

BINDING LIST NOV 15 1921



Nature

A WEEKLY

ILLUSTRATED JOURNAL OF SCIENCE



ence

Nature,
September 29, 1921.]

7/11

Nature

A WEEKLY

ILLUSTRATED JOURNAL OF SCIENCE

VOLUME CVII

MARCH, 1921, to AUGUST, 1921

168 275-
29/12/21

*"To the solid ground
Of Nature trusts the mind which builds for aye."*—WORDSWORTH

London

MACMILLAN AND CO., LIMITED

NEW YORK: THE MACMILLAN COMPANY

Q
1
N2
v. 107
cop. 2

PRINTED IN GREAT BRITAIN BY
THE CORNWALL PRESS, LTD.,
PARIS GARDEN, STAMFORD STREET,
LONDON, S. E. 1.

INDEX.

NAME INDEX.

- A. (H. E.), W. Warde Fowler: A Personal Appreciation, 551
- Abbot (Dr. C. G.), Experiments with Solar Cooking Apparatus on Mount Wilson, 540
- Abbott (G.), Cup and Ring Markings, 652; The Colours of Primroses, 395
- Abbott (W. J. L.), Coloration of Flints found at Cromer, 599; Gold-coloured Teeth of Sheep, 459; Why do Worms Die?, 490
- Abetti (A.), Applications of Vectorial Calculus to Astronomy, 671; Astronomical Determinations of Latitudes and Longitudes in Central Asia, 703
- Abraham (H.), and R. Planiol, The Use of the Bandot Telegraph in Wireless Telegraphy, 447
- Ackermann (A. S. E.), Bumble-bees and the Extraction of Nectar from White-runner Beans, 822; Experiments with Clay in its Relation to Piles, 534; The Physical Properties of Clay, III., 824
- Adam (Dr. N. K.), appointed to the Sorby Research Fellowship, 604; Geometrical Isomerism in Monomolecular Films, 522; The Properties and Molecular Structure of Thin Films of Palmitic Acid on Water, Part I., 286
- Adams (Dr. C. E.), and Prof. E. Marsden, Report on the Geophysical Observatory at Apia, 152
- Adams (Mary), (Dr. W. Garnett), A Little Book on Map Projection, new edition, 618
- Adams (Dr. W. S.), Spectrum Researches on the Motions in the Line of Sight, etc., 539; A. H. Joy, G. Strömberg, and C. G. Burwell, 1646 Spectroscopic Parallaxes, 281
- Adlam (G. H. J.), Chemistry, 647
- Adler (Daisy L.), Science and Technology in Palestine, 458
- Ahmichen (E.), A Series of Flights with a Free Helicopter, 62
- Agar (Prof. W. E.), Breeding Experiments with the Cladoceran *Daphnia*, 245
- Alayrac (M.), The Movement of a Solid in a Resistant Medium, 734
- Alexander (Prof. S.), P. M. Sieff, and D. B. Stanhill, Literature for Jerusalem University, 333
- Alkins (W. E.), Resignation of the Lectureship in Metallurgy in Manchester University, 507; M. Cook, and J. Harwood, Variation in *Sphaeria*, 30
- Allen (Dr. E. J.), Regeneration and Reproduction of the Syllid *Procerastea*, 61
- Allen (Dr. H. S.), appointed Reader in Physics in Edinburgh University, 411; Sources and Sinks, 622
- Allen (Prof.), Sex Chromosomes in the Liverwort *Sphaerocarpos*, 572
- Amundsen (Capt. R.), arrival of, at Vancouver, 821; request for a Grant from the Storting for his Arctic Expedition, 531
- Anderson (Dr. C.), appointed Director of the Australian Museum, Sydney, 434
- Anderson (Dr. H. K.), elected a Member of the Athenæum Club, 84
- Andrade (Dr. E. N. da C.), The Foundations of Physics, 643
- André (E.), The Oil from Grape Pips, 510
- Andrée (Prof. K.), Geologie des Meeresbodens. Band ii. Die Bodenbeschaffenheit und nützliche Materialien am Meeresboden, 292
- Andrew (R. C.), A Farmer's Handbook: A Manual for Students and Beginners, 679
- Andrews (E. C.), elected Permanent Honorary Secretary of the Australasian Association, 408
- Angell (Dr. J. R.), The Development of Research in the United States, 122; elected President of Yale University, 156
- Annandale (Dr. N.), The Fauna of Scottish Lochs, 778; The Vegetation of an Island in the Chilka Lake, 574; and Major R. B. S. Sewell, Oceanographic Research in the British Empire, 139
- Appellöf (A.), [obituary], 114
- Appleton (A. B.), The Development of Muscle, Bone, and Body-weight in Sheep, 509; The Alleged Inheritance of an Acquired Character in Man; The so-called Gluteus Maximus of Tarsius, 510; The Influence of Function on the Conformation of Bones, 190
- Armitage (Miss Eleonora), The Annular Eclipse, 212
- Armstrong (A. H.), The Economic Aspects of Railway Electrification in the United States, 404
- Armstrong (A. L.), Discovery of Engravings on Flints at Grime's Graves, 403
- Armstrong (Dr. E. F.), and T. P. Hilditch, A Study of Catalytic Actions at Solid Surfaces, vi., 573
- Armstrong (Prof. H. E.), Address to the Old Students' Association of the Royal College of Science, 28; The Designation of Vitamines, 72; The Particulate Nature of Enzymic and Zymic Change (Adrian Brown Memorial Lecture), 698
- Arton (A.), Apparatus for Directional Radio-mechanics, 479
- Ashton (T. S.), appointed Senior Lecturer in Economics in Manchester University, 380
- Ashworth (Prof. J. H.), The Edinburgh Meeting of the British Association, 590, 818
- Aston (Dr. F. W.), Atoms and Isotopes, 633; Isotopes and Atomic Weights, 334; The Constitution of Nickel, 520; The Constitution of the Alkali Metals, 72
- Aubel (E.), The Action of the Pyocyanic Bacillus on Asparagin, 735
- Aubel (E. van), The Atomic Heat of the Elements, 703
- Aucken (I.), A Physical Interpretation of the Energy Quantum, 553
- Auden (Dr. G. A.), Habits of the Hedgehog, 491
- Audubert (R.), The Elementary Quantity of Energy Concerned in Solution, 190; The Mechanism of the Energy Exchanges in Evaporation, 62
- Auger (V.), Double Catalysis of Vanadic Acid and Hydrogen Peroxide, 542; and Mlle. M. Vary, Sulphonations in the Presence of Iodine, 767
- Austen (L. W.), The Wave-front Angle in Radio-telegraphy, 280; Experiments to Determine the Directions from which Atmospheric Disturbances in Radio-telegraphy appear to come, 632
- Back (E. A.), Insect Control in Flour Mills, 309
- Bailey (E. B.), Structure of the South-west Highlands of Scotland, 222
- Baillaud (J.), Manuel de Topométrie. Opérations sur le Terrain et Calculs, 6
- Baille-Barrelle (M.), The Production of Coke from Sarre Coal, 663

- Bain (A. W.), Watson's A Text-book of Physics. Seventh edition, 358
- Bain (A. Watson), and others, The Modern Teacher: Essays on Educational Aims and Methods, 519
- Bainbridge (Prof. F. A.), and Prof. J. A. Menzies, Essentials of Physiology. Fourth edition, 166
- Baire (Prof. R.), Another Plan of Calendar Reform, 634
- Bairstow (Prof. L.), Administration of Scientific Work, 439
- Baker (C.), Catalogue of Second-hand Scientific Instruments, 372
- Baker (R. T.), awarded a Mueller Memorial Medal by the Australasian Association, 408; presented with the Mueller Medal, 691; Scientific Names for Commercial Timbers, 45
- Balfour (A. J.), elected President of the British Academy, 629; The Institute of Physics, 313; The Work of Lord Kelvin, 341
- Balfour (H.), Native Life in the Loyalty Islands and Southern Nigeria, 495
- Ballance (Sir Charles A.), appointed Thomas Vicary Lecturer at the Royal College of Surgeons of England, 507
- Balls (Dr. W. L.), A Simple Apparatus for approximate Harmonic Analyses and for Periodicity Measurements, 444; and H. A. Hancock, Cutting Sections of Cotton Hairs, 361
- Balsillie (Dr.), resignation of the Lectureship in Chemistry in Edinburgh University, 411
- Barbellion (W. N. P.), A Last Diary, 743
- Barbieri (N. A.), Anatomical Study on the Aretinal Termination of the Optic Nerve in the Animal Series, 543
- Barclay (Dr. A. E.), A Danger arising from the Coolidge Tube when Used for X-ray Screen Work, 53
- Barker (T. V.), "Practical Suggestions" on the Study of Crystals in Schools, 54
- Barlot (N.), The Displacement of Metals in Saline Solutions, 62
- Barlow (Dr. G.), The Theory of the Analysis of an Electric Current by Periodic Interruption, 574; and Dr. H. B. Keene, The Experimental Analysis of Sound in Air and Water, 574
- Barnard (J. E.), A Universal Geometric Slide Photomicrographic Apparatus, 470
- Barnard (Prof.), Discovery of Pons-Winnecke's Comet, 217; Search for Meteors from the Pons-Winnecke Radiant, 694
- Barnes (Dr. H.), bequests by, 637
- Barnett (Prof. S. J.), Molecular and Cosmical Magnetism, 8; Recent Progress in the Theory of Magnetism and its Simplest Applications, 662
- Bartell (F. E.), Anomalous Osmose, 94
- Barton (Mrs. W. J.), Women's Minimum Wages, 605
- Bartram (R. A.), gift to Sunderland Technical College, 669
- Bartrum (C. O.), Relativity and the Velocity of Light, 42. 141
- Basden (Rev. G. T.), Among the Ibos of Nigeria, 495
- Bateson (Dr. W.), Variiegation in a Fe₂N, 233
- Bather (Dr. F. A.), Biological Terminology, 301, 489, 778; Co-operative Indexing of Periodical Literature, 550; The Embryology of Crinoids, 132
- Batten (H. M.), Habits and Characters of British Wild Animals, 547
- Bayeux (R.), The Reducing Power of the Organic Liquids and Tissues of some Marine Animals, 287
- Bayliss (Prof. W. M.), elected a member of the Athenæum Club, 84; The Contractile Vacuole, 810; The Nature of Enzyme Action. Fourth edition, 232
- Beal (C. H.), The Cushing Oil and Gas Field, Oklahoma, 216
- Beard (Dr.), resignation of the Lectureship in Comparative Embryology in Edinburgh University, 411
- Beck (R. and J.), Ltd., Catalogue of Microscopes and Microscopical Apparatus, 309
- Becker (H. G.), A New Principle in Blow-pipe Construction, 446; A Simple Apparatus for Observing the Rate of Reaction between Gases and Liquids, 477
- Bedford (T. G.), re-appointed a Demonstrator in Experimental Physics, Cambridge University, 830
- Beilby (Sir George), The Internal Physics of Metals, 265; The World's Fuel Situation (James Forrest lecture), 597
- Bell (A. L.), The Bearing Power of Soils, 596
- Benedict (Dr. F. G.), Experiments on the Skin Temperature of Pachyderms, 540; and F. B. Talbot, Metabolism and Growth from Birth to Puberty, 647
- Bennett (J. J.), Direction-finding Wireless and Marine Navigation, 363
- Benson (Prof. W. N.), Recent Advances in our Knowledge of New Zealand Geology, 440
- Bentivoglio (Marie), Cassiterite Crystals from New England district, N.S.W., and Stanthorpe, Queensland, 832
- Bergson (Prof. H.), retirement of, from his Chair at the Collège de France 572
- Bernard (P.), and Barbe, An Apparatus for Lighting and Extinguishing Public Gas-lamps, 62
- Bernhauer (Dr. M.), The Staphylinid Beetles, 413
- Berry (E. W.), A New Species of Nelumbo from the Eocene of Meridian Mississippi, 246; Fossil Plants from the Late Cretaceous of Tennessee, 94
- Bertrand (G.), and A Compton, The Influence of Heat on the Activity of Salicinase, 127; and Mme. M. Rosenblatt, The General Presence of Manganese in the Vegetable Kingdom, 799; and P. Thomas, Translated from the third edition by H. A. Colwell, Practical Biological Chemistry, 390; and R. Vladesco, Causes in the Variation in the Amount of Zinc in Vertebrate Animals: the Influence of Age, 222; and R. Vladesco, The Probable Intervention of Zinc in the Phenomena of Fertilisation in the Animal Vertebrates, 735; and R. Vladesco, Variation in the Proportion of Zinc in the Organism of the Rabbit during growth, 703
- Berwick (W. E. H.), An Algebraical Identity, 652
- Bevis (J. F.), and H. J. Jeffrey, British Plants: Their Biology and Ecology. Second edition, 71
- Bey (C. A.), The Utilisation of the Stems of various Animal Plants, etc., 222
- Bidder (Dr. G. P.), Measuring with High Powers of the Microscope, 650
- Bieler (E. S.), The Currents induced in a Cable by the Passage of a Mass of Magnetic Material over it, 574
- Bierry (H.), and F. Rathery, Liver, Blood Plasma and Protéid Sugar, 575; F. Rathery, and Mlle. Levina, The Protéid Sugar in Cancerous Subjects, 703
- Bigot (A.), The Contraction on Drying of Kaolins and Clays, 222
- Bijl (P. A. van der), Some South African Stereums; A Fungus, *Gibbelula Haygarthii*, sp.n., on a Spider of the family Lycosidæ, 607
- Biles (Sir John H.), impending Retirement of, from the John Elder Chair of Naval Architecture and Marine Engineering in Glasgow University, 540
- Biology (The Professor of), The Purple Sapphire, and other Posthumous Papers, selected from the Unofficial Records of the University of Cosmopoli by Christopher Blayre, 677
- Blaise (E. E.), The Preparation of the Acyclic δ -Diketones, 799
- Blake (Rev. Canon J. E. H.), Coiling of Underground Shoots of *Convolvulus arvensis*, 747
- Blaringhem (L.), The Pollen of Flax and the Degenerescence of the Varieties Cultivated for the Fibre, 640
- Bledisloe (Lord), Speech at the Parliamentary Visit to the Rothamsted Experimental Station, 375; The British Science Guild, 314; The Work of the Rothamsted Experimental Station, 699
- Blichfeldt (S. H.), [obituary], 148
- Bloch (L. and E.), Critical Potentials and Band Spectra of Nitrogen, 767; Some Spark Spectra in the extreme Ultra-violet, 253; The Spark Spectra of Gold and Platinum in the Extreme Ultra-violet, 350; The Spark Spectra of Iron and Cobalt in the Extreme Ultra-violet, 287
- Blomfield (Dr. J. E.), [obituary], 721
- Blount (B.), [death], 242; [obituary article], 306
- Blythe (A. Wynter), [obituary], 213
- Bohr (Prof. N.), Atomic Structure, 104
- Bolton (H.), A New Species of Blattoid (Archimydracris) from the Keele Group (Stephanian) of Shropshire, 29
- Bonacina (L. C. W.), Relativity, Space, and Ultimate Reality, 171; "Space" or "Æther"?, 234; The Physical Continuity of "Space," 300; The Physical Status of "Space," 459

- Bond (Hon. Colonel C. J.), Pathogenic Organisms in the Pollen of Flowers and Disease in Bees, 584
- Bond (W. N.), The Effect of Viscosity on Orifice Flows, 350
- Bone (Prof. W. A.), illness of, 21; Researches upon Brown Coals and Lignites, part i., 125
- Bonhote (J. L.), Restoration to Egypt of the Cattle-egret, 245
- Boodin (Prof. J. E.), Cosmic Evolution, 126
- Booth (A. L.), The Economic Selection of Coal, 282
- Bora (E.), The Natural History of Anopheles and their Extermination, iii., 351
- Borradaile (L. A.), The Mouth-parts of Certain Decapod Crustaceans, 509
- Bougault (J.), and P. Robin, The Iodamidines, 94
- Boule (Prof. M.), Les Hommes Fossiles: Eléments de Paléontologie Humaine, 322
- Bourgeois (Gen.), awarded the Patron's Medal of the Royal Geographical Society, 178
- Bourion (F.), and Ch. Courtois, The Formation of Julin's Chloride in the Preparation of Electrolytic Chlorine, 542
- Bourquelot (E.), and M. Bridel, Application of the Biochemical Method of Research on Glucose to the Study of the Products of Fermentation Hydrolysis of Inulin, 350
- Boutaric (A.), Actinometric and Polarimetric Measurements at High Altitudes, 607; and M. Vuillaume, The Flocculation of Colloidal Arsenic Sulphide, 510
- Bouvier (E. L.), The Psychic Life of Insects, 501
- Bowditch (C. P.), [death], 659
- Bower (Prof. F. O.), appointed a Governor of the West of Scotland Agricultural College, 669
- Bowley (Prof. A. L.), Elements of Statistics, fourth edition, 102; Official Statistics, 549
- Boycott (Prof. A. E.), Hæmoglobin in Mollusca, 395
- Braak (Dr. C.), Climatic Conditions of the Principal Air Routes in the East Indian Archipelago, 792
- Bragg (Sir William), Ether Waves and Electrons, 374; Application of the Ionisation Spectrometer to the Determination of the Structure of Minute Crystals, 253; elected a Member of the Athenæum Club, 84; Electrons, 79, 109; The Intensity of X-ray reflection by Diamond, 477; The World of Sound: Six Lectures delivered before a Juvenile Auditory at the Royal Institution, Christmas, 1919, 200
- Bragg (Prof. W. L.), The Dimensions of Atoms and Molecules, 758; and H. Bell, The Dimensions of Atoms and Molecules, 107
- Brame (Prof. J. S. S.), elected President of the Institution of Petroleum Technologists, 149
- Brammall (A.), The Trend of Reconstitution Processes in Shales, Slates, and Phyllites, 605
- Branly (Prof. E.), awarded the Nobel Prize for Physics, 598
- Brazier (C. E.), The Comparability of Anemometers, 286
- Brenchley (Dr. W. E.), Indian Agriculture, 58
- Brend (Dr. W. A.), Psychotherapy and War Experience, 122
- Brentano (Dr. J. C. M.), appointed an Assistant Lecturer in Physics in Manchester University, 380
- Brett (Prof. G. S.), A History of Psychology. Vols. ii. and iii., 806
- Bridel (M.), The Application of the Law of Mass Action to the Results obtained in the Reaction of β -galactosidase on Galactose in Solution in Propyl Alcohol, 510; and R. Arnold, The Application to Plants of the Biochemical Method of Detecting Glucose, 575
- Brierley (Dr. W. B.), Personal Impressions of American Biological Research, 117; Plant Pests and their Control, 795
- Briffault (R.), Psyche's Lamp: A Re-valuation of Psychological Principles as Foundation of all Thought, 583
- Briggs (Prof. H.), An Experimental Analysis of the Losses due to Evaporation of Liquid Air contained in Vacuum Flasks, 190; The Adsorption of Gas by Charcoal, Silica, and other Substances, 285; The Adsorption of Gas under Pressure, 638
- Brighton (A. G.), awarded the Wiltshire Prize in Geology in Cambridge University, 572
- Britton (Dr. N. L.), and Dr. J. N. Rose, The Cactaceæ, vol. ii., 580; and Dr. C. F. Millspaugh, The Bahama Flora, 327
- Brodetsky (Dr. S.), Elementary Pure Mathematics, 616
- Broglie (L. de), and A. Dauvillier, The Electronic Structure of the Heavy Atoms, 670
- Broglie (M. and L. de), Bohr's Model Atom and Corpuscular Spectra, 222
- Brönsted (Prof. J. N.), and Prof. G. Hevesy, The Separation of the Isotopes of Chlorine, 619
- Brooks (A. H.), Mineral Springs of Alaska, 246; and M. F. La Croix, The Iron and Associated Industries of Lorraine, etc., 631
- Brooks (C. E. P.), Sun-spots and Weather, 599; The Evolution of Climate in North-west Europe, 286
- Brooks (Prof. W. R.) [obituary article], 340
- Brown (Prof. E. W.), Collision of Star and Nebula, 471
- Brown (Sir Hanbury), The Land of Goshen and the Exodus. Third edition, 679
- Brown (Prof. N. C.), Forest Products: Their Manufacture and Use, 326
- Brown (N. E.), A New Book on Cactaceæ, 580
- Brown (R. G.), The pre-Buddhist Religion of the Burmese, 791
- Brown (Dr. R. N. Rudmose), The Principles of Economic Geography, 774
- Brown (T. A.), appointed Senior Lecturer in Pure Mathematics at University College, London, 379
- Brown (Dr. W.), elected Wilde Reader in Mental Philosophy in Oxford University, 507; Psychology and Psychotherapy, 711
- Browne (A. D.), elected to a Fellowship at Queen's College, Cambridge, 60
- Browne (W. R.), Relation of Streams to Geological Structure, 832; The Igneous Rocks of Encounter Bay, South Australia, 795
- Browning (K. C.), appointed Professor of Chemistry and Metallurgy at the Artillery College, Woolwich, 540
- Bruce (A. B.), x-rays and their Physiological Effects, 146
- Bruce (Dr. W. Ironside) [obituary], 148
- Bruhat (Prof. G.), The Variation of the Specific Heats of Substances at Low Temperatures, 280; and Mlle. M. Hanot, The Lippich Black Fringe and the Precision of Polarimetric Measurements, 542
- Bruni (G.), A New Process for the Cold Vulcanisation of Rubber, 671; Solubility of Crystalline Substances in Caoutchouc, 254
- Bruylants (P.), The Action of the Organo-magnesium Compounds on Glutaric Nitrile, 703
- Bryant (W. W.), Kepler, 713
- Bryce (Prof.), A Human Embryo, 180
- Buchanan (Dr. G. S.), International Organisation and Public Health, 150
- Budden (Miss M. T.), elected to an Associates' Fellowship in Mathematics at Newnham College, 474
- Buisson (H.), and C. Fabry, The Displacement of the Solar Lines under the Action of the Gravitational Field, 382
- Bull (F. E.), and J. W. Meares, Hydro-electric Survey of India. Vol. ii.; Second Report on the Water-power Resources of India, ascertained during the Season 1919-20, 263
- Bull (L.), The Brightness of the Electric Spark, 253
- Buller (Prof. A. H. R.), The Ocellus Function of the Sub-sporangial Swelling of *Pilobolus*, 574
- Burkitt (M. C.), Prehistoric Art in Caves and Rock-shelters, 460
- Burnett (Major R.), A Remarkable Tribe in the Neighbourhood of Mosul, 756
- Burnett (W. C.), appointed Secretary of the Delegacy of Local Examinations, Oxford University, 604
- Burnham (Prof. S. W.), [obituary article], 212
- Burroughs (J.), [death], 148; [obituary article], 177
- Burton (Sir Richard F.), The Centenary of, 52; Proposed Institution of an Annual Memorial Lecture and a Medal, 630
- Bury (Col. H.), Progress of the Mount Everest Expedition, 661
- Butler (B. S.), G. F. Loughlin, V. C. Heikes, and others. The Ore Deposits of Utah, 484
- Butler (Sir Harcourt), The University of Lucknow, 251
- Butterworth (C. F.), Photographs of Nova Aquila, iii., 182

- Butterworth (S.), Eddy Current Lopes in Cylindrical Conductors, 573; The Errors Due to Capacity and Eddy-current Effects in Inductometers, 632
- Buxton (L. H. Dudley), elected to an Albert Kahn Traveling Fellowship, 443; Ancient and Modern Inhabitants of Malta, 699
- Buxton (P. A.), Animal Ecology in Deserts, 190
- Cabrier (A.), An Automatic Lighting and Extinguishing Apparatus for Street Gas Lamps, 542
- Callendar (Prof. H. L.), Properties of Steam and Thermodynamic Theory of Turbines, 482
- Calman (Dr. W. T.), appointed Deputy Keeper in the Department of Zoology of the British Museum, 402
- Calmette (Prof. A.), elected a Foreign Member of the Royal Society, 342; Tuberculosis "Carriers," 751
- Cambridge and Paul Instrument Co., Ltd., The Cambridge Microtomes and the Cambridge Recording Clinical Thermometers, 437
- Cameron (Sir Charles Alexander), [obituary], 51
- Campbell (Prof.), Bright Object near the Sun, 759
- Campbell (Dr. Norman R.), Atomic Structure, 170; Experimental Geometry, 301; Physics: The Elements, 643; "Space" or "Ether"?, 234; The Disappearance of Gas when an Electric Discharge is passed through more or less Exhausted Tubes, 793; and C. C. Patterson, Researches at the National Physical Laboratory, 87
- Campbell (Dr. R.), appointed Reader in Petrology in Edinburgh University, 411
- Campbell (Dr. W.), appointed Lecturer in Bacteriology and the Pathology of Industrial Diseases at the Bradford Technical College, 28
- Cannon (Miss), and others, Variable Stars, 759
- Cantlie (Sir James), Thomson's Machine for Armless Men, 469
- Capitan (Dr.), and M. Peyrony, Works of Art Discovered at La Ferrassie, 468
- Carlheim-Gyllensköld (V.), Tycho Brahe and his Observatory, 535
- Carline (G. R.), awarded a Scholarship by the Anglo-Swedish Society, 411
- Carmichael (Prof. R. D.), The Theory of Relativity. Second edition, 264
- Carmody (Prof. P.), Trinidad as a Key to the Origin of Petroleum, 471
- Carnegie (Andrew), Autobiography of, 2
- Carpenter (R. C.), The Structure and Uses of Balsa Wood, 279
- Carpentier (J.), [obituary], 790
- Carr (Prof. H. Wildon), A Psychology of Logic, 612; The Epistemological Problem, 228; What Relativity in Science Implies, 578
- Carracido (Don J. R.), elected President of the Spanish Association, 244
- Carlslaw (Dr. H. S.), The Cooling of a Solid Sphere with a Concentric Core of a Different Material, 446
- Carson (J. R.), and J. J. Gilbert, Transmission Characteristics of the Submarine Cable, 540
- Carter (G. S.), awarded a Frank Smart Prize at Cambridge University, 540
- Carter (H. G.), appointed Curator of the Herbarium, Cambridge University, 284
- Cartwright (W.), appointed Assistant Lecturer in Metallurgy in Manchester University, 507
- Carty (J. J.), Science and the Industries, 121
- Carus-Wilson (C.), An Unknown Organism in Flint, 299; An Unusual Stalagmite, 21; Cup and Ring Markings, 523, 715; Organism in Flint, 362; The Sound of Distant Gun-fire, 108
- Carver (Dr. A.), Principles and Practice of Psychotherapy, 711
- Cassel (Sir Ernest), Gift for a Hospital or Sanatorium for the Treatment of Functional Nervous Disorders, 307
- Casson (S.), Evidence of the Character and Distribution of Iron-age Culture in the Balkan Peninsula, 500
- Castelvecchio (Signorina L. P. di), appointed Professor of Italian in Birmingham University, 474
- Castle, Origin and Relationships of the Various Types of Sex-determining Chromosomes, 571
- Caswell (J. S.), appointed Demonstrator in Engineering at the University College of Swansea, 637
- Cave (C. J. P.), Cloud Forms, 365; International Exploration of the Upper Air, 761; The Sound of Distant Gun-fire, 140
- Caven (Prof. R. M.), The Foundations of Chemical Theory, 613
- Cavenagh (F. A.), appointed Professor of Education at the University College of Swansea, 637
- Chaffard, P. Brodin, and Grigaut, The Arrest of Uric Acid in the Liver, 94
- Chailley-Bert (P.), R. Faillie, and J. P. Langlois, The "Second Wind" of Runners, 640
- Challener (W. A. P.), elected to a Beit Fellowship for Scientific Research, 700
- Chalmers (T. W.), The Gyroscopic Compass: A Non-Mathematical Treatment, 328
- Champy (Ch.), Inter-sexes in Newts, 692; The Experimental Change of Sex in *Triton alpestris*, 447
- Chance (E.), The Deposition of Eggs by a Cuckoo, 215
- Chandra (R. G.), Search for Meteors from the Pons-Winnecke Radiant, 694
- Chapas (M.), The Solubility of the Isomeric Nitroanilines in Metaxylene, 127
- Chapman (A. Chaston), elected President of the Institute of Chemistry, 23
- Chapman (F.), The Age of the Ironstone Beds of the Mornington Peninsula, 607
- Chapman (Prof. S.), Molecular and Cosmical Magnetism, 8
- Charcot (Dr.), An Expedition of the *Pourquoi-Pas* to Rockall, 799; Landing upon the Islet of Rockall, 755; The Island of Jan Mayen, 190
- Chatley (Dr. H.), Cohesion, 786
- Chatton (E.), and R. Courrier, A Trypanosome of the Bat, *Vesperugo pipistrellus*, 478
- Chénevaux (C.), The Variation of the Specific Refraction of Dissolved Salts in Dilute Solution, 575
- Cheplin (H. A.), and L. F. Rettger, Feeding Experiments with Albino Rats, 223
- Chetverikov (S. S.), The Fundamental Factor of Insect Evolution, 501
- Chevenard (P.), The Action of Additions on the Expansion Anomaly of the Ferro-nickels 150; The Expansion Anomaly Accompanying the Magnetic Transformation of Pyrrhotine and Magnetite, 30
- Chilton (Prof. C.), *Asellus aquaticus*, 180; awarded a Mueller Memorial Medal by the Australasian Association, 408
- Chipp (T. F.), The Fungi of the Malay Peninsula, 469
- Chisholm (G. G.), The Realm of Man, 774
- Chittenden (F. J.), The Garden Doctor: Plants in Health and Disease, 40
- Chofardet (P.), Observations of the Reid Comet made at the Besançon Observatory, 286
- Cholodkovsky (Prof. N. A.), [obituary], 820
- Chree (Dr. C.), A Comparison of Magnetic Declination Changes at British Observatories, 29; Recent Work on Aurora, 565; The Height and Spacing of Wires in Electroculture, 632; The Magnetic Storm of May 13-17, 359; The Recent Magnetic and Electrical Disturbances, 399
- Christy (M.), The Ancient Legend as to the Hedgehog carrying Fruits upon its Spines, 375
- Chrystal (the late W. J.), Bequests by, 540, 604
- Chuckerbutti (Prof.), The Motions of the Trevelyan Rocker, 824
- Ciamician (Prof.), elected an Honorary Foreign Member of the Chemists' Club, New York, 114
- Ciamician (G.), and C. Ravenna, Influence of Organic Substances on Plant Development, 254
- Clack (B. W.), The Coefficient of Diffusion of Certain Saturated Solutions, 445
- Clark (D.), elected Professor of Civil Engineering at Trinity College, Dublin, 603
- Clark (Dr. H. Lyman), The Echinoderm Fauna of Torres Strait, 712
- Clark (J. E.), Dates of Flowering of some Trees in South-west and South-east England, 245; and H. B. Adames, Report on the Phenology of the British Isles, December, 1910, to November, 1920, 413
- Clark (W. E. Le Gros), Ancient Skulls from Greenland, 532

- Clark (Dr. W. M.), The Determination of Hydrogen Ions, 772
- Clarke (F. W.), and W. C. Wheeler, The Inorganic Constituents of Marine Invertebrates, 795
- Clarke (G. A.), An Unusual Pilot-balloon Trajectory, 30; Clouds, 365
- Clarke (Dr. W. Eagle), retirement from the Keepership of The Natural History Department of the Royal Scottish Museum, 243
- Clarke (Miss Winifred S.), appointed Lecturer in Education in Manchester University, 507
- Claude (G.), Process for the Synthesis of Ammonia, 765; The Manufacture of Hydrogen for the Synthesis of Ammonia, 351; The Synthesis of Ammonia under very High Pressure, 93
- Claxton, Report of the Royal Observatory, Hong-Kong, 1920, 824
- Clayton (A. E.), Harmonic Analysis, 759
- Clayton (H. H.), Solar Radiation in Relation to Faculæ, 108; The "Flight" of Flying-fish, 714
- Clerc (L.-P.), Applications de la Photographie Aérienne, 167
- Clerici (E.), New Mineral Deposit near Rome, 127
- Clifton (Prof. R. B.) [obituary article], 18
- Coates (H.), Fall of Meteorites in Perthshire, 632
- Cobbett (Dr. L.), re-appointed University Lecturer in Pathology in Cambridge University, 507
- Coblentz (Dr.), The Present Position of our Knowledge of the Laws of Radiation of a Perfectly Black Body, 344
- Coblentz (W. W.), The Spectrophotoelectrical Sensitivity of Proustite, 694
- Cockerell (Prof. T. D. A.), Natural History of Porto Santo, 10; Waste Oil from Ships, 333
- Cohen (Prof. E.), and Dr. W. Schut, Piezochemie kondensierter Systeme, 450
- Cohen (Prof. J. B.), Pure Organic Chemicals, 12
- Coker (Prof. E. G.), K. C. Chakko and M. S. Ahmed, Contact Pressures and Stresses, 280
- Cole (Prof. G. A. J.), Organism in Flint, 333; The Problem of the Bray Series, 510
- Coleman (L. C.), The Cultivation of the Millet "Ragi" in Mysore, 58
- Collard (A.), "L'Astronomie et les Astronomes," 503
- Collie (Prof. J. Norman), elected a Member of the Athenæum Club, 213
- Collinge (Dr. W. E.), appointed Keeper of the York Museum, 60; The Scarcity of Swallows, 628
- Collis (Prof. E. L.), and Dr. M. Greenwood, The Health of the Industrial Worker. Containing a Chapter on Reclamation of the Disabled, by Dr. A. J. Collis, 354
- Colwell (H.), History of Electrotherapy, 150
- Comessatti (A.), Geometric Theory of Binary Forms, ii., 127; iii., 128
- Comissopulos (N. A.), and J. Wadsworth, Variability of Temperature over Europe and North America (1900-9), 605
- Comrie (L. J.), elected to an Isaac Newton Studentship in Astronomy in Cambridge University, 123
- Contremoulins (G.), The Protection against X-rays of Persons other than the Operator and Patient, 382, 414
- Conway (Prof. R. S.), New Studies of a Great Inheritance: Being Lectures on the Modern Work of some Ancient Writers, 744
- Cook (Dr. G.), appointed Professor of Mechanical Engineering at King's College, London, 572
- Cook (Dr. M. T.), College Botany: Structure, Physiology, and Economics of Plants, 807
- Cooke (A.), Groundwork of Surgery (for First-year Students), 807
- Cooper (P. A.), The X-ray Structure of Potassium Cyanide, 745
- Copaux (Prof. H.), translated by Dr. H. Leffmann, Introduction to General Chemistry, 743
- Copeland (Prof. E. B.), The Coco-nut. Second edition, 391
- Coronas (Rev. J.), The Climate and Weather of the Philippines, 1903 to 1918, 732
- Cortie (Rev. A. L.), Report of the Stonyhurst College Observatory, 503; The Great Sun-spot Group and Magnetic Disturbances, May 8-21, 426
- Cory (C. B.) [obituary], 820
- Cossor (A. C.), and Son, The Origin of "Churning at 62°" on Dairy Thermometers, 362
- Coste (J. H.), Earthworms drowned in Puddles, 360; Why do Worms Die?, 491
- Cotton (Dr. L. A.), The Kurrajong Earthquake of August 15, 1919, 832
- Coulter (Prof. J. M.), elected a Foreign Member of the Linnean Society, 369
- Coupon (H.), A Stem with Horizontal Geotropism, 159
- Courmont (P.), A. Rochain, and F. Laupin, The Disappearance of Pathogenic Germs in the Course of the Purification of Sewage by Activated Sludge, 735
- Couvreur (E.), and X. Chahovitch, A Natural Mode of Defence against Microbe Infections in the Invertebrates, 191
- Coville (F. V.), The Influence of Cold in Stimulating the Growth of Plants, 223
- Coward (T. A.), elected President of the Manchester Literary and Philosophical Society, 342; The Birds of the British Isles and their Eggs. Second series, 40
- Cowley (W. L.), and Dr. H. Levy, Aeronautics in Theory and Experiment. Second edition, 389
- Craig (Dr. J.), Knighthood conferred upon, 277
- Crawford (Prof.), and Miss Levy, Pons-Winnecke's Comet, 405
- Crawford (O. G. S.), Iron Currency-bars, 587
- Crewe (H. T.), The Practical Electrician's Pocket Book for 1921, 232
- Crewe (Lord), The Universities and Technological Education, 656
- Cridland (Miss Dorothy), awarded a Scholarship by the Anglo-Swedish Society, 411
- Crocco (Col. G. A.), Utilisable Energy of the Wind, 478
- Crocker (Prof. F. B.) [obituary], 721
- Crommelin (Dr. A. C. D.), Meteors on the Moon, 235; The Annular Eclipse, 211
- Crook (T.), Economic Mineralogy: A Practical Guide to The Study of Useful Minerals, 646
- Crookshank (Dr. F. G.), The Ethnological Significance of Mongolian Imbecility, 218
- Crossland (C.), The Proposed University of Jerusalem, 733
- Crowther (Dr. J. A.), appointed University Lecturer in Physics as applied to Medical Radiology in Cambridge University, 572; re-appointed a Demonstrator in Experimental Physics, Cambridge University, 830
- Crowther (W. L.), and C. E. Lord, The Osteological Specimens in the Tasmanian Museum, 116
- Crutwell (G. E. W.), A Model for Investigating the Movements in the River Thames between Teddington and Shoeburyness, 596
- Cullen (Rev. J.), An Algebraical Identity, 587
- Culpin (Dr. M.), Spiritualism and the New Psychology: An Explanation of Spiritualist Phenomena and Beliefs in Terms of Modern Knowledge, 164
- Cumpston (Dr. J. H. L.), Accuracy in Medicine, 441
- Cunningham (Dr. Brysson), Bull and Meare's Second Report on the Water-power Resources of India, 263; Hydrology of the Western States of North America, 406; Inland Waterways, 48
- Cunningham (E.), Relativity: The Electron Theory and Gravitation. Second edition, 742
- Curie (Mlle. Irène), The Atomic Weight of Chlorine in some Minerals, 382
- Curie (Mme.), presentation to, of a Gram of Radium, 402; The γ -Radiation and the Evolution of Heat from Radium and Mesothorium, 382
- Currie (Sir Arthur), The Universities and Technological Education, 656
- Curtis (Sir G.), The Development of Bombay, 757
- Cushing (Dr. H. P.) [obituary], 741
- Cushman (R. A.), The Ichneumon-flies of the Tribe Ephialtini, 532
- Cusmano (G.), Intermolecular Condensations produced by Oxynitric Groups, 127
- Czaplicka (Miss), [obituary], 466
- Dale (Sir Alfred W. W.), [obituary], 790
- Dale (G. H. C.), Map Reading, 775
- Dalton (O. M.), appointed Keeper of the Department of

- British and Mediæval Antiquities of the British Museum, 722
- Damiens (A.), The System Bromine-Tellurium, 799; The System Iodine-Tellurium, 94; Tellurium Tetraiodide, 414
- Dangeard (P. A.), The Structure of the Plant-cell in its Relations with the Theory of the Chondriome, 735
- Daniels (G. W.), appointed Professor of Commerce and Administration in Manchester University, 380
- Danjon (A.), and G. Rougier, Re-appearance of Saturn's Ring, 119
- Darmois (E.), The Molybdomalates of Ammonium and Sodium, 607
- Darton (N. H.), The Rate of Increase of Underground Temperature with Increasing Depth in the United States, 344
- Darwin (Dr. C. G.), appointed a Professor at the Norman Bridge Laboratory of Physics at the California Institute of Technology, 820
- Darwin (Sir Francis), The Annular Eclipse, 212
- Datta (S.), The Spectra of the Alkaline Earth Fluorides and their Relation to each other, 444; The Vacuum Arc Spectra of Sodium and Potassium, 158
- Davidson (Dr. J.), The Cells of Plant Tissues in Relation to Cell-sap as the Food of Aphids, 93
- Davidson (J. H.), British Laboratory and Scientific Glassware, 331
- Davies (Sir Alfred T.), The Collection of Rural Lore in Wales by School-children, 124
- Davies (Nina de Garis), and Dr. A. H. Gardiner, The Tomb of Amenemhet, 70; The Tomb of Antefoker, Vizier of Sesostris I, and of his Wife, Senet, 70
- Davis (H. J.), appointed Lecturer in Mathematics in the Bradford Technical College, 411
- Davis (W. A.), Modern Methods of Manuring in India, 58
- Davison (Dr. C.), The Chinese Earthquake of December 16, 1920, 473; The Elements of Analytical Conics, 616; The Elements of Plane Geometry, 134; The Sound of Distant Gun-fire, 108
- Dawson (Sir Philip), Electric Traction in Connection with Heavy Railway Work, 181
- Dawson (Dr. W. Bell), Ocean Tides, 651
- Dawson (W. H.), The Yearbook of the Universities of the Empire, 1921, 519
- Debenham (F.), re-elected University Lecturer in Surveying and Cartography in Cambridge University, 474; The Future of Polar Exploration, 179
- Decarrière (E.), The Rôle of the Gaseous Impurities in the Catalytic Oxidation of Ammonia, 670, 735
- Déjardin (G.), The Ionisation of Argon by Slow Electrons, 542
- Delacré (Prof. M.), Dalton and Atomic Symbols, 440
- Delaunay (P.), The Extraction of the Glucosides in some Indigenous Orchids, 94
- Delépine (M.), The Active Racemic Compounds, 382; Fleury, and Ville, Researches on $\beta\beta$ -Dichloroethyl Sulphide, 478
- De Marchi (L.), Vertical Temperature Gradient in the Atmosphere, 671
- Dendy (Prof. A.), An Addition to the British Fauna (*Rhynchodemus Scharffi*), 298; Hexactinellid Sponges, 413; The Problem of Human Evolution, 691
- Denham (H. J.), Method of Cutting Sections of Cotton Hairs, 299
- Dennett (R. E.), [death], 434; [obituary article], 529
- Denning (W. F.), Prof. W. R. Brooks, 340; Large Detonating Fireball, 153; Large Meteors on March 1 and 2, 55; Meteors from Pons-Winnecke's Comet, 601; Nova Cygni III (1920), 471; Pons-Winnecke's Comet and its Meteor Shower, 15; Observations of Pons-Winnecke's Comet, 373, 438; Recent Brilliant Fireballs, 182; Recent Meteors, 634; Reid's Comet, 247; The August Meteors, 694; The August Meteoric Display, 793; The Fireball of March 2, 88; The Meteoric Radiants of June 25-30, 535; The Recent Meteoric Display, 825
- Denny (M. E.), Fabricated Ships, 596
- Densmore (Prof. H. D.), General Botany for Universities and Colleges; Laboratory and Field Exercises for "General Botany," 69
- Dervieux (M.), Method of Individual Diagnosis of the Blood and of Sperm, 543
- Dervin and Olmer, Ammoniacal Silver Carbonate, 670
- Desch (Prof. C.), Necessity for Humanistic Instruction and Study in the Training of Men of Science, 655
- Desgrez, Guillemard, and Hemmerdinger, The Fixation of Carbon Monoxide diluted and carried by an Air-current, 735; Guillemard, and Labat, The Use of the Alkaline Polysulphides for the Neutralisation of certain Toxic Gases, 31; and R. Moog, The Influence of some Organic Bases and of their Chlorohydrates on the activity of Pancreatic Amylase, 127
- Deslandres (Dr H. A.), awarded the Bruce Gold Medal of the Astronomical Society of the Pacific, 115; elected a Foreign Member of the Royal Society, 342; and V. Burson, Researches on the Atmosphere of Stars, 93, 222
- De Stefani, Ligurian Fossil Sponges, iii., 128; vi., 671
- Destouches (L.), The Prolongation of Life in *Galleria mellonella*, 351
- De Toni (Prof. G. B.), The Teratology of the genus *Datura*, L., 92
- Detrie (J.), The Transformation of Phenol into cyclo-Hexanol, 478
- Dewar (Sir James and Lady), presented with a Loving-cup by the Royal Institution, 530
- Dible (J. H.), appointed Lecturer in Bacteriology in Manchester University, 669
- Dickson (A.), Survivals of the Regalia of the Wa-Vumba tribe in the delta of the Umba River, 215
- Dickson (Dr. E. C. S.), appointed Senior Lecturer in Physics in Manchester University, 669
- Diéner (F.), Concerning Activated Sludge, 735
- Dixey (F.), The Norite of Sierra Leone, 638
- Dobbin (Dr. L.), appointed Reader in Chemistry in Edinburgh University, 411
- Dobson (G. M. B.), The Causes of Errors in Forecasting Pressure Gradients and Upper Winds, 605
- Doidge (Miss Ethel), Revision of the Native Species of Microthyriaceæ, 469
- Donald (C. H.), Companions: Feathered, Furred, and Scaled, 805
- Donald (R.), Suggestion for a Corporation for an Inter-Empire Scheme for Radio Communication, 660
- Dongier (R.), The Simultaneous Oscillations of Temperature and Wind at the top of the Eiffel Tower and their relation with the Bjerknæs Steering Surface of a Depression, 191; The Simultaneous Oscillations of the Pressure and Wind at the top of the Eiffel Tower, etc., 510
- Dort (M.), The Variations of the Solar Radiation during the Eclipse of the Sun of April 8, 1921, 414
- Douglas (J. A.), Geological Sections through the Andes of Peru and Bolivia. iii., From Callao to the River Perene, 350; The Structure of the Andes, 436
- Dover (C.), The Occurrence of *Bombus* in the Indian Plains, 362
- Dow (J. S.), The Use of Artificial Light as an Aid to various Games and Sports, 470
- Dowling (J. J.), Observations of Plant-growth with the Recording Ultramicrometer, 523
- Dowson (E. M.), The Programme and Policy of the Egyptian Government in regard to the Development of the Oil Resources of the Country, 502
- Dragoïu (J.), and F. Vlès, The Cytological Consequences of the Osmotic Arrest of Cell Division, 447
- Dreyer (Dr. J.), Instinct in Man: A Contribution to the Psychology of Education. Second edition, 455
- Dreyer (Dr. J. L. E.), Primitive Chronology, 274; The Cosmology of Dante, 428
- Druce (Dr. G. C.), Botanical Work in the Shetlands, 92; The Extinct and Dubious Plants of Britain, 343
- Drury (Dr.), Protection against Smallpox by Vaccination, 757
- Drury (O. G. C.), The Ingersoll Cement-gun, 596
- Dry (F. W.), awarded the James Edmondson Ackroyd Memorial Fellowship at Leeds University, 732
- Drysdale (Dr. C. V.), Science and Civilisation, 715
- Drzewina (Mme. Anna), and G. Bohn, The Defence of Animals grouped together against Poisons, 222
- Dubiago (M.), Discovery of a new Comet, 1921c, 373
- Dubois (E.), The Minimum Potential of Electric Discharge in Hydrogen at Low Pressures, 799

- Dubrisay (R.), The Action of Boric Acid on Glycerol and the Polyvalent Alcohols, 670
- Duffrenoy (J.), Influence of the Temperature of the Thermal Waters of Luchon on their Flora, 159
- Dufton (A. F.), Sources and Links, 522
- Dugan (R. S.), *U cephei*, 373
- Duncan (R. D.), "Wired Radio," 87
- Dunkerly (J. S.), Physiological Reactions in the Protozoa, 395; The Reparation Act and Scientific Research, 427
- Dunkley (W. G.), A Primer of Trigonometry for Engineers: with numerous Worked Practical Examples, 134
- Dunlop (G. A.), appointed Keeper of the Warrington Museum, 85
- Dunoyer (L.), A New Spectrum of Cæsium, 831
- Dupont (G.), The Acid Constituents of the Exudation of the Maritime Pine, 447, 542; The Study of the Acid Constituents of the Resinous Exudation from the Pine, 319
- Dupuy (E. L.), The Influence of Welding on the Resistivity of Iron, 670
- Durand (J. F.), The Decomposition of Metallic Alcoholates and Phenates by Heat, 607
- Durell (C. V.), Modern Geometry: The Straight Line and Circle, 616
- Durrant (R. G.), Sound Transmitted through Earth, 140
- Durward (J.), Diurnal Variation in Wind Velocity and Direction at various heights, 693
- Duthie (Miss Georgina May), appointed a Demonstrator in Anatomy in Manchester University, 507
- Du Toit (A. L.), Geology of Pondoland, 827
- Dyson (Sir F. W.), Solar Eclipse Results and the Principle of Relativity, 682; Stellar Parallax, 527
- Ealand (C. A.), Insect Life, 806
- Easterfield (Prof. T. H.), Work of the Staff of the Cawthron Institute, 668
- Eastwood (G. S.), and J. R. Fielden, An Algebra for Engineering Students, 616
- Ebell (M.), Reid's Comet, 247; The Orbit of Comet Pons-Winnecke, 345
- Eckersley (T. L.), Errors in the Apparent Bearings of Radio Stations, 502
- Eddington (Prof. A. S.), A Difficulty in Einstein's Gravitational Theory, 170; A Generalisation of Weyl's Theory of the Electromagnetic and Gravitational Fields, 125; elected President of the Royal Astronomical Society, 51; "Space" or "Æther," 201
- Eden (Dr. G.), appointed Assistant Lecturer on Clinical Medicine and Junior Medical Tutor in Birmingham University, 90
- Edie (F. S.), appointed Professor of Biochemistry in the University of Cape Town, 572
- Edrige-Green (Dr. F. W.), New Facts of Colour Vision, 826; The Effect of Red Fatigue on the White Equation, 509; The Theory of Vision, 361; V. Z. Cope, and Prof. T. Swale Vincent, appointed Arris and Gale Lecturers at the Royal College of Surgeons of England, 507
- Edwards (Prof. C. A.), The Physico-Chemical Properties of Steel. Second edition, 772
- Einstein (Prof. A.), elected a Foreign Member of the Royal Society, 342; The Development and Present Position of the Theory of Relativity, 504; The Relation between Geometry and Physics, 504; The Degree of D.Sc. conferred upon, by Manchester University, 504
- Elderton (W. Palin), American and British Superannuation Systems, 651, 683
- Elles (Dr. Gertrude L.), The Bala Country: Its Structure and Rock-succession, 158
- Elliott (C.), "Halo-blight" of Oats, 155
- Ellis (C. D.), The Magnetic Spectra of the β -rays excited by the γ -rays, 444
- Ellis (Dr. D.), Advances in the Study of the Yeasts, 387
- Ellis (Havelock), Impressions and Comments. Second series, 1914-20, 743
- Elmhirst (R.), and Dr. J. H. Paul, Distribution of Copper in the Blood and "Liver" of the Decapod Crustacea, 151
- Emerson (B. K.), The Geology of Massachusetts and Rhode Island, 631
- Emmons (W. H.), The Enrichment of Ore Deposits, 581
- Engledow (F. L.), The Problem of Increasing the Yield of Cereal Crops by Plant Breeding, 509
- Errera (Leo), *Recueil de l'Institut Botanique*, tome iv., 6
- Erskine-Murray (Dr. J.), A New Acoustical Phenomenon, 490
- Euler (Prof. H.), and Prof. P. Lindner, *Chemie der Hete und der alkoholischen Gärung*, 485
- Evans (Dr. I. B. Pole), The Flowering Plants of South Africa. Vol i., No. 1, 40
- Evans (Dr. J. W.), American and British Superannuation Systems, 683; Co-operative Indexing of Periodical Literature, 550; Falconer's The Geology of the Plateau Tin Fields, 679; Mineralogy for Students, 646; The Employment of Water-power in the Development of the Mineral Industry, 596
- Eve (Prof. A. S.), Ionisation Potential and the Size of the Atom, 552
- Everest (Dr. A. E.), and A. J. Hall, Anthocyanins and Anthocyanidins, part iv., 61
- Evermann (Prof. B. W.), The Alaskan Salmon Fisheries, 219
- Ewart (Prof. A. J.), elected President of the Royal Society of Victoria, 435; Work done in Botany and Geology during the War Period, 441
- Ewing (Sir J. A.), Steam and Thermodynamic Theory, 482; The Atomic Process in Ferro-magnetic Induction, 444; The Mechanical Production of Cold. Second edition, 103
- Fabre (J. H.), Insect Adventures, 101
- Fabry (Prof. C.), presented with the Franklin Medal and Honorary Membership of the Franklin Institute, 369
- Faes (H.), and M. Staehelin, The resistance of the Adult Cockchafer to Low and High Temperatures, 703
- Fage (L.), Shore Fishes, 796; Some Spiders without Pulmonary Sacs, 159
- Fairbairn (Miss Ruth), appointed Lecturer in Histology in Manchester University, 380
- Fairgrieve (M. M'C.), The Annual Incidence of Intelligence and its Measurement by the American Army Tests, 606
- Fajans (Prof. K.), Radioaktivität und die neueste Entwicklung der Lehre von den chemischen Elementen. Dritte auflage, 583
- Falconer (Dr. J. D.), The Geology of the Plateau Tin Fields, 679
- Fanfani (Rev. E.), A Simplified Calendar Reform, 88
- Farabee (Dr. W. C.), Ancient American Gold Objects in the Museum of the University of Pennsylvania, 85
- Farmer (Dr. R. C.), Rt. Hon. Lord Moulton of Bank, 82
- Farrand (Dr. L.), acceptance of the Presidency of Cornell University, 732
- Fenton (Dr. E. G.), Physiography and Glacial Geology of Southern Patagonia, 828
- Feret (R.), The Law of Equilibrium of Solid Grains in a Vertical Ascending Current of Water, 158
- Ferguson (Dr. A.), Studies in Capillarity. Part i., 477; and P. E. Dowson, part ii., 477
- Ferguson (E. W.), Revision of the Amycterides (Coleoptera). Part vi., Acantholophus, 479
- Fernald (Prof. C. H.) [obituary], 114
- Ferrié (Gen.), awarded the Osiris Prize, 629
- Féry (C.), A Battery Depolarised by Air, 30
- Field (Dr. H. H.) [obituary], 242
- Field (S.), The Electrolytic Recovery of Zinc, 252
- Finch (Prof. J. K.), Topographic Maps and Sketch Mapping, 294
- Findlay (Prof. A.), and V. H. Williams, The Electrolytic Reduction of Glucose, 252
- Fisher (Dr. H. L.), Laboratory Manual of Organic Chemistry, 519
- Fisher (S.) [obituary], 213
- Flajolet (M.), The Strong Magnetic Perturbation of May 14-15, 1921, 542
- Fleck (Dr. A.), The Exploitation of Irish Peat, 770
- Fleming (Prof. J. A.), awarded the Albert Medal of the Royal Society of Arts, 499; presented with the Albert Medal of the Royal Society of Arts, 562; Wireless Telephony, 369

- Fletcher (J. J.), Presidential Address to the Linnean Society of N.S.W., 479
- Fletcher (T. B.), Life-histories of Indian Microlepidoptera, 631
- Fletcher (Sir W. Morley), elected a Member of the Athenæum Club, 213
- Fleure (Prof. H. J.), The Treaty Settlement of Europe, 660
- Flexner (Dr. S.), Experimental Epidemics in Colonies of Mice, 540
- Florentin (D.), and H. Vandenberghe, Methods of Estimating small quantities of Carbon Monoxide in Air- and Flue-gases, 63
- Foch (A.), The Phenomena of Resonance in Aspiration Turbines, 607
- Foley (A. L.), A Photographic Method of Finding the Instantaneous Velocity of Sound-waves at Points near the Source, 94
- Fornander (A.), Fornander Collection of Hawaiian Antiquities and Folklore. With translations. Edited and illustrated with Notes by T. G. Thrum. Third series. Part iii., 391
- Fosse (R.), and G. Laude, Syntheses of Cyanic Acid and Urea by the Oxidation in Alcoholic Ammoniacal Solution of Phenols and Aldehydes, 191; and Mlle. N. Rouchelman, The Formation of Urea in the Liver after Death, 222
- Fournier d'Albe (Dr. E. E.), Amplifying the Optophone, 43
- Fourtau (R.), The Neogene Echinoderms of Egypt, 86
- Fowler (R. H.), and C. N. H. Lock, The Origin of the Disturbances in the Initial Motion of a Shell, 126
- Fowler (W. Warde), Prof. L. C. Miall, 18; [obituary article], 528
- Fox (P.), Measurements of Stellar Parallax at the Dearborn Observatory, 382
- Frachtenberg (L. I.), Myths of the Alsea Indian Tribe of Oregon, 215
- Franklin (T. B.), Relation of the Soil Colloids to the Conductivity of the Soil, 62
- Frederick (R. C.), and Dr. A. Forster, Public Health Chemical Analysis, 708
- Freeman (R. A.), Social Decay and Regeneration, 452
- Frémont (C.), The Fragility of some Welded Steel Joints, 62
- French (J. W.), Amplifying the Optophone, 43
- Frésenius (Th. W.), Introduction to Qualitative Chemical Analysis. Seventh edition. Translated by C. A. Mitchell, 708
- Freund (Ida), edited by A. Hutchinson and M. Beatrice Thomas, The Experimental Basis of Chemistry: Suggestions for a Series of Experiments Illustrative of the Fundamental Principles of Chemistry, 356
- Fric (M.), The Stability of Nitrocellulose Powders, 734
- Friend (Rev. H.), Why do Worms Die?, 172
- Friend (Dr. J. Newton), Iron in Antiquity, 372
- Fritch (Prof. F. E.), and Dr. E. J. Salisbury, An Introduction to the Structure and Reproduction of Plants, 200
- Froc (Father), awarded the Cross of the Legion of Honour, 308
- Fuller (C.), Growth of the Antenna in Termites, 24
- Fulton (Dr. T. W.), retirement of, from the Scientific Superintendency of the Fishery Board for Scotland, 370
- Galippe (V.), and Mme. G. Souffland, Meteorites and Igneous Rocks endowed with Movement, 661
- Gallenkamp and Co., Ltd., Catalogue of Electric Furnaces, 182; List of Students' Balances and Weights, 310
- Galloway (Prof. W.), The Fying-fish, 376
- Gardiner (Prof. J. Stanley), The Reparation Act and the Cost of German Publications, 359; West Indian Zoology, 829
- Garman (Dr. S.), elected a Foreign Member of the Linnean Society, 369
- Garner (W. E.), and C. L. Abernethy, Heats of Combustion and Formation of Nitro-compounds. Part i., 158
- Garnett (J. C. M.), Education and World Citizenship: An Essay towards a Science of Education, 386; The Universities and Technological Education, 656
- Garrard (Major A.), Motor-car Headlights: Ideal Requirements and Practical Solutions, 118
- Garrett (J. G.), appointed Lecturer and Demonstrator in Mine Surveying in Birmingham University, 90
- Garstang (Prof. W.), Friendship (To T. H. R.), 594; Haeckel's Biogenetic Law, 542
- Gaselee (S.), Co-operative Indexing of Periodical Literature, 551
- Gask (Lilian), Betty and Bobtail at Pine-Tree Farm, 41
- Gaster (L.), elected Honorary General Secretary of the British International Association of Journalists, 342
- Gatehouse (T. E.), [obituary], 213
- Gatenby (Dr. J. B.), appointed Professor of Biology in the University of Rangoon, 411
- Gates (Dr. R. R.), appointed Professor of Botany at King's College, London, 442; Mutations and Evolution, 636, 714; The Genetics of Sex, 571; The Inheritance of Acquired Characters, 89
- Gates (S. B.), Pure Mathematics for Engineers, 2 parts, 134
- Gault (H.), and R. Weick, Additional Properties of the Keto-enolic Double Linkage, 799
- Gebien (H.), The Tenebrionidæ, 413
- Geley (G.), translated by S. de Brath, From the Unconscious to the Conscious, 712
- Gemmill (W.), appointed Assistant Lecturer on Clinical Surgery in Birmingham University, 90
- General Electric Co., Ltd., Research Staff of the, A Method for the Micro-analysis of Gases by the Use of the Pirani Pressure Gauge, 477
- Ghosh (Prof. P. N.), Young's Interference Experiment, 362
- Ghosh (Miss I. S.), The Phytogeography and Flora of the Mountain-summit Plateaux of Tasmania, 347
- Giblett (M. A.), Some Problems connected with Evaporation, 541
- Gibson (P. I. C.), appointed a Demonstrator in Pathology in Manchester University, 507
- Gibson (Dr. W.), Coal in Great Britain, 38
- Gilbert (Dr. G. K.), Hydraulic Mining Débris in the Sierra Nevada, 404
- Gilchrist (Miss Elizabeth), The Utilisation of Solid Caustic Soda and the Absorption of Carbon Dioxide, 639
- Giles (A. W.), The Eskers in the Vicinity of Rochester, New York, 533
- Gill (Brevet Lt.-Col. C. A.), The *Rôle* of Meteorology in Malaria, 791
- Gill (E. L.), The Annular Eclipse, 212
- Glangeaud (P.), The Earthquake of October 3, 1920, 94
- Glasgow (A. G.), Gift to Leeds University, 604
- Godard (H.), Observations of the Reid Comet, 286; Observations of Winnecke's Comet, 1912b, 414
- Godlee (Sir Rickman J.), Six Papers by Lord Lister with a Short Biography and Explanatory Notes, 232; Thomas Wharton Jones, F.R.S., 829
- Godwin-Austen (Lt.-Col. H. H.), Mount Everest, 137
- Goldsbrough (Dr. G. R.), The Influence of Satellites upon the Form of Saturn's Ring, 445
- Goldschmidt (Prof. R.), The Determination of Sex, 780
- Goodacre (W.), Study of the Moon's Surface, 825
- Goodrich (Prof. E. S.), elected Linacre Professor of Zoology and Comparative Anatomy in Oxford University, 766
- Gordon (J. W.), Meteors on the Moon, 234
- Gorgas (the late Surg.-Gen.), proposed Institute for Tropical Diseases in Panama in Memory of, 277
- Goris (A.), and C. Vischniac, The Alkaloids of Valerian, 383
- Gouy (G.), The Calculation of the Coma, 286
- Graham (P. A.), Highways and Byways in Northumbria, 168
- Gramont (A. de), Spectra of Quantitative Sensibility of Silicon in Fused Salts and in Steels, 702; and G. A. Hemsalech, The Conditions of the Emission of the Spark Lines by the Electric Arc, 799
- Granger (R. F.), Observations of the Solar Eclipse, 247
- Grassi (Prof. G. B.), elected a Foreign Member of the Linnean Society, 369; Can Anopheles Propagate Malaria Directly?, 254; Life of Anopheles, ii., 127
- Gray (Prof. A.), Matter and Motion, 98; Sir J. J. Thomson's Elements of the Mathematical Theory of Electricity and Magnetism. Fifth edition, 647
- Gray (J.), The Mechanism of Ciliary Movement, 190

- Greaves (W. M. H.), awarded a Smith's Prize, Cambridge University, 60; elected to an Isaac Newton Studentship in Astronomy in Cambridge University, 123
- Green (E. E.), Observations on British Coccidæ, 724
- Greenhill (Sir G.), Principles of Picture-hanging, 491
- Gregory (H. E.), The Navajo Country, 406
- Gregory (Prof. J. W.), Marine Deposits, 292
- Gregory (Sir Richard), address to the British Science Guild, 507
- Gregory (Dr. W. K.), The Evolution of the Lachrymal Bone in Vertebrate Animals, 279
- Greig-Smith (Dr. R.), The Extraction of Acids from Cultures, 575; The High-temperature Organism of Fermenting Tan Bark. Part i., 479
- Grey (E. C.), and E. G. Young, The Enzymes of *B. coli communis*. Part i., 61.
- Grierson (W. W.), The Use of Reinforced Concrete on British Railways, 596
- Griffith-Boscawen (Sir Arthur), Importance of the Work Done at the Rothamsted and other Research Institutions, 375
- Griffiths (Dr. A.), and Constance H. Griffiths, Viscosity of Water and Low Rates of Shear, 350
- Griffiths (E. A.), A Liquid Oxygen Vaporiser, 412
- Grimble (A.), From Birth to Death in the Gilbert Islands, 374
- Griswold (W. S.), Facts about Rattlesnakes, 245
- Grover (C.), [obituary], 20
- Grubb (E.), The Bible: Its Nature and Inspiration, 738
- Gruzewska (Mme. Z.), The Mucilaginous Substances of *Laminaria flexicaulis*, 703
- Guilbert (G.), A Case of Destruction by a Gale, 127
- Guild (J.), The Refractometry of Prisms, 126
- Guillaume (C. E.), The Compulsory Adoption of the Metric System by the Japanese Empire, 253
- Guillaume (J.), Observations of Pons-Winnecke's Comet (1921b), 478; Observations of the Reid Comet made at the Observatory of Lyons, 286; Observations of the Sun made at the Lyons Observatory, 62
- Guillet (L.), and M. Ballay, Critical Points Due to Hardening Caused by Wire-drawing, 639
- Guilliermond (Prof. A.), The Microsomes and the Lipoid Formations of the Plant Cell, 671; Translated and Revised by Dr. F. W. Tanner, The Yeasts, 387
- Guldberg (Prof. A.), Une Application des polynômes d'Hermite à un problème de statistique, 824
- Gunther (R. T.), Early Science in Oxford. Part i., Chemistry, 13
- Guntz (A. A.), An Automatic Apparatus for Recording the Variations of a Gaseous Mass with Time, 319
- Gurney (J. H.), Transportation of Young Birds in Mid-air, 245
- Hackspill (L.), and E. Botolfsen, The Preparation of Calcium Carbide by Calcium Ammonium and Acetylene, 735
- Haddon (Dr. A. C.), appointed Deputy Curator of the Museum of Archaeology and Ethnology, Cambridge University, 830; The Migrations of Cultures in British New Guinea, 532; The Outriggers of Indonesian Canoes, 244; The Practical Value of Ethnology, 500
- Hadfield (Mrs. E.), Among the Natives of the Loyalty Group, 495
- Hadfield (Sir Robert), awarded the John Fritz Gold Medal, 21; Address of Thanks on Presentation of the John Fritz Medal, 629; The Present Labour Unrest, 342; The World's Hunger for Iron and Steel, 506
- Hagen (Dr. J. G.), Periodicity of Variable Stars, 566
- Hailwood (A. J.), awarded the Moseley Memorial Prize in Physics in Manchester University, 732
- Haines (Miss F. E.), elected to a Scientific Fellowship at Girton College, 474
- Haldane (Lord), Administration of Scientific Work, 430; The Nationalisation of the Universities, 733; The Reign of Relativity, 578
- Haldane (Dr. J. S.), Mechanism, Life, and Personality: An Examination of the Mechanistic Theory of Life and Mind. Second edition, 136
- Hale (A. J.), elected Professor of Applied Chemistry at the Finsbury Technical College, 830
- Haler (P. J.), and A. H. Stuart, A Second Course in Mathematics for Technical Students, 134
- Hall (A. D.), Corundum in the Northern and Eastern Transvaal, 794
- Hall (A. H.), The Influence of the Automatic and Semi-automatic Machine on the Skill and Resourcefulness of the Mechanic and Operator, 596
- Hall (Sir Daniel), The Present Position of Research in Agriculture, 731; The Relationships Between Research Stations, College, and Farm Institutes, etc., 700
- Haller (Prof. A.), elected a foreign member of the Royal Society, 342
- Hankin (Dr. E. H.), Flight, 86; The "Flight" of Flying-fishes, 797; The Soaring Flight of Dragon-flies, 509
- Hann (Prof. J. von), The Energy of Cyclones, 11
- Harbord (F. W.), The Chief Metallurgical Developments in this Country since 1914, 344
- Harden (Prof. A.), Bertrand and Thomas's Practical Biological Chemistry, 390; Euler and Lindner's Chemie der Hefe und der alkoholischen Gärung, 485
- Harding (C.), Great British Droughts, 627; Vegetation Around London Earlier than in the Provinces, 269
- Harding (W. A.), The Leeches of the Chilka Lake, 371
- Hardy (Prof. G. H.), The International Research Council, 107
- Hardy (W. B.), Colloidal Theory, 226
- Harker (A.), Notes on Geological Map-reading, 294
- Harkins (Prof. W. D.), Isotopes: their Number and Classification, 202
- Harlan (H. V.), and H. K. Hayes, Production of *Haxtoni* in a Number of Crosses, 251
- Harmand (Dr. J.), [obituary], 341
- Harriot (Thomas), Tercentenary of the Death of, 564
- Harris (G. T.), The Desert Flora of a Small Area in East Devon, 404; Why do Worms Die?, 269
- Harrison (Dr. J. W. H.), The Colours of Primroses, 359
- Hartree (W.), and Prof. A. V. Hill, A Method of Analysing Galvanometer Records, 318
- Hartridge (Dr. H.), A New Acoustical Phenomenon, 586; appointed Senior Demonstrator in Physiology in Cambridge University, 475; The Resonance Theory of Hearing, 204, 394, The Resonance Theory of Hearing: A Method of Projecting Interference Bands; A Method of Projecting Absorption Spectra; The Shift of Absorption Bands with Change of Temperature, 446; Wrightson's Hypothesis of Audition, 811
- Hartshorn (L.), and E. S. Keeping, Vacuum Tubes used as Detectors of Electrical Oscillations, 445
- Harvey (W. W.), elected to a John Lucas Walker Studentship in Pathology in Cambridge University, 316
- Hatch (Dr. F. H.), appointed Technical Adviser to the Mines Department on Metalliferous Mining, 114
- Hatschek (E.), A Simple Apparatus for Determining the Congulation Velocity of Gold Sols, 702
- Houghton (Dr. J. L.), and Kathleen E. Bingham, Constitution of the Alloys of Aluminium, Copper, and Zinc Containing High Percentages of Zinc, 29
- Havelock (Prof. T. H.), The Stability of Fluid Motion, 29
- Hawkes (L.), appointed Reader in Geology at Bedford College for Women, 572
- Hawkes (Mrs. O. A. M.), The Biology and Genetics of *Adalia bipunctata*, 724
- Hawkins (H. P.), Stella Maitland: or, Love and the Stars, 777
- Hawkshaw (J. C.), [obituary], 20
- Hawley (Lt.-Col. W.), Excavations at Stonehenge, 23
- Haworth (A.), appointed a Demonstrator in Pathology in Manchester University, 507
- Hayata (B.), Icones Plantarum Formosanarum. Vol ix., 346
- Hayes (H. K.), J. H. Parker, and C. Kurtzweil; Inheritance of Rust Resistance, 251
- Hazard (D. L.), Alaska Magnetic Tables and Magnetic Charts for 1920, 72
- Head (Dr. H.), Release of Function in the Nervous System, 359
- Heath (the late A. G.), The Moral and Social Significance of the Conception of Personality, 777
- Heath (Sir Thomas), The Copernicus of Antiquity (Aristarchus of Samos), 713

- Heawood (E.), The World-map Before and After Magellan's Voyage, 214
- Hecht (Dr.), Suggestions for Co-operation between French and British Museum Curators, 469
- Heim (Dr. A.), The Weight of Mountains, 469
- Helena Victoria (Princess), Visit to Leeds University, 123
- Hemptonne (A. de), The Law of Faraday, and the Action of the Silent Electric Discharge on the Metallic Oxides, 703
- Henderson (J.), and M. Ongley, Geology of the Osborne and Whatatutu Sub-divisions, N.Z., 828
- Henderson (J. B.), The Scaphopoda of the Eastern Coast of America, 117
- Henderson (Sir J.), Prof. H. R. Hassé, A Contribution to the Thermodynamical Theory of Explosions, 573
- Henderson (Miss Margaret), The Structure and Saprophytism of the Pyrolacæ and Monotropacæ in Relation to the Ericaceæ, 765
- Henriot (M. and Mme. E.), The Double Refraction of Compressed Glass, 607
- Henroteau (Dr. F.), Les Etoiles Simples, 583
- Henry (D. C.), appointed Lecturer in Chemistry in Manchester University, 732
- Hepburn (Dr. J. S.), and Dr. E. Q. St. John, The Active Digestive Agent in the Liquor secreted in the Pitchers of *Nepenthes*, 764
- Herbert (D. A.), The Mode of Ascent of Waterfalls by the Narrow-mouthed Lamprey, 436
- Herdman (Prof. W. A.), Final Report of the Grain Pests (War) Committee, 180; Oceanographic Research, 172
- Herford (Miss May A. B.), appointed Lecturer in Classical Archaeology in Manchester University, 507
- Heron-Allen (E.), Phenomena of "Intelligence" in the Protozoa, 456
- Herpin (R.), The Origin and the Rôle of the Reserve Cells of the General Cavity in *Perinereis cultrifera* and *P. Marioni*, etc. 768
- Herron (Prof. E. F.), and Prof. E. Wilson, The Magnetic Susceptibility of Certain Natural and Artificial Oxides, 126
- Herschel (Col. J.), [death], 466
- Herzfeld (Miss Gertrude, M.A.), awarded the William Gibson Research Scholarship for Medical Women, 540
- Hess (Prof. A. F.), Scurvy: Past and Present, 713
- Hewett (D. F.), and C. T. Lupton, Anticlines in the Bighorn Basin, Wyoming, 216
- Hewlett (Prof. R. T.), and Dr. A. T. Nankivell, The Principles of Preventive Medicine, 676
- Hey (W. H.), appointed Lecturer in Systematic Surgery in Manchester University, 669
- Hicks (Dr. W. M.), awarded the Adams Prize of Cambridge University, 379
- Hickson (Prof. S. J.), Some Alcyonaria in the Cambridge Museum, 189; The Neglect of Science, 779
- Hiern (W. P.), A New Species and a New Variety of *Diospyros*, 640
- Hilger, Ltd. (Adam), Catalogue of Optical Instruments, 725
- Hill (Prof. A. V.), The Energy involved in the Electric Change in Muscle and Nerve, 317
- Hill (G. F.), Diptera found in Association with Termites, 799
- Hill (Prof. Leonard), The Peculiar Effects of Light, 567
- Hilton (Prof. H.), A Note on Crystal Measurement, 605; Plane Algebraic Curves, 388; The Vibrations of a Crystalline Medium, 189
- Hinds (Dr. J. I. D.), [obituary], 277
- Hingston (Capt. R. W. G.), A Naturalist in Himalaya, 210
- Hinshelwood (C. N.), and E. J. Bowen, Influence of Physical Conditions on the Velocity of Decomposition of Certain Crystalline Solids, 285
- Hirst (S.), Some New and Little-known Acari, mostly Parasitic in Habit, 253
- Hobson (B.), The Drought and Underground Water, 684
- Hobson (R. L.), appointed Deputy Keeper in the Department of British Antiquities of the British Museum, 51; appointed Keeper of the Department of Ceramics and Ethnography of the British Museum, 722
- Hoernlé (Prof. R. F. A.), Studies in Contemporary Metaphysics, 228
- Hogarth (D. G.), Hittite Seals: With particular reference to the Ashmolean Collection, 70
- Holdedahl (O.), The Zoned Concretions of Calcite in the Magnesium Limestone of Durham, 795
- Hollander (Dr. B.), In Search of the Soul and the Mechanism of Thought, Emotion, and Conduct, 2 vols., 644
- Holleman (Prof. A. F.), edited by Dr. A. J. Walker, assisted by Dr. O. E. Mott, A Text-book of Organic Chemistry. Fifth English edition, 325
- Hollingworth (S. E.), elected to the Harkness Scholarship in Geology in Cambridge University, 572
- Hollis (Dr. I. N.), and others, Speeches at the Presentation of the John Fritz Medal to Sir Robert Hadfield, 594
- Holloway (Dr. J. E.), The Structure of the Prothallus in *Lycopodium*, 151
- Honda, Matsushita, and Idei, Cause of Quenching Cracks in Steel, 534
- Hood (G. F.), and Major J. A. Carpenter, A Text-book of Practical Chemistry, 708
- Hopkins (Prof. F. G.), elected to the Sir William Dunn Professorship of Biochemistry in Cambridge University, 284
- Hopkinson, Bertram, The Scientific Papers of, Collected and Arranged by Sir J. Alfred Ewing and Sir Joseph Larmor, 675
- Horne (Prof. A. R.), A Graphical Method of Determining Shear Influence Lines, etc., 93
- Horst (Dr. C. I. van der), Madreporaria, Agariciidæ, 413
- Horwood (A. R.), A New British Flora: British Wild Flowers in their Natural Haunts (In Six Volumes). Vols. I. and II., 232; The Outdoor Botanist, 293
- Houstoun (Dr. R. A.), Young's Interference Experiment, 268
- Howard (A.), Agriculture in India, 58
- Howard (Dr. L. O.), Annual Report of the Entomologist to the U.S. Department of Agriculture, 343
- Howe (J. Allen), Stones and Quarries, 423
- Howorth (Sir Henry H.), Transcendental Premises in Science, 9
- Hoy (C. M.), The Game Laws in Australia, 435
- Hudson (A. E. L.), Auroral Display, 359
- Huebner (Prof. J.), Dyes and Dyeing, 421
- Hügel (Baron R. von), resignation of the Curatorship of the Museum of Archaeology and Ethnology, Cambridge University, 830
- Hughes (W. E.), The Forms of Electro-deposited Iron and the Effect of Acid upon its Structure. Part i., Deposits from the Chloride Bath, 253
- Humbert (G.), [obituary], 84
- Hume (Dr. W. F.), Preliminary Report on Abu Durba, Western Sinai, 827; Relations of the Northern Red Sea and its Associated Gulf-areas to the "Rift" Theory, 574
- Humphreys (Prof. W. J.), Physics of the Air, 66
- Humphry (R. H.), The Hot-wire Incliner, 126
- Hunter (Dr. J. de Graaff), Atmospheric Refraction, 745
- Huntington (E.), and S. W. Cushing, Principles of Human Geography, 774
- Hutchinson and Richards, Artificial Farmyard Manure, 828
- Hutton (J. H.), A Form of Lycanthropy in Assam among the Naga Tribes, 278
- Huxley (Dr. L.), Anniversaries and Other Poems, 136
- Huxley (J. S.), Sex-ratios and the Ways of Modification in Animals and Plants, 116; The "Flight" of Flying-fish, 267
- Huygens (Christiaan), Œuvres Complètes de, Tome Quatorzième. Calcul des Probabilités. Travaux de Mathématiques Pures; 1655-1666, 4
- I. (R. T. A.), Logs and Antilogs, 300
- Ibbotson (F.), The Chemical Analysis of Steel-works' Materials, 741
- Ibbs (T. L.), Some Experiments on Thermal Diffusion, 318
- Idrac (M.), Experimental Studies on Hovering Flight, 446
- Ijima (Prof. I.), [obituary], 277
- Illingworth (S. R.), Apparatus for the Testing of Dust from Coal-mines, 87
- Imms (Dr. A. D.), Isle of Wight Disease in Hive Bees, 283; The Lac and Shellac Industry in India, 797
- Inge (Very Rev. Dr. W. R.), Social Degeneration, 452; The Road to Ruin and the Way Out, 506

- Irwin-Smith (Vera), Life-histories of Australian Diptera Brachycera. Part i., Stratio-myiidae, No. 2, 799
- Ise (Prof. J.), The United States Forest Policy, 326
- Issel (A.), First Steps in the Systematic Arrangement of Geological Marks, 351
- Ives (Major H. E.), Airplane Photography, 39
- Jack (R. L.), The Salt and Gypsum Resources of South Australia, 795
- Jackson (Sir Herbert), Presidential Address to the Institute of Chemistry, 22
- Jackson (H. G.), appointed Reader in Zoology at Birkbeck College, 443
- Jackson (J.), Double Stars, 217
- Jaeger (Prof. F. M.), Lectures on the Principle of Symmetry and its Applications in all Natural Sciences. Second (augmented) edition, 200
- Jameson (Dr. H. Lyster), The Japanese Artificially-induced Pearl, 396, 621
- Japan (The Crown Prince of), conferment upon of an Honorary Degree by Cambridge University, 411; Visit to Greenwich Observatory, 369
- Jarry-Desloges (R.), Study of the Bright Martian Areas, 607
- Jarvis (Florence E.), The Hydroids of the Western Indian Ocean, 413
- Jauch (L.), The Electrical and the Mechanical Methods of connecting the Propellers of a Ship with the Steam Turbines, 724
- Jeans (J. H.), Cosmogony and Stellar Evolution, 557, 588; Relativity and the Velocity of Light, 42, 169; The Dynamical Theory of Gases. Third edition, 804; The Mathematical Theory of Electricity and Magnetism. Fourth edition, 133
- Jeffreys (Dr. H.), The Accelerations of the Sun and Moon, 281; Certain Geological Effects of the Cooling of the Earth, 445; The Concept of "Space" in Physics, 267; The Physical Status of "Space," 394; Uniform Motion in the Æther, 747
- Jellicoe (Lord), and others, Speeches at the Opening of the Cawthron Institute, Nelson, 435, 668
- Jenkin (Prof. C. F.), and D. N. Shorthose, The Total Heat of Liquid Carbonic Acid, 412
- Jenkins (Rhys), The Rise and Development of the Sussex Iron Industry, 240, 630
- Jeness (D.), and the late Rev. A. Ballantyne, The Northern D'Entrecasteaux, 111
- Jewett (F. B.), Industrial Research, 121
- Joerg (W. L. G.), Visit to Europe to Study the Present Status and Tendencies of Geography, 434
- Johnsen (A.), and K. Rahbek, New Technical Applications of an Electrostatic Principle, 439
- Johnson (C. M.), Rapid Methods for the Chemical Analysis of Special Steels, Steel-making Alloys, their Ores and Graphites. Third edition, 423
- Johnson (Prof. T.), and Miss J. G. Gilmore, Occurrence of Dewalquea in the Core of the Bore made at Washing Bay, Co. Tyrone, 477; The Occurrence of a Sequoia at Washing Bay, Co. Tyrone, 639
- Johnson (T. B.), A. J. Hill, and E. B. Kelsey, Alkyl Amides of *iso*-Thiocyanacetic Acid, 94
- Johnson (W. E.), re-elected a University Lecturer in Moral Science in Cambridge University, 474
- Johnston (Sir H. H.), Sport and Administration in Central Africa, 518; The Man Who Did the Right Thing: A Romance of East Africa, 486
- Joleaud (L.), A Deep Boring which Demonstrates the Existence of Transported Strata in Northern Tunis, 447
- Jolibois (P.), A Photographic Method of Registering Chemical Reactions accompanied by a Variation in Pressure, 254; and Bouvier, The Reversibility of the Reaction $\text{CaCO}_3 = \text{CO}_2 + \text{CaO}$, 447
- Joly (H.), The Geology and Physical Geography of the Rio Guddiati Depression (Sierra Morena, Spain), 254
- Joly (Prof. J.), A Quantum Theory of Colour Vision, 317; Light and Electrons, 203; Scientific Research, 657; The Universities and Research, 760
- Jones (Prof. B. M.), appointed Principal of the Manchester College of Technology, 156
- Jones (Chapman), The Sir William Abney Memorial Lecture, 662
- Jones (E.), appointed Lecturer in Engineering in Manchester University, 669
- Jones (Prof. F. Wood), Human and Other Tails, 487
- Jones (H. Spencer), Stellar Magnitudes and their Determination, 142, 173, 205; The Application of Interference Methods to Astronomy, 685
- Jones (L. A.), and C. E. Fawkes, The Action of Photographic Reducers on the Images Produced on Development Printing Papers, 344
- Jones (Prof. O. T.), The Valentian Series, 350
- Jones (W. J.), appointed Professor of Chemistry in the University College of South Wales and Monmouthshire, 572
- Jones (Prof. W. N.), and Dr. M. C. Rayner, A Text-book of Plant Biology, 37
- Jordan (J. B.), Nets for Making Models of Simple Crystal-forms, 794
- Jouguet (E.), The Case of Poincaré in the Theory of Elasticity, 30
- Jourdain (Rev. F. C. R.), To lead a Biological Expedition to Spitsbergen, 214
- Joyce (T. A.), appointed Deputy Keeper of the Department of Ceramics and Ethnography of the British Museum, 722
- Kapetyn (Prof. J. C.), and Dr. P. J. Van Rhijn, Statistics of Proper Motions, 694
- Karsten (Dr. R.), The Sociology of the Indian Tribes of Ecuador, 150
- Katz (F. J.), and A. Keith, The Newington Moraine of New England, 86
- Kaye (Dr. G. W. C.), and Prof. T. H. Laby, Tables of Physical and Chemical Constants, and Some Mathematical Functions. Fourth edition, 264
- Kayser (E.), The Influence of Uranium Salts on Nitrogen Fixation, 414
- Keartland (G. A.), The Common Fox in Australia a Source of Revenue, 53
- Keith (Sir Arthur), appointed Arnott Demonstrator at the Royal College of Surgeons of England, 507; Human and Other Tails, 487; Human Palæontology, 322
- Keith (J.) [obituary], 51
- Kellas (Dr. A. M.) [death], 498; [obituary article], 560
- Keltie (Sir John Scott), The Position of Geography in British Universities, 502
- Kemble (E. C.), The Constitution of the Helium Atom, 662
- Kenyon (Sir Frederic), Presidential Address to the Museums Association, 822
- Kernot (M. E.), The Present System of Education of Engineers and Architects, 441
- Kerrison (Dr. P. D.), Diseases of the Ear. Second edition, 743
- Khan (Prof. M. A. R.), The Equation $UV = -f^2$, 309
- Kidd (Dr. W.), Initiative in Evolution, 419
- Kidston (Dr. R.), and Prof. W. H. Lang, Old Red Sandstone Plants, Showing Structures from the Rhynie Chert Bed, Aberdeenshire. Parts iv. and v., 382
- Kikuchi (Baron T.), [obituary article], 83
- Kilian (W.), and F. Blanchet, a Sub-alluvial Sheet of Thermal or Mineralised Water in the Bed of the Durance, at Serre-Ponçon, 639
- King (Dr. L. V.), Some New Formulæ for the Direct Numerical Calculation of the Coefficient of Mutual Induction of Coaxial Circles, 736
- King (W. B. R.), The Surface of the Marls of the Middle Chalk in the Somme Valley, etc., 158
- Kinghorn (J. R.), appointed Assistant in Charge of Reptiles, Birds and Amphibians in the Australian Museum, Sydney, 434
- Kinsey (A. C.), The American Cynipidæ or Gallwasps, 85
- Klähn (Dr. H.), The Value of the Statistics of Variation for the Study of Fossils, 215
- Knapp (A. W.), Cocoa and Chocolate: Their History from Plantation to Consumer, 357
- Knapp (L. F.), The Solubility of Small Particles and the Stability of Colloids, 381
- Knibbs (G. H.), elected President of the Australasian Association, 408; World and Empire Development, 441

- Knox (Alice V.), with chapters on the Production of X-rays and Instrumentation by Dr. R. Knox, General Practice and X-rays, 454
- Kochler (Prof. R.), Faune de France. No. 1. Echinodermes, 776
- Kohler (Mlle. D.), The Variation of Organic Acids in the Course of Anthrocyanic Pigmentation, 191
- König (Dr.), A New Sensitiser, "Pinaflavol," 217
- Kopaczewski (W.), Food Anaphylaxy and its Therapeutics, 543; Surface Tension and Antianaphylaxy, 319; The Role of Surface Tension in the Phenomena of Shock, 31
- Kraus (Prof. E. H.), and Dr. W. F. Hunt, Mineralogy: An Introduction to the Study of Minerals and Crystals, 646
- Kunhardt (Major J. C. G.), and Assistant-Surgeon G. D. Chitre, Eradication of Plague Infection by Rat Destruction, 757
- Kunitomi (Sin-iti), and H. Takò, The Correlation between the Fluctuation of Solar Activity and the Terrestrial Precipitation of Rain, 793
- Kunz (Dr. G. F.), Report on Precious Stones for 1919, 59
- Kyle (H. M.), Asymmetry, Metamorphosis, and Origin of Flat-fishes, 317
- Laby (Prof. T. H.), The Organisation of Science in Australia, 124, 442
- Lacroix (A.), The Mineralogical Composition of Rockallite, 799
- Ladd (Prof. G. T.), [death], 755
- Lafferty (H. A.), The "Browning" and "Stem-break" Disease of Cultivated Flax caused by *Polyspora lini*, n. gen. et sp., 253
- Laing (F.), The Cockroach, 565
- Laird (Prof. J.), A Study in Realism, 228
- Lake (P.), re-appointed Royal Geographical Society Reader in Geography in Cambridge University, 572
- Lamb (C. G.), Diptera (iii.), 413; Insect Oases: Venational Abnormalities in Diptera, 189; Secondary Sexual Characters in the Diptera, with a Description of a Novel Type, 509
- Lamb (Prof. H.), An Elementary Course of Infinitesimal Calculus. Third edition, 775; Proposed Appointment to the Rayleigh Lectureship in Mathematics in Cambridge University, 348; and R. V. Southwell, The Vibrations of a Spinning Disc, 318
- Lambert (P.), The Use of Polarised Light for the Examination of Old Pictures, 607
- Lamont (Miss Augusta), The Development of the Feathers of the Duck during the Incubation Period, 639
- Lamplugh (G. W.), The Junction of Gault and Lower Greensand near Leighton Buzzard, 476; C. B. Wedd, and J. Pringle, Iron Ores: Bedded Ores of the Lias, Oolites, and Later Formations in England, 261
- Lance (R.), An Anticryptogamic Product, 447; The Use of Coloured Screens for Fighting against Cryptogamic Diseases of Plants, 447
- Landon (J. W.), Elementary Dynamics: A Text-book for Engineers, 134
- Landman (Dr. G.), The Darimo; or, Protective Figures of Houses in New Guinea, 116
- Lane-Clayton (Dr. Janet E.), The Child Welfare Movement, 328
- Lang (Prof. V. von), [death], 597
- Langdon (Prof. S.), The Early Chronology of Sumer and Egypt and the Similarities of their Culture, 315
- Langlois (J. P.), A Moving Belt for the Study of Walking and of Work, 575
- Langmead (Dr. F. S.), appointed Professor of Medicine at St. Mary's Hospital Medical School, 700
- Langmuir (Dr. I.), The "Cubical" Model of the Atom, 310
- Lankester (Sir E. Ray), A Great Giver, 2; A Remarkable Flint Implement, 61, 403; Earthworms Drowned in Puddles, 329; Earth-worms, Mud-worms, and Water-worms, 424
- Laporte (M.), The Measurement of the Mobility of Gaseous Ions by the Toothed-wheel Method, 382
- Larbaud (Mlle.), New Technique for the Inclusions and Microscopical Preparations of Vegetable and Animal Tissues, 511
- Larmor (Sir Joseph), Electro-crystalline Properties as Conditioned by Atomic Lattices, 125; The Cape Observatory, 601; The Nature of the Crystal-reflection of X-rays, 126
- Latham (Major R. O.), The Colour of Primrose Flowers, 301
- Laufer (B.), Sino-iranica: Chinese Contributions to the History of Civilisation in Ancient Iran, with Special Reference to the History of Cultivated Plants and Products, 430
- Laumonier (Dr. J.), La Colloïdothérapie: Résultats cliniques, 358
- Law (A. R.), Helicopters, 622
- Law (Bonar), made an Honorary Member of the Institution of Engineers and Shipbuilders in Scotland, 91
- Layard (Nina F.), A Prehistoric Cooking-place in Norfolk, 623; Mammalian Remains with Moustarian Flint Implements found at Ipswich, 468
- Lazzarino (O.), Limiting Motions of a Semi-rigid Body about a Fixed Point under no Forces, 671
- Leachman (E. C.), Illuminated Signs, 23
- Leake (Dr. H. M.), The Bases of Agricultural Practice and Economics in the United Provinces, India, 807
- Leathes (Prof. J. B.), Molecular Size and Range of Molecular Attractions in Solutions, 138
- Lebeau (P.), and M. Picon, The Action of Sodammonium on Diphenylmethane, Fluorene, and Indene, 734
- Lebesgue (Prof. H.), elected Professor of Mathematics at the Collège de France, 830
- Le Chatelier (Prof.), elected an Honorary Foreign Member of the Chemists' Club, New York, 114; Saline Double Decompositions and their Graphical Representation, 62
- Leckie (Dr. A. J.), Jupiter's Four Great Satellites, 663
- Lee (Lord), Gift of an Estate to the Nation, 499
- Lee (Dr. G. W.), The Mesozoic Rocks of Applecross, Raasay, and North-East Skye, 151
- Lee (W. T.), and F. H. Knowlton, Geology and Palæontology of the Raton Mesa and other Regions in Colorado and New Mexico, 282
- Lees (Lt.-Col. E. F. W.), The Proposed International Air Maps, 533
- Legendre (J.), and A. Oliveau, The Role of the Domestic Rabbit in the Attraction and Nutrition of *Anopheles maculipennis*, 254
- Leggett (B.), Wireless Telegraphy: With Special Reference to the Quenched-spark System, 390
- Legrand (M.), The Estimation of Maltose and Lactose in Presence of Other Reducing Sugars, 159
- Leighton (A. E.), The Applications of Physical and Chemical Science in the Great War, 442
- Lemoine (G.), The Mutual Reaction of Oxalic Acid and Iodic Acid, 702; iii., 767
- Le Rolland (P.), The Deviations from the Law of Isochronism Produced by the Suspension Strip of the Pendulum, 190
- Lesne (P.), A Breeding-ground of *Ceratitis capitata* in the Neighbourhood of Paris, 94
- Le Sueur (H. R.), [obituary article], 658
- Levaditi (C.), Embryonic Leaflets in Relation to Pathogenic Micro-organisms, 831
- Levy (Dr. H.), The Criterion for Stable Flow of a Fluid in a Uniform Channel, 606
- Lewis (E. I.), Inorganic Chemistry. Third edition, 613
- Lewis (Prof. W. C. McC.), A System of Physical Chemistry (in 3 vols.), vol. ii., Thermodynamics. Third edition, 772
- Liljegren (C. O.), Coal, Oil, or Wind, 152
- Lindh (A. E.), The Absorption Spectra of Chlorine for the X-rays, 447
- Lindsay (H. A. F.), and C. M. Harlow, Report on Lac and Shellac, 797
- Line (J.), The Biology of the Crown Gall Fungus of Lucerne, 190
- Lipka (Dr. J.), Graphical and Mechanical Computation, 616
- Lippmann (Prof. G.), [obituary articles], 659, 788
- Lister (Miss G.), Conifers in English Gardens, 537
- Liston (Lt.-Col. W. G.), Plague and Rats, 606
- Litardière (R. de), The Chromosomic Processes in the Diploidic Nuclei of *Podophyllum peltatum*, 383
- Liversidge (Prof. A.), The Designation of Vitamines, 45
- Livingston (Dr. B. E.), re-elected Permanent Secretary of the American Association, 57
- Lockyer (Major W. J. S.), The Annular Eclipse of April 8,

- 303; The New Star of 1912—Nova Geminorum II., 248
- Lodge (Sir Oliver), A Novel Magneto-optical Effect, 553; Light and Electrons, 169; Relativity and the Velocity of Light, 73; Remarks on Simple Relativity and the Relative Velocity of Light, 716, 748; Further Remarks on Relativity, 784; Remarks on Gravitational Relativity, 814; The Gravitational Field of an Electron, 392; The Peltier Effect and Low-temperature Research, 73
- Loeb (L. B.), The Nature of the Negative Carriers Produced in Pure Hydrogen and Nitrogen by Photoelectrons, 223
- Longinescu (G. G.), G. P. Teodorescu, and G. Chaborski, Modified Methods for the Separation of the Metals of the Second Group in Quantitative Analysis, etc., 152
- Longman (H. A.), A New Marsupial Cranium from Pestic tertiary Sand on the Darling Downs, 371
- Longstaff (Dr. G. B.), [obituary article], 401
- Lopez-Lomba (J.), and P. Portier, The Physiological Mechanism of the Resistance of the Rabbit to Air-taminosis, 671
- Lord (Prof. A. R.), The Principles of Politics: An Introduction to the Study of the Evolution of Political Ideas, 264
- Lorentz (Prof. H. A.), to lecture at the Norman Bridge Laboratory of Physics at the California Institute of Technology, 820
- Lo Surdo (Prof. A.), A Spectroscope with Catoptric Grating, 478; Binaural Localisation of Pure Sounds, 351
- Lotka (A. J.), Analytical Note on Certain Rhythmic Relations in Organic Systems, 222
- Louis (Prof. H.), A Study in Geo-chemistry, 581; British Iron Ores, 261; The Coal-mining Industry, 763
- Low (J. W.), appointed Lecturer in Zoology at Birkbeck College, 156
- Lowe (H. J.), Bees and Scarlet-runner Beans, 684, 747; Rev. J. MacEnery's Excavation Work at Kent's Cavern, 758
- Lowery (H.), appointed an Assistant Lecturer in Physics in Manchester University, 380
- Lowry (Dr. T. M.), and Dr. C. P. Austin, Optical Rotatory Dispersion (Bakerian Lecture), 476
- Lubimenko (V.), The State of Chlorophyll in the Plants, 831
- Lucas (J. E.), L'Alimentation et L'Elevage Rationnels du Bétail (Opinions du Prof. A. Mallèvre), 422
- Luce (M.), Chemical Reactions and Radius of Curvature, 510
- Luckiesh (M.), Artificial Light: Its Influence upon Civilization, 486
- Ludford (R. J.), Protozoa and the Evolution of the Gregarious Instinct; and J. B. Gatenby, Dictyokinesis in Germ-cells, or the Distribution of the Golgi Apparatus During Cell-division, 509
- Luiggi (Prof.), Italian Engineering, 60
- Lumière (A.), Surface Tension and Anaphylactic Shock, 127; and H. Couturier, Anaphylaxis in Plants, 511; (A. and L.), and A. Seyewetz, Experiments with Photographic Desensitisers, 633
- Lyot (B.), The Aurora Borealis of May 14-15, 1921, and the Simultaneous Magnetic Phenomena, 478
- MacBride (Prof. E. W.), Weismannism, 80
- MacCullum (A.), Bequest to the Royal (Dick) Veterinary College, 507
- MacDonald (Sir Murdoch), and H. E. Hurst, The Measurement of the Discharge of the Nile through the Sluices of the Assuan Dam, 310
- MacGregor (Prof. D. H.), elected Drummond Professor of Political Economy in Oxford University, 766
- Mackie (Prof. A.), The Need for the Scientific Study of Education, 442
- Macklin (Rev. H. E.), Photographic Catalogue of the Globular Cluster Messier, 15, 311
- MacMahon (Major R. A.), An Introduction to Combinatory Analysis, 357
- Macmillan (G. A.), An Ornithological Problem, 746
- Macnair (Prof. P.), and C. M. Leitch, The Genus *Clisio-phylum*, 606
- Macoun (the late Prof. J.), proposed Memorial to, 403
- MacRitchie (D.), Greenland in Europe, 141
- Maestrini (D.), Action of Enzymes, v., 128
- Maggi (G. A.), Propagation of Waves of Arbitrary Form in Isotropic Media, 127
- Magrini (Prof. G.), The Italian Expedition for Exploring the Seas of the Levant, 478
- Maiden (J. H.), impending Retirement of, as Permanent Honorary Secretary of the Australasian Association, 408
- Mailhe (A.), The Catalytic Decomposition of the Poly-halogen Derivatives of the Paraffins, 639; The Catalytic Hydrogenation of the Phenylhydrazones, 414; The Preparation of a Petrol from a Fatty Oil, 831; The Preparation of the Amines of Secondary Alcohols, 191; and F. de Godon, The Preparation of Mixed Secondary and Tertiary Phenolic Amines, 575
- Maitland (A. G.), Utilisation of the Artesian Water Resources of Western Australia, 501
- Malby (R. A.), A Miniature Alpine Garden from January to December, 253
- Mallam (Dr. E.), appointed Litchfield Lecturer in Medicine in Oxford University, 540
- Malloch (P. D.), [obituary article], 498
- Mallock (A.), Atmospheric Refraction, 456, 745; Helicopters, 553
- Mangin (Prof. L. A.), elected a Foreign Member of the Linnean Society, 369
- Mangin (Capt. P. H.), Boring for Water in Palestine, 559
- Mann (L. M'Lellan), An Archaeological Discovery at Green Island, Jersey, 466
- Manquat (M.), The Phototropism of *Leucoma phaeorrhoea*, 414
- Maquenne (L.), and R. Cerighelli, The Distribution of Iron in Plants, 799
- Marcelet (H.), The Hydrogenation of Some Marine Animal Oils, 734
- Marcelin (A.), The Superficial Extension of Soluble or Volatile Bodies, 734
- Marchant (Dr. J.), appointed a K.B.E., 755
- Marden (Capt. B. J.), Science and Civilisation, 623
- Markham (Sir Clements R.), The Lands of Silence: A History of Arctic and Antarctic Exploration, 291
- Marmar (H. A.), Ocean Tides, 393
- Marr (Dr. J. E.), Yorkshire as an Earth-block Surrounded by Down-folded Strata, 827
- Marshall (Dr. C. H.), A New Treatment for Trypanosomiasis, 540
- Marshall (Dr. J. S.), Principles and Practice of Operative Dentistry. Fifth edition, 484
- Marston (R. B.), Earthworms Drowned in Puddles, 779; Picture-hanging Wire, 362
- Martin (E. A.), The Generation of Heath-fires, 811
- Martin (Dr. G.), The Peltier Effect and Low-temperature Research, 43, 141
- Martin (Prof. J. N.), Botany with Agricultural Applications. Second edition, 168
- Martin (P. H.), elected to the Theodore Williams Scholarship in Anatomy in Oxford University, 604
- Martinet and Coisset, The Action of Chloraloxim on the Aromatic Amines: The Synthesis of Isatins, 478; and Dornier, Isatin 5-Sulphonic Acid, 31
- Marvin (Dr. C. F.), and others, Research Problems in Geophysics, 730
- Mascart (J.), The Method of Working Out Averages in Meteorology, 734
- Mason (C. M.), appointed Senior Lecturer in Engineering in Manchester University, 669
- Massart (Prof. J.), elected a Foreign Member of the Linnean Society, 369
- Mathews (Prof. G. B.), An Algebraical Identity, $4X = Y^2 - 37Z^2$, 456
- Matignon (C.), The Action of Iodine on Different Metals in the Cold, 127; The Principles of Some New Methods Applicable to the Determination of Molecular Weights, 382; and Mlle. G. Marchal, The Use of Enamelled Bombs in Calorimetry, 319
- Matthews (Dr. J. M.), Application of Dyestuffs to Textiles, Paper, Leather, and other Materials, 421
- Matthews (J. R.), The Study of British Roses, 26
- Mawer (Prof. A.), The Place-names of Northumberland and Durham, 776

- Mawson (Sir Douglas), Geographical Problems of To-day and the Status of Geography in Science, 441
- Maxted (Dr. E. B.), Ammonia and the Nitrides: with Special Reference to their Synthesis, 549
- Maxwell (Sir Herbert), Herons and Fish, 490
- Maxwell (Prof. J. Clerk), Matter and Motion. Reprinted with Notes and Appendices by Sir Joseph Larmor, 98
- May (H. G.), Notes on Nematodirus, 343
- May (Dr. P.), The Chemistry of Synthetic Drugs. Third edition, 423
- Mayer (Prof. P.), Zoomikrotechnik: Ein Wegweiser für Zoologen und Anatomen, 71
- Mayer (S. and A.), The Fundamental Organic Substance of Amylopectin, 383
- Mayo-Robson (Sir Arthur), conferment upon, of the Cross of Chevalier of the Legion of Honour, 821
- McBain (Prof. J. W.), A Novel Magneto-optical Effect, 683; Colloids and Colloidal Electrolytes, 46; The Nature of the Emulsoid Colloid State, 73
- McClelland (Prof. J. A.), and J. J. McHenry, Uncharged Nuclei Produced in Moist Air by Ultra-violet Light and Other Sources, 477
- McClymont (J. R.), Essays on Early Ornithology and Kindred Subjects, 167
- McCulloch (L.), Basal Glume-rot of Wheat, 155
- McDonald (Agnes), and Dr. A. E. Trueman, The Evolution of Certain Liassic Gastropods, with Special Reference to their Use in Stratigraphy, 445
- McDougal (Dr. D. T.), elected General Secretary of the American Association, 56
- McDowall (R. J. S.), appointed Lecturer in Experimental Physiology and Experimental Pharmacology in Leeds University, 123
- McDowall (S. A.), Beauty and the Beast: An Essay in Evolutionary Æsthetic, 35
- McGlashan (H. D.), and F. C. Ebert, Southern California Floods of January, 1916, 406
- McHardy (Comdr. J. G.), The Physical Continuity of "Space," 360
- McIntosh (Prof. W. C.), re-elected President of the Ray Society, 115
- McKeown (A.), The Potential of the Iodine Electrode and the Activity of the Iodide Ion at 25° C., 702
- Mead (C. W.), The Diminutive Shrunken Heads made by the Jivaro Indians, 823
- Mees (Dr. C. E. K.), The Structure and Properties of Photographic Films, 502
- Megaw (Lt.-Col. J. W. D.), Plea for Support of the School of Tropical Medicine and Hygiene of Calcutta and Bombay, 156
- Meinzer (O. E.), Geology and Water Resources of Big Smoky, Clayton, and Alkali Spring Valleys, Nevada, 406
- Meldola (the late Prof. R.), Institution of a Medal in Memory of, 601
- Mellanby (Prof.), Vitamins, 568
- Mellanby (Prof. A. L.), and W. Kerr, Pressure-flow Experiments on Steam Nozzles, 54
- Menard (M.), and Pestel, Concerning the Danger of Radiological Installations, 447
- Mendenhall (Prof. C. E.), Aeronautical Instruments, 152
- Mendes-Corrêa (A. A.), Some Sexual Differences in the Skeleton of the Superior Limbs, 254
- Menzies (Prof. J. A.), [death], 659
- Menzies (Prof. A. W. C.), Molecular Structure and Energy, 331
- Mercanton (P. L.), The Application of Stereoscopic Vision to the Control of Glacial Variations, 159
- Merrill (G. P.), American State Geological and Natural History Surveys, 533
- Merton (G.), The Comet Pons-Winnecke, 601
- Merton (Prof. T. R.), Spectrophotometry in the Visible and Ultra-violet Spectrum, 125
- Messel (the late Dr. R.), Impending Institution of a Lecture in Memory of, 755
- Metcalf (M. M.), An Important Method of Studying Problems of Relationship and of Geographical Distribution, 223
- Metcalf (E. P.), and B. Venkateschar, The Absorption of Light by Electrically Luminiscent Mercury Vapour, 286
- Metropolitan-Vickers Electrical Co., Ltd., The Breakdown of a Turbo-alternator, 87
- Metz (C. W.), The Sterility of Mutant Hybrids in *Drosophila virilis*, 223
- Meunier (J.), The Principles of Analysis by means of Reducing Flames, 191
- Meurthe (E. D. de la), Gift to the University of Paris, 572
- Meyer (Mrs. K.), Scientific Life and Works of H. C. Oersted, 492
- Miall (Prof. L. C.), [obituary articles], 16-18
- Michaud (Dr. F.), *Energétique générale*, 455
- Michell (A. G. M.), A New Type of Crankless Steam Engine, 181
- Michelson (Prof. A. A.), Presented with the Albert Medal of the Royal Society of Arts, 84; Recent Applications of Interference Methods, 220
- Middlemiss (C. S.), Geology of Idar State, Bombay Presidency, 827
- Mill (Dr. H. R.), Polar Exploration, 291; The Second Herbertson Memorial Lecture of the Geographical Association, 214
- Millard (W. A.), Green-plant Matter as a "Decoy" for Actinomycetes Scabies in the Soil, 318
- Millikan (Prof. R. A.), appointed Director of the Norman Bridge Laboratory of Physics at the California Institute of Technology, 820
- Millosevich (F.), Minerals of Latian Province, 254
- Mills (E. H. F.), appointed Librarian of Birmingham University, 474
- Mills (Dr. E. J.), [death], 306; [obituary article], 432
- Milne (E. A.), Vectors and Tensors, 30
- Milne (R. M.), Mathematical Papers for Admission into the Royal Military Academy and the Royal Military College and Papers in Elementary Engineering for Naval Cadetships and Royal Air Force for the Years 1911-20, 713
- Milner (H. B.), Oil in Western Sinai, 250
- Minikin (R. C. R.), Practical River and Canal Engineering, 48
- Mirande (M.), Lathvrisism; or, The Intoxication Produced by Vetch-seeds, 414; Seeds giving Hydrogen Sulphide by Fermentation belonging to the Family of the Papilionaceæ, 447; The Extraction and the Nature of the Substance producing Sulphuretted Hydrogen in the Seeds of certain Papilionaceæ, 768
- Mitchell (Dr. A. Crichton), The Magnetic Storm of May 13-17, 392
- Mitra (P.), The Prehistoric Arts and Crafts of India, 630
- Miyake (Prof. T.), [death], 148
- Moberly (W. H.), appointed Professor of Philosophy in Birmingham University 474
- Mockeridge (Dr. Florence A.), appointed Lecturer in Botany and Head of the Biology Department of the University College of Swansea, 637
- Moir (J. Reid), An Early Chellean Palæolithic Workshop-site at Cromer, 406; Flint Implements in the Cromer Forest Bed, 458; Ochreous Flint Artefacts from Sheringham, 684; The Discovery of Large Quartzite Implements of Rostro-carinate and Early Palæolithic Types in Uganda, 649; The Excavation of Barrows on Brightwell Heath, near Ipswich, 723
- Moldenhauer (Prof. W.), Die Reaktionen des freien Stickstoffs, 772
- Moles (E), T. Batuccas, and M. Payà, The Density of the Air at Madrid and its Small Variations, 640; and F. Gonzalez, A New Revision of the Density of Oxygen Gas, 831
- Molinari (Prof. E.), Translated from the third (enlarged and revised) Italian edition by T. H. Pope, Treatise on General and Industrial Organic Chemistry, part i., 325
- Moll (Dr. W. J. H.), A New Registering Microphotometer, 253
- Molliard (M.), Influence of Sodium Chloride on the Development of *Sterigmatocystis nigra*, 414
- Monckton (H. W.), The Distribution of *Taraxacum erythrospermum*, Andr., in the South-East of England, 253
- Montagu de Beaulieu (Lord), Presidential Address to the British Science Guild, 505; Science and the Empire, 313
- Moore (Prof. E. H.), elected President of the American Association for 1921, 56

- Moore (Dr. G. E.), re-elected a University Lecturer in Moral Science in Cambridge University, 474
- Moore (H.), A Small Brinell Hardness Testing Machine, 763
- Moreux (Abbé), A Weather Prediction, 84
- Morgan (Prof. G. T.), The Finsbury School of Chemistry, 154
- Mortensen (Dr. Th.), Studies in the Development of Crinoids, 132
- Morton (Prof. W. B.), A New Acoustical Phenomenon, 586
- Moulton (Lord), [death], 50; [obituary article], 82
- Moureu (Prof. C.), La Chimie et la Guerre, Science et Avenir, 516; M. Murat, and L. Tampier, Acrylic Acid and Acrylic Esters, 510
- Muesebeck (C. F. W.), Revision of the Nearctic Ichneumonidae of the Genus *Apanteles*, 532
- Müller-Lyer (Dr. F.), translated by E. C. Lake and H. A. Lake, The History of Social Development, 452
- Mumford (Dr. A. A.), Testing and Grading of Health and Physical Fitness, 30
- Murphy (P. A.), The Sources of Infection of Potato Tubers with *Phytophthora infestans*, 639
- Murphy (R. C.), The Sea-coast and Islands of Peru, 501
- Murray (Justice), Anthropology and the Government of Subject Races, 441
- Murray (Hon. J. H. P.), and others, Commerce and Customs of Papua, 26
- Musgrave (A.), appointed Entomologist to the Australian Museum, Sydney, 434
- Myers (Dr. C. S.), Health and Work, 354; Industrial Fatigue, 23
- Nathorst (Prof. A. G.), [obituary article], 112
- Naulty (E.), Proposal to Fly by Aeroplane Across the North Pole, 755
- Neale (S. M.), Influence of Solvent upon Ionisation and the Accompanying Heat Effect, 702
- Negretti and Zambra, A Rainfall Rate Recorder, 117
- Nernst (Prof. W.), elected Rector of Berlin University, 732
- Neujmin (G.), The Orbit of Neujmin Comet, 1916a, 345
- Neville-Polley (L. J.), John Dalton, 678
- Newbery (E.), The Life-period of the Over-voltage Compounds, 800
- Newbigin (Dr. Marion I.), Ordnance Survey Maps: Their Meaning and Use. Second edition, 294
- Newcomen (T.), a Memorial to, unveiled at Dartmouth, 722
- Newman (F. H.), A New Form of Wehnelt Interrupter, 318
- Newman (Prof. H. H.), Vertebrate Zoölogy, 229
- Newstead (Prof. R.), The Natural History of the Upper Shiri River, Nyasaland, 381
- Newton (A. P.), Co-operative Indexing of Periodical Literature, 551
- Newton (H. W.), The Recent Large Sun-spot Group, 399
- Newton and Wright, Ltd., A New Model Radioscopic Couch, 437
- Nicholson (Prof. J. W.), elected President of the Röntgen Society, 563
- Nicolle (C.), and A Cuénod, New Acquisitions in the Experimental Study of Trachoma, 382
- Nierenstein (Dr.), and others, The Constitution of Catechin. Parts i.-iii., Studies in the Chroman Series, 280
- Nilsson (Prof. M. P.), Primitive Time-reckoning: A Study in the Origins and First Development of the Art of Counting Time among the Primitive and Early Culture Peoples, 275
- Nisbet (R. H.), Symbols in Vector Analysis, 362
- Noble (Sir William J.), elected President of the North-east Coast Institution of Engineers and Shipbuilders, 629; The Long-distance Telephone System of the United Kingdom, 216
- Nolf (P.), The Action of Chloroform on the Coagulation of the Blood Plasma of Birds, 703
- Nordenskjöld (Dr. O.), Exploration in South America, 21
- Nordmann (C.), Le Morvan, The Determination of the Effective Temperatures of Some Stars and their Colour Index, 734; The Apparent Diameter of α Orion, 319
- Norsworthy (Dr. Naomi), and Dr. Mary T. Whitley, The Psychology of Childhood, 164
- North (Dr. F. J.), Syringothyrus and Spiriferina, 501
- Norton (W. A.), Circumcision Regiments as a Native Chronology, 607
- Nuttall (J. M.), appointed Assistant Director of the Physical Laboratories in Manchester University, 732
- Nutting (C. C.), Barbados-Antigua Expedition, 829
- Nutting (Dr. P. G.), Relation between Deformation and Force, 633
- O'Connell (Dr. Marjorie), Jurassic Ammonites from Viñales, Cuba, 631
- Odling (Prof. W.), [obituary article], 19
- O'Donoghue (Prof. C. H.), An Introduction to Zoology, 740
- O'Dwyer (Margaret H.), The Nutritive Value of Certain Australian Grasses, 800
- Ogg (W. G.), and J. Hendrick, Studies of a Scottish Drift Soil, 85
- Ogilvie (the late Dr. F. M.), A Sportsman-naturalist, edited by H. Balfour, Field Observations on British Birds, 259
- Ohashi (Prof. P.), Augite from Nishigatake, Japan, 189
- Ohshima (H.), Reversal of Asymmetry in the Plutei of *Echinus miliaris*, 125
- Oldham (R. D.), Know Your Faults (Presidential Address to the Geological Society), 92
- O'Neill (H.), appointed an Assistant Lecturer in Metallurgy in Manchester University, 380
- Onnes (Prof. K.), Sir R. Hadfield and Dr. H. R. Woltjer, The Influence of Low Temperatures on the Magnetic Properties of Alloys of Iron with Nickel and Manganese, 285
- Onslow (Hon. H.), The Reparation Act and Scientific Research, 457
- Ormsby (M. T. M.), appointed Professor of Municipal Engineering at University College, London, 700
- Orton (Dr. J. H.), Sex-change in the Native Oyster (*O. edulis*), 586; The Production of Living Clavellina Zooids in Winter by Experiment, 75
- Osborn (Prof. H. F.), Evolution and Geographical Distribution of the Proboscidea, 539; The Evolution, Phylogeny, and Classification of the Proboscidea, 500; The Hall of the Age of Man in the American Museum, 236
- Osborne (Prof. W. A.), "Elementary Practical Biochemistry," 45
- Osler (the late Sir William), A Proposed Memorial Lecture-ship in the University of California, 380
- Ostwald (Prof. W.), translated by Prof. M. H. Fischer, An Introduction to Theoretical and Applied Colloid Chemistry: "The World of Neglected Dimensions," 226; Die chemische Literatur und die Organisation der Wissenschaft, 613
- Overton (Dr.), Observations of the Great Horned Owl, 822
- Owen (Sir Isambard), impending retirement of, from the Vice-Chancellorship of Bristol University, 442; The University of Bristol, 221
- Owens (Dr. I. S.), Atmospheric Pollution by Smoke, 567; London Smoke-fogs, 246
- Oxley (Dr. A. E.), Magnetism and Atomic Structure, 652
- Pack (R. W.), The Sunset Midway Oil Field of California. Part i., Geology and Oil Resources, 347
- Palmer (Dorothy M.), and W. G. Palmer, The Catalytic Reduction of Ethylene to Ethane, 412
- Palmer (W. G.), The Catalytic Activity of Copper. Part ii., 412
- Pariselle (M.), The Composition of French Essence of Turpentine, 607; The Hydrates of Pyridine, 190
- Park (W. E.), A Treatise on Airscrews, 389
- Parker (Dr. G.), The Early History of Surgery in Great Britain, 391
- Parker (Prof. G. H.), appointed Director of the Harvard Zoological Laboratory, 244
- Parkes (A. S.), Departures from Equality of the Sex-ratios in Man, 571
- Parkin (J.), Vitality of Gorse-seed, 491

- Parravano (N.), and C. Mazzetti, Transformation of Light into Heavy Magnesia, 254
- Parry (H.), A Balance Method of Using the Quadrant Electrometer for the Measurement of Power, 253
- Pars (L. A.), awarded a Smith's Prize, Cambridge University, 60; elected to a Fellowship at Jesus College, Cambridge, 348
- Parsons (Prof. F. G.), The Modern Londoner and Long Barrow Man, 186
- Partington (Prof. J. R.), A Modern Inorganic Chemistry, 269; A Text-book of Inorganic Chemistry for University Students, 198; Molecular Structure and Energy, 172; Physical and Inorganic Chemistry, 262; The Reparation Act and Scientific Research, 394; The Ratio of the Specific Heats of Air and of Carbon Dioxide, 541; and C. L. Bryant, British Laboratory Ware and Chemicals, 457
- Partington (Mrs. M.), Set of Cards for Teaching Chemical Formulae and Equations, 296
- Pascal (M.), Superficial Circulation, i., 127; iii., 671
- Pascoe (E. H.), Petroleum in the Punjab and North-western Frontier Province, 792
- Pastorelli and Rapkin, Ltd., List of Hydrometers and Specific-gravity Instruments, 247
- Patterson (Prof. A. H.), The Elementary Particle of Positive Electricity, 75
- Patton (Major W. S.), The Mesopotamian House-flies and their Allies, 117
- Paulsen (O.), Studies in the Vegetation of Pamir, 270
- Pavillard (J.), *Gymnodinium pseudonoctiluca*, 287
- Payn (H.), [obituary], 242
- Peake (H. E.), Racial Types in South-east England, 538
- Pealing (H.), The Reflection of X-ray Spectrum of Palladium from Fluorspar, 477
- Pear (Prof. T. H.), Psychotherapy and War Experience, 122
- Pearl (Prof. R.), A Single Numerical Index of the Age-distribution of a Population, 223; The Conditions of Cellular Immortality, 404; and L. J. Reed, The Rate of Growth of the Population of the United States since 1790, 94
- Pearsall (W. H.), The Development of Vegetation in the English Lakes, considered in Relation to the General Evolution of Glacial Lakes and Rock Basins, 509
- Pease (F. G.), Measurement of the Diameter of Arcturus, 725
- Peck (E. S.), British Pharmacy and its Possibilities, 564
- Pélabon (H.), The Resistance of Thallium Sulphide and Selenide, 735; The Resistivity of Selenium, 790
- Pelseuer (P.), Les Variations et leur Hérité chez les Mollusques, 7
- Penfold (A. R.), The Occurrence of a New Phenol in the Essential Oils of the Leptospermum, 703
- Percival (Prof. J.), Species and Races of Wheat, 538
- Peringuey (Dr.), The Use of the Stone Querns of the Bushmen, 469
- Perkins (Prof. A. J.), Agricultural Education, 442
- Perkins (Dr.), The Food of Trout caught in the Torquay Reservoirs, 757
- Perkins (Dr. R. C. L.), Variation exhibited by the British Species of Parasitic Bumble-bees of the Genus *Psithyrus*, 564
- Perot (A.), Investigation of the Einstein Spectral Shift, 182
- Perotti (R.), Radical Bacilli of *Diblotaxis eucoides*, 127
- Perrett (Dr. W.), The Resonance Theory of Hearing, 301
- Perrier (C.), The True Nature of Rosasite, 351
- Perrier (Prof. E.), [death], 721; [obituary article], 810
- Perry (Sir Cooper), Report on the University of London for 1920-21, 348
- Perry (W. J.), The Development and Spread of Civilisation, 146; The Nature of Man, 710
- Perryoste (F. H.), The Colours of Primroses, 459
- Pes (Prof. G.), Nuova Navigazione Astronomica: Le Rette di Posizione. Teoria-Applicazioni-Tavole. Seconda edizione, 777
- Petavel (Sir J. E.), A Comparison of British and German Volumetric Glassware, 297
- Petersen (Dr. C. G. J.), On the Stock of Plaice in Relation to the Intensive Fishing of the Present Times in the Belt Sea and other Waters, 407
- Pethybridge (Dr. G. H.), awarded the Boyle Medal of the Royal Dublin Society, 51; Sexual Organs of *Phytophthora*, 204
- Petit (Prof. G.), The Effect of Radio-activity on the Fertility of the Soil, 118
- Petrie (Prof. W. M. Flinders), Co-operative Indexing of Periodical Literature, 550; Italian Meteorites, 301; Theban Tombs, 70; Tools and Weapons: Illustrated by the Egyptian Collection in University College, London, and 2,000 Outlines from other Sources, 230; Work of the British School in Egypt, 564
- Petronievics (Dr. B.), The Law of Irreversible Evolution, 501
- Peyronel (B.), Ascophorous Form of *Rhacodiella castaneae*, the Cause of Smut in the Chestnut, 127
- Pfeil (L. B.), appointed Assistant Lecturer in Metallurgy at the University College of Swansea, 637
- Philip (A.), Calendar Reform, 235
- Phillipotts (Dr. Bertha S.), The Elder Edda and Ancient Scandinavian Drama, 168
- Philpot (H. P.), appointed Professor of Civil and Mechanical Engineering at the Finsbury Technical College, 830
- Pickering (Prof. W. H.), The Rotation of Venus, 88
- Picon (M.), A New Method of Preparing the Sodium Derivatives of the True Acetylene Hydrocarbons, 735
- Picone (M.), Potential of a Double Surface Layer, 478
- Pidduck (F. B.), Measurement of Small Inductance, 623
- Pieragnoli (L.), Pathology of Pliocene and Post-pliocene Mammals of Tuscany, 671
- Pierrat (M.), The Solubility of Various Potassium Salts in Mixtures of Water and Alcohol, 382
- Pitt (St. George Lane-Fox), Free Will and Destiny, with Open Letter on the International Moral Education Congress and League of Nations, Sir Frederick Pollock, and Appendix, F. J. Gould, 35
- Plaskett (Dr. H. H.), Radiation from the Carbon Arc, 648
- Playfair (G. I.), Australian Fresh-water Flagellates, 575
- Pledge (J. H.), The Use of Light-filters in Microscopy, 252
- Plehn (Dr. M.), A Cause of Disease in Fish Kept in Tanks and Ponds, 823
- Plimmer (Dr. R. H. A.), Quality of Protein in Nutrition, 664
- Plucknett (T. F. T.), elected Choate Memorial Fellow at Harvard College, 830
- Plummer (Alderman H.), gift to Manchester University, 572
- Plummer (Prof. H. C.), appointed Professor of Mathematics at the Artillery College, Woolwich, 604
- Plymen (G. H.), The Geology of Jersey, 827
- Pocklington (Dr. H. C.), An Algebraical Identity, 587
- Poitevin (E.), and H. U. Ellsworth, Hydrous Calcium Borate Inyoite Found at the Whitehead Gypsum Quarry, Hillsborough, New Brunswick, 823
- Politis (J.), The Brown Corpuscles Causing the Browning of the Vine, 287
- Pollard (Prof. A.), The Measurement of Single and Successive Short Time-intervals, 585
- Pommereau (H. de), The Reduction of Ethyl Naphthoate and a Case of Reduction of an Alcohol to Hydrocarbon by Sodium and Absolute Alcohol, 607
- Ponder (E.), A Method for Investigating the Hæmolytic Activity of Chemical Substances, 509
- Poole (H. H.), The Electrical Conductivity of Some Dielectrics, 253; The Nature of the Electrical Conductivity of Glass, 584
- Pope (Sir William J.), elected Membre d'Honneur of the French Chemical Society, 21
- Popesco (J.), The Value of the Surface Tension of Mercury in Various Gases, 607
- Porter (Prof. A. W.), Some Aspects of the Scientific Work of the late Lord Rayleigh, 252; Variation of Surface Tension and Surface Energy with Temperature, 702
- Porter (C. W.), and F. H. Thurber, A Compound which may Contain Univalent Oxygen, 600
- Portevin (A.), The Electrical Resistance of the Nickel-steels, 94; The Use of very Slow Cooling for the Micrographical Study of Alloys and the Structure of the Tungsten Steels, 350
- Potter (Prof. M. C.), British Plants Available as a Source of Industrial Alcohol, 170
- Poulton (Prof. E. B.), The Inspiration of the Unknown, 537

- Power (Dr. F. B.), presented with a Gold Medal by H. S. Wellcome, 466
- Pranker (T. L.), Studies in the Cytology of the Statolith Apparatus in Plants, Viewed in Relation to their Habit and Biological Requirements, 317
- Pride (A.), Scarcity of Swallows, 779
- Priestley (Prof. H. J.), Relativity and the Deviation of Spectral Lines, 43; The Development of the Theory of Relativity, 440; The Displacement of Spectral Lines by a Gravitational Field, 585
- Prior (Dr. G. T.), The Chemical Composition of the Adare and Ensishheim Meteorites, 189
- Proudman (Prof. J.), Ocean Tides, 176, 300
- Punnett (Prof.), and the late Major P. G. Bailey, Inheritance of Egg-colour and Broodiness in Poultry, 85
- Pycraft (W. P.), The Sea-shore, 103
- Pye-Smith (Prof. R. J.), [obituary], 178; bequest to Sheffield University, 507
- Quénisset (F.), Photographs of the Planet Venus, 670
- Ramage (A. G.), The Conditions for Mirage on the Queensferry Road, 639
- Raman (Prof. C. V.), Conical Refraction in Biaxial Crystals, 747; The Colours of Breathed-on Plates, 714; The Nature of Vowel Sounds, 332
- Ramsay (the late Sir William), a Memorial Tablet to be Placed in Westminster Abbey, 691
- Ramsbottom (Dr. A.), appointed Professor of Clinical Medicine in Manchester University, 380
- Ramsbottom (Capt. J.), Collection of Plants made by various members of H.M. Salonika Forces, 92
- Rankine (Prof. A. O.), Molecular Structure and Energy, 203; The Viscosity and Molecular Dimensions of Gaseous Cyanogen, 412
- Ranque (G.), A New Mercury Lamp, 670
- Ransom (H. B.), [obituary], 114
- Ransome (F. L.), The Copper Deposits of Ray and Miami, Arizona, 59
- Rasmussen (K.), Forthcoming Expedition to the Arctic Regions, 308
- Ratner (Dr. S.), Polarisation Phenomena in an X-ray Bulb, 522
- Raw (Lt.-Col. N.), Immunity in Human Tuberculosis, 148
- Ray (S. H.), Commerce and Customs of Papua, 26
- Rayleigh (Lord), Colour of the Light from the Night Sky, 158; The Aurora of May 13-15, 392; The British Science Guild, 314; The Common Occurrence of Aurora in the South of England, 137; Young's Interference Experiment, 298
- Read (Carveth), The Origin of Man and of his Superstitions, 710; title of Emeritus Professor of Philosophy and Comparative Psychology conferred upon, by London University, 572
- Read (Sir Hercules), impending Retirement of, 342; The Design of Museums, 436
- Reay (Lord), [obituary], 720
- Reboul (G.), and R. Luce, The Influence of the Geometrical Form of Solid Bodies on the Chemical Actions which they Undergo, 319
- Recknagel (Prof. A. B.), and Prof. J. Bentley, jun., Forest Management, 326
- Redfield (A. H.), Foreign Graphite in 1919, 795
- Redmayne (Sir R. A. S.), Pulverised Coal as a Combustible, 812; The Importance of Research in the Development of the Mineral Industries, 566, 568; The Production of Metallic Zinc, 361; The World-position in Relation to Coal, 633
- Reed (H. S.), The Dynamics of a Fluctuating Growth-rate, 222
- Rees (J. P.), appointed Lecturer in Metal Mining in Birmingham University, 90
- Regan (C. Tate), appointed Keeper of Zoology at the Natural History Museum, South Kensington, 51
- Rehberger (Dr. G. E.), Lippincott's Quick Reference Book for Medicine and Surgery, 484
- Reicherbach (H.), Relativitätstheorie und Erkenntnis Apriori, 583
- Reid (Mrs. Eleanor Mary), Two Pre-glacial Floras from beneath the Boulder Clay of Castle Eden, 501
- Reid (Sir G. Archdall), Biological Terminology, 265, 425, 680; Prevention of Venereal Disease, 195; The Natural History of Man, 808
- Reinecke (L.), Mineral Deposits between Lillooet and Prince George, British Columbia, 794
- Reinheimer (H.), Symbiosis: A Socio-physiological Study of Evolution, 35
- Reinmuth (Herr), A Plate of Reid's Comet, 373
- Reinold (Prof. A. W.), [death], 242; [obituary article], 276
- Remy (P.), The Action of the Vapours of Chloropicrin on *Argas reflexus*, 640
- Renard (Lt.-Col.), The Evolution of Aeronautics during the War, 118
- Rengade (E.), and J. Clostre, The Estimation of Water in Transformer Oils, 799; and E. Desvignes, An Arrangement for Testing the Hardness of Refractory Materials at a High Temperature, 735
- Rennie (Dr. J.), and others, Isle of Wight Disease in Hive Bees, 283
- Renshaw (Dr. A.), appointed Lecturer in Pathology in Manchester University, 669
- Richards (E. H.), The Action of Bacteria and Protozoa in Conserving the Nitrogen in Sewage, 318
- Richardson (H.), Foreign Scientific Literature, 458
- Richardson (J. H.), elected Wrenbury Scholar in Political Economy, Cambridge University, 830
- Richardson (N. M.), Picture-hanging Wire, 601
- Richardson (W. A.), The Micropetrography of the Rock-gypsum of Nottinghamshire, 605
- Richert (C.), Mlle. E. Bachrach, and H. Cardot, The Alternations between Tolerance and Anaphylaxy, 639; The Phenomena of Anaphylaxy in Micro-organisms, 126
- Richmond (E. A.), Life-history and Biology of Water-beetles of the Family Hydrophilidae, 150
- Rideal (E. K.), Active Molecules in Physical and Chemical Reactions, 446; appointed to the Humphry Owen Jones Lectureship in Physical Chemistry in Cambridge University, 507; The Catalytic Dehydrogenation of Alcohols, 158; The Latent Heats of Vaporisation, 126; and U. R. Evans, The Problem of the Fuel-cell, 381
- Rideal (Dr. S.), and A. Walker, Approved Technique of the Rideal-Walker Test, 150
- Rigg (G.), Review of the Zinc Industry at the Close of 1919, 279
- Rignano (E.), Psychologie du Raisonnement, 612
- Riley (H. L.), elected to a Beit Fellowship for Scientific Research, 700
- Rimmer (W. B.), grant to, by the Advisory Council for Scientific and Industrial Research, for Astronomical Work, 467
- Ritchie (Dr. J.), appointed Keeper of the Natural History Department of the Royal Scottish Museum, 243; The Walrus in Northern Scotland, 53
- Rivers (Dr. W. H. R.), Instinct and the Unconscious: A Contribution to a Biological Theory of the Psychoneuroses, 515
- Rivett (Dr. A. C. D.), The Applications of Physical and Chemical Science in the Great War, 442
- Robb (Dr. A. A.), The Absolute Relations of Time and Space, 422
- Roberts (C.), appointed Lecturer in Clinical Surgery in Manchester University, 669
- Robertson (Prof. J. K.), The Electrodeless Discharge in Sodium Vapour, 269; Young's Interference Experiment and the Spectrometer, 457
- Robertson (Sir Robert), Some War Developments of Explosives, 524
- Robertson (Dr. R. C.), appointed Assistant Lecturer and Demonstrator in Serology and Immunology at the Bradford Technical College, 28
- Robertson (Sir William), Science and the Empire, 314
- Robinson (Dr. H.), appointed to the Moseley Studentship in the University of Manchester, 530; resignation of, or the Senior Lectureship in Physics in Manchester University, 475
- Robinson (Dr. R.), appointed Professor of Chemistry and Director of the Chemical Research Laboratory in St. Andrews University, 540
- Rocasolano (A. de G.), The Variations Produced by Stabilisers in the Catalytic Power of Electroplatinosols, 767
- Rock (J. F.), The Leguminous Plants of Hawaii, 346

- Roebuck (the late W. Denison), The Distribution of Land and Fresh-water Mollusca in the British Isles, 724
- Rogeri (Fratri), *Nunc primum edidit R. Steele, opera hactenus inedita Rogeri Baconi*, fasc. v., *Secretum secretorum cum glossis et notulis; Tractatus brevis et utilis ad declarandum quedam obscure dicta*, 771
- Rogers (L.), awarded the Rogers Prize by the University of London, 700
- Rogestvsky (D.), Doublets in Spectral Series, 203
- Rolfe (R. A.), [death], 242; [obituary article], 276
- Rolston (Capt. W. E.), [obituary article], 789
- Romani (E.), A Method of Vulcanising Rubber, 671
- Rosa (Dr. E. B.), [death], 401; [obituary article], 465
- Roscoe (Rev. J.), The Milk Customs of Bunyoro, 602
- Rose (Prof. H. J.), Celestial and Terrestrial Orientation of the Dead, 538
- Rosenhain (Dr. W.), The Hardness of Solid Solutions, 318
- Ross (Sir Ronald), State Awards for Medical Discovery, 723
- Ross (A.), Width of Railways, 596
- Ross (Prof. A. D.), elected a Member of the Governing Body of the University of Western Australia, 349
- Rothé (M.), Radiogoniometry and Atmospheric Influences, 542
- Rothschild (Baron Edmond de), gift for the Development of Physico-chemical Research in France, 563
- Rouch (J.), Observations of the Electrical Field of the Atmosphere during the Eclipse of the Sun of April 8, 1921, 319
- Roughton (F. J. W.), elected Michael Foster Research Student in Physiology, Cambridge University, 830
- Roule (L.), A New Deep-sea Fish, *Scombrolabrax heterolepis*, caught near Madeira, 607
- Routledge (Mrs. S.), Carved Rock and Stone Houses in Easter Island, 564
- Rowell (Sir Herbert B.), [obituary], 658
- Rowell (H. S.), A New Acoustical Phenomenon, 586; A New Theorem on the Double Pendulum, 684
- Roxby (P. M.), Satow's A Diplomat in Japan, 263
- Russell (Miss Alice M.), The Macroscopic and Microscopic Structure of some Hybrid Sarracenias, etc., 764
- Russell (Dr. E. J.), appointed a Foreign Corresponding Member of the Reale Istituto Lombardo di Scienze e Lettere di Milano, 402; The Work of the Rothamsted Experimental Station, 700; and others, Physico-chemical Problems relating to the Soil, 504
- Russell (Prof. H. N.), A Superior Limit to the Age of the Earth's Crust, 125
- Russell-Wells (Sir Sydney), re-elected Vice-Chancellor of London University, 572
- Rutherford (Sir Ernest), elected Professor of Natural Philosophy at the Royal Institution, 342; Mass of Long-range Particles from Thorium-C, 246; The Stability of Atoms, 574; and J. Chadwick, The Disintegration of Elements by α -Particles, 41
- Ruttan (Prof. R. F.), nominated President of the Society of Chemical Industry, 563
- Ryan (Prof. H.), The Exploitation of Irish Peat, 728
- Ryrie (B. J.), appointed Lecturer in Morbid Anatomy and Histology in Manchester University, 669
- St. John (Dr. C. E.), and S. B. Nicholson, Displacement of Lines in the Spectrum of Venus, 725
- St. Mars (F.), The Wild Unmasked, 200
- Sabatier (P.), and B. Kubota, The Catalytic Decomposition of Allyl Alcohol: Action of various Oxides, 767; Catalytic Hydrogenation with Copper, 222; The Action of Heat on Allyl Alcohol in presence of various Catalysts, 702
- Sabatini (V.), Unity of the Vulsinio System, 254
- Sadler (Sir Michael), Modern Civilisation, 700; The Finances of Leeds University, 540
- Saha (Prof. Megh Nad), The Atomic Radius and the Ionisation Potential, 682; The Stationary H- and K-lines of Calcium in Stellar Atmospheres, 488
- Sahni (B.), The Cuticular Structure of *Glossopteris angustifolia*, Brongn., 671
- Saintsbury (Prof. G.), Notes on a Cellar-book. New edition, 163
- Salisbury (Dr. E. J.), Phenology and Habitat, with special reference to Woodlands, 414
- Salter (M. de Carle S.), A New Method of Constructing Average Monthly Rainfall Maps, 30
- Salter (H. E.), The Historic Names of the Streets and Lanes of Oxford. *Intra Muros*, 532
- Sampson (Prof.), Theory of Jupiter's Satellites, 405
- Sanford (R. F.), The Companion of a Hercules, 438
- Sartory (A.), and P. Bailly, The Agglutinating Power of Thorium Sulphate on the Spores of *Aspergillus fumigatus*, 478; L. Scheffler, P. Pellissier, and C. Vaucher, A Method of Evaporation, Concentration, and Desiccation of Organic or Mineral Substances, 222
- Satow (Sir Ernest), A Diplomat in Japan, 263
- Saunders (C. B.), Problems of Seed-testing, 509
- Saunders (J. T.), The Hydrogen-ion Concentration of some Natural Waters, 190
- Savage (Sir George), [obituary], 658
- Savour (Dr. Shankar Ras Ullal), appointed Professor of Physics in Presidency College, Madras, 411
- Sazerac (R.), and C. Levaditi, The Action of Bismuth on Syphilis and on the Nagana Trypanosome, 543
- Schaffers (Father V.), The Sound of Distant Gun-fire, 44
- Scharff (Dr. R. F.), A New British Land Planarian, 361
- Scharlieb (Dr. Mary), Vaccination, 244
- Schaumasse (A.), Observations of the Dubiago Comet (1921c), 542
- Schenkling, The Cleridæ, 413
- Scherfschewsky (P.), Dry Mist, 222; Systems of Clouds, 575
- Schiller (Dr. F. C. S.), Arguing in a Circle, 670
- Schmidt, Inheritance of Secondary Sexual Characters, 571
- Schmidt (Dr. Johs.), New Studies of Sun-fishes made during the "Dana" Expedition, 1920, 76
- Schnabel (Prof. C.), translated by Prof. H. Louis. Third edition, revised by the translator. Vol. i., 677
- Schneider (Mr.), The John Fritz Gold Medal awarded to, 530
- Schönfeld (Dr. M.), Prehistoric Astronomy in Scandinavia, 24
- Schuchert (Dr. C.), The Nature of Palæozoic Crustal Instability in Eastern North America, 501
- Schulz (A. R.), The Oil Possibilities in and around Baxter Basin, Rock Springs, 792
- Schulz (Dr. B.), The Variations of Mean Sea-level on the Flemish Coast, 54
- Schuster (Sir Arthur), The International Research Council, 72; The Quantum Theory and Homogenous Vibrations, 233
- Scott (Dr. D. H.), presented with the Linnean Gold Medal of the Linnean Society, 434; Studies in Fossil Botany, Third edition. Vol. i., *Pteridophyta*, 197; The Earliest Land Flora, 537
- Scott (Dr. H.), Clavicorn and other Beetles, 413
- Scott (H. H.), and C. E. Lord, Remains of *Nolotherium* found in Tasmania, 501
- Scott (Dr. J. H. D.), elected to a John Lucas Walker Studentship in Pathology in Cambridge University, 316
- Scott (L.), Agricultural Co-operation, 436
- Scripture (Prof. E. W.), Nature of Vowel Sounds, 12, 333
- Seagrave (F. E.), The Minor Planet Eros, 663; The Ephemeris of Eros, 793
- Searle (Dr. G. F. C.), An Experiment on Focal Lines formed by a Zone Plate, 126
- Sears, Jr. (J. E.), appointed Deputy Warden of the Standards in succession to Major P. A. MacMahon, 307
- See (Prof. T. J. J.), Dr. Hill's Cusped Orbit, 503; The Figure of the Earth, 601
- Segaller (Dr. D.), retirement from the British Dyestuffs Corporation, Ltd., 722
- Seligman (Prof. C. G.), A "New" Type of Tool of Moustertian Age, 330; Ancient Egyptian Survivals in Modern Egypt, 27
- Semon (Sir Felix), [obituary], 50; bequest to the Royal Society of Medicine, 530
- Sergi (S.), Vertebro-medullary Topography of Chimpanzee, 128
- Severi (F.), Theory of Simple Integrals of First Species belonging to an Algebraic Surface, iii., 671
- Seward (Prof. A. C.), Prof. A. G. Nathorst, 112; Plant

- Evolution, 197; The Cretaceous-Tertiary Boundary in North America, 282
- Shackleton (Sir Ernest), Impending New Expedition to the Antarctic, 602
- Shackleton (W.), [obituary], 561
- Shadwell (Dr. A.), The War of the Mines, 763
- Shakespear (Dr. G. A.), A New Acoustical Phenomenon, 623
- Shapley (Dr. H.), Magnitudes in Star Clusters, xi., 94; and Prof. H. D. Curtis, The Distances of the Globular Clusters, 825
- Sharpe (Sir Alfred), The Backbone of Africa: A Record of Travel during the Great War, with some Suggestions for Administrative Reform, 518
- Sharpe (Prof. W.), Diagnosis and Treatment of Brain Injuries: with and without a Fracture of the Skull, 484
- Shattock (Prof. S. G.), appointed Erasmus Wilson Lecturer at the Royal College of Surgeons of England, 507
- Shaw (H. K.), The Variable Nebula in Corona Australis, 634
- Shaw (Sir Napier), "Absolute" Temperatures in Meteorological Publications, 201; Meteorological Physics, 66; presented with a Portrait of Himself, 562; The Air and its Ways (Rede Lecture), 507, 653; The Possibility of Dissipating Fog by Artificial Heating, 118
- Shaw (R. C.), appointed a Demonstrator in Anatomy in Manchester University, 507
- Shears (Prof. G. P.), Obstetrics: Normal and Operative. Third edition, revised by Dr. P. F. Williams, 484
- Sheen (A. W.), appointed Professor of Surgery in the Welsh National School of Medicine, 604
- Sheppard (Dr. S. E.), The Nature of the Emulsoid Colloid State, 73
- Sheppard (T.), Artefacts and their Geological Age, 587; elected President of the Museums Association, 722; Origin of Materials Used in the Manufacture of Pre-historic Stone Weapons in East Yorkshire, 244
- Sherlock (Dr. R. L.), Rock-salt and Brine, 693
- Sherrington (Prof. C. S.), Break-shock Reflexes and "Supra-maximal" Contraction-response of Mammalian Nerve-muscle to Single-shock Stimuli, 509; Degree of D.Sc. conferred upon, by Oxford University, 572
- Shimizu (T.), New Apparatus for Showing the Tracks of α -, β -, and X-rays, 697
- Shipley (Sir A. E.), and Prof. E. W. MacBride, Zoology: An Elementary Text-book. Fourth edition, 295
- Silberstein (Dr. L.), Elements of Vector Algebra, 616
- Simmons (A. T.), [obituary article], 820
- Simpson (Dr. G. C.), The Origin of the South-west Monsoon, 154
- Singer (Dr. C.), Astrology, 771
- Singh (Prof. B. K.), Phototropism in Solution. Part i., 373; Recent Advances in Stereochemistry, 474
- Siret (L.), "La Dame de l'érable," 215
- Sitter (Prof. W. de), Jupiter's Four Great Satellites, 663
- Skaife (S. H.), Animal Life in South Africa, 136
- Skiff (Dr. F. J. V.), [death], 148
- Skjellerup (J. F.), Detection of Encke's Comet, 825
- Slipher (E. C.), Planetary Photography, 725; and G. H. Hamilton, The 1920 Opposition of Mars, 24
- Slipher (Prof. V. M.), Two Nebulæ with Unparalleled Velocities, 55
- Sloane (T. G.), Revisional Notes on Australian Carabidæ. Part vi., 640
- Slosson (Dr. E. E.), Creative Chemistry: Descriptive of Recent Achievements in the Chemical Industries, 618
- Small (Prof. J.), A Text-book of Botany for Medical and Pharmaceutical Students, 777
- Smart (W. M.), appointed to the John Couch Adams Astronomership, Cambridge University, 60
- Smith (A. J.), awarded a Frank Smart prize at Cambridge University, 540
- Smith (B. S.), and G. F. Partridge, A Method of Measuring Frequencies, 350
- Smith (Eng.-Comdr. E. C.), The Centenary of Napoleon, 302
- Smith (E. F.), An Introduction to Bacterial Diseases of Plants, 168
- Smith (Sir Francis P.), a Memorial Tablet to, placed on Birthplace of, 597
- Smith (Prof. G. Elliot), Prof. H. W. G. von Waldeyer, 368
- Smith (Dr. G. F. H.), appointed Assistant Secretary to the Natural History Museum, South Kensington, 51
- Smith (G. M.), Phytoplankton of the Inland Lakes of Wisconsin. Part i., 168
- Smith (J. Henderson), and Major A. G. Church, Science and Civilisation, 684
- Smith (Reginald A.), appointed Deputy-keeper of the Department of British and Medieval Antiquities of the British Museum, 51, 722
- Smith (T.), Tracing Rays through an Optical System, 126
- Smith (W. C.), elected a Fellow of Corpus Christi College, Cambridge, 572
- Smithells (Prof. A.), The Universities and Technological Education, 656, 695
- Smithells (C. J.), High-temperature Phenomena of Tungsten Filaments. 2 parts, 702
- Snyder (T. E.), Injury caused to the Lead Sheathing of Aerial Telephone Cables by *Scobicia declivis*, 343
- Soddy (Prof. F.), The Atomic Volume of Isotopes, 41
- Sollas (Prof. W. J.), *Saccamina Carteri*, Brady, and the Minute Structure of the Foraminiferal Test, 92
- Solomon (M.), A Radiological Ionometric Arrangement, 702
- Solvay (Dr. E.), elected an Honorary Foreign Member of the Chemists' Club, New York, 114
- Somigliana (C.), Depth of Glaciers, i., 703
- Spence (H. S.), Phosphate in Canada, 794
- Spencer (A. C.), The Geology and Ore Deposits of Ely, Nevada, 117
- Spencer (Sir Baldwin), The Cultural Anthropology of Australian Aborigines, 410
- Speyer (E. R.), Ceylon Ambrosia Beetles and their Relation to Problems of Plant Physiology, 93; Insects in Relation to the Reproduction of Coniferous Trees, 413
- Sprague (F. J.), presented with the Franklin Medal and Honorary Membership of the Franklin Institute, 369
- Standen (R.), The Feeding Habits of Squirrels, 822
- Standley (P. C.), The Trees and Shrubs of Mexico, 603
- Stanners (R. W.), appointed University Lecturer in Historical and Economic Geography, Cambridge University, 830
- Starch (Dr. D.), Educational Psychology, 164
- Starling (S. G.), An Introduction to Technical Electricity, 296
- Stead (G.), Effect of Electron Emission on the Temperature of the Filament and Anode of a Thermionic Valve, 210
- Stevenson (Dr.), Dubiago's Comet, 405
- Stebbing (E. P.), The Diary of a Sportsman-Naturalist in India, 615
- Stebbins (Prof. J.), A Photo-electric Study of Algal, 311
- Steckbeck (Dr. D. W.), The Comparative Histology and Irritability of Sensitive Plants, 764
- Steel (Prof. M.), A Laboratory Manual of Organic Chemistry for Medical Students. Second edition, 549
- Steel (T.), Dental Encrustations and the so-called "Gold-plating" of Sheep's Teeth, 249; Ulmite, a Constituent of Black Sandstone, 640
- Steele (Lieut. G. C.), The Influence of Meteorology on Naval Warfare, 286
- Stefanini (G.), Geology of Cyrenaica: i., Eocene Strata, 478
- Stefansson (V.), awarded the Founder's Medal of the Royal Geographical Society, 178
- Steinmann (Herausgegeben von Prof. G.), und Prof. O. Wilckens, Handbuch der Regionalen Geologie. 20 heft, iii. band, i. abteilung. The British Isles: The Channel Islands, by Thirteen Contributors. Local editor, J. W. Evans, 355
- Stelfox (S. H.), The Laws of Mechanics: A Supplementary Text-book, 134
- Stephenson (M.), The Silchester Discoveries, 538
- Stevens (A.), appointed Lecturer in Geography in Glasgow University, 669
- Stewart (Prof. A. W.), Recent Advances in Physical and Inorganic Chemistry. Fourth edition, 262
- Stewart (Prof. J. D.), Animal Tuberculosis, 410
- Stocks (Dr. P.), appointed Medical Officer in connection with the Department of Applied Statistics and Eugenics at University College, London, 379
- Stone (Dr. W. E.), [obituary], 721
- Stopes (Dr. Marie), elected President of the Society for Con-

- structive Birth Control and Racial Progress, 821; The Control of Parenthood, 88
- Størmer (Dr. C.), Auroræ at a Height of 500 km., 663; The Aurora Borealis of May 13, 1920, 671
- Stout (Mary), and Madeleine Agar, A Book of Gardening for the Sub-tropics, 232
- Strahan (Sir Aubrey), Dr. W. Gibson, T. C. Cantrill, Dr. R. L. Sherlock, and H. Dewey, Iron Ores. Pre-Carboniferous and Carboniferous Bedded Ores of England and Wales, 261
- Stratton (F. J. M.), The Spectrum of Nova Geminorum II., 248
- Street (R. O.), The Dissipation of Energy in Permanent Ocean Currents, etc., 158
- Stridsberg (G.), Coloured Thinking and Thought-forms, 55
- Stromeyer (C. E.), Solar Eclipse Results and the Principle of Relativity, 682
- Strong (Prof. J.), The Aims and Lines of Work of the Association of University Teachers, 701
- Stroobant (P.), The Flattening of the Spheroid of Saturn, 319
- Strutt (Prof. J. W.), [Lord Rayleigh], Scientific Papers. Vol. vi., 1911-19, 546
- Stuart (A.), appointed Assistant Lecturer in Geology at the University College of Swansea, 637
- Stubbs (A. J.), Picture-hanging Wire, 395
- Sturtevant (Dr. A. H.), The North American Species of *Drosophila*, 743
- Sudborough (J. J.), and Miss M. M. Mehta, The Perishing of Paper in Indian Libraries, 437
- Sudeley (Lord), resolution in the House of Lords on the Employment of Guide Lecturers and the Sale of Pictorial Illustrations in Museums, etc., 52
- Svedberg (Prof. The), The Formation of Colloids, 744
- Swinton (A. A. Campbell), Amplifying the Optophone, 8; The Peltier Effect and Low-temperature Research, 43
- Sykes (Brig-Gen. Sir Percy), A History of Persia (in two volumes). Second edition, 804
- Syngé (E. H.), Uniform Motion in the Æther, 746
- Talbot (W. H. Fox), Proposed Memorial to, 691
- Tanret (G.), An Ammonium Molybdo-quinat, 702; The Influence of Ammonium Molybdate on the Rotatory Power of Mannite, 607; The Influence of Ammonium Molybdate on the Rotatory Power of Some Sugars, 542
- Taylor (Dr. G.), The Evolution and Distribution of Race, Culture, and Language, 435; Water-divining in Australia, 822
- Taylor (H. F.), The Principles involved in the Preservation of Fish by Salt, 692
- Taylor (W.), [obituary], 721
- Tealé (E. O.), Palæozoic Geology of Victoria, 828
- Telford (J. C.), Fabricated Ships, 596
- Tennant (A. C.), Ocean Tides, 299
- Terenin (A.), The Normal Orbit of the Electron in the Atom of Mercury, 203
- Thayer (A. H.), [obituary article], 596
- Thayer (G. H.), with an Introductory Essay by A. H. Thayer, Concealing-coloration in the Animal Kingdom. New edition, 338
- Thomas (H. H.), An Ottokaria-like Plant from South Africa, 445; re-elected Fellow of Downing College, Cambridge, 830
- Thomas (Dr. H. H.), The Source of the Stones of Stonehenge, 23
- Thompson (Dr. F. C.), appointed Professor of Metallurgy in Manchester University, 91
- Thompson (Dr. J. M'L.), Studies in Floral Morphology. No. ii., 93
- Thompson (Dr. McLean), appointed Professor of Botany in Liverpool University, 572
- Thomson (Prof. E.), A Novel Magneto-optical Effect, 520, 619
- Thomson (G. P.), Anode Rays of Beryllium, 395
- Thomson (Dr. H. H.), Tuberculosis and Public Health, 328
- Thomson (J. Allan), The Geology of Western Samoa, 828
- Thomson (Prof. J. A.), A Correction, 811; and others, edited by Dr. J. Marchant, The Control of Parenthood, 5
- Thomson (Sir J. J.), elected Honorary Professor of Natural Philosophy at the Royal Institution, 342; Elements of the Mathematical Theory of Electricity and Magnetism: Fifth edition, 647; The Institute of Physics, 312; The Structure of the Molecule and Chemical Combination, 118
- Thooris (A.), Biological Study of Divers, 607
- Thorpe (Prof. J. F.), awarded the Longstaff Medal of the Chemical Society, 21
- Thorpe (Sir T. E.), Early Chemistry in Oxford, 13; elected an Honorary Foreign Member of the Chemists' Club, New York, 114; French Chemists and the War, 516; Prof. L. C. Miall, 17; Piezo-chemistry, 450
- Thouless (R. H.), appointed Lecturer in Psychology in Manchester University, 669; elected a Fellow of Corpus Christi College, Cambridge, 572
- Thoulet (J.), The Oceanic Circulation and the Density of Sea-water, 287
- Tieri (L.), Magnetic Double Refraction in Smokes, 778
- Tilden (Sir William A.), Famous Chemists: The Men and their Work, 802
- Tilley (C. E.), The Granite-gneisses of Southern Eyre Peninsula (South Australia), and their Associated Amphibolites, 29
- Tillyard (Dr. H. J. W.), appointed Professor of Russian in Birmingham University, 474
- Tillyard (Dr. R. J.), Papers on Metamorphic Insects, 249; Revision of the Family Enotheniidae (order Perlaria), with Descriptions of New Genera and Species, 800; The Neuropteroid Insects of the Hot Springs of New Zealand, 791
- Tompkins (Eng.-Capt. A. E.), Marine Engineering (A Text-book). Fifth edition, 296
- Tomkinson (Miss M. G.), awarded a Girton Travelling Fellowship, 603
- Tooth (S.), presentation of a New Plesiosaurian from the Wealden of Berwick to the British Museum (Natural History), 469
- Toporescu (E.), The Removal of Lime and Magnesia from Solution by Precipitates of Chromium Hydroxide, 159
- Torday (E.), The Batetela, 179
- Toy (F. C.), The Photographic Efficiency of Heterogeneous Light, 542
- Travers (Dr. M. W.), elected President of the Society of Glass Technology, 405; Importance of Quantitative Investigation in dealing with Technical Glass Problems, 405
- Trechmann (Dr. C. T.), and L. F. Spath, The Jurassic of New Zealand, 638
- Trelease (Dr. S. F.), appointed Secretary of the American Association, 56
- Treuthardt (A.), Some New Measurements of the Density of the Air at Geneva, 639
- Tridon (A.), Psychoanalysis: Its History, Theory, and Practice 515
- Trillat (A.), and R. Kaneko, Activity of Infection by the Air, 734
- Troughton (E. le G.), appointed Assistant in Charge of Mammals and Skeletons in the Australian Museum, Sydney, 434
- Turner (Dr. A. J.), Revision of Australian Lepidoptera-Hypsidae Anthelidae, 640
- Turner (Dr. D.), and D. M. R. Crombie, Behaviour of an Electrified Pith Ball in an Ionised Atmosphere, 381
- Turner (Dr. E. E.), and F. H. H. Wilson, The Decomposition of Dimethyl Oxalate by Acetic Acid, 832
- Turner (Miss E. L.), Some Birds from Texel, 189
- Turner (Prof. T.), The Casting of Metals, 344
- Twyman (F.), An Interferometer for Testing Camera Lenses, 470, 635
- Unwin (Prof. G.), Samuel Oldknow, the First Manufacturer of British Muslins, 477
- Unwin (Dr. W. C.), presented with the Kelvin Gold Medal for Engineering, 341
- Vallot (J.), Diffuse Radiation at Mont Blanc Observatory, compared with that at lower Altitudes, 542; Diffuse Radiation of the Sky Compared with the Direct Solar Radiation, 446

- Van Buren (A. W.), and R. M. Kennedy, Varro's Aviary at Casinum, 500
- Van Rhijn (Dr. P. J.), The Total Amount of Starlight, 566
- Varley (S. A.), [obituary article], 789
- Vaurabourg (C.), The Density and Refractive Indices of Sea-water, 287
- Vavon (G.), The Velocity of the Reaction in the Hydrogenation by Platinum Black, 831
- Veil (Mlle. S.), Allotropic Varieties of Oxides, 575
- Venn (J. A.), nominated Gilbey Lecturer in the History and Economics of Agriculture, 474
- Vernon (Dr. H. M.), and E. A. Rusher, Fatigue and Efficiency in the Iron and Steel Industry, 156
- Vernon (Dr. R. H.), [obituary], 242
- Véronnet (A.), Speculations on the Formation of Spiral Nebulæ, 438; The Constitution and Formation of the Spiral Nebulæ, 350
- Vèzes (M.), The Composition of French Turpentine, 351
- Villedieu (M. and Mme. G.), The Non-toxicity of Copper for Mildew, 31
- Vincent (H. C. G.), awarded the Wiltshire Prize in Geology in Cambridge University, 572
- Vinter-Hansen (Miss), Reid's Comet, 217
- Virville (A. Davy de), and R. Douin, The Modifications of Form and Structure of Liverworts submerged in Water, 510
- Vitale (A.), Il Regime delle Acque nel Diritto Pubblico e Privato Italiano, 358
- Vlès (F.), and J. Dragoiu, The Osmotic Pressure of Arrest of Cell Division, 414
- Vlies (L. E.), elected Chairman of the Chemical Section of the Manchester Literary and Philosophical Society, 342
- Vournazos (A. C.), A New Magnesian Hydraulic Cement, 639
- Voûte (J.), A Catalogue of Radial Velocities, 281
- Waddell (Dr. L. A.), Buddha's Diadem, 150
- Wagner (P. A.), Nature and Origin of the Crocodile River Iron Deposits, 795
- Waltz (P.), Eruption of Popocatepetl, 599
- Walcott (Dr. C. D.), The Structure of the Trilobite, 436
- Waldeyer (Prof. H. W. G. von), [obituary article], 368
- Walker (Dr. G. T.), The Probable Amount of Monsoon Rainfall in 1921, 724
- Walker (G. W.), A Difficulty in Einstein's Gravitational Theory, 169; The Problem of Finite Focal Depth revealed by Seismometers, 412
- Walker (Sir James), elected President of the Chemical Society, 115
- Walker (Comdr. J. J.), Some Aspects of Insect Life in New Zealand, 54
- Walkom (Dr. A. B.), Nummulospermum, gen. nov., the Probable Megaspore of Glossopteris, 445; Occurrence of Otozamites in Australia, 575
- Wallace (J. C.), elected a Junior Fellow of Emmanuel College, Cambridge, 474
- Wallace (R. Hedger), Cornalith, 811; History of the Churn, 587; The Origin of "Churning at 62°" on Dairy Thermometers, 268
- Waller (Dr. A. D.), The Galvanometric Measurement of Human Emotion, 183
- Wallis (Dr. R. L. M.), awarded the Raymond Horton-Smith Prize in Medicine, Cambridge University, 830
- Walsh (Lt.-Col. J. H. Tull), Nature in a Himalayan Valley, 210
- Waran (H. P.), The Effect of a Magnetic Field on the Intensity of Spectrum Lines, ii., 510
- Ward (Capt. F. Kingdon), In Farthest Burma, 231
- Ward (Prof. R. de C.), Cloudiness in the United States, 693; Essential Characteristics of U.S. Climates, 180
- Ward (S.), The Ways of Life: A Study in Ethics, 35
- Warren (Prof. H. C.), Human Psychology, 164
- Warren (S. H.), A Natural "Eolith" Factory beneath the Thanet Land, 565; The Stone-axe Factory of Graiglwyd, Penmaenmawr, 346
- Washington (Dr. H. S.), Chemical Analyses of Igneous Rocks, 151; The Chemistry of the Earth's Crust, 693; The Rhyolites of Lipari, 795
- Watson (D. M. S.), appointed Professor of Zoology and Comparative Anatomy at University College, London, 443
- Watson (Dr. W.), A Text-book of Physics. Seventh edition. Revised by H. Moss, 358
- Watts (F.), Abnormal Psychology and its Educational Applications (Second edition of "Echo Personalities"), 264
- Watts (H. C.), High-speed Aircraft Propellers and the Destruction of Gnats, 269
- Watts (Prof. W. W.), The Universities and Technological Education, 656, 726
- Wayland (E. J.), Geology of Uganda, 827
- Weatherburn (Dr. C. E.), Elementary Vector Analysis: With application to Geometry and Physics, 744
- Webb (Sir Arthur Lewis), [obituary], 114
- Webb (S. and Beatrice), A Constitution for the Socialist Commonwealth of Great Britain, 100
- Webber (Prof. W. P.), Elementary Applied Mathematics: A Practical Course for General Students, 134
- Webster (Prof. A. G.), Connection of the Specific Heats with the Equation of State of a Gas, 94; The Connection between the Equation of a Gas and the Specific Heats of the Gas at Constant Pressure, etc., 565
- Wedel (T. O.), The Mediæval Attitude toward Astrology, particularly in England, 771
- Weiss (H.), and P. Lafitte, The Interpenetration of Solids, 735
- Welch, The Genera of the Enchytræidæ, 179
- Wells (H. G.), The Salvaging of Civilisation, 707
- Wentworth-Sheilds (F. E.), Protecting Reinforced Concrete from Marine Deterioration, 596
- Wesendonk (C. de), Nature of Vowel Sounds, 12
- West (Prof. A. P.), Experimental Organic Chemistry, 807
- West (F. M.), A New Acoustical Phenomenon, 652
- West (Dr. G. D.), Experiments on Thermal Transpiration Currents, 445
- Westgren (Dr. A.), Röntgen Spectrographic Investigations of Iron and Steel, 437
- Wheeler (Prof. W. M.), Organisation in Research, 180
- Whipple (R. S.), The Design of Scientific Instruments, 54, 600
- Whitaker (W.), The Water-supply of Buckinghamshire and Hertfordshire, 565
- White (A. Silva), Unveiling the Senussi Shrines, 366
- White (C. J.), revised by P. P. Blackburn, The Elements of Theoretical and Descriptive Astronomy. Eighth edition, 581
- White (H. J. O.), Short Account of the Geology of the Isle of Wight, 827
- White (P. Bruce), Researches on Bee Disease, 373
- White (W. A.), Fuel Oil, 119
- Whitehead (Prof. J.-B.), the "Corona Voltmeter," 119
- Whitehead (Prof.), The Preparation of Schoolboys for Scientific Study at the University, 656
- Whitney (Mary Watson), [death], 20
- Whymper (R.), Cocoa and Chocolate: Their Chemistry and Manufacture. Second edition, 713
- Whytlaw-Gray (Dr. R.), Magnetic Double Refraction of Smokes, 810; and J. B. Speakman, A Novel Magneto-optical Effect, 619
- Widal (F.), P. Abrami, and E. Brissaud, Experimental Researches on Autocolloidoclasia by Cold, 767; P. Abrami, and J. Hutinel, Working of the Liver following Surgical Anæsthesia produced by Chloroform, Ether, Nitrous Oxide, or Novocaine, 446
- Willaman (Prof. J. J.), Vocational Chemistry: For Students of Agriculture and Home Economics, 777
- Williams (C. B.), The Froghopper-blight of Sugar-cane in Trinidad, 661
- Williams (S.), appointed Assistant Lecturer in Botany in Manchester University, 507
- Williamson (J. W.), British Scientific Instruments, 361: Publications of the U.S. National Research Council, 121
- Wills (H. H.), gifts to Bristol University, 604, 700
- Willsmore (Prof. N. T. M.), The Work of British Chemists during the War, 440
- Wilson (C. T. R.), Recent Work on Lightning and Thunderstorms, 638

- Wilson (Prof. E. B.), elected a Foreign Member of the Royal Society, 342
- Wilson (J.), The Breeding and Feeding of Farm Stock, 678
- Wilson (Dr. M.), A Fungoid Disease of the Douglas Fir, 437
- Wilson (Dr. T. S.), The late Prof. C. Lapworth's Views on Spiral Movements in Rocks during Elevation or Depression, 93
- Wilson (Dr. W.), appointed Professor of Physics at Bedford College for Women, 443
- Wilson, Some Effects of Environment on Efficiency and Safety, 567
- Wilson-Barker (Sir David), The "Flight" of Flying-fish, 233
- Wiltshire (G. P.), The Methods of Infection of the Apple Canker Fungus, 318
- Wingrave (Dr. W.), The Japanese Artificially Induced Pearl, 620
- Winkler (Dr. A.), Geology of the Central Isonzo Valley, 827
- Wood (Dr. A. B.), and Dr. F. B. Young, "Light-body" Hydrophones and the Directional Properties of Microphones, 541; The Acoustic Disturbances produced by Small Bodies in Plane Waves Transmitted through Water, 541
- Wood (Dr. C. A.), and Dr. F. H. Garrison, A Physician's Anthology of English and American Poetry, 102
- Wood (Prof. T. B.), The Chemistry of Crop Production, 101
- Wood-Jones (Prof. F.), The "Flight" of Flying-fish, 233
- Woodward (Dr. A. Smith), re-elected President of the Linnean Society, 499
- Woodward (B. B.), Molluscan Fauna of Scottish Lakes, and a Pisidium New to the British Isles, 715; Pelseener's Les Variations et leur Hérité chez les Mollusques, 7
- Woodward (Dr. H.), re-elected President of the Palæontographical Society, 563
- Woog (P.), The Oiliness of Fatty Bodies, 799
- Woolsey (T. S.), with two chapters by W. B. Greeley, Studies in French Forestry, 548
- Wootton (Mrs. B.), A Socialist Commonwealth, 100
- Wordie (J. M.), The Natural History of Pack-ice as observed in the Weddell Sea, 1914 to April, 1916, 62; The Shackleton Antarctic Expedition of 1914-17: Bathymetrical Observations in the Weddell Sea, 62; Geological Observations in the Weddell Sea Area, 606; The Soundings and Deep-sea Deposits of the Shackleton Expedition in the Weddell Sea, 692
- Workman (W. P.), and A. G. Cracknell, The School Geometry: Matriculation Edition, 616
- Worthington (W. B.), elected President of the Institution of Civil Engineers, 370
- Wright (Sir Almoth), awarded the Gold Medal of the Royal Society of Medicine, 657
- Wright (A. M.), Meat-canning and the Causes of Failure, 53
- Wright (Dr. G. F.), [obituary], 433
- Wright (Mrs. Mabel C.), A New Conchostracan Genus—*Limnetheria*—from the Coal Measures of Kilkenny, 309
- Wright (S.), The Relative Importance of Heredity and Environment in Determining the Piebald Pattern of Guinea-pigs, 94
- Wrightson (Sir Thomas), [obituary article], 530
- Wrinch (Dr. Dorothy), The Structure of Scientific Inquiry, 542
- Wyatt (T. C.), elected to a Fellowship at Christ's College, Cambridge, 316
- Wylie (R.), Bequests to Glasgow University, 91
- Yajnik (N. A.), and H. C. Mahajan, Hydrolysis of some Indian Oils by Vegetable Lipase, 671; and D. R. Sarma, Investigations on Indigo Textile Hydrosulphite Vat-dyeing, 671
- Yéramian (V.), The Synthesis and Dehydration of Ethylpropylphenylcarbinol, 831
- Young (A. E.), Some Investigations in the Theory of Map Projections, 744
- Young (R. K.), Fixed Calcium Lines in Early Type Stars, 247
- Young (Prof. S.), elected President of the Royal Irish Academy, 115
- Younghusband (Sir Francis), and Prof. J. N. Collie, The Ascent of Mount Everest, 12
- Youngken (Dr. H. W.), The Comparative Morphology, Taxonomy, and Distribution of the Myricaceæ of the Eastern United States, 765
- Z. (H.), and H. C. S., *Bibliotheca Chémico-mathematica*, 2 vols., 294
- Zeeman (Prof. P.), elected a Foreign Member of the Royal Society, 342
- Zenghelis (C. D.), A New Reaction of Ammonia, 735; The Detection of Nitrogen in Organic Compounds, 799
- Zsigmondy (Prof. R.), translated by Prof. E. B. Spear. Part i., *Kolloid-chemie*; part ii., *Industrial Colloidal Chemistry*, 226

TITLE INDEX.

- Aberdeen University, Conferment of Degrees, 669
- Abney, Sir William, as a Scientific Photographer, Chapman Jones, 662
- Absorption: Bands, The Shift of, with Change of Temperature, Dr. Hartridge, 446; Spectra, a Method of Projecting, Dr. Hartridge, 446
- Abu Durba, Western Sinai, Preliminary Report on, Dr. W. F. Hume, 827
- Academy, The Royal, 305
- Acari, Some New and Little-known, mostly Parasitic in Habit, S. Hirst, 253
- Acids from Cultures, The Extraction of, Dr. R. Greig-Smith, 575
- Acoustic Disturbances produced by small Bodies in Plane Waves transmitted through Water, Drs. A. B. Wood and F. B. Young, 541
- Acoustical: Phenomenon, A New, Dr. J. Erskine-Murray, 490; Dr. H. Hartridge, H. S. Rowell, and Prof. W. B. Morton, 586; Dr. G. A. Shakespear, 623; F. M. West, 652
- Acque, Il Regime delle, nel Diritto Pubblico e Privato Italiano, A. Vitale, 358
- Acquired Characters, The Inheritance of, Dr. R. Ruggles Gates, 89
- Acrylic Acid and Acrylic Esters, C. Moureu, M. Murat, and L. Tampier, 510
- Acyclic δ -Diketones, The Preparation of the, E. E. Blaise, 799
- Adalia bipunctata*, The Biology and Genetics of, Mrs. O. A. M. Hawkes, 724
- Adams Prize, 1921-22, Subject Proposed for the, 188
- Adult Education Committee, Constitution of an, by the President of the Board of Education, 251
- Aeronautical: Instruments, Prof. C. E. Mendenhall, 152; Treatises, 389
- Aeronautics: During the War, The Evolution of, Lt.-Col. Renard, 118; in Theory and Experiment, W. L. Cowley and Dr. H. Levy. Second edition, 389
- Aeroplane Photography, Practical, 39
- "Ether": "Space" or, Prof. A. S. Eddington, 201; "Space" or, Dr. Norman R. Campbell; L. C. W. Bonaccina, 234; Uniform Motion in the, E. H. Syngé, 746; Dr. H. Jeffreys, 747; Waves and Electrons, Sir William Bragg, 374

- Africa: The Backbone of, A Record of Travel during the Great War, with Some Suggestions for Administrative Reform, Sir Alfred Sharpe, 518
- Age-distribution of a Population, A Single Numerical Index of the, Prof. R. Pearl, 223
- Agricultural: Botany, The National Institute of. Report of the Potato Synonym Committee of, for 1920, 371; Co-operation, L. Scott, 436; Education, Prof. A. J. Perkins, 442; Practice and Economics in the United Provinces, India, The Bases of, Dr. H. M. Leake, 807; Research, 731
- Agriculture: and Fisheries in the Civil Service Estimates, 257; Indian, Dr. W. E. Brechley and others, 58; Research in, The Present Position of, Sir Daniel Hall, 731
- Air: Density of the, at Geneva, Some New Measurements of the, A. Treuthardt, 639; at Madrid and its Small Variations, E. Moles, T. Batuccas, and M. Payá, 640; Maps, International, The Proposed, Lt.-Col. E. F. W. Lees, 533; Routes in the East Indian Archipelago, Climatic Conditions on the Principal, Dr. C. Braak, 792; The, and its Ways, Sir Napier Shaw, 653; Upper, International Exploration of the, C. J. P. Cave, 761
- Aircraft Propellers, High-speed, and the Destruction of Gnats, H. C. Watts, 269
- Airplane Photography, Major H. E. Ives, 39
- Airscrews, A Treatise on, W. E. Park, 389
- Alaska: Magnetic Tables and Magnetic Charts for 1920, D. L. Hazard, 372; Mineral Springs of, A. H. Brooks, 246
- Alaskan Salmon, The, Prof. B. W. Evermann, 219
- Albert Medal of the Royal Society of Arts, The, presented to Prof. A. A. Michelson, 84
- Alcohol, Industrial, British Plants available as a Source of, Prof. M. C. Potter, 170
- Alcoholology, 163
- Alcohols: Secondary, The Preparation of the Amines of, A. Mailhe, 191; The Catalytic Dehydrogenation of, E. K. Rideal, 158
- Alcyonaria in the Cambridge Museum, Prof. S. J. Hickson, 189
- Algebra: for Engineering Students, An, G. S. Eastwood and J. R. Fielden, 616; Vector, Elements of, Dr. L. Silberstein, 616
- Algebraical: Identity, $4X=Y^2-3Z^2$, An, Prof. G. B. Mathews, 456; Identity, An, Dr. H. C. Pocklington; Rev. J. Cullen, 587; W. E. H. Berwick, 652
- Algol, A Photo-electric Study of, Prof. J. Stebbins, 311
- Alkali Metals, The Constitution of the, Dr. F. W. Aston, 72
- Alkaline: Earth Fluorides, The Spectra of the, and their Relation to each other, S. Datta, 444; Polysulphides, The Use of the, for the Neutralisation of Certain Toxic Gases, Desgrez, Guillemard, and Labat, 31
- Alloys: of Aluminium, Copper, and Zinc, containing High Percentages of Zinc, Constitution of the, Dr. J. L. Haughton and Kathleen E. Bingham, 29; of Iron with Nickel and Manganese, The Influence of Low Temperatures on the Magnetic Properties of, Prof. K. Onnes, Sir R. Hadfield, and Dr. H. R. Woltier, 285
- Allyl Alcohol: The Action of Heat on, in Presence of Various Catalysts, P. Sabatier and B. Kubota, 702; The Catalytic Decomposition of, P. Sabatier and B. Kubota, 767
- Alpine Garden, A Miniature, from January to December, R. A. Malby, 253
- Alsea Indian Tribe of Oregon, Myths of the, L. I. Frachtenberg, 215
- Amenemhet, The Tomb of, Nina de Garis Davies, and Dr. A. H. Gardiner, 70
- American: and British: Engineers, Conference of, 504; Superannuation Systems, 245; W. Palin Elderton, 621; Dr. J. W. Evans; W. Palin Elderton, 683; Association, Chicago Meeting of the, Appointments and Resolutions, 56-58; Resolutions of the Executive Committee of the Council, 531; Biological Research, Personal Impressions of, W. B. Brierley, 117; Cynipidæ or Gall-wasps, A. C. Kinsev, 85; *Museum Novitates*, No. 1, 500; of Natural History, Journal of the, Vol. xx., No. 5, 180; The Hall of the Age of Man in the, Prof. H. F. Osborn, 236; State Geological and Natural History Surveys, History of, G. P. Merrill, 533; Text-books of Botany, New, 69
- Amines, Phenolic, The Preparation of Mixed Secondary and Tertiary, A. Mailhe and E. de Godon, 575
- Ammonia: A New Reaction, C. D. Zenghelis, 735; and the Nitrides: With special reference to their Synthesis, Dr. E. B. Maxted, 549; Synthesis, The Claude Process for, G. Claude, 765; under Very High Pressure, G. Claude, 93
- Ammoniacal Silver Carbonate, Dervin and Olmer, 670
- Ammonium: and Sodium, The Molybdomalates of, E. Darmois, 607; Molybdate, The Influence of, on the Rotatory Power of Some Sugars, G. Tanret, 542; Molybdo-quinine, An, G. Tanret, 702
- Amycterides (Coleoptera), Revision of the, Part vi., Acantholophus, E. W. Ferguson, 479
- Amylopectin, The Fundamental Organic Substance of, S. and A. Mayer, 383
- Anaphylaxy: in Micro-organisms, The Phenomena of, C. Richet, E. Bachrach, and H. Cardot, 126; in Plants, A. Lumière and H. Couturier, 511
- Anemometers, The Comparability of, C. E. Brazier, 286
- Andes, The Structure of the, J. A. Douglas, 436
- Anode Rays of Beryllium, G. P. Thomson, 395
- Anglo-Swedish Society, award of Scholarships by the, to Miss Dorothy Cridland and G. R. Carline, 411
- Angular Measurement, The Centesimal System of, adopted in Sweden, 21
- Animal: Ecology in Deserts, P. A. Buxton, 190; Life in South Africa, S. H. Skaife, 136
- Animals, The Defence of, grouped together against Poisons, Mme. Anna Drzewina and G. Bohn, 222
- Anniversaries and other Poems, Dr. L. Huxley, 136
- Annular Eclipse of April 8, The, Dr. A. C. D. Crommelin, 211; Sir Francis Darwin; Miss Eleonora Armitage; E. L. Gill, 212
- Anopheles: Life of, ii., B. Grassi, 127; *maculipennis*, The rôle of the Domestic Rabbit in the Attraction and Nutrition of, J. Legendre and A. Oliveau, 254; propagate Malaria Directly?, Can. B. Grassi, 254; The Natural History of, and their Extermination, iii., E. Bora, 351
- Antarctic Expedition, Sir Ernest Shackleton's New, 602
- Antefoker, The Tomb of, Vizier of Sesostris I., and of his Wife, Senet, Nina de Garis Davies, and Dr. A. H. Gardiner, 70
- Anthocyanin Pigmentation, The Variation of Organic Acids in the Course of, Mlle. D. Kohler, 191
- Anthocyanins and Anthocyanidins, Part iv., Dr. A. E. Everest and A. J. Hall, 61
- Anthropology and the Government of Subject Races, Justice Murray, 441
- Anticlines in the Bighorn Basin, Wyoming, D. F. Hewett and C. T. Lupton, 216
- Anticryptogamic Product, An, R. Lance, 447
- Antitoxins, Standardisation of Vaccines, Toxins, and, 161
- Antilogs, Logs, and, R.T.A.L., 300
- Antinometric and Polarimetric Measurements at High Altitudes, A. Boutaric, 607
- Apple Canker Fungus, The Methods of Infection of the, G. P. Wiltshire, 318
- Archæological Discoveries at Martres-de-Veyre, 597
- Arctic and Antarctic Exploration, A History of, The Lands of Silence, Sir Clements R. Markham, 291
- Arcturus, The Diameter of, Measurement of, F. G. Pease, 725
- Aretinal Termination of the Optic Nerve in the Animal Series, Anatomical Study on the, N. A. Barbieri, 543
- Argon, Ionisation of, by Slow Electrons, G. Déjardin, 542
- Arguing in a Circle, Dr. F. C. S. Schiller, 670
- Aristarchus of Samos, The Copernicus of Antiquity, Sir Thomas Heath, 713
- Aristotelian Society, Proceedings of the, New Series, Vol. xx., 618
- Arizona, Copper Deposits of, F. L. Ransome, 50
- Art, Prehistoric, in Caves and Rock-shelters, M. C. Burkitt, 460
- Artefacts and their Geological Age, T. Sheppard, 587
- Artillery College, Woolwich, K. C. Browning appointed

Professor of Chemistry and Metallurgy at the, 540; Prof. H. C. Plummer appointed Professor of Mathematics at the, 604
Asellus aquaticus, Prof. C. Chilton, 180
Aspergillus fumigatus, the Agglutinating Power of Thorium Sulphate on the Spores of, A. Sartory and P. Bailly, 478
 Astrology: Dr. C. Singer, 771; The Mediæval Attitude toward, particularly in England, T. O. Wedal, 771

ASTRONOMICAL NOTES.

Comets :

Pons-Winnecke's Comet, 55; New Comet, 1921a, 119; Pons-Winnecke's Comet, 153; Comet Reid 1921a, 153; Discovery of Pons-Winnecke's Comet, Prof. Barnard, 217; Reid's Comet, Miss Vinter Hansen, 217; Pons-Winnecke's Comet, 247; Reid's Comet, M. Ebell; W. P. Denning, 247; Reid's Comet, 311; Neujmin Comet, 345; Pons-Winnecke's Comet, 345; A New Comet, 1921c, 373; Reid's Comet, 373; Pons-Winnecke's Comet, 373; Dubiago's Comet, Dr. Steavenson, 405; Pons-Winnecke's Comet, Prof. Crawford and Miss Levy, 405; Pons-Winnecke's Comet, W. F. Denning, 438; Comets, 471; Pons-Winnecke's Comet, G. Merton; W. F. Denning, 601; Search for Meteors from the Pons-Winnecke Radiant, Prof. Barnard, R. G. Chandra, 694; Detection of Encke's Comet, J. F. Skjellerup, 825

Meteors :

Large Meteors on March 1 and 2, W. F. Denning, 55; The Fireball of March 2, W. F. Denning, 88; Large Detonating Fireball, W. F. Denning, 153; Recent Brilliant Fireballs, W. F. Denning, 182; The Meteoric Radiants of June 25-30, W. F. Denning, 535; Recent Meteors, W. F. Denning, 634; The August Meteors, W. F. Denning, 694; The August Meteoric Display, W. F. Denning, 793; The Recent Meteoric Display, W. F. Denning, 825

Observatories :

Brazilian National Observatory Annual, 1921, 119; Stonyhurst College Observatory Report, 503; Report of the Kodaikanal Observatory for 1920, 535; The Cape Observatory, Sir Joseph Larmor, 601

Planets :

The 1920 Opposition of Mars, E. C. Slipper and G. H. Hamilton, 24; The Rotation of Venus, Prof. W. H. Pickering, 88; Re-appearance of Saturn's Ring, A. Danjon and G. Rougier, 119; Theory of Jupiter's Satellites, Prof. Sampson, 405; Occultation of Venus, 566; The Figure of the Earth, Prof. T. J. J. See, 601; The Minor Planet Eros, F. E. Seagrave, 663; Jupiter's Four Great Satellites, Prof. W. de Sitter; Dr. A. J. Leckie, 663; Displacement of Lines in the Spectrum of Venus, Dr. C. E. St. John and S. B. Nicholson, 725; Planetary Photography, E. C. Slipper, 725; Continuation of the Ephemeris of Eros, F. E. Seagrave, 793; Study of the Moon's Surface, W. Goodacre, 825

Stars :

Ancient Star Maps, Dr. M. Schönfeld, 24; Two Nebulae with Unparalleled Velocities, Prof. V. M. Slipper, 55; Nova Aquilæ III., C. F. Butterworth, 182; Double Stars, J. Jackson, 217; Fixed Calcium Lines in Early Type Stars, R. K. Young, 247; 1646 Spectroscopic Parallaxes, W. S. Adams, A. H. Joy, G. Strömberg and C. G. Burwell, 281; A Catalogue of Radial Velocities, J. Voûte, 281; Photographic Catalogue of the Globular Cluster Messier 15, Rev. H. E. Macklin, 311; A Photo-electric Study of Algol, Prof. J. Stebbins, 311; The Eclipsing Variable U Cephei, R. S. Dugan, 373; Speculations on the Formation of Spiral Nebulae, A. Veronnet, 438; The Companion of α Herculis, R. F. Sanford, 438; Nova Cygni III.

(1920), W. F. Denning, 471; Collision of Star and Nebula, Prof. E. W. Brown, 471; The Total Amount of Starlight, Dr. P. J. van Rhijn, 566; Periodicity of Variable Stars, Dr. J. G. Hagen, 566; The Variable Nebulae in Corona Australis, H. K. Shaw, 634; Statistics of Proper Motions, Prof. J. C. Kapteyn and Dr. P. J. van Rhijn, 694; Measurement of the Diameter of Arcturus, F. G. Pease, 725; Variable Stars, Miss Cannon; S. Williams; C. Hoffmeister, 759; Mr. Flint's Parallax Observations, 759; The Distances of the Globular Clusters, Dr. H. Shapley and Prof. H. D. Curtis, 825

Sun :

The Accelerations of the Sun and Moon, Dr. H. Jeffreys, 281

Miscellaneous :

The Date of Easter, 24; A Simplified Calendar Reform, Rev. E. Fanfani, 88; Another Investigation of the Einstein Spectral Shift, A. Perot, 182; Eclipse of Rhea by Titan, 345; Dr. Hill's Cusped Orbit, 503; "L'Astronomie et les Astronomes," A. Collard, 503; Popular Astronomy in Sweden, 535; Another Plan of Calendar Reform, Prof. R. Baire, 634; Auroræ at a Height of 500 km., Dr. C. Størmer, 663; Bright Object near the Sun, Prof. Campbell, 759, 793

Astronomical Society of the Pacific, Award of the Bruce Gold Medal of the, to Dr. H. A. Deslandres, 115

Astronomy: Prehistoric, in Scandinavia, Dr. M. Schönfeld, 24; Popular, in Sweden, 535; The Application of Interference Methods to, H. Spencer Jones, 685; Theoretical and Descriptive, The Elements of, C. J. White. Eighth edition. Revised by P. P. Blackburn, 582

Athenæum Club: Dr. H. K. Anderson, Prof. W. M. Bayliss, and Sir William Bragg, elected Members of the, 84; Prof. J. Norman Collie and Sir W. Morley Fletcher, elected Members of the, 213

Atmospheric Refraction, A. Mallock, 456; Dr. J. de Graaff Hunter, A. Mallock, 745

Atom: The "Cubical" Model of the, Dr. I. Langmuir, 310; The Size of the, Ionisation Potential and, Prof. A. S. Eve, 552

Atomic: Heat of the Elements, The, E. van Aubel, 703; Radius, The, and the Ionisation Potential, Prof. Megh Nad Saha, 682; Structure, Prof. N. Bohr, 104; Dr. Norman R. Campbell, 170; Magnetism and, Dr. A. E. Oxley, 652; Symbols, Dalton and, Prof. M. Delacré, 440; Weights, Isotopes and, Dr. F. W. Aston, 334

Atoms and Isotopes, Dr. F. W. Aston, 633; and Molecules, The Dimensions of, Prof. W. L. Bragg and H. Bell, 107; The Dimensions of, Prof. W. L. Bragg, 758; The Heavy, The Electronic Structure of, L. de Broglie and A. Dauvillier, 670; The Stability of, Sir Ernest Rutherford, 574

Audition, Wrightson's Hypothesis of, Dr. H. Hartridge, 811

Augite from Nishigatake, Japan, Prof. R. Ohashi, 189
 Aurora Borealis: of May 13, 1920, The, Dr. C. Størmer, 671; Lord Rayleigh, 392; The, and The Simultaneous Magnetic Phenomena, B. Lyot, 478; In the South of England, The Common Occurrence of, Lord Rayleigh, 137; Recent Work on, Dr. C. Chree, 565

Auroræ at a Height of 500 km. Dr. C. Størmer, 663
 Auroral Display, A. E. L. Hudson, 359

Australasian Association, The Melbourne Meeting of the, 408; 440; Resignation of J. H. Maiden of the Permanent Honorary Secretaryship of the; E. C. Andrews elected Permanent Honorary Secretary; G. H. Knibbs elected President of the; Award of Medals to R. T. Baker and Prof. C. Chilton, 408

Australia, The Organisation of Science in, Prof. T. H. Laby, 124; 442

Australian: Aboriginals, The Cultural Anthropology of, Sir Baldwin Spencer, 410; Carabidæ, Revisional Notes on, part vi., T. G. Sloane, 640; Diptera Brachycera, Studies in Life-histories of. Part i., Stratiomyiidae.

- No. 2, Vera Irwin-Smith, 799; Fresh-water Flagellates, G. I. Playfair, 575; Game Laws, C. M. Hoy and others, 435; Grasses, Certain, The Nutritive Value of, Margaret H. O'Dwyer, 800; Lepidoptera, Revision of, Hysidæ, Anthelidæ, Dr. A. J. Turner, 640; Museum, Sydney, New Appointments at the, 434; *Museum Magazine*, No. 1, 758
- Austrian Universities, Fees in the Medical Faculties for Foreigners, 251
- Auto-colloidoclasia by Cold, Experimental Research, F. Widal, P. Abrami, and E. Brissaud, 767
- Automatic and Semi-automatic Machine, The Influence of the, on the Skill and Resourcefulness of the Mechanic and Operator, A. H. Hall, 596
- ββ*-Dichloroethyl Sulphide, Researches on, Delépine, Fleury, and Ville, 478
- B. coli communis*, The Enzymes of, E. C. Grey and E. G. Young, part ii., 61
- Baconi, Rogeri, Opera hactenus inedita, fasc. v., Secretum Secretorum cum glossis et notulis; Tractatus brevis et utilis ad declarandum quedam obscure dicta, Fratris Rogeri. Nunc primum edidit R. Steele, 771
- Bacterial Diseases of Farm Crops, 155
- Bahama Flora, The, Prof. N. L. Britton and Dr. C. F. Millspaugh, 327
- Bakerian Lecture, The, Drs. T. M. Lowry and C. P. Austin, 476
- Bala Country, The, Its Structure and Rock-succession, Dr. Gertrude L. Elles, 158
- Balances and Weights, Students', Gallenkamp and Co.'s List of, 310
- Balsa Wood, Structure and Uses of, R. C. Carpenter, 279
- Barbados—Antigua Expedition, C. C. Nutting, 829
- Barrows, Excavation of, on Brightwell Heath, near Ipswich, J. Reid Moir, 723
- Basal Glume-rot of Wheat, 155
- Basic Slags: Their Production and Utilisation in Agriculture, 7
- Batetela, The, E. Torday, 179
- Battery Depolarised by Air, A, C. Féry, 30
- Baudot Telegraph, The Use of the, in Wireless Telegraphy, H. Abraham and R. Planiol, 447
- Beans, White-runner, Bumble Bees and, A. S. E. Ackermann, 822
- Beast and Man in India, 805
- Beauty and the Beast: An Essay in Evolutionary Aesthetic, S. A. McDowall, 35
- Bee Disease, Researches on, a Correction, P. B. White, 373
- Beer, Scientific and other Aspects of, 698
- Bees and Scarlet-runner Beans, H. J. Lowe, 684, 747; Disease in, Pathogenic Organisms in the Pollen of Flowers and, Hon. Col. C. J. Bond, 584; Hive, Isle of Wight Disease in, Dr. J. Rennie, and others; Dr. A. D. Imms, 283
- Beit Fellowships for Scientific Research awarded to H. L. Riley and W. A. P. Challenor, 700
- Berlin University, Prof. W. Nernst elected Rector of, 732
- Beryllium, Anode Rays of, G. P. Thomson, 395
- Betty and Bobtail at Pine-tree Farm, Lillian Gask, 41
- Bible, The, Its Nature and Inspiration, E. Grubb, 738
- Bibliotheca Chémico-mathematica, 2 vols., Compiled and Annotated by H. Z. and H. C. S., 294
- Binary Forms, Geometric Theory of, ii., 127; iii., 128, A. Comessatti, 127
- Binaural Localisation of Pure Sounds, A. Lo Surdo, 351
- Biochemistry, Elementary Practical, Prof. W. A. Osborne, 45
- Biological Terminology, Sir G. Archdall Reid, 265; Dr. F. A. Bather, 301; Sir G. Archdall Reid, 425; Dr. F. A. Bather, 489; Sir G. Archdall Reid, 680; Dr. F. A. Bather, 778
- Bio-Technology, Bureau of, Bulletin No. 2 of the, 278
- Birds of the British Isles, The, and their Eggs, T. A. Coward. Second series, 40
- Birkbeck College, J. W. Low appointed Lecturer in Zoology at, 156
- Birmingham University, Appointments in, 90; W. H. Moberley appointed Professor of Philosophy; Dr. H. J. W. Tillyard Professor of Russian; Signorina L. P. di Castelvecchio Professor of Italian; E. H. F. Mills Librarian in, 474; Conferment of Degrees; gift by C. Hyde, 603
- Birth Control, Constructive, Discussion on, 692; and Racial Progress, Society for, Dr. Maric Stopes elected President of the, 821
- Birthday Honours, The King's, 466
- Bismuth, The Action of, on Syphilis and on the Nagana Trypanosome, R. Sazerac and C. Levaditi, 543
- Blattoid (Archimylacris), A New Species of, from the Keele Group (Stephanian) of Shropshire, H. Bolton, 29
- Blood: and of Sperm, Method of Individual Diagnosis of the, M. Dervieux, 543; Plasma of Birds, Coagulation of the, The Action of Chloroform on the, P. Nolf, 703
- Blow-pipe Construction, A New Principle in, H. G. Becker, 446
- Board of Trade, Standards Department, J. E. Spears, jun., appointed Deputy Warden in succession to Major P. A. MacMahon, 307
- Bohr's Model Atom and Corpuscular Spectra, M. and L. de Broglie, 222
- Bombay, The Development of, Sir G. Curtis, 757
- Bombus in the Indian Plains, The Occurrence of, C. Dover, 362
- Bones, Conformation of, The Influence of Function on the A. B. Appleton, 190
- Boric Acid, The Action of, on Glycerol and the Polyvalent Alcohols, R. Dubrisay, 670
- Bose Research Institute, Grant to and Work of the 821
- Botanical Papers from Pennsylvania, 764
- Botanist, The Outdoor, A. R. Horwood, 293
- Botany: and Geology during the War Period, Work Done in, Prof. A. J. Ewart, 441; College, Structure, Physiology, and Economics of Plants, Dr. M. T. Cook, 807; Descriptive, 346; for Medical and Pharmaceutical Students, a Text-book of, Prof. J. Small, 777; General, for Universities and Colleges, Prof. H. D. Densmore, 69; General, Laboratory and Field Exercises for, Prof. H. D. Densmore, 69; with Agricultural Applications, Prof. J. N. Martin. Second edition, 168
- Bothalia*, No. 1, 691
- Botulism, 53
- Boyle: Medal of the Royal Dublin Society, Award of the, to Dr. G. H. Pethybridge, 51; Robert, Lecture, Sir William Bragg, 374
- Bradford Technical College, Appointments at, 28, 411
- Brain Injuries: Diagnosis and Treatment of, with and without a Fracture of the Skull, Prof. W. Sharpe, 484
- Bray Series, The Problem of the, Prof. G. A. J. Cole, 510
- Brazilian National Observatory Annual, 1921, 119
- Break-shock Reflexes and "Supra-maximal" Contraction-response of Mammalian Nerve-muscle to Single-shock Stimuli, 509
- Breathed-on Plates, The Colours of, Prof. C. V. Raman, 714
- Bright Object near the Sun, 759, 793
- Brinell Hardness Testing Machine, A Small, 762
- Bristol University: Colston Society Committee, the Title of the, changed to Colston University Research Society, 60; impending Retirement of Sir Isambard Owen from the Vice-chancellorship, 442; Appeal for Funds, 443; Gifts to, by H. H. Wills, 604, 700; Students from Abroad at, 669; Appeal Fund of, 733
- British: Academy, A. J. Balfour elected President of the, 629; American and, Engineers, Conference of, 594; American and, Superannuation Systems, 545; W. Palin Elderton, 651; and German Volumetric Glassware, A Comparison of, Sir J. E. Petavel, 297; Association. Combined Meeting of Organising Committees of the Sections of the, 20; Report of the Corresponding Societies Committee of the, 53; 1921 Presidents of Sections, 114; The Edinburgh Meeting of the, 472; Prof. J. H. Ashworth, 590, 818; Birds, Field Observations on, A Sportsman-naturalist (the late Dr. F. M. Ogilvie), 259; Cast-iron Research Association. The, Approved by the Department of Scientific and Industrial Research, 499; Chemists during the War, Work of, Prof. N. T. M. Willsmore, 440; Coal-fields, 38; Coccidæ, Observations on part vi; E. E. Green, 724; Dyes and Dyestuffs, 673;

- Dyestuffs Corporation, 162; Droughts, Great, C. Harding, 627; Engineering Standards Association, Formation of Seven Sub-committees, 532; Fauna, An Addition to the, Prof. A. Dendy, 298; Flora: A New, British Wild Flowers in their Natural Haunts, A. R. Horwood. (In six vols.) Vols. i. and ii., 232; Forestry, The Progress of, 753; Glass Industries, Ltd., The New Works of, 181; International Association of Journalists, L. Gaster elected Honorary General Secretary of the, 342; Iron Ores, Prof. H. Louis, 261, Isles, The Birds of the, and their Eggs, T. A. Coward. Second series, 40; Laboratory and Scientific Glassware, J. H. Davidson, 331; Laboratory Ware and Chemicals, Prof. J. R. Partington and C. L. Bryant, 457; Mammals, Studies of, 547; Medical Association, Sir William Macewen President-elect for 1922, 307; Meteorological and Magnetic Year Book, 1917, part 4, 152; Museum, R. L. Hobson and R. A. Smith appointed Deputy Keepers in the Department of British and Medieval Antiquities, 51; Dr. W. T. Calman appointed Deputy Keeper in the Department of Zoology, 402; appointments in the, 722; New Guinea, The Migrations of Cultures in, Dr. A. C. Haddon, 532; Petrographic Nomenclature, Report of Joint Committee on, 149; Pharmacy and its Possibilities, E. S. Peck, 564; Plants Available as a Source of Industrial Alcohol, Prof. M. C. Potter, 170; Plants: Their Biology and Ecology, J. F. Bevis and H. J. Jeffrey. Second edition, 71; Rainfall, 1919, 71; Research Association for Liquid Fuels for Oil Engines Industry, The, approved by the Department of Scientific and Industrial Research, 21; for the Woollen and Worsted Industries, Report of the Council for 1920, 246; Race, to Save the, 661; Roses, the Study of, J. R. Matthews, 26; Science Guild, Annual Dinner of the, Speeches by Lord Montagu of Beaulieu, Sir William Robertson, Lord Rayleigh, and Lord Bledisloe, 313-314; Annual Meeting of the, Address by Lord Montagu of Beaulieu, and others, 505; Scientific Instruments, J. W. Williamson, 361; Dictionary of, 324; Stratigraphy, 355; Wild Animals, Habits and Characters of, H. M. Batten, 547
- Bromine—tellurium, The System, A. Damiens, 790
- Brown, Adrian, Memorial Lecture, The, Prof. H. E. Armstrong, 698
- Browning of the Vine, the Brown Corpuscles causing the, J. Politis, 287
- "Buddha's Diadem," Dr. L. A. Waddell, 150
- Bumble-bees of the genus *Psithyrus*, Variation in, Dr. R. C. L. Perkins, 564
- Bunyoro, The Milk Customs of, Rev. J. Roscoe, 602
- Burma, In Farthest, Capt. F. Kingdon Ward, 231
- Burmese, the pre-Buddhist Religion of the, R. G. Brown, 791
- Burton, Sir Richard F., the Centenary of, 52; Institution of a Memorial Lecture and a Medal, by the Royal Asiatic Society, 630
- Bushmen, The Stone Querns of the, Dr. Peringuey, 469
- Cactaceae, A New Book on, N. E. Brown, 580; The, Drs. N. L. Britton and J. N. Rose, Vol. ii., 580
- Cæsium, A New Spectrum of, L. Dunoyer, 831
- Calcite, The Zoned Concretions of, in the Magnesian Limestone of Durham, O. Holtedahl, 795
- Calcium Borate Inyoite, Hydrous, found in the Whitehead Gypsum Quarry, Hillsborough, New Brunswick, E. Poitevin and H. U. Ellsworth, 823; Carbide, The Preparation of, by Calcium-ammonium and Acetylene, L. Hackspill and E. Botolfsen, 735; Lines, Fixed, in Early Type Stars, R. K. Young, 347
- Calculus: for Students, 775; Infinitesimal, An Elementary Course of, Prof. H. Lamb. Third edition, 775
- Calcutta: and Bombay School of Tropical Medicine and Hygiene, Plea for the Support of the, Lt.-Col. J. W. D. Megaw, 156; University, Application for Financial Aid for Teaching and Post-graduate Study, 188
- Calendar: of Scientific Pioneers, 29, 61, 92, 124, 157, 189, 221, 252, 285, 317, 349, 381, 412, 444, 476, 508, 541, 573, 604, 638, 670, 701, 734, 767, 798, 831; Reform,
- A. Philip, 235; A Simplified, Rev. E. Fanfani, 88; Plan of, Prof. R. Baire, 634
- California: Institute of Technology, Appointments in the Norman Bridge Laboratory of Physics at the, 820; The Sunset Midway Oilfield of. Part i., Geology and Oil Resources, R. W. Pack, 347
- Calorimetry, The Use of Enamelled Bombs in, C. Matignon and Mlle. G. Marchal, 319
- Cambridge: Microtomes and Recording Clinical Thermometers, Cambridge and Paul Instrument Co., Ltd., 437; University, Proposed Prælectorship in Geodesy; Diploma in Hygiene, Grants made to the Gordon Wigan Fund, 27, 28; A. D. Browne elected to a Fellowship at Queen's College; W. M. Smart appointed to the John Couch Adams Astronomership; Smith's Prizes awarded to L. A. Pars and W. M. H. Greaves, 60; L. J. Comrie and W. M. H. Greaves elected to Isaac Newton Studentships in Astronomy; Proposed Appointment of a University Lecturer in Medical Radiology; Report of the General Board of Studies; Proposed Discontinuance of the Higher Local Examination, 123; Emmanuel College, Offer of a Research Studentship, 220; Prof. F. G. Hopkins elected to the Sir William Dunn Professorship of Bio-chemistry; Sir Napier Shaw to deliver the Rede Lecture; H. G. Carter appointed Curator of the Herbarium; proposed Grant from the Worts Fund towards an Expedition to Greenland; Steps towards a Solution of the Women in the University Question, 284; Dr. J. H. D. Scott and W. W. Harvey elected to John Lucas Walker Studentships in Pathology; T. C. Wyatt elected to a Fellowship at Christ's College; Gift by Barclays Bank, Ltd., towards the new Engineering Laboratory; Proposals as to Women Students, 316; Possible Alterations in the Mathematical and Natural Sciences Triposes; Proposed Appointment of Prof. H. Lamb as Rayleigh Lecturer in Mathematics; The Humphrey Owen Jones Lectureship to be Revived; L. A. Pars elected to a Fellowship at Jesus College, 348; Dr. W. M. Hicks awarded the Adams Prize; Proposed Advisory Committee in Geodesy and Geodynamics, 379; Forthcoming Conferment of Honorary Degrees; A Lecturer to be Appointed for Physics as Applied to Medical Radiology; the Degree of Ph.D. approved for C. G. L. Wolf; The Scope of the Examination in Anatomy in the Natural Sciences Tripos, 411; Dr. G. E. Moore and W. E. Johnson re-elected University Lecturers in Moral Science; F. Debenham re-elected University Lecturer in Surveying and Cartography; J. A. Venn nominated Gilbey Lecturer in History and Economics of Agriculture; J. C. Wallace elected a Junior Fellow of Emmanuel College; Miss F. E. Haines elected to a Fellowship at Girton College, and Miss M. T. Budden to a Fellowship at Newnham College, 474; Proposed Appointment of a Committee to Manage the Low Temperature Station for Research in Bio-chemistry and Bio-physics; Dr. H. Hartridge appointed Senior Demonstrator in Physiology; Postponement of Vote on the Women Question, 475; E. K. Rideal appointed Humphrey Owen Jones Lecturer in Physical Chemistry; Dr. L. Cobbett re-appointed University Lecturer in Pathology; The Rede Lecture delivered by Sir Napier Shaw, 507; Frank Smart Prizes awarded to A. J. Smith and G. S. Carter, 540; Dr. J. A. Crowther appointed University Lecturer in Physics as Applied to Medical Radiology; S. E. Hollingworth elected to the Harkness Scholarship in Geology, 572; P. Lake re-appointed Royal Geographical Society's Reader in Geography, 572; A. G. Brighton and H. C. G. Vincent awarded the Wiltshire Prize in Geology; W. C. Smith and R. H. Thouless elected Fellows of Corpus Christi College, 572; A Travelling Girton Fellowship awarded to Miss M. G. Tomkinson, 603; Appointments in, 830
- Camera Lenses, An Instrument for Testing, F. Twyman, 470, 635
- Camouflage, Natural, 338
- Canadian Arctic Archipelago, K. Rasmussen's Expedition to the, 308
- Cancer: New Electrical Plant for the X-ray Treatment of, 561; The Use of Radiotherapy in the Treatment of, 820
- Cannibals, Reformed, 111

- Caoutchouc, Solubility of Crystalline Substances in, G. Bruni, 254
- Cape Observatory, The, Sir Joseph Larmor, 601
- Cape Town University, F. S. Edie appointed Professor of Biochemistry in, 572
- Capillarity: Studies in, part i., Dr. A. Ferguson; Studies in, part ii., Dr. A. Ferguson and P. E. Dawson, 477
- Carbon: Arc, Radiation from the, Dr. H. H. Plaskett, 649; Monoxide in Air- and Flue-gases, Estimating Small Quantities of, D. Florentin and H. Vandenberghe, 63; The Fixation of, Diluted and Carried by an Air-current, Desgrez, Guillemard, and Hemmerdinger, 735
- Carnegie: Andrew, Autobiography of, 2; Institution of Washington, Year Book of the, 503; Preliminary Results of the Magnetic Survey of the Indian and Southern Oceans by the, 181; Return of the, to San Francisco, 84; Trust for the Universities of Scotland, Report for 1919-20 of the, 123; United Kingdom Trust, Report of the, for 1920, 157
- Catalytic: Actions at Solid Surfaces, A Study of, vi., Dr. E. F. Armstrong and T. P. Hilditch, 573; Activity of Copper, The, part ii., W. G. Palmer, 412; Hydrogenation with Copper, P. Sabatier and B. Kubota, 222; Hydrogenation of the Phenylhydrazones, The, A. Mailhe, 414; Oxidation of Ammonia, The rôle of the Gaseous Impurities in the, E. Decarrière, 670; Oxidation of Ammonia Gas, The rôle of the Gaseous Impurities in the, E. Decarrière, 735; Reduction of Ethylene to Ethane, Some Experiments on the, Dorothy M. Palmer and W. G. Palmer, 412
- Catechin, The Constitution of, Parts i. to iii., Dr. Nierenstein, and others, 280
- Cattle-egret, The Restoration of the, to Egypt, J. L. Bonhote, 245
- Cawthron Institute, Nelson, New Zealand, Opening of the, by Lord Jellicoe, 435, 668
- Cedar, A Recumbent, in Vigorous Growth, 792
- Cell Division, The Cytological Consequences of the Osmotic Arrest of, J. Dragoin and F. Viès, 447; The Osmotic Pressure of Arrest of, F. Viès and J. Dragoin, 414
- Cellar-book, Notes on a, Prof. G. Saintsbury. New edition, 163
- Cells of Plant Tissues in Relation to Cell-sap as the Food of Aphids, Dr. J. Davidson, 93
- Cellular Immortality, Prof. R. Pearl, 404
- Central Africa, Sport and Administration in, Sir H. H. Johnston, 518
- Ceratitis capitata*, A Breeding-ground of, in the Neighbourhood of Paris, P. Lesne, 94
- Cereals, Genetics of, 250
- Ceylon Ambrosia Beetles and their Relation to Problems of Plant Physiology, E. R. Speyer, 93
- Channel Islands, An Archaeological Discovery in the, J. M'Lellan Mann, 467
- Chellean Palaeolithic Workshop-site at Cromer, An Early, J. Reid Moir, and others, 406
- Chemical: Analysis, Public Health, R. C. Frederick and Dr. A. Forster, 708; Analysis, Qualitative Introduction to, Th. W. Fresenius. Seventeenth edition, translated by C. A. Mitchell, 708; Analysis of Special Steels, Steel-making Alloys, their Ores and Graphites, Rapid Methods for the, C. M. Johnson. Third edition, 423; Formulae and Equations, Set of Cards for Teaching, Mrs. M. Partington, 206; Industry, Society of, Nomination of Prof. R. F. Ruttan as President of the, 563; Reactions, A Photographic Method of Registering, Accompanied by a Variation in Pressure, R. Jolibois, 254; and Radius of Curvature, M. Luce, 510; Research in the Elementary Laboratory, 356; Society, Election of Officers and Council of the, 115; Annual General Meeting and Dinner of the, 116; Theory, The Foundations of, Prof. R. M. Caven, 613
- Chemicals, Fine, Laboratory Glass and Porcelain. Issue of a Memorandum on, by the Institute of Chemistry, 306; Pure Organic, Prof. J. B. Cohen 12
- Chémie der Hefe und der alkoholischen Gärung, Profs. H. Euler and P. Lindner, 485
- Chemische Literatur, Die, und die Organisation der Wissenschaft, Prof. W. Ostwald, 613
- Chemistry: G. H. J. Adlam, 647; Applied, a Forthcoming Congress of, 821; Reports of the Progress of, vol. v., 1920, 807; Biological, Practical, Prof. G. Bertrand and P. Thomas. Translated from the third edition by H. A. Colwell, 390; Creative, Descriptive of Recent Achievements in the Chemical Industries, Dr. E. E. Slosson, 618; Early, in Oxford, Sir Edward Thorpe, 13; General and Industrial Organic, Treatise on, Prof. E. Molinari. Translated from the third Italian edition by T. H. Pope, part i., 325; General, Introduction to, Prof. H. Copaux. Translated by Dr. H. Lefmann, 743; Inorganic, E. I. Lewis. Third edition, 613; A Modern, 198; Prof. J. R. Partington; The Reviewer, 269; A Text-book of, for University Students, Prof. J. R. Partington, 198; Institute of, Address to the, by Sir Herbert Jackson, 22; A. Chaston Chapman elected President of the, 23; International Conference of, 787; Large-scale, at the Imperial College of Science and Technology, 624; Organic, A Laboratory Manual of, for Medical Students, Prof. M. Steel. Second edition, 549; A Text-book of, Prof. A. F. Holleman. Edited by Dr. A. J. Walker, assisted by Dr. O. E. Mott. Fifth English edition, 325; Experimental, Prof. A. P. West, 807; Laboratory Manual of, Dr. H. L. Fisher, 519; Text-books of, 325; Physical, A System of, Prof. W. C. McC. Lewis (in three vols.), vol. ii., Thermodynamics. Third edition, 772; Physical, Pure and Applied, 772; Physical and Inorganic, Recent Advances in, Prof. A. W. Stewart. Fourth edition, 262; Prof. J. R. Partington, 262; Practical, 708; Practical, A Text-book of, G. F. Hood and Major J. A. Carpenter, 708; Progress of, Annual Reports on the, for 1920, 519; The Experimental Basis of, Suggestions for a Series of Experiments Illustrative of the Fundamental Principles of Chemistry, Ida Freund. Edited by A. Hutchinson and M. Beatrice Thomas, 356; The Finsbury School of, Prof. G. T. Morgan, 154; Theoretical, Text-books on, 613; Vocational, for Students of Agricultural and Home Economics, Prof. J. J. Willaman, 777
- Chemists, Famous, The Men and Their Work, Sir William A. Tilden, 802
- Chequers Estate, gift by Lord Lee to the Nation of an Estate in Connection with the, 499
- Chermes Cooleyi*, Gillette, 532
- Child Welfare Movement, The, Dr. Janet E. Lane-Clayton, 328
- Chilka Lake: The Leeches of the, W. A. Harding, 370; The Vegetation of an Island in the, Dr. N. Annandale, 574
- Chimie et la Guerre, La, Science et Avenir, Prof. C. Moureu, 516
- Chimpanzee, Vertebro-medullary Topography of, G. Sergi, 128
- Chinese Earthquake of December 16, 1920, The, Dr. C. Davison, 473
- Chloraloxim, The Action of, on the Aromatic Amines: The Synthesis of Isatins, T. Martinet and P. Coisset, 478
- Chloride Bath, Deposits from the, W. E. Hughes, 253
- Chlorine: The Atomic Weight of, in Some Minerals, Mlle Irène Curie, 382; The Absorption Spectra of, for the X-rays, A. E. Lindh, 447; The Isotopes of, The Separation of, Profs. J. N. Brönsted and G. Hevesy, 619
- Chlorophyll in the Plasts, The State of, V. Lubimenko, 831
- Chloropicrin, The Action of the Vapours of, on *Argas reflexus*, P. Remy, 640
- Chocolate: Cocoa and, their Chemistry and Manufacture, R. Whympster. Second edition, 713; Their History from Plantation to Consumer, A. W. Knapp, 357
- Chromam Series, Studies in the, Dr. Nierenstein and others, 280
- Chronology: Early, of Sumer and Egypt, Prof. S. Langdon, 315; Primitive, Dr. J. L. E. Dreyer, 274
- Churn, History of the, R. Hedger Wallace, 587
- "Churning at 62°," The Origin of, on Dairy Thermometers, R. Hedger Wallace; Pastorelli and Rapkin, Ltd., Dr. W. Goodwin, 268; A. C. Cossor and Son, 362
- Ciliary Movement, The Mechanism of, J. Gray, 190
- Circulation, Superficial, i., M. Pascal, 127; iii., M. Pascal, 671

- Circumcision Regiments as a Native Chronology, W. A. Norton, 607
- Citizenship, World, Education and, 707
- Civics, The Summer School of, 220
- Civil : Engineers, Institution of, Awards of the, 307; List Pensions, New, 650; Service Estimates, Agriculture and Fisheries in the, 257; University Grants in the, 225; Salaries, University and, 801; Science in the, 1
- Civilisation : Modern, Sir Michael Sadler, 700; Science and Capt. B. J. Marden, 623; J. Henderson Smith and Major A. G. Church, 684; Dr. C. V. Drysdale, 715; The Development and Spread of, W. J. Perry, 146; The Salvaging of, H. G. Wells, 707
- Claude Process for Ammonia Synthesis, The, G. Claude, 765
- Clavellina Zooids, The Production of Living, in Winter by Experiment, Dr. J. H. Orton, 75
- Clavicorn and Other Beetles, The, Dr. H. Scott, 413
- Clay : in its Relation to Piles, Experiments with, A. S. E. Ackermann, 534; The Physical Properties of, *ibid.*, A. S. E. Ackermann 824
- Cloridae, The, Schenkling, 413
- Climate in North-west Europe, The Evolution of Climate in, C. E. P. Brooks, 286
- Clisiophyllum, The Genus, Prof. P. Macnair and C. M. Leitch, 606
- Cloud : Form in the Lower Atmosphere, The Physical Structure of, R. F. Granger, 605; Forms, Capt. C. J. P. Cave, 365
- Clouds : G. A. Clarke, 365; Systems of, P. Schereschewsky, 575
- Coal : -fields, British, 38; in Great Britain, Dr. W. Gibson, 38; -mining Industry, The, Prof. H. Louis, 763; Oil or Wind, C. O. Liljegen, 152; Position, The, 193; Pulverised, as a Combustible, Sir R. A. S. Redmayne, 812; The Economic Selection of, A. L. Booth, 282; The Microstructure of, 282; The World-position in Relation to, Sir Richard A. S. Redmayne, 633
- Coals, Brown, and Lignites, Researches upon, part 1, Prof. W. A. Bone, 125
- Cobalt Ore, A New Deposit of, 25
- Cockchafer, The Resistance of the Adult, to Low and High Temperatures, H. Faes and M. Staehelin, 703
- Cockroach, The, F. Laing, 565
- Cocoa and Chocolate : their Chemistry and Manufacture, R. Whymper. Second edition, 713; their History from Plantation to Consumer, A. W. Knapp, 357
- Coco-nut, The, Prof. E. B. Copeland, Second edition, 391
- Cohesion, Dr. H. Chatley, 786
- Coiling of Underground Shoots of *Convolvulus arvensis*, Rev. Canon J. E. H. Blake, 747
- Coke from Sarre Coal, The Production of, M. Baille-Barrelle, 663
- Cold, The Mechanical Production of, Sir J. A. Ewing. Second edition, 103
- Collège de France, Retirement of Prof. H. Bergson, 572
- Colloidal : Arsenic Sulphide, The Flocculation of, A. Boutaric and M. Vuillaume, 510; Theory, W. B. Hardy, 226
- Colloid Chemistry : An Introduction to Theoretical and Applied, "The World of Neglected Dimensions," Dr. W. Ostwald. Translated by Prof. M. H. Fischer, 226
- Colloïdothérapie : La, Résultats Cliniques, Dr. J. Laumonier, 358
- Colloids : and Colloidal Electrolytes, Prof. J. W. McBain, 46; The Chemistry of, Prof. R. Zsigmondy. Translated by Prof. E. B. Spear, two parts, 226; The Formation of, Prof. The Svedberg, 744
- Colour Vision : A Quantum Theory of, Prof. J. Joly, 317; New Facts of, Dr. F. W. Eddridge-Green, 826
- Coloured Thinking and Thought-forms, G. Stridsberg, 55
- Coma, The Calculation of the, G. Gouy, 286
- Combinatory Analysis, An Introduction to, Major P. A. MacMahon, 357
- Comet, New, 1921a, 119
- Companions : Feathered, Furred, and Scaled, C. H. Donald, 805
- Concealing. Coloration in the Animal Kingdom : An Exposition of the Laws of Disguise through Colour and Pattern : Being a Summary of A. H. Thayer's Dis-closures, G. H. Thayer. New edition, 338
- Concrete, Reinforced : Protecting, from Marine Deterioration, F. E. Wentworth-Sheilds, 596; The Use of, on British Railways, W. W. Grierson, 596
- Conical Refraction in Biaxial Crystals, Prof. C. V. Raman, 747
- Conics, Analytical, The Elements of, Dr. C. Davison, 616
- Conifers in English Gardens, Miss G. Lister, 538
- Conjoint Board of Scientific Societies, Fourth Report of the, 600
- Conscious, From the Unconscious to the, G. Geley. Translated by S. de Brath, 712
- Conscription, Fraudulent Proceedings Practised to Avoid Service under, 470
- Contact Pressures and Stresses, Prof. G. Coker, K. C. Chakko, and M. S. Ahmed, 280
- Convolvulus arvensis*, Coiling of Underground Shoots of, Rev. Canon J. E. H. Blake, 747
- Coolidge Tube, a Danger Arising from the, when Used for X-ray Screen Work, Dr. A. E. Barclay, 53
- Cooling of a Solid Sphere, The, with a Concentric Core of a Different Material, Dr. H. S. Carslaw, 446
- Co-operative Indexing of Periodical Literature, 449; Dr. F. A. Bather, Prof. W. M. F. Petrie, Dr. J. W. Evans, A. P. Newton, S. Gaselee, 550; 551
- Copernicus of Antiquity, The (Aristarchus of Samos), Sir Thomas Heath, 713
- Copper : Deposits of Arizona, F. L. Ransome, 59; The Non-toxicity of, for Mildew, M. and Mme. G. Villedieu, 31
- Corn Sales Bill, Second Reading of the, 243
- Cornalith, R. Hedger Wallace, 811
- Cornell University, Dr. L. Farrand elected president of, 732
- Corona Australis, The Variable Nebula in, H. K. Shaw, 634
- "Corona Voltmeter," The, Prof. J. B. Whitehead, 119
- Correction, A, Prof. J. A. Thomson, 811

CORRESPONDENCE.

- "Absolute" Temperatures in Meteorological Publications, Sir Napier Shaw, 201
- Acoustical Phenomenon, A New, Dr. J. Erskine-Murray, 490; Dr. H. Hartridge; H. S. Rowell; Prof. W. B. Morton, 586; Dr. G. A. Shakespear, 623; F. M. West, 652
- "Æther," "Space" or, Prof. A. S. Eddington, 201; Dr. Norman R. Campbell; L. C. W. Bonacina, 234; Uniform Motion in the, E. H. Syngé, 746; Dr. H. Jeffreys, 747
- Alcohol, Industrial, British Plants available as a source of, Prof. M. C. Potter, 170
- Algebraical Identity, An, $4X=Y^2-37Z^2$, Prof. G. B. Mathews, 456; Dr. H. C. Pocklington; Father J. Cullen, 587; W. E. H. Berwick, 652
- Aircraft Propellers, High-speed, and the Destruction of Gnats, H. C. Watts, 269
- Alkali Metals, The Constitution of the, Dr. F. W. Aston, 72
- American and British Superannuation Systems, W. Palin Elderton, 651; Dr. J. W. Evans; W. Palin Elderton, 683
- Annular Eclipse, The, of April 8, Sir Francis Darwin; Miss Eleonora Armitage; E. L. Gill, 212
- Anode Rays of Beryllium, G. P. Thomson, 395
- Antilogs, Logs and, R. T. A. I., 300
- Artefacts and their Geological Age, T. Sheppard, 587
- Atmospheric Refraction, A. Mallock, 456; Dr. J. de Graaff Hunter; A. Mallock, 745
- Atom, the Size of the, Ionisation Potential and, Prof. A. S. Eve, 552
- Atomic Radius, The, and the Ionisation Potential, Prof. Megh Nad Saha, 682; Structure, Prof. N. Bohr, 104; Dr. Norman R. Campbell, 170
- Atoms and Molecules, The Dimensions of, Prof. W. L. Bragg and H. Bell, 107
- Aurora in the South of England, The Common Occurrence of, Lord Rayleigh, 137; of May 13-15, The, Lord Rayleigh, 392
- Auroral Display, A. E. L. Hudson, 359

- Bees and Scarlet-runner Beans, H. J. Lowe, 684; 747
 Beryllium, Anode Rays of, G. P. Thomson, 395
 "Biochemistry," "Elementary Practical," Prof. W. A. Osborne, 45
 Biological Terminology, Sir G. Archdall Reid, 265; Dr. F. A. Bather, 301; Sir G. Archdall Reid, 425; Dr. F. A. Bather, 489; Sir G. Archdall Reid, 680; Dr. F. A. Bather, 778
 Bombus in the Indian Plains, The Occurrence of, C. Dover, 362
 Breathed-on Plates, The Colours of, Prof. C. V. Raman, 714
 British and German Volumetric Glassware, A Comparison of, Sir J. E. Petavel, 297; Laboratory and Scientific Glassware, J. H. Davidson, 331; Fauna, An Addition to the (*Rhynchodemus scharffi*), Prof. A. Dendy, 298; Laboratory Ware and Chemicals, Prof. J. R. Partington and C. L. Bryant, 457; Land Planarian, A New, Dr. R. F. Scharff, 361; Plants available as a Source of Industrial Alcohol, Prof. M. C. Potter, 170; Scientific Instruments, J. W. Williamson, 361
 Calendar Reform, A. Philip, 235
 Chemicals, Pure Organic, Prof. J. B. Cohen, 12
 Chemistry, Inorganic, A Modern, Prof. J. R. Partington; The Reviewer, 269
 Chlorine, The Separation of the Isotopes of, Profs. J. N. Brønsted and G. Hevesy, 619
 Churn, History of the, R. Hedger Wallace, 587
 "Churning at 62°," The Origin of, on Dairy Thermometers, R. Hedger Wallace; Pastorelli and Rapkin, Ltd.; Dr. W. Goodwin, 268; A. C. Cossor and Son, 362
 Civilisation, Science and, Capt. B. J. Marden, 623
 Clavellina Zooids in Winter, The Production of Living, by Experiment, Dr. J. H. Orton, 75
 Conical Refraction in Biaxial Crystals, Prof. C. V. Raman, 747
Convolvulus arvensis, Coiling of Underground Shoots of, Rev. Canon J. E. H. Blake, 811
 Cornalith, R. Hedger Wallace, 811
 Correction, A, Prof. J. Arthur Thomson, 811
 Cotton Hairs, Method of Cutting Sections of, H. J. Denham, 299; Dr. W. L. Balls and H. A. Hancock, 361
 Cup and Ring Markings, C. Carus-Wilson, 523; G. Abbott, 652; C. Carus-Wilson, 715
 Cyclones, The Energy of, Prof. J. von Hann, 11
 Double Pendulum, A New Theorem on the, H. S. Rowell, 684
 Doublets in Spectral Series, D. Rogestvinsky, 203
 Drought, The, and Underground Water, B. Hobson, 684
 Earthworms Drowned in Puddles, Sir E. Ray Lankester, 329; J. H. Coste, 360; R. B. Marston, 779; Mud-worms and Water-worms, Sir E. Ray Lankester, 424
 Einstein's Gravitational Theory, A Difficulty in, G. W. Walker, 169; Prof. A. S. Eddington, 170
 Electrodeless Discharge, The, in Sodium Vapour, Prof. J. K. Robertson, 269
 Electron in the Atom of Mercury, The Normal Orbit of the, A. Terenin, 203; The Gravitational Field of an, Sir Oliver Lodge, 392
 Electrons, Light and, Sir Oliver Lodge, 169; Prof. J. Joly, 203
 Elements, The Disintegration of, by α -Particles, Sir E. Rutherford and J. Chadwick, 41
 Emulsoid Colloid State, The Nature of the, Dr. S. E. Sheppard, 73; Prof. J. W. McBain, 74
 Energy, Molecular Structure and, Prof. J. R. Partington, 172; Prof. A. O. Rankine, 203; Quantum, A Physical Interpretation of the, I. Aucken, 553
 Everest, Mount, The Ascent of, Sir Francis Younghusband and Prof. J. N. Collie, 12; Lt.-Col. H. H. Godwin-Austen, 137
 Fauna of Scottish Lochs, The, Dr. N. Annandale, 778
 Fern, Variegation in a, Dr. W. Bateson, 233
 Flint, An Unknown Organism in, C. Carus-Wilson, 299; Prof. G. A. J. Cole, 333; C. Carus-Wilson, 362; Implementations in the Cromer Forest Bed, J. Reid Moir, 458
 Flying-fish, The "Flight" of, Sir David Wilson-Barker; Prof. F. Wood-Jones, 233; J. S. Huxley, 267; H. H. Clayton, 714
 Foreign Scientific Literature, H. Richardson, 458
 Fowler: W. Warde, A Personal Appreciation, H. E. A., 551
 Geometrical Isomerism in Monomolecular Films, N. K. Adam, 522
 Geometry, Experimental, Dr. N. R. Campbell, 301
 German Publications, The Reparation Act and the Cost of, Prof. J. Stanley Gardiner, 359
 Glass, The Nature of the Electrical Conductivity of, H. H. Poole, 584
 Glassware, British Laboratory and Scientific, J. H. Davidson, 331; Volumetric, A Comparison of British and German, Sir J. E. Petavel, 297
 Gnats, The Destruction of, High-speed Aircraft Propellers and, H. C. Watts, 269
 Gold-coloured Teeth of Sheep, W. J. L. Abbott, 459
 Gorse-seed, Vitality of, J. Parkin, 491
 Greenland in Europe, D. MacRitchie, 141
 Gregarious Instinct, Protozoa and the Evolution of the, R. J. Ludford, 332
 Gun-fire, Distant, The Sound of, Father V. Schaffers, 44; C. Carus-Wilson; Dr. C. Davison, 108; Capt. C. J. P. Cave, 140
 Hæmoglobin in Mollusca, Prof. A. E. Boycott, 395
 Hearing, The Resonance Theory of, Dr. H. Hartridge, 204; Dr. W. Perrett, 301; Dr. H. Hartridge, 394
 Heath-fires, The Generation of, E. A. Martin, 811
 Hedgehog, Habits of the, Dr. G. A. Auden, 491
 Helicopters, A. Mallock, 553; A. R. Low, 622
 Herons and Fish, Sir Herbert Maxwell, 490
 Homogeneous Vibrations, The Quantum Theory and, Sir Arthur Schuster, 233
 Indexing, Co-operative, of Periodical Literature, Dr. F. A. Bather; Prof. W. Flinders Petrie; Dr. J. W. Evans, 550; A. P. Newton; S. Gaselee, 551
 Inductance, Small, Measurement of, F. B. Pidduck, 623
 International Research Council, The, Sir Arthur Schuster, 72; Prof. G. H. Hardy, 107
 Ionisation Potential and the Size of the Atom, Prof. A. S. Eve, 552; The Atomic Radius and the, Prof. Megh Nad Saha, 682
 Iron Currency-bars, O. G. S. Crawford, 587
 Isotopes, The Atomic Volume of, Prof. F. Soddy, 41; Their Number and Classification, Prof. W. D. Harkins, 202
 Italian Meteorites, Prof. W. M. Flinders Petrie, 301
 Japanese Artificially Induced Pearl, The, Dr. W. Wingrave, 620; Dr. H. Lyster Jameson, 621
 Jerusalem University, Literature for, Prof. S. Alexander, I. M. Sieff, and D. B. Stanhill, 333
 Laboratory Ware and Chemicals, British, Prof. J. R. Partington and C. L. Bryant, 457
 Light and Electrons, Sir Oliver Lodge, 169; Prof. J. Joly, 203; Velocity of, Relativity and the, C. O. Bartrum; Sir Oliver Lodge, 73; J. H. Jeans, 42; C. O. Bartrum, 141; J. H. Jeans, 169
 Logs and Antilogs, R. T. A. I., 300
 Low-temperature Research, The Peltier Effect and, Dr. G. Martin; Sir Oliver Lodge, 73; A. A. Campbell Swinton, 43; Dr. G. Martin, 141
 Magnetic Double Refraction in Smokes, L. Tieri, 778; Storm of May 13-17, The, Dr. C. Chree, 359; Dr. A. Crichton Mitchell, 392; Dr. R. Whytlaw-Gray, 810
 Magnetism and Atomic Structure, Dr. A. E. Oxley, 652; Molecular and Cosmical, Prof. S. J. Barnett, 8; Prof. S. Chapman, 9
 Magneto-optical Effect, A Novel, Prof. E. Thomson, 520; Sir Oliver Lodge, 553; Dr. R. Whytlaw-Gray and J. B. Speakman; Prof. E. Thomson, 619; Prof. J. W. McBain, 683
 Man, The Natural History of, Sir G. Archdall Reid, 808
 Mercury, Atom of, The Normal Orbit of the Electron in the, A. Terenin, 203
 Metals, The Internal Physics of, Sir George Beilby; The Writer of the Article, 265
 Meteorites, Italian, Prof. W. M. Flinders Petrie, 301
 Meteorological Publications, "Absolute" Temperatures in, Sir Napier Shaw, 201
 Meteors on the Moon, J. W. Gordon, 234; Dr. A. C. D. Crommelin, 235
 Microscope, Measuring with High Powers of the, Dr. G. P. Bidder, 650

- Molecular Attractions in Solutions, Molecular Size and Range of, Prof. J. B. Leathes, 138; Structure and Energy, Prof. J. R. Partington, 172; Prof. A. O. Rankine, 203; Prof. A. W. C. Menzies, 331
- Molecules, Atoms and, The Dimensions of, Prof. W. L. Bragg and H. Bell 107
- Molluscan Fauna of Scottish Lakes, and a Pisidium new to the British Isles, B. B. Woodward, 715
- Moon, Meteors on the, J. W. Gordon, 234; Dr. A. C. D. Crommelin, 235
- Mutations and Evolution, Prof. R. R. Gates, 714; The Writer of the Article, 715
- Nickel, The Constitution of, Dr. F. W. Aston, 520
- Ocean Tides, A. C. Tennant, 299; Prof. J. Proudman, 300; H. A. Marmer, 393; Dr. W. Bell Dawson, 651
- Oceanographic Research in the British Empire, Dr. N. Annandale and Major R. B. S. Sewell, 139; Prof. W. A. Herdman, 172
- Ochreous Flint Artefacts from Sheringham, J. Reid Moir, 684
- Oil, Waste, from Ships, Prof. T. D. A. Cockerell, 333
- Optophone, Amplifying the, A. A. Campbell Swinton, 8; Dr. E. E. Fournier d'Albe; J. W. French, 43
- Ornithological Problem, An, G. A. Macmillan, 746
- Oyster, Native (*O. edulis*), Sex-change in the, Dr. J. H. Orton, 586
- Palestine, Science and Technology in, Daisy L. Adler, 458
- Pathogenic Organisms in the Pollen of Flowers and Disease in Bees, Hon. Col. C. J. Bond, 584
- Pearl, The Japanese Artificially Induced, Dr. W. Wingrave, 620; Dr. H. Lyster Jameson, 621
- Peat, Irish, The Exploitation of, Dr. A. Fleck, 779
- Peltier Effect, The, and Low-temperature Research, Dr. G. Martin; A. A. Campbell Swinton, 43; Sir Oliver Lodge, 73; Dr. G. Martin, 141
- Physics, The Concept of "Space" in, Dr. H. Jeffreys, 267
- Physiological Reactions in the Protozoa, J. S. Dunkerly, 395
- Phytophthora, Sexual Organs of, Prof. G. H. Pethybridge, 204
- Picture-hanging Wire, R. B. Marston, 362; A. J. Stubbs, 395; Principles of, Sir G. Greenhill, 491
- Plant-growth, Observations of, with the Recording Ultramicrometer, J. J. Dowling, 523
- Polarisation Phenomena in an X-ray Bulb, Dr. S. Ratner, 522
- Porto Santo, Natural History of, Prof. T. D. A. Cockerell, 10
- Positive Electricity, The Elementary Particle of, Prof. A. H. Patterson, 75
- Potassium Cyanide, The X-ray Structure of, P. A. Cooper, 745
- Prehistoric Cooking-place in Norfolk, A. Nina F. Layard, 623
- Primrose Flowers, The Colour of, Major R. O. Latham; The Writer of the Article, 301; Dr. J. W. H. Harrison, 359; G. Abbott, 395; F. H. Perrycoate, 459
- Protozoa; and the Evolution of the Gregarious Instinct, R. J. Ludford, 332; Phenomena of "Intelligence" in the, E. Heron-Allen, 456; Physiological Reactions in the, J. S. Dunkerly, 395
- Quantum Theory, The, and Homogeneous Vibrations, Sir Arthur Schuster, 233
- Quartzite Implements of Rostro-carinate and Early Palaeolithic Types in Uganda, The Discovery of, J. Reid Moir, 649
- Radiation from the Carbon Arc, Dr. H. H. Plaskett, 648
- Relativity: and the Deviation of Spectral Lines, Prof. H. J. Priestley, 43; and the Velocity of Light, C. O. Bartrum; J. H. Jeans, 42; Sir Oliver Lodge, 73; C. O. Bartrum, 141; J. H. Jeans, 169; Space, and Ultimate Reality, L. C. W. Bonacina, 171; The Principle of, Solar Eclipse Results and, C. E. Stromeyer; Sir F. W. Dyson, 682
- Reparation Act, The: and Scientific Research, Prof. J. R. Partington, 394; Hon. H. Onslow, 457; J. S. Dunkerly, 427; and the Cost of German Publications, Prof. J. Stanley Gardiner, 359
- Rhynchodemus Scharffi*, An Addition to the British Fauna, Prof. A. Dendy, 298
- Science: and Civilisation, Capt. B. J. Marden, 623; E. Henderson Smith and Major A. G. Church, 684; Dr. C. V. Drysdale, 715; and Technology in Palestine, Daisy L. Adler, 458; The Neglect of, Prof. S. J. Hickson, 779; Transcendental Premises in, Sir Henry H. Howorth, 9
- Scientific Research, The Reparation Act and, Prof. J. R. Partington, 394; J. S. Dunkerly, 427; Hon. H. Onslow, 457
- Sexual Organs of Phytophthora, Prof. G. H. Pethybridge, 204
- Sheep, Gold-coloured Teeth of, W. J. L. Abbott, 459
- Sodium Vapour, The Electrodeless Discharge in, Prof. J. K. Robertson, 269
- Solar Eclipse Results and the Principle of Relativity, C. E. Stromeyer; Sir F. W. Dyson, 682
- Solar Radiation in Relation to Faculae, H. H. Clayton, 108
- Sound Transmitted through Earth, R. G. Durrant, 140
- Sources and Sinks, A. F. Dufton, 522; Dr. H. S. Allen, 622
- "Space": or "Æther," Prof. A. S. Eddington, 201; Dr. Norman R. Campbell; L. C. W. Bonacina, 234; The Concept of, in Physics, Dr. H. Jeffreys, 267; The Physical Continuity of, L. C. W. Bonacina, 300; Commdr. J. G. McHardy, 360; The Physical Status of, Dr. H. Jeffreys, 394; L. C. W. Bonacina, 459
- Spectral Lines: The Deviation of, Relativity and, Prof. H. J. Priestley, 43; The Displacement of, by a Gravitational Field, Prof. H. J. Priestley, 585
- Spectral Series, Doublets in, D. Rogestvensky, 203
- Doublets in, D. Rogestvensky, 203
- Stellar Atmospheres, The Stationary H- and K-lines of Calcium in, Prof. Megh Nad Saha, 488
- Sun-spot Group, The Great, and Magnetic Disturbances, May 8-21, Father A. L. Cortie, 426
- Superannuation Systems, American and British, W. Palin Elderton, 651; Dr. J. W. Evans; W. Palin Elderton, 683
- Swallows, Scarcity of, A. Pride, 779
- Tails, Human and other, Prof. F. Wood Jones; Sir A. Keith, 487
- Tides, Ocean, A. C. Tennant, 299; Prof. J. Proudman, 300; H. A. Marmer, 393
- Timbers, Commercial, Scientific Names for, R. T. Baker, 45
- Time-intervals, Short, The Measurement of Single and Successive, Prof. A. Pollard, 585
- Tools of Mousterian Age, A "New" Type of, Prof. C. G. Seligman, 330
- Underground Water, The Drought and, B. Hobson, 684
- Vacuole, The Contractile, Prof. W. M. Bayliss, 810
- Variegation in a Fern, Dr. W. Bateson, 233
- Vector Analysis, Symbols in, R. H. Nisbet, 362
- Vegetation around London earlier than in the Provinces, C. Harding, 269
- Vision, The Theory of, Dr. F. W. Edridge-Green, 361
- Vitamines, The Designation of, Prof. H. E. Armstrong, 72; Prof. A. Liversidge, 45
- Vowel Sounds, Nature of, C. de Wesendonk; Prof. E. W. Scripture, 12; Prof. C. V. Raman, 332; Prof. E. W. Scripture, 333
- Worms Die? Why do, Rev. H. Friend, 172; G. T. Harris, 269; W. J. L. Abbott, 490; J. H. Coste, 491
- Wrightson's Hypothesis of Audition, Dr. H. Hartridge, 811
- X-ray Structure of Potassium Cyanide, The, P. A. Cooper, 745
- X-rays and their Physiological Effects, A. B. Bruce, 140
- Young's Interference Experiment, Dr. R. A. Houston, 268; Lord Rayleigh, 298; Prof. P. N. Ghosh, 362; and the Spectrometer, Prof. J. K. Robertson, 457
- Zinc, Metallic, The Production of, Sir R. A. S. Redmayne; The Writer of the Note, 361
- Corundum in the Northern and Eastern Transvaal, A. D. Hall, 794
- Cosmic Evolution, Prof. J. E. Boodin, 126
- Cosmogony and Stellar Evolution, J. H. Jeans, 557, 588
- Cotton-growing: in the British Empire, Grant by the Government for Fostering, 467; Proposed Register of Qualified Men for the Development of, 244
- Cotton Hairs, Method of Cutting Sections of, H. J. Denham, 299; Dr. W. L. Balls and H. A. Hancock, 361
- Credulity, Modern, 705
- Cretaceous-Tertiary Boundary in North America, The, Prof. A. C. Seward, 282

Crinoids: Studies in the Development of, Dr. Th. Mortensen, 132; The Embryology of, Dr. F. A. Bather, 132
 Crocodile River Iron Deposits, Nature and Origin of the, P. A. Wagner, 795
 Cromer: An Early Chellean Palaeolithic Workshop-site at, J. Reid Moir and others, 406; Flints Found at, Colour of, W. J. L. Abbott, 599
 Croonian Lecture of the Royal Society, Dr. H. Head, 350
 Crop Production, The Chemistry of, Prof. T. B. Wood, 101
 Cryptogamic Diseases of Plants, The Use of Coloured Screens for Fighting against, R. Lance, 447
 Crystal Measurement, Prof. H. Hilton, 605
 Crystalline: Medium, The Vibrations of a, Prof. H. Hilton, 189; Solids, The Influence of Physical Conditions on the Velocity of Decomposition of Certain, C. N. Hinshelwood and E. J. Bowen, 285
 Crystals: Biaxial, Conical Refraction in, Prof. C. V. Raman, 747; in Schools, Practical Suggestions for the Study of, T. V. Barker, 54
 Cuckoo, The Deposition of Eggs by a, E. Chance, 215
 Cultivated Plants, The Natural History of, 430
 Cup and Ring Markings: C. Carus-Wilson, 523; G. Abbott, 652; C. Carus-Wilson, 715
 Currency-Bars, Iron, O. G. S. Crawford, 587
 Currents induced in a Cable by the Passage of a Mass of Magnetic Material over it, The, E. S. Bieler, 574
 Curves: Introduction to the Theory of, 388; Pure Algebraic, Prof. H. Hilton, 388
 Cushing Oil and Gas Field, Oklahoma, The, C. A. Beal, 216
 Cyanic Acid and Urea, Syntheses of, by the Oxidation in Alcoholic Ammoniacal Solution of Phenols and Aldehydes, R. Fosse and G. Laude, 191
 Cyclones, The Energy of, Prof. G. von Hann, 11
 Cyrenaica: Geology of, 1, Eocene Strata, G. Stefanini, 478

Dairy Thermometers, The Origin of "Churning at 62°" on, R. Hedger Wallace; Pastorelli and Rapkin, Ltd.; Dr. W. Goodwin, 268; A. C. Cossor and Son, 362
 Dalton, John, L. J. Neville-Polley, 678; and Atomic Symbols, Prof. M. Delacre, 440
 Dame de l'érable," "La, L. Siret, 215
 Dangerous Drugs Act, 1920, Draft Regulations, 213
 Dante, The Cosmology of, Dr. J. L. E. Dreyer, 428
 Daphnia, Breeding Experiments with, Prof. W. E. Agar, 245
 Darino, or Protective Figures on Houses in British New Guinea, Dr. G. Landtman, 116
 Dark Nebulae, Dr. A. C. D. Crommelin, 464
 Datura, The Teratology of the Genus, Prof. G. B. Detoni, 92
 Dead, Celestial and Terrestrial Orientation of the, Prof. H. J. Rose, 538

DEATHS.

Appellöf (A.), 114
 Blichfeldt (S. H.), 148
 Blomfield (Dr. J. E.), 721
 Blount (B.), 242; 306
 Blyth (A. Wynter), 213
 Bowditch (C. P.), 659
 Brooks (Prof. W. R.), 340
 Bruce (Dr. W. Ironside), 148
 Burnham (Prof. S. W.), 212
 Burroughs (J.), 148; 177
 Cameron (Sir Charles Alexander), 51
 Carpentier (J.), 790
 Cholodkovsky (Prof. N. A.), 820
 Clifton (Prof. R. B.), 18
 Cory (C. B.), 820
 Crocker (Prof. F. B.), 721
 Cushing (Dr. H. P.), 341
 Czaplicka (Miss), 466
 Dale (Sir Alfred W. W.), 790
 Dennett (R. E.), 434; 529
 Fernald (Prof. C. H.), 114
 Field (Dr. H. H.), 242
 Fisher (S.), 213
 Fowler (W. Warde), 528

Gatehouse (T. E.), 213
 Grover (C.), 20
 Harmand (Dr. J.), 341
 Hawkshaw (J. C.), 20
 Herschel (Col. John), 466
 Hinds (Dr. J. I. D.), 277
 Humbert (G.), 84
 Ijima (Prof. I.), 277
 Keith (J.), 51
 Kellas (Dr. A. M.), 498; 560
 Kikuchi (Baron T.), 83
 Ladd (Prof. G. T.), 755
 von Lang (Prof. V.), 597
 Le Sueur (H. R.), 658
 Lippmann (Prof. G.), 659; 788
 Longstaff (Dr. G. B.), 401
 Malloch (P. D.), 498
 Menzies (Prof. J. A.), 650
 Miall (Prof. L. C.), 16-18
 Mills (Dr. E. J.), 306, 432
 Miyake (Prof. T.), 148
 Moulton (Lord), 50; 82
 Nathorst (Prof. A. G.), 112
 Odling (Prof. W.), 19
 Payn (H.), 242
 Perrier (Prof. E.), 721; 819
 Pye-Smith (Prof. R. J.), 178
 Ransom (H. B.), 114
 Reay (Lord), 720
 Reinold (Prof. A. W.), 242, 276
 Rolfe (R. A.), 242, 276
 Rolston (Capt. W. E.), 789
 Rosa (Prof. E. B.), 401, 465
 Rowell (Sir Herbert B.), 658
 Savage (Sir George), 658
 Semon (Sir Felix), 50
 Shackleton (W.), 561
 Simmons (A. T.), 820
 Skiff (Dr. F. J. V.), 148
 Stone (Dr. W. E.), 721
 Taylor (W.), 721
 Thayer (A. H.), 596
 Varley (S. A.), 789
 Vernon (Dr. R. H.), 242
 Waldeyer (Prof. H. W. G. von), 368
 Webb (Sir Arthur Lewis), 114
 Whitney (Mary Watson), 20
 Wright (Dr. G. F.), 433
 Wrightson (Sir Thomas), 530

Decapod Crustacea, Distribution of Copper in the Blood and "Liver" of the, R. Elmhirst and Dr. J. H. Paul, 151; Crustaceans, The Mouth-parts of Certain, L. A. Borradaile, 509
 Deformation and Force, Relation between, Dr. P. G. Nutting, 633
 Dentistry, Operative, Principles and Practice of, Dr. J. S. Marshall. Fifth edition, 484
 Desensitising Photographic Plates, A. and L. Lumière and A. Seyewetz, 633
 Desmid Flora of a Small Area in East Devon, G. T. Harris, 404
 Des Moines, Iowa, Municipal Observatory at, Opening of the, 821
 Dewalquea in the Core of the Bore made at Washing Bay, Co. Tyrone, The Occurrence of, Prof. T. Johnson and Miss J. G. Gilmore, 477
 Dewey Decimal System, Extension of the, by the Radio Laboratory of the U.S. Bureau of Standards, 372
 Diary, A Last, W. N. P. Barbellion, 743
 Dictyokinesis in Germ-cells, or the Distribution of the Golgi Apparatus during Cell-division, R. J. Ludford and J. B. Gatenby, 509
 Dielectrics, The Electrical Conductivity of Some, H. H. Poole, 253
 Diffuse Radiation of the Sky compared with the direct Solar Radiation, J. Vallot, 446
 Diffusion of certain Saturated Solutions, The Coefficient of, B. W. Clack, 445

- Dimethyl Oxalate, Decomposition of, by Acetic Acid, Dr. E. E. Turner and F. H. H. Wilson, 832
- Diospyros, A New Species and a New Variety of, W. P. Hiern, 640
- Diplotaxis erucoides*, Radical Bacilli of, R. Perotto, 127
- Diptera (iii), C. G. Lamb, 413; Found in Association with Termites, Some, G. F. Hill, 799; Secondary Sexual Characters in the, with a Description of a Novel Type, C. G. Lamb, 509; Venational Abnormalities in, C. G. Lamb, 189
- Direction-finding Wireless and Marine Navigation, J. J. Bennett, 303
- Disease, The Fight against, 308
- Dissolved Salts in Dilute Solution, The Variation of the Specific Refraction of, C. Chénevaux, 575
- Divers, The Biological Study of, A. Theoris, 607
- Double: Pendulum, A New Theorem on the, H. S. Rowell, 684; Surface Layer, Potential of a, M. Picone, 478
- Doublets in Spectral Series, D. Rogestvensky, 203
- Douglas Fir, A Fungoid Disease of the, Dr. D. Wilson, 437
- Dragon-flies, The Soaring Flight of, Dr. E. H. Hankin, 509
- Drosophila, The North American Species of, Dr. A. H. Sturtevant, 743; *virilis*, Sterility of Mutant Hybrids in, C. W. Metz, 223
- Drought, The, and Underground Water, B. Hobson, 684
- Droughts, Great British, C. Harding, 627
- Drugs, Synthetic, The Chemistry of, Dr. P. May. Third edition, 423
- Dubiago Comet, 1921, 373; Dr. Stevenson, 405, 471; A. Schaumasse, 542
- Dublin University, Conferment of Honorary Degrees upon Prof. W. M. Bayliss, Prof. E. Borel, and Prof. A. A. Michelson, 91; D. Clark, appointed Professor of Civil Engineering at Trinity College; Conferment of Degrees, 603
- Duck, Development of the Feathers of the, during the Incubation Period, Miss Augusta Lamont, 639
- Durance, The Presence of a Sub-alluvial Sheet of Thermal or Mineralised Water in the Bed of the, W. Kilian and F. Blanchet, 639
- Durham University, Impending Conferment of Honorary Degrees upon Sir E. H. W. Tennyson d'Eyncourt and Prof. A. Meek, 91; Conferment and Proposed Conferment of Degrees, 604; Conferment of Honorary Degrees, 700
- Dust from Coal-mines, Apparatus for Testing, S. R. Illingworth, 87
- Dye-making Industry, Appointment of a Committee to Advise the Board of Trade with respect to the Development of the, 629
- Dyes: and Dyeing, Prof. J. Huebner, 421; and Dyestuffs, British, 673
- Dyestuffs: Application of, to Textiles, Paper, Leather, and other Materials, Dr. J. M. Matthews, 421; British, Corporation, 162
- Dynamics: Elementary, A Text-book for Engineers, J. W. Landon, 134; of Golf Balls, 207
- Ear, Diseases of the, Dr. P. D. Kerrison. Second edition, 743
- Earth: Cooling of the, Certain Geological Effects of the, Dr. H. Jeffreys, 445; The Figure of the, Prof. T. J. J. See, 601; Pressure, Theories of, A. L. Bell, 596
- Earthquake: in Asmara, Eritrea, 823; in China, of December 16, 21; of October 3, 1920, P. Glangeaud, 94; Shocks, Recent, 370; The Chinese, of December 16, 1920, Dr. C. Davison, 473
- Earthquakes registered at the De Bilt Observatory, 216
- Earth's Crust: A Superior Limit to the Age of the, Prof. H. N. Russell, 125; Chemistry of the, Dr. H. T. Washington, 693
- Earthworms: Drowned in Puddles, Sir E. Ray Lankester, 329; J. H. Coste, 360; R. B. Marston, 779; Mud-worms, and Water-worms, Sir E. Ray Lankester, 424
- Easter Island, Carved Rocks and Stone Houses on, Mrs. S. Routledge, 564
- Eastern North America, Nature of Palæozoic Crustal Instability in, Dr. C. Schuchert, 501
- Echinoderm Fauna of Torres Strait, The, Dr. H. L. Clark, 712
- Echinus miliaris*, the Plutei of, Reversal of Asymmetry in, H. Ohshima, 125
- Eclipse: of Rhea by Titan, 345; The Annular, of April 8, Major W. J. S. Lockyer, 303
- Eddy Current Losses in Cylindrical Conductors, with Special Applications to the Alternating Current Resistances of Short Coils, S. Butterworth, 573
- Edinburgh University: The Prof. Tait Memorial, 90; Dr. H. S. Allen, appointed Reader in Physics; Dr. R. Campbell, Reader in Petrology; and Dr. L. Dobbin, Reader in Chemistry, 411; Resignation of Dr. Beard as Lecturer in Comparative Embryology, and of Dr. Balsillie as Lecturer in Chemistry, 411; Bequest to, by Dr. H. Barnes, 637; Conferment of Degrees, 669
- Education: and World Citizenship: An Essay towards a Science of Education, J. C. M. Garnett, 386, 707; as a Science, 386; Scientific Study of, The Need for the, Prof. A. Mackie, 442; The Encyclopædia and Dictionary of, part i., 103
- Educational Associations, Ninth Annual Conference of, Report of the, held at University College, London, 1921, 231
- Egg-colour and Broodiness in Poultry, Inheritance of, Prof. Punnett and the late Major P. G. Bailey, 85
- Egypt: British School in, Work of the, Prof. W. M. F. Petrie, 564; Sumer and, Early Chronology of, Prof. S. Langdon, 315; The Development of the Oil Resources of, E. M. Dowson, 502
- Egyptian: Neogene Echinoderms, R. Fourtau, 86; Survivals, Ancient, in Modern Egypt, Prof. C. G. Seligman, 27
- Eiffel Tower, Simultaneous Oscillations of the Pressure and Wind at the Top of the, R. Dongier, 510
- Einstein Spectral Shift, Investigation of the, A. Perot, 182
- Einstein's Gravitational Theory, A Difficulty in, G. W. Walker, 169; Prof. A. S. Eddington, 170
- Elasticity, The Case of Poincaré in the Theory of, E. Jouguet, 30
- Elder Edda, The, and Ancient Scandinavian Drama, Dr. Bertha S. Phillpotts, 168
- Electric: Current, The Theory of the Analysis of an, by Periodic Interruption, Dr. G. Barlow, 574; Discharge in Hydrogen at Low Pressures, The Minimum Potential of, E. Dubois, 799; Furnaces, A. Gallenkamp and Co.'s Revised Catalogue of, 182; Spark, The Brightness of the, L. Bull, 253; Traction in connection with Heavy Railway Work, Sir Philip Dawson, 181
- Electrical: and Mechanical Methods of Connecting the Propellers of a Ship with the Steam Turbines, comparison of the, L. Jauch, 724; Conductivity of Glass, The Nature of the, H. H. Poole, 584; Disturbances, The Recent Magnetic and, Dr. C. Chree, 399; Engineers, Institution of, Granting of a Royal Charter for the, 821; Theory and Relativity, 133
- Electrician's Pocket Book for 1921, The Practical, Edited by H. T. Crewe, 232
- Electricity: and Magnetism, Elements of the Mathematical Theory of, Sir J. J. Thomson. Fifth edition, 647; The Mathematical Theory of, J. H. Jeans. Fourth edition, 133; Inquiry, The London, 609; Technical, An Introduction to, S. G. Starling, 296
- Electrified Pith Ball in an Ionised Atmosphere, Behaviour of an, Dr. D. Turner and D. M. R. Crombie, 381
- Electro-crystalline Properties as conditioned by Atomic Lattices, Sir Joseph Larmor, 125
- Electroculture, Height and Spacing of Wires in, Dr. C. Chree, 632
- Electrodeless Discharge in Sodium Vapour, The, Prof. J. K. Robertson, 269
- Electro-magnetism, Oersted—the Discoverer of, 492
- Electron: Emission, Effect of, on the Temperature of the Filament, and Anode of a Thermionic Valve, G. Stead, 216; in the Atom of Mercury, The Normal Orbit of the, A. Terenin, 203; The Gravitational Field of an, Sir Oliver Lodge, 392
- Electrons: Sir William Bragg, 79, 109; Ether Waves and, Sir William Bragg, 374; Light and, Sir Oliver Lodge, 169; Prof. J. Joly, 203

- Electrostatic Principle, New Technical Applications of an, A. Johnsen and K. Rahbek, 439
- Electrotherapy, History of, H. Colwell, 150
- Elements, The Disintegration of, by α -Particles, Sir Ernest Rutherford and J. Chadwick, 41
- Empire Cotton Growing Corporation, Grant by the Government to the, 499
- Emulsoid Colloid State, The Nature of the, Dr. S. E. Sheppard, 73; Prof. J. W. McBain, 74
- Enchytræidæ, The Genera of the, Welch, 179
- Encke's Comet, Detection of, J. F. Skjellerup, 825
- Energétique Générale, Dr. F. Michaud, 455
- Energy: Quantum, A Physical Interpretation of the, I. Aucken, 553; Molecular Structure and, Prof. J. R. Partington, 172; Prof. A. O. Rankine, 203
- Engineers: American and British, Conference of, 594; and Architects, Education of, The Present System of, M. E. Kernot, 441
- Entomological Meeting, Third, held at Pusa on the 3rd to 15th February, 1915, Report of the Proceedings of the, Edited by T. B. Fletcher, 3 vols., 455
- Environment, Some Effects of, on Efficiency and Safety, Wilson, 567
- Enzyme Action, The Nature of, Prof. W. M. Bayliss. Fourth edition, 232
- Enzymes, Action of, v., D. Maestrini, 128
- Enzymic and Zymic Change, The Particulate Nature of, Prof. H. E. Armstrong, 698
- "Eolith" Factory, A Natural, beneath the Thanet Sand, S. H. Warren, 565
- Epidemics, Experimental, Produced in Colonies of Mice, Dr. S. Flexner, 540
- Epistemological Problem, The, Prof. H. Wildon Carr, 228
- Epsom College, Bequest to, by Dr. H. Barnes, 637
- Equation $UV = -f^2$, Prof. M. A. R. Khan, 309
- Equilibrium, The Law of, of Solid Grains in a Vertical Ascending Current of Water, R. Feret, 158
- Eros: The Minor Planet, F. E. Seagrave, 663; The Ephemeris of, Continuation of, F. E. Seagrave, 793
- Errera, Léo, Recueil de l'Institut Botanique, Tome iv., 6
- Eskers in the Vicinity of Rochester, New York, A. W. Giles, 533
- Ethology, The Practical Value of, Dr. A. C. Haddon, 500
- Ethyl Naphthoate, The Reduction of, etc., H. de Pomereau, 607
- Ethylpropylphenylcarbinol, Synthesis and Dehydration of, V. Yéramian, 831
- Etoiles Simples, Les, Dr. F. Henroteau, 583
- Eugenics, International Congress of, Forthcoming, 115
- Europe: The Present Status and Tendencies of Geography in, W. L. G. Joerg to Study, 434; The Treaty Settlement of, Prof. H. J. Fleure, 660
- Eustheniidae, Revision of the Family (order Perlaria), with Descriptions of New Genera and Species, Dr. R. J. Tillyard, 800
- Evaporation: Concentration, and Desiccation of Organic or Mineral Substances, A Method of, A. Sartory, L. Scheffler, P. Pellissier, and C. Vaucher, 222; from Large Expanses of Water, Some Problems connected with, M. A. Giblett, 541; The Mechanism of the Energy Exchanges in, R. Audubert, 62
- Everest: Mount, The Ascent of, Sir Francis Younghusband and Prof. J. N. Collie, 12; The Route to, Lt.-Col. C. H. Bury, 52; Lt.-Col. H. H. Godwin-Austen, 137; Expedition, Progress of the, 822
- Evolution: Initiative in, Dr. W. Kidd, 419; Irreversible, The Law of, Dr. B. Petronievs, 501; Insect, The Fundamental Factor of, S. S. Chetverikov, 501; Mutations and, Prof. R. R. Gates, 636; Prof. R. R. Gates, 714; The Writer of the Article, 715
- Explosions, The Thermodynamical Theory of, i., Sir J. B. Henderson; ii., Sir J. B. Henderson and Prof. H. R. Hassé, 573
- Explosives, Some War Developments of, Sir Robert Robertson, 524
- Eyes Radiate Energy? "Can, Dr. C. Russ, 535
- Fabre Anthology, A, 101
- Fabricated Ships, M. E. Denny; J. C. Telford, 596
- Factories, Chief Inspector of, Report of the, for 1920, 755
- Faculae, Solar Radiation in Relation to, H. H. Clayton, 108
- Falmouth Observatory, Meteorological Results for 1920 at the, 662
- Faraday, The Law of, and the Action of the Silent Electric Discharge on the Metallic Oxides, A. de Hemptinne, 703
- Farm: Crops, Bacterial Diseases of, 155; Stock, The Breeding and Feeding of, J. Wilson, 678
- Farmer's Handbook, A, A Manual for Students and Beginners, R. C. Andrew, 679
- Farmyard Manure, Artificial, Hutchinson and Richards, 828
- Fatigue: and Efficiency in the Iron and Steel Industry, Dr. H. M. Vernon, 156; Effect of, on Health and Longevity, Dr. H. M. Vernon and E. A. Rusher, 156
- Fatty Acids from Natural Hydrocarbons of the Paraffin Type, 181
- Faults, Know Your, R. D. Oldham, 92
- Fauna of Scottish Lochs, The, Dr. N. Annandale, 778
- Faune de France, No. 1, Echinodermes, Prof. R. Kœhler, 776
- Feeding Experiments with Albino Rats, H. A. Cheplin and L. F. Rettger, 223
- Fern, Variegation in, Dr. W. Bateson, 233
- Ferro: -magnetic Induction, The Atomic Process in, Sir Alfred Ewing, 444; -nickels, The Action of Additions on the Expansion Anomaly of the, P. Chevenard, 159
- Filarial Diseases in the Tropics, Expedition to Investigate, 22
- Finsbury: School of Chemistry, The, Prof. G. T. Morgan, 154; Technical College, Continuance of the, 220; Correspondence Respecting the, between the City and Guilds Institute and the London County Council, 508; H. P. Philpot appointed Professor of Civil and Mechanical Engineering, and A. J. Hale Professor of Applied Chemistry at the, 830
- Fireball: Large Detonating, W. F. Denning, 153; of March 2, The, W. F. Denning, 88
- Fireballs, Recent Brilliant, W. F. Denning, 182
- Fish: Herons and, Sir Herbert Maxwell, 490; Kept in Tanks and Ponds, An Unrecognised Cause of Disease in, Dr. M. Plehn, 823; Preservation of, by Salt, The Principles Involved in the, H. F. Taylor, 692
- Fisheries, Agriculture and, in the Civil Service Estimates, 257
- Fishery Board for Scotland, Retirement of Dr. T. W. Fulton, 370
- Fishes: Shore, L. Fage, 796; Studies of, 796
- Flames, Reducing, The Principles of Analysis by Means of, J. Meunier, 191
- Flat-fishes, a symmetry, Metamorphosis, and Origin of, H. M. Kyle, 317
- Flax: Cultivated, The "Browning" and "Stem-break" Disease of, Caused by *Polyspora lini*, n. gen. et sp., H. A. Lafferty, 253; The Pollen of, and the Degenerescence of the Varieties Cultivated for the Fibre, L. Blaringhem, 640
- Flight: Dr. E. H. Hankin, 86; Hovering, Experimental Studies on, M. Idrac, 446
- Flights, A Series of, with a Free Helicopter, E. Oehmichen, 62
- Flint: An Unknown Organism in, C. Carus-Wilson, 290; Implement, A Remarkable, from Selsey Bill, Sir E. Ray Lankester, 61; A Remarkable, Sir E. Ray Lankester, 403; Implements in the Cromer Forest Bed, J. Reid Moir, 458; Organism in, Prof. G. A. J. Cole, 333; C. Carus-Wilson, 362
- Floral Morphology, Studies in, No. ii., Dr. J. M'L. Thompson, 93
- Flow, The Criterion for Stable, of a Fluid in a Uniform Channel, Dr. H. Levy, 666
- Flowering Plants of South Africa, The, Edited by Dr. I. B. Pole Evans. Vol. i., No. i., 40
- Fluid Motion, The Stability of, Prof. T. H. Havelock, 29
- Flying-fish: The "Flight" of, Sir David Wilson-Barker; Prof. F. Wood-Jones, 233; J. S. Huxley, 267; Prof. W. Galloway, 376; H. H. Clayton, 714; Dr. E. H. Hankin, 707
- Focal: Depth, Problem of Finite, revealed by Seismometers,

- G. W. Walker, 412; Lines formed by a Zone Plate, An Experiment on, Dr. G. F. C. Searle, 126
- Fog, the Possibility of Dissipating, by Artificial Heating, Sir Napier Shaw, 118
- Food Anaphylaxy and its Therapeutics, W. K. Opaczewski, 543
- Foreign Scientific Literature, H. Richardson, 458
- Forest: Management of, Prof. A. B. Recknagel and Prof. J. Bentley, Jun., 326; Policy, The United States, Prof. J. Ise, 326; Products: Their Manufacture and Use, Prof. N. C. Brown, 326
- Forestry: British, The Progress of, 753; Commission, Report of the, 404; Education, Imperial, 315; in France, 548; in the United States, 326
- Fornander Collection of Hawaiian Antiquities and Folklore, A. Fornander. With translations. Edited and illustrated with notes by T. G. Thrum. Third series. Part iii., 391
- Forrest, The James, Lecture, Sir George Beilby, 597
- Fossil: Botany, Studies in, Dr. D. H. Scott. Third Edition. Vol i., *Pteridophyta*, 197; Plants from the Late Cretaceous of Tennessee, E. W. Berry, 94
- Fossils, The Value of the Statistics of Variation for the Study of, Dr. H. Klähn, 215
- Fowler: W. Warde, A Personal Appreciation, H. E. A., 551
- Fox, The Common, in Australia, as a Source of Revenue, G. A. Keatland, 53
- France, Collège de, Prof. H. Lebesque appointed Professor of Mathematics at the, 830
- Franklin Institute, Presentation of the Franklin Medal and Certificate of Honorary Membership of the, to Prof. C. Fabry, and F. J. Sprague, 369
- Free Will and Destiny, St. George Lane-Fox Pitt, With Open Letter on the International Moral Education Congress and League of Nations, Sir Frederick Pollock; and Appendix, F. J. Gould, 35
- French Academy of Medicine, Election of Foreign Correspondents, 755; Chemical Society, Sir William J. Pope elected Membre d'Honneur of the, 21; Chemists and the War, Sir T. E. Thorpe, 516; Forestry, Studies in, T. S. Woolsey, Jun., with two chapters by W. B. Greeley, 548; Société de Géographie, Centenary of the, 598; Turpentine, The Composition of, M. Vèzes, 351
- Frequencies, A Method of Measuring, B. S. Smith and G. F. Partridge, 350
- Friendship (To T. H. R.), Prof. W. Garstang, 594
- Fritz, John, Gold Medal: awarded to Sir Robert Hadfield, 21; awarded to Mr. Schneider, 530; Origin of the Institution of the, 403; presentation of the, to Sir Robert Hadfield, 595; Sir Robert Hadfield's address of thanks on receiving the, 629
- Fuel: -cell, The Problem of the, E. K. Rideal and N. R. Evans, 381; Oil, W. A. White, 119; The Use of, 385; Situation, The World's, Sir George Beilby, 597
- Fungi, Formation of a Collection of Types of, at the Lister Institute, 563
- Galleria mellonella*, The Prolongation of Life in, L. Destouches, 351
- Galvanometer Records, A Method of Analysing, W. Hartree and Prof. A. V. Hill, 318
- Galvanometric Measurement of Human Emotion, Dr. A. D. Waller, 183
- Garden Doctor, The, Plants in Health and Disease, F. J. Chittenden, 40
- Gardening for the Sub-tropics, A Book of, Mary Stout and Madeline Agar, 232
- Gas: Connection between the Equation of State of a, and the Specific Heats of the Gas, Prof. A. G. Webster, 565; The Disappearance of, when an Electric Discharge is Passed through Exhausted Tubes, Dr. N. R. Campbell, 793; The Adsorption of, by Charcoal, Silica, and other Substances, Prof. H. Briggs, 285; Under Pressure, Prof. H. Briggs, 638; Pressure, Origin of Petroleum, and cause of, 347
- Gaseous: Cyanogen, The Viscosity and Molecular Dimensions of, Dr. A. O. Rankine, 412; Ions, The Measurement of the Mobility of, by the Toothed-wheel method, M. Laporte, 382; Mass with Time, An Automatic Apparatus for Recording the Variations of a, A. A. Guntz, 319
- Gases: A Method for the Micro-analysis of, by the Use of the Pirani Pressure Gauge, Research Staff of the General Electric Co., Ltd., 477; and Liquids, The Rate of Reaction between, A. Simple Apparatus for Observing, H. G. Becker, 477; The Dynamical Theory of, J. H. Jeans. Third edition, 804
- Gault and Lower Greensand, The Junction of, near Leighton Buzzard, G. W. Lamplugh, 476
- Genetics of Cereals, 250
- Geo-chemistry, A Study in, Prof. H. Louis, 581
- Geographical Place-names, Royal Geographical Society Tests of, 693
- Geographical Problems of To-day and the Status of Geography in Science, Sir Douglas Mawson, 441
- Geography, Economic, The Principles of, Dr. R. N. Rudmose Brown, 774; Human, Principles of, E. Huntington and S. W. Cushing, 774; in British Universities, The Position of, Sir John Scott Keltie, 502
- Geological: Literature added to the Geological Society's Library, 793; Map-reading, Notes on, A. Harker, 294; Marks, First Steps in the Systematic Arrangement of, A. Issel, 351; Sections through the Andes of Peru and Bolivia. III.: From Callao to the River Perene, J. A. Douglas, 350; Survey, Memoirs of the, Special Reports on the Mineral Resources of Great Britain. Vols. xii. and xiii., Iron Ores (continued), 261
- Geologie: des Meeresbodens; Band ii., Prof. K. André, 292; Regionalen, Handbuch der, Herausgegeben von Prof. G. Steinmann und O. Wilckens. 20 Heft, iii. Band, 1 Abteilung. The British Isles: The Channel Islands, by Thirteen Contributors. Local editor, Dr. J. W. Evans, 355
- Geology: and Ore Deposits of Ely, Nevada, The A. C. Spencer, 117; Palæontology of the Raton Mesa and other Regions in Colorado and New Mexico, W. T. Lee and F. H. Knowlton, 282; Water Resources of Big Smoky, Clayton, and Alkali Spring Valleys, Nevada, O. E. Meinzer, 406; Regional, 827
- Geometrical Isomerism in Monomolecular Films, N. K. Adam, 522
- Geometry: Experimental, Dr. Norman R. Campbell, 301; Modern, The Straight Line and Circle, C. V. Durell, 616; Plane, The Elements of, Dr. C. Davison, 134; The School, Matriculation Edition, W. P. Workman and A. G. Cracknell, 616
- Geophysical: Observatory at Apia, Report on the, Dr. C. E. Adams and Prof. E. Marsden, 152; Problems, Dr. C. F. Marvin, and others, 730
- German: British and, Volumetric Glassware, A Comparison of, Sir J. E. Petavel, 297; Men of Science, Death of, Since the Beginning of the War, 755; Publications, Cost of, The Reparations Act and, Prof. J. Stanley Gardiner, 359; Difficulty of Obtaining, by Reason of the Operations of the Reparations Act, 630
- Gibbelula Haygarthii*, A Fungus, sp. n., on a Spider of the Family Lycosidæ, P. A. van der Bijl, 607
- Gibson, William, Research Scholarship for Medical Women, Award of the, to Miss Gertrude M. A. Herzfeld, 540
- Gilbert Islands: From Birth to Death in the, A. Grimble, 374; The Natives of the, 374
- Giver, A Great, Sir E. Ray Lankester, 2
- Glaciers, Depth of, i., C. Somigliana, 703
- Glasgow University: Gifts and Bequests to, 91; Honorary Degrees to be Conferred upon L. Binyon, Sir Dugald Clerk, and Principal J. C. Irvine, 349; Impending Retirement of Sir John H. Biles; Bequests by the late W. J. Chrystal, 540; The Future Zoological Building of, 597; and the Royal Technical College, Bequests to, by W. J. Chrystal, 604; Grant from the Bellahouston Trustees; Approval of the Establishment of the Ordinary Degree of B.Sc. in Pure Science; A. Stevens appointed Lecturer in Geography; Prof. F. O. Bower appointed a Governor of the West of Scotland Agricultural College; Building Operations of the New Institute of Zoology Begun; Recognition of the School of Pharmacy, 669
- Glass: Compressed, The Double Refraction of, M. and

- Mme. E. Henriot, 607; Technology, Society of, Annual General Meeting of the, Dr. M. W. Travers elected President, 404; the Electrical Conductivity of, The Nature of, H. H. Poole, 584
- Glassware: British Laboratory and Scientific, J. H. Davidson, 331; used in Dairy Chemistry, Tests on Volumetric, 663; Volumetric, A Comparison of British and German, Sir J. E. Petavel, 297
- Globular Clusters, The Distances of the, Dr. H. Shapley and Prof. H. D. Curtis, 825
- Glossopteris angustifolia*, Brongn., The Cuticular Structure of, B. Sahni, 671
- Glucose: Detecting, A Method allowing the Application to Plants of the Biochemical Method of, M. Bridel and R. Arnold, 575; The Electrolytic Reduction of, Prof. A. Findlay and V. H. Williams, 252
- Glucosides in some Indigenous Orchids, Extraction of the, P. Delauney, 94
- Glutaric Nitrile, The Action of the Organo-magnesium Compounds on, P. Bruylants, 703
- Gnats, the Destruction of, High-speed Aircraft Propellers and, H. C. Watts, 269
- Gold: -coloured Teeth of Sheep, 249; W. J. L. Abbott, 459; Sols, The Coagulation Velocity of, A Simple Apparatus for determining, E. Hatschek, 702
- Golf Balls, Dynamics of, 207
- Grorse-seed, Vitality of, J. Parkin, 491
- Goshen, The Land of, and the Exodus, Sir Hanbury Brown. Third edition, 679
- Grain Pests (War) Committee, Final Report, Prof. W. A. Herdman, 180
- Granite-gneisses of Southern Eyre Peninsula (South Australia) and their Associated Amphibolites, C. E. Tilley, 29
- Graphical and Mechanical Computation, Dr. J. Lipka, 616
- Graphite, Foreign, in 1919, A. H. Redfield, 795
- Gravitation, Relativity and, 742
- Gravitational Relativity, Remarks on, Sir Oliver Lodge, 814
- Great Inheritance: New Studies of a, Being Lectures on the Modern Worth of some Ancient Writers, Prof. R. S. Conway, 744
- Greenland: Ancient Skulls from, W. E. Le Gros Clark, 532; in Europe, D. MacRitchie, 141; The Need of the Establishment of a High-power Radio-telegraphic Station in, 402
- Green-plant Matter as a "Decoy" for Actinomyces Scabies in the Soil, W. A. Millard, 318
- Greenwich Observatory: Visit of the Crown Prince of Japan to, 369; Visitation of the, 472
- Gregarious Instinct, Protozoa and the Evolution of the, R. J. Ludford, 332
- Gresham's School Natural History Society, Annual Report of the, 791
- Grime's Graves, Norfolk, Discovery of Engravings at, A. L. Armstrong, 493
- Growth-rate, The Dynamics of a Fluctuating, H. S. Reed, 222
- Guinea-pigs, The Relative Importance of Heredity and Environment in Determining the Piebald Pattern of, S. Wright, 94
- Gun-fire, Distant, The Sound of: Father V. Schaffers, 44; C. Carus-Wilson; Dr. C. Davison, 108; Capt. C. J. P. Cave, 140
- Guthrie Lecture, The Sixth, of the Physical Society of London, Prof. A. A. Michelson, 220
- Gymnodinium pseudonociluca*, J. Pavillard, 287
- Gyroscopic Compass, The: A Non-mathematical Treatment, T. W. Chalmers, 328
- Haeckel's Biogenetic Law, Prof. W. Garstang, 542
- Hæmoglobin in Mollusca, Prof. A. E. Boycott, 395
- Hæmolytic Activity of Chemical Substances, A Method for Investigating the, E. Ponder, 509
- "Halo-blight" of Oats, C. Elliott, 155
- Harmonic Analysis: A. E. Clayton, 759; A Simple Apparatus for Approximate, and for Periodicity Measurements, Dr. W. L. Balls, 444
- Harvard Zoological Laboratory, Prof. G. H. Parker appointed Director of the, 244
- Hawaii, The Leguminous Plants of, J. F. Rock, 346
- Haxtoni*, The Production of, H. V. Harlan and H. K. Hayes, 251
- Health: and Longevity, Effect of Fatigue on, Dr. H. M. Vernon and E. A. Rusher, 156; and Physical Fitness, Testing and Grading of, Dr. A. A. Mumford, 30; and Work, Dr. C. S. Myers, 354
- Hearing: The Resonance Theory of, Dr. H. Hartridge, 204; Dr. W. Perrett, 301; Dr. H. Hartridge, 304; An Experiment which Favours, Dr. Hartridge, 446; Wrightson's Theory of, A Criticism of, Dr. Hartridge, 446
- Heath-fires, The Generation of, E. A. Martin, 811
- Heats of Combustion and Formation of Nitro-compounds, Part I., W. E. Garner and C. L. Abernethy, 158
- Hedgehog: Habits of the, 375; Dr. G. A. Auden, 491; carrying Fruits upon its Spines, The Ancient Legend as to the, M. Christy, 375
- Helicopters: A. Mallock, 553; A. R. Low, 622
- Helium Atom, The Constitution of the, E. C. Kemble, 662
- Herbertson Memorial Lecture of the Geographical Association, The Second, Dr. H. R. Mill, 214
- a-Herculis*, The Companion of, R. F. Sanford, 438
- Hérons and Fish, Sir Herbert Maxwell, 490
- Hill's, Dr., Cusped Orbit, 503
- Himalaya, A Naturalist in, Capt. R. W. G. Hingston, 210
- Historical Research in London, Institute of, 668
- Hittite Seals: With Particular Reference to the Ashmolean Collection, D. G. Hogarth, 70
- Hommes Fossiles: Les, *Eléments de Paléontologie Humaine*, Prof. M. Boule, 322
- Homogeneous Vibrations, The Quantum Theory and, Sir Arthur Schuster, 233
- Hong-Kong, Royal Observatory, Report for 1920 of the, Claxton, 824
- Hopkinson, Bertram, The Scientific Papers of, Collected and Arranged by Sir J. Alfred Ewing and Sir Joseph Larmor, 675
- Hot-wire Incliner, The, R. H. Humphry, 126
- Human: Embryo, A, Prof. Bryce, 180; Emotion, Galvanometric Measurement of, Dr. A. D. Waller, 183; Evolution, The Problem of, Prof. A. Dendy, 691; Palæontology, Prof. A. Keith, 322; Sciences, A Suggested Institute of, 769
- Humanities, The Place of the, in the Education of Men of Science, Prof. C. Desch, 655
- Huygens, Christiaan, *Œuvres Complètes de*, Tome Quatorzième. *Calcul des Probabilités. Travaux de Mathématiques Pures*, 1655-1666, 4
- Hydracarina, Species of, Occurring in Britain, C. D. Soar and W. Williamson, 150
- Hydraulic Mining Débris in the Sierra Nevada, Dr. G. K. Gilbert, 404
- Hydraulics*, *Journal of*, Proposed Issue of a, 437
- Hydrogen: -ion Concentration of Some Natural Waters, The, J. T. Saunders, 190; Ions, The Determination of, Dr. W. M. Clark, 772; The Manufacture of, for the Synthesis of Ammonia, G. Claude, 351
- Hydrogenation: by Platinum Black, Velocity of the Reaction in the, G. Vavon, 831; of some Marine Animal Oils, The, H. Marcelet, 734
- Hydrography of the Nile Basin, 90
- Hydroids of the Western Indian Ocean, The, Florence E. Jarvis, 413
- Hydrology of the Western States of North America, Dr. B. Cunningham, 406
- Hydrometers and Specific-gravity Instruments, Pastorelli and Rapkin's List of, 247
- Iberica*, 215
- Ibos of Nigeria, Among the, Rev. G. T. Basden, 495
- Ice in the Arctic Seas, Report for 1920 of the State of the, 216
- Ichneumonop-flies: of the Genus *Apanteles*, C. F. W. Muesebeck, 532; of the Tribe *Ephialtini*, R. A. Cushman, 532
- Icones Plantarum Formasanarum*, B. Hayata. Vol. ix., 346
- Idar State, India, Geology of, C. S. Middlemiss, 827
- Igneous Rocks: Chemical Analyses of, Dr. H. S. Washington, 151; of Encounter Bay, South Australia, The, W. R. Browne, 795

- Illuminating Engineering Society, Report of the, 470
 Illumination, International Commission on, the First Technical Session of the, 722
 Imbecility, Mongolian, Dr. F. G. Crookshank, 218
 Imperial: College of Science and Technology, Anonymous Gift for Scholarships, 123; New Chemical Laboratory opened by A. J. Balfour, 561; Large-scale Chemistry at the, 624; Forestry Education, 315
 Impressions and Comments. Second series, 1914-20, Havelock Ellis, 743
 Indexing, Co-operative, of Periodical Literature, 449; Dr. F. A. Bather; Prof. W. M. Flinders Petrie; Dr. J. W. Evans, 550; A. P. Newton, S. Gaselee, 551
 "Index-numbers" and Wages-regulation, 513
 India: and Burma, Pendulum Operations in; Capt. Couchman, 187; Hydro-electric Survey of. Vol. ii.: Second Report on the Water-power Resources of India, ascertained during the Season 1919-20 by F. E. Bull and J. W. Meares, 263; Institution of Engineers, Calcutta, Inauguration of the, 243; Meteorological Department of the Government of, Report of the, for 1919-20, 279; The Prehistoric Arts and Crafts of, P. Mitra, 630
 Indian: Agriculture, Dr. W. E. Brenchley, and others, 58; Botanical Society, Origin and Aims of the, 243; Educational Service, Appointments to the, 411; *Industries and Labour, Journal of*, No. i., 179; Infants, Weights at Birth of, Dr. D. F. Curjel, 757; Micro-lepidoptera, Life-histories of, T. B. Fletcher, 631; Oils, Some, Hydrolysis of, by Vegetable Lipase, N. A. Yajnik and H. C. Mahajan, 672; Tribes of Ecuador, Sociology of the, Dr. R. Karsten, 150; Village Site and Cemetery near Madisonville, Ohio, Excavation of an, 278
 Indigo Textile Hydrosulphite Vat-dyeing, Some Investigations on, N. A. Yajnik and D. R. Sarma, 671
 Indonesian Canoes, The Outriggers of, Dr. A. C. Haddon, 244
 Inductance, Small, Measurement of, F. B. Pidduck, 623
 Inductometers, Errors due to Capacity and Eddy-current Effects in, S. Butterworth, 632
 Industrial: Crisis in this Country, The, Sir Robert Hadfield, 342; Fatigue, Dr. C. S. Myers, 23; Hygiene, impending appointment of an International Committee on, 562; Research, F. B. Jewett, 121; Worker, The Health of the, Prof. E. L. Collis and Dr. M. Greenwood. Containing a Chapter on Reclamation of the Disabled, by Dr. A. J. Collis, 354
 Industries: Safeguarding of, 178; Bill, read a second time, 467
 Infection by the Air, Activity of, A. Trillat and R. Kaneko, 734
 Ingersoll Cement Gun, The, O. G. C. Drury, 596
 Insect: Adventures, J. H. Fabre, 101; Control in Flour Mills, E. A. Back, 309; Life, C. A. Ealand, 806; Oases, C. G. Lamb, 189
 Insects: in Relation to the Reproduction of Coniferous Trees, E. R. Speyer, 413; The Psychic Life of, E. L. Bouvier, 501
 Instinct: and the Unconscious: A Contribution to a Biological Theory of the Psycho-neuroses, Dr. W. H. R. Rivers, 515; in Man: A Contribution to the Psychology of Education, Dr. J. Drever. Second edition, 455
 Institute of Metals, Programme of the Autumn Meeting of the, 756
 Institute of Physics, The Inauguration of the, Speeches by Sir J. J. Thomson, and A. J. Balfour, 312
 Institution: of Civil Engineers, Election of Officers and Council of the, W. B. Worthington President, 370; of Mining and Metallurgy, Annual Report of the, 278
 Intelligence, The Annual Incidence of, and its Measurement by the American Army Tests, M. M'C. Fairgrieve, 601
 Interference: Bands, A Method of Projecting, Dr. Hartridge, 446; Methods, Recent Applications of, Prof. A. A. Michelson, 220; The Application of, to Astronomy, H. Spencer Jones, 685
 Interferometer for Testing Camera Lenses, An, F. Twyman, 635
 Intermolecular Condensations produced by Oxynitric Groups, G. Cusmano, 127
 International: Hydrographic Board, Establishment of an, 562; Organisation and Public Health, Dr. G. S. Buchanan, 150; Research Council, The, Sir Arthur Schuster, 72; Prof. G. H. Hardy, 107; Union against Tuberculosis, The Conference of the, 751
 Internationalism, 577
 Inulin, the Products of Fermentation Hydrolysis of, The Application of the Biochemical Method of Research on Glucose to the Study of, E. Bourquelot and M. Bridel, 350
 Inventions and Grants in Aid, 129
 Iodamidines, The, J. Bougault and P. Robin, 94
 Iodine: Electrode, The Potential of the, and the Activity of the Iodide Ion at 25° C., A. McKeown, 702; The Action of, on Different Metals in the Cold, C. Matignon, 127; -tellurium, The System, A. Damiens, 94
 Ionisation: Potential, The Atomic Radius and the, Prof. Megh Nad Saha, 682; and the Size of the Atom, Prof. A. S. Eve, 552; Spectrometer, Application of the, to the Determination of the Structure of Minute Crystals, Sir William Bragg, 253; The Influence of Solvent upon, and the accompanying Heat Effect, S. M. Neale, 702
 Ireland, the Geological Map of, 823
 Iron: -age Culture in the Balkan Peninsula, S. Casson, 500; and Associated Industries of Lorraine, etc., The, A. H. Brooks and M. F. La Croix, 631; and Steel Industry, Fatigue and Efficiency in the, Dr. H. M. Vernon, 156; Institute, Programme of the Paris Meeting of the, 821; The World's Hunger for, Sir Robert Hadfield, 596; Currency-bars, O. G. S. Crawford, 587; in Antiquity, Dr. J. N. Friend, 372; in Plants, The Distribution of, L. Maquenne and R. Cerighelli, 799; Ores: Bedded Ores of the Lias, Oolites, and Later Formations in England, G. W. Lamplugh, C. B. Wedd, and J. Pringle, 261; Pre-Carboniferous and Carboniferous Bedded Ores of England and Wales, Sir A. Strahan, Dr. W. Gibson, T. C. Cantrill, Dr. R. L. Sherlock, and H. Dewey, 261; The Resistivity of, The Influence of Welding on, E. L. Dupuy, 670
 Ironstone Beds of the Mornington Peninsula, Age of the, F. Chapman, 607
 Isatin 5-Sulphonic Acids, J. Martinet and O. Dornier, 31
 Isle of Wight: Disease in Hive Bees, Dr. J. Rennie, and others; Dr. A. D. Imms, 283; Short Account of the Geology of the, H. J. O. Wright, 827
 Isochronism, The Deviations from the Law of, Produced by the Suspension Strip of the Pendulum, P. Le Rolland, 190
 Isonzo Valley, Central, Geology of the, Dr. A. Winkler, 827
 Iso-thiocyanacetic Acid, Alkyl Amides of, T. B. Johnson, A. J. Hill, and E. B. Kelsey, 94
 Isotopes and Atomic Weights, Dr. F. W. Aston, 334; The Atomic Volume of, Prof. F. Soddy, 41; Their Number and Classification, Prof. W. D. Harkins, 202
 Italian: Engineering, Lectures on, by Prof. Luiggi, 60; Meteorites, Prof. W. M. Flinders Petrie, 301
 Italy, Agriculture in, A New Society for Scientific Work in, 149
 Japan, A Diplomat in, Rt. Hon. Sir Ernest Satow, 263
 Japanese Artificially Induced Pearl, The, Dr. H. Lyster Jameson, 396; Dr. W. Wingrave, 620; Dr. H. Lyster Jameson, 621
 Jersey, The Geology of, G. H. Plymen, 827
 Jerusalem, The Proposed University of, C. Crossland, 733; Literature for, Prof. S. Alexander I. M. Sieff, and D. B. Stanhill, 333
 Jivaro Indians, The Diminutive Shrunken Heads made by the, C. W. Mead, 823
 Jones, Thomas Wharton, Sir Rickman Godlee, 829
 Jordan's Nets for Making Models of Simple Crystal-forms, 794
 Julian's Chloride, The Formation of, in the Preparation of Electrolytic Chlorine, F. Bourion and Ch. Courtois, 542
 Jungle Book, A, 615
 Jupiter's: Four Great Satellites, Prof. W. de Sitter, Dr. A. J. Leckie, 663; Satellites, Theory of, Prof. Sampson, 405
 Jurassic Ammonites from Viñales, Western Cuba, Dr. Marjorie O'Connell, 631

- Kaolins and Clays, The Contraction on Drying of, A. Bigot, 222
- Kelvin Gold Medal for Engineering, The, presented to Dr. W. C. Unwin, 341; Lecture of the Institution of Electrical Engineers, The Twelfth, Sir William Bragg, 79
- Kent's Cavern, Rev J. MacEnery's Excavation Work at, H. J. Lowe, 758
- Kepler, W. W. Bryant, 713
- Keto-enolic Double Linkage, Additional Properties of the, H. Gault and R. Weick, 799
- Kilauea Volcano Observatory, Maintenance of the, 823
- Kinetic Theory, The, and the Quantum, 804
- King George V. Dock, London, The, 628
- Kodaikanal Observatory, Report of the, for 1920, 535
- Kurrajong Earthquake of August 15, 1919, The, Dr. L. A. Cotton, 832
- Laboratory Ware, British, and Chemicals, Prof. J. R. Partington and C. L. Bryant, 457
- Lac and Shellac: Industry in India, The, Dr. A. D. Imms, 797; Report on, H. A. F. Lindsay and C. M. Harlow, 797
- Lachrymal Bone in Vertebrate Animals, Evolution of the, Dr. W. K. Gregory, 279
- La Ferrassie, Works of Art Discovered at, Dr. Capitan and M. Peyrony, 468
- L'Alimentation et L'Élevage Rationnels du Bétail (Opinions du Prof. A. Mallèvre), J. E. Lucas, 422
- Lamarckism Unshamed, 419
- Laminaria flexicaulis*, The Mucilaginous Substances of, Mme. Z. Gruzewska, 703
- Lamprey, The Narrow-mouthed, and its Ascent of Waterfalls, D. A. Herbert, 436
- L'Astronomie et les Astronomes*, A. Collard, 503
- Land Flora, The Earliest, Dr. D. H. Scott, 537
- Lands of Silence, The: A History of Arctic and Antarctic Exploration, Sir Clements R. Markham, 291
- Lathrism, or the Intoxication produced by Vetch-seeds, M. Mirande, 414
- Latian Province, Minerals of, F. Millosevich, 254
- Latitudes and Longitudes in Central Asia, Astronomical Determinations of, G. Abetti, 703
- Law of Mass Action, Application of the, to the Results obtained in the Reaction of β -Galactosidase on Galactose in Solution in Propyl Alcohol, M. Bridel, 510
- Leeds University: Visit of Princess Helena Victoria; Dr. R. J. S. McDowall appointed Lecturer in Experimental Physiology and Experimental Pharmacology, 123; The Finances of, Sir Michael Sadler, 540; The Memorial Gas Plant being Constructed; Gift towards, by A. G. Glasgow, 604; The James Edmondson Ackroyd Memorial Fellowship awarded to F. W. Dry, 732
- Leonard Prize for Radiographic Research, The, 502
- Leonardo da Vinci*, The Salving of the, 217
- Leptospermum, Occurrence of a New Phenol in the Essential Oils of the, A. R. Penfold, 703
- Levant, The Seas of the, Preliminary Notice of the Italian Expedition for Exploring, Prof. G. Magrini, 478
- Liassic Gastropods, The Evolution of Certain, with Special Reference to their Use in Stratigraphy, Agnes McDonald and Dr. A. E. Trueman, 445
- Life: and Mind, Problems of, 35; The Ways of, A Study in Ethics, S. Ward, 35
- Light: and Electrons, Sir Oliver Lodge, 169; Prof. J. Joly, 203; Artificial, Its Influence upon Civilisation, M. Luckiesh, 486; The Use of, as an Aid to Various Games and Sports, J. S. Dow, 470; as an Aid to Publicity, The Use of, Capt. E. Stood, E. C. Leachman, and E. T. R. Murray, 23; "body" Hydrophones and the Directional Properties of Microphones, Drs. A. B. Wood and F. B. Young, 541; -filters in Microscopy, The Use of, J. H. Pledge, 252; Heterogeneous, The Photographic Efficiency of, F. C. Toy, 542; the Relative Velocity of, Remarks on Simple Relativity and, Sir Oliver Lodge, 716, 748; The Velocity of, Relativity and, C. O. Bartrum; J. H. Jeans, 42; Sir Oliver Lodge, 73; C. O. Bartrum, 141; J. H. Jeans, 169; The Absorption of, by Electrically Luminescent Mercury Vapour, E. P. Metcalfe and B. Venkatesacher, 286
- Lighting: and Extinguishing Public Gas-lamps, An Apparatus for, P. Bernard and Barbe, 62; A. Cabrier, 542; of Ships at Sea, The, Discussion on, 310
- Lightning: and Thunderstorms, Recent Work on, C. T. R. Wilson, 638; Ball, seen in London, 722
- Ligurian Fossil Sponges: iii., C. De Stefani, 128; vi., C. De Stefani, 671
- Lime and Magnesia, The Removal of, from Solution, by Precipitates of Chromium Hydroxide, E. Toporescu, 159
- Limiting Motions of a Semi-rigid Body about a Fixed Point under no Forces, O. Lazzarino, 671
- Limnætheria, A New Conchostracan Genus, Mrs. Mabel C. Wright, 309
- Linnean: Gold Medal of the Linnean Society, Presentation of the, to Dr. D. H. Scott, 434; Society, Election of Officers and Council of the, 499; Prof. J. M. Coulter, Dr. S. Garman, Prof. G. B. Grassi, Prof. L. A. Mangin, and Prof. J. Massart elected Foreign Members of the, 369
- Lippich, Black Fringe, The, and the Precision of Polarimetric Measurements, G. Bruhat and Mlle. M. Hanot, 542
- Lippincott's Quick Reference Book for Medicine and Surgery, Dr. G. E. Rehberger, 484
- Liquid Air Contained in Vacuum Flasks, An Experimental Analysis of the Losses due to Evaporation of, Prof. H. Briggs, 190; Carbonic Acid, The Total Heat of, Prof. C. F. Jenkin and D. N. Shorthose, 412; Oxygen Vaporiser, A, E. A. Griffiths, 412
- Lister, Lord, Six Papers by, with a Short Biography and Explanatory Notes, Sir Rickman J. Godlee, 232
- Literature for Jerusalem University, Prof. S. Alexander, I. M. Sieff and D. B. Stanhill, 333
- Liver: Blood Plasma, and Proteid Sugar, H. Bierry and F. Rathery, 575; Working of the, Comparative Researches on the, Following Surgical Anæsthesia produced by Chloroform, Ether, Nitrous Oxide, or Novocaine, F. Widal, P. Abrami, and J. Hutinel, 446
- Liverpool: Dept. of Oceanography, Changes of Staff, 637; University, Dr. McLean Thompson appointed Professor of Botany in, 572
- Liverworts Submerged in Water, The Modifications of Form and Structure of, Ad. Davy de Virville and R. Douin, 510
- Lockyer, The Norman, Observatory, The Hill Observatory, Sidmouth, to be known in future as, 306
- Logic, A Psychology of, Prof. H. Wildon Carr, 612
- Logs and Antilogs, R. T. A. I., 300
- London: County Council and Day Continuation Schools, 475; Handbook of Lectures and Classes for Teachers for the Session 1921-22, 850; Electricity Inquiry, The, 609; Institute of Historical Research in, 668; University, Purchase of Site, 28; Resolution for the Continuance of the Physiological Laboratory, South Kensington; Conferment of Doctorates, 123; College, Annual Report of the Committee of the, 221; Forthcoming Public Lectures, 284; Presentation Day, 348; Appointment of, Representatives of Science to the Senate for 1921-25, 348; The Granting of the Degrees of Master of Science and Master of Arts, 349; T. A. Brown appointed Senior Lecturer in Pure Mathematics, and Dr. P. Stocks Medical Officer in connection with the Department of Applied Statistics and Eugenics at University College, 379; Dr. R. R. Gates appointed Professor of Botany at King's College, 442; D. M. S. Watson appointed Professor of Zoology and Comparative Anatomy at University College; H. G. Jackson appointed Reader in Zoology at Birkbeck College; Dr. W. Wilson appointed Professor of Physics at Bedford College, 443; Conferment of Doctorates, L. H. D. Buxton elected to an Albert Kahn Travelling Fellowship, 443; Sir Sydney Russell-Wells re-elected Vice-Chancellor; Dr. G. Cook appointed Professor of Mechanical Engineering at King's College; L. Hawkes appointed University Reader in Geology at Bedford College; The Title of Emeritus Professor of Philosophy and Comparative Psychology conferred on Carveth Read, 572; Grants from the Dixon Fund; Conferment of Doctorates, 572; M. T. M. Ormsby appointed Professor of Municipal

- Engineering at University College; Dr. F. S. Langmead Professor of Medicine at St. Mary's Hospital Medical School; The Rogers Prize for 1921 awarded to L. Rogers; Conferment of Doctorates, 700; O.T.C., Publication of the Roll of War Service of the, 732; Conferment of the Ph.D. Degree, 798
- Londoner, The Modern, and Long Barrow Man, Prof. F. G. Parsons, 186
- Long-distance Telephone System of the United Kingdom, The, Sir William Noble, 216
- Longitudes, Bureau des, *Annuaire pour l'An*, 1921, 200
- Longstaff Medal of the Chemical Society, The, awarded to Prof. J. F. Thorpe, 21
- Loughborough College, Calendar of the, 830
- Low-temperature Research: The Peltier Effect and, Dr. G. Martin; A. A. Campbell Swinton, 43; Sir Oliver Lodge, 73; Dr. G. Martin, 141
- Loyalty Group, Among the Natives of the, Mrs. E. Hadfield, 495
- Lucerne, Crown Gall Fungus of, The Biology of the, J. Line, 190
- Luchon, Influence of the Temperature of the Thermal Waters of, on their Flora, J. Dufrenoy, 159
- Lucknow University, Sir Harcourt Butler, 251
- Lycanthropy in Assam among the Naga Tribes, J. H. Hutton, 278
- Lyme Regis, Exhibition of Fossils at, 598
- Madreporaria, Agariciidæ, Dr. C. I. van der Horst, 413
- Magellan's Voyage, The World-map before and after, E. Heawood, 214
- Magnesia, Transformation of Light into Heavy, N. Parravano and C. Mazzetti, 254
- Magnesian Hydraulic Cement, A New, A. C. Vournazos, 639
- Magnetic: and Electrical Disturbances, The Recent, Dr. C. Chree, 399; Declination Changes at British Observatories, A Comparison of, Dr. C. Chree, 29; Double Refraction in Smokes, L. Trieri, 778; Dr. R. Whytlaw-Gray, 810; Perturbation of May 14-15, 1921, The Strong, M. Flajolet, 542; Spectrum of the β -rays excited by the γ -rays, C. D. Ellis, 444; Storm of May 13-17, The, Dr. C. Chree, 359; Dr. A. Crichton Mitchell, 392; Susceptibility of certain Natural and Artificial Oxides, The, Profs. E. F. Herroun and E. Wilson, 126.
- Magnetism: and Atomic Structure, Dr. A. E. Oxley, 652; Molecular and Cosmical, Prof. S. J. Barnett, 8; S. Chapman, 9; The Theory of, and its Simplest Applications, Dr. S. J. Barnett, 662
- Magneto-optical Effect, A Novel, Prof. E. Thomson, 520; Sir Oliver Lodge, 553; Dr. R. Whytlaw-Gray and J. B. Speakman, 619; Prof. E. Thomson, 619; Prof. J. W. McBain, 684
- Malaria, The *Rôle* of Meteorology in, Brevet Lt.-Col. C. A. Gill, 791
- Malay Peninsula, Fungi of the, T. F. Chipp, 469
- Malta, The Ancient and Modern Inhabitants of, L. H. D. Buxton, 699
- Maltose and Lactose, The Estimation of, in Presence of other Reducing Sugars, M. Legrand, 159
- Mammalian Remains with Mousterian Flint-implements at Ipswich, Discovery of, Miss Nina F. Layard, 468
- Man: Age of, The Hall of the, in the American Museum, Prof. H. F. Osborn, 236; The Natural History of, Sir G. Archdall Reid, 808; The Nature of, W. J. Perry, 710; The Origin of, and of his Superstitions, Carveth Read, 710; The Realm of, G. G. Chisholm, 774; who did the Right Thing, The, A Romance of East Africa, Sir Harry Johnston, 486
- Manchester: College of Technology, Prof. B. M. Jones appointed Principal of the, 156; Literary and Philosophical Society, Election of Officers and Council, T. A. Coward, President, L. E. Vlies, Chairman of the Chemical Section, 342; University, Dr. F. C. Thompson appointed Professor of Metallurgy in, 91; Conferment of Honorary Degrees and Degrees, 340; G. W. Daniels appointed Professor of Commerce and Administration, T. S. Ashton Senior Lecturer in Economics, Miss Ruth Fairbairn Lecturer in Histology, J. C. M. Brentano and H. Lowery Assistant Lecturers in Physics, and H. O'Neill Assistant Lecturer in Metallurgy, 380; Impending Resignation of Dr. H. Robinson, Proposed Conferment of Doctorates, 475; appointments in, 507; Gift from Alderman H. Plummer, 572; Dr. E. C. S. Dickson appointed Senior Lecturer in Physics, C. M. Mason Senior Lecturer in Engineering, E. Jones Lecturer in Engineering, W. H. Hey Lecturer in Systematic Surgery, C. Roberts Lecturer in Clinical Surgery, Dr. A. Renshaw Lecturer in Pathology, J. H. Dible Lecturer in Bacteriology, B. J. Kyrie Lecturer in Morbid Anatomy and Histology, R. H. Thouless Lecturer in Psychology, 669; J. M. Nuttall appointed Assistant Director of the Physical Laboratories, D. C. Henry Lecturer in Chemistry, A. J. Hailwood awarded the Moseley Memorial Prize in Physics, 732.
- Map: Projection, A Little Book on, Mary Adams (Dr. W. Garnett), new edition, 618; Projections, Some Investigations in the Theory of, A. E. Young, 744; Reading, G. H. C. Dale, 775
- Maps: and Map-reading, 294; Ordnance Survey, Their Meaning and Use, with Descriptions of Typical 1-in. Sheets, Dr. M. I. Newbigin. Second edition, 294; Topographic, and Sketch Mapping, Prof. J. K. Finch, 294
- Marine: Deposits, Prof. J. W. Gregory, 292; Engineering, Eng.-Capt. A. E. Tompkins. Fifth edition, 296; Invertebrates, The Inorganic Constituents of, F. W. Clarke and W. C. Wheeler, 795; Navigation, Direction-finding Wireless and, J. J. Bennett, 363
- Maritime Pine, The Acid Constituents of the Exudation of the, G. Dupont, 447
- Marlborough College Natural History Society, Report of the, for 1920, 371
- Marls of the Middle Chalk in the Somme Valley and the Neighbouring Districts, The Surface of the, and the Effect on the Hydrology, W. B. R. King, 158
- Mars, The 1920 Opposition of, E. C. Slipher; G. H. Hamilton, 24
- Marsupial Cranium from Post-tertiary Sand on the Darling Downs, A, H. A. Longman, 371
- Martian Areas, Study of the Bright, R. Jarry-Desloges, 607
- Massachusetts and Rhode Island, The Geology of, B. K. Emerson, 631
- Mathematical: Papers for Admission into the Royal Military Academy and the Royal Military College, and Papers in Elementary Engineering for Naval Cadetships and Royal Air Force for the years 1911-20, edited by R. M. Milne, 713; Papers of Huygens, 4; Text-books, 134
- Mathematics: Elementary Applied, a Practical Course for General Students, Prof. W. P. Webber, 134; for Technical Students, a Second Course in, P. J. Haler and A. H. Stuart, 134; Pure, for Engineers, S. B. Gates, 2 parts, 134; Elementary, Dr. S. Brodetsky, 616
- Matter and Motion, the late Prof. J. Clerk Maxwell. Reprinted with Notes and Appendices by Sir Joseph Larmor; Prof. A. Gray, 98
- Mayen, Jan, The Island of, J. B. Charcot, 190
- Meat Canning, The Process of, and the Causes of Failure, A. M. Wright, 53
- Mechanism, Life, and Personality: An Examination of the Mechanistic Theory of Life and Mind, Dr. J. S. Haldane. Second edition, 136
- Mechanics, The Laws of, a Supplementary Text-book, S. H. Stelfox, 134
- Medical Science and Practice, 484
- Medicine: Accuracy in, Dr. J. H. L. Cumpston, 441; Preventive, The Principles of, Prof. R. T. Hewlett and Dr. A. T. Nankivell, 676; The History of, Congress on, 690; The New, 676
- Melbourne University, Establishment of a Lectureship and Demonstratorship in Natural Philosophy, 28
- Meldola, the late Prof. R., Institution of a Memorial Medal to, 691
- Mellon Institute, Annual Report on the Industrial Fellowships of the, 380
- Men of Science, The Confidences of, 677
- Mercury: in Various Gases, Value of the Surface Tension of, J. Popesco, 607; Pump, a New, G. Ranque, 670

- Mesopotamian house-flies and their Allies, Major W. S. Patton, 117
- Mesozoic Rocks of Applecross, Raasay, and North-east Skye, The, Dr. G. W. Lee, 151
- Messel Memorial Lecture, Proposed Institution of a, 755
- Messier 15, Photographic Catalogue of the Globular Cluster, Rev. H. E. Macklin, 311
- Metabolism and Growth from Birth to Puberty, F. G. Benedict and F. B. Talbot, 647
- Metal Implements, Ancient, 230
- Metallic: Alcoholates and Phenates, Decomposition of, by Heat, J. F. Durand, 607; Zinc, the Production of, Sir R. A. S. Redmayne; The Writer of the Note, 361
- Metalliferous Mining Industry, Appointment of an Advisory Committee for the, 435
- Metallurgical Developments in this Country since 1914, F. W. Harbord, 344
- Metallurgy, Handbook of, Prof. C. Schnabel. Translated by Prof. H. Louis. Third edition, revised by the Translator. Vol. i., 677
- Metals: in Saline Solutions, The Displacement of, M. Barlot, 62; Institute of, Journal of the. Vol. xxiv., No. 2, 327; Modified Methods for the Separation of the, of the Second Group, G. G. Longinescu, G. P. Teodorescu, and G. Chaborski, 152; The Casting of, Prof. T. Turner, 344; The Internal Physics of, 218; Sir George Beilby; The Writer of the Article, 265
- Metamorphic Insects, The History of, Dr. R. J. Tillyard, 249
- Metaphysics, Contemporary, Studies in, Prof. R. F. A. Hoernlé, 228
- Metaxylene, The Solubility of the Isomeric Nitroanilines in, M. Chapas, 127
- Meteor: Radiants of June 25-30, The, W. F. Denning, 535; Display, The August, W. F. Denning, 793; The Recent, W. F. Denning, 825
- Meteorites: Adare and Ensisheim, Chemical Composition of the, Dr. G. T. Prior, 189; Igneous Rocks, Movement in, V. Galippe and Mme. G. Souffland, 661; in Perthshire, Falls of, 631; Italian, Prof. W. M. Flinders Petrie, 301
- Meteorological: Conference, the Fourth International, Proceedings of, 86; Physics, Sir Napier Shaw, 66
- Meteorology: Averages in, The Method of Working Out, J. Mascart, 734; of the Philippines, 732; The Influence of, on Naval Warfare, Lieut. G. C. Steele, 286; The *Rôle* of, in Malaria, Brevet Lt.-Col. C. A. Gill, 791
- Meteors: Large, on March 1 and 2, W. F. Denning, 55; On the Moon, J. W. Gordon, 234; Dr. A. C. D. Crommelin, 235; Recent, W. F. Denning, 634; The August, W. F. Denning, 694
- Metric System: Progress of the, 22, 630; The, and World Trade, 417; The Compulsory Adoption of the, by the Japanese Empire, C. E. Guillaume, 253
- Mexico, Trees and Shrubs of, P. C. Standley, 603
- Microbe Infections in the Invertebrates, a Natural Mode of Defence Against, E. Couvreur and X. Chahovitch, 191
- Micrographical Study of Alloys and the Structure of the Tungsten Steels, The Use of very Slow Cooling for the, A. Portevin, 350
- Microphotometer, a New Registering, Dr. W. J. H. Moll, 253
- Microscope, Measuring with High Powers of the, Dr. G. P. Bidder, 650
- Microscopes and Microscopical Apparatus, R. and J. Beck's Catalogue of, 309
- Milk Customs of Bunyoro, The, Rev. J. Roscoe, 602
- Mind and Brain, 644
- Mineral: Deposit near Rome, New, E. Clerici, 127; Deposits between Lilloet and Prince George, British Columbia, L. Reinecke, 704; Industries, the Importance of Research in the Development of the, Sir Richard Redmayne, 506, 568; Resources of Great Britain, Special Report on the. Vol. xiv., 51; Special Reports on the, Rock-salt and Brine, Dr. R. L. Sherlock, 603
- Mineralogy: An Introduction to the Study of Minerals and Crystals, Prof. E. H. Kraus and Dr. W. F. Hunt, 646; Economic, a Practical Guide to the Study of Useful Minerals, T. Crook, 646; for Students, Dr. J. W. Evans, 646
- Minerals and Rocks, Recent Work on, 794
- Mines: Department, Dr. r. H. Hatch appointed Technical Adviser on Metalliferous Mining, 114; The War of the, Dr. A. Shadwell, 763
- Mirage on the Queensterry Road, The Condition for, A. G. Kamage, 639
- Mist, Dry, P. Scherischewsky, 222
- Molecular: Attractions in Solutions, Molecular Size and Range of, Prof. J. B. Leathes, 138; Structure and Energy, Prof. J. R. Partington, 172; Prof. A. O. Rankine, 203; Prof. A. W. C. Menzies, 331; Weights, the Determination of, The Principles of some New Methods Applicable to, C. Matignon, 382
- Molecule, The Structure of the, and Chemical Combinations, Sir J. J. Thomson, 118
- Molecules, Atoms and, The Dimensions of, Prof. W. L. Bragg and H. Bell, 107
- Mollusca, Hæmoglobin in, Prof. A. E. Boycott, 395; Land and Fresh-water, Distribution of, in the British Isles, W. D. Roebuck, 724
- Molluscan Fauna of Scottish Lakes, and a Pisidium New to the British Isles, B. B. Woodward, 715
- Mollusques, Les Variations et leur Hérité chez les, Dr. P. Pelseneer; B. B. Woodward, 7
- Mongolian Imbecility, Dr. F. G. Crookshank, 218
- Monoplanes in Canada, G. Sheppard, 370
- Monsoon: Rainfall in 1921, the Probable Amount of, Dr. G. T. Walker, 724; South-west, The Origin of the, Dr. G. C. Simpson, 154
- Moon, Meteors on the, J. W. Gordon, 234; Dr. A. C. D. Crommelin, 235
- Moon's Surface, Study of the, W. Goodacre, 825
- Moseley Studentship at Manchester University, H. Robinson appointed to the, 530
- Motor-car Headlights: Ideal Requirements and Practical Solutions, Major A. Garrard, 118
- Mount Everest Expedition: gift to, by the King, 115; The, 434; Progress of the, 661, 722
- Mountains, The Weight of, Dr. A. Heim, 469
- Mousterian Age, A "New" Type of Tool of, Prof. C. G. Seligman, 330
- Moving Belt, A, for the Study of Walking and of Work, J. P. Langlois, 575
- Mueller Medal, The, presented to R. T. Baker, 691
- Muscle: and Nerve, The Energy involved in the Electric Change in, Prof. A. V. Hill, 317; Bone, and Body-weight in Sheep, the Development of; The Alleged Inheritance of an Acquired Character in Man; The So-called Gluteus Maximus of Tarsius, A. B. Appleton, 509-510
- Museum Curators, French and British, Suggested Co-operation between, Dr. Hecht, 460
- Museums: The Employment of Guide-lecturers and the Sale of Pictorial Illustrations in, 52; Association, The Paris Conference of the, 688; T. Sheppard elected President of the, 722; Presidential Address to the, Sir Frederic Kenyon, 822; The Design of, Sir Hercules Read, 436
- Mutations and Evolution, Prof. R. R. Gates, 636, 715; The Writer of the Article, 715
- Myricaceæ of the Eastern United States, The, Dr. H. W. Youngken, 765
- Napoleon, The Centenary of, Eng.-Comdr. E. C. Smith, 302
- National: Association of Industrial Chemists, Report of the, for 1920, 215; Physical Laboratory, Annual Visitation of the, 592; Report of the, for 1920, 694; Researches at the, Dr. N. R. Campbell and C. C. Patterson, 87; Progress, Research and, 97; Union of Scientific Workers, Resolutions of the Council of the, 214
- Native Life in the Loyalty Islands and Southern Nigeria, H. Balfour, 495
- Natural History Museum, South Kensington, C. Tate Regan appointed Keeper of Zoology; Dr. G. F. H. Smith appointed Assistant Secretary, 51
- Nature in a Himalayan Valley, Lt.-Col. J. H. Tull Walsh, 210

- Naturhistorischer Verein der preussischen Rheinlande und Westfalens, Publications of the, for 1913-19, 758
- Navajo Country, The, H. E. Gregory, 406
- Navigazione Astronomica: Nuova, Le Kette di Posizione. Teoria—Applicazioni—Tavole, Prof. G. Pes. Seconda edizione, 777
- Nebulæ: Dark, Dr. A. C. D. Crommelin, 464; Two, with Unparalleled Velocities, Prof. V. M. Slipper, 55
- Negative Carriers Produced in Pure Hydrogen and Nitrogen by Photoelectrons, The Nature of the, L. B. Loeb, 223
- Nelumbo, A New Species of, from the Eocene of Meridian, Mississippi, E. W. Berry, 246
- Nematodirus, Notes on, H. G. May, 343
- Nepenthes, The Active Digestive Agent, in the Liquor Secreted in the Pitchers of, Drs. J. S. Hepburn and E. Q. St. John, 764
- Nervous System, Release of Function in the, Dr. H. Head, 350
- Neujmin's Comet, 1916a, G. Neujmin, 345
- Neuroteroid Insects of the Hot Springs Region of New Zealand, The, in Relation to the Problem of Trout-food, Dr. R. J. Tillyard, 791
- New: South Wales, Linnean Society of, Presidential Address, J. J. Fletcher, 479; The Influenza Epidemic in, in 1919, 308; York, Chemists' Club, Sir Edward Thorpe, Prof. Le Chatelier, Prof. Ciamician, and Dr. E. Solvay elected Honorary Foreign Members of the, 114; Zealand, Discovery of an Ancient Drainage System in, 533; Geology of the Osborne and Whatatutu Subdivisions, J. Henderson and M. Ongley, 828; Geology, Recent Advances in our Knowledge of, Prof. W. N. Benson, 440; Some Aspects of Insect Life in, Comdr. J. J. Walker, 54; Species of the Genus *Lycopodium*, Dr. J. E. Holloway, 151; The Jurassic of, Dr. C. T. Trechmann and L. F. Spath, 638
- Newcomen: Society, Activities of the, 468; Thomas, a Memorial to, Unveiled at Dartmouth, 722
- Newington Moraine of New England, The F. J. Katz and A. Keith, 86
- Newts, Intersexes in, Ch. Champy, 692
- Nichols Prize of the Royal Society of Medicine, The, 215
- Nickel: A Paper on, 724; The Constitution of, Dr. F. W. Aston, 520; Steels, The Electrical Resistance of the, A. Portevin, 94
- Nigeria: Forest Administration of, Annual Report for 1919 of the, 86; Geological Survey of, Bulletin No. 1. The Geology of the Plateau Tin Fields, Dr. J. D. Falconer, 679
- Night Sky, Colour of the Light from the, Lord Rayleigh, 158
- Nile Basin: Hydrography of the, 90; The Measurement of the Discharge of the, through the Sluices of the Assuan Dam, Sir Murdoch MacDonald and H. E. Hurst, 310
- Nitrocellulose Powders, The Stability of, M. Fric, 734
- Nitrogen: Critical Potentials and Band Spectra of, L. and E. Bloch, 767; Fixation, The Influence of Uranium Salts on, E. Kayser, 414; in Organic Compounds, The Detection of, C. D. Zenghelis, 799; in Sewage, The Action of Bacteria and Protozoa in Conserving the, E. H. Richards, 318
- Nobel: Prize for Physics for 1921, The, awarded to Prof. E. Branly, 598; Prizes, Proposal to Increase the Value of the, 598
- Non-ferrous Metallurgy, 677
- Norfolk and Norwich Naturalists' Society, Transactions of the. Vol. xi., part i., 85
- North America, The Cretaceous-Tertiary Boundary in, Prof. A. C. Seward, 282; Western States of, Hydrology of the, Dr. B. Cunningham, 406; -east Coast Institution of Engineers and Shipbuilders, Sir William J. Noble elected President of the, 629; Pole, Proposed Aeroplane Flight by E. Naulty across the, 755
- Northern D'Entrecasteaux, The, D. Jenness and the late Rev. A. Ballantyne, 111
- Northumbria, Highways and Byways in, P. A. Graham, 168
- Norwegian Scientific Expedition to Jan Møven, 598
- Nototherium, The Remains of, Discovered in Tasmania, H. H. Scott and C. E. Lord, 501
- Nova: Cygni III. (1920), W. F. Denning, 471; Geminorum II., the New Star of 1912, Major W. J. S. Lockyer, 248; The Spectrum of, F. J. M. Stratton, 248
- Novæ Aquilæ III., Photographs of the Spectra of, C. F. Butterworth, 182
- Nummulospermum, gen. nov., The Probable Megasporengium of *Glossopteris*, Dr. A. B. Walkom, 445
- Nutrition, Protein in, Quality of, Dr. R. H. A. Plimmer, 664
- Obstetrics: Normal and Operative, Prof. G. P. Shears. Third edition, revised by Dr. P. F. Williams, 484
- Ocean: Currents, The Dissipation of Energy in Permanent, with some Relations between Salinities, Temperatures, and Currents, R. O. Street, 158; Tides, Prof. J. Proudman, 176; A. C. Tennant, 299; Prof. J. Proudman, 300; H. A. Marmer, 393; Dr. W. Bell Dawson, 651
- Oceanographic: Problems, 33; Research, Prof. W. A. Herdman, 172; in the British Empire, Dr. N. Annandale and Major R. B. S. Sewell, 139; in the U.S.A., 632
- Ochreous Flint Artefacts from Sheringham, J. Reid Moir, 684
- Oersted: H. C., Scientific Life and Works of, K. Meyer, 492; the Discoverer of Electro-magnetism, 492
- Oil: from Grape Pips, The, E. André, 510; Fuel, The Use of, 385; in Western Sinai, H. B. Milner, 250; Possibilities in and around Baxter Basin, Rock Springs, Uplift, Wyoming, A. R. Schultz, 792; Waste, from Ships, Prof. T. D. A. Cockerell, 333
- Oiliness of Fatty Bodies, The, P. Woog, 799
- Oldknow, Samuel, The First Manufacturer of British Muslins, Prof. G. Unwin, 477
- Old Red Sandstone Plants, Showing Structures from the Rhynie Chert Bed, Aberdeenshire. Parts iv. and v., Dr. R. Kidston and Prof. W. H. Lang, 382
- Ontario, University Education in, Report of Royal Commission on the Financial Obligations of the State Towards, 188
- Optical: Instruments, Catalogue of, Adam Hilger, Ltd., 725; Rotatory Dispersion, Drs. T. M. Lowry and C. P. Austin, 476
- Optophone: Amplifying the, A. A. Campbell Swinton, 8; Dr. E. E. Fournier d'Albe; J. W. French, 43
- Ore Deposits: of Utah, The, B. S. Butler, G. F. Loughlin, V. C. Heikes, and others, 484; The Enrichment of, W. H. Emmons, 581
- Organic: Liquids and Tissues of Some Marine Animals, The Reducing Power of the, R. Bayeux, 287; Systems, Certain Rhythmic Relations in, Analytical Note on, A. J. Lotka, 222
- Orientation of the Dead, Celestial and Terrestrial, Prof. H. J. Rose, 538
- α Orion, The Apparent Diameter of, C. Nordmann, 319
- Ornithological Problem, An, G. A. Macmillan, 746
- Ornithology, Early, Notes on, and Kindred Subjects, J. R. McClymont, 167
- Osiris Prize, The, awarded to Gen. Ferrié, 629
- Osler Memorial Fellowship, An, Formed in California, 380
- Osmose, Anomalous, F. E. Bartell, 94
- Otozomites in Australia, The Occurrence of, Dr. A. B. Walkom, 575
- Ottokaria-like Plant from South Africa, An, H. H. Thomas, 445
- Over-voltage Compounds, The Life-period of the, E. Newbery, 800
- Owl, The Great Horned, Dr. Overton, 822
- Owls, Young, Transported in Mid-air, J. H. Gurney, 245
- Oxalic Acid and Iodic Acid, The Mutual Reaction of, G. Lemoine, 702; iii., G. Lemoine, 767
- Oxford: Early Chemistry in, Sir Edward Thorpe, 13; Early Science in. Part i., Chemistry, R. T. Gunther, 13; The Historic Names of the Streets and Lanes of, Intra Muros, H. E. Salter, 532; University, Work of the Forestry School, 91; Dr. W. Brown elected Wilde Reader in Mental Philosophy, 507; Dr. E. Mallam appointed Litchfield Lecturer in Medicine; Approval of Statute Constituting the Delegacy for the Society of Oxford Home Students and to the Decree Authorising

- a Loan to the Dyson Perrins Laboratory, 540; The Honorary Degree of D.Sc. conferred on Prof. C. S. Sherrington, 572; W. C. Burnett appointed Secretary of the Delegacy of Local Examinations; P. H. Martin elected to the Theodore Williams Scholarship in Anatomy, 604; Prof. D. H. Macgregor appointed Drummond Professor of Political Economy, and Prof. E. S. Goodrich Linacre Professor of Zoology and Comparative Anatomy, 766
- Oxides, Allotropic Varieties of, Mlle. S. Veil, 575
- Oxygen Gas, A New Revision of the Density of, E. Moles and F. Gonzalez, 831
- Oyster, The Native (*O. edulis*), Sex-change in, Dr. J. H. Orton, 586
- Pain, The Physiology of, 343
- Palæontographical Society, Election of Officers and Council of the, 563
- Palæontology, Human, Prof. A. Keith, 322
- Palestine : Boring in, for Water, Capt. P. H. Mangin, 599; Science and Technology in, Daisy L. Adler, 458
- Palmitic Acid on Water, The Properties and Molecular Structure of Thin Films of, N. K. Adam. Part i., 286
- Pamir : Studies in the Vegetation of, O. Paulsen, 270; The High, 270
- Panama, Gift by the Government of Panama for the proposed Memorial to the late Surg.-Gen. Gorgas in, 277
- Pancreatic Amylase, Influence of some Organic Bases and of their Chlorohydrates on the Activity of, A. Desgrez and R. Moog, 127
- Paper in Indian Libraries, The Perishing of, J. J. Sudborough and Miss M. M. Mehta, 437
- Papua, Commerce and Customs of, Hon. J. H. P. Murray and others, S. H. Ray, 26
- Paraffins, The Catalytic Decomposition of the Polyhalogen Derivatives of the, A. Mailhe, 639
- Parallax Observations, Mr. Flint's, 759
- Paris : Academy of Sciences, Gift to, by Baron Edmond de Rothschild, for the Development of Physico-chemical Research in France, 563; Conference of the Museums Association, The, 688; University of, Attendance at the, 156; Gift to, by E. Deutsch de la Meurthe, 572
- Parenthood : Four Aspects of, 5; The Control of, Prof. J. A. Thomson and others. Edited by Dr. J. Marchant, 5; Dr. Marie Stopes, 88
- Patagonia, Southern, Glacial Geology of, E. G. Fenton, 828
- Pathogenic Micro-organisms, Embryonic Leaflets in relation to, C. Levaditi, 831; Organisms in the Pollen of Flowers and Disease in Bees, Hon. Col. C. J. Bond, 584
- Pearl, The Japanese Artificially Induced, Dr. H. Lyster Jameson, 396, 621; Dr. W. Wingrave, 620
- Pearls, "Cultured," 341
- Peat : in Ireland, The Winning, Preparation, and Use of, 728; Irish, The Exploitation of, Prof. H. Ryan, 728; Dr. A. Fleck, 779
- Peltier Effect, The, and Low-temperature Research, Dr. G. Martin, A. A. Campbell Swinton, 43; Sir Oliver Lodge, 73; Dr. G. Martin, 141
- Pendulum Operations in India and Burma, Capt. Couchman, 187
- Pennsylvania : Botanical Papers from, 764; University Museum, Ancient American Gold Objects in the, Dr. W. C. Farabee, 85
- Penny, The High-value, 565
- Pensée scientifique, "Maitres de la, 758
- Perinereis cultrijera* and *P. Marioni*, Origin and the Rôle of the Reserve Cells of the General Cavity in, etc., R. Herpin, 768
- Persia, A History of, Brig.-Gen. Sir Percy Sykes. (In two volumes.) Second edition, 804
- Personality, the Conception of, The Moral and Social Significance of, the late A. G. Heath, 777
- Peru, The Sea-coast and Islands of, R. C. Murphy and Dr. F. A. Lucas, 501
- Petroleum : in the Punjab and North-west Frontier Province, E. H. Pascoe, 792; Origin of, and Cause of Gas Pressure, 347; Technologists, Institution of, Election of Officers and Council of the, 149
- Phenol into *cyclo*-Hexanol, The Transformation of, G. Vavon and J. Detrie, 478
- Phenylhydrazones, The Catalytic Hydrogenation of the, A. Mailhe, 414
- Philippines, The Climate and Weather of the, 1903 to 1918, Rev. J. Coronas, 732
- Phosphate in Canada, H. S. Spence, 794
- Photographic : Abstracts, 280; Aérienne, Applications de la, L.-P. Clerc, 167; Apparatus, Historical Collection of, Presentation to the Royal Photographic Society of a, Miss M. Talbot, 660; Films, The Structure and Properties of, Dr. C. E. K. Mees, 502; Reducers, the Action of, on the Images Produced on Development Printing Papers, L. A. Jones and C. E. Fawkes, 344
- Photomicrographic Apparatus, A Universal Geometric Slide, J. E. Barnard, 470
- Phototropism in Solution, Studies on. Part i., Prof. B. K. Singh, 373
- Phrenology and Habitat, with special reference to Woodlands, Dr. E. J. Salisbury, 414; of the British Isles, Dec., 1919, to Nov., 1920, Report on the, J. E. Clark and H. B. Adames, 413
- Physical : and Chemical Constants, Tables of, and Some Mathematical Functions, Dr. G. W. C. Kaye and Prof. T. H. Laby. Fourth edition, 264; Reactions, Active Molecules in, E. K. Rideal, 446; Science in the Great War, The Applications of, A. E. Leighton, Dr. A. C. D. Rivett, 442; and Natural Sciences, The Place of the, in General Education, Prof. Whitehead, 655
- Physician's Anthology, A, of English and American Poetry, selected and arranged by Drs. C. A. Wood and F. H. Garrison, 102
- Physico-chemical Problems relating to the Soil, Dr. E. J. Russell, and others, 504
- Physics : a Profession, 289; A Text-book of, Dr. W. Watson. Seventh edition. Revised by H. Moss, 358; Institute of, The Inauguration of the, Speeches by Sir J. J. Thomson and A. J. Balfour, 312, 313; of Metals, The Internal, 218; The Internal, Sir George Beilby; The Writer of the Article, 265; of the Air, Prof. W. J. Humphreys, 66; The Concept of "Space" in, Dr. H. Jeffreys, 267; The Elements, Dr. N. R. Campbell, 643; The Foundations of, Dr. E. N. da C. Andrade, 643
- Physiology : Essentials of, Profs. F. A. Bainbridge and J. A. Menzies. Fourth edition, 166; for Students, 166
- Physis. Part 12, vol. ii., 53
- Phytophthora, Sexual Organs of, Prof. G. H. Pethybridge, 204
- Phytoplankton of the Inland Lakes of Wisconsin, part i., G. M. Smith, 168
- Picard Oxy-acetylene Torch, Improvement of the, 632
- Picture-hanging : Principles of, Sir G. Greenhill, 491; Wire. R. B. Marston, 362; A. J. Stubbs, 395, 438; N. M. Richardson, 601
- Piezoelectricity, Sir T. E. Thorpe, 450
- Piezoelectric kondensierter Systeme, Prof. E. Cohen and Dr. W. Schut, 450
- Pilobolus, The Ocellus Function of the Subsporangial Swelling of, Prof. A. H. R. Buller, 574
- Pilot-balloon Trajectory, An Unusual, G. A. Clarke, 30
- "Pilz- und Kräuterzentrale," Heilbronn a. N., The Objects of the, 371
- "Pinaflavol," a New Photographic Sensitiser, Dr. König, 217
- Pine, Maritime, The Acid Constituents of the Secretion of the, G. Dupont, 542
- Place-names of Northumberland and Durham, The, Prof. A. Mawer, 776
- Plaice : Fishery in the Belt Sea and Neighbouring Waters, 407; in Relation to the Intensive Fishing of the Present Times in the Belt Sea and other Waters, On the Stock of, Dr. C. G. J. Petersen, 407
- Plague : and Rats, Lt.-Col. W. G. Liston, 606; Infection, Eradication of, by Rat Destruction, Major J. C. G. Kunhardt and Asst.-Surg. G. D. Chitre, 757
- Planarian, A New British Land, Dr. R. F. Scharff, 361
- Planetary Photography, E. C. Slipper, 725
- Plant : Biology, 37; A Text-book of, Prof. W. N. Jones

- and Dr. M. C. Rayner, 37; Breeding, The Problem of Increasing the Field of Cereal Crops by, F. L. Engledow, 509; Cell, The Microsomes and the Lipoid Formations of the, A. Guillaermond, 671; The Structure of the, in its Relations with the Theory of the Chondriome, P. A. Dangeard, 735; Development, Influence of Organic Substances on, G. Ciamician and C. Ravenna, 254; Evolution, Prof. A. C. Seward, 197; -growth, Observations of, with the Recording Ultramicrometer, J. J. Dowling, 523; Pests and their Control, Dr. W. B. Brierley, 795
- Plants: Bacterial Diseases of, An Introduction to, E. F. Smith, 168; British: Their Biology and Ecology, J. F. Beiss and H. J. Jeffrey. Second edition, 71; Collected by Various Members of H.M. Salonika Forces, Capt. J. Ramsbottom, 92; Growth of, The Influence of Cold in Stimulating the, F. V. Coville, 223; in the Field, Study of, 293; of Britain, The Extinct and Dubious, Dr. G. C. Druce, 343; Structure and Reproduction of, An Introduction to the, Prof. F. E. Fritch and Dr. E. J. Salisbury, 200
- Platform Review, No. 1, 349
- Plesiosaurian from the Wealden of Berwick, Sussex, Remains of a New, added to the Geological Department of the Natural History Museum, 469
- Pliocene and Post-Pliocene Mammals of Tuscany, Pathology of, L. Pieragnoli, 671
- Plumage: (Prohibition) Bill, Second Reading of the, 212; Agreement arrived at, respecting the, 341; The Importation of, Read a Third Time, 499; Act, Importation of, Constitution of the Advisory Committee in Connection with the, 821
- Podophyllum peltatum*, The Chromosomic Processes in the Diploidic Nuclei of, R. de Litardière, 383
- Polar Exploration: Dr. H. R. Mill, 291; The Future of, F. Debenham, 179
- Polarisation Phenomena in an X-ray Bulb, Dr. S. Ratner, 522
- Polarised Light, The Use of, for the Examination of Old Pictures, P. Lambert, 607
- Politics, The Principles of, An Introduction to the Study of the Evolution of Political Ideas, Prof. A. R. Lord, 264
- Polynômes d'Hermite, une application des, à un Problème de Statistique, Prof. A. Guldberg, 824
- Pompeii, Recent Excavations at, 723
- Pondoland, Geology of, A. L. Du Toit, 827
- Pons-Winnecke's: Comet and its Meteor Shower, W. F. Denning, 15, 55, 153, 373, 438, 601; Prof. Barnard, 217, 247; M. Ebell, 345; Prof. Crawford and Miss Levy, 405; I. Guillaume, 478; G. Merton; Search for Meteors from, Prof. Barnard; R. G. Chandra, 694
- Popocatepetl in Eruption, 599
- Porto Santo, Natural History of, Prof. T. D. A. Cockerell, 10
- Positive Electricity, The Elementary Particle of, Prof. A. H. Patterson, 75
- Potash Position, The, 321
- Potassium: Cyanide, The X-ray Structure of, P. A. Cooper, 745; Salts, The Solubility of Various, in Mixtures of Water and Alcohol, M. Pierrat, 382
- Potato Tubers, Sources of Infection of, with *Phytophthora ifestans*, P. A. Murphy, 639
- Prague, International Conference of Students at, 188
- Precious Stones, Report on, for 1919, Dr. G. F. Kunz, 59
- Pre-glacial Floras, Two, from Beneath the Boulder Clay of Castle Eden, Mrs. E. M. Reid, 501
- Prehistoric: Art, an Exhibition of, in Spain, 562; in Caves and Rock-shelters, M. C. Burkitt, 460; Cooking-place in Norfolk, A. Nina F. Layard, 623; Stone Weapons in East Yorkshire, Origin of Materials Used in the Manufacture of, T. Sheppard, 244
- Pressure Gradients and Upper Winds, Forecasting, Causes of Errors in, G. M. B. Dobson, 605
- Primrose Flowers, The Colour of, Major R. O. Latham; The Writer of the Article, 301
- Primroses, The Colours of, Dr. J. W. H. Harrison, 359; G. Abbott, 395; F. H. Perrycoste, 459
- Prisms, The Refractometry of, J. Guild, 126
- Proboscidea: Evolution and Geographical Distribution of the, Dr. H. F. Osborn, 539; Phylogeny, and Classification of the, Prof. H. F. Osborn, 500
- Procerastea, Regeneration and Reproduction of the Syllid, Dr. E. J. Allen, 61
- Proper Motions, Statistics of, Prof. J. C. Kapteyn and Dr. P. J. Van Rhijn, 694
- Proteid Sugar in Cancerous Subjects, The, H. Bierry, F. Rathery, and Mlle. Levina, 703
- Protein in Nutrition, Quality of, Dr. R. H. A. Plimmer, 664
- Protozoa: and the Evolution of the Gregarious Instinct, R. J. Ludford, 332; Phenomena of "Intelligence" in the, E. Heron-Allen, 456; Physiological Reactions in the, J. S. Dunkerly, 395
- Proustite, The Spectrophotoelectrical Sensitivity of, W. W. Coblenz, 694
- Psyche's Lamp: A Revaluation of Psychological Principles as Foundation of all Thought, R. Briffault, 583
- Psychoanalysis: Its History, Theory, and Practice, A. Tridon, 515
- Psychologie du Raisonnement, E. Rignano, 612
- Psychology: A History of, Prof. G. S. Brett. Vols. ii., and iii., 806; Abnormal, and its Educational Applications, F. Watts, 264; and Psychopathology, 515; and Psychotherapy, Dr. W. Brown, 711; Educational, Dr. D. Starch, 164; Human, Prof. H. C. Warren, 164; of Childhood, The, Dr. Naomi Norsworthy and Dr. Mary T. Whitley, 164; Some Aspects of, 164
- Psychopathology, Psychology and, 515
- Psychotherapy: and War Experience, Dr. W. A. Brend; Prof. T. H. Pear, 122; Principles and Practice of, 711; Psychology and, Dr. W. Brown, 711
- Purple Sapphire, The, and other Posthumous Papers, selected from the Unofficial Records of the University of Cosmopoli by Christopher Blayre, 677
- Pyocyanic Bacillus, The Action of the, on Asparagin, E. Aubel, 735
- Pyridine, The Hydrates of, M. Pariselle, 190
- Pyrolaceæ and Monotropaceæ, The, and the Ericaceæ, Miss Margaret Henderson, 765
- Pyrrhotine and Magnetite, The Expansion Anomaly accompanying the Magnetic Transformation of, P. Chevenard, 30
- Quadrant Electrometer, A Balance Method of Using the, for the Measurement of Power, H. Parry, 253
- Quantum: Theory, The, and Homogeneous Vibrations, Sir Arthur Schuster, 233; The Kinetic Theory and the, 804
- Quartzite Implements of Rostro-carinate and Early Palæolithic Types in Uganda, The Discovery of Large, J. Reid Moir, 649
- Queensland, North-Western, 86
- Rabbit, The Resistance of the, to Avitaminosis, The Physiological Mechanism of, J. Lopez-Lomba and P. Portier, 671
- Race, Culture, and Language, The Evolution and Distribution of, Dr. G. Taylor, 435
- Racemic Compounds, The Active, M. Delépine, 382
- Racial: Biology, impending Establishment in Sweden of an Institute for the Investigation of Problems of, 659; Types in South-east England, H. E. Peake, 538
- Radial Velocities, A Catalogue of, J. Voute, 281
- Radiation: Diffuse, at Mont Blanc Observatory, Compared with that at Lower Altitudes, J. Vallot, 542; from the Carbon Arc, Dr. H. H. Plaskett, 649; The Laws of, of a Perfectly Black Body, Dr. Coblenz, 344
- Radio: -activity, The Effect of, on the Fertility of the Soil, Prof. G. Petit, 118; -communication, Inter-Empire Scheme for, Suggestion for an, R. Donald, 660; -mechanics, Directional, Apparatus for, A. Artom, 479; -stations, The Errors in the Apparent Bearings of, T. L. Eckersley, 502; -telegraphy, Directions from which Atmospheric Disturbances in, Appear to Come, L. W. Austen, 632; The Wave-front Angle in, L. W. Austen, 280
- Radioaktivität und die neueste Entwicklung der Lehre von

den Chemischen Elementen, Prof. K. Fajans, Dritte Auflage, 583

Radiogoniometry and Atmospheric Influences, M. Rothé, 542

Radiological: Installations, Concerning the Danger of, M. Menard and Pestel, 447; Ionometric Arrangement, A. M. Solomon, 702

Radiology, Congress of, Postponement of the, 277

Radioscopic Couch, A New Model, Newton and Wright, Ltd., 437

Radium: and Mesothorium, The γ Radiation and the Evolution of Heat from, Mme. P. Curie, 382; gift of, to Mme. Curie, 402; X-rays and, Protective Measures against, 557

Railway Electrification in the United States, The Economic Aspects of, A. H. Armstrong, 404

Railways, The Width of, A. Ross, 596

Rainfall: British, 1919, 71; Explosions and the Precipitation of, 659; Maps, Average Monthly, A New Method of Constructing, M. de Carle S. Salter, 30; Rate Recorder, Negretti and Zambra's, 117

Rain-gauges, the Design of, 824

Ramsay, the late Sir William, Memorial Tablet to, to be Placed in Westminster Abbey, 691

Rattlesnakes, Facts about, W. S. Griswold, 245

Ray Society, Election of Officers and Council of the, 115

Rayleigh, the late Lord: Some Aspects of the Scientific Work of, Prof. A. W. Porter, 252; Scientific Papers, 546

Rays, Tracing, through an Optical System, T. Smith, 126

Reale Istituto Lombardo di Scienze e Lettere di Milano, Dr. E. J. Russell appointed a Foreign Corresponding Member of the, 402

Realism, A Study in, Prof. J. Laird, 228

Reality Ultimate, Relativity, Space, and, L. C. W. Bonacina, 171

Reconstitution Processes in Shales, Slates and Phyllites, The Trend of, A. Brammall, 605

Red: Fatigue, The Effect of, on the White Equation, Dr. F. W. Edridge-Green, 509; Sea, Northern, The Relations of the, and its Associated Gulf-areas to the "Rift" Theory, Dr. W. F. Hume, 574

Rede Lecture, The, Sir Napier Shaw, 653

Refraction, Atmospheric, A. Mallock, 456

Refractory Materials, Testing the Hardness of, at a High Temperature, E. Rengade and E. Desvignes, 735

Reid: Comet, 1921a, 153; Miss Vinter-Hansen, 217; M. Ebell; W. F. Denning, 247; H. Godard; P. Chofardet, J. Guillaume, 286, 311, 471; Reinmuth, 373

Relationship, and of Geographical Distribution, An Important Method of Studying Problems of, M. M. Metcalf, 223

Relativitätstheorie und Erkenntnis Apriori, H. Reichenbach, 583

Relativity: and Gravitation, 742; and the Deviation of Spectral Lines, Prof. H. J. Priestley, 43; and the Velocity of Light, C. O. Bartrum; J. H. Jeans, 42; Sir Oliver Lodge, 73; C. O. Bartrum, 141; J. H. Jeans, 169; Electrical Theory and, 133; Further Remarks on, Sir Oliver Lodge, 784; Gravitational, Remarks on, Sir Oliver Lodge, 814; in Science Implies, What, Prof. H. Wildon Carr, 578; Simple, Remarks on, and the Relative Velocity of Light, Sir Oliver Lodge, 716; 748; Solar Eclipse Results and the Principle of, C. E. Stromeyer; Sir F. W. Dyson, 682; Space, and Ultimate Reality, L. C. W. Bonacina, 171; The Development and Present Position of the Theory of, Prof. Einstein, 504; The Electron Theory and Gravitation, E. Cunningham. Second edition, 742; The Reign of, Viscount Haldane, 578; The Theory of, Prof. R. D. Carmichael. Second edition, 264; and the Relation between Geometry and Physics, Prof. Einstein, 504; The Development of the Theory of, Prof. H. J. Priestley, 440

Reparation Act: The, and Scientific Research, Prof. J. R. Partington, 394; J. S. Dunkerly, 427; Hon. H. Onslow, 457; and the Cost of German Publications, Prof. J. Stanley Gardiner, 359

Research: and National Progress, 97; in the United States, The Development of, Dr. J. R. Angell, 122; Organisa-

tion in, Prof. W. M. Wheeler, 180; The Safeguarding of, 481; The Universities and, Prof. J. Joly, 760

Resinous Exudation from the Pine, The Acid Constituents of the, G. Dupont, 319

Resonance: in Aspiration Turbines, The Phenomena of, A. Foch, 607; Theory of Hearing, The, Dr. H. Harttridge, 204

Reversibility of the Reaction $\text{CaCO}_3 = \text{CO}_2 + \text{CaO}$, P. Jolibois and Bouvier, 447

REVIEWS AND OUR BOOKSHELF.

Agriculture, Forestry, and Horticulture:

Andrew (R. C.), A Farmer's Handbook: A Manual for Students and Beginners, 679

Basic Slags: Their Production and Utilisation in Agriculture, 7

Brown (Prof. N. C.), Forest Products: Their Manufacture and Use, 326

Chittenden (F. J.), The Garden Doctor: Plants in Health and Disease, 40

Copeland (Prof. E. B.), The Coco-nut. Second edition, 391

Ise (Prof. J.), The United States Forest Policy, 320

Recknagel (Prof. A. B.), and Prof. J. Bentley, jun., Forest Management, 326

Stout (Mary), and Madeline Agar, A Book of Gardening for the Sub-Tropics, 232

Wilson (J.), The Breeding and Feeding of Farm Stock, 678

Wood (Prof. T. B.), The Chemistry of Crop Production, 101

Woolsey, jr. (T. S.), with two chapters by W. B. Greeley, Studies in French Forestry, 548

Anthropology and Archæology:

Baden (Rev. G. T.), Among the Ibos of Nigeria, 495

Davies (Nina de Garis), and Dr. A. H. Gardiner, The Tomb of Amenemhet; The Tomb of Antefoker, Vizier of Sesostris I., and of his Wife, Senet, 70

Fornander (A.), Fornander Collection of Hawaiian Antiquities and Folk-lore, with translations. Edited and illustrated, with notes, by T. G. Thrum. Third series. Part iii., 391

Hadfield (Mrs. E.), Among the Natives of the Loyalty Group, 495

Hogarth (D. G.), Hittite Seals: with particular reference to the Ashmolean Collection, 70

Jenness (D.), and the late Rev. A. Ballantyne, The Northern D'Entrecasteaux, 111

Petrie (Prof. W. M. Flinders), Tools and Weapons: Illustrated by the Egyptian Collection in University College, London, and 2,000 outlines from other sources, 230

Biology:

Batten (H. M.), Habits and Characters of British Wild Animals, 547

Bevis (J. F.), and H. J. Jeffrey, British Plants: Their Biology and Ecology. Second edition, 71

Britton (Prof. N. L.), and Dr. C. F. Millspaugh, The Bahama Flora, 327

Britton (Dr. N. L.), and Dr. J. N. Rose, The Cactaceæ. Vol. ii., 580

Clark (Dr. H. Lyman), The Echinoderm Fauna of Torres Strait, 712

Cook (Dr. M. T.), College Botany: Structure, Physiology, and Economics of Plants, 807

Coward (T. A.), The Birds of the British Isles and their Eggs. Second series, 40

Densmore (Prof. H. D.), General Botany for Universities and Colleges: Laboratory and Field Exercises for "General Botany," 69

Donald (C. H.), Companions: Feathered, Furred, and Scaled, 805

Ealand (C. A.), Insect Life, 806

Errera, Léo, Recueil de l'Institut Botanique. Tome iv., 6

Evans (Dr. I. B. Pole), The Flowering Plants of South Africa. Vol. i., No. 1, 40

- Fabre (J. H.), *Insect Adventures*, 101
 Fritch (Prof. F. E.), and Dr. E. J. Salisbury, *An Introduction to the Structure and Reproduction of Plants*, 200
 Gask (Lilian), Betty and Bobtail at Pine Tree Farm, 41
 Guillaermond (Prof. A.), translated and revised by Dr. F. W. Tanner, *The Yeasts*, 387
 Horwood (A. R.), *A New British Flora: British Wild Flowers in their Natural Haunts*. (In six vols.) Vols. i. and ii., 232; *The Outdoor Botanist*, 293
 Jones (Prof. W. N.), and Dr. M. C. Rayner, *A Text-book of Plant Biology*, 37
 Kidd (Dr. W.), *Initiative in Evolution*, 419
 Kœhler (Prof. R.), *Faune de France*. No. 1, *Echino-dermes*, 776
 Lucas (J. E.), *L'Alimentation et L'Elevage Rationnels du Bétail* (Opinions du Prof. A. Mallèvre), 422
 Martin (Prof. J. N.), *Botany with Agricultural Applications*. Second edition, 168
 Mayer (Prof. P.), *Zoomikrotechnik: Ein Wegweiser für Zoologen und Anatomen*, 71
 McClymont (J. R.), *Essays on Early Ornithology and Kindred Subjects*, 167
 Mortensen (T.), *Studies in the Development of Crinoids*, 132
 Newman (Prof. H. H.), *Vertebrate Zoology*, 229
 O'Donoghue (Prof. C. H.), *An Introduction to Zoology*, 740
 Ogilvie (the late Dr. F. M.), *Field Observations on British Birds*, edited by H. Balfour, 259
 Paulsen (O.), *The Second Danish Pamir Expedition: Studies in the Vegetation of Pamir*, 270
 Pelseneer (Dr. P.), *Les Variations et leur Hérité chez les Mollusques*, 7
 Pycraft (W. P.), *The Sea-shore*, 103
 Report of the Proceedings of the Third Entomological Meeting held at Pusa on the 3rd to 15th February, 1919. Edited by T. B. Fletcher. 3 vols., 455
 Read (Carveth), *The Origin of Man and of his Superstitions*, 710
 St. Mars (F.), *The Wild Unmasked*, 200
 Scott (Dr. D. H.), *Studies in Fossil Botany*. Third edition. Vol. i., *Pteridophyta*, 197
 Shipley (Sir A. E.), and Prof. E. W. MacBride, *Zoology: An Elementary Text-book*. Fourth edition, 295
 Skaife (S. H.), *Animal Life in South Africa*, 136
 Small (Prof. J.), *A Text-book of Botany for Medical and Pharmaceutical Students*, 777
 Smith (E. F.), *An Introduction to Bacterial Diseases of Plants*, 168
 Smith (G. M.), *Phytoplankton of the Inland Lakes of Wisconsin*. Part i., 168
 Stebbing (E. P.), *The Diary of a Sportsman-naturalist in India*, 615
 Sturtevant (A. H.), *The North American Species of Drosophila*, 743
 Thayer (G. H.), *Concealing-coloration in the Animal Kingdom. An Exposition of the Laws of Disguise through Colour and Pattern: Being a Summary of A. H. Thayer's Disclosures*. New edition, 338
- Chemistry:**
 Adlam (G. H. J.), *Chemistry*, 647
 Bayliss (Prof. W. M.), *The Nature of Enzyme Action*, Fourth edition, 232
 Bertrand (Prof. G.), and P. Thomas, translated by H. A. Colwell, *Practical Biological Chemistry*, 390
 Caven (Prof. R. M.), *The Foundations of Chemical Theory*, 613
 Chemistry, *Annual Reports on the Progress of*, for 1920, 519
 Clark (Dr. W. M.), *The Determination of Hydrogen Ions*, 772
 Cohen (Prof. E.), and Dr. W. Schut, *Piezochemie kondensierter Systeme*, 450
 Copaux (Prof. H.), *Introduction to General Chemistry*, translated by Dr. H. Leffmann, 743
 Edwards (Prof. C. A.), *The Physico-chemical Properties of Steel*. Second edition, 772
 Euler (Prof. H.), and Prof. P. Lindner, *Chemie der Hefe und der alkoholischen Gärung*, 485
 Fisher (Dr. H. L.), *Laboratory Manual of Organic Chemistry*, 519
 Frederick (R. C.), and Dr. A. Forster, *Public Health Chemical Analysis*, 708
 Fresenius (Th. W.), *Introduction to Qualitative Chemical Analysis*. Seventeenth edition, translated by C. A. Mitchell, 708
 Freund (Ida), Edited by A. Hutchinson and M. Beatrice Thomas, *The Experimental Basis of Chemistry: Suggestions for a Series of Experiments Illustrative of the Fundamental Principles of Chemistry*, 356
 Gunther (R. T.), *Early Science in Oxford*. Part i., *Chemistry*, 13
 Holleman (Prof. A. F.), Edited by Dr. A. J. Walker, assisted by Dr. O. E. Mott, *A Text-book of Organic Chemistry*. Fifth English edition, 325
 Hood (G. F.), and Major J. A. Carpenter, *A Text-book of Practical Chemistry*, 708
 Jaeger (Prof. F. M.), *Lectures on the Principle of Symmetry and its Applications in all Natural Sciences*. Second (augmented) edition, 200
 Lewis (E. I.), *Inorganic Chemistry*. Third edition, 613
 Lewis (Prof. W. C. McC.), *A System of Physical Chemistry* (in three vols.). Vol. ii., *Thermodynamics*. Third edition, 772
 Matthews (Dr. J. M.), *Application of Dyestuffs to Textiles, Paper, Leather, and other materials*, 421
 Maxted (Dr. E. B.), *Ammonia and the Nitrides: with Special Reference to their Synthesis*, 549
 May (Dr. P.), *The Chemistry of Synthetic Drugs*. Third edition, 423
 Moldenhauer (Prof. W.), *Die Reaktionen des freien Stickstoffs*, 772
 Molinari (Prof. E.), translated from the third Italian edition by T. H. Pope, *Treatise on General and Industrial Organic Chemistry*. Part i., 325
 Moureu (Prof. C.), *La Chimie et la Guerre*, *Science et Avenir*, 516
 Neville-Polley (L. J.), *John Dalton*, 678
 Ostwald (Prof. W.), translated by Prof. M. H. Fischer, *An Introduction to Theoretical and Applied Colloid Chemistry: "The World of Neglected Dimensions," 226; Die chemische Literatur und die Organisation der Wissenschaft*, 613
 Partington (Prof. J. R.), *A Text-book of Inorganic Chemistry for University Students*, 198
 Partington (Mrs. M.), *Set of Cards for Teaching Chemical Formulæ and Equations*, 296
 Reports of the Progress of Applied Chemistry: Issued by the Society of Chemical Industry. Vol. v., 1920, 807
 Saintsbury (Prof. G.), *Notes on a Cellar-book*. New edition, 163
 Slosson (Dr. E. E.), *Creative Chemistry: Descriptive of Recent Achievements in the Chemical Industries*, 618
 Steel (Prof. M.), *A Laboratory Manual of Organic Chemistry for Medical Students*. Second edition, 549
 Stewart (Prof. A. W.), *Recent Advances in Physical and Inorganic Chemistry*. Fourth edition, 262
 Svedberg (Prof. The.), *The Formation of Colloids*, 744
 Tilden (Sir William A.), *Famous Chemists: The Men and their Work*, 802
 West (Prof. A. P.), *Experimental Organic Chemistry*, 807
 Willaman (Prof. J. J.), *Vocational Chemistry: For Students of Agriculture and Home Economics*, 777
 Z. (H.), and H. C. S., *Bibliotheca Chemico-mathematica*, 2 vols., 294
 Zsigmondy (Prof. R.), translated by Prof. E. B. Spear, *The Chemistry of Colloids*. Part i., *Kolloid-chemie*; part ii., *Industrial Colloidal Chemistry*, 226
- Engineering:**
 Bull (F. E.), and J. W. Meares, *Hydro-electric Survey of India*. Vol. ii., *Second Report on the Water-power Resources of India*, 263
 Chalmers (T. W.), *The Gyroscopic Compass: A Non-Mathematical Treatment*, 328

Cowley (W. L.), and Dr. H. Levy, *Aeronautics in Theory and Experiment*. Second edition, 389
 Leggett (B.), *Wireless Telegraphy: with Special Reference to the Quenched-spark System*, 390
 Minikin (R. C. R.), *Practical River and Canal Engineering*, 48
 Park (W. E.), *A Treatise on Airscrews*, 389
 Tompkins (Engr.-Capt. A. E.), *Marine Engineering (A Text-book)*. Fifth edition, 296

Geography and Travel:

Adams (Mary), (Dr. W. Garnett), *A Little Book on Map Projection*. New edition, 618
 Brown (Sir Hanbury), *The Land of Goshen and the Exodus*. Third edition, 679
 Brown (Dr. R. N. Rudmose), *The Principles of Economic Geography*, 774
 Dale (G. H. C.), *Map Reading*, 775
 Finch (Prof. J. K.), *Topographic Maps and Sketch Mapping*, 294
 Graham (P. A.), *Highways and Byways in Northumbria*, 168
 Hingston (Capt. R. W. G.), *A Naturalist in Himalaya*, 210
 Huntington (E.), and S. W. Cushing, *Principles of Human Geography*, 774
 Markham (Sir Clements R.), *The Lands of Silence: A History of Arctic and Antarctic Exploration*, 291
 Mawer (Prof. A.), *The Place-names of Northumberland and Durham*, 776
 Newbigin (Dr. Marion I.), *Ordnance Survey Maps: Their Meaning and Use. With Descriptions of Typical 1-in. Sheets*. Second edition, 294
 Ward (Capt. F. Kingdon), *In Farthest Burma*, 231

Geology and Mineralogy:

Andrée (Prof. K.), *Geologie des Meeresbodens. Band II.: Die Bodenbeschaffenheit und nutzbare Materialien am Meeresboden*, 292
 Boule (Prof. M.), *Les Hommes Fossiles: Eléments de Paléontologie Humaine*, 322
 Butler (B. S.), G. F. Loughlin, V. C. Heikes, and others, *The Ore Deposits of Utah*, 484
 Crook (T.), *Economic Mineralogy: A Practical Guide to the Study of Useful Minerals*, 646
 Emmons (W. H.), *The Enrichment of Ore Deposits*, 581
 Evans (Dr. J. W.), *Falconer's The Geology of the Plateau Tin Fields*, 679
 Falconer (Dr. J. D.), *The Geology of the Plateau Tin Fields*, 679
 Gibson (Dr. W.), *Coal in Great Britain*, 38
 Harker (A.), *Notes on Geological Map-reading*, 294
 Howe (J. Allen), *Stones and Quarries*, 423
 Kraus (Prof. E. H.), and Dr. W. F. Hunt, *Mineralogy: An Introduction to the Study of Minerals and Crystals*, 646
 Lamplugh (G. W.), C. B. Wedd, and J. Pringle, *Memoirs of the Geological Survey. Special Reports on the Mineral Resources of Great Britain*. Vol. xii., *Iron Ores (continued): Bedded Ores of the Lias, Oolites, and Later Formations in England*, 261
 Steinmann (Prof. G.), and Prof. O. Wilckens, *Handbuch der Regionalen Geologie*. 20 Heft, III. Band, 1 Abteilung. *The British Isles: The Channel Islands*, by thirteen contributors, 355
 Strahan (Sir Aubrey), Dr. W. Gibson, T. C. Cantrill, Dr. R. L. Sherlock, and H. Dewey, *Memoirs of the Geological Survey. Special Reports on the Mineral Resources of Great Britain*. Vol. xiii., *Iron Ores (continued): Pre-Carboniferous and Carboniferous Bedded Ores of England and Wales*, 261

Mathematical and Physical Science:

Bailaud (J.), *Manuel de Topométrie. Operations sur le Terrain et Calculs*, 6
 Bragg (Sir William), *The World of Sound: Six Lectures delivered before a Juvenile Auditory at the Royal Institution, Christmas, 1919*, 200
 Bryant (W. W.), *Kepler*, 713

Callendar (Prof. H. L.), *Properties of Steam and Thermo dynamic Theory of Turbines*, 482
 Campbell (Dr. N. R.), *Physics: The Elements*, 643
 Carmichael (Prof. R. D.), *The Theory of Relativity*. Second edition, 264
 Crewe (H. T.), *The Practical Electrician's Pocket Book for 1921*, 232
 Cunningham (E.), *Relativity: The Electron Theory and Gravitation*. Second edition, 742
 Davison (Dr. C.), *The Elements of Analytical Conics*, 616; *The Elements of Plane Geometry*, 134
 Dunkley (W. G.), *A Primer of Trigonometry for Engineers: With Numerous Worked Practical Examples*, 134
 Durell (C. V.), *Modern Geometry: The Straight Line and Circle*, 616
 Eastwood (G. S.), and J. R. Fielden, *An Algebra for Engineering Students*, 616
 Ewing (Sir J. A.), *The Mechanical Production of Cold*. Second edition, 103
 Fajans (Prof. K.), *Radioaktivität und die neueste Entwicklung der Lehre von den chemischen Elementen*. Dritte Auflage, 583
 Gates (S. B.), *Pure Mathematics for Engineers*. 2 Pts., 134
 Haler (P. J.), and A. H. Stuart, *A Second Course in Mathematics for Technical Students*, 134
 Heath (Sir Thomas), *The Copernicus of Antiquity (Aristarchus of Samos)*, 713
 Henroteau (Dr. F.), *Les Etoiles Simples*, 583
 Hilton (Prof. H.), *Plane Algebraic Curves*, 388
 Hopkinson, Bertram, *The Scientific Papers of, Collected and Arranged by Sir J. Alfred Ewing and Sir Joseph Larmor*, 675
 Huygens, Christiaan, *Œuvres Complètes de, Tome Quatorzième: Calcul des Probabilités: Travaux de Mathématiques Pures: 1655-1666*, 4
 Jeans (J. H.), *The Dynamical Theory of Gases*. Third edition, 804; *The Mathematical Theory of Electricity and Magnetism*. Fourth edition, 133
 Kaye (Dr. G. W. C.), and Prof. T. H. Laby, *Tables of Physical and Chemical Constants, and some Mathematical Functions*. Fourth edition, 264
 Lamb (Prof. H.), *An Elementary Course of Infinitesimal Calculus*. Third edition, 775
 Landon (J. W.), *Elementary Dynamics: A Text-book for Engineers*, 134
 Lipka (Dr. J.), *Graphical and Mechanical Computation*, 616
 MacMahon (Major P. A.), *An Introduction to Combinatory Analysis*, 357
 Maxwell (the late Prof. J. Clerk), with Notes and Appendices by Sir Joseph Larmor, *Matter and Motion*, 98
 Michaud (Dr. F.), *Energétique Générale*, 455
 Milne (R. M.), *Mathematical Papers for Admission into the Royal Military Academy and the Royal Military College, and Papers in Elementary Engineering for Naval Cadetships and Royal Air Force for the years 1911-20*, 713
 Nilsson (Prof. M. P.), *Primitive Time-reckoning: A Study in the Origins and First Development of the Art of Counting Time among the Primitive and Early Culture Peoples*, 275
 Reichenbach (H.), *Relativitätstheorie und Erkenntnis Apriori*, 583
 Robb (Dr. A. A.), *The Absolute Relations of Time and Space*, 422
 Silberstein (Dr. L.), *Elements of Vector Algebra*, 616
 Starling (S. G.), *An Introduction to Technical Electricity*, 296
 Stelfox (S. H.), *The Laws of Mechanics: A Supplementary Text-book*, 134
 Strutt (Prof. J. W.), [Lord Rayleigh], *Scientific Papers*. Vol. 6, 1911-19, 546
 Thomson (Sir J. J.), *Elements of the Mathematical Theory of Electricity and Magnetism*. Fifth edition, 647
 Watson (Dr. W.), *A Text-book of Physics*. Seventh edition. Revised by H. Moss, 358

Weatherburn (Dr. C. E.), *Elementary Vector Analysis: With Application to Geometry and Physics*, 744
 Webber (Prof. W. P.), *Elementary Applied Mathematics: A Practical Course for General Students*, 134
 White (C. J.), revised by P. P. Blackburn, *The Elements of Theoretical and Descriptive Astronomy*. Eighth edition, 582
 Workman (W. P.), and A. G. Cracknell, *The School Geometry: Matriculation edition*, 616
 Young (A. E.), *Some Investigations in the Theory of Map Projections*, 744

Medical Science:

Bainbridge (Prof. F. A.), and Prof. J. A. Menzies, *Essentials of Physiology*. Fourth edition, 166
 Collis (Prof. E. L.), and Dr. Major Greenwood, *The Health of the Industrial Worker*, and, by Dr. A. J. Collis, a Chapter on Reclamation of the Disabled, 354
 Cooke (A.), *Groundwork of Surgery*. (For First-year Students), 807
 Godlee (Sir Rickman J.), *Six Papers by Lord Lister, with a Short Biography and Explanatory Notes*, 232
 Hess (Prof. A. F.), *Scurvy: Past and Present*, 713
 Hewlett (Prof. R. T.), and Dr. A. T. Nankivell, *The Principles of Preventive Medicine*, 676
 Kerrison (Dr. P. D.), *Diseases of the Ear*. Second edition, 743
 Knox (Alice V.), with Chapters on the Production of X-rays and Instrumentation by Dr. R. Knox, *General Practice and X-rays*, 454
 Lane-Clayton (Dr. Janet E.), *The Child Welfare Movement*, 328
 Laumonier (Dr. J.), *La Colloïdothérapie: Résultats Cliniques*, 358
 Marshall (Dr. J. S.), *Principles and Practice of Operative Dentistry*. Fifth edition, 484
 Parker (Dr. G.), *The Early History of Surgery in Great Britain*, 391
 Rehberger (Dr. G. E.), *Lippincott's Quick Reference Book for Medicine and Surgery*, 484
 Reid (Sir G. Archdall), *Prevention of Venereal Disease*, 195
 Rivers (Dr. W. H. R.), *Instinct and the Unconscious: A Contribution to a Biological Theory of the Psycho-neuroses*, 515
 Shears (Prof. G. P.), *Obstetrics: Normal and Operative*. Third edition, revised by Dr. P. F. Williams, 484
 Thomson (Dr. H. H.), *Tuberculosis and Public Health*, 328
 Thomson (Prof. J. A.), and others, Edited by Dr. J. Marchant, *The Control of Parenthood*, 5
 Tridon (A.), *Psychoanalysis: Its History, Theory, and Practice*, 515

Metallurgy:

Ibbotson (F.), *The Chemical Analysis of Steel-Works' Materials*, 741
 Johnson (C. M.), *Rapid Methods for the Chemical Analysis of Special Steels, Steel-making Alloys, their Ores and Graphites*. Third edition, 423
 Metals, *Journal of the Institute of*, Edited by G. Shaw Scott. Vol. xxiv., No. 2, 327
 Schnabel (Prof. C.), translated by Prof. H. Louis: *Handbook of Metallurgy*. Third edition. Vol. i., 677

Meteorology:

British Rainfall, 1919, 71
 Clarke (G. A.), *Clouds*, 365
 Humphreys (Prof. W. J.), *Physics of the Air*, 66

Miscellaneous:

Annuaire pour l'An 1921, publié par le Bureau des Longitudes, 200
 Bain (A. Watson), and others, *The Modern Teacher: Essays on Educational Aims and Methods*, 519
 Barbellion (W. N. P.), *A Last Diary*, 743
 Benedict (F. G.), and F. B. Talbot, *Metabolism and Growth from Birth to Puberty*, 647

Bowley (Prof. A. L.), *Elements of Statistics*. Fourth edition, 102; *Official Statistics*, 549
 British Scientific Instruments, *Dictionary of*, 324
 Carnegie, Andrew, *Autobiography of*, 2
 Clerc (L.-P.), *Applications de la Photographie Aérienne*, 167
 Conway (Prof. R. S.), *New Studies of a Great Inheritance: Being Lectures on the Modern Worth of some Ancient Writers*, 744
 Dawson (W. H.), *The Yearbook of the Universities of the Empire, 1921*, 519
 Ellis (Havelock), *Impressions and Comments*. Second series, 1914-20, 743
 Encyclopædia and Dictionary of Education, The, part i., 103
 Freeman (R. A.), *Social Decay and Regeneration*, 452
 Garnett (J. C. M.), *Education and World Citizenship: An Essay towards a Science of Education*, 386
 Grubb (E.), *The Bible: Its Nature and Inspiration*, 738
 Hawkins (H. P.), *Stella Maitland; or, Love and the Stars*, 777
 Huxley (Dr. L.), *Anniversaries and other Poems*, 136
 Ives (Major H. E.), *Airplane Photography*, 39
 Johnston (Sir Harry), *The Man who did the Right Thing: A Romance of East Africa*, 486
 Lord (Prof. A. R.), *The Principles of Politics: An Introduction to the Study of the Evolution of Political Ideas*, 264
 Luckiesh (M.), *Artificial Light: Its Influence upon Civilization*, 486
 Müller-Lyer (Dr. F.), Translated by Elizabeth Cooté Lake and H. A. Lake, *The History of Social Development*, 452
 Phillpotts (Dr. Bertha S.), *The Elder Edda and Ancient Scandinavian Drama*, 168
 Purple Sapphire, The, and other Posthumous Papers, Selected from the Unofficial Records of the University of Cosmopoli by Christopher Blayre, 677
 Report of the Ninth Annual Conference of Educational Associations held at University College, London, 1921, 231
 Rogeri (Fratris), *Nunc primum edidit R. Steele. Opera hactenus inedita Rogeri Baconi, fasc. v. Secretum Secretorum cum glossis et notulis; Tractatus brevis et utilis ad declarandum quedam obscure dicta*, 771
 Satow (Rt. Hon. Sir Ernest), *A Diplomat in Japan*, 263
 Sharpe (Sir Alfred), *The Backbone of Africa: A Record of Travel during the Great War, with some suggestions for Administrative Reform*, 518
 Subject Index to Periodicals, The, 1917-19. B—E, Historical, Political, and Economic Sciences, 199
 Sykes (Brig.-Gen. Sir Percy), *A History of Persia*. (In two volumes.) Second edition, 804
 Vitale (A.), *Il Regime delle Acque nel Diritto Pubblico e Privato Italiano*, 358
 Webb (S. and Beatrice), *A Constitution for the Socialist Commonwealth of Great Britain*, 100
 Wedel (T. O.), *The Mediæval Attitude toward Astrology, particularly in England*, 771
 Wells (H. G.), *The Salvaging of Civilization*, 707
 Wood (Dr. C. A.), and Dr. F. H. Garrison, *A Physician's Anthology of English and American Poetry*, 102
 Year-book of the Scientific and Learned Societies of Great Britain and Ireland. Thirty-seventh annual issue, 199

Philosophy and Psychology:

Aristotelian Society, *Proceedings of the*. New Series, vol. xx., 618
 Brett (Prof. G. S.), *A History of Psychology*. Vols. ii. and iii., 806
 Briffault (R.), *Psyche's Lamp: A Revaluation of Psychological Principles as Foundation of all Thought*, 583
 Brown (Dr. W.), *Psychology and Psychotherapy*, 711
 Culpin (Dr. M.), *Spiritualism and the New Psychology: An Explanation of Spiritualist Phenomena and Beliefs in Terms of Modern Knowledge*, 164
 Drever (Dr. J.), *Instinct in Man: A Contribution to the Psychology of Education*. Second edition, 455
 Geley (G.), Translated by S. de Brath, *From the Unconscious to the Conscious*, 712

- Haldane (Viscount), The Reign of Relativity, 578
 Haldane (Dr. J. S.) Mechanism, 'Life, and Personality : An Examination of the Mechanistic Theory of Life and Mind. Second edition, 136
 Heath (the late A. G.), The Moral and Social Significance of the Conception of Personality, 777
 Hoerl  (Prof. R. F. A.), Studies in Contemporary Meta-physics, 228
 Hollander (Dr. B.), In Search of the Soul and the Mechanism of Thought, Emotion, and Conduct. 2 vols., 644
 Laird (Prof. J.), A Study in Realism, 228
 McDowall (S. A.), Beauty and the Beast: An Essay in Evolutionary  sthetic, 35
 Norsworthy (Dr. Naomi), and Dr. Mary T. Whitley, The Psychology of Childhood, 164
 Pitt (St. George Lane-Fox), Free Will and Destiny. With Open Letter on the International Moral Education Congress and League of Nations, by Rt. Hon. Sir Frederick Pollock, and appendix by F. J. Gould, 35
 Reinheimer (H.), Symbiosis: A Socio-physiological Study of Evolution, 35
 Rignano (E.), Psychologie du Raisonnement, 612
 Starch (Dr. D.), Educational Psychology, 164
 Ward (S.), The Ways of Life: A Study in Ethics, 35
 Warren (Prof. H. C.), Human Psychology, 164
 Watts (F.), Abnormal Psychology and its Educational Applications (2nd edition of " Echo Personalities "), 264

Technology :

- Knapp (A. W.), Cocoa and Chocolate: Their History from Plantation to Consumer, 357
 Whympre (R.), Cocoa and Chocolate: Their Chemistry and Manufacture. Second edition, 713
- Rhacodiella castaneae*, Ascophorous Form of, B. Peyronel, 127
 Rhodesia Museum, Bulawayo, conditional gift to, by Sir Otto Beit, 469
Rhynchodemus Scharffi, An Addition to the British Fauna, Prof. A. Dendy, 298
 Rhyolites of Lipari, The, H. S. Washington, 795
 Rideal-Walker Test, " Approved Technique of the, Dr. S. Rideal and A. Walker, 150
 Rio Guadiato Depression (Sierra Morena), The Geology and Physical Geography of the, H. Joly, 254
 River and Canal Engineering, Practical, R. C. R. Mini-kin, 48
 Road to Ruin, The, and the Way Out, Dean Inge, 506
 Rockall: An Expedition of the *Pourquoi-Pas* to, Dr. J. Charcot, 799; Landing upon, by Dr. J. Charcot, 755
 Rockallit , The Mineralogical Composition of, A. Lacroix, 799
 Rockefeller Foundation: Activities of the, 791; Help of the, to the Medical Schools of Central Europe, 28
 Rock-gypsum of Nottinghamshire, The Micropetrography of the, W. A. Richardson, 605
 Rocks, Minerals and, Recent Work on, 794
 Rome, Reported Fall of a " Thunderbolt " in, 149
 R ntgen: Society, Election of Officers and Council of the, 563; Spectrographic Investigations of Iron and Steel, Dr. A. Westgren, 437
 Rosasite, The True Nature of, C. Perrier, 351
 Roses, British, The Study of, J. R. Matthews, 26
 Rotatory Power of Mannite, The Influence of Ammonium Molybdate on the, G. Tanret, 607
 Rothamsted Experimental Station: Parliamentary Visit to the, Speeches by Lord Bledisloe and Sir Arthur Grif-fith-Boscawen, 375; The, Lord Bledisloe and others, 699
 Royal: Academy, The, 305; Anthropological Institute, The, 120; Astronomical Society, Prof. A. S. Eddington elected President of the, 51; College of Science, Ad-dress to the Old Students' Association of the, Prof. H. E. Armstrong, 28; College of Surgeons of England, Appointments at the, 507; Commission for the Exhibi-tion of 1851, The Prince of Wales made President of the, 21; (Dick) Veterinary College, Bequest to, by A. MacCullum, 507; Geographical Society Awards, 178;

- Institution, Lecture Arrangements, 52; Sir J. J. Thom-son elected Honorary Professor of Natural Philosophy, and Sir Ernest Rutherford Professor of Natural Philo-sophy at the, 342; Gifts to the, by Sir Humphry D. Rolleston and Sir David L. Salomons, 467; Presenta-tion of a Loving Cup by Members of the, to Sir James and Lady Dewar, 530; Irish Academy, Prof. S. Young elected President of the, 115; Observatory, Greenwich, Visitation of the, 472; Sanitary Institute: Folkestone Congress, June 20-25, 567; Scottish Museum, Natural History Department of the, Retirement of Dr. W. Eagle Clarke from the Keepership of the, Appointment of Dr. J. Ritchie as Keeper, 243; Society, Selected Candi-dates of the, 20; Prof. A. Calmette, Dr. H. Deslandres, Prof. A. Einstein, Prof. A. Haller, Prof. E. B. Wilson, and Prof. P. Zeeman elected Foreign Members of the, 342; Conversazione, The, 377; The Second, 536; Society of Arts, Award of the Albert Medal of the, to Prof. J. A. Fleming, 499; Albert Medal, The, Presented to Dr. J. A. Fleming, 562; Award of Medals, 598; The Colonial Section of the, Changed to the " Dominions and Colonies Section, " 629; of Edinburgh, Election of Fellows of the, 51; Election of Honorary Fellows of the, 597; of Medicine, Award of the Gold Medal of the, to Sir Almoth Wright, 657; Bequest to, by Sir Felix Semon, 530; Bequest to, by Dr. H. Barnes, 637; of Victoria, Election of Officers and Coun-cil of the, 435
 Rubber: Bisulphide of Thiouramine and the Vulcanisation of, E. Romani, 671; Cold Vulcanisation of, A New Pro-cess for the, G. Bruni, 671; Exhibition, The Fifth International, 499
 Rugby School, Natural History Society of, Report of, for 1920, 308
 Runners, The " Second Wind " of, P. Chailley-Bert, R. Faillie, and J. P. Langlois, 640
 Russia, Scientific Publications for, 594
 Russian: Men of Science, Appointment of a Committee by the University of Finland to Aid, 660; Scientific and Literary Men, An Appointments Committee for, Formed, 116
 Rust Resistance, Inheritance of, H. K. Hayes, J. H. Parker, and C. Kurtzweil, 251
- St. Andrews University: Honorary Degrees to be Conferred on Prof. W. M. Bayliss, Sir William Henderson, Emeritus Prof. D. Macewan, and Prof. A. N. White-head, 507; Dr. R. Robinson appointed Professor of Chemistry and Director of the Chemical Research Laboratory, 540; Conferment of Honorary Degrees, 637
Saccamina Carteri, Brady, and the Minute Structure of the Foraminiferal Test, Prof. W. J. Sollas, 92
 Salaries for Full-time Teachers in Technical Schools, etc., Report of the Burnham Committee on, 766
 Salicinase, The Influence of Heat on the Activity of, G. Bertrand and A. Compton, 127
 Saline Double Decompositions and their Graphical Repre-sentation, H. Le Chatelier, 62
 Salmon, The Alaskan, Prof. B. W. Evermann, 219
 Salt and Gypsum Resources of South Australia, The, R. L. Jack, 795
 Samoa, Western, Geology of, J. Allan Thomson, 828
 San Domingo, The Rainfall of, 470
 Sarracenias, Some Hybrid, and their Parent Species, The Macroscopic and Microscopic Structure of, Miss Alice M. Russell, 764
 Saturn, The Flattening of the Spheroid of, P. Stroobant, 319
 Saturn's Ring: Re-appearance of, A. Danjon and G. Rougier, 119; The Influence of Satellites upon the Form of, Dr. G. R. Goldsbrough, 445
 Scaphopoda, The, of the Eastern Coast of America, J. B. Henderson, 117
 Scarlet-runner Beans, Bees and, H. J. Lowe, 684, 747
Science Abstracts, Physics and Electrical Engineering Sec-tions, 216
 Science: An Historical Catalogue of, 294; and Civilisation, J. Henderson Smith and Major A. G. Church, 684;

- Capt. B. J. Marden, 623; Dr. C. V. Drysdale, 715; and Technology in Palestine, Daisy L. Adler, 458; and the Industries, J. J. Carty, 122; for the Young Farmer, 101; in the Civil Service, 1; Masters' Association, Issue of a Circular Respecting Research Work, 411; Museum, South Kensington, Catalogue of Machine-tools and Metal-working and Wood-working Machines, 310; Teachers, Association of, Report for 1920 of the, 123; The Neglect of, Prof. S. J. Hickson, 779; Transcendental Premises in, Sir Henry H. Howorth, 9
- Scientific: and Learned Societies of Great Britain and Ireland, Year Book of the, Thirty-seventh Annual Issue, 199; Inquiry, The Structure of, Dr. Dorothy Wrinch, 542; Instruments, British, J. W. Williamson, 361; Dictionary of, 324; The Design and Construction of, R. S. Whipple, 54, 600; Papers, Prof. J. W. Strutt [Lord Rayleigh]. Vol. vi., 1911-19, 546; Pioneers, Calendar of, 29, 61, 92, 124, 157, 189, 221, 252, 285, 317, 349, 381, 412, 444, 476, 508, 541, 573, 604, 638, 670, 701, 734, 767, 798, 831; Publications for Russia, 594; Research, Prof. J. Joly, 657; in the United States, Endowment of, 719; The Reparations Act and, Prof. J. R. Partington, 394; J. S. Dunkerly, 427; Hon. H. Onslow, 457; Work, Administration of, Lord Haldane; Prof. L. Baird-stow, 439
- Scobicia declivis*, Injury to Lead Sheathing of Aerial Telephone Cables by, T. E. Snyder, 343
- Scombrobrax heterolepis*, A New Deep-sea Fish, caught near Madeira, L. Roule, 607
- Scotland, South-west Highlands of, Structure of the, E. B. Bailey, 222
- Scottish Drift Soil, Studies of a, W. G. Ogg and J. Hendrick, 85
- Scurvy: Past and Present, Prof. A. F. Hess, 713
- Sea: -level, Mean, Variations of the, on the Flemish Coast, Dr. B. Schulz, 54; -shore, The, W. P. Pycraft, 103; -water, The Density and Refractive Indices of, C. Vaurabourg, 287; The Oceanic Circulation and the Density of, J. Thoulet, 287
- Secondary School Teachers' War Relief Fund, Report of the, 637
- Seed: Testing, Problems of, C. B. Saunders, 509; Trials Arranged by the National Institute of Agricultural Botany, 631
- Seeds Giving Hydrogen Sulphide by Fermentation belonging to the Family of the Papilionaceæ, M. Mirande, 447
- Selborne Society, Lectures in Connection with the, 507
- Selenium, The Resistivity of, H. Pélabon, 799
- Sensitive Plants, the Comparative Histology and Irritability of, Dr. D. W. Stockbeck, 764
- Senussi Shrines, Unveiling the, A. Silva White, 366
- Sequola at Washing Bay, Co. Tyrone, Occurrence of a, Prof. T. Johnson and Jane G. Gilmore, 639
- Sewage, the Purification of, by Activated Sludge, The Disappearance of Pathogenic Germs in the Course of, P. Courmont, A. Rochain, and F. Laupin, 735
- Sex: -change in the Native Oyster (*O. edulis*), Dr. J. H. Orton, 586; -ratios and their Modifications in Animals and Plants, J. S. Huxley, 116; The Determination of, Prof. R. Goldschmidt, 780; The Genetics of, Prof. R. R. Gates, and others, 571
- Sexual: Differences in the Skeleton of the Superior Limbs, Some, A. A. Mendes-Corrêa, 254; Organs of Phytophthora, Prof. G. H. Pethybridge, 204
- Shackleton Antarctic Expedition of 1914-17, The, J. M. Wordie, 62; Geological Observations in the Weddell Sea Area, J. M. Wordie, 606; in the Weddell Sea, The Soundings and Deep-sea Deposits of the, J. M. Wordie, 692
- Shear Influence Lines, A Graphical Method of Determining, etc., Prof. A. R. Horne, 93
- Sheep: Gold-coloured Teeth of, W. J. L. Abbott, 459; River Gas- and Oil-field of Alberta, The, 661
- Sheep's Teeth, Dental Encrustations and the So-called "Gold-plating" of, T. Steel, 249
- Sheffield University, Bequest by R. J. Pye-Smith, 507
- Shell, Disturbances in the Initial Motion of a, The Origin of the, R. H. Fowler and C. N. H. Lock, 126
- Shetlands, Botanical Work in the, Dr. G. C. Druce, 92
- Shimizu Expansion Apparatus, The, 697
- Siberia: Impending Trading Expedition to, 756; Maps Showing the Distribution of Population in, 150
- Sierra Leone, The Norite of, F. Dixey, 638
- Silchester Discoveries, The, M. Stephenson, 538
- Silicon in Fused Salts and in Steels, Spectra of Quantitative Sensibility of, A. de Gramont, 702
- Simple Integrals, Theory of, of First Species Belonging to an Algebraic Surface, III., F. Severi, 671
- Sinai, Western, Oil in, H. B. Milner, 250
- Sinks, Sources and, A. F. Dufton, 522; Dr. H. S. Allen, 622
- Sino-iranica, Chinese Contributions to the History of Civilisation in Ancient Iran, with Special Reference to the History of Cultivated Plants and Products, B. Laufer, 430
- Skin Temperatures of Pachyderms, The, Dr. F. G. Benedict, 540
- "Slaves," The, of Mosul, Major R. Burnett, 756
- Sleeping Sickness, A New Treatment of, Dr. C. H. Marshall, 540
- Sludge, Activated, Concerning, F. Diénert, 735
- Smallpox: in Nottingham, The Outbreak of, 790; Protection Against, by Vaccination, Dr. Drury, 757
- Smith, Sir Francis Pettit, A Memorial Tablet to, 597
- Smithsonian Institution: Annual Report of the, 501; Field-work of the, 765
- Smoke: -fogs, Dr. J. S. Owens, 246; Problem, The, Prof. L. Hill; Dr. Owens, 567
- Social; Decay and Regeneration, R. A. Freeman, 452; Degeneration, Rev. Dr. W. R. Inge, 452; Development, The History of, Dr. F. Müller-Lyer. Translated by Elizabeth C. Lake and H. A. Lake, 452
- Socialist Commonwealth of Great Britain, A Constitution for the, S. and Beatrice Webb; Mrs. B. Wootton, 100
- Soda, Solid Caustic, The Utilisation of, and the Absorption of Carbon Dioxide, Miss Elizabeth Gilchrist, 639
- Sodammonium, The Action of, on Diphenylmethane, Fluorene, and Indene. Dimethylfluorene, P. Lebeau and M. Picon, 734
- Sodium: and Potassium, The Vacuum Arc Spectra of, S. Datta, 158; Chloride, Influence of, on the Development of *Sterigmatocystis nigra*, M. Mollard, 414; Derivatives of the True Acetylene Hydrocarbons, A New Method of Preparing the, M. Picon, 735; Vapour, The Electrodeless Discharge in, Prof. J. K. Robertson, 269
- Soil: Physico-chemical Problems Relating to the, Dr. E. J. Russell, and others, 504; the Conductivity of the, The Relation of the Soil Colloids to, T. B. Franklin, 62
- Solar: Activity, The Correlation between the Fluctuation of, as Shown by Sunspots and Faculæ, Sin-iti Kunitomi and H. Takô, 793; Cooking Apparatus on Mount Wilson, Experiments with, Dr. C. G. Abbot, 540; Eclipse Results and the Principle of Relativity, C. E. Stromeyer; Sir F. W. Dyson, 682; Lines, The Displacement of the, Under the Action of the Gravitational Field, H. Buisson and C. Fabry, 382; Radiation in Relation to Faculæ, H. H. Clayton, 108; Radiation, The Variations of the, During the Eclipse of the Sun of April 8, 1921, at Bagnères-de-Bigorre, M. Dort, 414
- Solid Bodies, The Influence of the Geometrical Form of, on the Chemical Actions which they Undergo, G. Reboul and R. Luce, 319
- Solids, The Interpenetration of, H. Weiss and P. Lafitte, 735
- Solubility of Small Particles, The, and the Stability of Colloids, L. F. Knapp, 381
- Soluble or Volatile Bodies, The Superficial Extension of, A. Marcellin, 734
- Solution, The Elementary Quantity of Energy Concerned in, R. Audubert, 190
- Solutions, Solid, The Hardness of, Dr. W. Rosenhain, 318
- Sorby Research Fellowship, Dr. N. K. Adam appointed to the, 604
- Sound: in Air and Water: The Experimental Analysis of, Some Experiments towards a Sound Spectrum, Drs.

- G. Barlow and H. B. Keene, 574; The World of, Six Lectures delivered before a Juvenile Auditory at the Royal Institution, Christmas, 1919, Sir William Bragg, 200; Transmitted Through Earth, R. G. Durrant, 140; -waves, A Photographic Method of Finding the Instantaneous Velocity of, at Points near the Source, A. L. Foley, 94
- Soul, The Search of the, and the Mechanism of Thought, Emotion, and Conduct, Dr. B. Hollander. 2 vols., 644
- Sources and Sinks, A. F. Dufton, 522; Dr. H. S. Allen, 622
- South: Africa, The Flowering Plants of, Edited by Dr. I. B. Pole Evans. Vol. i., No. 1, 40; The Fungus Flora of, Miss Ethel Doidge; P. van der Bijl, 469; America, Dr. O. Nordenskjöld's Expedition to, Progress of, 21; -eastern Union of Scientific Societies, The Proceedings and Transactions for 1920; Prof. E. B. Poulton President for 1921-22, 214; Annual Congress of the, 537; -west Monsoon, The Origin of the, Dr. G. C. Simpson, 154
- Southern California Floods of January, 1916, H. D. McGlashan and F. C. Ebert, 406
- Space: and Ultimate Reality, Relativity, L. C. W. Bonacina, 171; in Physics, The Concept of, Dr. H. Jeffreys, 267; or "Æther," Prof. A. S. Eddington, 201; Dr. Norman R. Campbell; L. C. W. Bonacina, 234; The Physical Continuity of, L. C. W. Bonacina, 300; Commdr. J. G. McHardy, 360; The Physical Status of, Dr. H. Jeffreys, 394; L. C. W. Bonacina, 459; Time and, The Absolute Relations of, Dr. A. A. Robb, 422
- Spanish Association, Don J. R. Carracido elected President of the, 244
- Spark Lines, The Conditions of the Emission of the, by the Electric Arc, A. de Gramont and G. A. Hemsalech, 799; Spectra of Gold and Platinum in the Extreme Ultra-violet, The, L. and E. Bloch, 350; of Iron and Cobalt in the Extreme Ultra-violet, The, L. and E. Bloch, 287; Some, in the Extreme Ultra-violet, L. and E. Bloch, 253
- Specific Heats: of Air and of Carbon Dioxide, Ratio of the, Prof. J. R. Partington, 541; of Substances at Low Temperatures, Variation of the, Prof. G. Bruhat, 280; The Connection of the, with the Equation of State of a Gas, A. G. Webster, 94
- Spectral: Lines, the Deviation of, Relativity and, Prof. H. J. Priestley, 43; The Displacement of, by a Gravitational Field, Prof. H. J. Priestley, 585; Series, Doublets in, D. Rogestvensky, 203
- Spectrophotometry in the Visible and Ultra-violet Spectrum, Prof. T. R. Merton, 125
- Spectroscope with Catoptric Grating, A, Prof. A. Lo Surdo, 478
- Spectroscopic Parallaxes, 1646, W. S. Adams, and others, 281
- Spectrum Lines, The Effect of a Magnetic Field on the Intensity of, ii., H. P. Waran, 510; Researches on the Motions in the Line of Sight, etc., Dr. W. S. Adams, 539
- Sphæria, Variation in, W. E. Alkins, M. Cook, and J. Harwood, 30
- Spiders, Some, without Pulmonary Sacs, L. Fage, 159
- Spiral Movements in Rocks during Elevation or Depression, Prof. C. Lapworth's Views with Regard to, Dr. T. S. Wilson, 93; Nebulæ, Formation of, Speculations on the, A. Véronnet, 438; The Constitution and Formation of the, A. Véronnet, 350
- Spiritualism and the New Psychology: An Explanation of Spiritualist Phenomena and Beliefs in Terms of Modern Knowledge, Dr. M. Culpin, 164
- Spitsbergen, The Impending Biological Expedition to, 214
- Sponges, Hexactinellid, Prof. A. Dendy, 413
- Sportsman-naturalist: A, 259; in India, The Diary of a, E. P. Stebbing, 615
- Squirrels, The Feeding Habits of, R. Standen, 822
- Stalagmite containing Impressions of Moth's Wings, C. Carus-Wilson, 21
- Stanford, Leland, University of California, Impending Establishment in, of a Research Institute on the Production, Distribution, and Consumption of Food, 156
- Staphylinid Beetles, The, Dr. M. Bernhauer, 413
- Star: and Nebula, Collision of, Prof. E. W. Brown, 471; Clusters, Magnitudes in, XI., H. Shapley, 94; Maps, Ancient, 24
- Starlight, The Total Amount of, Dr. P. J. Van Rhijn, 566
- Stars: Atmosphere of, Researches on the, H. Deslandres and V. Burson, 93, 222; Determination of the Effective Temperatures of Some, and their Colour Index, C. Nordmann and Le Morvan; Double, J. Jackson, 217; Parallaxes of, The Determination of the, Grant to W. B. Rimmer by the Advisory Council for Scientific and Industrial Research for Research Work on, 467; Variable, Miss Cannon; S. Williams; C. Hoffmeister, 759; Periodicity of, Dr. J. G. Hagen, 566; State Awards for Medical Discovery, Sir Ronald Ross, 723; *Technology*, No. 1, 311
- Statistics: Elements of, Prof. A. L. Bowley. Fourth edition, 102; Official, Prof. A. L. Bowley, 549
- Statolith, Apparatus in, Studies in the Cytology of the, T. L. Pranker, 317
- Steam: and Thermodynamic Theory, Sir J. A. Ewing, 482; of Turbines, Properties of, Prof. H. L. Callendar, 482; Engine, A New Type of Crankless, A. G. M. Michell, 181; Nozzles, Pressure-flow Experiments on, Prof. A. L. Mellanby and W. Kerr, 54
- Steel: Joints, Welded, The Fragility of Some, C. Frémont, 62; The Analysis of, 741; The Cause of Quenching Cracks in, Honda, Matsushita, and Idei, 534; The Physico-chemical Properties of, Prof. C. A. Edwards. Second edition, 772; Works' Materials, The Chemical Analysis of, F. Ibbotson, 741
- Stella Maitland; or, Love and the Stars, H. P. Hawkins, 777
- Stellar: Atmospheres, The Stationary H- and K-lines of Calcium in, Prof. Megh Nad Saha, 488; Evolution, Cosmogony and, J. H. Jeans, 557, 588; Magnitudes and their Determination, H. Spencer Jones, 142, 173, 205; Parallax, Sir Frank Dyson, 527; Measurements of, at the Dearborn Observatory, P. Fox, 382
- Stem with Horizontal Geotropism, A, H. Coupin, 159
- Stems of Various Annual Plants, The Utilisation of the, C. A. Bey, 222
- Stereochemistry, Recent Advances in, Prof. B. K. Singh, 474
- Stereoscopic Vision, The Application of, to the Control of Glacial Variations, P. L. Mercanton, 159
- Stickstoffs, Die Reaktionen des freien, Prof. W. Moldenhauer, 772
- Stone-axe Factory, The, of Graig-lwyd, Penmaenmawr, S. H. Warren, 346
- Stonehenge, Excavations at, Lt.-Col. W. Hawley; The Source of the Blue Stones at, Dr. H. H. Thomas, 23; Recent Work at, 50
- Stones and Quarries, J. Allen Howe, 423
- Stonyhurst College Observatory Report, Rev. A. L. Cortie, 503
- Stratigraphy, British, 355
- Streams, Relation of, to Geological Structure, W. R. Browne, 832
- Students and Teachers from the Dominions Overseas and from Foreign Countries in British Universities, 156
- Submarine Cable, Transmission Characteristics of the, J. R. Carson and J. J. Gilbert, 540
- Subject-index to Periodicals, 1917-19; Section F: Education and Child Welfare, 188; B.-E. Historical, Political and Economic Sciences, 199
- Sudan Government, Institution of a Scientific Research Committee by the, 661
- Sugar-cane in Trinidad, The Froghopper-blight of, C. B. Williams, 661
- Sulphonations in the Presence of Iodine, V. Auger and Mlle. M. Vary, 767
- Sulphuretted Hydrogen in the Seeds of Certain Papilionaceæ, the Extraction and Nature of the Substance Producing, M. Mirande, 768
- Sumer and Egypt, Early Chronology of, Prof. S. Langdon, 315
- Summer: Educational Courses in England and Wales, List of, 380; Time, Date for the Beginning of, 21
- Sun: and Moon, The Accelerations of the, Dr. H. Jeffreys, 281; Naked Eye Observations of the Eclipse of the,

- R. F. Granger, 247; Observations of the, made at the Lyons Observatory, J. Guillaume, 62; The Eclipse of the, of April 8, 1921, The Electrical Field of the Atmosphere During, J. Rouch, 319; Spot Group, The Great and Magnetic Disturbances, May 8-21, Rev. A. L. Cortie, 426; The Recent Large, H. W. Newton, 399; -spots and Weather, C. E. P. Brooks, 599; Effect of a Large Group of, 369; -fishes, New Studies of, made during the "Dana" Expedition, 1920; Dr. Johs Schmidt, 76
- Sunderland Technical College, Gift to, by R. A. Bartram, 669
- Supernannation Systems, American and British, 545; W. Palin Elderton, 651, 683; Dr. J. W. Evans, 683
- Surface Tension: and Anaphylactic Shock, A. Lumière, 127; and Antianaphylaxy, W. Kopcawewski, 319; and Surface Energy with Temperature, The Variation of, Prof. A. W. Porter, 702; The *Rôle* of, in the Phenomena of Shock, W. Kopcawewski, 31
- Surgery: Groundwork of (for First-year Students), A. Cooke, 807; in Great Britain, The Early History of, Dr. G. Parker, 391
- Sussex Iron Industry: The Rise and Development of the, Rhys Jenkins, 240; The Rise and Fall of the, Rhys Jenkins, 630
- Swallows: The Scarcity of, Dr. W. E. Collinge, 628; A. Pride, 779
- Swansea University College, Appointments at, 637
- Symbiosis: A Socio-physiological Study of Evolution, H. Reinheimer, 35
- Symmetry, Lectures on the Principle of, and its Applications in all Natural Sciences, Prof. F. M. Jaeger. Second (augmented) edition, 200
- Syringomyelitis and Spiriferina, Dr. F. J. North, 501
- Tails, Human and Other, Prof. F. Wood Jones; Sir Arthur Keith, 487
- Talbot, the late W. H. Fox, Proposed Memorial to, 691
- Tan Bark, Fermenting, The High-temperature Organism of. Part i., Dr. R. Greig-Smith, 479
- Tapa or Bark Cloth," "A Catalogue of Specimens of, 791
- Taraxacum erythrospermum*, Andr., in the South-east of England, The Distribution of, H. W. Monckton, 253
- Tasmania, The Phytogeography and Flora of the Mountain-summit Plateaux of, Miss L. S. Gibbs, 347
- Tasmanian Museum, Catalogue of the Osteological Specimens in the, W. L. Crowther and C. E. Lord, 116
- Teacher: The Modern, Essays on Educational Aims and Methods, Edited by A. Watson Bain, 519
- Technological Education, The Universities and, Prof. A. Smithells, 695; Prof. W. W. Watts, 726
- Telephonic Communication Established between Cuba and the United States, 402
- Telephony: Long-distance, 241; Wireless, Demonstrations of, 369; The Possibilities and Achievements of, Dr. J. A. Fleming, 369
- Tellurium Tetraiodide, A. Damiens, 414
- Temperature and Wind at the Top of the Eiffel Tower, The Simultaneous Oscillations of, and their Relation with the Bjerknes Steering Surface of a Depression, R. Dongier, 191; Variability of, over Europe and North America (1900-9), N. A. Comissopulos and J. Wadsworth, 605
- Temperatures, "Absolute," in Meteorological Publications, Sir Napier Shaw, 201
- Tenebrionidæ, The, H. Gebien, 413
- Termites, Growth of the Antenna in, C. Fuller, 24
- Texel, Some Birds from, Miss E. L. Turner, 189
- Teyler Society of Haarlem, Offer of a Gold Medal by the, 22
- Thallium Sulphide and Selenide, The Resistance of, H. Pélabon, 735
- Thames between Teddington and Shoeburyness, A Model for Investigating the Movements of the, G. E. W. Cruttwell, 596
- Theban Tombs, Prof. W. M. Flinders Petrie, 70
- Therapeutic Substances, Control of Certain, Report of Committee on, 149
- Thermal: Diffusion, Some Experiments on, T. L. Ibbs, 318; Transpiration Currents, Experiments on, Dr. G. D. West, 445
- Thomson's Machine for Armless Men, Sir James Cantlie, 469
- Thorium C, Mass of Long-range Particles from, Sir Ernest Rutherford, 246
- Tides: Ocean, Prof. J. Proudman, 176, 300; A. C. Tennant, 299; H. A. Marmer, 393; Dr. W. Bell Dawson, 651
- Timbers, Commercial, Scientific Names for, R. T. Baker, 45
- Time: and Space, The Absolute Relations of, Dr. A. A. Robb, 422; -intervals, Short, The Measurement of Single and Successive, Prof. A. Pollard, 585; reckoning, Primitive, A Study in the Origins and First Development in the Art of Counting Time among the Primitive and Early Culture Peoples, Prof. M. P. Nilsson, 275
- Tissues, Vegetable and Animal, New Technique for the Inclusions and Microscopical Preparations of, Mlle. Larbaud, 511
- Tolerance and Anaphylaxy, The Alternations between, C. Richet, Mlle. E. Bachrach, and H. Cardot, 639
- Tools and Weapons: Illustrated by the Egyptian Collection in University College, London, and 2000 Outlines from other Sources, Prof. W. M. Flinders Petrie, 230
- Topométrie, Manuel de, Opérations sur le Terrain et Calculs, J. Baillaud, 6
- Torres Strait and its Echinoderms, 712
- Toxins, Vaccines, and Antitoxins, Standardisation of, 161
- Trachoma, New Acquisitions in the Experimental Study of, C. Nicolle and A. Cuénod, 382
- Trees: and Shrubs of Mexico, P. C. Standley, 603; Dates of the Flowering of Some, in South-west and South-east of England, J. E. Clark, 245
- Trevelyan Rocker, Study of the Actual Motions of the, Prof. Chuckerbutti, 824
- Trigonometry, A Primer of, for Engineers: With Numerous Worked Practical Examples, W. G. Dunkley, 134
- Trilobite, The Structure of the, Dr. C. D. Walcott, 436
- Trinidad as a Key to the Origin of Petroleum, Prof. P. Carmody, 471
- Triton alpestris*, The Experimental Change of Sex in, C. Champy, 447
- Trout, The Food of, Caught in the Torquay Reservoirs, Dr. Perkins, 757
- Trypanosomiasis, A New Treatment of, Dr. C. H. Marshall, 540
- Tuberculosis: and Public Health, Dr. H. H. Thomson, 328; "Carriers," Prof. Calmette, 752; Human, Immunity in, Lt.-Col. N. Raw, 148; Problem, The, 641; The Conference of the International Union against, 751; The Treatment of, by Public Authorities, 353
- Tungsten Filaments, High-temperature Phenomena of, Parts i. and ii., C. J. Smithells, 702
- Tunis, Northern, A Deep Boring which Demonstrates the Existence of Transported Strata in, L. Joleaud, 447
- Turbines, Properties of Steam and Thermodynamic Theory of, Prof. H. L. Callendar, 482
- Turbo-alternator, Causes Leading to the Breakdown of a, The Metropolitan-Vickers Electrical Co., Ltd., 87
- Turpentine, French Essence of, The Composition of, M. Pariselle, 607
- Tycho Brahe and his Observatory, V. Carlheim-Gyllensköld, 535
- U Cephei, The Eclipsing Variable, R. S. Dugan, 373
- Uganda, Geology of, E. J. Wayland, 827
- Ulmite, a Constituent of Black Sandstone, T. Steel, 640
- Ulua Valley, Honduras, Marble Vases from, 757
- Uncharged Nuclei Produced in Moist Air by Ultra-violet Light and other Sources, the late Prof. J. A. McClelland and J. J. McHenry, 477
- Unconscious to the Conscious, From the, G. Geley. Translated by S. de Brath, 712

- United Kingdom, University Statistics of the, 1919-20, 554
 United States: Annual Report of the Commissioners of Education for the, 91; Climates, Essential Characteristics of, Prof. R. de C. Ward, 180; Cloudiness in the, Prof. R. de C. Ward, 693; Coast and Geodetic Survey, Report of the Director, 533; Department of Agriculture, Annual Report of the Entomologist to the, Dr. L. O. Howard, 343; Endowment of Scientific Research in the, 719; Forest Policy, The, Prof. J. Ise, 326; Forestry in the, 326; Formation of a Science Service in the, 370; Funds Available in 1920 in the, for Scientific Research, 475; Geological Survey, Report of, for Year ending June 30, 1918, 151; Mineral Resources of the, in 1919, 309; Patent Office, A Movement for Reforms in the, 277; National Academy of Sciences, Annual Meeting of the, 539; National Research Council, Publications of the, J. W. Williamson, 121; Organisation for the Conservation of the Natural Resources of the, 534; Rate of Growth of the Population of the, since 1790, Prof. R. Pearl and L. J. Reed, 94; Rate of Increase of Underground Temperature with Increasing Depth in the, N. H. Darton, 344; Study of Medicine in the, 798; University Education in the, 794
 Univalent Oxygen, A Compound which may Contain, C. V. Porter and F. H. Thurber, 600
 Universities: of the Empire, Congress of the, 610, 655; The Yearbook of the, 1921, edited by W. H. Dawson, 519; The, and Research, Prof. J. Joly, 760; The, and Technological Education, Lord Crewe, and others, 656; Prof. A. Smithells, 695; Prof. W. W. Watts, 726; The Nationalisation of the, Viscount Haldane, 733
 University: and Civil Service Salaries, 801; Education in the United States, 794; Finance, 737; Grants and Needs, 65; in the Civil Service Estimates, 225; Statistics of the United Kingdom, 1919-20, 554; Teachers, Association of, Address to the, Prof. J. Strong; Election of Officers of the, 701
 Unknown, The Inspiration of the, Prof. E. B. Poulton, 537
 Upper: Air, International Exploration of the, C. J. P. Cave, 761; Shiri River, Nyasaland, The Natural History of the, Prof. R. Newstead, 381
 Urea in the Liver after Death, The Formation of, R. Fosse and Mlle. V. Rouchelman, 222
 Uric Acid in the Liver, Arrest of, Chaffard, Brodin, and Grigaut, 94
 Utah, The Ore Deposits of, B. S. Butler, G. F. Loughlin, V. C. Heikes, and others, 484
 Vaccination, Dr. Mary Scharlieb, 244
 Vaccines, Toxins and Antitoxins, Standardisation of, 161
 Vacuole, The Contractile, Prof. W. M. Bayliss, 810
 Vacuum Tubes Used as Detectors of Electrical Oscillations, L. Hartshorn and E. S. Keeping, 445
 Valerian Series, The, Prof. O. T. Jones, 350
 Valerian, The Alkaloids of, A. Goris and C. Vischniac, 383
 Vanadic Acid and Hydrogen Peroxide, Double Catalysis of, V. Auger, 542
 Vaporisation, The Latest Heats of, E. K. Rideal, 126
 Varro's Aviary at Casinum, A. W. Van Buren and R. M. Kennedy, 500
 Vector Analysis: Elementary, with Application to Geometry and Physics, Dr. C. E. Weatherburn, 744; Symbols in, R. H. Nisbet, 362
 Vectorial Calculus, Applications of, to Astronomy, A. Abetti, 671
 Vectors and Tensors, E. A. Milne, 30
 Vegetation: around London Earlier than in the Provinces, C. Harding, 269; in the English Lakes, The Development of, Considered in Relation to the General Evolution of Glacial Lakes and Rock Basins, W. H. Pearsall, 509
 Venereal Disease, Prevention of, Sir G. Archdall Reid, 195; The Conquest of, 195
 Venus: Spectrum of, Displacement of Lines in the, Dr. C. E. St. John and S. B. Nicholson, 725; The Occultation of, 566, Photographs of, F. Qué'nisset, 670; The Rotation of, Prof. W. H. Pickering, 88
 Vertebrate Morphology, 229
 Vertical Temperature Gradient in the Atmosphere, L. De Marchi, 671
Vesperugo pipistrellus, A Trypanosome of the Bat, E. Chatton and R. Courrier, 478
 Vibrations of a Spring Disc, The, Prof. H. Lamb and R. V. Southwell, 318
 Victoria, Palæozoic Geology of, E. O. Teale, 828
 Vienna, Retired University Professors in, Condition of, 178
 Viscosity: Effect of, on Orifice Flows, W. N. Bond, 350; of Water and Low Rates of Shear, Dr. A. Griffiths and Constance H. Griffiths, 350
 Vision, The Theory of, Dr. F. W. Edridge-Green, 361
 Vitamines, The Designation of, Prof. A. Liversidge, 45; Prof. H. E. Armstrong, 72
 Vitamins, Prof. Mellanby, 568
 Vowel Sounds, Nature of, C. de Wesendonk; Prof. E. W. Scripture, 12, 333; Prof. C. V. Raman, 332
 Vulsinio System, Unity of the, V. Sabatini, 254
 Wa-Vumba Tribe in the Delta of the Umba River, Survivals of the Regalia of the, A. Dickson, 215
 Wages-regulation, Index-numbers and, 513
 Wales: Collection of Rural Lore in, by School-children, Sir Alfred T. Davies, 124; National Museum of, Annual Report of the, 85; The University of, Honorary Degrees to be Conferred on, Prof. T. W. E. David, Sir J. J. Dobbie, and Prof. A. Gray, 507
 Walrus, The, in Northern Scotland, Dr. J. Ritchie, 53
 War Memorial, A, 675
 Warrington Museum, G. A. Dunlop appointed Keeper of the, 85
 Water: -beetles of the Family Hydrophilidæ, Life-history and Biology of, E. A. Richmond, 150; -divining in Australia, Dr. Griffith Taylor, 822; in Transformer Oils, The Estimation of, E. Rengade and J. Clostre, 799; -power and the Development of the Mineral Industry, Dr. J. W. Evans, 506; -supply of Buckinghamshire and Hertfordshire, The, W. Whitaker, 565; Underground, The Drought and, B. Hobson, 684
 Waterways, Inland, Dr. Brysson Cunningham, 48
 Waves of Arbitrary Form in Isotropic Media, Propagation of, G. A. Maggi, 127
 Weather: Forecasts for Agricultural Purposes, Summer Service of, 598; in July, The, 756; Prediction, A, Abbé Moreux, 84; The, a Comparison of Previous Winters, 309; The Dry, 23, 534
 Wehnelt Interrupter, A New Form of, F. H. Newman, 318
 Weismannism, Prof. E. W. MacBride, 89
 Welcome Chemical Research Laboratories, Presentation of a Gold Medal to Dr. F. B. Power to Commemorate his Directorship of the, 466
 Welsh National School of Medicine, A. W. Sheen appointed Professor of Surgery in the, 604
 West Indian Zoology, Prof. J. Stanley Gardiner, 829
 Western Australia: Geological Survey of, Issue of a Series of Memoirs for Prospectors and Miners, 279; University of, Prof. A. D. Ross elected a Member of the Governing Body of the, 349; Utilisation of the Artesian Water Resources of, A. G. Maitland, 501
 Weyl's Theory of the Electromagnetic and Gravitational Fields, A Generalisation of, Prof. A. S. Eddington, 125
 Wheat: Home-grown, 89; Species and Races of, Prof. J. Percival, 538
 White, Gilbert, proposed Memorial to, 370
 Wild: Birds Advisory Committees for England and Scotland, Meetings of the, 369; Unmasked, The, F. St. Mars, 200
 Wind: Utilisable Energy of the, Col. G. A. Crocco, 478; Velocity and Direction at Different Heights, Diurnal Variation in, J. Durward, 693
 Wire-drawing, Critical Points due to Hardening caused by, L. Guillet and M. Ballay, 639
 "Wired Radio," R. D. Duncan, 87
 Wireless: Telegraph Apparatus, Demonstration of New, 563; Telegraphy: with Special Reference to the Quenched-spark System, B. Leggett, 300; Direction-finding, and Marine Navigation, J. J. Bennett, 363; Telephony, Demonstrations of, 369; The Possibilities

- and Achievements of, Dr. J. A. Fleming, 369; Weather Messages for the Benefit of Navigators, 598.
- Woburn Agricultural Experiments, Continuance of the, 754.
- Women's Minimum Wages, Mrs. W. J. Barton, 605.
- Work, Health and, Dr. C. S. Myers, 354.
- World: and Empire Development, G. H. Knibbs, 441; Citizenship, Education and, 707; Trade, The Metric System and, 417.
- Worms Die?, Why Do, Rev. H. Friend, 172; G. T. Harris, 269; W. J. L. Abbott, 490; J. H. Coate, 491.
- Wrightson's Hypothesis of Audition, Dr. H. Hartridge, 811.
- X-ray: Reflection by Diamond, The Intensity of, Sir W. H. Bragg, 477; Spectrum of Palladium from Fluorspar, The Reflection of the, H. Pealing, 477; Structure of Potassium Cyanide, The, P. A. Cooper, 745.
- X-rays: and Radium, Protective Measures against, 557; and their Physiological Effects, A. B. Bruce, 140; Crystal-reflection of, The Nature of the, Sir Joseph Larmor, 126; General Practice and, Alice V. Knox. With chapters on the Production of X-rays and Instrumentation, by Dr. R. Knox, 454; in Medical Practice, 454; The Protection against, of Persons other than the Operator and Patient, G. Contremoulins, 382. 414.
- Yale University, Prof. J. R. Angell elected President of, 156.
- Yeasts: Advances in the Study of, Dr. D. Ellis, 387; The, Prof. A. Guilliermond. Translated and revised by Dr. F. W. Tanner, 387.
- Yngaren, Trials of the, 600.
- York Museum, Dr. W. E. Collinge appointed Keeper of the, 60.
- Yorkshire as an Earth-block surrounded by Down-folded Strata, Dr. J. E. Marr, 827.
- Young's Interference Experiment, Dr. R. A. Houston, 268; Lord Rayleigh, 298; Prof. P. N. Ghosh, 362; and the Spectrometer, Prof. J. K. Robertson, 457.
- Zinc: in the Organism of the Rabbit during Growth, The Variation in the Proportion of, G. Bertrand and R. Vladesco, 703; in the Phenomena of Fertilisation in the Animal Vertebrates, The Probable Intervention of, G. Bertrand and R. Vladesco, 735; in Vertebrate Animals, The Causes in the Variation in the Amount of, G. Bertrand and R. Vladesco, 222; Metallic, The Production of, Sir R. A. S. Redmayne; The Writer of the Note, 361; Statistical and Technical Information upon, 1913-19, G. Rigg, 279; The Electrolytic Recovery of, S. Field, 252.
- Zoology: An Elementary Text-book, Sir A. E. Shipley and Prof. E. W. MacBride. Fourth edition, 295; An Introduction to, Prof. C. H. O'Donoghue, 740; for Medical Students, 740; Vertebrate, Prof. H. H. Newman, 229; West Indian, Prof. J. Stanley Gardiner, 829.
- Zoomikrotechnik: Ein Wegweiser für Zoologen und Anatomen, Prof. P. Mayer, 71.



A WEEKLY ILLUSTRATED JOURNAL OF SCIENCE.

*"To the solid ground
Of Nature trusts the mind which builds for aye."*—WORDSWORTH.

THURSDAY, MARCH 3, 1921.

Editorial and Publishing Offices:

MACMILLAN & CO., LTD.,

ST. MARTIN'S STREET, LONDON, W.C.2.

Advertisements and business letters should be
addressed to the Publishers.

Editorial communications to the Editor.

Telegraphic Address: PHUSIS, LONDON.

Telephone Number: GERRARD 8830.

Science in the Civil Service.

TWENTY years ago there were very few scientific workers in the Civil Service; only one or two Departments existed where a knowledge of science was a qualification for employment, and the higher Civil Service contained few men who could claim even a nodding acquaintance with scientific thought. The rapid growth of the public Services within the last fifteen years, the assimilation of public utility companies into the State system, the creation of entirely new Departments, and the realisation forced upon Ministers by the war of the necessity for scientific research in the nation's interest, have resulted in the employment of thousands of scientific and technical workers. Many of those engaged temporarily during the war have returned to the universities or other institutions from which they were recruited, but a large number remain and have been absorbed by various State establishments. The position of such

workers demands our earnest attention. Prejudice dies hard, and there are still many men in high administrative positions in the Civil Service who hold science in contempt, and this feeling is reflected in their attitude towards scientific workers in their Departments.

It is true, perhaps, that there is something incompatible between science and the Civil Service as it exists. There is a fierce egoism in science which combats the merest semblance of submission to the rigid tyranny of the administrative system. The true scientific worker is impatient of the delay which is the direct outcome of existing departmental methods. He wants to get the results of his labours to the outside waiting world immediately; he is restrained daily by the exasperating regulations which prevent him from doing so. He is for ever reacting against the repressive influence of his environment and the irritating interference of the lay official disciplined to the system.

However, scientific workers have been attracted to the Civil Service in increasing numbers not so much by the emoluments or the security of tenure—the primary considerations of unprogressive minds—as by the opportunities afforded by Government service for the continuation of their researches, which would otherwise have to be abandoned to take up teaching or commercial posts. Some new Departments are the direct outcome of their labours. But gradually their functions are being usurped by the adept place-hunters in the administration, and already some of the ablest men of science, who have given signal proof of their ability to run their own Departments satisfactorily, have been forced to relinquish administrative control to the lay officer. We can think of only two remaining scientific heads of Departments who rank with permanent assistant Secretaries of

State—only two, that is, who can be assured that their schemes will not be mutilated by a non-scientific officer before going through the permanent Secretary to the appropriate Minister. The semi-official apology for this remarkable state of affairs is somewhat disingenuous. It is urged that the administrative machine is so complex that only those with long experience are competent to work it. If this be the true explanation of the subordination of the man of science to the lay official, it is high time the machinery of our Government Departments was overhauled. Ministers responsible for scientific Departments should realise that there is a growing class-consciousness among the younger men of science, and real resentment felt against the intrusion of lay officials into their proper sphere of activities. Such intrusion means duplication of work. It is worthy of note that in one Department where the lay element has been subordinated to the scientific staff a pre-war staff of more than a hundred has been reduced to eighty-two, although the work of the Department has greatly increased in the meantime.

The present system presents yet a further fault which must be remedied. The administrative head of a Department, the lay official, has authority to select the heads of scientific Departments under his immediate control. Being without the necessary qualification to judge of the scientific experience of a scientific worker, it follows that he must, to a large extent, rely upon the judgment of the retiring officer or of other scientific workers of his own choosing. In neither case does it follow that the best man available is chosen. We suggest that some machinery should be put into motion whereby the State could be reasonably assured of the high calibre of its scientific officers. Their selection might, for example, be entrusted to *ad hoc* committees of scientific experts appointed by outside scientific bodies at the request of the Government.

An inter-departmental comparison of the grading and salary scales of scientific workers in the Civil Service would reveal glaring anomalies, but it would occupy too much space in NATURE. In no case do the status, pay, and prospects of promotion of scientific workers compare favourably with those which obtain in the higher clerical grades. Leaving out of consideration the conditions of service of medical men, the scheme lately adopted for scientific workers in the Fisheries Division of the Ministry of Agriculture and Fisheries is the most favourable in the Service. A comparison

between this scheme and that in force for the higher clerical grades is given below:—

Grade	Higher Division Clerks. (Administrative Class.)		Salary.	..	Scientific Workers.	
	I.	1 post			1000-1200	1 post
..	II.	2 posts	700-900	..	2 posts	650-750
..	III.	4 "	500-700	..	5 "	450-650
..	IV.	4 "	200-500	..	13 "	200-450

(All the above posts carry with them Civil Service bonuses in force.)

Such disparities of pay and prospects must react unfavourably against the recruitment of the best scientific workers to the ranks of Government officers. The best men will be attracted to the administrative class and be lost to science. Last year the Civil Service National Whitley Council published a report on the organisation of the Civil Service in which a comprehensive scheme was put forward for the clerical classes. After considerable delay a technical committee of the same council has been entrusted with the task of preparing a scheme for the scientific and technical classes. In the meantime the issue has been prejudicially affected by the varying schemes put forward by different Departments. There is no apparent reason for the inordinate delay in setting up the technical committee. It would have been more satisfactory to deal with all classes of Civil Servants in one report, like that on the United States Civil Service described in last week's issue of NATURE.

A Great Giver.

Autobiography of Andrew Carnegie. Pp. xii + 385. (London: Constable and Co., Ltd., 1920.) 25s. net.

THE life-histories of remarkable men always have interest and value. Few are more fascinating than that of Andrew Carnegie, who began his business career as a telegraph messenger boy at two and a half dollars a week, and step by step, through many trials and triumphs, became the great steel-master, built up a colossal industry, amassed an enormous fortune, and then deliberately and systematically gave away the whole of it for the enlightenment and betterment of mankind. No doubt the element of chance has some part in such great success as that of Carnegie. But it is only a subordinate part. This autobiography enables us to see clearly enough that it was "character" inborn and nurtured by parents—sturdy and high-principled, though brought by the vicissitudes of business to great poverty, even to actual hunger—which determined Carnegie's career. Character made him

courageously and honestly avail himself of the opportunities which "chance" placed to his hand.

Andrew Carnegie's childhood was influenced, as he tells us, by his birthplace, Dumfermline, the burial-place of King Robert the Bruce, with its abbey-church, palace, and glen—"perhaps the most radical town in the kingdom." From his uncles Bailie Morrison and George Lauder he learned much of Wallace, Bruce, and Burns, and he avows "there was then and there created in me a vein of Scottish prejudice or patriotism which will cease to exist only with life." He always kept Burns's philosophy of life before him, and as a schoolboy, when tempted to do a weak or selfish thing, would ask himself: "What would Wallace have done?" and braced himself to the braver course. His father's occupation as a hand-weaver having been superseded by the competition of large factories, the family—father, mother, and two sons, Andrew, aged twelve, and Thomas, aged four—emigrated to Pittsburg (Allegheny City), in the United States, where they had friends and hard-working relatives.

In the autobiography now published Andrew Carnegie tells his own story, not as one posturing before the public, but as in the midst of his own people and friends, tried and true, to whom he can speak with the utmost freedom. It is impossible to epitomise such a narrative. Its charm lies in the record of friendships and in personal touches, in the statement of guiding faith and principle, and of the worldly wisdom of a generous and worthy spirit which accompanies the detailed story of the steps by which the author rose. From being a messenger boy he became a telegraph operator, then a divisional superintendent of the Pennsylvania Railroad. He invested his first savings in the building of sleeping-cars and went on to the organising of rail-making and locomotive works and the formation of a company to build iron bridges, for which he also started the making of pig-iron. And so we come, in 1868, when Carnegie was thirty-three years old, to his great contracts in bridge-building and his negotiations with the bankers of New York and London, his ready command of capital, and the final concentration of all his energies upon the introduction into Pittsburg of the Bessemer steel process and the organisation of the Carnegie Steel Co.

In December, 1868, Carnegie wrote a memorandum which has great interest to-day. It is dated from the St. Nicholas Hotel, New York. He writes:

"Thirty-three and an income of 50,000 dollars per annum. By this time two years I can so arrange all my business as to secure at least 50,000 dollars per annum. Beyond this never

earn—make no effort to increase fortune, but spend the surplus each year for benevolent purposes. Settle in Oxford and get a thorough education, making the acquaintance of literary men. . . . Settle in London. . . . Man must have an idol—the amassing of wealth is one of the worst species of idolatry. . . . I will resign business at thirty-five, but during the ensuing two years I wish to spend the afternoons in receiving instruction and in reading systematically."

Happily (or perhaps unhappily) for him, he did not carry out this programme. For another thirty-two years he was the head of the great business which grew and flourished marvellously in his hands. During that period he had more leisure—he travelled round the world, he spent summer holidays in Great Britain, and made the close friendship of such men as Matthew Arnold, Herbert Spencer, and many others prominent in literature or politics. In 1886, when he was fifty-one, both his mother and his brother died, and in the following year he married Miss Whitfield, of whom he writes (twenty years later) in 1906: "I cannot imagine myself going through these twenty years without her. Nor can I endure the thought of living after her."

Mr. Carnegie tells us in this autobiography that in 1901 the profits of his firm had reached forty millions of dollars per annum, and that seventy millions might have been earned in the year when he and his partners were informed by Mr. Pierpont Morgan, the banker, that if they wished to retire from business he thought he could arrange it. The Carnegie Steel Co. was bought by Mr. Morgan at the price which both he and Carnegie considered fair. We are not told in this book exactly what it was, but it was probably somewhere about one hundred and fifty million pounds, of which a smaller part went to Mr. Schwab and his partners, and the rest to Carnegie.

Andrew Carnegie had found great pleasure in giving pecuniary help to various public purposes during his fifty and more years of money-making. He now, at the age of sixty-six, set to work deliberately to give away his vast fortune (after amply providing for his wife and daughter) in such a way as to make it a source of betterment to his fellow-men. The present writer knew him at this period, and visited him at his place in Scotland, Skibo Castle. He was a kindly and unselfish host, taking a real pleasure in literature, and enjoying both golf and salmon-fishing. He was devoted to church music, and kept an accomplished musician to play the fine organ built in the hall of Skibo. He knew nothing of pictures

of science. There is no doubt that he devoted an immense amount of trouble and consideration to devising methods of bestowing his endowments which should be really beneficial and not either futile or pauperising.

There are many people who, through ignorance and a low estimate of human motive, sneer at Carnegie's "free libraries," and foolishly regard his generous gifts as mere vanity and self-advertisement. Those who knew him, and, indeed, all who examine the record of his various benefactions, are led to a different conclusion—namely, that he carried out in his later years the generous purpose of his early life, and aimed at employing his wealth for the good of the community, with some kindly partiality towards the men who had worked in his employ and those associated with his native place. We cannot give here the complete list and amounts of his benefactions, but to the Carnegie Corporation of New York, "to promote the advancement and diffusion of knowledge by aiding institutions of higher learning and scientific research," he gave 25 million pounds, and it is not yet known what further sum it may receive as his residuary legatee. To the relief fund for men in his mills he gave one million pounds; to establish, in the United States, a pension fund for aged university professors he gave three million pounds, and a million pounds to pay the fees of poor students in Scotch universities; and another million to improve the universities. To nearly three thousand towns (many in Great Britain) Carnegie gave library buildings at a cost of fifteen million pounds. To establish the beautiful museum, library, and picture gallery at Pittsburg, he paid more than five million pounds. Including his hero fund, his Peace Palace at The Hague, and many minor gifts, the Carnegie benefactions, all told, amount, according to the authoritative statement of the editor of this autobiography, to something more than seventy million pounds sterling (350 million dollars)—"a huge sum," as the editor remarks, "to have been brought together and then distributed (in his lifetime) by one man."

The gift in making which Mr. Carnegie tells us he had a greater pleasure than he derived from any other was that of Pittencrieff Park and Glen, together with King Malcolm's tower and St. Margaret's shrine—the paradise of his childhood—presented by him to his native city, Dumfermline. The final chapter of the book tells of Carnegie's visit to the Emperor William, and the bitter disappointment of the old man when, in 1914, he found his faith in the Emperor as a man of peace misplaced.

NO. 2679, VOL. 107]

The bare facts which we have mentioned in this notice of Andrew Carnegie's autobiography are transformed in their narration by the man himself into a most engaging personal story, replete with revelations of worldly wisdom, generous and upright character, and tender feeling. It is, indeed, well worth reading. One of America's greatest men—Elihu Root—in 1920 said of Carnegie at a meeting held in memory of his life and work:

"He belonged to that great race of nation-builders who have made the development of America the wonder of the world. He was the kindest man I ever knew. Wealth had brought him no hardening of the heart, nor made him forget the dreams of his youth. Kindly, affectionate, charitable in his judgments, unrestrained in his sympathies, noble in his impulses, I wish that all the people who think of him as a rich man giving away money he did not need could know of the hundreds of kindly things he did unknown to the world."

E. RAY LANKESTER.

Mathematical Papers of Huygens.

Œuvres Complètes de Christiaan Huygens. Tome Quatorzième. Calcul des Probabilités. Traavaux de Mathématiques Pures; 1655-1666. Pp. v+557. (La Haye: Martinus Nijhoff. 1920.)

THIS volume contains Huygens's celebrated essay, "De ratiociniis in ludo aleæ," and various minor mathematical papers of his earlier years. The theory of probability was founded in 1654, when a gambler who was interested in mathematics proposed to Pascal some problems connected with games of chance. Pascal corresponded with Fermat about one of these, the "problem of points," to which he attached the greatest importance. Two players of equal skill want each a certain number of points to win; if they stop their game before it is finished, how should the stakes be divided between them? Pascal and Fermat came to the same result, but gave different proofs. In the following year Huygens was in Paris and heard of this, but he neither met Pascal or Fermat, nor received any information as to their methods.

On his return home he lost no time in preparing his treatise on games of chance, which was published in Latin in 1657 as an Appendix to van Schooten's "Mathematical Exercises," and three years later in the original Dutch. The treatise contains fourteen propositions. The first three define the expectation of a player who has p chances of gaining a sum a and q chances of gaining b , as $(pa + qb)/(p + q)$. The six next pro-

positions discuss simple cases of the problem of points when there are two or three players; the method is similar to that of Pascal. The remaining five propositions deal with questions relating to dice, after which Huygens gives five exercises without demonstrations, which are left to the reader. Three of these had been proposed to Huygens by Pascal and Fermat. Their solution afterwards occupied Hudde, De Moivre, James Bernoulli, and others, and the generalisations to which they led had an important influence on the development of the theory of probability.

Several of the most valuable works of Huygens were published long after they were written, whereby he lost the priority of various important discoveries. Thanks to van Schooten, the treatise on probability was promptly issued, and it remained for more than fifty years the only introduction to the theory. Two English translations appeared, and James Bernoulli reprinted it in his "Ars conjectandi." Huygens continued up to 1688 to occupy himself occasionally with questions arising out of his treatise, and the five exercises at the end of it. He never published any of his notes, but they are now printed in the form of nine appendices. The same methods are followed in them as in the treatise.

The remaining two-thirds of the volume contain various mathematical studies from the years 1655 to 1666. Among these are some dealing with the theory of numbers, and particularly with the equation known as Pell's, $ax^2 + 1 = y^2$, where a is an integer which is not a square. Other notes discuss problems of rectification or quadrature, or examine the properties of the cycloid and other curves. Many of the results thus found were published by Huygens in 1673 in his "Horologium oscillatorium," but without proofs and without any clue to the way in which they were found. The studies now printed for the first time thus form a valuable supplement to that work and throw much light on the methods he employed to discover the results announced in it. A similar case is the "rule for finding logarithms" which Huygens communicated to the Paris Academy in 1666 without explanation or proof, and which was first found in the Archives of the Academy and published by Bertrand in 1868. It was suggested by Bertrand that Huygens must have known and used the series $\log(1+x) = x - \frac{1}{2}x^2 + \frac{1}{3}x^3 - \dots$. We see now that this was not the case, but that Huygens used a method founded on an approximate quadrature of the hyperbola deduced from a theorem which he had published in 1651.

Huygens also contributed to the solution of one of the burning questions of the day, the drawing

of tangents to algebraic curves. His notes on the subject are given in the present volume. He found, however, when the third volume of Descartes's Letters came out in 1667, that he had been anticipated. This was fully acknowledged by Huygens in a paper published by the Academy in 1693, in which the priority of Sluse and Hudde is recognised. The papers communicated by Huygens to the Paris Academy, and everything connected with them, are to be published in a later volume of the "Œuvres complètes."

J. L. E. D.

Four Aspects of Parenthood.

The Control of Parenthood. By Prof. J. Arthur Thomson and Others. With an introduction by the Bishop of Birmingham. Edited by Dr. James Marchant. Pp. xi+203. (London and New York: G. P. Putnam's Sons, 1920.) 7s. 6d. net.

DURING the past seven years the National Birth-rate Commission has been sitting, and it has published two reports, one in 1916, entitled "The Declining Birth-rate: its Causes and Effects," and the other, called "Problems of Population and Parenthood," in 1920. Smaller volumes have already sprung up around these large reports, and they have dealt with certain aspects or phases of the great general question of the falling birth-rate and all it may involve. One of these smaller books is the work before us; it contains short essays on four aspects of the subject—the biological, the economic, the social and religious, and the Imperial and racial; there is an introduction by the Bishop of Birmingham, and the whole is edited by Dr. James Marchant, who is the secretary of the National Birth-rate Commission itself.

The biological aspects are considered by Prof. J. Arthur Thomson, of Aberdeen University, whose fascinating works on natural history and sex are an assurance that facts will be found here clearly and attractively stated; and Prof. Leonard Hill, whose research work in physiology gives him every right to speak with authority upon such a subject as the present. Dean Inge and Mr. Harold Cox write on the economic aspects; Dr. Mary Scharlieb, the Rev. F. B. Meyer, and Principal A. E. Garvie represent the social and religious aspects; and Sir Rider Haggard, the novelist, and Marie Carmichael Stopes, the doctor of science and philosophy, deal with the Imperial and racial side of the matter. All the birds in this little nest of authors are not, however, singing in tune, and, in

particular, Dr. Mary Scharlieb, the doctor of medicine, differs in emphatic terms from Dr. Marie Stopes, the doctor of science and philosophy.

The second, third, and fourth aspects of the subject of the control of parenthood scarcely fall to be reviewed in a journal like NATURE, but the first may fairly claim notice. Prof. Hill's contribution is rather too closely packed with facts regarding embryology, pregnancy, housing, and food to be grasped easily in its significance; but its author is sturdily opposed to artificial means of preventing conception which "demand a premeditated act in what should be a natural function and disturbs the normality of the sexual act." Such a use of preventives tells also far more against the woman than the man. Prof. Hill sees the risks, the physiological risks as well as the social, of the only child. His solution of the problem of keeping down the vigour of sexual desire is "a wisely regulated diet, *plus* hard physical exercise and occupation."

Prof. J. Arthur Thomson, from the point of view of biology, writes with all his accustomed picturesqueness of imagery, but the brilliancy of his phrasing is somewhat of a danger, and may even constitute a sort of verbal camouflage, a risk which he himself seems to recognise when in his closing paragraph he says: "We must not, however, look at things too biologically . . . we are mind-and-body creatures, and the greatest thing in human life is love." After enumerating all the evils which may arise from birth control, he directs attention to the fact that the good side of the reduction of the birth-rate deserves more consideration than it usually receives. It may improve the health of both mothers and children, give quality for quantity, render life less anxious and earlier marriage more practicable, work against war, make woman's position more independent, and so forth. His contrast between the keeping up of numbers by the fertility or spawning method, with its unlimited production of lives the majority of which almost immediately cease, and by what he finely designates "economised reproduction associated with increased parental care," is absolutely conclusive in favour of the latter plan.

The spawning solution among the lower animals themselves is less effective in the long run than that which Peripatus adopted—viz. the giving birth to a few miniature adults ready at once to fend for themselves. "The tapeworm, with its degenerate body and drifting life of ease, has its millions of embryos; the golden eagle, with its differentiated body and controlled life, has two eaglets at a time." Yet it is not securely known that high individuation directly lessens fertility,

for whilst some of the greatest men were childless a fair list of famous fathers can be made out. After all, the strictly scientific or the rigidly biological aspect of human reproduction refuses to be dissociated from the other ways of looking at things; and Prof. Thomson closes with words which have weight: "If we lose the adventurousness of early marriage on meagre material resources, and the delight of having children while we are young enough to sympathise with them, we are missing some of the fragrant flowers of life."

Our Bookshelf.

Recueil de l'Institut Botanique Léo Errera (Université de Bruxelles). Publié par L. Errera. Tome iv. Pp. xi+653+plates. (Brussels: Maurice Lamertin, 1920.) 50 francs.

THIS ponderous volume contains a selection of papers published in various scientific journals from 1885 to 1900 by the late Léo Errera and other Belgian botanists. There are a few short communications by Errera at the beginning of the volume of a general nature, such as those on the law of the conservation of life, spontaneous generation, and the mechanism of sleep. The volume is mainly a collection of papers on plant cytology and on the physiology of organisms of simple structure. Workers specially interested in these branches will appreciate the advantage of associating in one volume a number of papers scattered through many different journals, but as all these journals are fairly accessible the production of a great mass of reprints may seem somewhat extravagant in view of the difficulties attending scientific publication at the present time.

The volume contains thirty-two papers in all; nineteen, mostly brief, are by Errera, including one in which the inheritance of acquired characters in a mould-fungus (*Aspergillus*) is maintained; others deal with protoplasmic movement, the ascent of sap, and an apparatus to demonstrate the mechanism of stomates. Communications by E. Laurent and G. Bullot deal with the physiology of growth and curvature of the fungus *Phycomyces*; and Jean Massart discusses the sensibility to various external influences of unicellular organisms under several headings. The irritability of *Noctiluca* he describes as analogous to that of the Sensitive Plant, the essential difference lying only in the manner of the reaction. The longest paper is by E. de Wildeman (published in 1893) on the formation of the dividing wall in cells; the subjects of study were mainly species of mosses and brown and red seaweeds.

Manuel de Topométrie. Opérations sur le Terrain et Calculs. By Jules Baillaud. Pp. vii+222. (Paris: H. Dunod, 1920.) 13 francs.

In this book Capt. Baillaud sets down his war experience in the preparation of the plans neces-

sary for artillery work, gathered during two years spent as Chef de Brigade Topographique. No claim is made to the production of a complete text-book of surveying; the author's limited experience would preclude that; and, as will be naturally understood, the practised surveyor has little to learn from this volume. The only point where it may possibly be of service in supplementation to more complete treatises is in the discussion given of the problem of resection, particularly of resection from more than three points, a problem somewhat neglected by English writers. A fervent claim is made to the superiority of the centesimal division of the quadrant, which, it is held, offers practical advantages, such that, once used, it is hard to understand how its merits can be doubted; "one returns with difficulty to the sexagesimal division." However this may be, the subject is now beyond discussion, there not being the remotest chance of the use of the centesimal system spreading outside the pale of the Service géographique de l'Armée. Even admitting that there are some gains in facility of computation, we think these dearly purchased at the cost of this isolation.

A recommendation is made that when taking out the number corresponding to a given logarithm a table of antilogs should be used, and it is regretted that no such table, extending to more than four decimal places, has been published. This must be read as meaning published in France. Such tables are common here, and an excellent little set of five-figure tables, including antilogs, is (or was?) procurable at the modest price of sixpence, while Filipowski's seven-figure tables are well known. They are not more generally employed solely because computers find that, on the whole, the use of the simple log table is preferable.

E. H. H.

Basic Slags: Their Production and Utilisation in Agriculture. (Reprinted from the Transactions of the Faraday Society, vol. xvi., part ii., 1920.) Pp. 259-335. (London: The Faraday Society, n.d.) 7s. 6d.

THIS full report of the discussion organised by the Faraday Society last March on the utilisation of basic slag in agriculture forms a convenient little booklet which agricultural lecturers and experts will find of considerable value.

The necessity for the discussion arose out of the change in the manufacture of steel which began before the war, but has proceeded at an increasing rate in the past few years. In consequence, agriculturists no longer obtain the slag to which they have been accustomed, and which was used in the classical experiments that have passed into agricultural tradition; they obtain instead something completely different under, however, the same name. An account of the discussion was reported in NATURE of April 8, 1920 (p. 183).

From the agricultural point of view there is an interesting account of the field trials with the new

slags, which suggests for them a better value than was first expected from the chemical analysis. On the works side the report does not make very hopeful reading; no easy way could be found for increasing the phosphorus content of the slag, apart from the simple addition of mineral phosphates, which would be quite unnecessary.

The meeting was useful, and the publication of the papers will prove even more so, as it will enable a wider circle to appreciate the present position of the basic slag problem. It is gratifying to know that, as the direct outcome of the discussion, the Ministry of Agriculture set up a Committee of steel-makers and agriculturists to go into the question of the improvement of basic slag, and to report on any action that could be taken. The Committee is presided over by Dr. E. J. Russell, of the Rothamsted Experimental Station, and is understood to be pursuing its inquiries with a view to an early report. The Faraday Society is to be congratulated on the success of its efforts.

Les Variations et leur Hérité chez les Mollusques. By Paul Pelseener. (Mémoires de l'Académie Royale de Belgique, Classe des Sciences, Collection in-8°. Série II., tom. v.) Pp. 826; 286 illustrations in the text. (Brussels, 1920.)

CUT off from the sea, his library, and his laboratory at Ghent, that doyen of malacologists, Dr. Paul Pelseener, during the German occupation of Belgium, fell back on his note-books and such material as lay to his hand, and has put together a fine volume that will be a work of reference for practically all time.

The variations observable in the Mollusca have never hitherto been systematically studied as a whole. Dr. Pelseener now takes them up seriatim as they occur in the shell, in the external features of the animal, and in the various internal organs and their systems (circulatory, respiratory, nervous, etc.), plentifully quoting original observations in addition to his own, and illustrating the whole with reproduced and new figures. He classes these variations and discusses their interrelationships, individual and specific, in different organs, their cause, especially when due to environment, and finally their heredity.

It is impossible within the limits of a short notice to summarise even the author's conclusions: the work itself must be consulted. When, however, he states that there is no example in the Mollusca of preadaptation, we venture to think he must have overlooked the case of the myophore in Velates, and of the dorsal depression in the shell of the young Nautilus, which later on receives the ventral curve of the preceding whorl, as pointed out by Hyatt in his "Phylogeny of an Acquired Characteristic."

The book is touchingly dedicated "A la mémoire de mes Compatriotes victimes de l'agression Allemande (1914-1918)." B. B. WOODWARD.

Letters to the Editor.

[The Editor does not hold himself responsible for opinions expressed by his correspondents. Neither can he undertake to return, or to correspond with the writers of, rejected manuscripts intended for this or any other part of NATURE. No notice is taken of anonymous communications.]

Amplifying the Optophone.

IT may be of interest to record some experiments that I have recently been making on the application of a thermionic amplifier to increase the volume of the sounds produced by Dr. Fournier d'Albe's very wonderful optophone so as to render these sounds audible to everyone in a room without the necessity of each listener being furnished with a separate telephone receiver.

The experiments were carried out at the instance of Mr. J. M. McCarthey, who is teaching blind soldiers to read with this instrument, and who asked me whether it would not be possible to magnify the sounds sufficiently to enable a class of a dozen or more to hear them simultaneously.

The Fournier d'Albe optophone instrument employed was one of the improved type designed and manufactured by Messrs. Barr and Stroud, and the amplifier I found to work best out of several I tried was an audio-frequency one with three "R" valves, transformer-coupled, of the French military type. This was used with a Brown loud-speaking telephone with considerable success.

In Mr. McCarthey's opinion, and so far as a person such as myself, who has no experience with the optophone, could judge, the best results were obtained when the optophone was arranged for what is technically known as "black sounding," when the white paper is represented by silence and notes are sounded as the beam of light passes over the black letters.

I have very little doubt that still better results could be obtained with an amplifier specially designed for the purpose. Further experiment is desirable in order to obtain the best results, but, so far, what has been accomplished is quite encouraging.

A. A. CAMPBELL SWINTON.

66 Victoria Street, London, S.W.1,

February 25.

Molecular and Cosmical Magnetism.

DR. CHAPMAN'S important letter (NATURE, November 25, 1920) bases a theory of cosmical magnetism on the presence of gyroscopic magnetic elements proved to exist in ferro-magnetic substances by my investigations on magnetisation by rotation. But he considers my fundamental theory to require serious modification. As I understand his letter, however, his theory is identical with mine (see *Science*, vol. xlviii., p. 304, 1918, and references) except as to paramagnetic and diamagnetic bodies. He has, I think, confused my treatments of magnetic intensity and intensity of magnetisation.

While in my papers electron rings or orbits have been assumed, the fundamental theory is essentially the same if ring electrons or magnetons of other types, preferable for Dr. Chapman's purpose, are assumed instead; and I have referred to this equivalence before the Physical Society and elsewhere.

The gist of the theory is this: A magneton or electron orbit, being a gyroscope, tends to take an

orientation with the direction of its revolution coincident with that of any rotation impressed upon it. Being a magnet, it also tends to set with its axis parallel to an impressed magnetic intensity. Ultimate coincidence in either case may be prevented by extraneous forcives. But, in given circumstances, whatever the forcive towards alignment, and whatever alignment of the magneton is produced by a magnetic intensity, H will be produced by rotation about the direction of the intensity with velocity $\Omega = H/R$, where R is the ratio of the angular momentum of the magneton to its magnetic moment. The general idea has been applied to cosmical magnetism by Schuster (1912), by Einstein and by de Haas (1915), and by myself (1909 and 1915), though not with Dr. Chapman's detail.

If all the magnetons within a body are alike, rotating it at velocity Ω will produce the same magnetisation as would be produced by applying a uniform magnetic field of strength $H = R\Omega$.

For weak fields the ferro-magnetic bodies rotated all receive intensities of magnetisation proportional to the intensities of the fields applied, and are thus magnetised by rotation proportionally to velocity. This proportionality exists only for elastic displacements to which Dr. Chapman refers (and to which I have referred, comparing the molecular forces to those due to springs).

If the magnetons in a body are of two kinds, positive and negative, with constants R_1 and R_2 , rotating the body will have the same effect as if a magnetic intensity $H_1 = R_1\Omega$ were applied to the positive magnetons and an intensity $H_2 = R_2\Omega$ were applied to the negative magnetons. If the effect on the negative magnetons is preponderant, the rotation will thus produce an intensity of magnetisation in the direction of H_2 , but of magnitude less than that which would be produced by the intensity $R_2\Omega$ if all the magnetons were negative.

When the displacements are not elastic my theory gives results analogous to those of Voigt for a swarm of magnetons in an ordinary magnetic field. If there are N similar magnetons per unit volume, if the rotations are damped only about the axes perpendicular to the magnetic axis, and if the effects of collisions and the molecular field are negligible, all the magnetons, even in the weakest magnetic field of strength H , will ultimately become oriented with their axes in the direction of the field. In this case, if C and U denote the moment of inertia and initial (permanent and undamped) angular velocity about the magnetic axis of a magneton, the intensity of magnetisation will be

$$I = NC/R.(U - H/R).$$

The first and principal term is entirely independent of H . The orientation is produced by the field, but only the time taken to arrive at the steady state is affected by its magnitude. If collisions are not absent, or the molecular field becomes appreciable, the intensity of magnetisation will not reach saturation, but will increase with the field strength, being greater for a given applied field strength the greater the time between collisions and the weaker the molecular and demagnetising fields.

For the same swarm of magnetons subjected to an angular velocity Ω instead of a magnetic field with intensity H , we have, when the effects of collisions and the molecular and demagnetising fields are negligible,

$$I = NC/R.(U + \Omega).$$

The first and only important term is independent of Ω . Here the orientation is produced by the velocity

impressed, but only the time taken to reach the steady state is affected by its magnitude. The effects of collisions and of molecular and demagnetising fields are essentially the same as in Voigt's case.

Like Dr. Chapman and others, I have considered the possibility of dissociations increasing the intensity of magnetisation of hot bodies, and I have plans for experiments in this field. If the gyroscopic behaviour of a magneton is to account for cosmical magnetism (and it was the contemplation of this which led me to the rotation experiments), we must, as has long been evident, assume a constitution of the earth and sun different from that of materials on which experiments have previously been made.

On my theory, a magneton in a diamagnetic or paramagnetic body set into rotation is acted upon by the same alignment force as if alone or in a ferromagnetic body. But the intensity of magnetisation in the latter is small, for the same reason for which it is small when the body is placed in an ordinary magnetic field. In the former it is zero, because, on the assumption I have made, with Weber and Langevin, the magnetons are grouped rigidly together so that no element with a magnetic moment can have its orientation changed. This is the only point on which Dr. Chapman's theory, as I understand it, differs from mine. Rotation experiments on diamagnetic and paramagnetic bodies by Lébedew and by Mrs. Barnett and myself have hitherto given no magnetisation.

S. J. BARNETT.

Washington, D.C., January 31.

I FULLY agree with Prof. Barnett's statement of the theory of magnetisation by rotation, and regret that through misunderstanding his treatment of magnetic intensity I suggested that his theory required modification. I am glad to know that he contemplates experiments on the rotation of hot bodies; this point, and the greater possibilities afforded if the magnetic elements remain intact at high temperatures, are the matters to which chiefly I wished to direct attention. Experiments made here with Dr. Oxley have negated my suggestion that diamagnetic and paramagnetic bodies should also show magnetisation on rotation, thus confirming the previous results mentioned by Prof. Barnett; experiments on hot ferromagnetic bodies are not yet advanced sufficiently to state whether they support the view that the earth's magnetism may depend on its high internal temperature. Further trial seems to preclude the possibility of trustworthy calculation at present, and the view must be tested by experiment. Until this is done it seems useless to enter into further details of the earth's field and its secular variation.

As regards the sun, later consideration of the narrow radial limitation of its magnetic field leads me to think that no simple magnetisation, by gyroscopic action or otherwise, is the probable cause; any such view requires two hypotheses, one to explain the production and the other the neutralisation of the field. A unitary hypothesis, such as the second of those indicated by Sir J. Larmor in the British Association Report for 1919, seems preferable.

S. CHAPMAN.

The University, Manchester, February 22.

Transcendental Premises in Science.

PERHAPS you will permit one who belongs to a considerable section of your readers who are neither mathematicians nor neo-physicists to state how the

very remarkable discussion on Prof. Einstein's theory in NATURE of February 17 appears to some of us.

Mathematics to us is a very precise and complete form of deductive logic applied to space and number. It differs from ordinary logic only in having its arguments set out in a symbolical shorthand instead of in words, and thus enables a long deduction to be condensed into a short statement. This unfamiliar form of notation and condensation of the argument are the chief stumbling-blocks to the outsider.

Like other forms of logic, it is an art rather than a science, namely, the art of drawing legitimate conclusions from premises. In essence, it has nothing to do with the truth or falsity of the results. These depend entirely on the nature of the premises. The most faultless string of equations, like the most immaculate collection of syllogisms, may conclude with an absurdity or a stupendous error if the premises are faulty. The logical mill by which the results are obtained may turn out good flour or only chaff. This depends entirely on what it is fed with.

This is why the Philistine who is not a mathematician sometimes shakes his head when he is presented with a series of equations on the blackboard and his teacher says to him: "Look there. What do you say to that?"

What the Philistine doubts is not the accuracy of the deduction in this case, but the validity of the premises used in the new departure, which turns largely on the nature of space and time as defined by the neo-physicists. Granting that they are legitimate, the results are unquestionable. Are they legitimate? Let us turn to space. The first remark I would make is that, whatever its value, the definition in question represents something entirely and confessedly different from space as known to the great mass of men and to all philosophers, mathematicians, and physicists until the last few decades, and it has, therefore, no claim to be called space at all.

Space was defined by Newton by two predicates, namely, extension and immovability. I would presume to add a third one, quite necessary as things are now marching, namely, that any finite portion of space may be measured by three co-ordinates at right angles to each other and passing through one point—or, in other words, space has three dimensions. This is the only space known to human experience, as it was to the early geometers. The addition of a fourth or any number of other dimensions as factors of space is inconceivable unless we entirely alter the comprehension and connotation of the words "space" and "dimension." You may call the result what else you will; you are misleading a great many innocent people in calling it "space," like the Pragmatist is doing when he defines the "truth" he writes about as "the useful."

When Riemann read his famous paper before the Göttingen Academy at the instance of Gauss, who presided on the occasion, he first introduced the notion of space with more dimensions than three. He spoke entirely as a pure mathematician. His premises were not facts, but definitions of abstractions which could not materialise into realities. With his abstract postulates he was able to frame a series of equations which were quite legitimate in form, but the conclusions of which were also abstractions, and could not be presented in a mental picture or as representing anything in Nature. Since then, a large literature has grown up in regard to these phantasms of mathematical abstraction. Attempts—very futile attempts, as it seems to me—have been made to translate the conclusions of Riemann's equations into

pictures in which lines with the most wonderful contortions have been supposed to represent the effects of adding new dimensions to space. They are useful only as illustrations of the enormous gap separating this so-called hyperspace from the space of human experience. There have latterly been attempts to go much further and to import the creations of Riemann's imagination into the analysis of physical problems, into speculations on the construction of space beyond the range of human vision, and to postulate on the existence of space of different kinds, including curvilinear space, all of which I deem to be entirely outside the province of legitimate induction. The word "curvilinear" describes a predicate or function of matter, but not of space; as well might it be applied to a vacuum. Nor do I exactly know what Prof. Einstein means by relative space as used by him. The word "relative" has a perfectly recognised meaning in philosophy as the antithesis of "absolute." If it is used by him in this sense, assuredly there is no novelty in it. It was the fashion of the philosophers of the ancient world and of the schoolmen of medieval times to separate space and time from the other phenomena of Nature. They held that both have an objective existence, and are not, as they deemed, entirely subjective and transient, like the more obvious presentations of sense. There are many rebels against this notion now who claim that space is as much entitled to be called a subjective phenomenon as is colour or taste, and that a man void of the senses of sight and touch could have no cognisance of what we mean by space. As to the size of any portion of space being relative only, I happen to have myself a personal proof of it in the fact that, my two eyes having lenses of different curvature, any object seen with one appears to my consciousness as one-third larger than when seen by the other. In the sense here mentioned I understand the word "relative," but I fail to understand what Prof. Einstein means by it.

Meanwhile, let us try to be content with our limitations. One of the earliest antinomies recorded was the question of whether space is limited or unlimited. It remains an antinomy still, and must remain so. The one alternative is as incredible and unimaginable as the other, and the Sphinx refuses to reply when she is asked about it. There is no calculus available by which men with limited faculties and all prone to error can map out infinity, discover the secrets of the realms beyond the stars, and transcend the world accessible to our senses, and which alone can be equated with, and adequately tested by, inductive methods. Let us leave to the pure mathematicians the delightful occupation of rambling through wonderland with their imagination. It would be unreasonable to deprive them of their mental relaxations and amusements in the land of dreams in which they have such ample scope for mental dexterity. All I maintain is that these dreams are entirely out of place in that branch of inductive thought called science. My most gifted friend Mr. Hobson, of Queens' College, Cambridge, a very original mathematician, in a lucid account of the aims and purposes of pure mathematics, emphatically protests against mixing up that empyrean study with the mundane realities of plebeian physics.

Lastly, let us remember a graphic phrase of Mansel when dealing with transcendentalism in philosophy. He warned his pupils that "a man who tries to look down his own throat with a candle in his hand must take care that he does not burn his back hair."

I have touched only the fringe of the subject raised
NO. 2679, VOL. 107]

in this most interesting discussion, for which we are all grateful, but I feel that whether the space discussed in it is limited or not, yours is very definitely limited, and I must trespass on it no further.

HENRY H. HOWORTH.

45 Lexham Gardens, February 21.

Natural History of Porto Santo.

THE Island of Porto Santo, one of the Madeira group, is probably best known to biologists on account of the famous rabbit still found commonly there. Darwin showed that the animal differed conspicuously from the English rabbit, and inferred that it had evolved into a new race since its introduction into the island some hundreds of years ago. Haeckel gave it a distinctive name, *Huxleyi*. It is, indeed, a distinct race or subspecies from the English rabbit, but zoologists had failed to observe that it was identical with the Lusitanian animal, which had not then been segregated by them. Thus the Porto Santo rabbit loses its importance as evidence of evolution, being, in fact, the South European subspecies of *Oryctolagus cuniculus*.

To the modern biologist, however, Porto Santo has far more attractive features. It is a small island, some 6½ miles by 3 miles, but of irregular shape, with a number of adjacent islets. Yet on this small area are found as many as forty-one native species of Helicoid snails, the very much larger island of Madeira having only thirty-seven. A few of the forty-one are now extinct, being represented only by fossils or empty shells. On the other hand, the number may be considerably increased if we add the varieties and local races, some of them quite distinctive. In addition to the native species, there are some which have been introduced, and *Helix pisana*, in particular, exists in countless myriads, with many variations. It seems to have been no obstacle to the spread of this snail that the island was already occupied by a prodigious number of land mollusca. Whether the advent of *H. pisana* reduced the numbers of the native species it is hard to say, but the latter still abound everywhere.

The largest and finest snail of Porto Santo is *Pseudocampylaea Lowei*, Férussac, or *gigantea*, Lowe. It is a quite common fossil in beds which must apparently be referred to the Pleistocene, but it has been found living, and a perfectly fresh shell is to be seen in the British Museum (Natural History). I found no living specimens, but obtained several shells in ploughed fields, showing the pink apex and traces of the bands; certainly not fossils. It may be that agriculture has been the principal cause of the extinction (it is probably now extinct) of this fine mollusc. *Leptaxis fluctuosa*, Lowe, is another species which seems to be extinct, but I found a recent shell showing the coloured banding. The islets about Porto Santo are extremely interesting. The Ilheo de Cima, on which the lighthouse stands, is about 1200 metres long and less than 500 metres across at its widest part. It is scarcely 300 metres from the main island, and there are half-submerged rocks in the channel. Yet on this islet we find swarming under stones the very distinct and remarkable snail *Geomitra turricula*, Lowe, found nowhere else in the world! The large *Pseudocampylaea portosantana*, Sowerby, which is a sort of smaller edition of *P. Lowei*, abounds on the main island. But on the Ilheo de Cima it has not merely one distinct race, but two. On the top of the islet, near the end facing the main island, we find a very large, dark, depressed race, the greatest diameter

of which is 29-31 mm. This is the race *cimensis* of Wollaston. About the landing-place, on the east side, is another race, smaller than usual (maximum diameter 22-25 mm.), not dark, but well and conspicuously banded, and with the spire greatly depressed. It may be called race *evoluta*; it has possibly become distinctly segregated since Wollaston's time, since it combines the characters of the other forms, and is the sort of thing which might doubtless be obtained from them by careful breeding under artificial conditions. At the same time these races *cimensis* and *evoluta* exist to-day as pure types, very distinct and easily recognised, occupying different stations on the Ilheo de Cima.

In some ways the Ilheo de Nordeste, the most remote of the islets about Porto Santo, is even more interesting. It is a mere rock in the ocean, about 500 metres long and 300 metres high, somewhat less than 3 km. from the main island. With the aid of our boat's crew of strong Portuguese sailors, my wife and I were able to land and climb about the excessively rocky surface. The vegetation is scanty, but includes the beautiful stock, *Matthiola maderensis*, Lowe, and the orange-flowered Lotus. Ants and millipedes seemed to be entirely absent. On this lonely rock, and nowhere else, lives the beautiful snail *Cryptaxis forensis*, Wollaston, with dark, keeled shell and pink lip and apex. Here, and not elsewhere, is found (in great abundance) the small, button-like *Discula polymorpha* race *gomesiana*, Paiva. But here also is the invading *Helix pisana* and the native *Plebecula punctulata*, Sowerby, which abounds on the main island.

The curious little *Geomitra paupercula*, Lowe, abounds under rocks in dry places at Porto Santo and on the adjacent islets. It is unique in the group for its wide distribution, being found also in Madeira and all three Desertas, and in the Azores and Canaries. It sticks very tightly to the rocks or to any other convenient object. I once saw a beetle (*Helops*) walking along with one of these snails on its back. It is probable that at different times these snails have attached themselves to the feet of birds, and thus got carried across the sea.

The soundings taken many years ago by H.M.S. *Styx* (Capt. Vidal) show that Porto Santo rests on an elevated bank, indicating a former island perhaps six or seven times as large. The margins of this bank appear to be cliff-like, almost vertical, the depths suddenly increasing from, e.g., 45 to 200 fathoms. This might be taken to indicate the cliffs of the former island, perhaps dating from the Mesozoic. The oldest deposits on the island containing fossils are Miocene, and are marine. At Calheta Point one may see this Miocene material, with large shells and corals, mixed with dark volcanic rock, which seems to have been thrust up from beneath. The suggestion is obvious that the island dates only from the Miocene, but, apart from the *Styx* soundings, it seems improbable that the remarkable snail fauna has wholly evolved from some immigrant or immigrants since that time. The sandy fossil beds containing land shells must be considered Pleistocene. Wollaston calls these shells subfossil, but they are quite comparable with Pleistocene fossils elsewhere, and show about as much difference from the living fauna as might be expected. At the base of this series, in the Campo do Baixo, is a dense stratum of marine Pleistocene, which has been studied and will, I hope, be fully described by my friend Senhor A. C. de Noronha, a very keen and able naturalist who was born in the island.

The insect fauna of Porto Santo is scanty, but the collections obtained will doubtless prove to be of ex-

ceptional interest when studied. Three species of butterflies are common, *Colias edusa*, *Vanessa cardui*, and *V. callirhoë*, the last breeding abundantly on the nettle *Urtica membranacea*, Poir. Wollaston considered that specimens of the Porto Santo *V. callirhoë* were smaller than those of Madeira, but I could not see any difference. We found only two species of bees, both *Andrena*. No fossorial wasps could be found, though the sandy country seemed exactly suited to them. The numerous spiders appear to have no Pompilidæ to attack them. At the back of the town rises the tall Pico do Castello, and on its summit may be seen a building in which the inhabitants used to take refuge from the Moorish pirates. A cannon remains on the side of the mountain, half-buried in the earth. To-day the lowlands of Porto Santo are overrun, like those of Madeira, by the obnoxious little ant *Iridomyrmex humilis*, which has exterminated the once-abundant house-ant, *Pheidole megacephala*. But on the top of the Pico do Castello we found the *Pheidole* still holding out, with numerous strong nests.

The flora is scanty, and was not specially studied by us. We were interested to find the orchid *Genmaria diphylla*, Lk., on the Pico do Castello and Pico d'Anna Ferreira. The Pico do Castello has been extensively planted with trees in recent years, and I thought the orchid might have been introduced with soil, but this seems unlikely in the case of the Pico d'Anna Ferreira, which remains in its original condition.

The people of Porto Santo are a hardy and industrious race who win a scanty living from the sea and soil. We found them exceedingly friendly and cheerful, and left them with strong feelings of regard. We were specially indebted to our guide, Senhor Juan do Pico, who knew every path and byway.

T. D. A. COCKERELL.

Hotel Bella Vista, Funchal, Madeira,

February 3.

The Energy of Cyclones.

IN the recent discussion in NATURE on the energy of cyclones no mention has been made of tropical cyclones, although these are the most remarkable phenomena of their kind.

It is impossible to apply to these cyclones the theories which ascribe the energy of the rotating wind system to the re-adjustment of equilibrium of warm and cold masses of air within that system, since in the cyclones of the tropical zone temperature and humidity are symmetrically distributed. In these cyclones warm and cold sectors do not exist. The Indian meteorologists Henry Blanford, Sir John Eliot, Fr. Chambers, and W. T. Willson have published papers on the cyclones of the Bay of Bengal and the Arabian Sea, giving a full explanation of their origin and development. These very important works no longer receive the attention they deserve. They also throw much light upon the source of energy in these cyclones. I endeavoured to make a rough calculation of the energy contained within one of these whirls, taking into account the preceding pressure distribution over the hurricane region, and the results were in good agreement with the observed wind forces. I should therefore like to direct attention to this work.

The calculation was based upon observations of the Backergange cyclone. It is given in my "Lehrbuch der Meteorologie" (1901 edition, p. 579, footnote), as well as in a paper, "Remarks on the Origin of (Tropical) Cyclones" (*Meteorologische Zeitschrift*, 1877, August, p. 311). My calculation has no ap-

plication to the cyclones of middle and higher latitudes, as it presupposes simple whirls like the symmetrical cyclone of the tropics.

J. VON HANN.
Vienna, February.

The Ascent of Mount Everest.

THE opportunity which mountaineers and geographers have long looked for of approaching Mount Everest from the north has at last arrived. The Tibetan Government has given its consent for the dispatch of an expedition to explore the mountain. The expedition is now being organised by a combined committee of the Royal Geographical Society and the Alpine Club, and an attempt will be made to ascend this the highest mountain in the world.

The cost of the expedition is estimated at about 10,000*l.* Already a quarter of this amount has been raised among the members of the two societies. But the expedition will have to leave England very shortly, and it is essential to its success that the equipment shall be the best possible, and that no financial uncertainty shall delay the organisation in India of a picked corps of Himalayan porters and of an adequate transport service. Heavy initial outlay is therefore involved, and we now appeal to the general public, confident that it will wish to further an enterprise the successful accomplishment of which will bring so much credit to this country.

Subscriptions should be sent to the Treasurer, Royal Geographical Society, Kensington Gore, S.W.7, or to the Bank of Liverpool and Martins (Cocks, Bidulph, and Co.'s branch), 43 Charing Cross, S.W.1.

FRANCIS YOUNGHUSBAND,
President, Royal Geographical Society.

J. N. COLLIE,
President, Alpine Club.

February 23.

Pure Organic Chemicals.

I AM glad to see that the writer of the leading article in NATURE of February 24 directs attention to the concern with which research workers view the possibility of foreign organic chemicals being restricted or excluded by legislation in the interests of British manufacturers.

The latter are not yet in a position to supply many materials in that state of unquestioned purity such as one associates with the old firms of Merck and Kahlbaum in Germany and Poulenc Frères in France.

As an illustration I may mention that I recently ordered a pound of propyl alcohol (as catalogued) from a British firm, and at the same time a like quantity from Poulenc Frères. The first forwarded a material costing 18*s.* which consisted of a mixture boiling over a wide range of temperature but containing no propyl alcohol, whereas the French firm supplied a pure sample of nearly constant boiling point costing 11*s.*, including postage.

J. B. COHEN.
The University, Leeds, February 25.

Nature of Vowel Sounds.

WITH regard to the very interesting researches on vowel sounds by Prof. Scripture published in NATURE of January 13 (p. 632) and January 20 (p. 664), I beg to be permitted to state that the attempt of Helmholtz to produce vowels with smooth, simple tones has since been fully confirmed. Using, instead of tuning-forks, bottles caused to sound by currents of air blown over their orifices, which, as is well known, give almost perfectly simple tones, I have been able to demonstrate this myself. The remarkable and

extended investigations of Prof. Miller described in his book, "Science of Musical Sound," have fully proved the statement of Helmholtz to be true, as have also the researches of Prof. Stumpff, of Berlin. I am therefore of the opinion that the Helmholtz theory of vowel sounds can scarcely be doubted any longer. Hermann's and Scripture's method of producing vowels by sending puffs of air through a resonator does not contradict this. Whenever a complex vibration is set up which appears to be a mixture of simple tones corresponding to the sound of a vowel, there will be produced a vowel. However, it is very important to have repeated Hermann's experiments and extended them by using resonators with soft walls.

CHARLES DE WESENDONK.

Hôtel Eden, Montreux, Switzerland.

THE above letter very properly directs attention to the excellent work of Prof. Miller. It is worth while to study Fig. 130 of his book, reproduced below. For the tuning-fork there is only one tone, namely, the fundamental. For the other instruments the fundamental appears clearly, but for the voice the fundamental is lacking. Thus the strongest tone in a vowel, the voice tone, does not appear in the plot. This is in agreement with the work of Hermann and myself. As explained in NATURE of January 13 and 20, this arises from the fact that the voice tone consists of a series of puffs.

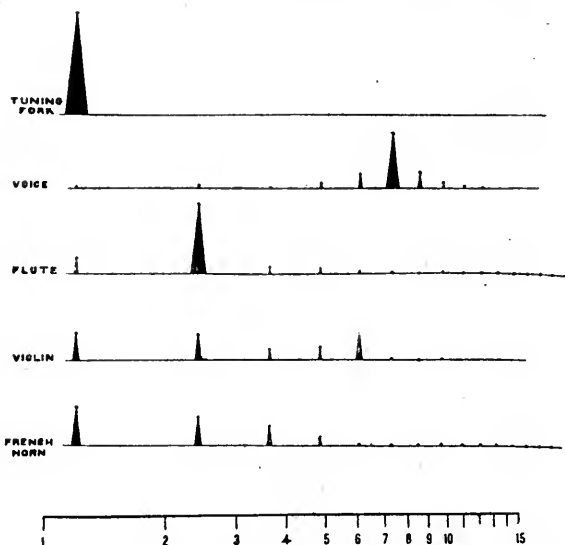

FIG. 1.—Distribution of energy in sounds from various sources

Prof. Miller's plots show that for the musical instruments the harmonics appear strongly at certain places. For the voice, however, the seventh, eighth, and ninth harmonics appear. Three tones in the relations 7:8:9 sounded together would produce a most discordant sound with disturbing beats, and certainly not the clear tone that characterises a vowel. As explained in NATURE, such a group of neighbouring harmonics arises from the presence of an inharmonic in this region which can express itself only in this way.

It is interesting to note that Prof. Miller's results give direct evidence of both elements of the new vowel theory, namely, that the voice tone consists of a series of puffs, and that the vowel tones are independent of the pitch of the voice tone. From Prof. Miller's plots they would appear always to be inharmonic.

E. W. SCRIPTURE.

Early Chemistry in Oxford.¹

By SIR EDWARD THORPE, C.B., F.R.S.

AN attempt is being made at Oxford to bring together such scattered information as exists concerning the early history of science in that University, and to commemorate the achievements of Tunstal, Richard of Wallingford, Merle, Mauduit, Rede, Aschenden—forgotten worthies of a medieval time—and of Digges, Recorde, Dwight, Lower, Mayow, and others of a later period. As regards physical science, it is intended to illustrate its development by a sort of *catalogue raisonné* of scientific instruments, mainly from the collections in the various colleges and University departments which are known to be rich in specimens of the best work of the craftsmen of the seventeenth and eighteenth centuries.

The present booklet—the first instalment of the projected series—deals with the history of chemistry at Oxford down to the time of Daubeny. It traces the beginnings from Roger Bacon (1214–92), who may be said to have well and truly laid its foundations as a science by his insistence on the appeal to experiment. His dictum, *Sine experientia nihil sufficienter sciri potest*, now over the entrance to an Oxford laboratory, is significant not only of his breach with scholasticism, but also of his clear recognition of the path that science must follow. Mr. Gunther deals only in very general terms with the influence of Bacon—more with his teaching and the essential nature of his philosophy than with his actual achievements. He sees his limitations in the dominance of the Greek philosophy, and in his inability to act, through force of circumstances, upon his own principles. Considering that Bacon's name is associated with Oxford traditions, and that the book is primarily intended for Oxford students, to whom, indeed, it is dedicated, more space might well have been allotted to one who was "at once the earliest and among the greatest of our [Oxford] teachers."

The early association of chemistry with medicine was, of course, felt in Oxford, as elsewhere. The Spiceria of medieval Oxford were to be found in the High Street, near the site of the present front of Brasenose College. Their shops, which did not escape being occasionally "ragged," dealt originally in spices, seeds, and roots, and only gradually developed into apothecaries. One of the earliest was that of John le Spicer, whose shop, in 1332, was in All Saints parish. Mr. Gunther furnishes a plan showing the apothecaries' quarters in Oxford, and he gives illustrations of their receptacles for drugs from the series in the Ashmolean Museum.

From the times of Roger Bacon and the early spicers to the middle of the seventeenth century is a big jump. But Oxford contributed nothing to chemical science during the intervening period. The study of natural phenomena was foreign to the scholastic learning of the time. As Mr. Gunther points out, "the long list of Waynflete

readers of Natural Philosophy, none of whom left any original work, shows how barren discourses on this subject must be, when they are founded on Aristotle rather than on Nature." There were, however, alchemists during this period in Oxford, among them the Rosicrucian Fludd, of St. John's, in 1591, and Simon Forman and John Thornborough (1602), of Magdalen. Mention should also be made of John French (1616–57), who wrote treatises on distillation, "partly taken out of the most select Chymicall Authors of several Languages, and partly out of the Author's manual experience." But the real awakening in Oxford occurred during the troubles of the Civil War, when Wilkins, Ward, Bathurst, Petty, and Willis met weekly, first in an apothecary's house for "the convenience of inspecting drugs," next at the lodgings of Dr. Wilkins, warden of Wadham, and afterwards at the lodgings of Mr. Robert Boyle. The last-named had settled, in 1654, in Crosse's rooms in the High Street, having recently left Ireland, "a barbarous country," he says, "where chemical spirits were so misunderstood, and chemical instruments so unprocurable, that it was hard to have any Hermetic thoughts in it."

This association of the progenitors of the Royal Society with Oxford is an incident of which the University is justly proud, and Mr. Gunther treats of it in some detail. Boyle, who was of a tender constitution, was devotedly looked after by his sister, Lady Ranelagh, who came up to Oxford to settle him in his lodgings. While there, we learn from a letter which Mr. Gunther prints, she was not wholly satisfied, as she thinks the position of the doors with respect to the fireplace, even in the warmest room, will occasion draughts, "the inconvenience" of which "may be helped . . . by a folding screen." Boyle, however, was sufficiently comfortable to remain there for fourteen years, when he removed to London to his new laboratory at the back of Lady Ranelagh's house in Pall Mall. Crosse's house in Oxford was pulled down in 1809; it was where the Shelley memorial now stands. Mr. Gunther gives a reproduction of an old print showing it and its relation to University College and other buildings in the High Street (Fig. 1).

Oxford owes to Boyle its first regular teacher of practical chemistry—Peter Sthael, of Strassburg, "a Lutheran, a great hater of women, and a very useful man," who had been engaged by Boyle as one of his assistants. He began his courses in 1659. Among his pupils was John Locke, of Christ Church, "a man of turbulent spirit, clamorous and never contented. The club [class] wrote and took notes from the mouth of their master, who sat at the upper end of a table; but the said J. Lock scorned to do it; so that while every man besides of the club were writing, he would be prating and troublesome." That the fingers of the troublesome J. Locke did actually itch to be at chemical experimenting is shown by

¹ "Early Science in Oxford." Part I, "Chemistry." By R. T. Gunther. Pp. vi+91. (Oxford: The Oxford Science Laboratories, 1920.) 6s.

his subsequent action, for an account of which to pieces, but the whole place is filthy." Mr. we must refer to the book itself.

Oxford is associated with the discovery of the emerged from the furnaces of the Ashmolean—art of salt-glazing stoneware, due to John Dwight namely, Dr. John Wall, a fellow of Merton, who (1661), of Christ Church. John Ludwell, fellow probably gained there the knowledge of operative of Wadham, about 1670 experimented on the chemistry which enabled him to study the manufacture of glass, which he surmised was a facture of porcelain, and ultimately to found the famous china factory of Worcester.

With the removal of the members of the Another Dr. Wall, known as Martin Wall "philosophicall Clubbe" to London, the pursuit of (1747-1824), a fellow of New College, in 1781 experimental inquiry languished and almost died became public reader of chemistry. He, accord-

out. The chief glory of Oxford in the years immediately following the Restoration was John Mayow, fellow of All Souls, who left the University in 1675 and settled at Bath as a physician. He died four years later at the age of thirty-six. On his epoch-making work—his "Tractatus de Respiratione," in which he recognised the real nature of atmospheric air, and of the function of one of its constituents in supporting combustion and respiration—as also on his subsequent treatises in which he further elaborated his practical discovery of oxygen, there is no need to enlarge. Mr. Gunther styles him "the greatest chemist whom Oxford has ever produced."

The first University chemical laboratory was established by Elias Ashmole, whose original scheme for the foundation of a scientific institution comprised an "elaboratory," as well as a repository for his "raree show" of archaeological curios. The *Officina Chymica* was housed in the cellar of the building, which was erected in 1683, and placed under the charge of Dr. Plot. "Certaine scholars" of the Philosophical Society of Oxford thereupon "went a course of chimistrie" and "had meetings in the large room over the elaboratory Every Friday in the afternoone to talke of Chymicall matters," "their discourses" being "registered down" by Dr. Plot. Plot resigned his office in 1689, and was succeeded by Mr. Edward Hannes, of Christ Church. In 1704 Hannes was followed by Dr. John Freind, also of Christ Church, who is described as "well-skill'd in Speculative and Practical Chymistry," and "the first who applied the Newtonian philosophy to chemistry." He was assisted by Richard Frewin, of the same college, and Camden professor of ancient history, who seems to have had charge of the Ashmolean Laboratory. The latter, according to Uffenbach, the traveller, who visited it in 1710, "does not trouble much about it, and the operator, Mr. White (said to be a good-for-nothing man) still less." "Not only are the finest instruments, tiles, and such like, almost all broken

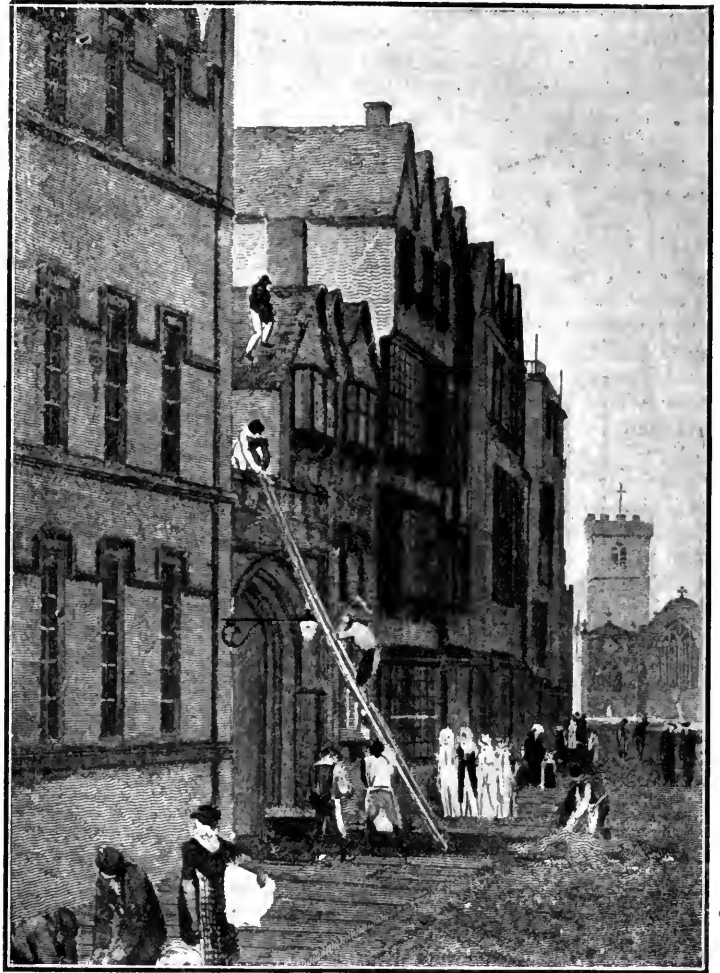

University College. Crosse's. Three Tuns. Tillyard's.
FIG. 1.—Site of Boyle's Laboratory. From "Early Science in Oxford."

ing to our author, taught that chemistry "is an immediate revelation from Heaven to Adam, and had its name from Cham, the progenitor of the Egyptians." "Chymistry" is not only "a piece of knowledge not mis-becoming a gentleman, but it promises to afford a firm and elegant basis for a compleat skill in Natural Philosophy—and certainly will enable any divine in Europe to describe with confidence the operation by which Moses might have reduced the golden calf to powder—to the confusion of Voltaire and all his disciples."

The early memoirs of the Manchester Philosophical Society contain several papers by Wall, brief notes of whose lectures are preserved in MS. in the Radcliffe library and in private letters of the time; some of the latter are printed by Mr. Gunther. Wall is described as a "learned, ingenious, and pleasing gentleman," who once had the honour of drinking tea with Dr. Samuel Johnson.

A contemporary of Wall's, James Higginbotham, of Magdalen Hall, afterwards James Price, of Guildford, was the last of the English alchemists, and killed himself after the exposure, by a committee of the Royal Society, of his pretensions to transmute mercury into gold.

From the closing years of the eighteenth century to the time of the foundation of the Aldrichian professorship, Oxford readerships in chemistry were held in succession by Dr. Thomas Beddoes (1788-93), best known as the founder of the "Pneumatic Institution" at Clifton, and the discoverer of Humphry Davy; and Dr. Robert Bourne, a fellow of Worcester, and an eminent medical man of his time. Indeed, practically all the readerships were held by medical men, and their teaching was largely directed to the needs of medicine.

In 1803 Dr. G. Aldrich endowed a professorship of chemistry. The first occupant of the chair was John Kidd, who held it from 1803 to 1822. He is the author of two papers in the *Phil. Trans.*, one on "Naphthaline, a peculiar substance . . . produced during the decomposition of coal-tar"; the other on "The natural production of Saltpetre in the walls of subterraneous buildings," the saltpetre having been scraped from "the hoary walls" of the basement of the Ashmolean Museum in which Dr. Kidd and his family resided.

Dr. Kidd was succeeded by Dr. Charles G. B. Daubeny, a professor of botany to chemists, and a professor of chemistry to botanists, who held the chair for thirty-two years, when his "increasing duties at the Botanic Garden compelled him to resign his Chemical Professorship." The cellar at the Ashmolean, although, as Daubeny said, "notoriously unworthy of a great University, being dark, inconvenient, and confined," was afterwards occupied by the late Prof. Story-Maskelyne, who gave instruction there in chemical analysis. An incident connected with his tenancy of this basement is related by Mr. Gunther in a footnote with which this notice of a most interesting account of Oxford's relations to chemistry must conclude:—

Some workmen were employed to make some alterations to a wall when one of them drove his pick through into a small room that had evidently not seen the light of day for generations. They enlarged the aperture, and, on entering, found some bottles that appeared to them of extreme antiquity. Very naturally they tasted the contents and speculated on the possible origin of the long forgotten hoard. When eventually the discovery was reported to Maskelyne, then at the mineralogical department at the British Museum, he exclaimed, "They have broken into my cellar, the stupid idiots. If they had only looked at the other side they would have seen my new oak door." But what probably rankled in his mind was the thought that his own gin had impaired their clear vision.

Mr. Gunther's surmise cannot, however, be well founded, as the gin was reached only *after* the wall had been broken through. It was presumably the same wine cellar that Dr. Daubeny had vainly petitioned Convocation to improve for him.

Pons-Winnecke's Comet and its Meteor Shower.

By W. F. DENNING.

A NEW comet was discovered by Jean Louis Pons at Marseilles in June, 1819, and it was observed during five weeks. From the observations obtained, Encke computed that the comet was revolving in an elliptical orbit, with a period of 2052 days, or 5.618 years. Nothing more was, however, seen of the object until nearly forty years afterwards, when Winnecke re-discovered it, and also re-determined its period of revolution. It has since been observed in 1869, 1875, 1886, 1892, 1898, 1909, and 1915. During the last fifty years the planet Jupiter has somewhat disturbed the orbit of the comet, for the two objects made several near approaches. Two periods of the comet are nearly equivalent to one period of Jupiter, hence at alternate visits of the former to aphelion, as in about 1872, 1883, 1895, and 1907, the perturbations were considerable. These had the effect of lengthening the comet's period and bringing that section of its course which is nearest to the sun almost into conjunction with the earth's path at the end of June.

On June 28, 1916, a meteoric shower of strik-

ing and abundant character was observed by the present writer at Bristol. It was first seen there at 10.25 p.m., and half an hour later it was also observed from Bournemouth and Birmingham. The sky was not very favourable, but at Bristol sixty-nine meteors were observed in about two hours, including twenty of the first magnitude, and the radiant point appeared to be diffused over the region of η Ursæ Majoris, θ Boötis, and a little east. This position corresponded approximately with the radiant point computed for Pons-Winnecke's comet, and the date was also correct, so that an intimate association (or identity) of the two phenomena was suggested (see *Monthly Notices of the Royal Astronomical Society* for 1916, vol. lxxvi., p. 742). The meteoric shower named is likely to be repeated, and on a more brilliant and abundant scale, on about June 27 next, for the comet will be very much nearer to the earth than it was in June, 1916. On that occasion the meteors were seen about ten months after the comet's nucleus had passed through perihelion, so that the stream of

particles following in the comet's wake must have been something like 550 million miles long. This need not, however, occasion great surprise, for observations have proved that in the case of the great Leonid stream of November the débris or meteoric particles are distributed completely around the orbit, which extends in its outer limits to beyond the path of the remote planet Uranus.

Formerly we had no special meteor shower to distinguish the midsummer period, but it is quite possible that in future years June may acquire a similar notoriety for meteors as that which has been long held by August and November, and should the new shower fully justify expectation it will in a certain measure prove a recompense for the lack of grand displays of meteors which has characterised the past thirty-five years. There were great storms of meteors in November, 1866, 1872, and 1885, but the Leonids of Tempel's comet (1866) and the Andromedids of Biela's comet have failed to furnish a really brilliant display of first-class importance during more than the third of a century, and it seems difficult to predict the dates of great revivals, although the years 1933 and 1934 are likely to bring a considerable shower, if not a grand exhibition, of meteors at the middle of November.

Including the periodical comet of Pons-Wincke, we now have six comets of which the orbits bear so striking and suggestive a similarity to those of rich meteoric streams that we may certainly conclude them to have the same derivative sources. There are also a number of other comets which furnish significant evidence that they are closely connected, if not identical, with active meteor showers. For example, the comet of Mechain-Tuttle seems to present conformity with a radiant point observed from $220^{\circ}+76^{\circ}$ from December 20 to 25. The comet Lexell (1770) agrees with a radiant point in June at about $280^{\circ}-24^{\circ}$. The comet of 1739 agrees with a radiant point at $153^{\circ}+40^{\circ}$ from October 14 to 22, and the comet Denning (1881) presents similar features of orbit to a meteor shower observed during the period July 25 to August 8 from a radiant at $303^{\circ}-10^{\circ}$.

There are many other instances in which cometary and meteoric accordances may be assumed with a fair degree of probability, yet when we consider the large number of orbits now definitely computed for comets and meteor streams we are bound to admit that chance coincidences must sometimes occur, and that it is difficult, except in special cases, to select the genuine instances of agreement.

Obituary.

PROF. L. C. MIALL, F.R.S.

THE death of Prof. Miall, announced in our columns last week, removes from the world a man who stood in natural history eminent in a position of his own, in education as one of the most sane and enlightened reformers of his time, and in personality one of the truly great among men.

Louis Compton Miall was born in 1842, the son of a Congregational minister in Bradford. After his early education at Silcoates he entered the teaching profession as an assistant master, but was soon tempted to accept the curatorship of the newly founded Literary and Philosophical Society of Bradford, where he developed a keen interest in geology and palæontology. A little later he was appointed to the curatorship of the Museum of the Leeds Philosophical and Literary Society, and in 1876, two years after the foundation of the Yorkshire College of Science, he was appointed as its first professor of biology, a position which he continued to hold in the University of Leeds until his retirement in 1907. With Sir Edward Thorpe, the late Sir Arthur Rücker, and Prof. A. H. Green he was one of the four scientific pioneers of university education in Yorkshire. He held the Fullerian professorship of physiology in the Royal Institution, 1904-5, was president of Section D (Zoology) of the British Association at the Toronto meeting in 1897, and president of the Education Section at Dublin in 1908. He was

elected a fellow of the Royal Society in 1892, and made an honorary D.Sc. of Leeds in 1904.

On his retirement from Leeds in 1907 Prof. Miall took up his residence at Letchworth, within easy reach of Cambridge and of the British Museum, and he continued active in writing and teaching. In 1918, soon after the death of his gifted wife, to whom he was married in 1870, he returned to his native county, residing at Ben Rhydding. For some time he maintained an active interest in his books, and he left practically complete a work on "Garden-craft in the Past." Lately his health failed somewhat, but almost until his death he retained wonderful vigour of mind and intellectual interest. In the middle of January he had a slight paralytic stroke, followed by a second, which left him in a weak state. From then his strength slowly ebbed, and he passed away peacefully, without suffering, in the house of his daughter, Mrs. Harold Wager, at Leeds.

To those who did not know him it is scarcely possible to give an adequate idea of the kind and strength of the influence which Prof. Miall exercised, or of the veneration in which he was held wherever his labours lay. In attempting to describe any section of his work there arises at once the memory of the man himself, his arresting personality, the scale and strength of his principles of heart and mind, his austere simplicity and perfect sincerity, his deliberate judgment, the comprehensiveness and sanity of his mental atti-

tude, his perfect lucidity of thought and speech, the richness and rarity of his store of learning in so many fields, and the scrupulousness of his taste, which abhorred and swept before it all that partook of the pretentious or the base.

Prof. Miall's intellectual interests were not confined to science. He had a real love of art and music, and was keenly interested in the works of Greek and Latin authors and in the classics of English, French, and German literature. His activities in biology, both as teacher and as investigator, coincided with the great output of biological work which followed upon the publication of Darwin's "Origin of Species." His earlier scientific memoirs were mainly geological and palaeontological. Shortly after he was appointed curator of the Museum at Bradford he was instrumental in bringing to light a newly discovered Labyrinthodont which had been found in a coal mine at Low Moor. It was in connection with this discovery that he first made the acquaintance of Prof. Huxley and Sir Charles Lyell, and the incident seems to have been a turning point in his career. Between the years 1869 and 1881 he published numerous papers on geology and palaeontology. He also wrote a manual for students on "The Skull of the Crocodile," and, in conjunction with F. Greenwood, an important memoir on "The Anatomy of the Indian Elephant."

From 1881 onwards Prof. Miall's biological investigations were mainly confined to the structure and development of insects, and his books on "The Cockroach," "The Harlequin Fly," and "The Natural History of Aquatic Insects" are among the most important memoirs on insect structure and development published during the latter half of the nineteenth century. These books, which are written with great lucidity and charm, have been an inspiration to many naturalists, and are enduring examples of how to "study the works of Nature with open eyes."

In his love of Nature Prof. Miall had very much the temperament of Gilbert White, and in collaboration with his friend Dr. W. Warde Fowler he brought out a scholarly edition of "The Natural History and Antiquities of Selborne," enriched with an abundance of notes explaining and amplifying Gilbert White's observations. The historical side of biology always had great attractions for him. He paid attention to it in his teaching, and two books from his pen, "A History of Biology" and a remarkably interesting account of "The Early Naturalists and their Work," testify to the wide range of his reading and the great knowledge which he possessed.

Prof. Miall's zeal as an educational reformer is well known. In his book on "Thirty Years of Teaching" his ideals and aspirations are clearly set forth, and in his "Object-Lessons from Nature," "Round the Year," and "House, Garden, and Field" he has given a most delightful insight into the methods which should be employed in the rational study of natural history as opposed to mere collecting and the compila-

tion of lists of species. He was far from disparaging the study of systematic zoology or botany, but he did most strenuously deprecate aimless work "which springs from no real curiosity about Nature and attempts to answer no scientific questions." He loved Nature with all his heart, and ever served her faithfully.

A. S.; H. W.

By the death of Prof. Louis Compton Miall, emeritus professor of biology in the University of Leeds, there passes away the last but one of the small body of teachers—less than a dozen in number—who, as members of the professoriate of the Yorkshire College, may be said to have laid the foundations of the University and, in a measure, to have fashioned its aims and destiny. The Yorkshire College, the progenitor of the University, was established in Leeds in 1874. Miall, who at that time was secretary and curator of the Museum of the Philosophical and Literary Society of Leeds, had acquired more than a local reputation as a geologist and botanist, and was then embarking upon the biological inquiries upon which his position as a man of science mainly rests. He was known throughout the West Riding as an excellent teacher and an admirable lecturer who could always command the interest and sympathetic attention of his audience. It was inevitable that the college should seek to secure his co-operation as a member of its staff. He joined it first as lecturer, and afterwards as professor of biology in its second session, and his appointment marks a turning point in its history. In its earliest days its governing body had no clearly defined policy concerning its scope and functions. It had been established partly in response to a demand for greater facilities in technical education, and partly from a desire to see in Yorkshire an institution similar in character to that of Owens College in Manchester. One section would make it a technical or trade school pure and simple, whilst another section, of more liberal views and with more sympathy towards the *literae humaniores*, hoped it might develop upon broader lines. The accession of Miall determined the issue; biology had no immediate or obvious place in the curriculum of such a trade school as was then contemplated. Professors of art subjects were thereafter added as quickly as the finances of the struggling institution permitted, and the college was thus fairly placed upon lines that directly led first to its inclusion in the federated Victoria University, and eventually to its independent establishment as the University of Leeds.

The turn in the fortunes of the Yorkshire College was without doubt largely determined by the personality and character of Miall and by the respect in which he was held by all who knew him and had the interests of the institution at heart, whatever might be their conception of its functions. By no section of the body corporate was he more warmly welcomed than by the staff.

They had already learned to appreciate his powers and capacity and to admire his manifold attainments. He was a cultured, well-read man with many interests, literary and scientific, a somewhat fastidious critic with a high standard of excellence, but with sympathy and of sound judgment. As a colleague he was all that a colleague should be—unselfish, painstaking, hard-working, and loyal, always ready to put his knowledge and his experience at the service of his fellows. In the college councils he was never argumentative or captious—a man of few words, disposed more to listen than to speak. When he did intervene in a discussion what he said was weighty and strictly to the point, and seldom failed to convince the majority of his colleagues. His sense of fairness, his impartiality, and his freedom from prejudice made him strive to see the other man's point of view and to give it its due weight. This was so obvious that it gave his judgments much of their power and influence. One felt that when Miall reached a conviction, and gave utterance to it in his characteristic slow and deliberate tones, he was probably right.

The development of the Yorkshire College, as compared with that of Owens College in its early days, was comparatively rapid. The times were of course different, and public appreciation of the benefits of such institutions was far greater in 1874 than in the early 'fifties. Moreover, the Leeds institution had never to struggle against the prejudices, religious and social, which at the outset dogged the progress of John Owens's foundation. But this rapid development was not unattended with its crises. There were times of difficulty and of anxiety which the teaching staff was called upon to share. It was on such occasions that Miall's strong common sense, sound judgment, knowledge of affairs, and business aptitudes were of special service, as, for example, in the movement to house the college in more appropriate and more dignified quarters than it at first possessed; in the discussions concerning the plan and arrangements of the projected new buildings; and finally during the course of the delicate negotiations which preceded the federation of the college with the Victoria University.

As one who took his fair share in the various stages of the development of the college during the first eleven years of its existence, and recalls its early struggles, and their outcome, with no small measure of satisfaction, it affords me a special gratification to bear testimony to the loyal and devoted service of one of the truest friends the University of Leeds ever possessed.

T. E. THORPE.

THE Editor invites me to write a few words about the late Prof. L. C. Miall, a man whom I seldom met, but when I did, always with interest and pleasure. More than twenty years ago, when we were editing White's "Selborne" together, I wished to know more of him, and invited him to Oxford for a Sunday. It was like

him to have brought no evening dress, but we had a fruitful time, and I found in the man a rare simplicity of mind and manners, and a great interest in his own experience, which he perhaps imparted more freely to a classical man than to one of his own circle. I heard the early history of the chance given him through Prof. Rolleston: how he asked a question after a lecture and was invited to talk it over next day before Rolleston left for Oxford, the result being that Rolleston stayed all day to talk to him and thereafter never forgot him. I heard the story of the little society of scientific men formed to read Homer, and later on he wrote me several letters about the best way to teach a boy Latin: a job which in his "emeritus" days he greatly enjoyed, doing it of course in his own peculiar and independent way.

Miall's enthusiasm in his own work was unbounded, and to communicate it to others the great delight of his life. He fairly astonished me, after a visit here at Kingham, by sending me as a gift the five splendid volumes on insects of Réaumur, and later on his own book on the early naturalists, one as great a treasure as the other, for his own beautiful English was as clear and enjoyable as Réaumur's French. He did, in fact, fit me out with a simple apparatus following the course of his own studies, so intensely did he wish his friend, only five years younger than himself, to share his enthusiasm. He once gave me a whole morning's microscopic teaching in his laboratory at Leeds, but though he fitted me out to continue his course I had no time to do so. That at my age he should have thought it possible shows the simplicity of his mind. Miall was one of those men who love teaching for its own sake, and the charm of his personality was such that I spent the time gladly and gratefully. But it was difficult, I found, to get him to bring his mind to bear on something quite new and out of his own experience. At Kingham I once took him to see the work of some mice in a flooded meadow which was new to me, but he had something else which he was expounding to me at the moment, and was not to be enticed. I shall always cherish his memory as one of the straightest and simplest Englishmen I ever knew.

W. WARDE FOWLER.

PROF. R. B. CLIFTON, F.R.S.

PROF. ROBERT BELLAMY CLIFTON was born on March 13, 1836, and so had nearly completed his eighty-fifth year when he died on February 21. The only son of a Lincolnshire gentleman, he received his education at University College, London, and at St. John's College, Cambridge, coming out sixth wrangler in the Tripos of 1859 and second Smith's prizeman, the senior wrangler and first Smith's prizeman being Canon Wilson. His Cambridge record is typical of his subsequent career; he was a man of great learning, but also of great deliberation. Obtaining a fellowship at St. John's, he went to Owens College, Man-

chester, in 1860 as professor of natural philosophy, and was appointed professor of experimental philosophy in the University of Oxford in 1865, which appointment he held until 1915.

The position of physics in 1865 was very different from what it is at the present time; there was then no such thing as a physical laboratory actually built for the purpose. Clifton's first work was the building of the Clarendon Laboratory, which was completed in 1872. The architect, no doubt, was responsible for most of the exterior, but the interior fittings down to the minutest details were practically carried out from Clifton's own working drawings. The necessary funds came from the trustees of Edward, second Earl of Clarendon, an alternative competitor for these funds being a riding-school.

The laboratory having been built, it had to be equipped with apparatus, which was a labour of love to Clifton, who was a born instrument-maker. Much of the apparatus is of his own designing, with the result sometimes that when an instrument had been brought to perfection it had become too sacred to be entrusted to the common herd.

Clifton was an excellent and inspiring lecturer, and spent an enormous amount of time in designing and fitting up apparatus for lecture purposes, so that his lectures were often more of the nature of laboratory demonstrations; time, however, was no consideration; no student could hope to get through even one subject during his academical life. He devoted himself to his pupils, both in Oxford and afterwards in obtaining posts for them. Besides lecturing, he took a large share in the laboratory instruction. This consisted almost entirely of repetitions of known experiments carried out with as much accuracy as possible. Research in the modern sense was not welcomed with open arms; the apparatus was too jealously guarded; but every student received a sound grounding in accurate experimental work, which no doubt bore good fruit later in many cases.

Clifton served on the council of the Royal Society for several years, was president of the Physical Society from 1882-84, was on the Royal Commission on Accidents in Mines from 1879-86, and at the same time had an estate in Lincolnshire to look after. All this, combined with his teaching, kept him constantly engaged, as he worked very thoroughly and deliberately at anything he took up, so that he had very little time left for original work; his published papers, in fact, are very few.

Clifton's method of private work was peculiar; he was popularly supposed to begin about midnight, and to go to bed with the "hooter," the Great Western Railway whistle which is sounded at Oxford at 5.30 a.m.; as he never took any exercise, it was a mystery how he managed to maintain his general fitness.

Clifton married in 1862 Miss Catharine Elizabeth Butler, and during her lifetime kept a most hospitable house. Every Sunday he had some of his

students to lunch, having previously furnished them with a sketch of the route to his house. He was a most lovable man, who had the affection of all his pupils, and was a welcome addition to any company.

PROF. W. ODLING, F.R.S.

ON February 17 the death occurred at Oxford of the former Waynflete professor of chemistry, in his ninety-second year. For many years the name of Prof. Odling has been almost unknown to students of chemistry, except to those who have become acquainted with something of the history of their subject during the last century. But it deserves to be held in respectful remembrance both by students of chemistry and by the large body of professional chemists now practising in this country, though probably only a contemporary could appreciate at their full value Odling's services to science on one hand, and on the other the position of influence in relation to applications of chemistry which he held fifty years ago.

William Odling was born in Southwark in 1829, the son of a surgeon. After leaving school he studied medicine at Guy's Hospital Medical School, and graduated M.B. Lond. with honours in physiology and comparative anatomy in 1851. Before this time, in 1848, he had shown his bent in the direction of chemistry by becoming a fellow of the Chemical Society, then in the early days of its existence. He never practised medicine, but proceeded to Paris in 1851, where he placed himself under the famous Alsatian chemist Gerhardt, and so received some impress from his teacher which doubtless influenced his attitude later as an exponent of chemical theory. In 1856 he became one of the hon. secretaries of the Chemical Society, being associated during the first nine years with the late Prof. Redwood, and during the last four with the late Mr. A. G. Vernon-Harcourt. In the years 1860 to 1872 Odling gave great assistance to the English chemists of his time by his masterly discourses at the Chemical Society on subjects such as the fixation of atomic weights, valency, and classification, then matters of frequently hot debate.

From 1868 to 1872 Odling held the Fullerian professorship at the Royal Institution, previously held by Faraday, and in 1872 he moved to Oxford, having been appointed Waynflete professor of chemistry in succession to Sir Benjamin Brodie.

His appointment he retained for forty years until he retired in 1912. Oxford at the time of his appointment was still too much under the conservative influences which had for so long retarded the progress of science in the University, and, like the other scientific departments, chemistry had to struggle during many years.

In 1877 the Institute of Chemistry had its origin in a voluntary association of chemists united in the desire for the organisation of the profession and for improvement in the education and qualifications of those who intended to practise

as consultants. Sir Edward Frankland was the first president, and he was followed by Sir Frederick Abel; but it was during Odling's occupancy of the chair, and largely owing to his influence, that the charter was granted in 1885. Although it is vain to look in the Royal Society Catalogue of Scientific Papers for outstanding discoveries the result of experimental work under Odling's name, it should not be forgotten that he contributed several very important articles on theoretical subjects to Watts's "Dictionary," and among them one on atomic weights, in which he came very near the discovery of the periodic law now always associated with the name of Mendeléeff.

In 1872 Odling married the only daughter of Alfred Smee, F.R.S., inventor of "Smee's battery," and formerly surgeon to the Bank of England, and by her he left three sons. Mrs. Odling died about four years ago, and this loss seems to have affected her husband seriously; however, when visited in January only a few weeks before his death his mental activity seemed undiminished, and he was ready to talk of old times.

W. A. T.

THE death of MR. C. GROVER, of Rousdon, Devonshire, on February 16, removes from the list of variable star observers a notable figure. There are now thirty-five years' observations made with the same instrument (a 6.4-in. refractor by Merz and Cooke, with low-power eye-piece of 25 by Steinheil) by the same observer on the same plan, and with remarkable regularity and

continuity. The first half of these observations were collected and discussed in vol. lv. of the R.A.S. Memoirs, but an equal contribution can now be added with a natural termination. This work was planned by the late Sir Cuthbert Peek, who took a personal share in its inception. Since Sir Cuthbert's death in 1900 it has been continued by his son, Sir Wilfred Peek. Mr. Grover would have been seventy-nine on March 7, and continued at his regular work until the very day preceding his death. There can seldom have been a more single-minded piece of astronomical work.

THE death of MR. JOHN CLARKE HAWKSHAW on February 12 is recorded in *Engineering* for February 18. Mr. Hawkshaw, who was eighty years of age at the time of his death, was the son of the late Sir John Hawkshaw, whose name is associated with so many important engineering works. Mr. Hawkshaw was associated with the construction of the Albert Dock, Hull; the Severn Tunnel, etc., and assisted his father in investigations with the Channel Tunnel and many other schemes. He was elected a member of the Institution of Civil Engineers in 1867, became member of council in 1889, and held the office of president in 1902-3.

IT is announced in *Science* for February 4 that MARY WATSON WHITNEY, emeritus professor of astronomy, and from 1889 to 1910 director of the observatory of Vassar College, New York State, died on January 20, aged seventy-three years.

Notes.

THE following fifteen candidates have been selected by the council of the Royal Society to be recommended for election into the society:—Dr. W. E. Agar, Dr. F. W. Aston, Prof. W. L. Bragg, Dr. W. T. Calman, Dr. A. H. Church, Prof. G. Dreyer, Prof. W. H. Eccles, Dr. J. C. G. Ledingham, Mr. C. S. Middlemiss, Prof. K. J. P. Orton, Dr. J. H. Parsons, Prof. J. C. Philip, Dr. A. A. Robb, Sir E. Tennyson D'Eyncourt, and Mr. G. Udny Yule.

THE Royal Society administers two funds, the Gore Fund and the Trevelyan Fund, which have been bequeathed to the society for the promotion of scientific research. There is a balance in hand of about 200l., and the president and council would be glad to consider applications for the whole or part of this balance. Applications should be sent to the Secretaries of the Royal Society, Burlington House, London, W.1, before April 15, stating the sum asked for and the way in which it is proposed to spend it, and enclosing any references or other documents the applicant may think fit.

THE combined meeting of organising committees of the Sections of the British Association, held at Burlington House on Friday last, February 25, was so helpful in many respects that it might very well

become an annual event. The meeting was called to consider various suggestions as to the number and grouping of Sections, presidential addresses, and other subjects discussed in the recent correspondence in *NATURE* and elsewhere, and also to facilitate the arrangement of joint programmes between two or more Sections for the annual assembly at Edinburgh in September next. At the general session it was agreed that the number of Sections should not be reduced, but that voluntary grouping for the consideration of subjects of common interest was desirable. The council (through the general officers) was empowered to fix hours of addresses and discussions, and the view was approved that the oral delivery of presidential addresses should be optional, as well as that the addresses themselves might be used to open discussions. It was also decided that the council should invite the recorders of Sections, or their nominees, to be present at meetings of council when presidents of Sections are elected. Organising committees will thus, through their representatives, be able to put forward their views as to new sectional presidents. Several important joint discussions were arranged for the forthcoming meeting, among them being one between the Sections of Physics and Chemistry on Langmuir's theory of the atom, and another between the Sections of Economics, Education, and

Psychology on vocational education and psychological tests. We hope shortly to be able to give further particulars of these and other joint discussions which promise to make the Edinburgh meeting both distinctive and of great interest to a large intellectual public.

SIR WILLIAM J. POPE has been elected Membre d'Honneur of the French Chemical Society.

THE PRINCE OF WALES has become president of the Royal Commission for the Exhibition of 1851 in succession to Prince Arthur of Connaught.

ANNOUNCEMENT is made that summer time is to begin this year during the night of April 2-3 and end on October 2-3. Last year summer time began on March 28.

THE council of the Chemical Society has awarded the Longstaff medal to Prof. J. F. Thorpe. The presentation will be made at the annual general meeting on March 17.

By a decree dated December 17, 1920, the centesimal system of angular measurement has been adopted in Sweden for land surveying, the hundredth part of a right angle being indicated by 10.

THE Mackenzie-Davidson memorial lecture of the Electro-Therapeutics Section of the Royal Society of Medicine will be given at 8.30 p.m. on Friday, March 18, at the rooms of the society, 1 Wimpole Street, W.1, by Prof. W. D. Halliburton, who will take as his subject "Physiological Advance: The Importance of the Infinitely Little."

THE sixth Guthrie lecture in connection with the Physical Society of London will be delivered at 5 o'clock on Friday, March 11, at the Imperial College of Science and Technology by Prof. A. A. Michelson, of Chicago. The subject will be "Some Recent Applications of Interference Methods." To this meeting visitors are invited.

A DISCUSSION on problems of seismology will be held in the rooms of the Royal Astronomical Society to-morrow, March 4, at 5 p.m. The chair will be taken by Prof. H. H. Turner. Prof. Horace Lamb will open the discussion, which will be continued by Dr. G. W. Walker, Mr. R. D. Oldham, and Mr. J. J. Shaw.

WE regret to learn that Prof. William A. Bone, professor of chemical technology at the Imperial College of Science and Technology, South Kensington, whose work on fuel is so well known, underwent a serious operation on Thursday last, and is at present passing through a critical period of recovery. He is, therefore, compelled to suspend all his scientific and public engagements for some time.

THE British Research Association for Liquid Fuels for Oil Engines Industry has been approved by the Department of Scientific and Industrial Research as complying with the conditions laid down in the Government scheme for the encouragement of industrial research. The secretary of the committee engaged in the establishment of this association is Mr. Percy Still, 19 Cadogan Gardens, S.W.1.

At the last meeting of the Geological Society Mr. C. Carus-Wilson exhibited a specimen of stalagmite from a cave in the Cheddar district containing the preserved impressions of moths' wings. Each layer of the stalagmite shows a number of these fossils, and Mr. Carus-Wilson thinks they may have been rejected by bats while feeding. The stalagmite had formed on a ledge at one side of the cave about 60 ft. from its mouth. Many other limestone caverns might yield similar fossils if searched.

Science for February 4 announces that the John Fritz gold medal for notable scientific and industrial achievement has been awarded to Sir Robert Hadfield, inventor of manganese steel and leader of the British steel industry. The award of the medal has been authorised unanimously by the sixteen members of the committee representing the national organisations of civil, mechanical, mining, metallurgical, and electrical engineers. The medal was established in 1902 in honour of John Fritz, ironmaster of Bethlehem, Pennsylvania.

A SWEDISH expedition, under the leadership of Dr. Otto Nordenskjöld, is at present engaged in exploration in the central and southern Cordilleras of South America. The *Geographical Journal* for February states that Dr. Nordenskjöld, accompanied by Mr. A. Bäckman, Count S. de Rosen, and others, began work last autumn in the Sierra region south of Oroya and explored the little-known Perene River and Pangoa Valley. In December the expedition went south to Chile. Its destination was the Peñas Gulf and the region round San Rafael Lake. It is hoped also to ascend one of the glaciers to the inner mountain region. The expedition, which has received valuable assistance from the Governments of Peru and Chile, expects to return to Europe at the end of the southern summer.

THE *Times* for February 25 contains an interesting letter from the secretary of the China Inland Mission with regard to the great earthquake that visited the north-west provinces of China on December 16 last. The meizoseismal area covers a large portion of the provinces of Kansu and Shensi, and is not less than 200 miles long from north-west to south-east and about 150 miles wide. The centre of the area lies about 30 miles south-east of Pingliang. Even near Sichow, which is about 250 miles from the epicentre, the shock was strong enough to throw down houses and to bury the inmates in the ruins. The earthquake seems to have been a remarkable one, even among shocks of the first order of magnitude, especially as regards the great size of the area of destruction and the changes wrought in the superficial layer of the crust.

THE next summer meeting of the Institution of Electrical Engineers will be held in Scotland on June 7-10. The first two days will be spent in Glasgow, when visits will be paid to the new power station at Dalmarnock and to works and other places of interest. There will also be papers on that power station and on the hydro-electric power resources of Scotland. On

June 9 the party will proceed by special train to Fort William or Banavie (Inverness Canal), and on the following day a steamer will take the visitors down Loch Linnhe to Kinlochleven, where the hydro-electric installation of the British Aluminium Co. will be visited. In the afternoon the steamer will continue its journey southwards and land the party at Oban, where the visit will end on Friday evening, June 10. The journey to Fort William and thence to Oban will give an opportunity of seeing the most magnificent scenery of the Western Highlands.

A JOINT discussion on "The Failure of Metals under Internal or Prolonged Stress," to be held on April 6, is being organised by the Faraday Society, the Institution of Mechanical Engineers, the Institute of Metals, and the Iron and Steel Institute. Other institutions of engineers and shipbuilders are also participating in the discussion, which will occupy an afternoon and an evening session. The proceedings will be opened by Dr. W. Rosenhain, and the preliminary programme contains a list of sixteen papers on specific aspects of the subject, in which the chemical influences at work, the effects of stress at high temperature, corrosion, the mechanism of failure from internal stress, as well as particular points in relation to the failure of steel, brass, and lead, will be discussed. An exhibition of specimens will be held in connection with the meeting. Further information can be obtained from Mr. F. S. Spiers, secretary to the joint committee, 10 Essex Street, Strand, W.C.2.

THE Electro-Therapeutic Section of the Royal Society of Medicine and the British Association of Radiology and Physiotherapy have organised a congress to be held in London on April 14-16. Sir Humphry Rolleston will be president of the meeting, and Dr. G. Harrison Orton secretary-general. The honorary secretaries for general correspondence are Dr. S. Melville and Dr. Justina Wilson, and the sectional secretaries Dr. N. S. Finzi for radiology, Dr. G. Murray Levick for electrology, and Dr. C. V. MacKay for physiotherapy. A provisional programme of the meeting has been arranged which includes discussions and visits to the electrical departments of selected London hospitals. Abstracts of papers should reach the secretaries at the Royal Society of Medicine before March 24; communications may be written either in English or in French.

THE Teyler Society of Haarlem announces that a gold medal of the value of 400 florins will be offered in 1924 for a treatise dealing with the following investigations:—"Referring to the studies of V. Grégoire, which show that the nuclei of both animal and vegetable cells are built up of karyomeres, the society invites investigation into the nature of these organs, especially during the period of rest of the nuclei, and of their bearing on questions of heredity." Papers may be submitted in English, Dutch, French, or German (in Latin characters), and must be type-written or written by someone other than the author; they become the property of the society, and the right to publish them in its Proceedings is reserved. The works should be sent under a pseudonym, and the author's name and address enclosed in a sealed

envelope bearing the same pseudonym. Papers must reach the society on or before April 1, 1923, and should be addressed: aan het Fundatiehuis van wijlen den Heer P. Teyler van der Hulst, te Haarlem.

AN inquiry into the present-day problems connected with the spread and prevention of filarial diseases in the tropics, more especially as they affect Demerara and the West Indies, has been undertaken at the request of the Colonial Office by the London School of Tropical Medicine. Dr. J. Anderson and his laboratory staff sailed from England on February 24; Prof. R. T. Leiper, the leader of the expedition, and the other members, Dr. Vevers, Dr. C. U. Lee, and Dr. Khalil, will proceed by different routes during March. The whole party will meet in Demerara early in April. The expedition will be away for upwards of seven months. The sending of this expedition at the present moment is particularly opportune in view of the proposed Intercolonial Medical Conference which is to be held shortly at Georgetown, British Guiana, to consider the sanitary problems of the West Indies. The expedition has been made possible through the generous public support accorded to the appeal recently made by Lord Milner on behalf of the London School of Tropical Medicine.

IN a communication from the Decimal Association on the progress of the metric system of weights and measures, it is stated that since the war the system has made notable headway in many foreign countries which have not yet officially made it compulsory for use in trade. In China the system is already in exclusive use on the railways, and it is expected that the Government will adopt the metric units when standardising their weights and measures. Legislative proposals having for their object the exclusive use of the system for trade purposes are at present under consideration in the United States, Japan, and Siam. Our own Ordnance Survey Office has announced that on all small-scale maps an alternative scale of kilometres and tenths will be printed in addition to the scale of inches, and on all small-scale layer maps the metric heights will be added in whole numbers of metres. The Decimal Association urges the Government to abandon its attitude of passive permission of the metric system and to embark on a campaign of active encouragement, and adds that it appears inevitable that the metric units will ultimately become the world standards of weight and measure, and that the longer we delay its exclusive adoption the more difficult and costly will be the transition.

SIR HERBERT JACKSON, the retiring president of the Institute of Chemistry, in the course of his address at the annual general meeting on March 1, remarked that Government Departments and official authorities generally have shown more inclination in recent times than in the past to accord higher recognition to the services of men of science. The institute is taking part in many matters affecting the public life of the country where chemistry is concerned, and the annual report shows that chartered professional bodies of this character are able to render the State valuable

service. The greater consideration given to science by the Government is an encouragement to the coming generation of chemists to follow a career of essential and vital importance to the needs of the country. Sir Herbert Jackson added that it would probably be regarded as desirable at the present moment for the council of the institute, without taking part in politics, to give expression to its views on the grave importance of maintaining in this country industries on which not only the future development of our chemical industry and many allied industries depends, but also the outlook of a very large number of students of chemistry who are now in course of training. The institute is entrusted by its charter with securing the supply of well-trained chemists, but unless a great chemical industry is maintained there will be a very poor prospect for them. Mr. A. Chaston Chapman succeeds Sir Herbert Jackson as president of the institute.

THE dry weather experienced recently is occasioning a suspicion in some quarters that the wet years we have had may be followed by a period of drought. This is naturally of importance in London and largely populated centres. It is customary now to compare rainfall results with the new normals for the thirty-five years 1881 to 1915. Taking Greenwich observations for means of comparison, the annual results for the last ten years show an excess of rain in seven years on the thirty-five years' average (23.50 in.) and a deficiency in three years. Other stations in the Thames Valley generally support these results. The total rainfall at Greenwich for the ten years was 254.25 in. Looking at the Greenwich results for the last hundred years, the heaviest rainfall in ten years seems to have occurred in 1872 to 1881, when there were seven years with an excess, and three years with a deficiency, on the hundred years' normal (24.41 in.). The total rainfall for the ten years was 268.42 in. This was followed by a dry period continuing approximately for twenty years, from 1883 to 1902, during which there were seventeen years with a deficiency, and only three years with an excess, of rainfall. This single instance affords probably little proof for future guidance. The admirable Monthly Reports published by the Thames Conservancy and the Monthly Maps of the Thames Valley rainfall published by the Meteorological Office would afford better and more valuable data for inquiry, especially in connection with the water-supply for London.

IN a discussion on "The Use of Light as an Aid to Publicity" before the Illuminating Engineering Society on February 24 attention was directed to the indiscriminate use of bright lights in shop-windows and for illuminated signs, and the need for some form of co-ordination of such displays was emphasised. It was also remarked that the lighting of exhibitions, even those devoted to technical or scientific processes, is usually executed in a very crude manner without any scientific and organised plan. The use of light for directing attention to objects and revealing them to observers involves interesting optical problems, some of which were illustrated by a variety of luminous signs exhibited at the meeting. There was general agreement that the best effect is

secured by adopting methods similar to those used in lighting the stage of a theatre, *i.e.* by concealing the actual light-sources from view. Capt. E. Stroud showed photographs of a number of shop-windows thus illuminated, and Mr. E. C. Leachman, who read a paper on illuminated signs, exhibited some striking pictorial transparency effects. A feature of these was the use of a new method of depositing colours on specially prepared linen, by the aid of which good transparency of the coloured surfaces, high luminosity, and vivid contrasts of light and shade were obtained. It was remarked that the device of illuminating a translucent picture from behind opened up new possibilities in art, as painted pictures lighted in the usual way from the front appear flat in comparison. Other forms of signs made use of ingenious colour effects. One of the most interesting devices was the sign shown by Mr. E. T. Ruthven Murray, in which light is distributed throughout the interior of a sheet of plate-glass by total internal reflection, so that white letters stencilled on the back appear strikingly illuminated, the source of light, a tubular lamp, being completely concealed from view.

THE publication of the first number of the *Antiquaries' Journal* makes a new departure in the history of the Society of Antiquaries, an attempt to bring before a wider public the results of its investigations, which have hitherto lain buried for many readers in the long series of its Proceedings and "Archæologia." The character of this the first example of the new publication ensures its success. Perhaps the most important paper is the interim report by Lt.-Col. W. Hawley on his excavations at Stonehenge conducted during the work undertaken for the preservation of the monument by H.M. Office of Works. Full details of the results of the digging required for the re-erection of some of the monoliths are given, but in the absence of a scientific commentary these may be regarded only as material for examination by experts. The most interesting new points are the excavation of the pits marked on Aubrey's map of 1606 and the statement by Dr. H. H. Thomas, Petrographer to H.M. Geological Survey, who has arrived at the important conclusion that with regard to the majority of the blue stones "their ultimate source lay in the Prescelly Mountains and in the boulder-strewn area to the immediate south-east. All possible proximate sources, however, must, of course, be investigated, but he felt that the idea of Pembrokeshire boulders being carefully selected from practically all other rocks, and stranded on the high ground of Salisbury Plain by glacial action, was contrary to all sound geological reasoning; and that such an assemblage of stones, of which so many were of the same type, pointed to human selection and conveyance from a distance."

THE Journal of the Royal Society of Arts for January 28 contains a paper by Dr. C. S. Myers on industrial fatigue. No satisfactory definition or test of industrial fatigue is known, though various suggested methods are discussed. Dr. Myers analyses the work curve, and shows that it is compounded of at least five different factors—fatigue, practice, incite-

ment, settlement, and spurt—and in most factories probably of more. Examples from some of the publications of the Industrial Fatigue Research Board show the disadvantages of the ten-hour as against the eight-hour working day, and also the improvement resulting from suitably arranged rest-pauses. The author points out, however, that a certain amount of fatigue is not only inevitable, but also beneficial; it is when the fatigue cannot be dissipated by rest that the condition is serious and the work suffers. The difference between the work of a machine and that of a human being is emphasised; it is unnatural for the latter to maintain a uniform output hour by hour. It is also necessary for industry to recognise the importance of individual differences among workers. Dr. Myers concludes by referring to the work of the Industrial Fatigue Research Board and of the National Institute of Industrial Psychology, which latter continues and develops the more general work of the Board for special firms. Although these bodies have been working but a short time, their researches have clearly shown the very complex nature of industrial fatigue problems and the urgent necessity for scientific investigation by impartial workers.

SIXTY-ONE pages on the growth of the antenna in termites might be thought disproportionate, but Mr. C. Fuller has made a really interesting study (*Annals of the Natal Museum*, vol. iv., p. 235, November, 1920). The number of segments in the antenna has, as in other insects, been held to distinguish various species, and even the length of the basal segment, numbered III., has been taken as diagnostic. But when soldiers of one species from a single colony were found with antennæ ranging from seventeen to

nineteen segments, this practice clearly called for re-consideration. It now appears that the segments are produced by separation from this segment III., and normally two at a time. The two segments of a pair may fuse or the proximal element may not be separated from III., and in this way arise antennæ with an odd number of segments. The relative length of III. depends on the number of segments that have been separated from it. The variation of number is governed by a general tendency to reduction throughout the group and by various environmental factors, of which nutrition is the most important. All antennæ, even in the adults of the most fully developed species, show within segment III. un-separated segments, and are therefore arrested organs. This gradual and continuous response to the environment in a segmented organ has an obvious bearing on theories of evolution, and Mr. Fuller's paper deserves study by general biologists. Fortunately, it is well arranged and well written. But we do not like the words "quiescency" and "monolocular"; we do not understand how "acrogenous" can apply to growth in a proximal region; and we protest against the use of the anatomical term "joint" when "segment" is intended.

MESSRS. NEWTON AND CO., LTD., 37 King Street, Covent Garden, W.C.2, have recently prepared a set of lantern-slides for a lecture on "Wireless Telegraphy" dealing more particularly with the Elwell-Poulsen system. The slides, many of which are from hitherto unpublished photographs, are accompanied by a full set of notes, which provides alternative methods of treatment for audiences of varying degrees of acquaintance with the subject.

Our Astronomical Column.

THE DATE OF EASTER.—A Bill to fix the date of Easter as the second Sunday in April has been introduced into the House of Lords by Lord Desborough. This Bill may serve to focus attention on the matter, but it is scarcely likely of itself to do more, for the question is one that calls for international and ecclesiastical co-operation, as was recognised by the Astronomical Union when it appointed Cardinal Mercier to preside over the Commission on Calendar Reform. Isolated action would only increase the present inconvenience, and obviously a Parliamentary decision would not be accepted by a considerable section of the community in such a matter as the alteration of the date of a religious festival.

ANCIENT STAR MAPS.—Dr. M. Schönfeld contributes an article to *La Nature* for February 5 on pre-historic astronomy in Scandinavia. He reproduces some old rock sketches found at Bohuslän, Venslev, and Dalby. They appear unmistakably to be intended to represent several notable star groups, Ursa Major being repeated three or four times, while Boötes, Virgo, and Cassiopeia are also more or less roughly delineated. It would appear that these designs are not very many thousands of years old, as several sketches of men and animals accompanying the star groups indicate that the constellations were already mapped out substantially as we now know them. The Bull, Archer, Great and Little Dog, and the ship Argo can all be traced. Moreover, Arcturus

moves through 0.6° in 1000 years, and while the sketch of Boötes is too rough to assign a date to it with any accuracy, we can at least say that it is unlikely to have been drawn more than 10,000 years ago. Dr. Schönfeld claims that different sketches represent the sky at different seasons of the year, but he seems to overlook the fact that unless we know the approximate date of the drawings we may be several months in error through the effects of precession.

THE 1920 OPPOSITION OF MARS.—*Popular Astronomy* for February contains very interesting drawings and photographs of Mars made at Flagstaff Observatory last spring, together with articles by E. C. Slipher and G. H. Hamilton. The aspect of Syrtis Major was very unusual, considerable sections of it being covered by a white veil, apparently cloud or mist. It was noted that this white region was not surrounded by a dark band, as was the polar cap; and it is concluded that the latter band is not illusory, as some have contended. Mr. Hamilton notes that the Syrtis appeared normal until March 8, and was then modified in two different ways. Besides the partial covering by white cloud, the south-eastern edge of the Syrtis appeared to fade and merge into the adjacent desert. Both Mr. Hamilton and Mr. Slipher refer to the veiling by mist near the limb which is a familiar feature, but at the recent opposition the mist seems to have persisted an unusually long time after sunrise.

A New Deposit of Cobalt Ore.

THE development of new uses of metallic cobalt has established a demand for this commodity, which until recently was a metal of comparatively small account. When the production of metallic cobalt as a by-product commenced a few years ago, it was necessary to initiate research into the possible uses of the metal before an increased demand could be created. The position now is that the uses of cobalt are many and various, and the question is: Where are we to find the supplies that are likely to be necessary to meet the future demand for the metal?

In these circumstances it becomes important to put on record any discoveries of new occurrences that give any promise of development to meet the world's requirements, and in this connection a report by the Queensland Government Geologist recently received at the Imperial Mineral Resources Bureau concerning a high-grade deposit near Selwyn, in the Cloncurry district of Queensland, is of special interest. The locality is approximately 19 miles south of Selwyn, the nearest railway station, which is 71 miles from Cloncurry. By track it is about 5 $\frac{3}{4}$ miles south of Mount Dore (located on Queensland 4-mile map-sheet 120) and 1-2 miles west of the Mort River.

The cobalt ore occurs at the contact of diorite (apparently a dyke about 5 chains wide) and schists, the latter belonging to the Cloncurry series of supposed Silurian age. The schists have a strike of 5° west of north, and dip easterly at angles of 74° to 80°. They form noticeable outcrops on the area, and associated with them at a few chains from the diorite are several prominent white quartz outcrops conforming to the strike of the country, and to all appearances barren.

The workings at present consist of four shafts. No. 1 is 23 ft. deep, No. 2 27 ft., No. 3 20 ft., and No. 4 20 ft. The distance between No. 1 and No. 4 shafts is 300 ft.

The ores consist of cobaltite (sulpharsenide of cobalt, containing 35.5 per cent. of cobalt) and erythrite or cobalt bloom (hydrous arsenate of cobalt, containing when pure about 29 per cent. of cobalt). A picked sample of cobaltite from this lode recently assayed for the Department of Mines gave the following composition:

	Per cent.
Arsenic	40.2
Sulphur	15.8
Cobalt	33.1
Nickel	nil
Iron	2.1
Insoluble (chiefly SiO ₂)	8.3

99.5

The workings are not extensive, and the following notes are descriptive of what work has been done in prospecting:

No. 1 Shaft.—This is the most southerly shaft on the lode. At the top the lode is 2 ft. 6 in. wide, and at the bottom (23 ft. deep) it has narrowed to 12 in. On the hanging wall there is a seam of white clay up to 4 in. thick. Where this is removed the hanging wall is pink-stained with "bloom." The footwall has a smooth surface indicating a fault plane. The ore here consists of highly altered rock with veins of erythrite and small lenses of sulphide.

An average sample chipped across the lode on both sides of the shaft (1 ft. on the north and 6 in. on the south) near the bottom gave the following analysis (Assay No. 515/7):

Gold	9 grains
Silver	trace
Metallic cobalt	17.4 per cent.
Metallic nickel	nil
Arsenic	9 per cent.

No. 2 Shaft.—This shaft discloses a lode formation 5 ft. wide regularly to the bottom, depth 27 ft. Both walls are well defined. On the footwall is a seam of solid sulphide ore 2-9 in. thick, and on the hanging wall there is a very narrow seam of sulphide. Between two walls the lode material consists of a siliceous indurated gangue, much jointed, with erythrite and sulphide veins coating all the joint-faces. Cobaltiferous wad is present in small quantities in the lower half of the shaft, associated with the two other minerals. A grab sample from the ore-paddock at this shaft returned (Assay No. 516/7):

Gold	19 grains
Silver	trace
Metallic cobalt	12 per cent.
Metallic nickel	nil
Arsenic	16.5 per cent.

The ore-paddocks at this shaft are estimated to contain 50 tons of ore, averaging, as above, approximately 12 per cent. of cobalt.

No. 3 Shaft.—The lode varies from 2 ft. to 3 ft. in thickness. On the footwall is a very thin seam of scheelite. The lode is schist much altered and replaced by veins of erythrite, generally not exceeding 1 in. thick. There are small lenses of sulphide close to the footwall.

No. 4 Shaft, the most northerly, has turned out the most massive sulphide ore. The lode is from 2 ft. to 3 ft. wide, and consists of soft, decomposed schist largely replaced with erythrite. It contains a central string of solid sulphide ore in the form of lenses almost constituting a single vein. The lenses vary from 8 in. to 18 in. in width. Analyses of the following samples were as follows:

Average Sample taken across Lode in No. 4 Shaft
(Assay No. 513/7).

Gold	2 dwt. 19 gr.
Silver	18 dwt.
Metallic cobalt	19.5 per cent.
Metallic nickel	nil
Arsenic	28.3 per cent.

Average Sample of Paddock of Oxidised Ore
(Assay No. 514/7).

Gold	trace
Silver	trace
Metallic cobalt	10 per cent.
Metallic nickel	nil
Arsenic	12 per cent.

The ore-paddock near this shaft is estimated to contain 32 tons of picked high-grade sulphide ore, the approximate content of cobalt equalling 25 per cent. There are also about 10 tons of lower-grade oxidised ore consisting mostly of erythrite in a schist gangue assaying 10 per cent. of cobalt.

It is estimated that in prospecting the lode between 130 and 140 tons of ore have been raised, of which 92 tons represents ore in paddocks; 30 tons of the latter is approximately of 25 per cent. grade and the balance of 10-12 per cent. grade.

The lode is regular in its trend, almost following a straight line for at least 300 ft. The walls in places

are well defined, and both these features indicate that there has been movement along the contact, so that it may be classed as a fissure lode on an igneous contact. It is certainly too regular in strike to consider it a replacement along what superficially appears to be rather regular igneous contact. Where the gangue is extremely hard indurated schist this is much jointed or broken, further pointing to a settling movement along the contact planes. The lode underlies 75° - 80° easterly, which is the dip of the schists on the hanging walls. The gangue in the lode consists of diorite in various stages of alteration, soft weathered schist, and hard indurated schist. Where the last-named occurs replacement appears to be confined to the fracture-faces, which are coated with cobaltite in process of oxidation to erythrite.

A few chains north of No. 4 shaft there are some old abandoned workings on the contact. These were worked for copper, and there is a good deal of copper carbonate associated with the mullock. With the copper occurs a vein of scheelite 2-4 in. wide, from which well-developed crystals of that mineral have

been obtained. Although so closely contiguous, there is no appearance of cobalt stains.

In the diorite dyke in juxtaposition to the cobalt lode there is a quartz outcrop running at right angles to it which contains cobaltiferous wad as well as jasper-brown iron ore. Although it does not meet the cobalt lode at the surface, it has possibly a genetic relationship to the cobalt lode, and it is suggested that it may have been a channel of supply, thus accounting for what, at the present time only, appears a definite localisation of the cobalt in the contact lode. A sample of the wad from this outcrop contained:

Metallic cobalt	5.2 per cent.
Metallic nickel	nil
Arsenic	0.9 per cent.

It is very desirable, however, that the whole of the diorite contact should be prospected, particularly the eastern contact, on account of copper carbonates, scheelite, and cobalt ores having been already found along it.

The Study of British Roses.

THE study of our British roses has been rendered increasingly difficult by successive attempts to classify the numerous forms—species or varieties—in a satisfactory system. The late Mr. J. G. Baker in his "Monograph of British Roses" in 1869 recognised thirteen species and a moderate number of varieties. In the "London Catalogue of British Plants" (1908) some of Baker's varieties are raised to specific rank, and twenty-five species and a large number of additional varieties are recognised. Wolley-Dod's "List of British Roses" (1911) included about 170 names, but in his "Revised Arrangement" recently published in the *Journal of Botany* the number of names having full specific rank is reduced to eighteen, the author remarking that most of the very detailed descriptions of Déséglise and other specialists can scarcely be other than those of an individual bush or specimen which cannot be completely matched by any other.

The present position is discussed in the *New Phytologist* (vol. xix., Nos. 7 and 8) by Mr. J. R. Matthews, who considers that only by culture, combined with cytological study, will it become possible to determine finally the genetic relationships of the numerous micro-species into which old, well-known species like *Rosa canina*, Linn., have been split. The study of external form has so far failed to give a satisfactory solution of the problem, and the anatomical method followed by Parmentier has not proved more successful. Several hybrids—that is, crosses—between distinct species have been recognised among British roses, and it is not improbable that the difficulty in classifying the genus may be largely due to

hybridisation and segregation, complicated, it may be, by rehybridisation. Hybrids between closely similar parents would be difficult to diagnose, and in actual practice would, as a rule, be considered distinct species or varieties; and it is suggested that a large portion of the total number of named varieties of roses has arisen in this way.

The work of Jeffrey on hybridism in the Rosaceæ indicates that certain recognised species are, from the study of their pollen, in reality concealed hybrids (cryptohybrids), and Miss Cole more recently from the study of the pollen in numerous roses concludes that the great majority of so-called species are really of hybrid origin. There is no experimental evidence to show whether these species-hybrids segregate or remain stable; but presuming segregation to occur in the genus *Rosa*, we might expect to find a large number of visually distinct forms showing various combinations of Mendelian unit-characters, such as hairiness, leaf serration, glandularity, glaucousness, etc.

Mr. Matthews attempts a theoretical analysis of some of the British species of roses on the basis of a few separate characters such as these. The species selected are the aggregate species generally recognised by systematists, and the author suggests that the numerous sub-species and varieties of these aggregates which have been described represent some of the various combinations of unit-characters which might be expected to result from the process of segregation. The argument is confessedly entirely hypothetical, and the author emphasises the importance of experimental work to establish the hypothesis.

Commerce and Customs of Papua.¹

IN his Report on the Territory of Papua for the year ending June, 1919, the Lieutenant-Governor, the Hon. J. H. P. Murray, shows that, as in so many other parts of the world, the scarcity and irregularity of shipping facilities are acting prejudicially to the progress and development of the Territory. This is especially indicated by the decrease of exports upon

which the prosperity of the country mainly depends. Rubber alone showed an increase, but the quantity is as yet small (207 tons as compared with 144 tons in 1918). Another important vegetable export, copra, has decreased (2598 tons as compared with 3189 tons in 1918). Native-made copra forms a large proportion of the output, and, owing to variation in the production, this does not increase steadily like the plantation product. The production of sisal hemp has also decreased, whilst the value of all the crops has been much reduced by a fall in prices. The

¹ "Commonwealth of Australia. Papua. Annual Report for the Year 1918-19." Pp. 117+2 pls. (Printed and Published for the Government of the Commonwealth of Australia by Albert J. Mullett, Government Printer for the State of Victoria.)

export of the chief minerals, gold and copper, has decreased, but there are good prospects of development and increased production at Port Moresby and Misima Island. The value of the gold was 26,766*l.* in 1919 as against 33,512*l.* in 1918. Copper was worth 11,537*l.* in 1918, but only 1653*l.* in 1919.

The actual revenue of the Territory, including a grant of 30,000*l.* from the Commonwealth of Australia, amounted during the year to 103,120*l.* The expenditure was 102,961*l.* Thus a surplus of 18,778*l.* in 1918 was increased by about 159*l.* to 18,937*l.*

The European population was 1007. Coloured persons other than Papuans were 304, of whom 217 were mission teachers. There were also 340 police and 821 village constables of various races. During the year 8610 native labourers were recruited, to whom more than 40,000*l.* was paid in wages.

The actual native population is uncertain. A quarter of a million is suggested by the Acting Medical Officer. In some districts the number is increasing, but around Port Moresby the physique of the natives appears to be deteriorating through the adoption of European food and clothing. In a supplement to the report the Rev. J. B. Clark, of the London Missionary Society, gives a hopeful account of the progress of the natives. Boys leaving school become telephone operators and clerks, and some of the native churches are capable of self-government. The relations of the natives with the Government have been, on the whole, satisfactory. A few affrays and murders have taken place in remote districts, but there has been a general prevalence of respect for law and order. An incident in the Chirima district of the Mambare Division is typical of dealings with the natives. The attempt of a patrol to arrest a native led to an attack in which another native was killed and a woman and a boy were wounded. The natives were afterwards pacified by the Resident Magistrate of the Kumusi Division. The pacification involved some difficulty and risk, as the natives took to the bush and refused to parley unless the officers, Messrs. Blyth and Fowler, went to them unarmed and alone. The officers took the risk, and after a conference the confidence of the natives was restored.

A valuable scientific section of the report is found in the supplements contributed by the Resident Magistrates and patrol officers, the Medical Officer, the Government Geologist, and the Agricultural Expert.

A paper of considerable ethnological interest by the late W. Beavers (*cf.* NATURE, February 19, 1920) is also included. It deals with the use of emblems or insignia of man-killing among certain tribes of the north-western part of Papua. A preface gives an account of the ceremonious reception of the man-killer by his village, and of his life on his return. The insignia consist of various decorations of shell-rings, feathers, dog-teeth, and similar articles. There are also other distinctions not of a material nature, such as taking the name of the individual slain, prohibition of his flesh to the slayer, skull trophies, and mutilations. A further account describes the *Kortopo* ceremony by which the privileges of the man-killer are passed on to others. The custom is now decadent, and the slaying of a fat pig is sufficient justification for the wearing of the emblems.

The polyglot character of the tribes of Papua is shown by an index of the vocabularies of native dialects contained in the annual reports from 1889 to 1918. There are more than 450 titles. The present report increases them by fourteen.

SIDNEY H. RAY.

Ancient Egyptian Survivals in Modern Egypt.

AN interesting lecture upon the above subject was delivered on behalf of the Egypt Exploration Society at the rooms of the Royal Society, Burlington House, on February 23 by Prof. C. G. Seligman.

Two classes of survival from ancient Egypt may be distinguished, namely, (1) beliefs and (2) certain technological objects and processes. Each group embraces, on one hand, survivals *in situ*, such as certain beliefs connected with the calendar, and a ceremony in which a sacred boat takes a prominent part; and, on the other, examples from other parts of Africa in which Egyptian customs, often modified by later cultural waves, have persisted for a longer or shorter period. As examples may be cited certain medieval graves of Senegal, and probably the funeral customs of a number of tribes of Equatoria, as well as the belief in multiple souls found in the Southern Congo and West Africa.

A striking example is found in the persistence of old beliefs attached to certain days. In the Sallier papyrus, which dates from the time of Rameses II., or possibly of his successor, Athyr 19th is marked as one of the days "to beware": "storms are engendered in the skies; do not travel on the river neither up nor down; do not . . . at all on this day." In a modern calendar for 1878 the instructions for Zu'l-Heggeh 4th, which corresponds to the Coptic Hatour, *i.e.* Athyr 19th, is: "Avoid travelling on the Mediterranean." Thus we have persisting for some 3500 years the tradition that this day is unlucky for travellers.

Another interesting example mentioned by Prof. Seligman was that of a boat which is kept at Luxor, at the present day on the roof of a mosque, but a few years ago suspended in a tree. At stated times the boat is brought down, decorated with green branches, placed upon a cart, filled with children, and taken in procession round the town. There are three boat processions in Luxor every year, one to commemorate the birthday of Abu'l Heggag, the patron saint of Luxor, and the others on the birthday of the Prophet and the beginning of Ramadan.

These beliefs and ceremonies are of interest, not only because the period over which they have persisted is longer than that bridged by the host of beliefs and practices that constitute the folk-lore of other peoples, but also because it is possible to adduce perfectly definite evidence of their direct continuity over a very much longer period of time. The interest of the boat ceremony is even greater; Prof. Seligman thought a fairly good case could be made out for a number of boat ceremonies still performed in the East—*e.g.* one he had himself witnessed in Ceylon—having originated in Egypt and been carried eastward by Islam, just as was the Malay alphabet.

University and Educational Intelligence.

CAMBRIDGE.—Trinity College has offered to establish a prælectorship in geodesy if satisfactory arrangements are made for the institution in the University of a school for research in that subject. This is a very welcome move forward in a scheme which has been under consideration for some time to found a centre of geodetic teaching, and ultimately a Geodetic Institute, at Cambridge.

It is proposed to offer a diploma in hygiene which will suit the needs of medically qualified students of public health whose qualification is foreign and not registrable in Great Britain.

Grants have been made for the Gordon Wigan Fund towards plant-breeding, museum cases for insects, standard slides for petrology, and a solar radiation recorder for the botanical school. A recommendation is put forward to increase the value of the Balfour studentship from 250l. to 300l. a year.

THE London County Council Education Officer announces that a lecture on "Chemical Technology" will be given by Dr. M. O. Forster at Salters' Hall, St. Swithin's Lane, E.C.4, on Saturday, March 5, at 10.30 a.m.; and one on "The Romance of Science" by Sir W. H. Bragg at University College, Gower Street, on Tuesday, March 15, at 6 p.m.

In an answer to a question concerning the London University site, the Chancellor of the Exchequer has made the following statement:—"In October last the University of London accepted the offer made by the Government in the preceding April of a site behind the British Museum and the site has been purchased. For the funds required for building the University headquarters the University must look primarily to private generosity, but it will be open to the University Grants Committee to supplement local contributions if the funds at their disposal allow." The purchase price of the site is 425,000l.

THE University of Melbourne has issued a statement with reference to an important lectureship and demonstratorship just established in natural philosophy. The lecturer will deliver the lectures in natural philosophy to medical students, and be generally responsible for the organisation of the teaching of this part of the work of the natural philosophy department. He will be appointed in the first instance for a period of five years, the appointment to date from March 1, 1922. The salary of the lecturer will be 750l. per annum, payable monthly. Candidates should not be above thirty-five years of age, and applications for the post should be lodged with the Registrar, University of Melbourne, by April 15 next. Facilities for original research in physics will be given. The Grayson gratings (see Proc. Roy. Soc. Vict., September, 1917) were ruled in a workshop of the natural philosophy department of the University.

A COURSE designed to meet the needs of qualified medical practitioners who may wish to obtain the diploma in public health of the Royal Colleges of Physicians of London and Surgeons of England has been arranged by the committee of the Technical College, Bradford, and the Health Committee of the City Council. For this purpose the Technical College has recently been placed upon the list of recognised institutions by the Royal Colleges. The proposed course will extend over twenty-five weeks, and include lectures and laboratory work in bacteriology and pathology and in chemistry. In connection with the course in bacteriology, Dr. W. Campbell has been appointed lecturer in bacteriology and the pathology of industrial diseases, and Dr. R. Cecil Robertson assistant lecturer and demonstrator in serology and immunology in the college. The course in chemistry will be under the direction of the head of the chemistry department of the Technical College (Dr. R. D. Abell). The recognition of the college for post-graduate work of this nature marks an important point in the development of the work of the college.

THE announcement that the Rockefeller Foundation intends to assist the medical schools of Central Europe is yet another step in the fulfilment of its purpose "to promote the well-being of mankind throughout the world." A programme is announced which provides for assistance in the rehabilitation of scientific equip-

ment for medical purposes, for aid in furnishing medical journals to universities, and invites the authorities of the Medical School of Belgrade University to study medical education in England and America as guests of the Foundation. These decisions are the result of investigations into medical conditions in Central Europe made by representatives of the Trust, who reported that, with the exception of Austria, all the countries in this region are suffering from a shortage of physicians; there are only nine medical schools of repute to provide medical men for some 75,000,000 people. Belgrade is regarded as one of the strategic points in a medical campaign, so the invitation to study English and American methods has been given to the men who are responsible for its development; they have also been authorised to recommend candidates to the Foundation for fellowships for specialised post-graduate medical study. Germany is not included in the scheme, for she is considered to be adequately supplied with well-equipped medical schools. The International Health Board of the Rockefeller Foundation has come to an agreement with the Government of Czechoslovakia whereby the latter will borrow the services of a competent American public health administrator, and co-operate with the Board in the development of a national public health laboratory service, in the provision of fellowships for Czechs for public health training, and the dispatch of a Czech Commission to study public health administration in England and America. Nine medical men have already been awarded fellowships, and five members of the Commission from the Ministry of Hygiene have arrived in America as guests of the Foundation.

In an address delivered in September last to the Old Students' Association of the Royal College of Science (Lamley and Co., South Kensington, S.W.7, price 2s. 6d.), Prof. H. E. Armstrong recalled his early training at the Royal College of Chemistry as it existed in 1865 at the close of Hofmann's career as professor in that institution. The freedom of choice of study left to an independent student of those days was contrasted with the examinational restraints imposed at present on candidates for university degrees. The lecturer referred to his later studies at Leipzig under Kolbe, in the golden era of German *Lern- und Lehr-freiheit*, and to his early teaching experiences at the London Institution. In 1879 Prof. Armstrong entered the service of the City and Guilds of London Institute, and thus became the founder successively of the chemical departments of the Finbury Technical College and the Central Technical College. An intimate knowledge of the educational requirements of London extending over a period of fifty years leads the lecturer to the conclusion that the Imperial College must be autonomous, and that its functions should be restricted to the physical and mathematical sciences. Conversely, University College should be constituted as an Imperial College of Biological Science and Technology dealing with the special requirements of biology. It is suggested further that King's College should become an Imperial College of Arts and Economics. The three colleges thus reconstituted should be federated in one Imperial university. The social needs of the new university in regard to playing-fields would be met by establishing the Arts College on a country site such as at Kenwood. Students' hostels would be required at the urban centres. Each college should be granted the power to confer its own degrees, but the federal scheme should be sufficiently elastic to leave a student free to attend courses at a college other than his own so that his studies "could be as broad as his heredity would permit."

Calendar of Scientific Pioneers.

March 3, 1702. Robert Hooke died.—One of the earliest and most vigorous members of the Royal Society, Hooke was Gresham professor of astronomy. He constructed the first Gregorian telescope, first applied a spiral spring for the regulation of watches, pointed out the real nature of combustion, and proposed to measure the force of gravity by means of a pendulum. He died in the old Gresham College, and is buried in St. Helen's Church, Bishopsgate.

March 3, 1808. Johann Christian Fabricius died.—Professor of natural history at Copenhagen and then at Kiel, Fabricius by his writings exercised great influence on the development of entomology.

March 3, 1879. William Kingdon Clifford died.—A brilliant mathematician and thinker, Clifford died at the age of thirty-three while occupying the chair of applied mathematics in University College, London.

March 5, 1827. Pierre Simon, Marquis de Laplace died.—The son of a poor farmer of Normandy, Laplace went to Paris at the age of eighteen. There he was befriended by D'Alembert, and speedily rose to a high position among the group of distinguished men of science who adorned France during the Revolutionary period. An astronomer, physicist, and mathematician, his "*Mécanique Céleste*," published in five volumes between 1799 and 1825, is regarded as one of the noblest monuments of human genius. His tomb is in the Père Lachaise Cemetery, near that of Molière's.

March 5, 1827. Alessandro Volta died.—Born in Como in 1745, Volta was for twenty-five years professor of natural philosophy at Pavia. His invention of the voltaic pile was made in 1799, and the following year he communicated his discovery through Sir Joseph Banks to the Royal Society. So great was the interest raised by Volta's invention that Napoleon called him to Paris in order to see the experiments. At the Centenary Exhibition at Como in 1899 Volta's books and papers and much of the apparatus he left were destroyed by fire.

March 5, 1866. William Whewell died.—A man of encyclopædic knowledge, Whewell was for many years Master of Trinity College, Cambridge. He wrote much on scientific subjects, and made important additions to the theory of tides.

March 6, 1908. William Edward Wilson died.—After accompanying Huggins on an eclipse expedition to Oran, Wilson set up an observatory at Danamona, Westmeath. He carried out notable investigations on the temperature of the sun.

March 7, 1904. Ferdinand André Fouqué died.—A professor of the Collège de France, Fouqué was one of the earliest workers in the field of the microscopic examination of rocks and minerals, of which Sorby was the great pioneer.

March 9, 1851. Hans Christian Oersted died.—Twenty years after Volta's invention of the voltaic pile, Oersted, then professor of natural philosophy at Copenhagen, made the observation that a wire uniting the ends of a voltaic battery affected a magnet in its vicinity. Following up this discovery, in 1820 he published his tract, "Experiments on the Effects of Opposing Electricity upon the Magnetic Needle," the effect of which was described by Forbes as instantaneous and wonderful. The ideas of Oersted were seized upon by Ampère, Arago, Davy, Seebeck, and Faraday, and in their hands led to rapid development of the science of electromagnetism, of which Oersted is rightly regarded as one of the founders.

E. C. S.

Societies and Academies.

LONDON.

Royal Society, February 17.—Prof. C. S. Sherrington, president, in the chair.—Dr. C. Chree: A comparison of magnetic declination changes at British observatories. A comparison is made of mean monthly, daily, and hourly values at different stations, and of the relative amplitudes of the oscillatory movements which frequently occur even on comparatively quiet days. Use is made of magnetic curves from Eskdalemuir, Stonyhurst, Falmouth, and Kew observatories.—Prof. H. M. Macdonald: The transmission of electric waves around the earth's surface.—Prof. T. H. Havelock: The stability of fluid motion. The object is to illustrate the use of the criterion, introduced by Reynolds and modified by Orr, as a measure of the degree of stability of various fluid motions under different boundary conditions. Cases examined are the flow of a stream with a free surface, and the flow between fixed planes under different fields of force and boundary conditions of no slip or no tangential stress or constant normal pressure due to the disturbance from the steady state.—Prof. W. H. Young: The transformation of integrals.—Dr. J. L. Haughton and Kathleen E. Bingham: The constitution of the alloys of aluminium, copper, and zinc containing high percentages of zinc. The constitution of aluminium-copper-zinc alloys containing not more than 15 per cent. of aluminium and 10 per cent. of copper is discussed. The investigation has been carried out by the study of the heat absorptions and evolutions which take place in heating and cooling alloys between temperatures at which they are liquid and ordinary temperatures; by the measurement of electrical resistance at various temperatures; and by microscopic study of specimens which have been annealed for prolonged periods and quenched, or very slowly cooled and quenched. From the results obtained a model has been constructed to represent the constitution at temperatures above 250° C. The diagram advanced by Rosenhain and Archbutt has been used as one face of the ternary prism, the other binary system face being somewhat modified from Tafel's diagram.

Geological Society, February 2.—Mr. R. D. Oldham, president, in the chair.—H. Bolton: A new species of Blattoid (*Archimylacris*) from the Keele group (Stephanian) of Shropshire. The author describes the basal portion of a new type of Blattoid wing found by Mr. John Pringle in core-material of purple marly shale from a borehole for water. The wing belongs to the genus *Archimylacris*, and is closely allied to *A. Lerichei*, Pruvost, and *A. Dessaillyi*, Leriche, from the upper beds of the Westphalian of Liévin, Northern France.—C. E. Tilley: The granite-gneisses of Southern Eyre Peninsula (South Australia) and their associated amphibolites. Southern Eyre Peninsula is underlain by a complex series of pre-Cambrian rocks subject to prolonged erosion, but now in part covered by weathered products and recent æolian sediments. The fundamental platform of the eastern half of the peninsula consists of granite-gneisses, amphibolites, and hornblende-schists, embraced within the Flinders series. The petrography of the rocks is described and the significance of their mineralogical constitution discussed. The gneissic structure is a primary gneissic banding arising from flow-movements in a heterogeneous magma. The amphibolites are considered as representing more basic and earlier igneous intrusions, probably of the same igneous cycle and connected with the one great orogenic epoch, which have become thermally metamorphosed. Inter-

calated in bands in the gneisses of portions of the hundred of Lincoln is a series of dolerites which have suffered a metamorphism of the highest grade.

Zoological Society, February 8.—Prof. E. W. MacBride, vice-president, in the chair.—Dr. C. F. Sonntag: The comparative anatomy of the tongues of the Mammalia, family Simiidae.—D. M. S. Watson: Basis of classification of the Theriodontia.

Royal Meteorological Society, February 16.—Mr. R. H. Hooker, president, in the chair.—M. de Carle S. Salter: A new method of constructing average monthly rainfall maps. For the present purpose a new series of isomeric maps for the period 1881–1915 has been prepared, on the scale of 20 miles to 1 in., from 550 records. A map showing the distribution of average annual rainfall for thirty-five years has been compiled on the same scale (i) from Dr. H. R. Mill's survey maps on the scale of 2 miles to 1 in. prepared from all available data, and (ii) by computing 1700 additional average values for the districts not yet surveyed. The twelve monthly isomeric maps and the annual map were ruled in a network of squared lines 10 miles apart, and values interpolated at each of the points of intersection. The twelve percentage evaluations for each point were collected and severally applied to the value from the annual map, thus obtaining twelve monthly rainfall values applicable to the point in question. The latter were plotted on a fresh series of ruled maps, together with the actual average values for the 550 stations originally utilised, and the whole were used as a basis for isohyetal lines. The whole gave 2573 values for each month, and left no space of more than 10 miles without some means of controlling the drawing of the lines. The paper discusses the limits of error introduced by the method.—G. A. Clarke: An unusual pilot-balloon trajectory. A balloon observed by one theodolite was found to pursue a course so erratic that its results, if calculated by the method applicable to the one-theodolite ascents, would have shown a wind of more than 110 miles per hour from W.S.W. at 2500 ft., with a return wind of similar velocity from E.N.E. only 500 ft. higher. Such conditions in the atmosphere being extremely improbable, an endeavour was made to deduce the magnitude of the vertical currents, and it was found that the path described could be accounted for by a descending current of about 6 miles per hour, followed by an ascending one of somewhat similar velocity.

CAMBRIDGE.

Philosophical Society, February 7.—Prof. Seward, president, in the chair.—G. E. Briggs: The development of photosynthetic activity during germination.—Prof. G. H. Hardy: A theorem concerning summable series.—E. A. Milne: Vectors and tensors. The usual intuitive concept of a vector useful in three dimensions no longer serves in four dimensions, and a more precise definition is required, in which, however, the notion of a permanency independent of any particular co-ordinate system is preserved. Consider the class of co-ordinate systems and the class of representations of a particular vector (by means of sets of components) associated with them: it is suggested that a vector be defined as the class of such correlated sets.—H. C. Pocklington: (a) Standing waves parallel to a plane beach. (b) A kinetic theory of the universe.—Prof. H. F. Baker: (a) A configuration in four dimensions. (b) The representation of a cubic surface on a quadric surface. (c) Delaunay's method in planetary theory. (d) A periodic motion in dynamics.

February 21.—Prof. Seward, president, in the chair.—Dr. Hartridge: The present position of the Helmholtz theory of hearing.

MANCHESTER.

Literary and Philosophical Society, January 11.—Mr. Francis Jones, vice-president, in the chair.—Dr. A. A. Mumford: Testing and grading of health and physical fitness. The author urged the necessity of fresh physical fitness tests for school-children—the present tests mainly dealt with exceptional children, such as the deformed, diseased, and mentally unfit—based on the capacity to put forth effort, and thus considering the work of the heart, lungs, and the nervous system. The tests, brought into prominence by the work of the Air Force, mainly concerned breathing, and were now being adapted to boys in the Manchester Grammar School. The first test, dealing with the amount of air used in respiration, was measured by the spirometer; the second, dealing with the force of respiration, was measured by pressure against a column of mercury; and the third concerned the movements of the chest, which could be examined by means of a specially designed waistcoat.

January 25.—Sir Henry A. Miers, president, in the chair.—W. E. Alkins, M. Cook, and J. Harwood: Variation in *Sphæria*—(i) *S. lacustre*, Muller; (ii) *S. corneum*, Linné; (iii) *S. pallidum*, Gray. These three papers were mainly confined to the presentation of results and a comparison of species, a general discussion of the significance of the results being reserved for a fourth and concluding paper on *S. rivicola*. Two hundred specimens of *S. lacustre* from Three Lows, North Staffordshire, and five hundred each of *S. corneum* and *S. pallidum* from the Ashton and Guide Bridge Canal, near Dukinfield Station, had to be examined. The authors have studied the variation of width, length, and thickness.

PARIS.

Academy of Sciences, February 7.—M. Georges Lemoine in the chair.—G. Gouy: Systems of prisms with parallel edges.—R. Birkeland: The resolution of the general algebraic equation by hypergeometric functions of several variables.—E. Jouguet: The case of Poincaré in the theory of elasticity. Poincaré has studied the small deformations of an elastic solid, starting with an initial state in which the tensions are not zero. The author examines some thermodynamic properties of elastic solids with similar deformations.—A. Guillet: A chronograph recording photographically for the measurement of short periods in harmonic motion or with circular uniform movement by means of Lissajous's figures.—C. Féry: A battery depolarised by air. A modification of the Leclanche cell. The zinc is in the form of a horizontal disc placed at the bottom of the cell; the carbon is a cylinder the lower flattened edge of which is immediately above the zinc plate. The removal of the polarising hydrogen by the air causes currents between the upper and lower ends of the carbon cylinder. It is claimed for this battery that no peroxide of manganese is required, local action is absent, and its e.m.f. during use is very constant. It has received practical application in the French Posts and Telegraphs Department, and it has been shown that it lasts three times as long as the old form.—P. Chevenard: The expansion anomaly accompanying the magnetic transformation of pyrrhotine and magnetite. In the neighbourhood of 320° C. pyrrhotine suddenly increases in length, corresponding very probably to a true allotropic transformation analogous to the change of α -iron into γ -iron. This hypothesis is confirmed by the fact noted by Weiss, that the magnetisation coefficient of pyrrhotine is nearly independent of the temperature round about 320° C. Magnetite also shows an anomaly in expansion at 570° C.—a temperature near the magnetic Curie point determined by

Weiss.—A. Liénard: Electromagnetic energy and thermodynamic potential of a system of currents.—A. Portevin and J. Durand: Anomaly of expansion of the gold-copper alloys.—L. Forsén: The constitution of the derivatives of molybdc acid.—J. Martinet and O. Dornier: Isatin 5-sulphonic acid. Isatin has not hitherto been directly sulphonated. Details are given for the preparation of isatin 5-sulphonic acid from isatin and fuming sulphuric acid, and some of its salts are described.—H. Bouygues: Considerations on the endoderm.—M. and Mme. G. Villedieu: The non-toxicity of copper for mildew. The results of experiments on *Phytophthora infestans* (the mildew of potato), controverting the usually accepted view that it is the copper in anticyptogamic mixtures which is efficacious in destroying mildew.—W. Kopaczewski: The rôle of surface tension in the phenomena of shock. The surface tension of serum is reduced by the addition of a solution of sodium hyposulphite. The author attributes the suppression of the anaphylactic shock by sodium hyposulphite solutions to this change in surface tension, and not to the effect of this salt in dispersing flocculated serum.—A. Trillat: The influence of the state of division of droplets containing bacteria on the infection of culture media.—MM. Desgrez, Guillemard, and Labat: The use of the alkaline polysulphides for the neutralisation of certain toxic gases. Spraying with a sodium polysulphide soap solution, originally suggested for the removal of chloropicrin vapour from air, has been found to be also efficacious in removing other toxic gases. Figures are given for the amounts required to remove chlorine, phosgene, acrolein, bromoacetone, and other noxious vapours.

Books Received.

The Government of the Philippine Islands. Philippine Census, A.D. 1918. Manila: The Climate and Weather of the Philippines, 1903 to 1918. By the Rev. J. Coronas. Pp. 195. (Manila: Bureau of Printing.)

What to Read on Social and Economic Subjects. A Select Bibliography Compiled by the Fabian Society. Sixth edition. Pp. xii+80. (London: The Fabian Society; G. Allen and Unwin, Ltd.) 2s. net.

The Boy in Industry and Leisure. By the Rev. R. R. Hyde. (Social Service Library.) Pp. xxviii+281. (London: G. Bell and Sons, Ltd.) 6s. net.

Small Single Phase Transformers. By E. T. Painton. Pp. x+95. (London: Sir I. Pitman and Sons, Ltd.) 2s. 6d. net.

Elementary Principles of Continuous-Current Armature Winding. By F. M. Denton. Pp. x+102. (London: Sir I. Pitman and Sons, Ltd.) 2s. 6d. net.

A Guide to the Preparation of a Note-Book of Biology. By E. W. Shann. Pp. 48. (London: G. Bell and Sons, Ltd.) 2s. 6d. net.

Mitteilungen der Naturforschenden Gesellschaft in Bern aus dem Jahre 1919. Pp. lxxv+231+v Tafel. (Bern: K. J. Wyss Erben.)

The Breeding and Feeding of Farm Stock. By J. Wilson. Pp. vii+152. (London: Methuen and Co., Ltd.) 6s. net.

A Book of Butter: A Text on the Nature, Manufacture, and Marketing of the Product. By Prof. E. S. Guthrie. Pp. xv+270. (New York: The Macmillan Co.; London: Macmillan and Co., Ltd.) 12s. net.

Report of the Indian Association for the Cultivation of Science and Proceedings of the Science Convention for the Year 1918. Pp. iii+199+xxxi+plates. (Calcutta.)

Economic Mineralogy: A Practical Guide to the Study of Useful Minerals. By T. Crook. Pp. xi+492. (London: Longmans, Green and Co.) 25s. net.

Insect Life. By C. A. Ealand. Pp. xii+340+lxiv plates. (London: A. and C. Black, Ltd.) 30s. net.

In Farthest Burma: The Record of an Arduous Journey of Exploration and Research through the Unknown Frontier Territory of Burma and Tibet. By Capt. F. K. Ward. Pp. 311. (London: Seeley, Service and Co., Ltd.) 25s. net.

The Subject Index to Periodicals, 1917-19. B-E: Historical, Political, and Economic Sciences. Pp. 248. (London: The Library Association.) 21s. net.

Transactions of the Norfolk and Norwich Naturalists' Society. Presented to Members for 1919-20. Vol. xi., part 1, December. Pp. xiii+101. (Norwich.) 7s. 6d.

Annuaire Astronomique et Météorologique pour 1921. 57 Année. By C. Flammarion. Pp. 251. (Paris: E. Flammarion.) 8 francs.

Department of Applied Statistics (Computing Section), University of London, University College. Tracts for Computers. Edited by Karl Pearson. No. iv.: Tables of the Logarithms of the Complete γ -function to Twelve Figures. Originally computed by A. M. Legendre. Pp. 4+10. (London: Cambridge University Press.) 3s. 9d. net.

The National Physical Laboratory. Collected Researches. Vol. xv., 1920. Pp. iv+329+plates. (London: H.M. Stationery Office.) 20s. net.

Diary of Societies.

THURSDAY, MARCH 3.

ROYAL INSTITUTION OF GREAT BRITAIN, at 3.—F. Balfour Browne: Mason Wasps.

ROYAL SOCIETY, at 4.30.—Discussion on Isotopes to be opened by Sir J. J. Thomson, followed probably by Dr. F. W. Aston, Prof. F. Soddy, Prof. T. R. Merton, and Prof. F. A. Lindemann.

ROYAL AERONAUTICAL SOCIETY (at Royal Society of Arts), at 5.—J. W. W. Dyer: Airship Fabrics.—Major T. Orde Lees: Parachutes.

LINNEAN SOCIETY, at 5.—R. T. Günther: A Manuscript of Matthias de Lohel, from the Library of Magdalen College, Oxford.—Dr. B. Daydon Jackson: Naturalists and their Indebtedness to the National Trust.

ROYAL COLLEGE OF PHYSICIANS OF LONDON, at 5.—Dr. G. Graham: Glycæmia and Glycosuria (Goulstonian Lecture).

CHILD-STUDY SOCIETY (at Royal Sanitary Institute), at 6.—Miss M. C. Buysman: The Value of the Drama in the Training of the Child's Emotions.

CHEMICAL SOCIETY, at 8.—C. K. Ingold and J. F. Thorpe: The Chemistry of the Glutaconic Acids. Part XII. The Simultaneous Occurrence of 1:2- and of 1:3-Addition to Glutaconic Ester. A Study in Mobile Equilibrium involving the Utilisation of the Labile Ester in the "Nascent" Condition.—E. O. C. Baly and W. F. Barker: The Photochemical Reaction between Hydrogen and Chlorine, and its Variation with the Intensity of the Light.—J. Kenner and W. V. Stubbs: A Second Form of 6:6'-Dinitrodiphenic Acid and its Conversion into New Cyclo Systems.—J. Moir: The Calculation of the Colour of Monocyclic Coloured Substances.—N. V. Sidewick and E. K. Ewbank: The Stability of Tautomeric Formaldehydrazones.—F. W. A. Atack and L. Whinyates: The Structural Isomerism of Oximes. Part III. A Fourth Benzil-dioxime.

ROYAL SOCIETY OF MEDICINE (Obstetrics and Gynaecology Section), at 8.—Dr. G. Evans: A Study of the Condition of the Arteries in a Uterus Removed 24 Days after Delivery.—Dr. A. Bourne: Puerperal Salpingo-peritonitis.

FRIDAY, MARCH 4.

ROYAL SOCIETY OF MEDICINE (Laryngology Section), at 4.

ROYAL SOCIETY OF ARTS (Indian Section), at 4.30.

ROYAL ASTRONOMICAL SOCIETY (Geophysical Discussion), at 5.—Problems of Seismology: opened by Prof. H. Lamb, followed by Dr. G. W. Walker, R. D. Oldham, and J. J. Shaw. Chairman: Prof. H. H. Turner.

INSTITUTION OF MECHANICAL ENGINEERS AND THE SOCIETY OF CHEMICAL INDUSTRY (Joint Meeting), at 6.—P. Kestner: Degassing and Purification of Boiler Feed-Water.

INSTITUTION OF ELECTRICAL ENGINEERS (Students' Meeting) (at Faraday House), at 6.30.—A. Rosen: Telephonic Transmission through Submarine Cables.

JUNIOR INSTITUTION OF ENGINEERS (at Caxton Hall), at 8.—W. H. Simmons: Manufacture of Gun-cotton.

ROYAL SOCIETY OF MEDICINE (Anæsthetics Section), at 8.30.—R. Apperly: The Importance of the Examination of the Patient by the Anæsthetist, Previous to Anæsthesia.
ROYAL INSTITUTION OF GREAT BRITAIN, at 9.—W. A. Tait: Severn Crossings and Tidal Power.

SATURDAY, MARCH 5.

ROYAL INSTITUTION OF GREAT BRITAIN, at 3.—Sir Ernest Rutherford: Electricity and Matter.

MONDAY, MARCH 7.

VICTORIA INSTITUTE (at Central Buildings, Westminster), at 4.30.—Rev. H. Costley White: Public School Education.

ROYAL INSTITUTION OF GREAT BRITAIN (General Meeting), at 5.
SOCIETY OF ENGINEERS, INC. (at Geological Society), at 5.30.—R. W. A. Brewer: Some Modern Engineering Practice in America.

ARISTOTELIAN SOCIETY (at University of London Club, 21 Gower Street), at 8.—Prof. J. E. Boodin: Cosmic Evolution.

ROYAL SOCIETY OF ARTS, at 8.—Major G. W. C. Kaye: X-rays and their Industrial Applications (Cantor Lecture).

SOCIETY OF CHEMICAL INDUSTRY (at Chemical Society), at 8.—Dr. J. C. Drummond: Factors Influencing the Food Value of Lard and Lard Substitutes.—Dr. R. C. Farmer: The Stability of Benzoyl Peroxide.

SURVEYORS' INSTITUTION, at 8.—A. B. D. Lang: The Report from the Select Committee of the House of Commons on Business Premises.

ROYAL GEOGRAPHICAL SOCIETY (at Æolian Hall), at 8.30.—J. H. Driberg: The Lango District, Uganda Protectorate.

MEDICAL SOCIETY OF LONDON (at 11 Chandos Street, W.1), at 9.—G. E. Gask: Surgery of the Lung and Pleura (Lettsomian Lecture).

TUESDAY, MARCH 8.

ROYAL INSTITUTION OF GREAT BRITAIN, at 3.—Prof. A. Keith: Darwin's Theory of Man's Origin in the Light of Present-Day Evidence.

ROYAL HORTICULTURAL SOCIETY, at 3.

ROYAL COLLEGE OF PHYSICIANS OF LONDON, at 5.—Dr. G. Graham: Glycæmia and Glycosuria (Goulstonian Lecture).

INSTITUTION OF CIVIL ENGINEERS, at 5.30.—S. Leggett: The Amritsar Hydro-electric Irrigation Installation.

ZOOLOGICAL SOCIETY OF LONDON, at 5.30.—E. G. Boulenger: Experiments on Colour-changes of the Spotted Salamander (*Salamandra maculosa*), conducted in the Society's Gardens.—Miss Joan B. Procter: The Variation of the Scapula in the Batrachian Groups Aglossa and Arcoifera.—Dr. W. T. Calman: Notes on Marine Wood-boring Animals. II. Crustacea.—Augusta Arnabæk Christies-Linde: The Reproductive Organs of the Ascidian *Kükenthalia borealis*, Gottschaldt.—B. P. Uvarov: The Geographical Distribution of Orthopteran Insects in the Caucasus and in Western Asia.

ROYAL PHOTOGRAPHIC SOCIETY OF GREAT BRITAIN, at 7.—Annual General Meeting.

QUEKETT MICROSCOPICAL CLUB, at 7.30.

ROYAL ANTHROPOLOGICAL INSTITUTE (Special Meeting), at 8.15.—Prof. F. G. Parsons: The Head Form of the Long Barrow Race, with Reference to the Modern Inhabitants of London.

ROYAL SOCIETY OF MEDICINE (Psychiatry Section), at 8.30.—Dr. H. Devine: Study of Hallucinations in a Case of Schizophrenia.

WEDNESDAY, MARCH 9.

INSTITUTE OF METALS (Annual General Meeting) (at Institution of Mechanical Engineers), at 10.30 and 2.30.—Prof. H. C. H. Carpenter and Constance F. Elam: Stages in the Re-Crystallisation of Aluminium Sheet on Heating, with a Note on the Birth of Crystals in Strained Metals and Alloys.—P. H. Brace: Some Notes on Calcium.—Prof. C. A. Edwards and A. M. Herbert: Plastic Deformation of Some Copper Alloys at Elevated Temperatures.—H. Moore and S. Beckinsale: The Action of Reducing Gases on Heated Copper.

ROYAL SOCIETY OF ARTS, at 4.30.—W. Dewar: The Plumage Trade and the Destruction of Birds.

GEOLOGICAL SOCIETY OF LONDON, at 5.30.—W. B. R. King: The Surface of the Marls of the Middle Chalk in the Somme Valley and the Neighbouring Parts of Northern France, and the Effect on the Hydrology.—Gertrude L. Elles: The Bala Country: Its Structure and Rock-Succession.

THURSDAY, MARCH 10.

INSTITUTE OF METALS (Annual General Meeting) (at Institution of Mechanical Engineers), at 10.30.—H. Moore, S. Beckinsale, and Clarice E. Mallinson: The Season Cracking of Brass and Other Copper Alloys.—Dr. J. L. Haughton: The Constitution of the Alloys of Copper with Tin, Parts III. and IV.

ROYAL INSTITUTION OF GREAT BRITAIN, at 3.—Dr. G. C. Simpson: The Meteorology of the Antarctic.

ROYAL SOCIETY, at 4.30.—*Probable Papers*.—Sir Joseph Larmor: Electro-crystalline Properties as Conditioned by Atomic Lattices.—Lord Rayleigh: The Colour of the Light from the Night Sky.—Prof. A. S. Eddington: A Generalisation of Weyl's Theory of the Electromagnetic and Gravitational Fields.—Prof. T. R. Merton: Spectrophotometry in the Visible and Ultra-violet Spectrum.—Prof. W. A. Bone: Researches upon Brown Coals and Lignites.—H. N. Russell: A Superior Limit to the Age of the Earth's Crust.

LONDON MATHEMATICAL SOCIETY (at Royal Astronomical Society), at 5.

ROYAL COLLEGE OF PHYSICIANS OF LONDON, at 5.—Dr. A. Whitfield: Some Points in the Etiology of Skin Diseases.

ROYAL SOCIETY OF MEDICINE (Bacteriology and Climatology Section), at 5.30.—Discussion: The Place of Baths and Health Resorts in Gynecology.

INSTITUTION OF ELECTRICAL ENGINEERS (at Institution of Civil Engineers), at 6.—Prof. E. Wilson: Feebly Magnetic Materials: Practical Applications.

OPTICAL SOCIETY (at Imperial College of Science), at 7.30.—Prof. H. F. Newall: The Story of a New Star (Lecture).—T. F. Connolly: Note on a Handy Form of Measuring Microscope.

ROYAL SOCIETY OF MEDICINE (Neurology and Ophthalmology Sections, Joint Meeting), at 8.—Dr. G. Holmes, L. Paton, and Others: Ocular Palsies.

FRIDAY, MARCH 11.

ASSOCIATION OF ECONOMIC BIOLOGISTS (in Botanical Lecture Theatre, the Imperial College of Science), at 2.30.—Exhibits and Short Communications.—Dr. J. Davidson: The Cells of Plant Tissues in Relation to Cell-sap as the Food of Aphids.—E. R. Speyer: Ceylon Scolytid Beetles: their Bionomics and Relation to Ambrosia Fungi and Problems of Plant Physiology

ROYAL ASTRONOMICAL SOCIETY, at 5.

PHYSICAL SOCIETY OF LONDON (at Imperial College of Science), at 5.—Prof. A. A. Michelson: Some Recent Applications of Interference Methods (Sixth Guthrie Lecture).

ROYAL SOCIETY OF MEDICINE (Clinical Section), at 5.30.

INSTITUTION OF ELECTRICAL ENGINEERS (Students' Meeting) (at King's College), at 6.30.—J. A. Broughall: Some Recent Developments in Converting Machinery for Small Substations.

ROYAL SOCIETY OF MEDICINE (Neurology and Ophthalmology Sections, Joint Meeting), at 8.30.—Dr. G. Holmes, L. Paton, and Others: Ocular Palsies.

ROYAL INSTITUTION OF GREAT BRITAIN, at 9.—Dr. J. Freeman: Medical Idiosyncrasies.

SATURDAY, MARCH 12.

ROYAL INSTITUTION OF GREAT BRITAIN, at 3.—Sir Ernest Rutherford: Electricity and Matter.

PHYSIOLOGICAL SOCIETY (at Institute of Physiology, University College), at 4.

CONTENTS.

	PAGE
Science in the Civil Service	1
A Great Giver. By Sir E. Ray Lankester, K.C.B., F.R.S.	2
Mathematical Papers of Huygens. By J. L. E. D.	4
Four Aspects of Parenthood	5
Our Bookshelf	6
Letters to the Editor:—	
Amplifying the Optophone.—A. A. Campbell Swinton, F.R.S.	8
Molecular and Cosmical Magnetism.—Prof. S. J. Barnett; Prof. S. Chapman, F.R.S.	8
Transcendental Premises in Science.—Sir Henry H. Howorth, K.C.I.E., F.R.S.	9
Natural History of Porto Santo.—Prof. T. D. A. Cockerell	10
The Energy of Cyclones.—Prof. J. von Hann	11
The Ascent of Mount Everest.—Sir Francis Young-husband, K.C.S.I., K.C.I.E., and Prof. J. N. Collie, F.R.S.	12
Pure Organic Chemicals.—Prof. J. B. Cohen, F.R.S.	12
Nature of Vowel Sounds. (<i>Illustrated</i>).—Charles de Wesendonk; Prof. E. W. Scripture	12
Early Chemistry in Oxford. (<i>Illustrated</i>). By Sir Edward Thorpe, C.B., F.R.S.	13
Pons-Winnecke's Comet and its Meteor Shower. By W. F. Denning	15
Obituary:—	
Prof. L. C. Miall, F.R.S. By A. S. and H. W.; Sir Edward Thorpe; and Dr. W. Warde Fowler	16
Prof. R. B. Clifton, F.R.S.	18
Prof. W. Odling, F.R.S. By W. A. T.	19
Notes	20
Our Astronomical Column:—	
The Date of Easter	24
Ancient Star Maps	24
The 1920 Opposition of Mars	24
A New Deposit of Cobalt Ore	25
The Study of British Roses	26
Commerce and Customs of Papua. By Sidney H. Ray	26
Ancient Egyptian Survivals in Modern Egypt	27
University and Educational Intelligence	27
Calendar of Scientific Pioneers	29
Societies and Academies	29
Books Received	31
Diary of Societies	31



THURSDAY, MARCH 10, 1921.

Editorial and Publishing Offices:

MACMILLAN & CO., LTD.,

ST. MARTIN'S STREET, LONDON, W.C.2.

Advertisements and business letters should be
addressed to the Publishers.

Editorial communications to the Editor.

Telegraphic Address: PHUSIS, LONDON.

Telephone Number: GERRARD 8830.

Oceanographic Problems.

IT may be taken for granted that a new *Challenger* expedition, such as was suggested by Prof. W. A. Herdman in his presidential address to the British Association at Cardiff last August, would have for its *general* objects just those of the great voyage of 1872-76. One must remember that only an infinitesimal part of the ocean floor has been investigated by all the deep-sea exploring voyages yet organised. On the whole, then, a new expedition ought to make soundings, take temperature observations, trawl and dredge, etc., adopting the same attitude towards these matters as that already taken. The traverses across the great oceans would, of course, be different ones, so that new stations would be investigated—except where it may be desirable to check some of the former results—and here and there it may be found advisable to study some relatively small area intensively—that is, to make the observing stations much closer together than over the rest of the traverses. This ought to be practicable, for the improvements in the gear employed and in its management have been so great since 1872 that much more work should certainly be done in the same time than was possible on board the old *Challenger*. Just because of the enormous improvement in apparatus, it

would be advisable to repeat much of the work of the former expedition, especially in areas that have not been touched by any of the later voyages.

Confirmation of many of the old results is absolutely necessary; for instance, much is to be learned by repeating the observations made by the German plankton expedition of 1889, especially in other areas than the Sargasso Sea. Such results would be of immense theoretical significance if they were obtained by the newer methods that have been developed, because of the criticism of Victor Hensen's original methods of quantitative plankton research. The same remarks may be made with reference to the collection of water samples from the surface and at all levels down to the sea-bottom. The activities of the nitrogen-bacteria were practically unknown in 1872, but they have been studied very closely since. Even the methods for the estimation of atmospheric gases dissolved in sea-water have been greatly improved, and a general study of the distribution of these at the bottom of the deep oceans would give information of great value in tracing movements of water-masses on the large scale. Something has been done since 1872 on the bacteria of the oceanic oozes and the overlying water, but mainly in rather shallow water and on a very limited scale; a big series of such samplings over the ocean far from the land cannot fail to have enormous interest. This, of course, is work that must be done on board ship, and will require exhaustive preliminary research into methods adapted to the rather trying conditions. With, however, a modern ship, electric incubators, refrigerating machinery, and so on, there is no insuperable difficulty. What may be really troublesome will be the elaboration of a thoroughly sound method of collecting samples of water and ooze from great depths by means that will satisfy a critical bacteriologist.

Thus, it may be agreed, the general outlook ought to be very much what it was in 1872, except that the most careful attention should be paid to methods, especially such as have been developed to an extent that the *Challenger* men of science of 1872 could not have anticipated. It is possible also that some of the devices adopted during the anti-submarine warfare of the last few years may have great potentialities, and if any confidential information of such promise is in existence it should be considered.

The results of the old *Challenger* expedition had, it is well known, certain important economic

consequences, and this aspect of the new expedition should certainly be kept in mind. Here we are immediately concerned with the purely scientific interest of a renewed exploration of the ocean, but fishery research provides biological data of theoretical interest, and so it is quite properly a part of the programme of a deep-sea expedition on the great scale. One remembers, also, that such economic-marine exploration has been asked for by the owners of deep-sea fishing vessels; that the steam vessels employed in trawling always tend to become more and more powerful and to go further afield; that methods of conservation may quite conceivably make the products of tropical or polar seas accessible to the whole world (so that Dr. W. S. Bruce's idea of utilising penguin eggs as food for Europe is by no means absurd); and that British commercial enterprise is quite capable of establishing fisheries in any part of the world, if it is assured that there is a reasonable chance of success. One remembers that it was the exploration of the Stanton Banks off the Western Hebrides by Capt. Tizard in the *Triton* that led to the suggestion that fishing vessels might go there. The result was the sending of trawlers by Mr. George Moody, of Grimsby, and the subsequent exploitation of the now well-known Dhu Artach fishing-grounds. Mr. Tate Regan made the suggestion at the recent British Association meeting that an enormous area of sea-bottom off the South American coasts might be explored with much gain to ichthyology, but there may also be great potentialities for fishing in such a survey; and no doubt there are other promising regions that might also be examined. One must not forget that the modern steam trawler had not been "invented" when the old *Challenger* sailed, and so such an object as we suggest here was probably not in the minds of her officers and naturalists.

There are certainly many other lines of investigation that are either new or present themselves to us now in a new way. One feels, for instance, that the mode of origin of coral reefs, atolls, barriers, etc., has still to be investigated on a really comprehensive scale, and with all the methods of modern physical and biological chemistry. In this connection speculation and theory have far outrun observation to the extent that one is appalled at the task of examining the various hypotheses that have been made and of tackling the enormous literature. Some really big investigation of this subject is now imperative (if only

from the point of view of the unhappy teacher of zoology!). There is probably (one finds it difficult to be sure) no adequate investigation of the physical chemistry of the water of a lagoon, considering such matters as CO₂-equilibrium between atmosphere and sea; changes in hydrogen-ion concentration; the effect of pelagic organisms, and their variability in abundance, upon these functions; the precipitation of calcium carbonate from solution by bacteria (work which is suggested by Drew's incomplete investigations in the *Tortugas*), and so on. In fact, the outlook upon coral formation and the growth of reefs is now entirely different from what it was in 1872. What is the rôle of commensal algæ and the Pütter method of nutrition of marine animals, for instance? And, in this connection, how *do* deep-sea animals really feed? There are no satisfying observations upon this point.

These considerations point to one direction in which the general methods of the old expedition ought to be revised. It is absolutely essential that a new voyage should be world-wide and comprehensive—more so than was the old voyage—and, given a well-chosen ship, this ought to be practicable. But, none the less, *intensive* investigation of relatively small areas is required—not such investigations as those of the Mediterranean, the Ægean, and the Baltic, for example (these ought to be the work of *local* expeditionary forces), but rather prolonged examination of oceanic islands, atolls, parts of a continental coast that have special significance, and so on. This can be attempted only by detaching parties (one or two men of science with assistants) from the ship and leaving them at such scientific, strategic points with all the materials and apparatus necessary for the research—whatever it may be. Perhaps a dozen or so such landing parties placed here and there over the world, relieved at intervals by the parent expedition and taken care of, would be almost as valuable to science as the main expedition. They could study temperature and salinity variations and meteorological phenomena, set up tide gauges, collect, analyse, and so on—there is no end to the work to be done.

This suggests a matter of organisation which may well be neglected: the *personnel* of the expedition must—if all that is suggested here is attempted—be rather large, and it could not possibly be obtained just now. It can be raised, given two years' notice of the certainty that an

expedition will sail, for in that time men can be trained. Just now there must be many young men to whom it would be sheer joy to be destined for units in a new *Challenger* landing party, and the prospect of such an adventure would be a powerful incentive to sustained and earnest training. No doubt this is a matter which those who are trying to organise the expedition have in mind. No doubt also the evident shortcomings of the old expedition are being scrutinised—one suspects on reading the "Narrative" that there was a good deal of what is now called "joy-riding." These are details, perhaps, that are incidental to the planning of the scientific work, but they seem to be really important.

J. J.

To the foregoing account of what it may reasonably be expected that an oceanographic expedition would accomplish, and of the preparation that will be necessary, we have now regretfully to append the announcement that the council of the British Association has reluctantly decided that the organisation of such an expedition on an adequate scale cannot be profitably promoted at the present time.

In accordance with the resolution passed by the general committee at the Cardiff meeting, the council appointed a special oceanographic committee to inquire into the details of the suggested project and to prepare a reasoned statement as to the need for such an expedition and its probable scale, scope, equipment, and cost. This memorandum has now been completed, and is available for use when the occasion arises; but in view of the present demand for economy in all national expenditure, and after consultation with trustworthy authorities, both scientific and administrative, the council at a recent meeting adopted a report by the general officers to the effect that, while retaining the scheme under consideration, no further action should be taken until circumstances seem more favourable for public expenditure upon such an undertaking.

The Oceanographic Committee will remain in existence with a watching and organising brief ready to revive the project whenever a favourable opportunity arises, and the council will doubtless report upon the whole matter to the meeting of the general committee of the Association at Edinburgh next September.

It is hoped that the proposed expedition is postponed only for a season, and that the interval may be usefully employed in perfecting plans and making other essential preparations.

Problems of Life and Mind.

- (1) *The Ways of Life: A Study in Ethics.* By Stephen Ward. Pp. 127. (London: Oxford University Press; Humphrey Milford, 1920.) 6s. 6d. net.
- (2) *Symbiosis: A Socio-physiological Study of Evolution.* By H. Reinheimer. Pp. xii+295. (London: Headley Bros., 1920.) 15s. net.
- (3) *Free Will and Destiny.* By St. George Lane-Fox Pitt. With *Open Letter on the International Moral Education Congress and League of Nations.* By the Rt. Hon. Sir Frederick Pollock, and appendix by Frederick J. Gould. Pp. xix+100. (London: Constable and Co., Ltd., 1920.) 5s.
- (4) *Beauty and the Beast: An Essay in Evolutionary Aesthetic.* By Stewart A. McDowall. Pp. vii+93. (Cambridge: At the University Press, 1920.) 7s. 6d. net.

THE solution of the problems of life and mind, to which George Henry Lewes addressed himself in mid-Victorian times, still exercises the thought of to-day. It is noteworthy that, although he did not make full use of the concept, Lewes, following Mill, urged that the kind of effect he called "emergent" (and Mill "heteropathic") is qualitative, new, or, as it is sometimes termed, "constitutive," and cannot, like "resultant" effects, be quantitatively deduced from given antecedents by a process of algebraical summation. On this, much modern interpretation turns. It does not, of course, follow that there are not laws of qualitative emergents, just as there are quantitative laws of resultants. Nor does it follow that, in life and mind, there is no hereditary transmission of emergent qualities. Nay, rather it may be said that the laws and the history of evolution are founded on emergence as, in the long run, the keynote of progress. In the system of philosophy which Prof. Alexander has recently laid before us the stages of emergence from the bosom of space-time are fully discussed.

Noteworthy, too, is Lewes's treatment of the unconscious, which, for him, was to be interpreted, after mid-Victorian fashion, in terms of physiology. That does not satisfy the thinkers of to-day. Many claim that, in psychical terms, all that is psychical must be interpreted; and if, in the midst of our fully conscious life, with its memory and anticipation, there surges up much that is new, and that, from its very newness, carries neither the again-ness of the one nor the not-yet-ness of the other, this must be interpreted as the outcome of psychical integration which

has nowise been established in the conscious life of the individual concerned. It is not here a case, as in habit, of the submergence of that which has been integrated in the light of conscious purpose, but of the rising above the threshold of that which was integrated outside that individual life.

There are thus two forms of integration: (i) that which is established in the course of individual life above—for the most part in human life well above—the threshold of consciousness; and (ii) that which comes to each one of us in integrated form from the subliminal part of the psychical system to which we are heir. Neither of these can now be neglected; but one or the other may receive special emphasis. The stress in Mr. Stephen Ward's book (1) is on integration in the field of thought. Not readily is there to be found in such short compass so suggestive a treatment—no mere summary, but touched throughout with individuality—as that which is the foundation of his study of ethics. He insists that, for thought, every fact is a conceptualised fact, and inevitably to be taken as universalised; and “while we think in the present, *what* we think of is either past or future.” Hence, “inasmuch as the present is not expressible in thought, it follows that the purpose of our being is not expressible in thought. For thought, the word ‘purpose’ always has a future reference; for life, our purpose is to be what we are, to have a present.” And while, in life, so much is provided *for* thought to discuss, yet of this a great deal is nowise provided *by* the thought of the individual or the race. Its integration has been otherwise established.

The goal of reason is truth, and “the first necessity of reason is that it should be one and one only. There cannot [ultimately] be several kinds of truth. It must be self-standing and complete, for if it were not complete, it would depend on something outside itself—something, that is, which would be more true than itself.” Whence “it is obvious that no experience of which we are capable could possibly fulfil these conditions.” But the perfectly right, as the goal of duty, is in like position. Man is bound “to realise eventually that, situated as he is, all that he can know of reason or morality is that they are *not* what he is, because both require a freedom or completeness which his life is unable to supply.” They are unattainable ideals, but thereby they lose nothing of their grandeur.

Here morality is dealt with *in excelsis*. A reasonable being and a moral being are one and the same—but beyond our reach. On the other hand, Mr. Reinheimer (2) seeks the roots of

morality in the very beginnings of life. His advocacy of symbiosis, in his extended sense of the word, is well known from his previous publications. Making due allowance for some over-emphasis, pardonable in the advocate, what one may fairly regard as his main contention—that integration in bionomic relatedness is essential to the good of all concerned in the intricate web of life—is sound at the core. In this mesh of relatedness the nutritive factors demand as careful study as those which subserve the end of reproduction. Life as a whole is an integrated symbiotic whole; and if we be “sharers in a wholesome panpsychism” we may fairly seek and find in the very foundations of organic evolution the foundations also of the integration of the unconscious, neither identifying the psychical with the physiological, nor accepting the mythological views of Maeterlinck and Samuel Butler (which are considered and criticised by Mr. Reinheimer), but regarding them as distinct, though, in some way, deeply and closely interrelated. Mr. Reinheimer, indeed, suggests that the physical and mental work together in internal or domestic symbiosis.

Thus, while, for Mr. Ward, at the upper limit of human thought is the concept of duty which under the conditions of our life cannot be reached, for Mr. Reinheimer the foundations of duty are laid in that integrated biological reciprocity to which he extends the concept of symbiosis.

Intermediate between these different levels on which the problems of life and mind may be discussed is the doctrine of the complex as affording the foundations on which a superstructure of consciousness is built. Mr. Lane-Fox Pitt, in his “Purpose of Education,” of which his essay on “Freewill and Destiny” (3) is the sequel, says that a complex may be defined as a dynamic system of closely associated ideas linked together in some experience, or succession of experiences, with corresponding emotions, perceptions, memories, interests, and range of volitions. In every individual, he says, there are “egos” innumerable, and they all strive. Freedom is the escape from this bondage of strife. Our destiny is the conquest of this multiplex egoism. Hence it would seem that, alike in the realm of ethical thought, with which Mr. Ward deals, in that of symbiotic interrelatedness under Mr. Reinheimer's treatment, and in that of a complex of complexes founded on the unconscious, as interpreted by Mr. Lane-Fox Pitt, the direction of progress is towards further and fuller integration of factors which, under the correlative process of differentiation, tend to fall asunder.

When, in this difficult problem of the unconscious, we dig down to essentials, the question

arises whether such a definition of a complex as Mr. Lane-Fox Pitt suggests can be accepted, at any rate so far as "the submerged part of the iceberg" is concerned. Are there ideas, or memory-images, or wishes, or thoughts in the unconscious? Or are there psychical processes, tendencies, dispositions, urges, hormones, or however else they may be named, which determine the character and colour of ideas which, as such, live only above the threshold? Under the influence of what some regard as picturesque Herbartian mythology, of Prof. Bergson's fascinating poetry, of the rather repellent Freudian treatment of the latent dream, we have an interpretation in terms of unconscious ideas and memory-images. Is this science or mythology? That is the central question, whatever the answer may be.

Lewes was tireless in his emphasis on the distinction between what he called empirical and metempirical treatment—between what one may speak of as integration in fact, and the real or supposed cause or source to which that integration is due. In his illuminating discussion of æsthetics (4), founded on Croce, but containing some interesting modifications of treatment, Mr. McDowall accepts the view that the only reality is living spirit, and that beauty is expression, or the form given by the spirit to its intuitions, through which it makes contact with reality; but whereas for Croce the living spirit is immanent and unfolding, for Mr. McDowall its ultimate explanation is in its relatedness to a transcendent source whence all personality is derived. Our "expression" enables us to realise a greater and more perfect Expression than ours. Love is relationship, and beauty the expression of relationship; but there must be reciprocity. Give and take must go hand in hand in the realm of personal being, which is the only ultimate reality. Beauty in evolution is the progressive purification of that which may have its temporal foundations in that impulse of sex which psycho-analysis reveals.

Now one may agree with Lewes that empirical and metempirical solutions of the problems of life and mind should be carefully distinguished. It may be that in matters of science the latter may, by a self-denying ordinance, be rigorously excluded; but they cannot be ruled out from philosophical discussion; and Mr. McDowall's well-developed thesis, in this and other writings, demands full consideration before a court in which not only men of science, as such, are represented.

Regarded, however, from the purely empirical point of view, æsthetic expression and its correlative impression must take their due place among

the problems of life and mind. To whatever source the integration may be due, integration there is. Nay, but is there not more than integration? Is there not the progressive evolution of the new? Unquestionably there is; and for its interpretation we must accept the concept of emergence, emphasised by Lewes and elaborated by Prof. Alexander. How comes it that in thought there arise universals which cannot be got out of a mere summation of particulars? How comes it that the proteins of even closely allied species are different? How comes it that the unconscious complex has characters all its own? How comes it that from lust in the animal there is the beautiful expression of love in man? In each case there are emergent characters which cannot be interpreted as resultants in terms of algebraical summation. Science must accept emergence as a natural datum, in the absence of which there would be no evolution to be interpreted. It then falls to the lot of philosophy to ask and, if it may be, to answer the deeper question: What is it that makes emergents emerge?

Plant Biology.

A Text-book of Plant Biology. By Prof. W. Neilson Jones and Dr. M. C. Rayner. Pp. viii + 262 + vi plates. (London: Methuen and Co., Ltd., 1920.) 7s.

MANY have tried their hands at writing books on botany, and although not a few have achieved some success, none has won it in that full measure which to the uninitiated might seem so easy of achievement. The subject is so rich and varied, and plant life so intriguingly beautiful, that it is, indeed, hard to understand why we have to wait so long for a really good elementary text-book of botany. It may be that the older among us did in our youth drink too deep of the German springs of botanical knowledge, and that the supplies from those sources, though excellent for local consumption, have the defect which is often inherent in their mineral and yet stronger waters—that of travelling ill; or it may be that the writing of a good text-book of botany is in truth a peculiarly difficult task.

The science owns a broad domain—morphology, physiology, pathology, all lie within its range, and those botanists are few who have wide knowledge of them all. Moreover, the laboratory, which has done so much for research, has not proved so useful as a centre for the dissemination of knowledge. It is not a good propagating house, and as plants grown therein are apt to thrive but poorly, so books written by the dwellers in laboratories are perhaps lacking in freshness. This at

least is true, that if an elementary text-book is to appeal to young people it must have something of the freshness of the fields and of the fragrance of their plants.

The great merit of the text-book by Prof. Neilson Jones and Dr. Rayner is that it has freshness and fragrance. The art whereby the authors have cultivated these qualities so successfully is, as becomes good art, not apparent. They have taken the old themes; but the setting is simpler. As is essential for the writing of a good book, the authors have morphological minds, and hence their work is well proportioned. They write easily and simply; the careless English so frequently employed by writers of scientific and other literature is rarely used by them. Now and again they fall from grace—as, for example, in the use of “up” thrice on pp. 2 and 3; but in general the histology of construction—the phrasing—is as good as the morphological plan is sound. That plan consists in the distribution of the subject-matter under three headings: the plant as a machine (a “works” would surely be better), the plant as a begetter of machines, and the plant as a citizen of the world.

In the first division the main facts of plant physiology and morphology are described—experimental demonstrations being relegated to the end of the chapters; in the second section growth and reproduction, cell division and heredity are dealt with; and in the last section the ecology of plants is taught in a manner altogether fresh and delightful. From the point of vantage of a beech clump in the Berkshire Downs the authors survey the vegetation and show the near and far plant associations, plant societies, and the open and closed formations. What is no less acceptable, they spare their readers the overgrowth of terminology which, unless it be pruned hard, will choke the young plant of ecological science, and prove once again the truth of the old adage that “Botany is easier to learn than its nomenclature.” The two former sections of the book are treated in a more conventional manner, and it may be that newness of presentation of physiological and morphological facts is as unnecessary as it is undoubtedly difficult.

If, as is to be hoped, a new edition of this book be called for, the authors might, perhaps with advantage, consider the advisability of jettisoning some of the wealth of information which they have included in the present edition. For example, alternation of generations is a subject which in its fullness makes a fine and impressive story, but it is small and unexhilarating beer when taken only in the fern. If alternation were to go, embryo-

sacs might go also—that is, be left for later studies. The desire “to cover the ground,” though warmly approved by publishers, is one which should be ruthlessly suppressed by every writer of an elementary text-book on botany. It would also be well to transfer the chapter on the soil which concludes it to an earlier place in the volume, for this chapter should certainly come before that on ecology, and would be aptly placed in that section of the work which deals with osmotic phenomena and the absorption of water by plants.

F. K.

British Coal-fields.

Coal in Great Britain. By Dr. W. Gibson. Pp. viii+311+vihi plates. (London: Edward Arnold, 1920.) 21s. net.

THE need for a small book giving within a reasonable compass a trustworthy summary of the essential characteristics of the coalfields of Great Britain has long been felt, and, as might be expected from the high qualifications of the author, the present volume goes far indeed towards filling this want. The first few chapters have been practically rewritten from an earlier book by the same author entitled “The Geology of Coal and Coal Mining,” but they have been amplified and brought up to date. If, however, any fault is to be found with this general portion, it is that the author has scarcely availed himself so fully as he might have done of the most recent researches on the subject, such as the monograph on the constitution of coal by Drs. Stopes and Wheeler, or the results attained by the admirable micro-sections of coal produced by Mr. Lomax. Possibly also the paragraph on the classification of coal might have been considerably expanded with advantage to several classes of readers.

It may be noted in passing that 6572 ft. is now no longer the greatest depth reached by a diamond bore-hole. This is the depth of the Paruschowitz boring, but it was surpassed some years ago by the Czuchow bore-hole, also in Silesia, which reached a depth of 7350 ft. The two chapters dealing with the stratigraphy of exposed and concealed coalfields respectively are very well written and illustrated, and should make the principles of this somewhat obscure subject intelligible even to the general reader, whose demands the author has obviously kept in view throughout the book.

The second part, which occupies about two-thirds of the work, consists of descriptions of the coalfields of Great Britain and Ireland. Naturally,

the space that can be devoted to each is very limited, and, as the author himself points out in his preface, many details which may assume considerable local importance, but are relatively insignificant from a more general point of view, have perforce been omitted. The salient features of each field have, however, been carefully studied, and are stated in such a way as to give a sufficiently clear view of their various characteristics; perhaps it might have been preferable to have subdivided the coalfields of Scotland, and to have devoted at least two chapters to these, instead of dealing with all of them in one, although no doubt that chapter is relatively a long one. Whilst there are necessarily omissions here and there, partly for lack of space, as has already been pointed out, and partly because no two geologists are at all likely to agree as to the relative importance of certain features, actual mistakes are decidedly rare.

It might have been desirable to devote more care to the sketch-maps of the coalfields, for they are by no means so clear as they might have been made; for example, in the map of the Northumberland and Durham coalfield it is doubtful whether a certain line lettered as a dyke of igneous rock is intended to represent the author's idea of the course of a possible dyke of such rock, or whether it is meant for the approximate line of the great fault known as the Ninety Fathom Dyke. At the same time, it is only right to admit that the representation of geological maps in black-and-white upon a very small scale is by no means an easy matter. The author may fairly be congratulated on having compressed so much useful information within the limits of a small but well-balanced volume, and it is fortunate that it appears at a moment when the importance of an accurate knowledge of the coalfields of the country is becoming generally recognised.

H. L.

Practical Aeroplane Photography.

Airplane Photography. By Major H. E. Ives, U.S. Army. Pp. 422. (Philadelphia and London: J. B. Lippincott Co., 1920.) 18s. net.

MAJOR IVES was formerly officer in charge of the experimental department of the photographic branch in the American Air Service, and as such he and his collaborators have had access to the information, photographs, and drawings supplied by the Allies to the United States. He has therefore had a unique opportunity of compiling a book describing the practice of air photo-

graphy in the war and the apparatus employed, an opportunity which has probably not been afforded to any other individual. The work undertaken has been, on the whole, well done, and an interesting book results. The numerous well-printed illustrations form one of the most noteworthy features; they include not only photographs of apparatus, diagrams, and interesting air views, but also many reproductions from the secret official publications of the Intelligence Branch of the British War Office, which have not hitherto been available in England. When looking through the 208 figures, one notices that in a few cases their source is acknowledged, but in the majority of cases figures are copied from English, French, or Italian sources without acknowledgment. Whatever may be said of this free use of English official photographs, the direct reproduction of five well-known diagrams drawn, we believe, by Capt. Durward, R.A.F., and of two tables copied from M. Clerc, without reference to their authors, can scarcely be passed without comment.

The sections of the book dealing with apparatus and materials are distinctly good. The author has selected his material well, and the only inaccuracy noted is in the description of the Williamson film camera. In describing tilt-recorders, the Goerz type only is figured and mentioned, though the Zeiss type was more commonly employed by the Germans. In his account of aerial photographic methods and the utilisation of photographs, the author is less fortunate, probably having little first-hand knowledge. His treatment of stereoscopy seems somewhat superficial, while his chapter on map-making is quite unsound. He has adopted the untenable view that a series of overlapping prints taken by a plane flying level at a constant altitude constitutes a complete pictorial map of the ground. This view may possess an element of truth when the ground is flat, but it cannot be used as a basis for aerial survey. It has already called down the contempt of surveyors, and in 1916 led the General Staff of the French Army to prohibit the use of photo-mosaics and squared maps made from them. Under the impression that an assemblage of photographs—or a photo-mosaic, to use a more precise term—is a map, the author goes on to give a useful description of the method by which such a mosaic is made, but is, in consequence, confused when he tries to introduce the work and suggestions of Bagley. Aerial map-making can be developed only by recognising that, while a photograph may seldom itself be regarded as a map, it does give a representation of the ground from which an accurate map can be compiled (so long as

certain conditions are known). With a good modern lens aberrations are negligible, and every other factor may be determined more or less accurately; the greater the accuracy attained in the estimation of the factors—height and such like—the greater will be the accuracy of the resulting compilation.

The conceptions of metrophotography and photogrammetry do not seem to find any mention in the book. It is almost inconceivable that an author should devote a section of his book to aerial mapping without any reference to the work already done in survey by photography from balloons. The subject of mapping by aerial photography was of vital importance in the war, and is the most promising outlet for the aeroplane camera in peace; its inadequate treatment here forms a serious blemish on an otherwise useful book.

H. H. T.

Our Bookshelf.

The Flowering Plants of South Africa. Edited by Dr. I. B. Pole Evans. Vol. i. No. 1, November, 1920. Pp. ii+10 plates. (London: L. Reeve and Co., Ltd.; South Africa: The Speciality Press of South Africa, 1920.) 15s., coloured; 10s., plain.

EUROPEAN gardens owe so much to South Africa for the plants which adorn them that the appearance of a South African *Botanical Magazine* is an event of considerable interest. Dr. I. B. Pole Evans, the energetic Director of the Botanical Survey of South Africa, who is editing "The Flowering Plants of South Africa," is to be congratulated on this new venture to bring the treasures of the South African flora to the notice of a wider public. In the preface it is stated that the publication is due to the keenness and interest of a South African lady, "whose love for her country and its natural beauties has been the means of procuring the necessary funds for the initiation of the work." The plants illustrated will represent so far as possible the flowering plants of the several provinces of the Union of South Africa.

It is unfortunate that in this first number the plants depicted, though familiar garden plants, are not for the most part of very special interest, and it is to be hoped that in succeeding numbers some of the less known and more striking flowers of South Africa will be represented.

The work being prepared in South Africa and produced in England has suffered considerably, and both the illustrations and the descriptions leave a good deal to be desired. The printing of the names at the foot of the plates is also unfortunate in view of the corrections that have had to be made in England in the text of plates 3 and 4, so that an incorrect name appears on each plate.

The experience gained from the publication of this first number will, we hope, lead to a con-

siderable improvement in following numbers. In making criticisms on this useful and interesting venture it is realised fully how great the difficulties in its production must have been.

The Garden Doctor: Plants in Health and Disease.

By F. J. Chittenden. Pp. x+154. (London: Country Life, Ltd.; New York: Charles Scribner's Sons, 1920.) 7s. 6d. net.

THERE are few gardeners, even scientific ones, who will not learn much from these pages, for Mr. Chittenden's position at Wisley gives him many opportunities of ascertaining the common pests of plants and their appropriate treatment. After giving an excellent and popular synopsis of the structure and physiology of the plant, he treats of those ailments due not so much to parasites as to wrong treatment. He deals with fungus pests by mentioning the common plants in alphabetical order, and in a few words sketches both diseases and treatment. His chapter on insect pests is not so good, though here, as throughout the book, he deals with principles, and if these are grasped the reader should be able to diagnose the nature, at any rate, of most of the common pests. There are chapters on fungicides, insecticides, and spraying generally, the usual formulæ being given. The illustrations on the whole are excellent, but lose much of their usefulness by having no text references, and appear to have been collected casually. Several of them are taken from the Ministry of Agriculture leaflets without acknowledgment, while others are of pests not mentioned in the book. The reference to the winged form of American blight as the "fly," and to the apterous form as the "insect," is not to be commended, while the full explanation of the plate of the "Daffodil Fly," which has a humorous touch, would be interesting. Despite minor criticisms which might be made, this is a most readable and interesting book.

G. C. G.

The Birds of the British Isles and their Eggs. By

T. A. Coward. Second series. *Families Anatidae to Tetraonidae.* Pp. vii+376+159 plates. (London and New York: Frederick Warne and Co., Ltd., 1920.) 12s. 6d. net.

THIS second series completes Mr. Coward's work on British birds, already favourably noticed in the pages of NATURE. It treats of the numerous and varied forms of aquatic and wading birds, storks, bustards, rails, pigeons, and the game-birds. The coloured figures, which represent practically every species, have been nicely reproduced in miniature from the late Lord Lilford's well-known book, most of them being the work of Mr. Archibald Thorburn. The coloured figures of the eggs are less satisfactory, but may be regarded as acceptable. In addition to these plates there are sixty-nine photographic illustrations of both birds and their nesting haunts. This wealth of illustration, in conjunction with the author's excellent and appropriate letterpress, renders this work the best of the minor books devoted to a subject which is ever growing in popularity.

Betty and Bobtail at Pine-Tree Farm. By Lillian Gask. Pp. 224. (London: G. G. Harrap and Co., Ltd., 1920.) 6s. net.

WE suppose that a book by this well-known author requires no commendation, but perhaps an appreciation in these pages may have a peculiar value. The story of a little girl's visit to a farm and what she saw of dog and sheep, weasel and vole, bat and eagle, and other creatures—it is not a work of science, of course, but a work of art; and how it is done who shall say? We could tell the same story, but no child would turn an ear. One must have the secret of the Pied Piper. It seems clear, however, that part of the success of the book must be due to its truthfulness—for the natural history seems all right, except a tale about golden eagles hunting the deer in Scotland. Another part of the success of the book must be due to restraint in giving information, for many books for young folks fail utterly in their Sandford-and-Mertonism. The boy explaining why bats are not birds would have been a bore if he had said another word, but he stops just in time. Goethe said something about this sort of thing! The rest of the attractiveness of the book is due to the art of the writer. We should add, however, that the coloured illustrations by Miss Helen Jacobs are charming, and the book is beautifully printed. We commend it heartily for young children.

Letters to the Editor.

[The Editor does not hold himself responsible for opinions expressed by his correspondents. Neither can he undertake to return, or to correspond with the writers of, rejected manuscripts intended for this or any other part of NATURE. No notice is taken of anonymous communications.]

The Disintegration of Elements by α -Particles.

IN earlier papers one of us has stated that long-range particles which can be detected by their scintillations on a zinc sulphide screen are observed when α -particles pass through air or nitrogen, but not through oxygen or carbon dioxide. From the deflection of these particles in a magnetic field it appeared that they were charged hydrogen atoms, indicating that some of the nitrogen atoms were disintegrated by an intense collision with an α -particle.

In these preliminary experiments it was difficult to get definite information as to the range of these particles from nitrogen, and so to compare them with the H atoms set in motion by the collisions of α -particles with ordinary hydrogen. Recently, improvement of the optical conditions has made the counting of such weak scintillations much easier and more certain. We have been able to show definitely that the H atoms from nitrogen have a greater range than the H atoms from hydrogen, the ratio being about 1.4 to 1. For example, the H atoms liberated by α -particles of range 7 cm. from hydrogen or any hydrogen compound have a maximum range corresponding to 29 cm. of air; while those from nitrogen have a range of 40 cm. This result shows that these particles cannot possibly arise from any hydrogen contamination.

This observation has opened the way to a series of experiments on other elements. The material under

examination, in the form either of gas or of a thin film of element or oxide, is exposed to the α -rays of radium C. Observation of the number of scintillations is made through a thickness of mica corresponding to a distance of 32 cm. of air, so that the results are quite independent of the presence of hydrogen or any hydrogen compound in the material.

In this way we have obtained definite evidence that long-range particles are liberated from boron, fluorine, sodium, aluminium, and phosphorus, in addition to nitrogen.

The numbers observed from boron and sodium are much smaller than those from the other elements mentioned.

The following elements showed very little, if any, effect at an absorption corresponding to 32 cm. air, viz. lithium, beryllium, carbon, oxygen, magnesium, silicon, sulphur, chlorine, potassium, calcium, titanium, manganese, iron, copper, tin, and gold.

The gases oxygen, carbon dioxide, and sulphur dioxide were examined at absorptions of less than 32 cm. air, and no trace of these particles was observed. We have not yet examined whether any of the other elements give rise to particles of maximum range less than 32 cm.

The particles liberated from all the first-mentioned elements have a maximum range of at least 40 cm. in air. In particular, the range of the particles from aluminium is surprisingly great, and certainly not less than 80 cm.

While we have no experimental evidence of the nature of these particles except in the case of nitrogen, it seems likely that the particles are in reality H atoms liberated at different speeds from the elements. Assuming that the law connecting range and velocity of the particles is the same as for the α -particle, it follows that the energy of the particle from aluminium of the maximum range of 80 cm. is about 25 per cent. greater than the energy of the incident α -particle.

It is of interest to note that no effect is observed in "pure" elements the atomic mass of which is given by $4n$, where n is a whole number. The effect is, however, marked in many of the elements the mass of which is given by $4n+2$ or $4n+3$. Such a result is to be anticipated if atoms of the $4n$ type are built up of stable helium nuclei and those of the $4n+a$ type of helium and hydrogen nuclei.

It should also be mentioned that no particles have so far been observed for any element of mass greater than 31. If this proves to be general, even for α -particles of greater velocity than those of radium C, it may be an indication that the structure of the atomic nucleus undergoes some marked change at this point; for example, in the lighter atoms the hydrogen nuclei may be satellites of the main body of the nucleus, while in the heavier elements the hydrogen nuclei may form part of the interior structure.

Until accurate data are available as to the effect of velocity of the α -particles on the number, range, and distribution of the liberated particles, it does not seem profitable at this stage to discuss the possible mechanism of these atomic collisions which lead to the disintegration of the nucleus.

E. RUTHERFORD.
J. CHADWICK.

Cavendish Laboratory, February 26.

The Atomic Volume of Isotopes.

AT the discussion on isotopes at the Royal Society on March 3 the question was raised as to within what limits of accuracy the conclusion is justified that the atomic volume of the various isotopes of lead is constant, and the following collected results

may therefore be of interest. There are two sets of data. In one the density and atomic weight of lead from thorite have been compared with the values of ordinary lead, and in the other a similar comparison has been made for the lead derived from two uranium minerals. These two sets, of course, cannot be compared together, as the densities of specimens are comparable only when they have been prepared under identical conditions. With due attention to this point the relative densities are, in the case of lead, capable of determination to a very high degree of accuracy.

In the first set of data (NATURE, February 4, 1915) the density determinations agreed in the case of three determinations on 73 grams of ordinary lead to within eight units, and in the case of two determinations on 65 grams of thorite lead to within four units in the fourth place of decimals. The first two values of the atomic weights in the following table are single determinations by a modification of Stas's method, the lead being converted into chloride, *via* the nitrate, in a quartz vessel without transference, and the ratio Pb : PbCl₂ determined. The third value is that obtained by O. Hönlgschmid in Vienna on another fraction of the same thorite lead used in the density determination by the silver titration method from four determinations of the ratio PbCl₂ : 2Ag and four of PbCl₂ : 2AgCl, and the probable error is given as ± 0.014 (*Zeitsch. Elektrochem.*, 1917, vol. xxiii., p. 161). The second set of data is that of T. W. Richards and C. Wadsworth (*Journ. Amer. Chem. Soc.*, 1916, vol. xxxviii., pp. 221 and 1658). The atomic weights are also by the silver titration method. The value 207.20 for the atomic weight of ordinary lead has also been obtained by G. P. Baxter and F. L. Grover (*Journ. Amer. Chem. Soc.*, 1915, vol. xxxvii., p. 1027), and the value 207.18 by O. Hönlgschmid and Mlle. S. Horovitz (*Monatsh.*, 1915, vol. xxxvi., p. 355) by similar methods. (Compare also *Ann. Rep. Chem. Soc.*, 1916, vol. xiii., p. 247.)

Variety of lead.	Atomic weight.	Density at 20°.	Atomic volume.	Difference from mean
Ordinary	207.199	11.3465	18.2619	+0.0009
Ceylon thorite... ..	207.694	11.3760	18.2572	-0.0038
	207.77		18.2639	+0.0029
		Mean	18.2610	
Ordinary	207.20	11.337	18.2765	-0.0026
Australian uranium ore	206.34	11.288	18.2796	+0.0005
Norwegian cleveite ...	206.085	11.273	18.2813	+0.0022
		Mean	18.2791	

The differences in the atomic volume are thus exceedingly small, and, moreover, they are not systematic. Rejecting the single determination of the atomic weight of thorite lead, it appears that ordinary lead with the intermediate atomic weight has an atomic volume slightly below that of the others. It seems quite safe to conclude that the atomic volumes cannot differ by so much as three parts in ten thousand and the atomic diameters by so much as one part in ten thousand. FREDERICK SODDY.

Relativity and the Velocity of Light.

IN his article in NATURE of February 17 on the general physical theory of relativity Mr. J. H. Jeans refers to recent experiments of Majorana, and his remarks imply that these experiments rendered it "possible to watch the progress of the ripple directly" and to measure the velocity of light in its unidirectional course from source to receiver, with the result that this velocity was shown to be constant. He contrasts these experiments with the original experiments of Michelson and Morley, in which the mean velocity of light in its outward and return journey

after its reflection from a mirror was dealt with. As the point in question is a fundamental one, and as a statement to this effect has been made before, I think the matter should not be passed over.

The experiments of Majorana referred to are doubtless those described in *Comptes rendus* (No. 14, tome clxv., 1917, and No. 2, tome clxvii., 1918) designed to show the constancy of the velocity of light relative to the observer when reflected by a moving mirror or when issuing from a moving source. I venture to suggest that these experiments do not bear the interpretation that Mr. Jeans puts upon them, and that the experiment has not yet been devised that will enable a comparison to be made between the velocity of light on its outward and return journeys along the same path, or that will give a measure of the velocity on a single journey. The author of these papers makes no claim to have done this. I fear such an experiment is impossible.

C. O. BARTRUM.

32 Willoughby Road, Hampstead,
February 24.

I HAD not intended to make the statement which Mr. Bartrum considers is implied in my words, and am sorry that in aiming at brevity I appear to have achieved only ambiguity. It need scarcely be said that I agree that no experiment has been, or can be, devised which can measure the velocity of light in any unidirectional course. The impossibility of any such experiment is, in effect, the primary postulate of the theory of relativity.

It is, nevertheless, possible to compare two velocities along the same unidirectional course, and this is what Prof. Majorana claims to have done.

The Michelson-Morley experiment gave us the sum only of the times of two separate journeys—from A (light) to B (mirror) and back from B to A. We cannot even speak of comparing the time on AB with that on BA until we have defined time at B in terms of the time at A. If this is defined in terms of the relativity relation $t' = \beta(t - ux/c^2)$, then the Michelson-Morley experiment is consistent with the two journeys being performed with the same velocity c , and therefore in equal times, but it does not of itself establish equality either of velocity or of time. The additional information provided by the experiments of Majorana does, I believe, enable this equality to be proved.

Consider the problem in terms of an æther and a FitzGerald-Lorentz contraction. According to the Michelson-Morley experiment, the time on the double journey is equal to

$$l_0 \left(1 - \frac{u^2}{c^2} \right)^{\frac{1}{2}} \left[\frac{l}{c-u} + \frac{l}{c+u} \right] \dots (1)$$

but there is so far no justification for identifying the two terms in this sum with the times of the separate journeys. The distributed expression for the time of the double journey might, in general, be of the form

$$l_0 \left(1 - \frac{u^2}{c^2} \right)^{\frac{1}{2}} \left[\frac{l}{c-u+a} + \frac{l}{c+u+\beta} \right] \dots (2)$$

where $c+a$, $c+\beta$ are the velocities through the æther on the two journeys. For this to conform to the results of the Michelson-Morley experiment, expressions (1) and (2) must be equal, requiring that

$$\frac{2c+a+\beta}{(c-u+a)(c+u+\beta)} = \frac{2c}{c^2-u^2} \dots (3)$$

Now impose a further velocity v on the whole Michelson-Morley apparatus, so that its velocity through the æther becomes $u+v$. The first result of Majorana (*Phil. Mag.*, vol. xxxv., p. 173) shows

that β remains unchanged. His second result (*Phil. Mag.*, vol. xxxvii., p. 149) shows that α remains unchanged. The time of the double journey is accordingly obtained by replacing u by $u+v$ in expression (2), and the Michelson-Morley result requires that equation (3) shall remain true when $u+v$ replaces u . Since Majorana's results held over a considerable range of values of v , it appears that (3) must be true for a whole range of values of u , requiring at once $\alpha=\beta=0$, so that the two terms in expression (1) must represent separately the times of the inward and outward journeys.

Translate this into relativity language, and it appears that when x, t, x', t' are related by the usual Lorentz transformation, then the Michelson-Morley experiment, when supplemented by the observations of Majorana, shows that both on the outward and on the inward journey light travels with the same constant velocity c . J. H. JEANS.

Relativity and the Deviation of Spectral Lines.

THE prediction of the Einstein spectral-line effect rests on two assumptions, namely, (1) the radiating source behaves as a natural clock, and (2) the time-period of the source is transmitted by the radiation to the observer.

An alternative to the second of these assumptions is that the radiation transmits the Einstein interval ds rather than the time interval dt of a vibration. This alternative appears to be more in accordance with the general ideas of relativity.

Consider two light pulses leaving A at times t_A, t_A+dt_A , and arriving at B at t_B, t_B+dt_B . Since $ds=0$ along the world line of each pulse, it appears that the interval $\gamma_A dt_A$ between the two departures from A is equal to the interval $\gamma_B dt_B$ between the arrivals at B—that is, the Einstein interval, and not the time interval, is transmitted.

If this contention be correct, the Einstein effect should arise, not from the transference of the source, but from the transference of the observer to a different gravitational field.

It may be contended that the use of the principle of least time in the ordinary method of deducing the deviation of a beam by a gravitational field presupposes an underlying constant time period in the radiation. To this I would reply that it is possible to deduce the deviation without any reference to pre-Einstein physics. I propose to deal with this point in a communication to the *Philosophical Magazine*.

H. J. PRIESTLEY.

University of Queensland, Brisbane,
January 15.

Amplifying the Optophone.

MR. CAMPBELL SWINTON'S forecast in NATURE of March 3, p. 8, has been fully verified since he wrote. On Tuesday, March 1, the Marconi Co. kindly lent me one of their three-valve amplifiers working with an S. G. Brown loud-speaking telephone and wooden trumpet. Mr. F. Swann, of the Marconi Co., personally superintended the installation, and we succeeded without much difficulty in producing a sound which made ordinary printed matter "legible" to several blind pupils in a room. A reading demonstration from the amplified sound was given in the presence of Sir William Collins and Mr. C. P. MacCarthy.

This new development marks a great step forward, and I consider that Mr. MacCarthy and Mr. Campbell Swinton deserve credit for their initiative in this matter.

E. E. FOURNIER D'ALBE.

to St. James's Terrace, N.W.8, March 5.

NO. 2680, VOL. 107]

WITH reference to the letter on the above subject in NATURE of March 3, it may be of interest to record that thermionic amplifiers were applied to the optophone a considerable time ago with the object of increasing the sound in the ordinary telephone, but although it was evident that the sound could be amplified, it was decided that to increase the cost and complexity of the instrument to the extent involved by the addition of an amplifying set was not justified.

In 1919 Messrs. Barr and Stroud, Ltd., applied to Messrs. Marconi, of Chelmsford, who were kind enough to prepare a special amplifying set.

At a later date, through the kindness of Major Henrici, the valuable advice and assistance of officers of the Signal Department at Woolwich were also obtained.

Mr. Swinton, by the application to the subject of his great experience of amplifiers, has attained most encouraging results in making the optophone notes audible for instructional purposes.

JAMES WEIR FRENCH,

Director, Barr and Stroud, Ltd.

Annesland, Glasgow, March 7.

The Peltier Effect and Low-temperature Research.

I WAS much interested to see Mr. A. A. Campbell Swinton's letter to NATURE of February 24, p. 828, on the above subject. So far as I am aware, the first suggestion to attain low temperatures by means of the Peltier effect was made by me when a student some twenty years ago. If Mr. Campbell Swinton will look up NATURE of August 15, 1901, p. 376, and also the *Chemical News*, 1901, vol. lxxxiv., p. 73, he will see an article by myself entitled "On a Possible Method of Obtaining the Absolute Zero of Temperature," in which the method is suggested in detail. There is little doubt that a great field of research would open out once the absolute zero of temperature were obtained, and temperature as a phase vanished from matter.

Attention may also be directed to a paper by Mr. Brinkworth and myself entitled "On the Heatless Condition of Matter" in *Chemical News*, 1902, vol. lxxxv., p. 194. Of course, it must be recollected that we were writing twenty years ago, long before modern developments occurred. Unfortunately, I have been out of touch with such matters, and have not had the opportunity of seeing whether any researches have been carried out on these lines owing to my work developing in a different direction.

GEOFFREY MARTIN.

109 Corporation Street, Manchester,
March 2.

WITH reference to Dr. Geoffrey Martin's interesting letter, it was because I thought it very possible that the idea was not new that I put my suggestion in the form of an inquiry. I have looked up his several most suggestive papers, which fully bear out what he says.

As I have pointed out, since the date of Dr. Martin's communications to NATURE and to the *Chemical News* in 1901, Prof. Kamerlingh Onnes has verified the disappearance of electrical resistance at very low temperatures which Dr. Martin, amongst others, predicted. It does not appear certain whether at such temperatures, when electrical conductivity in metals becomes infinite, either the Peltier effect or the corresponding opposite thermopile effect would operate.

Perhaps these effects may be enhanced, but possibly they may disappear; much would appear to depend upon how these low temperatures affect heat conduc-

tivity, with regard to which, I fancy, little is known. For instance, with temperatures at which electrical conductivity becomes infinite, does heat conductivity also become infinite? It would seem that this can be determined only experimentally. Perhaps Prof. Onnes, or someone else who possesses the necessary apparatus, could be induced to try the experiment. Let us hope that someone will do so.

A. A. CAMPBELL SWINTON.

66 Victoria Street, London, S.W.1, March 5.

The Sound of Distant Gun-fire.

THE results of the comparison of observations made on both sides of the fighting line upon the long-distance audibility of gun-fire have been rather disappointing. It appears that in Belgium and Germany a very marked maximum was found everywhere in the cold season, while in England and France the sounds were perceived in the summer months only. Moreover, in the latter countries the guns were never heard when the wind was blowing from the battlefields towards the observers, while in the former the direction of wind seems to have been of little importance.

The vertical distribution of temperatures and variations of wind velocity with altitude are generally recognised as the chief factors of the curvature of the trajectories of sound, and they both bend the sonorous rays upwards when temperatures are diminishing and the strength of a head wind is increasing with altitude. The former is at its maximum efficiency in summer, when there is a steep gradient over the surface of the earth; the other is nearly always a characteristic of air-flows, since, as a rule, friction against the soil retards the lower strata. It appears, therefore, at once that the long-distance transmission of gun-fire sound was observed in England and France when the conditions favouring the bending upwards of the rays were at their best. On the other hand, there seems to have been nothing particularly favourable to their being bent downwards in the upper air; first, because in summer temperature inversions at moderate heights are rare, and, secondly, because the contrary wind that was wanted was from between south-west and north-west, and it is a well-known fact that this wind generally occupies at all seasons the whole height of the troposphere. True, its speed begins usually to slacken above 11 km., and at about 20 km. eastern components appear. But one might rightly fear that rarefaction of the atmosphere at such altitudes must already have reduced the intensity of sound greatly.

Now, on the German side it is quite the reverse; the influences that curve the rays upwards are at their lowest when the maximum of audibility occurs, since this is the case in winter, when the gradient of temperature is very feeble and often reversed, and with indifferent direction of wind. But these very inversions are a powerful cause of bending the rays downwards. Thus with the ordinary wind-temperature theory we cannot escape an almost complete contradiction.

The hydrogen-atmosphere theory of van den Borne and van Everdingen cannot help us out of this perplexity, since in this theory the long-distance perceptibility of sound should be quite independent of meteorological conditions, not to speak of the insuperable difficulty of attributing sufficient intensity to a sound travelling through a vacuum of 0.01 cm. at 70 km.

I therefore think there is only one way of escape, namely, to advocate *diffraction*. It is well known that sonorous rays are endowed with this property in

a remarkable degree, and along such flat trajectories as must be the case in the long-distance propagation of sound, refracted rays cannot fail to diffuse to the earth all along. It is rather surprising that there should be a silent zone at all. Now, in ordinary circumstances these refracted rays, coming back to earth in all directions from the source, would be too faint to be perceived by any but a very attentive and well-trained ear as soon as a moderate distance from the centre of emission is reached. Should, however, any cause productive of upward curvature bend the rays that make a small angle with the horizon, then a caustic will be formed by these rays, and also by the diffraction rays issuing therefrom, so that the intensity of sound in these bundles of diffracted rays will grow sufficiently for hearing to be possible. The causes of upward bending, viz. vertical gradients of decreasing temperature and decreasing force of wind, are as a rule the more marked the nearer the earth one considers them. Thus the rays nearest the horizon are the most energetically bent, and the whole group intersect one another at small angles, thus forming beams where intensity is at a maximum.

In this theory diffraction would be the normal cause of the return to the earth of the sonorous waves in England and France; temperature gradient and contrary wind would only have to concentrate the rays in caustic bundles in order to intensify the sound at great distances. If temperature inversions and change of wind velocities or directions add their influences in order to bend the sound-tracks downwards, as in the German winter conditions, the direct rays themselves might be deflected towards the earth.

In this way everything seems to have a satisfactory explanation except the summer minimum of Germany. This is a very remarkable feature indeed, and very perplexing, for in summer as well as in winter the conditions for the return of the sound rays seem to be altogether more favourable on the German than on the Anglo-French side. For over the contrary east winds that bend them upwards flow, as a rule, the permanent west currents of the higher troposphere, the effect of which is to bend them down. One might wonder whether, perhaps, their bending effect is not *too* strong, and whether all but the rays damped by their passage through highly rarefied air are not brought back to earth *too soon* for a long-distance audibility zone to be possible! This hypothesis seems worth examining closely.

At any rate, the problem has lost its pleasing simplicity, and there is little hope that observations made during the war and not yet published will solve it adequately. One thing, therefore, remains to be done, and that is to turn to that supreme criterion—experiment.

Now this means organisation with vast resources and on a huge scale. Batteries should be fired on some suitable spot of the ancient Front (to facilitate taking into account the observations of the war) and observers posted along well-chosen lines, chiefly in the directions against and with the wind, at various distances in the air as well as on the ground. The salvoes should be fired at pre-arranged hours, so as to permit of calculating the trajectories travelled through by the reports. At the same time, and about the same places, meteorological observations as complete as possible should be made, and they, too, should be taken by aeroplane and dirigible at all suitable heights as well as on the earth.

No doubt this would be a tremendous business. But let it be remarked that there was a long period of time when it could have been done with little cost and scarcely any difficulty; this was in the months following the conclusion of peace, when immense

dumps of ammunition and enemy ordnance had to be destroyed, as well as thousands of aircraft, and when thousands of airmen and many war-meteorologists were waiting for demobilisation.¹ Is it not a pity that all these forces have been left unemployed? There still may be enough of them left to attempt to execute at least part of such a programme. But there is no time to lose, for every step that brings us nearer complete demobilisation diminishes the facilities and enhances the cost of the undertaking.

V. SCHAFFERS, S.J.

Louvain, January 28.

The Designation of Vitamines.

THE opinion now appears to be general that the bodies known as accessory foodstuffs should not be termed "vitamines," as they have not been proved to be amines, and, in fact, nothing appears to be known of their constitution. Recently the name has been written "vitamin," but this is not sufficiently distinctive for the spoken word unless the termination be pronounced as "min," *i.e.* with the "i" short.

If American authors cut off the final "e" from "amine," as some do from chloride, iodide, sulphide, sulphate, etc., the dropping of the "e" from "vitamine" will not help matters so far as such authors and their readers are concerned. I hope that the practice of dropping the final "e" will not spread to English writers; for, although we should probably soon get used to the appearance of chlorid, sulphid, sulphit, sulphat, phosphat, etc., there may be a tendency for some to pronounce these words with the "i" short as in "fit" and the "a" short as in "fat," while others would naturally retain the present pronunciation; it is most undesirable to have two different pronunciations for one and the same substance. The method of spelling sulphur and its derivatives as sulfur, sulfates, etc., cannot affect the pronunciation, and, moreover, the "ph" has crept in in error.

The "vitamines" might have been appropriately called "vitallines," which would indicate the vital part they play in nutrition, but that is, perhaps, too near to "vitelline" in sound and unnecessarily long; if they were termed "vitams," "vitans," "vitines" ("vitines" is probably more euphonious than "vitams"), or "vitins," all possible chance of confusion with other bodies would be avoided. The different varieties could be distinguished by A, B, etc., as has been proposed, or by α , β , γ , etc., in accordance with the usual practice of so indicating closely related chemical substances; or the water-soluble varieties might be written as w.s., or simply w., vitams, and the fat-soluble ones as f.s. or f. vitams; the letters w.s. or w. and f.s. or f. would at once be recognised as indicating their solubilities in water or fat, and there would not be the same difficulty to the reader of recollecting what A, B, etc., stand for.

A. LIVERSIDGE.

Kingston Hill, Surrey.

Scientific Names for Commercial Timbers.

IN the notice of "A Manual of the Timbers of the World" in NATURE of September 16, 1920, the reviewer's final paragraph reads as follows:—"Endless embarrassment to the landowning class resulted during the war from the confusion between the names 'silver spruce' and 'silver fir.'"

Now, from my experience in the use of both

¹ [This suggestion was put forward by Prof. de Quervain in January, 1910, and is referred to in NATURE, vol. cii., p. 377, and vol. ciii., p. 31.—EDITOR.]

scientific and common names, I feel sure all this confusion could have been obviated by using scientific names only, for in this case the timbers referred to are both generically and specifically different, viz. *Picea sitchensis* and *Abies pectinata* respectively, and, naturally, differently textured timbers. Although it is a long way from "down under," I make this appeal to the scientific man in the homeland, hoping that he may prevail on the commercial man to use scientific names exclusively, and to show him how by his following a scientific lead it will be to the latter's financial advantage.

Much confusion existed in the nomenclature of the product produced by eucalyptus-oil distillers when the Sydney Technological Museum first undertook research in this field of economics in 1897, for then it was only with the greatest difficulty that oils true to name could be obtained, all and sundry leaves being put in the still. By using scientific names only from the start, the pharmaceutical, perfumery, and other industrial enterprises have in this direction been so much assisted that the industry is placed on such a scientific basis that all orders for Australian oils are given under scientific names, the common names being absolutely discarded, and so putting a stop to endless confusion such as one finds in the timber trade.

If this can be accomplished throughout the whole essential oil trade, from oil distillers in the bush to the city merchants, and finally to the chemist and pharmacist, surely the timber trades and foresters are not to be regarded as having a *personnel* on a lower intellectual plane than, say, the bush distiller.

This confusing of common names in Australia also gives great trouble to the various trades using timbers; to give one instance only, there are five distinct species of Proteaceous timbers placed on the Sydney market under the name of "silky oak." In order to assist the trades, I was moved to write a paper on the subject, which was read before the Royal Society of New South Wales. As a result, several firms are now specifying scientific names when placing orders for "silky oak," as they know that by so doing they will obtain the exact kind of timber they want for their requirements, and insist on having that particular timber; so in the end there is satisfaction all round.

RICHARD T. BAKER.

Technological Museum, Sydney, N.S.W.,

January 6.

"Elementary Practical Biochemistry."

IN the otherwise discriminating and useful review of my little book, "Elementary Practical Biochemistry," which appeared in NATURE of November 25 last, there are certain statements due to a misunderstanding which I should like to correct, as they might lead to an unjust estimate of the standards in the medical school with which I have the honour to be associated. The reviewer regrets that insufficient attention is paid to preparative and quantitative work, whilst the absence of treatment of hydrogen-ion determination constitutes a "serious defect."

As the preface indicates, this volume is one of three. Of the other two, one is to be devoted to clinical applications, and the remaining one to preparative and quantitative procedures. There is already in the press a detailed description of hydrogen-ion determination by the indicator method, and also by the electrical method, using the Leeds-Northrup potentiometer and a special electrode which is the outcome of some years of patient investigation by Dr. J. M. Lewis, a research student in my laboratory.

W. A. OSBORNE.

University of Melbourne, January 24.

Colloids and Colloidal Electrolytes.

By PROF. J. W. MCBAIN.

COLLOIDS comprise all matter that is made up of particles smaller than a wave-length of light, but larger than a single molecule of an ordinary crystalloidal substance such as sugar, salt, or water. It would appear that in some cases the chemical molecules are linked together into particles of colloidal dimensions, and then from these particles are built up the familiar structures such as rubber, fibres of cotton, wood, or earthenware. It is a moot question as to whether, in the case of certain highly complex organic substances, the single molecules themselves may not be large enough to exhibit the distinctive properties of colloidal particles.

Scientific study has been devoted almost exclusively to mixtures in which colloidal particles are dispersed throughout a second continuous medium; such as in many precious stones, ink, the body fluids, or a bar of soap where the continuous medium is water. Furthermore, the investigations of physical chemists have been directed almost entirely to the study of very dilute colloidal solutions (sols) such as dilute suspensions of gold or arsenic trisulphide in water, whilst biologists have devoted a great deal of attention to gelatin and protein, colloids of a very different type. For this reason the innumerable observations that have been made on colloids have not been well linked up either with each other or with our general scientific knowledge. There are, however, two outstanding instances in which some of the familiar and unambiguous methods of classical physical chemistry have been extended to the study of highly characteristic colloids—namely, soaps, chiefly studied in this country, and proteins, chiefly elucidated by W. B. Hardy and by the professor of biophysical chemistry in Vienna University, Wolfgang Pauli.¹ It now appears that soaps, proteins, and gelatin salts are closely similar types of substances, whilst soaps are by far the most accessible to quantitative measurements.

A very important characteristic of most colloidal solutions which have received careful study is the fact that the colloidal particles possess electrical charges. For instance, silver particles of diameter of about 500 millionths of a millimetre, suspended in water, move under the influence of an electric field. This must be ascribed to electrical charges on the particles, and calculation shows that on each such particle there are anything up to 100 million negative charges or electrons. This electrical charge seems enormous until we reflect that it is relatively ever so much less than the number of atoms of silver, and that in an ordinary ion there is one electrical charge for each atom.

The stability of the dilute suspensions of such

insoluble substances greatly depends upon these electrical charges.

As will be shown, these "irreversible" or "suspensoid" particles, which have been so largely studied, occupy an intermediate position between electrically neutral colloidal particles, such as rubber in solution in benzene, and the much more highly charged colloidal particles known as the ionic micelle that occur in such aqueous solutions as those of soap. In the ionic micelle or particle the number of electrical charges is commensurate with the number of molecules or ions which have aggregated together.

Another prominent characteristic which physical chemists have met in attempting to study suspensoid colloids is their extreme variability and sensitiveness to all sorts of disturbing influences. It has become almost an axiom that only variable and non-reproducible results can be expected, and that they depend on the individual specimen examined. It is all the more fortunate, then, that in the case of soap solutions it is possible to obtain quantitative reproducible results depending only upon the composition and the state of the system. This has enabled us to investigate through these comparatively simple substances of known molecular formulæ and structure some of the characteristic properties exhibited by solutions of so many of those extraordinarily complex chemical substances, mostly of unknown formulæ, which are involved in all life processes, and are frequently of very great industrial importance. Salmon's suggestion is that these colloids should be called "equilibrium colloids," a classification that would in practice more or less correspond to the present modified use of Hardy's term "reversible colloids," now used chiefly with reference to the properties of dried residues. The expression "equilibrium colloids" has the advantage of possessing a rather deeper significance.

In the study of soap solutions in the Bristol University laboratory, it was first established that they exhibited excellent electrical conductivity even in the most concentrated viscous solutions. The change in conductivity with concentration exhibited remarkable anomalies such as had hitherto been met with only in certain non-aqueous solutions. The curve passes through both a maximum and a minimum in moderately strong solution. At this time it had been generally considered that colloids as such could not exhibit conductivity, and if observed it was ascribed to impurities and admixtures.

Although there were no admixtures in the case of these specially pure soap solutions, no data at all existed with regard to the amount of alkali set free in the solution through hydrolysis of the soap by the solvent water. Direct measurements succeeded in showing through two independent methods, electromotive force and rate of cata-

¹ A comprehensive summary of Pauli's masterly researches on this particularly complicated material is to be found in his "Kolloid-chemie der Eiweisskörper." Pp. 109. (Dre-den and Leipzig: Th. Steinkopff, 1920.)

lysis, that the hydrolytic alkalinity of soap solutions is for most purposes negligible, and hence that the conductivity observed must be proper to the soap itself. Incidentally, this result is of interest in showing that the process of saponification in the manufacture of soap could be much more complete than was thought by such authorities as Lewkowitsch.

A further essential stage in the development of this problem was attained through the study of the osmotic activity of the soap solutions. This property is, in such cases, surprisingly inaccessible to trustworthy quantitative measurement. However, a development of Cumming's dew-point apparatus gave a general method of securing data, and the results were confirmed by cryoscopic measurements upon the few soaps which could be studied in solution at 0° . The upshot is that a mass of trustworthy data proves that soaps exhibit osmotic activity comparable with that of an ordinary crystalloid such as sugar.

This at once exposed a fundamental difficulty in interpreting the results according to any of the other hitherto recognised theories of physical chemistry. The conductivity is that of a highly dissociated salt, whereas the osmotic activity is scarcely equal to that of an undissociated crystalloid, and yet many years of work had been devoted to establishing the trustworthiness of each of these facts. Examination of the results of the concentrated solutions of the higher soaps showed that, whereas the conductivity corresponded to that of two good conducting ions, the osmotic pressure was only that of one ion altogether. In other words, the osmotic result proved that the only crystalloidal constituent of such a solution was the sodium or potassium ion, all the other constituents, including whatever accounted for quite half the conductivity, being colloidal.

Hence we are driven to the conclusion that there are present in these solutions colloidal particles, the "ionic micelle," possessing an actual conductivity often several times greater than that of the sum-total of the ions which are contained in it, and which in so aggregating have retained their electrical charges. These aggregates are so large that they have little or no osmotic effect. For suggestions that make plausible the properties and stability of such aggregates, reference must be made to papers published by the Royal Society and the London and American Chemical Societies, where also it is shown how these conceptions explain the various properties of soap solutions. Direct measurements are now being carried out to test even more directly the validity of the explanations here advanced.

For the sake of clearness it should be emphasised that conductivity is not identical with rate of movement in an electric field, for it is a remarkable fact that matter in all states of subdivision from single atomic ions up to coarse granules may move at roughly the same rate in an electric field. This movement (cataphoresis) in the case of a fine grain of sand might thus be

equal in magnitude to that of one of the slower ions, whereas the resulting equivalent conductivity is only infinitesimal. The ionic micelle of soap solutions is noteworthy in that its mobility in an electrical field exceeds that of most true ions.

It is probable that quite general laws underlie the behaviour of colloidal particles together with all surfaces of separation in which ionising solvents are involved, thus including emulsions as well as large continuous surfaces.

In another respect, too, soap solutions afford a particularly good example for the study of a colloid in that the whole gamut of transition stages between ordinary salts and colloids can be illustrated by choosing the salts of the various fatty acids, or even by a mere change in concentration of a solution of any one of these. In dilute solution the soaps are largely present as simple salts, whereas in concentrated solutions of the higher soaps we have the complete formation of colloidal electrolyte.

Having gained some insight into the properties and behaviour of the slightly charged colloids and the highly charged colloidal electrolytes, the greatest need at the present time for the development of colloid chemistry is the discovery of some method of studying neutral uncharged colloids, such as, for instance, rubber or nitrocellulose solutions. No one has yet succeeded in developing a general method for obtaining quantitative data of direct significance, and a big advance is to be hoped for in this direction. This would probably lead to rational methods for the study of such familiar but complicated structures as the textiles, or paper, in which solvent is no longer present.

Recent study of soap solutions in the Bristol University laboratory has shown, further, that they can exist in three distinct characteristic forms—namely, clear, somewhat viscous, liquid sols, transparent elastic gels, and white opaque curds. Nearly all our previous knowledge of the properties of jellies has been due to the study of gelatin, usually containing admixed and partly combined salts or acids. The simpler case of the soap gels is, again, suited for study because no extraneous substances are present, and, as we have seen, the various constituents of the soap solution are characterised by well-marked properties such as conductivity and osmotic activity.

It has now been shown that the properties of soap solutions are independent of whether the solution is in the form of sol or gel except for the distinctive mechanical properties of the latter. In other words, the chemical equilibria, and hence the colloidal particles, are identical in sol and gel. This means that the gel structure must be built up of the same colloidal particles as were present in the sol. The possibilities as to the nature of this structure are severely limited by the fact that the conductivity remains unaltered. Hence we must infer that the colloidal particles are stuck together to form loose aggregates, which may be fragments of irregular network, or more probably innumerable filaments,

which, being embedded in the solution, give to the whole its temporary rigidity and elasticity. Many other lines of evidence support this view. For instance, the optical evidence shows that the structural elements in the gel are of very fine colloidal dimensions, far below the powers of the microscope. This conclusion that the particles in sol and gel are identical in number and nature shows that nothing analogous to crystallisation has taken place.

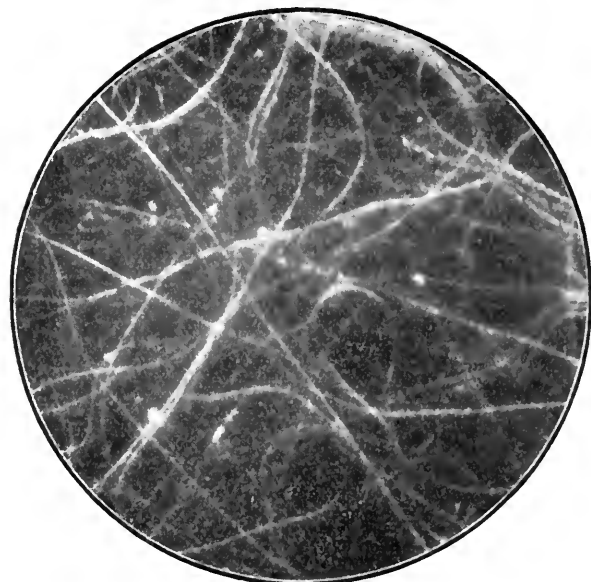

FIG. 1.—Ultramicroscopic appearance of a sodium soap (0.8N Sod. Myristate, $\times 600$).

In clear contradistinction to this, curds and coagula are formed by a process closely analogous to crystallisation. Soap sols and gels show almost nothing in the ultramicroscope with its dark ground illumination, but when solidification to white curd begins white fibres of barely microscopic diameter are seen to shoot out until the whole becomes a dazzling white felt of these fine fibres. Fig. 1 (magnification 600) illustrates

this appearance in a typical sodium soap, the myristate, in this its permanent stable state. To the naked eye it appears as a hard white cake of soap. Fig. 2, the stearate, exemplifies the more complicated behaviour of soft potassium soaps, in which the fibres that first appear are extremely short, and often twinned, but in which, on standing, true microscopic crystalline plates appear. These tiny crystals undoubtedly account for the "figging" which is seen in most good soft soaps.

Work at the Bristol University laboratory has

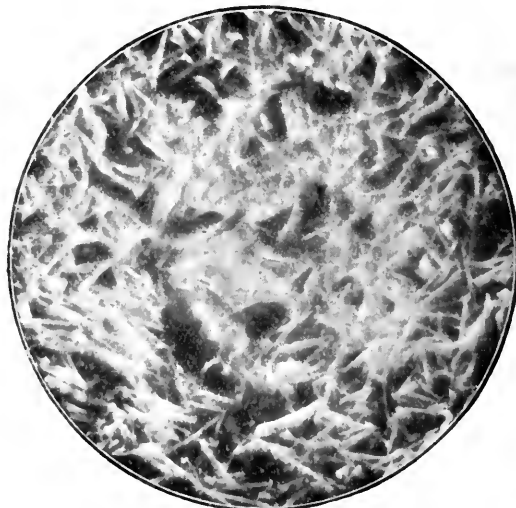

FIG. 2.—Ultramicroscopic appearance of a potassium soap (0.5N Pot. Stearate, $\times 500$).

not been confined to the elucidation of the results here outlined, but an extensive programme of investigation of the colloid and phase-rule phenomena involved in the typical processes of soap boiling is in progress, in the expectation that the precise elucidation of the behaviour of this particularly suitable and characteristic material may lead to the better understanding of some of the typical problems of the physical chemistry of the colloidal state.

Inland Waterways.¹

By DR. BRYSSON CUNNINGHAM.

THE outstanding feature of Mr. Minikin's book is the very interesting series of photographic illustrations which it contains; these impart a most effective realisation of the physical characteristics of the watercourses described in the text. They are a most serviceable adjunct, and some of the views have the additional charm of being picturesque. We reproduce two by way of example.

The work consists of ten chapters, of which the first is preliminary, and the second deals with general considerations relating to torrential

phenomena, bends, valleys, and erosion, while chap. iii. is on rainfall. The available rainfall, or run-off, is said to vary between 20 per cent. on permeable soils and 75 per cent. on impermeable ground. As limits, these are perhaps somewhat wide, and might, in this country at any rate, be appreciably narrowed. From a survey of flood discharges in England and Wales it has been computed by Mr. Clayton that in average areas the run-off to the sea is between 50 and 60 per cent. of the total rainfall. Transpiration, as a source of absorption of rainfall, receives little notice. Chap. iv. deals with river surveys, and in particular describes methods applicable to running

¹ "Practical River and Canal Engineering." By R. C. Royal Minikin. Pp. vii+123+12 plates. (London: Charles Griffin and Co., Ltd., 1920.) 12s. 6d.

surveys in unexplored or virgin tracts such as are to be found in Brazil, where the author has had much experience. For computing discharges, the well-known Chezy formula

and interesting, and the author's experiences in Brazil and elsewhere yield a number of practical hints of serviceable importance.

The startling incident recorded on p. 21 of the sudden invasion in clear weather of a trekking camp in Minas Geraes, Brazil, by a torrent from a downpour of rain on the hill summits some few miles away gives a vivid idea of the uncertainties and vagaries of rainfall in some districts. However, it is not necessary to seek an example so far away as Brazil; there was quite recently a disastrous instance of the same kind in Lincolnshire when the town of Louth was swept by a flood without any warning. The author dwells on the influence of vegetation in regard to its effect on rainfall, and says that in Brazil, as in other countries, great loss has been incurred through the careless cutting down of trees to make way for the farmer.

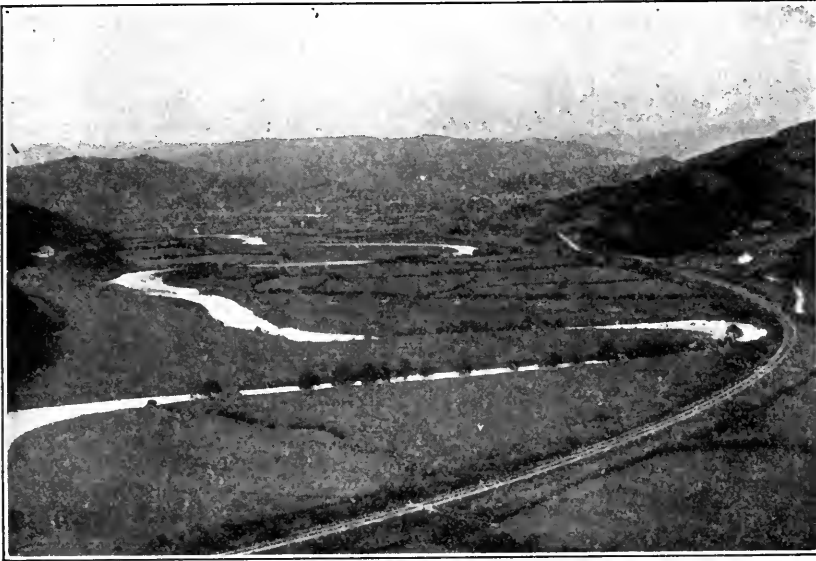

FIG. 1.—Dovey Valley, showing the river meandering from side to side of a broad, flat valley. From "Practical River and Canal Engineering."

is quoted, but there is no reference to the classic expression of Ganguillet and Kütter, or to the suggested adaptation of Chezy's formula in a very compact form, put forward by Mr. Barnes a few years ago. Chap. v. treats of waterways (water-courses would be a better term), which are classified as torrents, torrential rivers, semi-torrential rivers, and smooth flowing rivers. Chap. vi. deals with floods, chap. vii. with water flow, and the two following chapters with river training and canalisation. Canals are left to the last, and are compressed within the limits of a single chapter.

He states that many extensive forests have disappeared within the last fifty years, due to the custom of burning down a wooded area to form new plantations as soon as the old, for lack of care, have become exhausted. He believes

From the foregoing outline of the contents, and from the fact that the book contains only 119 pages of matter in fairly large sized print with numerous illustrations, it is evident that the treatment of the subject is necessarily general. Indeed, the author disclaims any attempt to include theoretical considerations in his purview. The explanation of so important a subject as canal construction within the compass of ten pages is obviously insufficient for completeness. As a brief review, however, the book has the merit of being clear



FIG. 2.—Canal in sandstone cutting. From "Practical River and Canal Engineering."

that the lack of rain upon several districts in Brazil is a direct consequence of this policy; this is an opinion which will, however, not command general acceptance.

Recent Work at Stonehenge.

THE repair of Stonehenge by the Office of Works has given occasion for the renewal of the excavations which were begun some twenty years ago by the Society of Antiquaries. The event is of good omen, not only because of the co-operation of a learned society with a Government Department, but also because the new evidence obtained by a season's work will emphasise the necessity of field-work in archæology. Much has been written about Stonehenge and our prehistoric monuments generally, but the past year has contributed more to our actual knowledge than all the theorists. The examination of the so-called Aubrey holes has demonstrated the former existence of a megalithic monument older than the Stonehenge of to-day. It consisted of a circle of standing stones, enclosed by a bank and a ditch, and seems to have been robbed of its stones, presumably for use in the present Stonehenge, during the period of the Bronze age in this country. Not long after the removal of the stones cremated human remains were placed in nearly all the holes in the chalk where the stones had stood. Similar deposits have been found in the ditch and elsewhere, and it will be well to suspend judgment on their meaning until the whole area has been thoroughly explored.

Meanwhile it seems that the last attempts to assign a date to Stonehenge should be reconsidered. The absence of any evidence that metal tools were used in its construction, and the deductions based on astronomical grounds, appeared to point to a date in the first half of the second millennium B.C. A more recent date is at least suggested by the late discoveries.

During the course of the work the use of modern cranes and jacks has inevitably suggested a comparison with the mechanical means possessed by the original builders. As is well

known, there are tenons on the tops of the upright stones, fitting into mortises on the lintels, which are thus kept in their places. The lintels also are worked with convex or concave ends, so that each is secured to its neighbour by a rough joggled joint. Stones so worked could only have been placed in position by lowering from above, and it is clear that the makers of Stonehenge were equal to the task of raising stones weighing five or six tons, and in some cases far more, to the required heights, and of setting them on the uprights with absolute precision. The use of levers and inclined planes of earth gives no satisfactory explanation, and seems absolutely excluded on the evidence of one of the existing lintels. This shows an enlargement of the mortises along the length of the under-side of the stone, which can only be the correction of a miscalculation discovered when the lintel was being lowered on to the tenons. To make the necessary alteration the lintel must have been removed, and this could scarcely have been effected without the use of some form of rope and a method of slinging, such as would not be at the command of a primitive and uncivilised community.

As a megalithic monument Stonehenge is anything but primitive, and is, indeed, in a class by itself, so far as British monuments are concerned. Whether the excavations of the next few years will bring to light any convincing evidences of its origin and purpose time alone can show.

The question of the origin of the "blue stones" has been once more attempted, and Dr. H. H. Thomas, of the Geological Survey, has positively identified them with the formation at the Prescelly mountains in Pembrokeshire. This is an important addition to our knowledge, though the question of their transport to Stonehenge is not thereby solved.

Obituary.

AS we go to press we deeply regret to see the announcement that LORD MOULTON died during the night of March 8.

SIR FELIX SEMON, the well-known laryngologist, died on Tuesday, March 1, at his residence at Great Missenden, Bucks. Sir Felix was born at Danzig in 1849, and received his medical education at Heidelberg, Berlin—where he took the M.D. degree in 1873—and later in Vienna and Paris. He then moved to London, received an appointment as clinical assistant at the Throat Hospital in Golden Square in 1875, and rapidly became known as an expert on diseases of the throat. In 1885 he was elected a fellow of the Royal College of Physicians, and in 1893 he was one of the founders of the Laryngological Society, of which he was president for the years 1894-96. When Sir Felix retired from London in 1911 a sum of 1040*l.* was presented to him in recognition

of his services to laryngology; this sum he presented to the University of London to establish the Semon Lecture Trust for the purpose of awarding a commemorative bronze medal for work on the treatment of diseases of the throat and nose, and to found the Semon Lectureship in Laryngology. Sir Felix received knighthood at the Diamond Jubilee in 1897, and was created K.C.V.O. in 1905. He was also the recipient of numerous foreign decorations, and was an honorary or corresponding member of many medical societies. Many articles from his pen have been published in medical journals and in the reports of scientific societies, but he will be best remembered as the founder and for twenty-five years the editor of the *Internationales Centralblatt für Laryngologie und Rhinologie*. His own work was chiefly in connection with cancer of the throat and with the functions and diseases of the motor nerves of the larynx.

WE regret to announce the death of SIR CHARLES ALEXANDER CAMERON on Sunday, February 27, at Dublin. Sir Charles was born in Dublin in 1830, and devoted most of his lifetime to the study of public health in his birth-place. He was a fellow of the Royal Colleges of Physicians and Surgeons of Ireland, of the latter of which he had been president, and he held a number of diplomas from various public health and sanitary institutions. From 1883-89 he was president of the Royal Institute of Public Health, and from 1893-94 he served as president of the Society of Public Analysts. Sir Charles was also a member of numerous foreign medical societies. For more than half a century he had control of the Public Health Department of Dublin Corporation, and had been public analyst for a large area round Dublin since 1862. In 1902 he was the recipient of the Harben gold medal. His publications afford a measure of the scope of his interests in science. The best known of his books is probably "The History of the Royal College of Surgeons of Ireland," the last edition of which was published in 1916. He was also the author of

books on agricultural chemistry and stock-feeding, as well as of numerous works and papers dealing with public health and hygiene. He received knighthood in 1885, and was created C.B. in 1899.

THE death of MR. JAMES KEITH on February 23, is announced in *Engineering* for March 4. Mr. Keith was the founder and managing director of the firm of James Keith and Blackman, the well-known heating and ventilating engineers, and much of the apparatus manufactured by his firm was of his invention. He was an associate member of the Institution of Civil Engineers, and a member of the Institution of Mechanical Engineers; he was also the author of numerous publications and contributions to the technical Press. Mr. Keith gave expert evidence in 1897 at the Board of Trade inquiry into the ventilation of the London Underground Railways, and also in 1903-4 before the Select Committee of the House of Commons on the ventilation of the Houses of Parliament.

Notes.

PROF. A. S. EDDINGTON has been elected president of the Royal Astronomical Society in succession to Prof. A. Fowler.

AT the meeting of the Royal Society on May 5 the Croonian lecture will be delivered by Dr. Henry Head on "Release of Function in the Nervous System."

THE Principal Trustees of the British Museum have appointed Mr. C. Tate Regan to be keeper of zoology and Dr. G. F. Herbert Smith assistant secretary at the Natural History Museum, South Kensington; also Mr. Robert L. Hobson and Mr. Reginald A. Smith deputy keepers in the department of British and medieval antiquities.

THE Toronto correspondent of the *Times* announces that a report by a Committee of the Dominion Privy Council, approved by the Duke of Devonshire, the Governor-General, expresses to Mr. Vilhjalmur Stefansson "the thanks of the Government of Canada in recognition and appreciation of your distinguished services rendered to Canada in connection with your explorations in the Arctic regions."

THE Radio Research Board of the Department of Scientific and Industrial Research, 16 Old Queen Street, S.W.1, is requiring workers of high academic qualification for the purpose of undertaking research work in wireless telegraphy. The yearly remuneration offered is from 350*l.* to 550*l.* In making application for the positions candidates should give particulars of any papers published by them in scientific journals.

THE following were elected fellows of the Royal Society of Edinburgh at the ordinary meeting on March 7:—Dr. Nelson Annandale, Mr. W. Arthur, Mr. B. B. Baker, Dr. Archibald Barr, Mr. J. Bartho-

lomew, Mr. A. Bruce, Mr. Andrew Campbell, Dr. Rasik Lal Datta, Dr. John Dougall, Dr. C. V. Drysdale, Mr. G. T. Forrest, Dr. W. Gibson, Dr. J. W. H. Harrison, Mr. J. A. G. Lamb, the Rev. A. E. Laurie, Mr. Neil M'Arthur, Mr. D. B. M'Quistan, Dr. T. M. MacRobert, Dr. J. M'Whan, Mr. J. Mathieson, Sir G. H. Pollard, Prof. E. B. Ross, the Right Hon. J. P. Smith, Prof. N. K. Smith, and Dr. I. S. Stewart.

AT a meeting of the Royal Dublin Society on February 22, the president, Lord Rathdonnell, in the chair, the Boyle medal of the society was awarded to Dr. George H. Pethybridge. In recommending Dr. Pethybridge's name as that of a suitable recipient of the Boyle medal, the science committee of the Royal Dublin Society directed special attention to his researches in the elucidation of the life-history of the fungi which cause blight in potatoes, and to his discovery of a process in the development of the sexual organs of *Phytophthora erythroseptica*, Pethy., and of *P. infestans*, Mont., until then unknown.

THE Geological Survey has just issued vol. xiv. of its Special Reports on the Mineral Resources of Great Britain, this being devoted to a description of the fireclays; it thus forms a companion volume to vol. vi., in which the other refractory materials such as ganister, etc., are described, and there is naturally a certain amount of overlapping between these two. The present report deals with the geology of the fireclays, and particularly with the available reserves of this material; it is intended that the chemistry of the subject should be dealt with in a separate volume, upon which Dr. J. W. Mellor is at present engaged. This is the first time that any serious attempt has been made to collect information upon this subject, the economic importance of which is

very great, having regard to the fact that high-grade refractory materials are indispensable to so many of our key industries.

THE following are the lecture arrangements at the Royal Institution after Easter:—Prof. R. A. Sampson on (1) The Nebular Hypothesis and (2) Measurement of Starlight; Prof. Keith, four lectures on Darwin's Theory of Man's Origin; Mr. Clodd on Occultism; Sir James Frazer on (1) Roman Life (Time of Pliny the Younger) and (2) London Life (Time of Addison); Dr. C. T. R. Wilson on Thunderstorms (the Tyndall lectures); Mr. H. S. Foxwell on Nationalisation and Bureaucracy; Dr. C. S. Myers on Psychological Studies: (1) Localisation of Sound and (2) Appreciation of Music; Mr. D. S. MacColl on War Graves and Monuments; Sir Alexander Mackenzie on Beethoven; Dr. H. H. Dale on Poisons and Antidotes; Mr. M. Y. Oldham on The Great Epoch of Exploration: (1) Portugal and (2) Spain; Prof. E. C. C. Baly on Chemical Reaction; Mr. F. Legge on Gnosticism and the Science of Religions; and Dr. R. S. Rait on (1) Scotland and France and (2) Scott and Shakespeare. The Friday evening meetings will be resumed on April 8, when Dr. R. H. A. Plimmer will deliver a discourse on Quality of Protein in Nutrition. Succeeding discourses will probably be given by Mr. Ernest Law, Sir J. J. Thomson, Sir James Walker, Sir Frank Dyson, Sir Robert Robertson, Dr. Bateson, Prof. Starling, Mr. A. Mallock, Dr. Leonard Huxley, and Dr. A. G. Webster.

AMONG the centenaries which fall due this year is that of Sir Richard F. Burton, the Oriental scholar and explorer, who was born on March 19, 1821. To the enterprise and daring which characterised Burton's travels in many unexplored parts of the world were added unusual powers of observation and a passion for scholarly research which together made him one of the most successful explorers of the nineteenth century. Practically all his numerous volumes remain standard works on the lands with which they deal. Among Burton's most striking exploits were his pilgrimage in disguise to Mecca and Medina in 1853-54 and his successful journey in 1855 to Harar, the forbidden city of Abyssinia, which several explorers had tried in vain to reach. In 1858 the expedition which Burton led to Central Africa in company with Speke discovered Lakes Tanganyika and Victoria, and so laid the foundations of modern knowledge of the sources of the Nile. Later work included important explorations in the Cameroons, the Gold Coast, Dahomey, and the Congo, and travels in the Rockies, Brazil, and Iceland. In addition to his geographical and anthropological volumes, Burton published a translation, with copious notes, of "The Arabian Nights."

IN the House of Lords on March 2 Lord Sudeley moved a resolution requesting the Government to take immediate steps to extend the employment of guide-lecturers and the sale of pictorial illustrations to all museums and similar institutions which are under Government control or influence. By this combination Lord Sudeley escapes the charge of asking only for fresh expenditure. The lecturers, it

is true, cost money, but the postcards and similar reproductions make money. That has been the experience of the British Museum at Bloomsbury, and we have long wondered why the sale of postcards and photographs has not been taken up by the Natural History Departments at South Kensington. In the debate initiated by Lord Sudeley a year ago the Primate suggested that the system might be extended to provincial museums. Some, like Colchester, already issue postcards; others would doubtless be glad to utilise the experience of the Clarendon Press and the British Museum authorities. The profits, as Lord Sudeley suggested, might help to pay for the guide-lecturers. A pooling of funds under some central organisation might provide lecturers each of whom could deal with a limited geographical group of the smaller museums.

THE annual general meeting of the Chemical Society will be held at Burlington House on Thursday, March 17, at 4 p.m., when the result of the ballot for the election of council will be announced and the retiring president, Sir James J. Dobbie, will deliver his presidential address. The presentation of the Longstaff medal to Prof. J. F. Thorpe will also be made. At the anniversary dinner of the society, to be held at the Hotel Cecil, Strand, on the same day at 7 for 7.30 p.m., the past-presidents who have completed their jubilee as fellows of the society have been invited as guests of honour. Sir James Dewar, who was elected on December 1, 1870, and served as president from 1897-99; Sir Edward Thorpe, elected on February 16, 1871, and served as president from 1899-1901; and Sir W. A. Tilden, elected on June 1, 1865, and served as president from 1903-5, have accepted invitations to be present. At the first banquet given on November 11, 1898, during the presidency of Sir James Dewar, to those past-presidents who had been fellows for fifty years, the society entertained Sir Joseph Gilbert, Sir Edward Frankland, Prof. William Odling, Sir Frederick Abel, Prof. A. W. Williamson, and Dr. John Hall Gladstone; whilst a later banquet was held on November 11, 1910, under the presidency of Prof. H. B. Dixon, in honour of Sir Henry Roscoe, Sir William Crookes, Dr. Hugo Müller, Dr. A. G. Vernon Harcourt, and Prof. William Odling, who had completed their jubilee as fellows.

THE route to Mount Everest is discussed in the *Geographical Journal* for February by Lt.-Col. C. H. Bury, who has been appointed chief of the projected expedition. Col. Bury favours the route from Darjeeling over the Jelep La Pass to Phari, and then *via* the Chumbi Valley, Kampa Dzong, and Tingri Dzong to the northern side of Mount Everest. The direct and shorter road to Kampa Dzong *via* Gangtok and the Tista Valley is more difficult for pack-animals, for it traverses in the Tista Valley a region of heavy rainfall where leeches abound. The route *via* Jelep La is now the main trade route into Tibet, and is traversed constantly by numbers of mules and pack-ponies. From Kampa Dzong to Tingri Dzong Col. Bury foresees no difficulties, and estimates that the journey should take about seven days in broad valleys about 15,000 ft. above sea-level. No advantage seems likely

to be gained by making use of the southern approach to Mount Everest by the Arun Valley, even if the Nepal Government gave consent. Col. Bury considers that aeroplanes would be useless in Tibet on account of the low density of the atmosphere, which would make it impossible for the present type of machine to rise off the ground. For general transport purposes he advocates yaks, which are very sure-footed and can be used up to altitudes of 20,000 ft. The *Geographical Journal* announces that official news of the expedition will be given solely through the Royal Geographical Society and the Alpine Club.

In the report of the Corresponding Societies Committee of the British Association for this year, a welcome change of policy is inaugurated in regard to the list of papers which the committee publishes annually. Hitherto this bibliography has been limited to papers appearing in the publications of societies affiliated to this committee. In that form it was incomplete, contained much that was of no value whatever, and was of little or no use to serious workers. By a judicious weeding-out of all subjects which are adequately dealt with in other bibliographies or by other societies, the list of papers this year has been confined to those dealing with the zoology, botany, and prehistoric archaeology of the British Isles. By extending its scope to include every British publication, whether of an affiliated society or not, the bibliography aims at a complete record of the work done in these subjects in this country. In its revised form the bibliography will be of immense service to those engaged in faunistic work and regional surveys. It covers the period from June to December, 1919, and appears to be remarkably complete. Only two omissions were detected in a list of more than a hundred references to the fauna of a particular district. The *Field* and *Country Life* are not included in the journals catalogued; perhaps they are regarded as newspapers, and therefore not within the scope of scientific journals. They, however, frequently contain records of great value, and every worker on British natural history has of necessity to search their pages for past records. The bibliography could be made more useful by a more detailed indication of the scope of each paper. For instance, all papers dealing with birds could be prefixed by the letter O instead of Z, and a similar distinctive letter could be arranged for all groups of animals and plants. Mr. T. Sheppard, the compiler, is to be congratulated on a useful piece of work, and thanked for the care and completeness with which it has been done.

DR. JAMES RITCHIE in the January-February issue of the *Scottish Naturalist* begins a survey of the occurrence of the walrus in northern Scotland. He shows that the modern walrus (*Trichechus rosmarus*) is a post-Glacial species which in prehistoric times ranged in British seas far south of its present haunts, while up to the middle of the sixteenth century it was evidently abundant in the Orkneys, where it was extensively hunted for the sake of its ivory, oil, and skin. Its extinction as a resident species was no doubt due, as in other parts of the world, to indiscriminate slaughter for economic purposes.

NO. 2680, VOL. 107]

THE common fox introduced into Australia somewhere about 1860 has for many years been a pest, but, according to an article by Mr. G. A. Keartland in the *Victorian Naturalist* for December last, the thousands annually slain and thrown away are to become a source of revenue; no fewer than 150,000 skins have already been disposed of in the fur market. The author is, however, mistaken in believing that in Europe this animal produces no more than two at a birth, and he is also mistaken in supposing that the hare in Great Britain produces no more than one young in a year. Thus his contention that these two animals have become more prolific in Australia is not justified.

DR. A. E. BARCLAY in the *Archives of Radiology and Electrotherapy* (No. 246, January, 1921, p. 225) indicates a danger arising from the Coolidge tube when used for X-ray screen work. Secondary radiation emanates from the anticathode, and the secondary image may pass through the screening diaphragm used; it is widely dispersed and produces undesirable effects. The recognition of this secondary radiation is of very great importance to the safety of the worker. The danger can be rectified by inverting the tube or by providing a hood for the anticathode.

AN interesting article on bacteriology in relation to commercial meat products appears in the *New Zealand Journal of Science and Technology* for November (vol. iii., No. 4), in which Mr. A. M. Wright describes the process of meat canning and the causes of failure. Frozen meat is also discussed, and an interesting experiment on the preservative action of cold described. A tub of water was inoculated with many millions of putrefactive bacteria, pieces of meat were immersed in it, and the tub was then placed in a freezing chamber and kept for five months at -15° - -20° C. At the end of this time the meat was examined; it was perfectly sweet and fresh, and sections showed no invasion of the meat by the putrefactive organisms.

Medical Science: Abstracts and Reviews for February (vol. iii., No. 5) contains, among other articles, summaries of recent work upon the radiological treatment of malignant disease, botulism, and epidemic hiccough. Botulism is a condition due to the ingestion of food containing poisons elaborated by an anaerobic bacillus, *B. botulinus*. Several outbreaks of botulism have occurred of late in the United States in connection with canned vegetable products, e.g. olives, asparagus, and beetroot. At Kiel an epidemic occurred from the consumption of pickled herrings. No outbreaks have been recorded in this country, but it is of interest to recall that the first cases of encephalitis lethargica occurring in 1918 were mistaken for it. Epidemic hiccough has been prevalent in France during this winter, and several French physicians believe that it is a manifestation of encephalitis lethargica.

WE have received part 12 (pp. 351-496) of the second volume of a recently established South American journal, *Physis*, which is the organ of the Argentine Society of Natural Sciences. It is well printed and illustrated, and is evidently a journal which cannot be overlooked by European students. The three most important articles in the part before us are by

F. Santschi on South American ants, by G. Bonarelli on the human mandibles of Bañolas, and by J. Brèthes on the South American bees of the genus *Xylocopa*, Latr. It may be added that two out of three of the above papers are written in French.

THE presidential address delivered by Comdr. J. J. Walker before the Entomological Society on January 19 dealt with "Some Aspects of Insect Life in New Zealand." It contains interesting information useful to the student of geographical distribution. As the author points out, the noble forests of the two islands are now little more than memories, and more than 350 species of introduced trees, shrubs, and weeds are ousting what is left of the indigenous flora. It is also a matter of certainty that the exceptional fauna of New Zealand is to a great extent doomed to extinction, and no effort should be lost to acquire as much information as possible concerning the animal life before the latter also is a thing of the past. Comdr. Walker comments on the very general opinion that New Zealand possesses the most limited insect fauna of any land of the same extent. He attributes this belief to the nocturnal or unobtrusive habits of many species, a large number being either inactive or retiring; many are cryptically coloured and hard to detect, and others very local. About 4000 species of Coleoptera are known, but the Cetoniadæ and Casididæ are absent. More than 1000 species of Lepidoptera inhabit New Zealand, and all except about 70 are indigenous. The butterflies, however, are very poorly represented, only 15 species being recorded. Diptera are abundant, but Hemiptera and Hymenoptera are comparatively few.

DURING the meeting of the Science Masters' Association at Oxford on January 5 and 6, some interesting demonstrations (with exhibits) were given by Mr. T. V. Barker in the mineralogical department of the University Museum on the subject of the study of crystals in schools, and a pamphlet of "Practical Suggestions" has been drawn up embodying the main facts dealt with. It is designed to amplify a previous pamphlet which was noticed in NATURE of September 2 last, p. 28. The preparation of solutions for crystallisation, instructions for the screen-projection of the crystals grown, the nature of crystals, isomorphism, polymorphism, and crystal structure as revealed by simple measurements were a few of the subjects dealt with in an attractive manner. As an example of the style adopted, a few lines from the reference to the isomorphism of the two acid phosphates of potassium and ammonium may be quoted:—"When the pupil has observed and measured both substances [under the microscope], he will agree with Mitscherlich that the two forms are isomorphous in the literal sense; and if some two years later he came to measure them with the reflecting goniometer he would, like Mitscherlich, revise his opinion and conclude that they are closely similar, but not identical, in angles."

THE variations of "mean sea-level" on the Flemish coast have been analysed by Dr. Bruno Schulz and the results published by the Deutsche Seewarte (*Aerologische und Hydrographische Beobachtungen den*

Deutschen Marine-Stationen während der Kriegszeit, 1914-18, Heft 1). Owing to war conditions full weather information was lacking, and the paper is chiefly concerned with long-period oscillations and with the correlation between non-periodic variations and local wind. Formulæ are given as representing these effects. It is interesting to note that it was impossible to use as data the difference between observed and predicted tides owing to the obvious errors of the latter, and daily means of hourly heights were used in conjunction with monthly and annual means. The wind effects are sorted according to direction and strength. The best results are found to be given by comparing the tidal height at a given time with the wind about three hours earlier. After allowing for wind there is a residual effect attributed to air-pressure; the ratio between simultaneous changes in sea-level and in barometer is found to have an average value of 10.3, the statical value being 13.4. Apparently the long-period oscillations, wind effects, and air-pressure effects are treated as being quite independent. There is great need for further work on these important problems, especially in this country.

In his presidential address to the Optical Society on February 10 Mr. Robert S. Whipple emphasised the influence of the design of scientific instruments on their accuracy, sensitivity, and cost of production. An instrument may be rendered ineffective by bad design of the moving parts, by unsuitability of the materials employed, or by bad workmanship. The selection of the materials, however, is part of the design, and good design will often minimise the effect of bad workmanship, though the converse is not true. A consideration of the fundamental principles of instrument construction shows the advantages of the geometric form of design. By geometric design internal strain in the parts of an instrument can be greatly reduced and backlash between the different parts eliminated. Geometric design may also simplify construction and thus materially reduce the cost of manufacture. The new applications of research to industry in many cases involve the new application of an old instrument. Thus the research instrument of to-day becomes the tool of to-morrow. In designing an instrument the manufacturer should, therefore, always have in mind the possibility of quantity production, so that the instrument can be readily developed from its laboratory form to one suitable for the workshop and capable of being manufactured on a large scale. Cheap production is thus rendered possible, and this is an important factor, especially in view of the keen competition which the scientific instrument industry of this country has now to meet.

PART II. of the Transactions of the Institution of Engineers and Shipbuilders in Scotland contains a paper by Prof. A. L. Mellanby and W. Kerr on pressure-flow experiments on steam nozzles. This paper is the second of a series on the same subject, the preceding paper having been presented to the British Association in August last. The measurements of pressure were carried out by means of a search-tube, which, when moved along the jet, gave

the pressure at any chosen position. The search-tube has already given excellent results in the hands of Prof. Stodola, but the method of analysis adopted in the present series is believed to be new. The results are exhibited in the form of curves, and the following are some of the author's deductions:—The purely convergent form of nozzle operates very much in accordance with theoretical ideas; it has a smooth expansion line in agreement with its well-rounded form, and a maximum range approximately in line with the theoretical critical drop. The convergent-parallel type scarcely acts in keeping with preconceived ideas; this form of nozzle should be considered one of extended convergence only. In both the above types theory demands a maximum range limited to a pressure ratio of 0.55; the actual ranges have only rough agreement with this figure. The convergent-divergent type has one over-all range in which the fall of pressure is continuous, but the throat pressure seems always to be below the theoretical. Sharp-entranced nozzles were also experimented with.

WITH reference to the letter published in NATURE of February 3 discussing coloured thinking and thought-forms, Mr. G. Stridsberg, of Stockholm, wishes to direct attention to a communication by Prof. H. Mygind, of Copenhagen, which appeared in the Danish review *Tilskueren* for 1884 (pp. 361-78) entitled "Om Erinring og Fantasi aforistiske Betragtninger" ("Aphorisms on Memory and Imagination").

A LENGTHY catalogue (No. 197) of scientific books and publications of learned societies, consisting of upwards of 2000 items, has reached us from Messrs. W. Heffer and Sons, Ltd., Cambridge. As will be seen by the following table of contents, it contains titles of works in most of the sciences. It should therefore appeal to many readers of NATURE, who can obtain the catalogue upon request. The list is classified as follows:—Mathematics, Physics, Astronomy, and Early Philosophy; Engineering; Agriculture, Husbandry, and Farriery; Anthropology and Ethnology; Botany; Chemistry, Chemical Technology, and Metallurgy; Geology, Mineralogy, and Palæontology; Zoology and Biology; Physiology, Anatomy, and Medicine; Portraits of Men of Science; Psychology and Psycho-Analysis; and Addenda.

A CATALOGUE (No. 410) of antiquarian and bibliographic interest has just been issued by Mr. F. Edwards, 83 High Street, Marylebone, W.1. It gives particulars of some 300 books, maps, plans, and engravings relating to London and its vicinity, and will be sent free upon application.

THE Smithsonian Institution issues a classified list of its publications available for distribution to scientific workers either gratis or at the prices indicated. Publications of the United States National Museum and of the Bureau of American Ethnology are not included. The list before us, which is Publication 2585, is brought down to August 21, 1920.

Our Astronomical Column.

LARGE METEORS ON MARCH 1 AND 2.—Mr. W. F. Denning, of Bristol, writes:—"On the evening of Tuesday, March 1, two large meteors were observed, and on the following night three others were recorded. The most brilliant of them all appeared on March 2, at 10 p.m. It was seen at Bristol, at Dunton Green, Kent, at Holt, Norfolk, and at other places. It was a very fine object, and gave a flash which lit up the sky. Its radiant point was a few degrees east of δ Leonis, and the path of the meteor was over the English Channel approximately from Dieppe, France, towards the Isle of Wight, but reaching only about half that distance. Observations are still coming to hand, and the real path will be calculated from them. It has been several times pointed out that the first few nights of March are specially distinguished by apparitions of bright meteors, although no periodic shower is known to occur on those dates. There appear, however, to be several fairly active displays in progress, and from the evidence obtained this year we may be enabled to determine their radiant points accurately."

PONS-WINNECKE'S COMET.—This comet has not yet been detected—which is a matter for surprise. In 1915 it was photographed five months before perihelion, and it should now be within the reach of moderate instruments, especially as it is very favourably placed in the morning sky. The following elements are likely to be near the truth:— ω 174°, Ω 96°, i 19.5°, q 1.01, $\log a$ 0.509, e 0.687. The most uncertain element is the date of perihelion. The following ephemerides for Greenwich midnight are based on the assumed dates:—1921 June 13.5 and June 21.5. The uncertainty is considerably greater than eight

days, so the search should extend beyond the limits of the ephemerides; these, however, should define the line on which it lies with tolerable precision:

T=1921 June 13.5.						
		R.A.	N. Decl.	log r	log Δ	
	h.	m.	s.			
March	7	14 47	44	25 58	0.2126	9.9291
	15	15 1	16	28 42	0.1932	9.8785
	23	15 15	48	31 39	0.1729	9.8269
	31	15 30	23	34 51	0.1519	9.7731

T=1921 June 21.5.						
		R.A.	N. Decl.	log r	log Δ	
	h.	m.	s.			
March	7	14 13	18	29 31	0.2317	9.9453
	15	14 21	12	32 35	0.2126	9.8984
	23	14 27	8	35 58	0.1932	9.8522
	31	14 32	23	39 26	0.1729	9.8064

The search should be carried on assiduously up to March 20, after which the moon will interfere.

TWO NEBULÆ WITH UNPARALLELED VELOCITIES.—Prof. V. M. Slipher announces that the spiral nebulæ N.G.C. 584 (R.A. 1h. 27.3m., declination $-7^{\circ} 16'$) and N.G.C. 936 (R.A. 2h. 23m., declination $-1^{\circ} 33'$) have extremely high recessional velocities, which are 1800 and 1300 km./sec. respectively. There is a decided preponderance of recessional motion indicated for the spiral nebulæ.

Prof. Eddington ("Report on the Relativity Theory of Gravitation," p. 89) suggested that these high velocities may not be real, but a result of the curvature of space in Einstein's system, according to which very distant objects would have their spectral lines shifted towards the red.

The Chicago Meeting of the American Association.

THE annual meeting of the American Association for the Advancement of Science and of the scientific societies associated with it, which was held in Chicago from December 27, 1920, to January 1, was the seventy-third meeting of the Association. The attendance was very large, more than 2400 persons being registered, and the programmes were correspondingly full and of broad scope. Fourteen Sections of the Association met on this occasion, together with forty-one national scientific societies. The official general programme required 112 pages. The meeting was very successful in every way, reflecting the marked renewal of scientific activity that has followed the war. The American Central West was, naturally, most strongly represented at this meeting. Thirteen hundred and eighty-three members were registered, of whom 856 were from Illinois, 98 from Indiana, 121 from Ohio, 125 from Michigan, 181 from Wisconsin, 72 from Minnesota, 90 from Iowa, and 70 from Missouri. On the other hand, the attendance was of wide geographic distribution; there were 27 registrants from California, 5 from Washington, 7 from Arizona, 22 from Colorado, 50 from Massachusetts, 81 from the District of Columbia, 4 from Florida, 48 from Canada, 10 from the Philippine Islands, and 20 from China.

The address of the retiring president, Dr. Simon Flexner, director of the laboratories of the Rockefeller Institute for Medical Research, on "Twenty-five Years of Bacteriology" (*Science*, December 31, 1920) gave to the 713 persons who attended the opening session a clear and inspiring presentation of this very important subject from one who has been a leader in the progress of bacteriological science. Dr. L. O. Howard, Chief of the Bureau of Entomology of the United States Department of Agriculture, presided at the meeting as president-elect. The Association has benefited immeasurably by Dr. Howard's enthusiasm and skill as permanent secretary during the last twenty-two years. The roll of the Association is now about nine times as great as it was when he became the chief executive officer.

The various sessions were held mainly in the buildings of the University of Chicago, which are admirably suited for such gatherings. The local arrangements for the meeting, to which its marked success was due in the main, were in charge of the local committee for the Chicago meeting. The *personnel* of this committee was as follows:—J. Paul Goode, general chairman; Gilbert A. Bliss, publicity; Henry C. Cowles, membership; Henry G. Gale, meeting-places; Frank R. Lillie, finance; and William D. MacMillan, hotel accommodations.

The printing of the general programme—a very difficult task on account of the very limited time available after the manuscript was in hand—was accomplished with a very high degree of efficiency by the University of Chicago Press. The final editing and proof-reading was in charge of Dr. Goode, who, together with the other members of the local committee, served the Association at great self-sacrifice during the trying days just preceding and during the meeting.

Besides the opening session, there were two other sessions of general interest. At one of these Dr. Robert F. Griggs gave a beautifully illustrated lecture on the region of Mount Katmai, Alaska, and "the Valley of Ten Thousand Smokes." At the other of these sessions Prof. Robert W. Wood gave a lecture on "High-power Fluorescence and Phosphorescence," with ingenious and spectacular experimental demonstrations. The attendance at these two sessions was

519 and 710 respectively. Admission to the opening session and to these "general interest" sessions was by ticket, a set of tickets being given to each registrant. By this new feature it became possible to determine the attendance and to show its distribution among members, guests, students in the University, etc.

A visible directory of those registering, kept currently corrected by several typists and attendants, proved to be a generally appreciated feature of the Chicago meeting. Panels bearing the directory slips were hung along a wall of the registration-room, so that the directory was readily consulted by everyone.

Prof. E. H. Moore, of the University of Chicago, was elected president of the Association for 1921. He will preside at the Toronto meeting next December, and will give his address as retiring president at the Boston meeting a year later. Prof. Moore is the acknowledged leader of American mathematicians, and the Association is particularly fortunate in having for its president a man of such wide interests and great accomplishments, and one representing the branch of science that is fundamental to all others as is mathematics.

Dr. D. T. McDougal, director of the department of botanical research of the Carnegie Institution of Washington, was elected general secretary of the Association in succession to Prof. E. L. Nichols, of Cornell University. Dr. MacDougal has already been active in the organisation of the Association's work, especially in the Pacific and South-Western Divisions, and his election as general secretary is especially fortunate. This officer is constitutionally entrusted with the various aspects of general organisation, particularly with reference to the affiliation of scientific societies. The Association aims to become an affiliation of all the larger and more influential societies of America, and with the progress of this kind of affiliation the Association becomes the only organisation through which the influence of all these societies may be united for the advancement of science as a whole.

Another step that will increase the efficiency of the work of the Association was the authorisation of the appointment of an assistant secretary, to assist the permanent secretary in the scientific work of his office, as he has thus far been assisted in the clerical management of his office by the efficient executive assistant, Mr. Sam Woodley. Dr. Sam F. Trelease, of the Johns Hopkins University, who is conveniently located to devote part time to this work, has been appointed secretary. He has recently returned to the United States after several years of excellent service in the school of agriculture of the University of the Philippines at Los Baños, P.I.

One of the main concrete projects before the permanent secretary's office for the ensuing months is the publication of the summarised proceedings for the years 1916–21, together with the revised membership list of the Association. It is hoped to publish this volume in the early spring, and it is to be sold by subscription, payment being made in advance of publication. The price is 1.50 dollars to members and 2 dollars to others, and orders should be addressed to the permanent secretary's office in the Smithsonian Institution, Washington, D.C.

The Toronto meeting of the Association will be held from Tuesday, December 27, to Saturday, December 31 next. The opening session, at which Dr. Howard will deliver an address as retiring president, will be on the evening of Tuesday, December 27. The annual meeting for 1922–23 will be held in Boston, and that for 1923–24 in Cincinnati. The

next quadrennial convocation meeting will occur in Washington, D.C., for 1924-25.

Dr. Burton E. Livingston, director of the laboratory of plant physiology of the Johns Hopkins University, who has been permanent secretary of the Association since last February, was re-elected permanent secretary for a period of four years. Dr. R. S. Woodward was re-elected treasurer of the Association, also for a four-year period.

The following vice-presidents and secretaries were elected for the respective Sections of the Association:

President: Eliakim H. Moore, University of Chicago, Chicago, Ill. (one year). *Retiring President:* L. O. Howard, Bureau of Entomology, United States Department of Agriculture, Washington, D.C. *Permanent Secretary:* Burton E. Livingston, Johns Hopkins University, Baltimore, Md. (four years). *General Secretary:* D. T. MacDougal, Desert Laboratory, Tucson, Ariz. (four years). *Treasurer:* R. S. Woodward, Washington, D.C. (four years).

Chairmen and Secretaries of Sections (Chairmen to hold Office for One Year, Secretaries for Four Years).

Section A, Mathematics:—*Chairman:* Oswald Veblen, Princeton University, Princeton, N.J. *Secretary:* William H. Roever, Washington University, St. Louis, Mo.

Section B, Physics:—*Chairman:* G. W. Stewart, State University of Iowa, Iowa City, Iowa. *Secretary:* S. R. Williams, Oberlin College, Oberlin, Ohio.

Section C, Chemistry:—*Chairman:* W. D. Harkins, University of Chicago, Chicago, Ill. *Secretary:* Gerald L. Wendt, University of Chicago, Chicago, Ill.

Section D, Astronomy:—*Chairman:* S. A. Mitchell, University of Virginia, Charlottesville, Va. *Secretary:* F. R. Moulton, University of Chicago, Chicago, Ill.

Section E, Geology and Geography:—*Chairman:* Willet G. Miller, Bureau of Mines, Toronto, Canada. *Secretary:* Elwood S. Moore, Pennsylvania State College, State College, Pa.

Section F, Zoology:—*Chairman:* C. A. Kofoid, University of California, Berkeley, California. *Secretary:* H. W. Rand, Harvard University, Cambridge, Mass.

Section G, Botany:—*Chairman:* Mel. T. Cook, New Jersey Agricultural Experiment Station, New Brunswick, N.J. *Secretary:* Robert B. Wylie, Iowa State University, Iowa City, Iowa.

Section H, Anthropology:—*Chairman:* A. E. Jenks, University of Minnesota, Minneapolis, Minn. *Secretary:* E. A. Hooton, Peabody Museum, Cambridge, Mass.

Section I, Psychology:—*Chairman:* E. A. Bott, University of Toronto, Toronto, Canada. *Secretary:* Frank N. Freeman, University of Chicago, Chicago, Ill.

Section K, Social and Economic Sciences:—*Chairman:* No election. *Secretary:* Seymour C. Loomis, 82 Church Street, New Haven, Conn.

Section O, Agriculture:—*Chairman:* Jacob G. Lipman, New Jersey Agricultural Experiment Station, New Brunswick, N.J. *Secretary:* Percy E. Brown, Iowa State College, Ames, Iowa.

Section Q, Education:—*Chairman:* Guy M. Whipple, University of Michigan, Ann Arbor, Mich. *Secretary:* Bird T. Baldwin, Iowa Child Welfare Research Station, State University of Iowa, Iowa City, Iowa.

There were no elections in Sections L, M, N, and P.

The eight elected members of the council of the Association for 1921 are as follows, their terms of

office to expire at the end of the annual meeting (denoted in parentheses):—N. L. Britton (1921-22), New York Botanical Garden; J. McK. Cattell (1921-22), Garrison, N.Y.; Henry C. Cowles (1921-22), University of Chicago; J. C. Merriam (1921-22), Carnegie Institution of Washington; G. A. Miller (1922-23), University of Illinois; W. E. Ritter (1922-23), Scripps Institution, La Jolla, California; A. E. Douglass (1923-24), University of Arizona; and Henry B. Ward (1923-24), University of Illinois.

The Council also includes the president, the permanent and the general secretary, the vice-presidents for the Sections, the secretaries of the Sections, and the representatives of the affiliated societies.

The executive committee of the council for 1921 consists of the following members, their terms of office to expire at the end of the annual meeting (denoted in parentheses):—J. McK. Cattell (1922-23), H. L. Fairchild (1923-24), Simon Flexner (1921-22), L. O. Howard (1924-25), W. J. Humphreys (1921-22), Burton E. Livingston (1924-25), D. T. MacDougal (1924-25), E. H. Moore (1921-22), Arthur A. Noyes (1923-24), Herbert Osborn (1924-25), and Henry B. Ward (1922-23).

The collection of portraits and autograph letters of all the presidents of the American Association made by Dr. Marcus Benjamin, of the Smithsonian Institution, has been purchased by the Association under conditions representing a partial gift from Dr. Benjamin.

The sum of 5000 dollars was appropriated for the Committee on Grants for Research, to be distributed during 1921.

A resolution was adopted by the council as follows:—

“Be it Resolved: That the American Association for the Advancement of Science would welcome the organization of Mexican men of science and their affiliation with this Association. *Resolved:* That a committee of seven be appointed to co-operate with such organization as Mexican men of science may form.”

The following were appointed on this committee:—L. O. Howard (chairman), A. E. Douglass, E. L. Hewitt, D. S. Hill, W. J. Humphreys, D. T. MacDougal, and W. Lindgren.

The following three resolutions were also adopted by the council:—

“Whereas the American Association for the Advancement of Science includes Sections on Physiology, Experimental Medicine, and Zoology, and whereas advancement of knowledge in these sciences, which is dependent upon intensive study of living tissue, is inevitably followed not only by amelioration of human suffering, but also by a lessening of animal disease and by substantial economic gain and by conservation of the food-supply; and whereas this Association is convinced that the rights of animals are adequately safeguarded by existing laws, by the general character of the institutions which authorise animal experimentation and by the general character of the individuals engaged therein,

“Therefore be it resolved that this Association agrees fully with the fundamental aim of those whose efforts are devoted to the safeguarding of the rights of animals, but deprecates unwise attempts to limit or prevent the conduct of animal experimentation such as have recently been defeated in California and Oregon, for the reason that such efforts retard advance in methods of prevention, control, and treatment of disease and injury of both man and animals, and threaten serious economic loss; and be it further

“Resolved that a copy of these resolutions be included in the official records of this Association, and that copies be sent to the National Congress, to the

Legislatures of each State in the Union, and to each member of the Association."

"Whereas the clean culture of roadsides and the drainage of marshes in the United States is imperiling the existence of the wild life of our country not now included in special preserves; and whereas the preservation of this wild life not in preserves is felt to be of great national importance, not only to students and lovers of Nature, but to human welfare in general, therefore

"Be it resolved by the council of the American Association for the Advancement of Science that it appreciates the importance of preserving this wild life not in preserves, and that it lends its moral support to the effort to combine all interested organisations in a co-operative investigations and conservation programme for the preservation of our unprotected wild life."

"Whereas, in recognition of the unique character and value of our national parks and monuments to present and future generations, twenty-four succes-

sive Congresses have wisely resisted attempts to commercialise them and have preserved them inviolate for nearly half a century; and whereas certain private interests are now seeking to secure special privileges in these areas, which if granted will seriously interfere with their true purpose and undoubtedly result in the entire commercialisation of these unique national museums,

"Therefore be it resolved that the American Association for the Advancement of Science requests members of Congress, first, to amend the Water Power Act so that it shall not apply to national parks and monuments, and that their full control be restored to Congress; and, secondly, to reject all present and future measures which propose to surrender any part of these national parks and monuments to private control or to divert them in any way from their original and exclusive purpose, the preservation for all future generations of unique representations of natural conditions such as exist in no other part of the world."

Indian Agriculture.

AGRICULTURE in India is of special importance in that it is the chief industry of that great country, in comparison with which all others are relatively unimportant. Of its two chief aspects crop production is more to the front than animal husbandry; and, now that the world-shortage of food is so acute, more and more attention is being directed to the improvement of the crops in both quality and quantity. The present position of affairs is concisely summed up by Mr. A. Howard (Journ. Roy. Soc. Arts, vol. lxxviii., July, 1920).

India is essentially a land of small cultivators, intensely conservative, usually poor, and unable to afford to take risks in the adoption of new methods. Progress is consequently very slow, and is chiefly being made by the improvement of varieties and by gradual changes in methods of cultivation. Since 1905 better varieties of wheat, rice, jute, tobacco, and cotton have been introduced, adding in many cases nearly 11. per acre to the profits of the cultivators. Little attention was formerly paid to the seed sown, and the resulting product was very mixed and lacked uniformity. By gradual selection of the better types from the original mixtures and by organisation of the seed distribution the value of the crops has gradually been much increased. Though high yield is of the greatest importance, many of the best yielding varieties are slow in maturing, rendering them unsafe to use on account of the short growing season. The best results are obtained with adaptable varieties, which do well over a wide range of conditions, and combine fair yield and quality with rapid growth and early maturity. The distribution of the improved seed supply presented many difficulties, but these have been overcome by enlisting the help of every kind of local agency and systematically replacing the old mixed varieties in village after village.

Crop yield in India is often depressed by the deficiency in soil aeration brought about by injudicious irrigation by flooding. When the land is constantly flooded it becomes temporarily waterlogged, and the oxygen content is so much lowered that plants cannot grow satisfactorily. Experiments indicate that a less number of floodings would give better results. Tests made at Coimbatore (R. C. Wood and K. R. Acharya, "Year Book," Madras Agricultural Department, 1919) show that in many cases a more economical and beneficial use of the available water can be made by means of a system of furrow irrigation, though flood-

ing is apparently more necessary for such crops as wheat, which need heavier watering. In this connection adequate drainage is of great importance, as during the rains surface-waterlogging is very common, resulting not only in deficient aeration, but also in a lowering of the fertility of the soil by denitrification. A month's waterlogging may reduce the yield of wheat by as much as sixteen bushels to the acre. Surface drainage by means of trenches about 2 ft. deep has proved effective, and the water so collected may be utilised by running it on to low-lying rice-fields. With improved drainage it is possible to grow the more deeply rooted crops which fail owing to the rotting of their roots when water is held up in the soil.

The temperature of the soil is another factor bearing a close relation to the crop. If the soil is too warm at the usual time for sowing wheat the seedlings do not thrive, and are liable to attack by white ants; the damage has been proved to be due to the partial destruction of the root-system of the seedlings by the high soil temperature. Suggested remedies are the postponement of sowing for a week and the opening of furrows to cool the soil by evaporation.

The advances outlined above are now being followed up by the gradual introduction of modern methods of manuring, and experiments with artificial fertilisers suggest possibilities for the future. W. A. Davis (Indigo Publication No. 6, Pusa) has obtained remarkable results by the use of superphosphate on cereal crops, emphasising the fact that if the soil is poor in organic matter this deficiency must be made good before the superphosphate can act efficiently. Green manuring with sannai (*Crotalaria juncea*) often meets this difficulty satisfactorily. Similar increases have been obtained with indigo crops, and the response to manurial treatment is considered to make the future position of natural indigo very hopeful, the one essential being that cheap supplies of phosphatic manures shall be available to planters in the near future.

In Mysore the millet "ragi" (*Eleusine coracana*) is of pre-eminent importance, as it covers one-third of the total cultivated area, and is the staple food of four-fifths of the people. L. C. Coleman (Dept. Agric. Mysore, Bull. 11) sets forth the results of much experimental work on the improvement of this crop as regards methods of cultivation, manuring, and seed selection, together with much useful information with

regard to the habit of growth of the plant and the diseases to which it is liable. Although no tests seem to have been made, it is suggested that on the typical "ragi" soils basic slag and bonemeal would probably be more advantageous than superphosphate.

The most casual survey of the available literature shows clearly that the possibilities of agriculture in India are being recognised as never before. Indian soils have hitherto been starved, and much of the cultivated land has almost reached the maximum state of impoverishment (D. Clouston, *Agric. Journ. India*,

vol. xv.), and, consequently, it is likely to respond well to manurial treatment. Fungal diseases and insect pests take heavy toll of the crops, and demand much investigation before they can be controlled. Nevertheless, the need for improvement is fully recognised, and steady but slow progress in this direction is being made by the patient and determined efforts of the many workers who have the interests of the country at heart, and the advance already made is of good augury for the future.

W. E. BRECHLEY.

Precious Stones in 1919.

THE long and valuable series of annual reports on precious stones commenced by Dr. George F. Kunz, of New York, in 1883 in the publications of the United States Geological Survey, and continued by him since 1907 in the *Mineral Industry*, bears witness to his enthusiasm for a subject in which he is the leading authority. His latest report, for 1919, has just been issued as an advance chapter (30 pages) of vol. xxviii. of the *Mineral Industry*. From it the following points are extracted:

During the war period the demand for articles of luxury naturally fell, but now a marked reaction has set in, and sales in Paris and elsewhere already exceed those of the pre-war period. Not only are a greater number of articles sold, but they also command higher prices. This is especially the case in the United States, where the annual value of the imports of precious stones is now (105,000,000 dollars in 1919) more than double ever before. As with everything else, the war has had far-reaching effects on the trade in precious stones. Difficulties have arisen owing to the varying rates of monetary exchange, labour questions, and the shifting of the centres of industry. Efforts are being made to discover fresh sources of supply. As in previous times of great disturbance, speculators and refugees acted wisely who converted perishable goods and almost worthless paper-money into portable and durable jewels.

Diamond is by far the most important item. To the South African output, which is controlled by the London Diamond Syndicate, the new territory of South-West Africa contributes 21 per cent. The total production of the Union in 1919 of rather more than 2,500,000 carats (about half a ton) amounts to only half that for the year 1913, but the value (nearly 12,000,000*l.* sterling) is actually greater, so great has been the advance in price. The sales, however, somewhat exceeded the production for the year, the reserve stock having been drawn upon. "River stones," being of better quality, command higher prices; the average in 1919 was just above 13*l.* per carat, as against 4*l.* in 1915. These stones are now being collected from the bed of the Vaal River with the aid of diving-bell caissons and compressed air. A notable diamond is one of 1500 carats (=300 grams) found in the Premier Mine, near Pretoria, in 1919;

it is, perhaps, a portion of the same large crystal as the famous "Cullinan" diamond found in 1905. New diamond fields are recorded in Kenya Colony, Gold Coast, Bechuanaland, Griqualand West, and Orange Free State. The Belgian Congo yielded in 1919 about a quarter of a million carats, whilst the returns from other countries (except a small quantity from British Guiana) are practically negligible.

As a diamond-cutting centre Amsterdam still takes the lead, but the industry is now being developed in England, particularly at Brighton for the employment of disabled soldiers. More cutting is also being done in America, as shown by the increased imports of uncut stones, and the establishment of cutting works in South Africa is under consideration. For these reasons the Dutch are considering the possibility of increasing the output from Borneo by systematic mining. The Arkansas diamond field is also to be explored more systematically. Besides its use as a gem, diamond has many important technical applications, but it is a significant fact that the American imports do not show an increase in this direction, the enormous increase noted above being accounted for by the imports of cut, but unset, gems.

Pearls form the next largest item in the American imports. Here again attempts are being made to increase the production of the pearl fisheries on the western coasts of Central America, whilst the freshwater pearls of the rivers of the United States are likely to be collected on a large scale.

Corundum gems show a steady, though comparatively small, output from Upper Burma (ruby and sapphire) and from Fergus County, in Montana (sapphire). Opal deposits are now being successfully developed in South Australia, and a new deposit of "black opal" has been discovered in New South Wales. Fine examples of "fire-opal" are mentioned from Western Australia. A fine mass of precious opal weighing 527 grams has been found in the new opal-mining district in Nevada. Mention is made of the beautiful, bright blue zircons which have recently appeared in the gem market, but no information is given as to their source. This has been variously suggested to be Ceylon, India, Siam, or Queensland; it is evidently kept a secret for trade purposes.

L. J. S.

Copper Deposits of Arizona.

A VERY complete and highly interesting monograph on the copper deposits of Ray and Miami, Arizona, by Mr. F. L. Ransome has just been issued by the United States Geological Survey as Professional Paper 115. These ore-bodies have rapidly attained first-class importance among the great copper producers of the United States. For a good many years, dating back to 1880, work had

been carried on in this district, the small richer veins being worked and a fair amount of copper won, but these deposits were not of a permanent character. About 1905 the attention of mining men was directed to the low-grade disseminated ore of the region, and work on this commenced about 1911. Up to 1918 nearly 46,000,000 tons of this ore had been mined and 490,000 tons of copper produced. The reserves

in one group of these mines, that of the Ray Consolidated Copper Co., were estimated in 1916 as more than 93,000,000 tons, averaging 2.03 per cent. of copper; those in the Miami mines at 50,000,000 tons, averaging 1.6 per cent.; and those in the Inspiration mine at 97,000,000 tons, carrying 1.63 per cent. The ore-bodies are large, irregular, flat-lying masses, and consist partly of Pinal schist and partly of granite and monzonite porphyry, carrying disseminated copper ore, some being more or less uniformly distributed through the rock and some concentrated in threads or veinlets. The copper occurs principally as chalcocite, though chalcopyrite is also met with. The ore-deposits have apparently been formed by a process of secondary enrichment upon rock that contained relatively little copper. The latter is termed by the author "protore," and apparently contained from 0.4 to 0.8 per cent. of copper. This "protore" appears to have been formed by the action of thermal alkaline sulphide waters carrying copper in solution, and there is considerable evidence that the presence of great bodies of monzonite porphyry lying far deeper than the present ore-bodies were in some way connected with the presence of these hypogene solutions.

University and Educational Intelligence.

CAMBRIDGE.—H.R.H. the Prince of Wales will visit the University to receive an honorary degree on May 31 next.

Mr. A. D. Browne has been elected to a fellowship at Queens' College. Mr. W. M. Smart, Trinity College, chief assistant at the observatory, has been appointed to the John Couch Adams astronomy, recently founded under a bequest by the late Mrs. Adams.

Smith's prizes have been awarded to L. A. Pars, Jesus College, for an essay on "The General Theory of Relativity," and to W. M. H. Greaves, St. John's College, for an essay on "Periodic Orbits in the Problem of Three Bodies."

A course of thirty lectures on applied entomology is to begin in the Easter term and Long Vacation by Mr. F. Balfour Browne for those students who wish to complete their training for such work in the tropics or in this country.

DR. WALTER E. COLLINGE, of St. Andrews University, has been appointed keeper of the York Museum.

THE annual gathering of the South-Western Polytechnic Institute, Chelsea, will be held to-morrow, March 11. The chair will be taken at 8.15 p.m. by Mr. C. H. St. J. Hornby (chairman of the governing body), and a lecture will be given by Prof. A. Harden on "Vitamins—Essential Constituents of Food."

THE National Union of Scientific Workers announces a public meeting to be held on Tuesday, March 15, at 6 p.m., in the Geology Theatre, Royal School of Mines, South Kensington, when Mr. W. Brierley will speak on "Personal Impressions of American Biological Research." The chair will be taken by Sir A. D. Hall.

IN view of the large demand for tickets for the lecture on "Himalayan Exploration, with Special Reference to Mount Everest," recently delivered by Profs. J. N. Collie and E. J. Garwood at University College, London, the lecture will be repeated on Monday, March 21, at 5.15 p.m., at the college. The

proceeds of the lecture will be devoted to the College Athletic Ground Fund, for which a sum of 6000*l.* is needed.

At a recent meeting of the Bristol University Colston Society Committee it was decided to alter the title of the society to Colston University Research Society. Originally founded as the University College Colston Society in 1899, its funds were applied in the first instance to the General Sustentation Fund of the college, and afterwards to a considerable extent to propaganda work in connection with the proposed Bristol University. On the establishment of the University the society automatically became the University Colston Society. At the same time the decision was made to apply the funds of the society henceforth to the support of research work within the University. The new name, Colston University Research Society, emphasises the fact that the society exists to support research work within the University, and should make it clear that the funds are devoted entirely to facilitate and extend this work, the value of which to the industrial and commercial world and to the community at large cannot be over-estimated. The annual dinner of the society is fixed for May 23, being the day preceding Founder's Day, and this day has been adopted now as a permanent date. The president is Alderman F. Sheppard, and Sir William Bragg, Quain professor of physics in the University of London, has accepted the invitation to be present as the guest of the society. The president-elect is Mr. E. Walls.

A VERY interesting and comprehensive course of six lectures on Italian engineering is now being given under the auspices of the University of London by Prof. Luiggi, of the University of Rome, at the Institution of Civil Engineers. In his first lecture, presided over by the Italian Ambassador, Prof. Luiggi outlined the subjects he proposed to consider, and pointed out that an impelling motive of nearly all modern engineering work in Italy was the necessity of increasing the food production of the country by irrigation and by the reclamation of marshy lands in order to provide for a present population of about 40,000,000, which is increasing at the rate of 500,000 a year. Another vital problem is to develop their great water-power resources owing to the scarcity of fuels and the impossibility of paying for imported coal and other fuels at present-day prices. In southern Italy, where water is scanty, it has been necessary to construct the Apulian aqueduct, nearly 1000 miles long, and by far the largest work of its kind in the world. In his second lecture some important irrigation canals will be described and the various schemes of reclaiming marshy land by drainage canals, by silting up with muddy flood-water, and by pumping. The main topic of the third lecture will be the great hydro-electric installations, some of which have units of 20,000 h.p. working under exceptionally high heads, as in the "Adamello," where an available fall of 3000 ft. has been successfully utilised for several years, although this working head will be surpassed in other plants now under construction. Applications of electrical power to railways will also be described, as will an extremely interesting power station at Larderello in Central Tuscany, in which steam for three turbines, each of 4000 h.p., is derived from volcanic heat tapped by pipes driven to depths of from 500 ft. to 600 ft. The University of London is particularly fortunate in having so distinguished an authority and so able a lecturer as the president of the Institution of Civil Engineers in Rome to give this course of lectures to its students and the engineering world.

Calendar of Scientific Pioneers.

March 10, 1810. Henry Cavendish died.—Of noble birth and a natural philosopher in the widest sense of the term, Cavendish spent practically all his life in the pursuit of science, carrying out most of his work in his secluded home at Clapham. His experiments on air led to the discovery of the constant quantitative composition of the atmosphere, of the composition of water, and of nitric acid, and paved the way to the discovery of argon. He measured the density of the earth, and left a mass of valuable material relating to electricity which was published by Maxwell. Biot referred to him as "le plus riche de tous les savants, et probablement aussi le plus savant de tous les riches." He is buried in All Saints' Church, Derby.

March 10, 1882. Sir Charles Wyville Thomson died.—Especially remembered as a student of the biological conditions of the depths of the sea, Thomson took part in the dredging expeditions in the *Lightning* and *Porcupine* (1868-69), and was scientific head of the *Challenger* Expedition. From 1870 until his death he was professor of natural history in Edinburgh University.

March 10, 1900. George James Symons died.—An indefatigable worker in meteorology, Symons published thirty-nine annual volumes of statistics of British rainfall observations, and was the founder of *Symons's Meteorological Magazine*.

March 13, 1845. John Frederic Daniell died.—Professor of chemistry at King's College, London, Daniell was the inventor of a hygrometer, a pyrometer, and the electric cell which bears his name. He wrote valuable works on meteorology and chemical philosophy.

March 14, 1874. Johann Heinrich Mädler died.—For many years director of the Dorpat Observatory, Mädler with Beer constructed a fine map of the moon. He wrote a history of astronomy, and in 1841 pointed out the probability of the existence of a planet exterior to Uranus.

March 15, 1897. James Joseph Sylvester died.—Holding chairs successively at University College, London, Virginia, Woolwich, Johns Hopkins University, and Oxford, Sylvester exerted a powerful influence on the study of mathematics both in England and in America. It has been said that in brilliancy of conception, in acuteness of penetration, and in fluency and richness of expression he has had few equals among mathematicians.

March 15, 1910. Hans Heinrich Landolt died.—The friend and contemporary of Lothar Meyer, Beilstein, and Kekulé, Landolt held professorships at Bonn, Aachen, and Berlin, and in 1891 succeeded Rammelsburg as director of the Berlin Chemical Institute. He carried out many investigations in physical chemistry dealing mainly with the chemical composition of substances and their optical properties.

March 16, 1838. Nathaniel Bowditch died.—At first assistant to a ship-chandler, Bowditch became a supercargo, then a captain, and later actuary to an important American insurance company. Known as a mathematician, he spent nearly twenty years in translating and annotating the "Mécanique Céleste" of Laplace. For several years he was president of the American Academy of Arts and Sciences.

March 16, 1841. Félix Savart died.—Trained as a doctor, Savart made investigations in molecular physics, and was chosen successor to Ampère in the chair of experimental physics in the Collège de France.

E. C. S.

Societies and Academies.

LONDON.

Royal Society, February 24.—Prof. C. S. Sherrington, president, in the chair.—Sir E. Ray Lankester: A remarkable flint implement from Selsey Bill. The implement, together with two hammer-stones, was found resting with other large broken flints on a bed of clay underlying "the Coombe rock gravel," and exposed by tidal action on the shore of Selsey Bill, by E. Heron-Allen in 1911. It is of large size, of rostrate form, with a convex dorsal and flat ventral surface, and has been shaped by powerful blows, resulting in coarse flaking of undoubted human workmanship. It belongs to a very early Palæolithic horizon, probably pre-Chellean. The only flint implements of similar weight and size known are two also of very early (viz. Upper Pliocene) age. It is suggested that the race of men who made and used such an implement had larger hands and more powerful limbs than the more modern races.—Dr. E. J. Allen: Regeneration and reproduction of the Syllid *Procerastea*. *Procerastea halleziana* was found living in membranous tubes on the stems of the hydroid *Syncoryne*. The worm was observed to feed by piercing the body-wall of the hydranths with its extruded pharynx and pumping out the contents of the gastral cavity of the hydroid. Sexual reproduction occurs, each individual forming a single large stolon which is set free as a male *Polybostrichus* or a female *Saccocereis*. *Procerastea* were also found undergoing rapid multiplication by a process of fragmentation, followed by the regeneration of anterior and posterior ends. Fragmentation can be induced by artificial means, and takes place in a definite way. The rate of regeneration of the different sections varied according to the region of the body from which they came, being most rapid in those from the middle region. Regeneration of anterior segments appears to continue until the original segments come to occupy exactly the same position in the regenerated worm as they had occupied in the parent.—E. C. Grey and E. G. Young: The enzymes of *B. coli communis*. Part ii.: (a) Anaerobic growth followed by anaerobic and aerobic fermentation. (b) The effects of aeration during the fermentation. (a) Anaerobic fermentation of glucose by an emulsion of *B. coli communis* proceeds differently according as the organisms have been grown previously with or without oxygen. When the immediate past history has been anaerobic, the fermentation under anaerobic conditions yields acetic acid in large proportion. Admission of oxygen during the fermentation leads to lactic acid production. (b) The effect of introducing oxygen in the fermentation of glucose by *B. coli communis* is to increase the lactic, acetic, and succinic acids, and to diminish the hydrogen, carbon dioxide, and formic acid, but to leave the alcohol unchanged. Under anaerobic conditions greater variations occur in the proportion of alcohol to acetic acid than under aerobic conditions. One effect of the introduction of oxygen during fermentation is to inhibit the mechanism of auto-reduction, which is responsible for the variations in alcohol when such occur. The products of aerobic fermentation contain less oxygen than the corresponding products of anaerobic fermentation of glucose; but there is a gain of oxygen in both cases upon the original glucose. If this extra oxygen comes from the water, one effect of the introduction of oxygen is to diminish the part played by water in the reactions.—Dr. A. E. Everest and A. J. Hall: Anthocyanins and anthocyanidins, part iv. The paper deals with the constitution of the blue anthocyan pigments in flowers and with the manner in which anthocyan pigments are

formed in Nature. The conclusions of Shibata and of Shibata and Kasiwagi concerning the constitution of the blue anthocyan pigments in flowers are compared with those of Willstätter and Everest. Important differences exist between the complex salts formed by the anthocyan pigments with the salts of such metals as iron and the blue pigments present in flowers. The blue plant pigments investigated are probably comparable to the alkali phenolates of the flavonols. In plant synthesis the flavonols are probably first formed, and from them the anthocyanins.

Zoological Society, February 22.—Sir S. F. Harmer, vice-president, in the chair.—A. Mallock: Colour-production in relation to the coloured feathers of birds.—E. D. Jones: Descriptions of new moths from South-East Brazil.—Dr. J. Stephenson: The morphology, classification, and zoogeography of the Indian Oligochaeta.—Dr. R. Broom: The structure of the reptilian tarsus.

EDINBURGH.

Royal Society, February 7.—Prof. F. O. Bower, president, in the chair.—T. B. Franklin: The relation of the soil colloids to the conductivity of the soil. Soil conductivity can be measured qualitatively by the value R_t/R_0 , where R_t and R_0 are the temperature ranges at the 4-in. depth and at the surface. The effects of weather changes—rain, snow, frost, surface mulch, evaporation, water content, and period—on R_t/R_0 have been discussed in a previous paper, and if these changes are all eliminated a constant value for the ratio should be obtained in any soil. Experiments with sand and clay loam showed that this constant value was obtained in sand, but not in clay loam; in the latter soil it varies with changes of the mean soil temperature. Thus when all other weather changes had been eliminated, but the mean soil temperature varied between 10°C . and 22°C ., R_t/R_0 for sand lay between 0.50 and 0.52, while for clay loam it lay between 0.37 and 0.45. Moreover, ignited clay loam behaved exactly like sand, showing that the cause of the variation was destroyed by ignition; it is suggested that the colloidal clay is the cause of this temperature coefficient of conductivity in clay soil.—J. M. Wordie: (1) The Shackleton Antarctic Expedition of 1914-17: Bathymetrical observations in the Weddell Sea. (2) The natural history of pack-ice as observed in the Weddell Sea, 1914 to April, 1916. The oceanographical results of the Shackleton Antarctic Expedition of 1914-17 are given. The pack-ice was studied from the time that it formed and imprisoned the *Endurance* in January, 1915, until it finally melted in April, 1916, 900 miles farther north. Prominence is given to the fact that the pack is continually in motion, to the pressure phenomena which are the result, and to the changes, particularly as regards salinity, which take place as the floes become older. The movement of the ice was governed by the wind, which drove the pack westwards round the Antarctic continent and outwards to lower latitudes. Between the Arctic and the Antarctic pack-ice there was apparently no difference except that of age; Antarctic floes were seldom more than two years old, but otherwise they resembled the ice of the polar basin, and even the so-called "palæocrystic ice." The various types of ice and pressure and the present-day terminology were illustrated by numerous photographs. The long series of soundings made in the Weddell Sea supplement those made by Dr. Bruce in the *Scotia*. A new and unexpected feature was the discovery in the south-west of a shallow area with depths about 200 fathoms over a distance of nearly 300 miles. The abnormal depth of the continental shelf at this place and elsewhere in the Antarctic was regarded as the result of earth-movement. The soundings and drift

of the ice practically settled the vexed question of Morrell's Land, the existence of which is now considered highly improbable. A description is given of the deep-sea deposits of the Weddell Sea; they form the only data for deducing the geological structure of the ice-covered Coats Land.

PARIS.

Academy of Sciences, February 14.—M. Georges Lemoine in the chair.—H. Le Chatelier: Saline double decompositions and their graphical representation. A description of a method of plotting a system of a pair of salts, taken in molecular proportions, and the pair resulting from their mutual decomposition in a square. The system

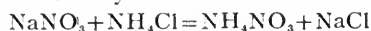

is given as an illustration, the recent data of M. Rengade being used.—L. Lecornu: The varied movement of fluids.—M. Louis Joubin was elected a member of the section of anatomy and zoology in succession to the late M. Yves Delage.—G. Giraud: Automorph functions.—T. Varopoulos: Some points in the theory of numbers.—A. Egnell: The determination of congruences of right lines the mean plane of which is given.—H. Villat: The cyclic movements of a fluid limited by a wall and containing a solid.—P. Ravigneaux: Graphical method for the study of epicyclic trains.—B. Gambier: Articulate systems, deformable or transformable.—E. Ehmichen: A series of flights with a free helicopter carried out on January 15, 28, and 29, 1921. About one-fifth of the total dead-weight was carried by a small hydrogen balloon, and the apparatus was lifted from 0.5 to 3 metres from the ground and maintained in equilibrium. Landing was easy.—C. Frémont: The fragility of some welded steel joints. As ordinarily carried out, electrically welded steel is weaker at the joint than in the body of the metal, and this is due to the inclusion of oxide. If sufficient pressure is applied during welding to squeeze out some molten metal this source of weakness is removed, but there is still a weak blue zone some distance away from the weld.—J. Guillaume: Observations of the sun made at the Lyons Observatory during the fourth quarter of 1920. Observations were possible on sixty-five days during the quarter, and the results are grouped in three tables, showing the number of spots, their distribution in latitude, and the distribution of the faculae in latitude.—MM. P. Bernard and Barbe: An apparatus for lighting and extinguishing public gas-lamps. A description of an apparatus controlled by a slow increase of pressure (about 3 in. of water) from the gasworks. The cycle of three operations, lighting, extinguishing, and resetting, is worked by three slow-pressure waves.—MM. P. Jolibois, R. Bossuet, and Chevry: Fractional precipitation.—R. Audubert: The mechanism of the energy exchanges in evaporation. Evaporation is a discontinuous phenomenon. The elementary quantum has a value near 10×10^{-16} T. ergs; it represents the work required to evaporate a molecule, and can be expressed as a variation of the superficial energy.—M. Barlot: The displacement of metals in saline solutions. An experimental study of the replacement of one metal by another in their homogeneous layers. Four examples of the effects produced are illustrated.—C. Matignon: Reactions producing magnesium.—Mlle. Jeanne Lévy: Some retropinacolic transpositions. A discussion of the causes of the transposition represented by

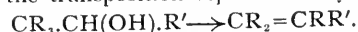

—Mlle. A. Roux and J. Martinet: The catalytic rôle of mercury in the sulphonation of anthraquinone.—MM. M. Tiffeneau and Orékhoff: The pinacolic nature

of some transpositions in the phenyldimethylglycol series.—L. Gaucher and G. Rollin: A new calcium salt.—D. Florentin and H. Vandenberghe: A criticism of the methods of estimating small quantities of carbon monoxide in air- and flue-gases. A comparison of the iodine pentoxide and blood methods, the latter being preferred.—A. Romieux: The evolution of terrestrial dynamism.—E. Le Danois: Fishing maps. An account of maps prepared for the Office scientifique des pêches.—A. Paillot: The mechanism of humoral immunity in insects.—F. Pickard and T. Pagliano: The biology of *Haltica ampelophaga*.—L. Besson: The influence of temperature on the number of deaths through infantile diarrhoea in Paris.

Books Received.

Germination in its Electrical Aspect: A Consecutive Account of the Electro-Physiological Processes Concerned in Evolution. By A. E. Baines. Pp. xxi+185. (London: G. Routledge and Sons, Ltd.; New York: E. P. Dutton and Co.) 12s. 6d. net.

The Physiology of Protein Metabolism. By Prof. E. P. Cathcart. (Monographs on Biochemistry.) New edition. Pp. viii+176. (London: Longmans, Green and Co.) 12s. 6d. net.

Six Papers by Lord Lister. With a short Biography and Explanatory Notes by Sir Rickman J. Godlee. (Medical Classics Series.) Pp. vii+184+iv plates. (London: J. Bale, Sons and Danielsson, Ltd.) 10s. net.

The Practical Electrician's Pocket Book for 1921. Edited by H. T. Crewe. Pp. lxxii+522. (London: S. Rentell and Co., Ltd.) 3s. net.

Le Mouvement Biologique en Europe. By Georges Bohn. Pp. 144. (Paris: A. Colin.) 4 francs.

Annals of the South African Museum. Vol. xviii., part 1. Pp. 180+2 plates. (Cape Town; London: Adlard and Son and West Newman, Ltd.) 20s.

Morphologie und Biologie der Strahlenpilze (Actinomycceten). By Prof. R. Lieske. Pp. ix+292+4 Tafel. (Leipzig: Gebrüder Borntraeger.) 108 marks.

Chemistry. By G. H. J. Adlam. (Science for All Series.) Pp. x+238. (London: J. Murray.) 3s. 6d. net.

Notes on a Cellar-Book. By G. Saintsbury. New edition. Pp. xxxi+228. (London: Macmillan and Co., Ltd.) 7s. 6d. net.

Wireless Telegraphy: With Special Reference to the Quenched-Spark System. By B. Leggett. (The D.-U. Technical Series.) Pp. xv+485. (London: Chapman and Hall, Ltd.) 30s. net.

The Principles of Politics: An Introduction to the Study of the Evolution of Political Ideas. By Prof. A. R. Lord. Pp. 308. (Oxford: Clarendon Press.) 8s. 6d. net.

An Elementary Text-Book of Zoology for Indian Students. By Prof. B. L. Bhatia. Adapted from "An Elementary Course of Practical Zoology," by Prof. T. J. Parker and Prof. W. N. Parker. Pp. xii+721. (London: Macmillan and Co., Ltd.) 21s. net.

Report of the Proceedings of the Third Entomological Meeting held at Pusa on the 3rd to 15th February, 1919. Edited by T. Bainbridge Fletcher. Vol. i. Pp. xii+417+69 plates. Vol. ii. Pp. vi+418-835+70-129 plates. Vol. iii. Pp. vi+836-1137+130-182 plates. (Calcutta: Government Printing Office.) 17.8 rupees for 3 vols.

Pre-Kensington History of the Royal College of Science and the University Problem. An Address delivered before the Old Students' Association of the Royal College of Science, London, September, 1920,

by Prof. H. E. Armstrong. Pp. 23. (London: Lamley and Co.) 2s. 6d.

The Lands of Silence: A History of Arctic and Antarctic Exploration. By Sir Clements R. Markham. Pp. xii+539. (Cambridge: At the University Press.) 45s. net.

Kincardineshire. By the late G. H. Kinnear. Pp. xi+122. (Cambridge: At the University Press.) 4s. 6d. net.

The Mechanical Production of Cold. By Sir J. A. Ewing. Second edition. Pp. x+204. (Cambridge: At the University Press.) 25s. net.

The Resources of the Sea. By Dr. W. C. McIntosh. Second edition. Pp. xvi+352. (Cambridge: At the University Press.) 35s. net.

Diary of Societies.

THURSDAY, MARCH 10.

INSTITUTE OF METALS (Annual General Meeting) (at Institution of Mechanical Engineers), at 10.30.—H. Moore, S. Beckinsale, and Clarice E. Mallinson: The Season Cracking of Brass and Other Copper Alloys.—Dr. J. L. Haughton: The Constitution of the Alloys of Copper with Tin, Parts III. and IV.

ROYAL INSTITUTION OF GREAT BRITAIN, at 3.—Dr. G. C. Simpson: The Meteorology of the Antarctic.

ROYAL SOCIETY, at 4.30.—Sir Joseph Larmor: Electro-crystalline Properties as Conditioned by Atomic Lattices.—Lord Rayleigh: The Colour of the Light from the Night Sky.—Prof. A. S. Eddington: A Generalisation of Weyl's Theory of the Electromagnetic and Gravitational Fields.—Prof. T. R. Merton: Spectrophotometry in the Visible and Ultra-violet Spectrum.—Prof. W. A. Bone: Researches upon Brown Coals and Lignites.—Prof. H. N. Russell: A Superior Limit to the Age of the Earth's Crust.—H. Ohshima: Reversal of Asymmetry in the Plutei of *Echinus miliaris*. With a Note by Prof. E. W. MacBride.

LONDON MATHEMATICAL SOCIETY (at Royal Astronomical Society), at 5.—J. Brill: Note on the Electrodynamic Equations.—T. W. Chaundy: A Method for the Solution of Certain Linear Partial Differential Equations.—C. W. Gilham: An Extension of Two Theorems on Jacobians.—G. H. Hardy and J. E. Littlewood: (1) The Approximate Functional Equation in the Theory of Riemann's Zeta-function. (2) Summation of a Certain Multiple Series.—S. Pollard: A New Condition for Cauchy's Theorem.—E. G. C. Poole: Certain Classes of Matthieu Functions.

ROYAL COLLEGE OF PHYSICIANS OF LONDON, at 5.—Dr. A. Whitfield: Some Points in the Etiology of Skin Diseases (Lumleian Lectures).

ROYAL SOCIETY OF MEDICINE (Balneology and Climatology Section), at 5.30.—Discussion: The Place of Baths and Health Resorts in Gynaecology.

INSTITUTION OF ELECTRICAL ENGINEERS (at Institution of Civil Engineers), at 6.—Prof. E. Wilson: Feebly Magnetic Materials: Practical Applications.

OPTICAL SOCIETY (at Imperial College of Science), at 7.30.—Prof. H. F. Newall: The Story of a New Star (Lecture).—T. F. Connolly: Note on a Handy Form of Measuring Microscope.

ROYAL SOCIETY OF MEDICINE (Neurology and Ophthalmology Sections, Joint Meeting), at 8.—Dr. G. Holmes, L. Paton, and Others: Ocular Palsies.

SOCIETY OF ANTIQUARIES, at 8.30.

FRIDAY, MARCH 11.

ASSOCIATION OF ECONOMIC BIOLOGISTS (in Botanical Lecture Theatre, the Imperial College of Science), at 2.30.—Exhibits and Short Communications.—Dr. J. Davidson: The Cells of Plant Tissues in Relation to Cell-sap as the Food of Aphids.—E. R. Speyer: Ceylon Scolytid Beetles: their Bionomics and Relation to Ambrosia Fungi and Problems of Plant Physiology.

ROYAL ASTRONOMICAL SOCIETY, at 5.—W. H. Wright: Occurrence of Enhanced Lines of Nitrogen in Spectra of Novae. Second Note.—W. J. Luyten: Visual and Photographic Light-curve of V18=RS Cephei.—Adml. Sir A. M. Field: The Solar Eclipse Expedition, 1922.—A. S. Williams: A New Variable Star in Perseus.—J. Halm: The Relations between the Masses, Mean Densities, and Luminosities of the Stars.—J. Halm: The Relation between the Velocities of the Stars and their Masses.—Rev. H. E. Macklin: The Clusters β and χ Persei.—Rev. J. Rowland: Note on the Magnitude Curves in Mr. Macklin's Paper.—R. T. Cullen: Note on the Travelling Wire Micrometer of the Greenwich Transit-circle.

PHYSICAL SOCIETY OF LONDON (at Imperial College of Science), at 5.—Prof. A. A. Michelson: Some Recent Applications of Interference Methods (Sixth Guthrie Lecture).

ROYAL SOCIETY OF MEDICINE (Clinical Section), at 5.30.

INSTITUTION OF ELECTRICAL ENGINEERS (Students' Meeting) (at King's College), at 6.30.—J. A. Broughall: Some Recent Developments in Converting Machinery for Small Substations.

ROYAL SOCIETY OF MEDICINE (Neurology and Ophthalmology Sections, Joint Meeting), at 8.30.—Dr. G. Holmes, L. Paton, and Others: Ocular Palsies.

ROYAL INSTITUTION OF GREAT BRITAIN, at 9.—Dr. J. Freeman: Medical Idiosyncrasies.

SATURDAY, MARCH 12.

ROYAL INSTITUTION OF GREAT BRITAIN, at 3.—Sir Ernest Rutherford: Electricity and Matter.
 PHYSIOLOGICAL SOCIETY (at Institute of Physiology, University College), at 4.

MONDAY, MARCH 14.

BIOCHEMICAL SOCIETY (Annual General Meeting) (at Lister Institute).
 ROYAL GEOGRAPHICAL SOCIETY (at Lowther Lodge), at 5.—Col. Sir Charles Close, G. T. McCaw, and A. R. Hinks: Notes on New Map Projections.
 ROYAL SOCIETY OF MEDICINE (War Section), at 5.30.—Col. H. E. R. James: The Best Form of Instruction for Medical Students to Fit Them to take Their Part in Case of National Emergency.
 ROYAL SOCIETY OF MEDICINE, at 5.30.—Sir John McFadyean and Others: Discussion: The Eradication of Tuberculosis in Men and Animals.
 INSTITUTION OF ELECTRICAL ENGINEERS (Informal Meeting) (at Chartered Institute of Patent Agents), at 7.—R. L. Morrison and Others: Discussion on Rectifiers.
 INSTITUTE OF MECHANICAL ENGINEERS (Graduates' Meeting), at 7.—A. J. Watson: Commercial Motor-Vehicles.
 SURVEYORS' INSTITUTION (Junior Meeting), at 7.—J. G. Elsworthy: Conversion of Buildings to Meet Modern Requirements.
 ROYAL INSTITUTE OF BRITISH ARCHITECTS, at 8.—H. P. Adams: Cottage Hospitals.
 ROYAL SOCIETY OF ARTS, at 8.—Major G. W. C. Kaye: X-rays and their Industrial Applications.
 MEDICAL SOCIETY OF LONDON (at 11 Chandos Street, W.1), at 8.30.—Sir Henry Gauvain and Others: Non-operative Treatment of Surgical Tuberculosis.

TUESDAY, MARCH 15.

ROYAL INSTITUTION OF GREAT BRITAIN, at 3.—Prof. A. Keith: Darwin's Theory of Man's Origin, in the Light of Present-Day Evidence.
 ROYAL SOCIETY OF MEDICINE (Therapeutics and Pharmacology Section), at 4.30.—P. B. Roth: The Uses of Heliotherapy.
 ROYAL SOCIETY OF MEDICINE (General Meeting), at 5.
 ROYAL COLLEGE OF PHYSICIANS OF LONDON, at 5.—Dr. A. Whitfield: Some Points in the Etiology of Skin Diseases (Lumleian Lectures).
 ROYAL STATISTICAL SOCIETY (at Surveyors' Institution), at 5.15.—Sir James Wilson: The World's Wheat.
 INSTITUTION OF PETROLEUM TECHNOLOGISTS (at Royal Society of Arts), at 5.30.—J. Kewley: The Crude Oils of Borneo.
 NATIONAL UNION OF SCIENTIFIC WORKERS (in the Geology Theatre, Royal School of Mines), at 6.—W. Brierley: Personal Impressions of American Biological Research.
 ROYAL PHOTOGRAPHIC SOCIETY OF GREAT BRITAIN, at 7.—A. S. Newman: The Design and Construction of the Reflex Camera.—Major A. Abrahams: The Use of the Reflex Camera.
 ROYAL ANTHROPOLOGICAL INSTITUTE (Special Meeting), at 8.15.—E. Torday: Culture and Environment: Cultural Differences among the Various Branches of the Batetela.

WEDNESDAY, MARCH 16.

INSTITUTION OF NAVAL ARCHITECTS (at Royal United Service Institution), at 11.—Duke of Northumberland: Presidential Address.—Sir Eustace D'Eyncourt: Some Features of German Warship Construction.—S. V. Goodall: Ex-German Battleship *Baden*.—W. R. G. Whiting: The Strength of Submarine Vessels.
 ROYAL METEOROLOGICAL SOCIETY (at Royal Astronomical Society), at 5.—Dr. G. C. Simpson: The South-West Monsoon (Lecture).
 INSTITUTION OF MECHANICAL ENGINEERS (Wireless Section) (at Institution of Mechanical Engineers), at 6.—G. Stead: The Effect of Electron Emission on the Temperature of the Filament and Anode of a Thermionic Valve.—Miss W. A. Leyshon and Prof. W. H. Eccles: Some Thermionic Tube Circuits for Relaying and Measuring.
 ROYAL SOCIETY OF ARTS, at 8.—C. A. Mitchell: Science and the Investigation of Crime.
 ROYAL MICROSCOPICAL SOCIETY, at 8.

THURSDAY, MARCH 17.

INSTITUTION OF NAVAL ARCHITECTS (at Royal United Service Institution), at 11.—R. J. Walker and S. S. Cook: Mechanical Gears of Double Reduction for Merchant Ships.—E. W. Blockside: Life-saving Appliances on Cargo and Passenger Vessels.—M. E. Denny: The Design of Balanced Rudders of the Spade Type.
 INSTITUTION OF NAVAL ARCHITECTS (at Royal United Service Institution), at 3.—H. B. W. Evans: Standardisation of Data for Airship Calculations.
 ROYAL INSTITUTION OF GREAT BRITAIN, at 3.—Dr. G. C. Simpson: The Meteorology of the Antarctic.
 CHEMICAL SOCIETY (Annual General Meeting), at 4.
 ROYAL SOCIETY, at 4.30.—*Probable Papers*.—Lord Rayleigh: The Colour of the Light from the Night Sky.—R. O. Street: The Dissipation of Energy in Permanent Ocean Currents, with Some Relations between Salinities, Temperatures, and Currents.—S. Datta: The Vacuum Arc Spectra of Sodium and Potassium.—W. E. Garner and C. L. Abernethy: Heats of Combustion and Formation of Nitro-compounds. Part I. Benzene, Toluene, Phenol, and Methylamine Series.—E. K. Rideal: The Catalytic Dehydrogenation of Alcohols.
 ROYAL COLLEGE OF PHYSICIANS OF LONDON, at 5.—Dr. A. Whitfield: Some Points in the Etiology of Skin Diseases (Lumleian Lectures).
 LINNEAN SOCIETY, at 5.—W. B. Alexander: The Vertebrate Fauna of Houtman's Abrolhos Islands, West Australia.—Prof. P. Fauvel: Annélides Polychètes de l'Archipel Houtman Abrolhos.—F. Chapman: *Sherbornina*: A New Genus of Foraminifera from Table Cape, Tasmania.
 ROYAL AERONAUTICAL SOCIETY (at Royal Society of Arts), at 5.30.—Capt. D. Nicolson: Flying-Boat Construction.

INSTITUTION OF MINING AND METALLURGY (at Geological Society), at 5.30.—E. H. Clifford: Scheme for Working the City Deep Mine at a Depth of 7000 feet (adjourned discussion).—A. E. Pettit: Notes and Records of Mining Costs.
 INSTITUTION OF ELECTRICAL ENGINEERS (at Institution of Civil Engineers), at 6.—Sir William Noble: The Long-distance Telephone System of the United Kingdom.
 INSTITUTION OF AUTOMOBILE ENGINEERS (London Graduates' Meeting) (at 29 Victoria Street), at 7.30.—H. B. Benny and D. J. Macklin: Modern Tendencies in Automobile Engine Design.
 ILLUMINATING ENGINEERING SOCIETY (at Royal Society of Arts), at 8.—Major A. Garrard and Others: Motor-Car Headlights: Ideal Requirements and Practical Solutions.
 INSTITUTION OF NAVAL ARCHITECTS (at Royal United Service Institution), at 8.—Prof. T. B. Abell: A Study of the Framing of Ships.
 RÖNTGEN SOCIETY (in Architecture Theatre, University College), at 8.15.—E. A. Owen and Phyllis K. Bowes: X-ray Dosage, with Special Reference to the Barium Platinocyanide Paste.
 HARVEIAN SOCIETY (at Town Hall, Paddington Green), at 8.30.—Dr. L. Williams: The Thyroid Gland in Everyday Life.

FRIDAY, MARCH 18.

INSTITUTION OF NAVAL ARCHITECTS (at Royal United Service Institution), at 11.—K. G. Winlay: The Spacing of Transverse Bulkheads.—A. M. Robb: Deflections of Bulkheads and of Ships.—J. J. King-Salter: Some Experiments on Tallows in their Use for the Launching of Ships.
 MONTESSORI SOCIETY (at University College), at 5.45.—F. Watts: Common Sense about Intelligence Testing.
 INSTITUTION OF MECHANICAL ENGINEERS, at 6.—Prof. E. G. Coker, K. C. Chakko, and M. S. Ahmed: Contact Pressures and Stresses.
 ROYAL SOCIETY OF MEDICINE (Electro-Therapeutics Section), at 8.30.—Prof. W. D. Halliburton: Physiological Advance: The Importance of the Infinitely Little (The Mackenzie-Davidson Memorial Lecture).
 ROYAL INSTITUTION OF GREAT BRITAIN, at 9.—Sir Frederick Bridge: The Researches of a Musical Antiquarian.

SATURDAY, MARCH 19.

ROYAL INSTITUTION OF GREAT BRITAIN, at 3.—Sir Ernest Rutherford: Electricity and Matter.

CONTENTS.

	PAGE
Oceanographic Problems. By J. J.	33
Problems of Life and Mind	45
Plant Biology. By F. K.	37
British Coal-fields. By H. L.	38
Practical Aeroplane Photography. By H. H. T.	39
Our Bookshelf	40
Letters to the Editor:—	
The Disintegration of Elements by α -Particles.—Sir E. Rutherford, F.R.S., and J. Chadwick	41
The Atomic Volume of Isotopes.—Prof. Frederick Soddy, F.R.S.	41
Relativity and the Velocity of Light.—C. O. Bartrum; J. H. Jeans, Sec. R.S.	42
Relativity and the Deviation of Spectral Lines.—Prof. H. J. Priestley	43
Amplifying the Optophone.—James Weir French	43
The Peltier Effect and Low-temperature Research.—Dr. Geoffrey Martin; A. A. Campbell Swinton, F.R.S.	43
The Sound of Distant Gun-fire.—Father V. Schaffers, S.J.	44
The Designation of Vitamines.—Prof. A. Liversidge, F.R.S.	45
Scientific Names for Commercial Timbers.—Richard T. Baker	45
"Elementary Practical Biochemistry."—Prof. W. A. Osborne	45
Colloids and Colloidal Electrolytes. (<i>Illustrated</i>). By Prof. J. W. McBain	46
Inland Waterways. (<i>Illustrated</i>). By Dr. Brysson Cunningham	48
Recent Work at Stonehenge	50
Obituary	50
Notes	51
Our Astronomical Column:—	
Large Meteors on March 1 and 2	55
Pons-Winnecke's Comet	55
Two Nebulæ with Unparalleled Velocities	55
The Chicago Meeting of the American Association	56
Indian Agriculture. By Dr. W. E. Brenchley	58
Precious Stones in 1919. By L. J. S.	59
Copper Deposits of Arizona	59
University and Educational Intelligence	60
Calendar of Scientific Pioneers	61
Societies and Academies	61
Books Received	63
Diary of Societies	63



THURSDAY, MARCH 17, 1921.

Editorial and Publishing Offices:

MACMILLAN & CO., LTD.,

ST. MARTIN'S STREET, LONDON, W.C.2.

Advertisements and business letters should be
addressed to the Publishers.

Editorial communications to the Editor.

Telegraphic Address: PHUSIS, LONDON.

Telephone Number: GERRARD 8830.

University Grants and Needs.

THE Report of the University Grants Committee (Cmd. 1163, 3d. net), dated February 3, confirms the opinion expressed in these columns on several occasions that greater financial assistance must be given to the Universities. It makes it clear that the present resources of the Universities are quite inadequate to meet the demands made upon them. Their expenditure has grown enormously, and even if the pre-war incomes had been doubled, it is doubtful whether they would be relatively as well off as they were before the war. Added to this there is an unprecedented influx of students; the number of full-time students in University institutions in Great Britain in receipt of annual grants in 1919-20 was 37,748 (including 11,682 ex-Service students), as compared with 23,872 in 1913-14. Here is ample evidence of the necessity for a much greater income. Unfortunately, there is not the same evidence that the necessity is being met. On the contrary, the Report clearly indicates that the Universities are unable to meet their existing responsibilities, still less to contemplate justifiable and desirable developments. Especially is this the case in respect of the emoluments of the teachers, which are still, we are told, "below the minimum necessitated by the present economic conditions." The Committee is of opinion that unless further substantial improvement is made in the salaries of the teaching staffs, the efficiency

of University education will be seriously endangered.

With this view anyone conversant with University life will cordially agree, as also with the statement that the emoluments should correspond to those now enjoyed by other professional classes, and show a reasonable ratio to the salaries paid in other branches of the teaching profession itself. So far, so good. But at this point the Report shows a lack of precision and logic, especially with reference to the scheme of remuneration put forward by the Association of University Teachers. In one place it seems to advocate basic minimum salaries, within grades and faculties, below which no teacher should be appointed; in another it doubts whether the principle of universal flat rates and automatic increments is either possible or desirable. It would be interesting to know how the Universities are to agree upon basic minimum salaries without accepting the principle of universal flat rates. There is one way, and that is to have different basic minimum salaries in different institutions—in other words, to grade the institutions; but it is questionable whether anyone, other than a doctrinaire, would seriously advocate a policy of this kind. In this connection it may be remarked that at a recent conference of representatives of the governing bodies of Universities with the council of the Association of University Teachers, a joint committee, comprising an equal number of representatives from both sides, was appointed to consider the whole question of remuneration of University teachers, and its report will be awaited with interest.

With regard to automatic increments, one wonders whether the Committee has heard of the Burnham scales of salaries or of the system of remuneration in operation in the Civil Service. The Report seems to indicate that promotion and its corollary—increase of remuneration—must come from the interchange of teachers between the various institutions. A little reflection will show the absurdity of such a suggestion. Of the important problem how to attract the best brain power to the staffs of the Universities in view of the financial inducements held out by the secondary schools, backed up by the Burnham scales of salaries, the Report has little to offer by way of a solution. One feels that the Committee would have been well advised to have left detailed criticisms on salaries to the University authorities. Committees are apt to become dogmatic.

In connection with the matter of superannua-

tion, the Report emphasises three principles from which few will dissent—the preservation of the autonomy of the Universities, the free interchange of teachers among educational institutions, and a wide choice of benefits for the beneficiaries; but it carefully omits to state, let alone to emphasise, another important principle, viz. that University teachers should have superannuation benefits at least equivalent to those given by the State to other teachers. Why the autonomy of the University should be emphasised in connection with the question of superannuation is a mystery to the plain man. No one suggests that an annual grant from the Treasury of 1,500,000*l.* is going to limit the autonomy of the Universities; but when University teachers ask that the School Teachers (Superannuation) Act should be extended to the Universities at an estimated additional cost of no more than 70,000*l.* or 80,000*l.* per annum, the bogey of loss of autonomy is immediately raised, and one wonders why. Again, it is one thing to enunciate principles; it is another to carry them into practice. It is all very well for the Committee to talk of the free interchange of teachers and to express a pious hope that it will materialise; but the fact is, there exists at the present moment a distinct barrier in the Superannuation Act to the free interchange of teachers, and there is no guarantee that this barrier will be removed. Further, while the sympathetic attitude of the Chancellor of the Exchequer to the senior members of the staffs who are precluded from profiting by the full benefits of the federated superannuation system is commendable, it is important to note that the capital sum necessary to meet these grievances would amount to something like one and a half millions. Unless we are greatly mistaken, Mr. Chamberlain has no intention of asking the Government for any such amount. The sum of half a million has been suggested, which means that only about a third of retrospective benefits will accrue to those in the federated system. Under the Teachers Act full benefits would accrue. Such distinctions as these do not conduce to harmony, and University teachers cannot be expected to remain content under them.

One or two other points may be noticed. The observations on the tenure and status of teachers, on equipment and accommodation, and particularly those on libraries and special national needs, are interesting and informative, but the suggestion that the three University colleges—Reading, Nottingham, and Southampton—should each look out

for a patron University under the ægis of which they might continue their present activities is not alluring. We dislike the principle of a patron University appointing representatives to approve courses and curricula and nominating external examiners. It smacks too much of educational bureaucracy. Why should not these three colleges together constitute a new University and work out their own destinies? In course of time, when the financial position became easier, no doubt they would hive off from one another as full-fledged Universities.

In a paragraph on finance the Report gives some important facts and figures. In his letter of July 16, 1920, Mr. Chamberlain states that, subject to the overriding necessities of national finance, he will submit to Parliament an increase in the vote from one million to one and a half millions in the estimate for 1921–22. While this will make an appreciable difference, it will not meet the needs of the present; other sources will have to be drawn upon. It would be unwise to expect much from a greater increase of fees—already the fees are two or three times greater than they are in America. Apparently little can be expected from private benefactions. There remains, therefore, the local authorities. The principle of a uniform *rd.* rate throughout the country for University education is sound, but the allocation of the various areas to their respective Universities would be difficult. All the same, looking to the future, the Government might reasonably ask the University Grants Committee to prepare a scheme of areas for the purpose of a possible rate of this kind. If such a scheme of rate aid were adopted, it would naturally form a new basis for estimating the Treasury contribution in the future.

Meteorological Physics.

Physics of the Air. By Prof. W. J. Humphreys. Pp. xi+665. (Philadelphia: J. B. Lippincott Co., 1920.) 5 dollars.

STUDENTS of the science of the atmosphere have read with interest and appreciation the articles by Prof. W. J. Humphreys, of the Weather Bureau of the United States, on various aspects of the physics of the atmosphere which appeared from time to time in the *Journal of the Franklin Institute of Philadelphia* during the years 1917–20. The reproduction of these articles, revised and collected into a book for publication by the institute, is a notable and welcome event in the history of the study of the air.

Prof. Humphreys is known to us all as an accomplished physicist who is not averse from mathematical reasoning, with a wide range of knowledge; a cautious and rigorous thinker, a competent critic, a clear writer, and a shrewd observer who is well acquainted with the inherent difficulty of associating the unconditioned or uncontrolled phenomena of the atmosphere with the carefully conditioned and completely controlled experiments of the physical laboratory. He is, perhaps, best known to us as having been the first to offer an explanation on a deductive basis of the separation of the atmosphere into troposphere and stratosphere, which appeared almost at the same time as Col. Gold's memoir in the Proceedings of the Royal Society, and as having constructed a very useful diagram of the chemical composition of the atmosphere at different heights, also arrived at deductively, which is reproduced in Prof. Willis Moore's "Descriptive Meteorology" and in the work now under review. It is none the less interesting because Dr. Chapman and Mr. Milne have suggested to the Royal Meteorological Society that the hydrogen which occupies so large a part of the diagram should be left out.

The results of the assiduous study of the phenomena of the atmosphere from the point of view which is characterised by the two examples just given cannot fail to be of interest and importance for meteorology and meteorologists. They range over an extraordinarily wide field. The mechanics and thermodynamics of the atmosphere, including the average meteorological conditions of the surface and the upper air, the physical aspects of their changes, the composition of the atmosphere, insolation and radiation, atmospheric circulation, evaporation and condensation, rain and raindrops, fogs, clouds, thunderstorms and lightning, form only the first part. It includes a very good chapter on winds adverse to aviation. The second part is devoted to atmospheric electricity and auroras, and the third to atmospheric optics, a very acceptable section in view of our lack of a summary of the subject in English books. The fourth deals with factors of climatic control, and comprises a penetrating discussion of the principal theories of glacial epochs, with a remarkably novel and effective discussion of the possible or probable effects of vulcanism.

The book is fully illustrated with many excellent diagrams and photographs excellently reproduced. The pictures of the succession of recorded volcanic eruptions are quite fascinating. Prof. Humphreys may be congratulated on having received from the Franklin Institute such effective assistance in that important side of the presenta-

tion of a subject which is largely dependent upon the success of its illustrations.

Apart from the general excellence of the book and the presentation of its material, the parts which impress one most on reading them for the first time are the chapters on thunderstorms and lightning, atmospheric electricity and auroras, and atmospheric optics, as examples of close physical reasoning, and the chapters on factors of climatic control as an example of reasoning of a more general character.

Where there is such a wealth of subject details can scarcely be regarded, but one or two points attract attention. There is nothing in the index under the letter "U," and the reader is left to draw his own conclusions about the units of the physics of the air, which, in the author's country as in ours, involve a question of real importance to progress in science. It must be remembered that the study of the atmosphere appeals not only to students in physical laboratories where intricate questions about units are all in the day's work, but also to persons outside who care little or nothing for the co-ordination of the various parts of the subject, and to whom any references in unfamiliar units are an unmitigated bore. Such questions should, therefore, be treated in a manner that leaves no room for uncertainty. On p. 30, in a discussion of temperature changes under variations of pressure, Prof. Humphreys tosses $g=981$ into a mixture of p 's and T 's with scarcely any warning to his readers, but on p. 33 he makes use of Db as the equivalent of pressure p where D is the density of mercury and b the barometric height in millimetres! The explanation of that cryptic equation affords quite a good exercise for the student of physics, but it is not the same as $g=981$. It is not quite fair to his readers to subject their intelligence to this kind of gymnastic, and when physical reasoning has to be addressed to unprofessional, as well as to professional, physicists there is really no alternative but to have a coherent and consistent system of units and to stick to it. The longer the step is postponed, the worse for us. One offence against the life-long habits of a reader may be condoned if it is sufficiently pressed, but no one can expect pardon for two such within three pages of the same book.

On p. 43 the author expresses his preference for "isothermal region" as against "stratosphere" as a name for that part of the atmosphere of which the characteristic feature is that there is no change of temperature with height. This is really astonishing, because to regard the "isothermal region" as really isothermal would be destructive of the whole plan of the structure

of the atmosphere disclosed by the observations.

The difference between the two regions is that in the lower region, the troposphere, the isothermal surfaces may be roughly described as horizontal, and in the stratosphere as vertical. The sudden transition from the horizontal sheet to the vertical sheet is the astounding feature which is exhibited at the tropopause all over the world; and as in the region of vertical isothermal surfaces the horizontal temperature gradient is from the equator towards the pole, and therefore opposite to that of the region where the isothermal surfaces are nearly horizontal, the opportunity of drawing effective attention to the paradoxical result of the equatorial region providing the coldest place on earth ought not to be missed. There is at least as much difference of temperature in the stratosphere between the equatorial region and the pole in one direction as there is at the surface in the opposite direction, at any rate in the summer, and if the upper region can be legitimately called isothermal, why not the surface layer?

It is remarkable that the chapters on the upper air draw their information from observations of the air of Europe. Our atmosphere has indeed been worn rather threadbare. We have drawn a number of conclusions from the European observations. They are largely confirmed by observations in Canada, and we are particularly anxious to know whether they are confirmed or contradicted by observations in the United States. So far as information has reached us, it would appear that the results for the United States show rather high temperatures and high pressures when brought into comparison with the observations of the rest of the world. That would indicate a sort of dislocation of the equatorial or tropical high pressure to the northward over the southern United States, at least in the summer. And as such a dislocation had already been indicated, years before the recent investigation of the upper air, by Teisserenc de Bort in his computed map of isobars at 4000 metres (which agrees in an extraordinary manner with the results of modern observations), we are naturally very curious to have compendious summaries of all the results for the United States, and to know whether the generalisations which we have made apply to them.

This brings to mind a certain shyness about tackling unsolved problems which other people have recognised as fundamental but have failed to solve. This shyness is a little bit characteristic of Prof. Humphreys's work, and is a rather disappointing feature of the book. One forms the

idea of a workman with a bag of nice, sharp physical and mathematical tools who undertakes with unerring success, any job that can be done with the available implements, and who prefers to pass by, with some irreproachable but vaguely general remarks, a number of old problems which Maury, Redfield, Espy, Loomis, Ferrel, and, later, Bigelow tried to solve. This is the more to be regretted because Prof. Humphreys's work is really original; it is not compilation. We get the impression that, while possessed of almost unexampled facility for dealing with it, he has preferred to pass by on the other side when anything controversial came within sight and there was a chance of a row. As an example, optics, which is an amenable subject, gets a whole part, while sound, which is also physics, but not amenable, receives only a casual reference, and in the chapter on the atmospheric circulation, on the question of what actually steers the wind, a good deal of space is given to discussion of the deflection due to the earth's rotation and change of velocity with latitude, which is true enough in the vague sense that it supposes the air to be free to find its path "under no forces," or without constraint. We should prefer to start with the fact that in actual practice wind is never free from the constraint of the distribution of pressure. Some meteorologists still require to realise that if it were not for a certain suitable constraint a train that started due north from New Orleans would presently find itself running into the Atlantic Ocean at a speed of a hundred or two hundred miles an hour. Nobody really expects it to behave in that way; the flange sees that it does not: no more does the wind; pressure takes care that it does not. Hence the introduction of unconstrained motion on the earth's surface requires an apologia that is seldom forthcoming.

We should like to pass on to Prof. Humphreys the remark of a London street arab who found us on one occasion hurrying to a cab to reach some function that insisted upon an academic robe which we were concealing so far as anything scarlet can be concealed: "Put it on, sir; don't be shy." We share the feeling and appreciate the dilemma, but we feel sure that if Prof. Humphreys were less afraid of saying something that his academic colleagues might criticise, he could render great service to the difficult science of meteorology, even if the critics were correct. Although ultimately the physics of the air is the same as that in the laboratory, the physical problems of the atmosphere require special intellectual tools for their solution, and the use of new tools requires courage. One can, of course, keep out of range of reproach for unorthodoxy or miscon-

ception when treating the questions that really move the meteorological world, but it is not so helpful as the bolder course. What we should like to know is almost as important to a subject as what we do know beyond dispute.

It is only when we reach part iv.—“Factors of Climatic Control”—that the author becomes really argumentative, and thereby most interesting, in suggesting and endeavouring to demonstrate that dust projected into the stratosphere by volcanoes is the efficient cause of prolonged changes of temperature that express themselves in climatic changes, after examining and rejecting all the other explanations which have been proposed. On reaching those chapters we feel once more in the fresh, free air, and the solicitude for the academic robe is disregarded. The oppression of the four walls of the laboratory vanishes. There is a sense of relief when the author boldly calculates the rates of fall of dust under Stokes's law without taking account of the counteracting influence of eddy motion which is so potent throughout the atmosphere in keeping solid and liquid particles in suspension. It would tax our space too much to consider why the stratosphere in particular should have to carry this additional burden, but the whole subject is full of interest, and now that he has taken off the academic gloves and faced so controversial a question as the cause of the Ice-age we look to Prof. Humphreys to let us have his views about various problems of the circulation of the atmosphere in general, and of cyclonic circulations in particular, to which in the past the meteorologists of the United States have made some notable contributions which might now be reviewed and perhaps revised. Meanwhile he deserves our hearty thanks for a very useful and handy book of reference indispensable for the meteorological library.

NAPIER SHAW.

New American Text-books of Botany.

- (1) *General Botany for Universities and Colleges.* By Prof. Hiram D. Densmore. Pp. xii + 459. (Boston and London: Ginn and Co., 1920.) 12s. 6d. net.
- (2) *Laboratory and Field Exercises for "General Botany."* By Prof. Hiram D. Densmore. Pp. viii + 199. (Boston and London: Ginn and Co., 1920.) 3s. 9d. net.

(1) **P**ROF. DENSMORE'S avowed intention is to “furnish both student and instructor with a helpful and connected statement of the more important facts and principles of modern botany.” It is but rarely that an elementary text-book meets

the requirements of teacher and student in equal degree; in striving after this ideal, Prof. Densmore has, one fears, fallen between two stools. For the student the statement is not sufficiently connected, and the teacher of university grade should not require help in regard to such elementary matter as fills the bulk of this book.

The discontinuous character of the text is aggravated by a noticeable lack of balance. Thus while the structure of stems, leaves, and roots is disposed of in thirty-three pages, an equal amount of space is devoted to an account of plant-breeding and evolution, which, moreover, deals principally with such modern developments as Mendelism and the mutation theory, touching but lightly on the more general aspects of evolution. The discussion of floral construction is inadequate, and the same remark applies to the chapter on fungi, which, in addition, is badly arranged, and gives no clue to the phylogeny of that group, the “simple classification” on p. 243 being in reality no classification at all. The author's didactic methods are often peculiar. Growth-movements are fully discussed before any account has been given of growth itself. The complex woody stem is described before the simpler herbaceous type. Part iii. (“Representative Families and Species of the Spring Flora”) would fit better into a book of Nature-study than it does into the present volume, where its usefulness is not apparent. It is only fair to note that some of the foregoing criticisms are repelled in advance in the author's preface, where he professes his adherence to a “biological, economic, and ecological point of view” in preference to a taxonomic or phylogenetic outlook.

Opinions differ widely as to the best form of elementary botanical course, but most teachers will agree that it is better to concentrate even unduly on one aspect of the science—say, phylogeny, physiology, or even taxonomy—than to adopt the kaleidoscopic method favoured by Prof. Densmore, whose hint as to the lack of interest shown by beginning students in most aspects of botany (the fortunate exception being “cellular biology”) is significant. It is claimed that the sections dealing with structure follow the teachings of the “newer anatomy”; in the absence of a precise definition, one is left in doubt as to how far this claim is justified, but the reviewer has searched in vain for any important anatomical facts or theories which have not figured in our elementary text-books for many years past. No mention whatever is made of palæobotanical evidence, which one would naturally expect to have an important bearing on the “newer anatomy.”

There are a number of obvious inaccuracies

which will doubtless disappear in a second edition. Thus the toadstool in Fig. 146 which purports to be *Amanita muscaria* is clearly a *Coprinus*; *Funaria* is said to be diœcious; Kerner von Mariläun appears as "Körner"; "*Nasturtium Tropaeolum*" is an unwelcome *combinatio nova*. Among good features of the book may be noted the section on the seasonal life of certain common plants, and the inclusion of *Chlamydomonas* as a type for detailed study. Without a first-hand knowledge of the requirements of American universities and colleges, it is difficult to say how this book will be received in its own country. There is not likely to be much demand for it on this side of the Atlantic.

(2) The book of practical exercises, though open to the same general criticisms as its companion volume, is more satisfactory on the whole. Some important subjects, such as sieve-tubes, the stoma, the ascus, and the angiospermic ovule, might have been dealt with in more detail.

M. D.

Theban Tombs.

(1) *The Tomb of Amenemhet*. (No. 82.) Copied in line and colour by Nina de Garis Davies, and with explanatory text by Dr. Alan H. Gardiner. (The Theban Tombs Series. First and Introductory Memoir.) Pp. vii+132+xlvi plates. (Published under the auspices of the Egypt Exploration Fund.) (London: George Allen and Unwin, Ltd., 1915.) 2 guineas net.

(2) *The Tomb of Antefoker, Vizier of Sesostris I., and of his Wife, Senet*. (No. 60.) By N. de Garis Davies. With a chapter by Dr. Alan H. Gardiner. (The Theban Tombs Series. Second Memoir.) Pp. iii+40+xlvi plates. (London: George Allen and Unwin, Ltd., 1920.) 2 guineas net.

THE importance of the series of painted tombs at Thebes for the history of civilisation is at last being adequately met by publication. A "Theban Tombs Series" has been started by Mr. Davies and Dr. Gardiner with the scrupulously accurate copies by Mrs. Davies. The style is adequate to every requirement, without the fastidiousness of luxurious book-making. The pictures of an age that overlaps the most brilliant civilisation of prehistoric Europe, about 1500-1200 B.C., are worthy of the fullest record that can be made.

(1) In this volume there is much to illustrate Egyptian thought and ideas. The conventions of the drawing arise from the need for a complete and absolute figure of each object, regardless of the

limitations of the view of it; if it were not complete, the magic value of the figure would be impaired or lost, and a merely relative view would not suffice. At first, in the pre-pyramid times, the paintings of objects were the exact size of the object. A discussion of the magic value of paintings ends in an open verdict; those entirely hidden in the burial chamber could only be magical; while biographies and other matter which was prominent to the public were memorial. The crippling of paintings by imperfect figures of noxious animals, or erasures of important parts, shows how much magic value was considered. The eldest-son priest was effaced, to hinder the value of offerings; the eyes of figures were picked out, that they might never see again; the drawing of the surveyor's measuring-rope was cut across, that he might never use it in a future state. The whole ritual of funeral scenes is discussed here, and also the meaning of the constant formula "an offering which the king gives." The likely meaning of this is omitted, however; the regular system of food-rents, or right of boarding for the king, which we find elsewhere, may well have existed in Egypt; a later appropriation of this for the service of the dead would constitute an offering legally by the king.

(2) This volume deals with almost the earliest painted tomb at Thebes. The scenes are the usual domestic, hunting, and funeral subjects known elsewhere, but many of the phrases of the workmen are very lifelike. The figures of fallow deer show how much the desert fauna has changed. It is to be hoped that the editors will publish a large part of the hundred tombs which need their care.

W. M. FLINDERS PETRIE.

Our Bookshelf.

Hittite Seals: With Particular Reference to the Ashmolean Collection. By D. G. Hogarth. Pp. xi+108+x plates. (Oxford: At the Clarendon Press, 1920.) 3l. 13s. 6d. net.

THE opening out of the history of man during the last thirty years has been quite as surprising as the growth of other branches of science. In place of trying to extract some further ideas from the ragged relics of literature, we have learned how to understand a civilisation without any intelligible documents, and to place the remains of it in order so as to show its abilities and to tell its course. The volume here noted deals with a branch of the Hittite work which has a wide historical interest, for the small seals are distinctive in their styles, and serve to show connections with work in other lands; they also were readily carried to other countries, and thus are links with neighbouring civilisations.

Mr. Hogarth has a close knowledge of the

region involved. He outlines the periods of Hittite history, and the various movements of peoples connected with it from 2000 to 600 B.C., in a masterly summary, which is very necessary for ethnological study. He then details the varied forms of the seals, and the subjects of the 335 specimens in the fine collotype plates. The classification by periods is the fruit of the work. It is notable that the button-badges of the Syrian invaders of Egypt (Sixth to Tenth Dynasties) and the labyrinth and frets of foreign origin (Sixth to Seventeenth Dynasties) seem to have been over and past before the rise of Hittite styles. The doubt (p. 23) as to the early use of the wheel in gem engraving is settled by work in Egypt so far back as the Eleventh Dynasty. The volume has the noble traditions of the Clarendon Press; but can students afford to support bibliophily as well as archæology in these times?

Zoomikrotechnik: Ein Wegweiser für Zoologen und Anatomen. By Prof. Paul Mayer. (Samm- lung naturwissenschaftlicher Praktika. Band ix.) Pp. vii + 516. (Berlin: Gebrüder Borntraeger, 1920.) 64 marks.

THE treatment of the subject of zoological technique in this book follows closely the lines of Lee and Mayer's well-known "Grundzüge der mikroskopischen Technik," the last (fourth) edition of which was issued in 1910; indeed, the present volume may be regarded as the new edition of that work.

In the first seventeen chapters directions are given for various methods of killing, fixing, hardening, staining, injecting, embedding, and sectioning organisms and tissues, for mounting whole specimens and sections, and for decalcification. The six remaining chapters deal with the technique of the cell, of eggs, embryos, and larvæ, and with histological methods for vertebrates and invertebrates. In a number of cases the account of a method is too short to be a real guide, and the reader is referred rather too often to "Lee and Mayer," or to some other book, for details which he might reasonably expect to find in this volume. For instance, in a book intended for anatomists, instructions should have been given for making up Kaiserling's solution, but instead there is a reference to "Lee and Mayer." A number of methods which would have been useful to zoologists have not received notice—*e.g.* methods for the culture of tissue and of Protozoa, the employment of iodine solution during the examination of intestinal amœbæ, and the examination and staining of spirochætes. But the omissions are relatively few, and the veteran professor is to be congratulated on the issue of this useful guide, to which he has added an excellent index.

Meteorological Office—Air Ministry: British Rainfall, 1919. Pp. xxviii + 268. (London: H.M.S.O., 1920.) 12s. 6d. net.

As a consequence of the absorption of the British Rainfall Organization by the Meteorologi-
NO. 2681, VOL. 107]

cal Office this volume is, for the first time, printed by the Stationery Office and issued as a Government publication. It contains a preface by Sir Napier Shaw and an introductory chapter by Mr. Carle Salter, both dealing with the change of responsibility. The work is divided into four parts. Part i. refers chiefly to organisation. Part ii. gives details as to evaporation and percolation in 1919, and as to the distribution of rainfall in time, embracing wet spells and droughts; also monthly and yearly rainfall tables at 348 stations in the British Isles, together with monthly rainfall maps and a second monthly map showing the percentage of average fall, and data of the seasonal rainfall of 1918-19.

Part iii. contains a general table of total rainfall in 1919 at 4893 stations in Great Britain and Ireland. Part iv. has an article on the effect of rainfall on the saturation-level in the chalk at Chilgrove, West Sussex, from 1836 to 1919, by Mr. D. Halton Thomson, also an article on the exposure of rain gauges by Mr. M. de Carle S. Salter, which should be read by all rainfall observers. There are many features not ordinarily recognised, especially the exposure during the winter months, when higher winds are experienced than during the summer months, the wind causing a factor detrimental to the correct measurement and calling for care in the position of the gauge so as to safeguard it against over-exposure and to avoid defects due to wind-eddies.

C. H.

British Plants: Their Biology and Ecology. By J. F. Bevis and H. J. Jeffrey. Second edition, revised and enlarged. Pp. xii + 346. (London: Methuen and Co., Ltd., 1920.) 7s. 6d.

THE revised and enlarged edition of "British Plants" provides a most useful handbook on general ecology, not only for the trained botanist, but also for the general reader who is interested in plant life. The outlines of the subjects are sketched in a suggestive manner with a minimum of technicalities, and sufficient general morphology is included to make the matters clear to the non-botanist. The first part of the book deals with environment and its influence on vegetation, the effects of climate, water, and soil receiving special attention. The second part gives general biological information, the section on the defensive equipment of plants gathering together a good deal of scattered knowledge. The last part treats of the evolution and present distribution of the British flora, and though one may join issue with the authors on certain points of detail, the broad outlines are clearly presented.

The book is fully illustrated, though some of the plant drawings would bear improvement—*e.g.* the underground rhizomes of couch-grass and mint, which lack distinctiveness and clearness. The authors are to be congratulated on bringing up to date a work which puts forward ecological matters in such a simple and attractive style.

W. E. B.

Letters to the Editor.

[The Editor does not hold himself responsible for opinions expressed by his correspondents. Neither can he undertake to return, or to correspond with the writers of, rejected manuscripts intended for this or any other part of NATURE. No notice is taken of anonymous communications.]

The International Research Council.

THE issue of the *Times* published on March 8 contains an article headed "The Progress of Science: Revolt against Super-Organisation." A few words of comment are necessary, though the task is disagreeable owing to the general tenor of the article, which in parts is frankly abusive and in others misleading. Its chief invective is directed against the International Research Council. This, according to the author, is to be "the supreme body in all the affairs of science," and he follows up this product of his imagination by enumerating in the same sentence the avowed objects of the International Research Council, placing a pure invention of his own in juxtaposition to the actual functions of the body concerned so as to leave the impression that both have equal authority.

The International Research Council was founded in the first instance through the action of the Royal Society and the Academies of Paris, Italy, Brussels, and Washington. Its object was to reorganise international work which had come to a standstill through the war, and to extend it where found desirable. The question as to the time at which former enemy countries should be admitted is a matter for argument, and it may be the policy of the *Times* to urge their immediate inclusion in the interests of the general peace of the world. Recent incidents at a meeting in Paris at which a German professor took part do not confirm this view, but the question has really nothing to do with the purpose which the article pretends to discuss. It should not be forgotten, however, that a friendly personal intercourse is an essential condition of the success of international conferences. This is recognised by the countries neutral during the war, which have nearly all accepted the invitation of the International Research Council to take part in this common enterprise.

The International Research Council has initiated the formation of unions for the conduct of scientific work. In the subjects of astronomy, geodesy and geophysics, and chemistry such unions are actually at work, and two others have been formed. Once an international union is established it becomes autonomous, and conducts its work without interference from the International Research Council except in a few matters in which a common policy is desirable.

Everyone knows that the decisions of an international conference are only advisory, and have no binding force on the separate countries. Representatives taking part in the conference report to the home authorities concerned, who act as they think fit, accepting, no doubt, in general such recommendations as have secured practical unanimity. At a recent meeting in Brussels certain countries desired to initiate the formation of an International Union of Biology, and their representatives tentatively drew up some statutes. These were submitted to a competent body in this country, which reported unfavourably, and there the matter ends so far as Great Britain is concerned. This does not, of course, prevent France, Italy, the United States, and other countries from forming a Union of Biology if they wish. I fail to understand where the grievance of the *Times* comes in.

ARTHUR SCHUSTER,

General Secretary of the International
Research Council.

The Constitution of the Alkali Metals.

IN a recent letter (*NATURE*, February 24, p. 827) attention was directed to positive rays of metallic elements generated by means of a heated anode by which lithium (atomic weight 6.94) was demonstrated to contain two isotopes 6 and 7. The mass spectrograph has now been successfully applied to the analysis of these rays and the investigation thereby extended to the heavier members of the group.

The method presents some peculiar technical difficulties, and the intensity of the lines yielded is very poor in comparison with that of the "gas" lines produced by the ordinary discharge tube. On the other hand, the arrangement is such that *none* of these ordinary "gas" lines appear at all, so that any line, however faint, if satisfactorily confirmed by repetitions with different fields, is conclusive evidence of the presence of metallic atoms of corresponding mass in the salt employed on the heated anode.

Sodium (atomic weight 23.00) is the easiest metal to deal with; its mass spectrum consists of a single line only. From the known values of the fields employed this line is in the position expected from the atomic weight; it is therefore assumed to be exactly 23, and used as a standard comparison line.

Potassium (atomic weight 39.10) gives a strong line at 39 and a very weak companion at 41. These figures are integers within about a quarter of a unit when compared with sodium 23. The relative intensities of the lines are not inconsistent with the accepted atomic weight. Potassium therefore probably consists of two isotopes 39 and 41.

Rubidium (atomic weight 85.45) gives two lines two units apart of relative intensity about 3 to 1. Comparison with the potassium line 39 gives these the masses 85 and 87 to within a fraction of a unit. As these values are in excellent agreement with the accepted atomic weight they may be taken, provisionally at least, as the weights of the two isotopic constituents of rubidium.

The mass spectra obtained from caesium (atomic weight 132.81) have so far exhibited only one line, which when measured against the rubidium lines indicates a mass 133. The intensity of this line leaves much to be desired, but it is sufficient to point to the conclusion that if, as the atomic weight would lead one to expect, another isotope of caesium exists, it is present in proportions of less than 5 per cent.

F. W. ASTON.

Cavendish Laboratory, March 12.

The Designation of Vitamines.

It is often said that a rose by any other name would smell as sweet but in chemistry this is not the case; the name is of consequence and the choice limited. I am glad that Prof. Liversidge takes exception in *NATURE* of March 10 to the sufficiency of the suggested dropping of the "e" from "vitamine"—the sting is still left in the "amin" tail; moreover, the word should be got rid of altogether, as it is but a monument of a gross experimental blunder.

In my early days one of the most valuable lessons I learnt was from the late Prof. A. W. Williamson, one of the keenest intellects of his day among chemists. He always insisted that we did well to use non-committal names—names which did not give expression to a view open to question but were simply descriptive of some recognisable character in no way open to doubt. No better illustration can be given than the use of the name "carbamide" for urea, actually enforced by the Chemical Society. "Urea" is non-committal but absolutely significant of the

origin of the substance, nothing more; "carbamide" is suggestive of a particular structure, of a view which, so long as I can remember, has not been in accordance with the facts and is now, I suppose, fairly generally abandoned, though the error is still perpetuated in the text-books—but one of the main purposes text-books serve is the perpetuation of error. Other cases might be quoted; time was when "constitutions" were settled on paper and not a few names are survivals of the practice.

In a course of Cantor lectures on "Food Problems" which I gave in May, 1919, I suggested the use of the term "advitant" in place of "vitamine." A word of good clang, its meaning is clear and will be obvious to most; the substances it is intended to cover are necessary to life and we may as well say so, though we have not the faintest idea what they are.

HENRY E. ARMSTRONG.

Relativity and the Velocity of Light.

MR. BARTRUM's excellent letter on p. 42 of NATURE of March 10 has done good service in extracting an explanation from Dr. Jeans, but the latter will forgive my saying that his position is not clear yet, at least not clear to me. Briefly thus:

(a) If we are able to compare the velocities of two single light journeys, one of which may be under normal conditions and therefore known, surely we have determined the other.

(b) I cannot see that Majorana's interesting experiments prove more than that the propagation of light has the characteristics of wave, and not projectile, motion.

(c) I admit Dr. Jeans's equations (1), (2), and (3), but I can see no merit in afterwards introducing v . If they are true for all reasonable values of u , what more is gained by writing $u+v$ instead of u ? Are they not the same thing?

OLIVER LODGE.

The Peltier Effect and Low-temperature Research.

FROM certain considerations emphasised by me in the *Phil. Mag.* for December (Supplement), 1876, especially § 33, ser. v., vol. ii., p. 538, about true contact e.m.f., I concluded that such forces are intimately connected with electrical resistance; good conductors fail to get a grip on the electricity so as to propel it effectively, while the grip of insulators is tremendous. Consequently it is probable that at any temperature at which electric resistance ceases, the Peltier effect will cease also.

OLIVER LODGE.

The Nature of the Emulsoid Colloid State.

THE publication in the Transactions of the Chemical Society for December last of the latest of the extremely valuable and interesting investigations by Prof. J. W. McBain and his collaborators on soap solutions leads me to direct attention to a hypothesis as to the nature of the emulsoid colloid state which I have briefly indicated in a technological paper on "Colloidal Fuels" (*Journ. Ind. Eng. Chem.*, vol. xiii., p. 37, 1921). The stabilising colloids used in these fuels belong to a class of bodies forming emulsoid sols and gels in *non-aqueous* systems, e.g. in hydrocarbon oils. The parallelism between certain such non-aqueous systems and aqueous emulsoids has struck many observers (notably M. Fischer) and caused considerable doubt as to the validity of the application of ionisation theories to the emulsoid colloids. Certainly it would appear that any theory of the

emulsoid systems must explain why sodium oleate forms sols and gels with water, whereas aluminium oleate does so with benzene.

The theory of micellar orientation supported by McBain appears to suffer in this respect, that the "micelle" postulated is already a micro-colloid system, and the colloid properties are already present in the "micelle." A consistent theory of emulsoids must not only be in agreement both with the physical properties (viscosity of sols, gelation, elasticity of gels, hysteresis, etc.) and with the facts as to chemical constitution (polysaccharide character of starches and celluloses, polypeptide character of proteins, fatty acid salts for soaps, etc.), but it should also show the physical properties developing from the chemical composition and constitution. If colour and selective absorption flow from chemical composition and constitution, there appears no reason why cohesion and selective adsorption should not do so also. The suggestion which I put forward was stated as follows (*loc. cit.*, p. 42):—"Such gels—(heat reversible) not coagula—may be imagined as very tenuous web-works, or foams, the mesh or walls of which are very probably sub-molecular in dimensions, or the whole mass of the colloids forms one 'molecule' uniformly dispersed through and partially dissolving the solvent. By partially I mean that only part of the 'molecule' of the emulsoid is consolute with the solvent or dispersible, while the other part of it is insoluble, and its atoms tend to unite, forming a semi-rigid framework."

The hypothesis proposed does not regard micellar orientation (and attraction) as primarily responsible for emulsoid sols and gels, but rather sub-molecular (or transmolecular) orientation of definite atom-groups, entirely in the sense of the theory of molecular orientation due to structure proposed for surface and interfacial tension phenomena by W. B. Hardy (*Proc. Roy. Soc.*, vol. lxxxvi., A, p. 610, 1912), J. Langmuir (*Journ. Amer. Chem. Soc.*, vol. xxxviii., p. 2221, 1916; *ibid.*, vol. xxxix., p. 1848, 1917), and W. Harkins (*Journ. Amer. Chem. Soc.*, vol. xxxix., pp. 354 and 541, 1917).

The genesis of a micelle, as plurimolecular unit of a colloid system, may be regarded as a consequence of equilibrium, usually incomplete, between homochemical solution forces and heterochemical forces, the former tending to dissociate and decompose the chemical molecule, the latter resisting decomposition. In the case of proteins the most probable general type of linkage, according to H. A. Plimmer ("Chemical Constitution of the Proteins," part ii., p. 2), is of the form

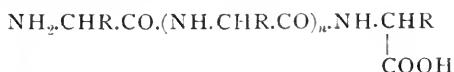

where n refers to the degree of polypeptide condensation and R is an alkyl or other substituent group. On the hypothesis suggested here we may, imperfectly, represent the redistribution of this in the presence of water for the polypeptide chain by

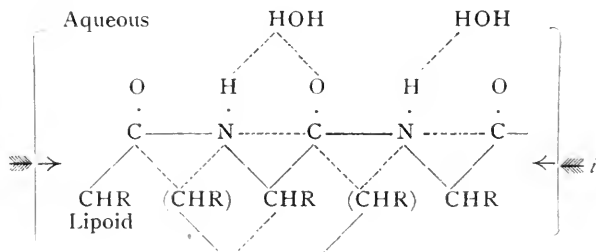

In this the arrows indicate the direction of an imagined plane or intra-molecular interface ι separating the hydrophile groups $\begin{matrix} \text{C}-\text{N} \\ \cdot \cdot \\ \text{O} \text{ H} \end{matrix}$, which are con-

solute with water (in virtue of residual affinities tending to complete the amino- and carboxyl groups), from the hydrophobe or hydrocarbon groups $-\text{CHR}$. Not only in one and the same protein molecule, but also to a variable extent between molecules, we may admit that this primary orientation leads to mutual attraction between water-soluble and water-insoluble groups respectively. Without any actual cleavage of the molecule, we have orientation and a straticheical field of force which is of a similar character, in essence, to crystallisation, but results in incomplete instead of complete equilibrium. The hydrocarbon or lipid atom groups will approach the fluid on the solid state according to molecular weights and constitution; hence the system may be likened, in one aspect, to a sub-molecular emulsion, the lipid groups tending to form interconnected sheets of atom-groups necessarily permeable to water and water solutes, although mechanically developing a stress resisting rupture in virtue of the fields of attraction and repulsion induced. The micelles are the smallest pluri-molecular units thus built up.

Applied to soaps, we have similarly a mutual attraction and solution of the hydrocarbon portions of the fatty acid radicles, without cleavage from the water-soluble portion, which dissolves and ionises. The passage of ionised micelles "through the open network of the gel as freely as through the sol" (Laing and McBain, *loc. cit.*, p. 1519) appears quite consistent with the hypothesis now suggested. Further, the form of the micellar aggregates—strings, sheets, networks of molecules—will, on this view, be a function of the original molecular constitution operating through intra-molecular orientation, and modified by ionisation and tautomerism, where these occur. The quasi-solubility in water of sodium, etc., soaps, being associated with ionisation, passes to insolubility in water with the non-ionising calcium, aluminium, iron, etc., soaps, when the solubility of the fatty acid portion (or hydrocarbon group) becomes dominant, and soap sols in non-aqueous solvents result. The stiffening to gels here with increased concentration and lowered temperature may be due to orientation of both the hydrocarbon and the metallic residues respectively, of the latter either directly or as oxides, these being solids at such temperatures.

In general, it is submitted that the present hypothesis gives a more generalised basis of explanation of what McBain regards as "not yet explained" (*loc. cit.*, p. 1518), viz. "the stable existence of any colloidal aggregate."

S. E. SHEPPARD.

Research Laboratory, Eastman Kodak Co.,
Rochester, N.Y., January 18.

THROUGH the kindness of the Editor I have been given an opportunity of commenting upon the speculations advanced by Dr. S. E. Sheppard in the foregoing interesting letter.

It is evident from reference to his paper in the *Journal of Industrial and Engineering Chemistry* that Dr. Sheppard is tempted to diverge from the views of nearly all who have studied the properties of suspensoid colloids, such as fine suspensions of particles of gold in water, and to regard these as being merely pseudo-colloids. In his opinion, a jelly made from gelatin, protein, starch, or soap would be the typical colloid, thus reverting to Graham's conception that

it is the substance, and not the physical state of subdivision, that makes a colloid.

It is impossible to exclude ionisation hypotheses from colloid chemistry now that it has been demonstrated that soaps in colloidal form are excellent conductors. At the same time we are quite clear that a theory of gels cannot depend upon ionisation phenomena, since gels occur in non-aqueous solvents which possess no measurable conductivity.

It is difficult to understand exactly what is meant by some of the technical terms used or coined without definition; but apparently Dr. Sheppard's conception of a stable colloid is a substance which contains atoms or atomic groupings, commonly found in chemicals which are insoluble in the solvent under discussion. For example, in aqueous sodium palmitate the long paraffin chain is regarded as being in itself insoluble in water, in contradistinction to the sodium atoms and ions. This is considered to result in a tendency for these hydrocarbon chains throughout the solution to become linked to each other through the residual affinity of the paraffin part of the molecule, to form sheets of molecular network co-extensive with the solution. The sodium end of each molecule is regarded as "dissolved" and subject to ionisation.

This conception is sufficiently elastic to conform to many of the facts, but surely such a word as "dissolved" loses its significance when applied to a solution in which both "undissolved" and "dissolved" parts of the molecule are present in a state of molecular subdivision. Thus, in the case of an aqueous solution in which gold is present in the form of single atoms—a case which has been very nearly realised—the gold would not be regarded as dissolved in the water, since gold and water are "heterochemical." The modern or current conception is certainly that this would be a true solution of gold, although highly supersaturated. It is evident that the difference is one of words, and not of scientific fact.

Again, it would be difficult to explain on Dr. Sheppard's conception the existence of gels such as that of rubber in benzene, in which surely every part of the hydrocarbon must be considered potentially soluble or "consolute" with benzene. Further, on what chemical grounds could one predict the formation of a gel of cadmium in alcohol?

I cannot but feel that even this conception of continuous open molecular network as constituting the typical colloid still leaves unexplained the stable existence of the colloidal aggregates of sols as distinguished from gels. In the case of an ordinary soap solution or sol, for example, perfect reversible equilibrium prevails, and yet the soap does not exist as "a continuous, semi-rigid framework," nor yet as single, independent molecules—that is, as crystalloid—since when in the latter condition it exhibits familiar crystalloidal properties such as osmotic activity. Hence our conclusion is that the soap is largely in the form of particles, each an aggregation of large numbers of molecules. Miss Laing found that there is a very ready change from sol to gel without alteration of either conductivity or osmotic activity. We seem forced, therefore, to conclude that the gel is built up from the same colloidal particles as the sol.

Similarly, in Svedberg's example of cadmium or cadmium oxide in alcohol, which at rest forms a jelly but on stirring reverts to a fluid sol, the colloidal particles of the sol must undoubtedly be those of the gel also. In this case the individual colloidal particles are presumably crystalline, in analogy with the experimental results recently obtained in Sherrer's X-ray investigations.

On the other hand, such colloids as gelatin have not indicated any regular pattern when examined by X-rays. A fully developed network of oriented molecules such as Dr. Sheppard describes should give indications analogous to a crystalline structure when thus examined. This X-ray method of investigation is being applied in another department of the University of Bristol to the various forms of soap solutions. It is hoped also to obtain fresh light on the problem by the experiments now being carried out by Miss Laing on the conduction of continuous current through soap jellies.

Dr. Sheppard's demand that any "consistent" theory of colloids should permit of the deduction of all the physical properties from the chemical formula alone, appears to over-estimate the extent to which the manifold physical properties of gold and silver sols of different degrees of subdivision and colour can be deduced merely from the knowledge of the chemical formulae of the metals. In conclusion, I think his idea is at present too vague and not sufficiently in accord with such facts as those mentioned to be likely to prove more fruitful than the one it seeks to replace, incomplete as the latter is in the absence of further experiment.

JAMES W. MCBAIN.

The Chemical Department, University of
Bristol, February 24.

The Production of Living *Clavellina* Zooids in Winter by Experiment.

In a recent publication ("Sea-temperature, Breeding, and Distribution in Marine Animals," Journ. Mar. Biol. Assoc., vol. xiii., No. 2, p. 351) the present writer showed that there was every reason to believe that the hibernation phenomena in many marine animals are purely temperature effects. In order to test this view the positions of sixteen good colonies of the beautiful Ascidian *Clavellina lepadiformis* were marked on September 1, 1920, on the wooden piles of the West Wharf, Great Western Docks, Millbay, Plymouth. This Ascidian usually appears on these piles about the end of May and dies down about the end of October, and has never been recorded in winter. On September 15 and 30 the piles were again visited and a record was made of those colonies which had survived the marking. The positions of the colonies were found to be shown effectively by three long wire nails driven into the piles on the outside of the colonies at the apices of imaginary triangles. On February 23 last the laboratory collector, Mr. Wm. Searle, who assisted in the marking of the colonies, visited the piles at the West Wharf and took careful scrapings between the nails marking the positions where *Clavellina* colonies were seen in September, 1920.

The material obtained remained in the collecting honey-jars on the floor of the laboratory until 8 p.m. of February 24. It was then examined, and anything like a resting stage of an Ascidian was picked out, cleaned a little, and transferred to clean water in a glass dish. On February 25 at noon the material was put into a warm room at a temperature of about 61° F., and distributed in a number of finger-bowls in ordinary tank-water passed through a Berkefeldt filter.

Little attention was given to the bowls beyond changing the water on February 28, until March 1, when a distinct *Clavellina* zooid was found in one dish and a bud in another. From that date onwards the number of zooids and buds has increased, and at the latest observation made on March 8 there were

twelve living zooids or well-developed buds and two well-developed zooids had been preserved. From the beginning of the experiment to March 1 the temperature did not fall below 60° F., and from an inspection of the thermograph records the mean temperature of the room is seen to be very nearly 61° F.; probably the mean temperature of the water in the dishes would be slightly lower. Since March 1 the mean temperature of the room and water has been slightly higher.

It is therefore highly probable that the awakening of *Clavellina* from the resting stage is a pure temperature effect. In this experiment tank-water was deliberately used, and it is considered highly improbable that this water can be regarded as biologically better than the water now surrounding the sleeping stages of *Clavellina* in the sea. There remains, therefore, only the presence or absence of some recondite chemical complex in the water as a possible factor in aiding in the awakening of this Ascidian. The existence of such a complex is, however, not regarded as probable.

Driesch has shown that *Clavellina* regenerates lost parts with facility, and that starving or foul water will also cause this Ascidian to absorb all its organs and pass into an undifferentiated condition. It would appear, however, that none of these factors operate during the period of hibernation, since the water at the West Wharf is undoubtedly more foul during the period when *Clavellina* flourishes than when it passes into and remains in the resting condition, and similar Ascidians in the same locality feed and grow during the winter. Other forms which feed in the same way, and probably on the same kinds of food, as *Clavellina* also flourish and grow in the same situation in winter.

It would therefore seem that variations in temperature are the normal stimuli for development and differentiation in *Clavellina*, and the determination of the actual point in temperature at which these changes occur should afford a useful clue in attacking the question of the underlying chemico-physical changes.

The winter resting stages of *Clavellina* are very simple bodies; they are flattened expansions of transparent gelatinous material (tunicin) with a mammillated surface containing a core of opaque yellow tissue—apparently undifferentiated—which shows mammillations corresponding to those in the gelatinous coat. In the development of the zooids the mammillations swell and a core of tissue extends into the swelling. The bud thus formed increases in size and differentiates into the zooid.

J. H. ORTON.

The Laboratory, The Hoe, Plymouth,
March 9.

The Elementary Particle of Positive Electricity.

REGARDING the suggestions for the name of the hydrogen nucleus made by Prof. Soddy (*NATURE*, December 16, 1920, p. 502) and Dr. Prideaux (*NATURE*, December 30, 1920, p. 567), it would seem to be better to use the term "hydron" instead of "hydrion," as being shorter and more euphonious.

It may be recalled that the late Lord Kelvin used himself, and tried in vain to induce others to use, the term "electrion" instead of "electron." At this late date it seems quite unnecessary to insist on the retention of the extra syllable simply to have the word "ion" retained in the longer term unless for the sake of euphony, as in "thermion."

ANDREW H. PATTERSON.

University of North Carolina, February 19.

New Studies of Sun-fishes made during the "Dana" Expedition, 1920.

By DR. JOHS. SCHMIDT, Carlsberg Laboratory, Copenhagen.

[The *Dana* is a four-masted motor schooner of 550 tons, belonging to the East Asiatic Company of Copenhagen. His Excellency H. N. Andersen, director of the company, generously placed this vessel at the disposal of the Danish Committee for the Study of the Sea for a cruise in the Atlantic.]

THE sun-fishes (*Mola* and *Ranzania*) are undoubtedly among the most remarkable creatures which inhabit the oceans. By their peculiar shape, altogether unlike what we are accustomed to find in fishes (Figs. 1-3), their divergence in point of internal structure, and the considerable size which the best-known species attains, they have from ancient times attracted the attention of naturalists.

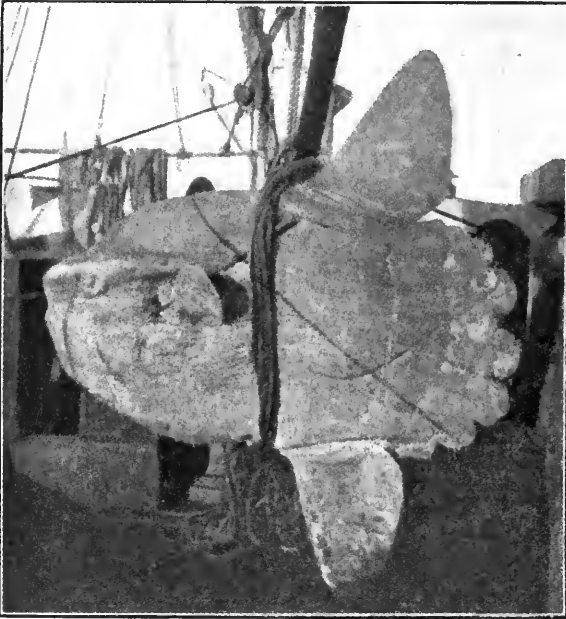

FIG. 1.—The short sun-fish (*Mola rotunda*). Length, 2'11 metres; weight not noted, probably about 500 kilos. (From Murray and Hjort's "Depths of the Ocean.")

Two species were known with certainty to occur in the North Atlantic: the short sun-fish (*Mola rotunda*, Fig. 1) and the oblong sun-fish (*Ranzania truncata*, Fig. 2). To these I am now able to add a third: *Mola lanceolata* (Fig. 3), a form the specific value of which has been questioned by recent authors. Though related to *Mola rotunda*, it is doubtless a distinct species, differing by the pointed tail and the number of fin-rays, as well as by several larval characters.

The oblong sun-fish attains a length of only two or three feet; the short sun-fish, on the other hand, is known to have reached a length of eight to ten feet or more, and a weight of more than a ton. It is thus one of the giants of the ocean. That the sun-fishes also possess gigantic strength is evident from a report of one of the Prince of

Monaco's cruises in the Atlantic with the yacht *Hirondelle*, where we read that a large specimen—the same as that represented in Fig. 3—which was harpooned from a boat sent out from the yacht, almost pulled the boat under in its struggles

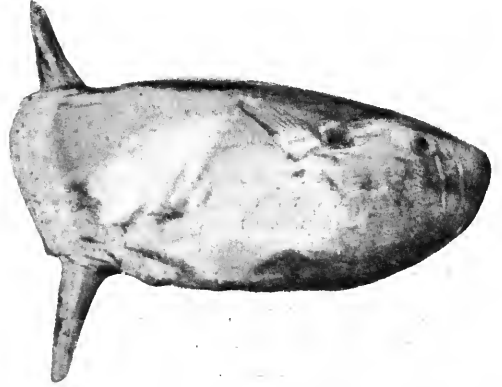

FIG. 2.—The oblong sun-fish (*Ranzania truncata*). Length, 0'65 metre. (From Beauregard.)

to escape. The sun-fish owes its strength to the powerful development of the muscles controlling the two large vertical fins (the dorsal and anal, shown in Fig. 1). On the other hand, the muscles generally composing the greater part of the body

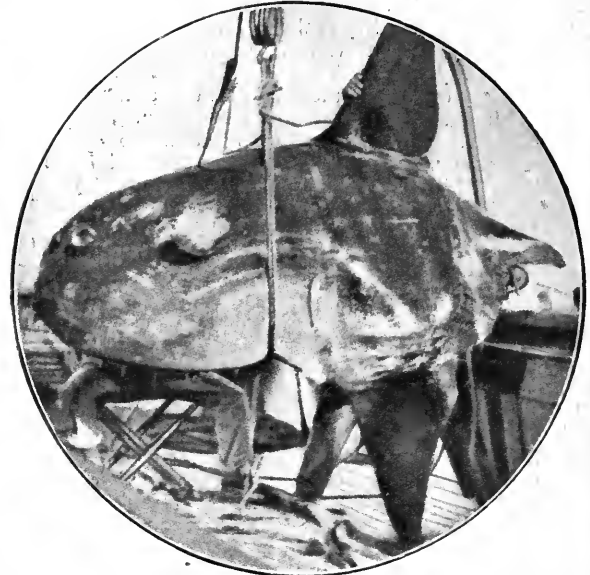

FIG. 3.—*Mola lanceolata*, a species related to the short sun-fish, but differing by the pointed tail. Length, 2 metres; weight, 285 kilos. (From the Prince of Monaco.)

in a fish, the great lateral muscles, are rudimentary in the sun-fish.

The short sun-fish (*Mola rotunda*) occurs comparatively frequently off the coasts of Western and Northern Europe, near the British Isles more

especially in the summer, and in Danish waters during autumn; it has also been found near Iceland and off the northernmost coast of Norway (about latitude 70° N.). It is thus not difficult to procure specimens, and such are also to be seen in most museums. The oblong sun-fish (*Ranzania truncata*), on the other hand, is far more rarely seen in collections. It does not penetrate so far to the north as *Mola rotunda*, but has, nevertheless, been found occasionally in the waters of Western Europe and the British Isles, where its northern limit of occurrence appears to lie.

With regard to the habits of the oblong sun-fish (*Ranzania*) practically nothing is known. It may, however, be mentioned that it was on one occasion observed in enormous numbers at the surface of the water, at Martinique, in the West

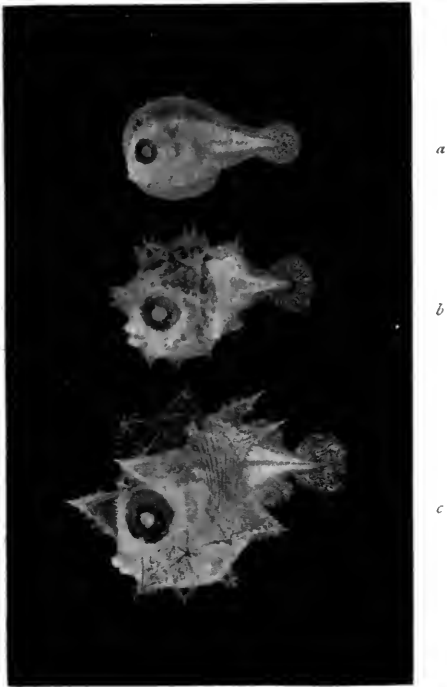

FIG. 4.—The oblong sun-fish (*Ranzania truncata*), larval stages. Length, *a*, 1.7 mm.; *b*, 1.8 mm.; *c*, 2.4 mm.; *a* hatched on board the *Dana* in the Sargasso Sea.

Indies. The short sun-fish is quite frequently encountered by mariners in the Atlantic. I have myself, on my cruises there, often seen it lying half sideways at the surface, with the tall dorsal fin projecting out of the water. It is not infrequently captured in the Mediterranean, especially during summer in the Straits of Messina, and it is known to feed on small forms of pelagic life. A fact of interest is that the larvæ of the freshwater eel appear to be its favourite food. The stomach, when opened, will often be found to contain eel larvæ (*Leptocephalus brevirostris*) by the hundred. There can thus be little doubt that it is one of the eel's deadliest enemies. The sun-fishes appear to be highly prolific. In a specimen of *Mola rotunda* $1\frac{1}{2}$ metres long, for instance, the

ovary was found to contain no fewer than 300 million small unripe ova.

The method of propagation of the sun-fishes, however, is unknown, and the tiny stages have not been identified in the case of any species. The collections made by the Danish Committee for the Study of the Sea have often brought to light larvæ which I had to refer to the sun-fishes, but it was impossible to determine to which species they belonged. On the trans-Atlantic cruise of the *Dana* in the summer of 1920, however, I succeeded in throwing light on the question, and was able to follow the



FIG. 5.—*Mola lanceolata* (*a* and *c*), *Ranzania truncata* (*b*); *c* larval, *a* and *b* post-larval stages. Length, *a*, 5.5 mm.; *b*, 3.5 mm.; *c*, 2.8 mm.; *a* and *b* same enlargement, *c* more enlarged. Note that the tail has disappeared in *a* and *b*.

development of two species for a great way back: in the case of one, to the egg itself. A full account of this needs a mass of illustration and proof material which would be out of place here. I will therefore merely give a few illustrations, reproduced from photographs, adding thereto some remarks on these larval forms, which, because of their odd appearance, are probably without parallel among fishes.

Fig. 4, *a*, shows a larva of the oblong sun-fish (*Ranzania truncata*), about 1.7 mm. long. It was hatched on board the *Dana* in the Sargasso Sea.

The eggs were found floating at a depth of scarcely 100 metres from the surface; they are small, transparent spheres, 1.3–1.4 mm. in diameter. It will be noticed that the larva, albeit clumsy to look at, nevertheless resembles an ordinary fish larva, with the usual strong tail. During the course of development, however, the tail is soon reduced, while the dorsal and anal fins, on the other hand, grow out strongly (see Fig. 5, b). It is precisely this reduction of the tail portion which gives the sun-fishes their remarkable, as it were truncate, appearance, as seen in Figs. 1 and 2. At a first glance it would appear as if the third species (*Mola lanceolata*) had retained the primary pointed tail (see Fig. 3). This is, however, only apparently the case; on studying the development, it will be seen that the primary larval tail here likewise soon disappears, and that the pointed tail discernible in Fig. 3 is a secondary formation. It almost seems, then, as if Nature had repented of her own strange whim, for scarcely has she deprived the species of its tail when she replaces it with a new one! All three species, indeed, undergo striking alterations in shape during development. When first hatched, the length of the larva is considerably greater than its height; but the proportions are soon reversed, and the height then exceeds the length (Fig. 5, a and b). This state of things, however, is not maintained; at a length of barely 5–6 mm. the body of the oblong sun-fish (*Ranzania truncata*) is already longer than it is high (in the case of the Mola species this does not occur until a far greater length is reached), and from now onwards the height decreases in proportion to the length until the final adult stage is attained (compare Figs. 4, 5b, and 2, as well as Figs. 5, c and a, and 3).

At an early stage, so far back as the embryo in the egg, we find the first indications of that spinous equipment which is so characteristic a feature of the sun-fish larvæ and young. The same spines can be recognised in both genera, thus showing that these belong to the same type; otherwise, the development and size of the spines differ widely, affording in this very feature a means of distinguishing the three species with the greatest ease. In the case of *Ranzania truncata* the spinous equipment is comparatively modest; in *Mola lanceolata*, on the other hand, the spines attain such an enormous development that at a certain stage they exceed the length of the body. Five of the spines at this stage stand out from among the rest in point of size, so much so, indeed, as to deserve the name of horns. Three of these are unpaired and set in the same plane, directed forward, upward and down, the remaining two being paired and set in a plane at right angles to the first, and pointing obliquely to the rear (Figs. 5, a, and 6). In all early stages the two genera are easily distinguishable one from the other by the structure of the bases of the spines, which in Mola exhibit transverse ribs, these being lacking in *Ranzania*.

NO. 2681, VOL. 107]

The Mola larvæ were invariably dead when found in the net; those of *Ranzania truncata*, on the other hand, I was now and then able to observe in a living state. The upper portion of the body (the entire part above the eyes) was dark, while the lower glittered like silver. When placed in a vessel full of sea-water, the larvæ could be seen shooting through the water at a surprising speed, propelled by the extremely rapid movements of the dorsal and anal fins, but apparently with no good steering qualities. Fig. 5, a and b, shows distinctly the two fins mentioned, which are set in a manner resembling that of the blades in a ship's propeller, here, however, always placed vertically.

The larvæ were found in the open sea, not far from the surface of the water: those of Mola somewhat deeper than those of *Ranzania*. They



FIG. 6.—*Mola lanceolata*, post-larval stage. Length, 5 mm. Front view.

were very numerous in places, especially in the Sargasso Sea, and we have found between one and two hundred in the contents of a single net, where they are difficult enough to discern among the thousands of other small creatures. I cannot, however, go further into the question of distribution until we have been through the collections thoroughly, which is a matter of considerable time.

In the literature of the subject, tiny larvæ of the sun-fishes have, so far as I am aware, been mentioned and figured three times: First, by Sir John Richardson (1844–48)—this, strangely enough, only on account of a drawing made by the botanist, Sir J. D. Hooker, who caught the specimen in a tow-net in the South Atlantic; secondly, in 1898, by the Danes Steenstrup and Lütken, from material collected in the Atlantic by Danish sail-

ing vessels many years ago; and, thirdly, by the Italian Sanzo, who in 1919 gave a figure of a specimen 2.8 mm. in length from the Straits of Messina. Richardson referred his—or rather Hooker's—specimen to the trunk-fishes, and termed it *Ostracion boops*; the other authors, however, realised that they were dealing with the young of sun-fishes, but were unable to make

any closer determination of the species. Judging from the new material provided by the *Dana* expedition, I can now with full certainty state that all the specimens in question are larvæ of the oblong sun-fish (*Ranzania*). The tiny stages of the short sun-fishes (*Mola*), however, do not appear to have been figured or mentioned in literature up to now.

Electrons.¹

By SIR WILLIAM BRAGG, K.B.E., F.R.S.

IN recent years the results of experimental research on the properties of electrons have accumulated with startling rapidity. As knowledge grows, the importance of the part played by the electron in the mechanics of the world becomes even clearer. There are all the right signs that progress is being made along a road that really leads somewhere; we are continually finding that, through some electron action, phenomena are linked together between which we had hitherto seen no connection. Precision is given to our views: we find ourselves able to express, quantitatively and with confidence, laws and relations which have been matters of vague surmise. Every experiment that is finished suggests others that are promising. The whole world of experimental physics is full of new life, and of the consciousness that after a period of hesitation the tide of discovery is sweeping on again. While knowledge grows by experiment, theory is also busy. The attempts to co-ordinate the new discoveries are of singular interest because of their daring, their width, and their strength: because they are so often fruitful in prediction: and, not least perhaps, because they seem so often to be irreconcilable with each other.

It helps to a right appreciation of the position as regards the electron if we observe its strong resemblance to the older state of things when first the atomic theory of matter was clearly defined. Just as chemistry has grown and prospered on its recognition of the unit of matter, so electrical science has already begun a new life, and, to all seeming, a most vigorous one, based on the understanding of Nature's unit of electricity. There are many different atoms of matter—nearly a hundred are distinguishable by their different chemical reactions; but the number of different kinds of electrical atoms is very much more limited. We have for some years been clear as to the existence of the electron, Nature's unit of negative electricity. More recently the work of Rutherford and Aston indicates that the nucleus of the hydrogen atom is to be regarded as the positive counterpart.

If the chemist has found so much profit in his recognition of the fact that Nature has just so many ways, and no more, of doing up parcels of matter, the electrician will surely gain in the same

way when he grasps the fact that not merely is electricity measurable in quantity, but that there is already a unit of Nature's choice, possibly no more than one unit. We may say with justice that already the most wonderful advances in modern physics are the reward for our appreciation of this truth, and we may hope with equal justice that we are yet far from reaping the full benefit.

The first suggestion of the atomic character of electric charge came, it is well known, from observation of the laws of electrolysis. Since the movement of atoms or atom clusters or ions across the electrolytic cell was accompanied by a simultaneous transfer of electricity, in which each ion, of whatever nature, bore always the same charge or at least a simple multiple of it, there was a clear indication that this division of electricity into parcels of constant magnitude implied the existence of some natural unit charge. No progress, however, was or could be made so long as the charge could be observed only as an attachment to an ion: it was not even clear that it could ever have a separate existence. In the long series of researches which finally led to the isolation of the electron and the determination of its properties, there were certain that marked definite stages in the forward movement. Crookes examined the electric discharge in bulbs exhausted to a high degree by the new air pumps which he had succeeded in making; and he observed the so-called cathode rays streaming away from the negative electrode. He showed that they possessed the properties to be expected from a stream of particles projected across the bulb and carrying negative electricity with them; for on one hand they could heat up bodies on which they fell, and on the other they were deflected in crossing a magnetic field. Crookes spoke of a fourth state of matter and defended his view against the opposing hypothesis, held largely on the Continent, that the stream consisted of electromagnetic waves in some form or other. Hertz showed that the rays could pass through thin sheets of matter such as aluminium leaf, and Lenard took advantage of this to coax them outside the bulb and display their effects in the air outside.

In the later years of last century came the great experiments of Wiechert, Thomson, and many other well-known observers, who weighed the electron and measured its charge, and showed that there was only the one electron, though it was

¹ The Twelfth Kelvin Lecture delivered before the Institution of Electrical Engineers on January 13.

to be found everywhere and in every body. Since then the measurements of these quantities have been repeated many times with increasing skill and understanding. They have reached their present high-water mark perhaps in the experiment of Millikan at Chicago, who gives as the value of the charge in electromagnetic units $e = 1.591 \times 10^{-20}$, the mass being 0.900×10^{-27} gram, or $1/1850$ of the mass of the hydrogen atom.

So we arrive finally at an accurate comparison of these unique and fundamental units of Nature with the units which we ourselves have chosen for our convenience, and without, of course, any consideration of the former. We infer from experiments such as those of Kaufmann and of Bucherer that the energy of the moving electron may be considered to exist wholly in the form of electromagnetic energy, such as is necessarily present when an electrical charge is in motion; and that its mass is in this way perfectly accounted for. But this conclusion sets a limit to the size of the electron, and we must assume that its radius, if its form is spherical, is very small compared with the radius of any atom. Also, as the velocity of the electron approaches that of light, its mass increases; imperceptibly at first, but in the end very rapidly.

Why, we may well ask, have these measurements of charge and mass never been made before? The electron is everywhere: the transfer of electricity from place to place consists always in the transfer of electrons. The electric current is a hurrying stream of electrons: all our electrical machinery concerns itself with setting them in motion, with giving them energy and again withdrawing it. In the processes of electrolysis the electrons are handed to and fro. Everywhere they fill the stage; why have we not hitherto noticed their qualities, which so far can be expressed so simply?

The answer is that we have never, until recently, been able to make them move fast enough in spaces sufficiently empty of air or other gases. It is only when an electron has a sufficient speed that it can escape absorption in the atoms which it must be continually meeting. Unless an electron has a speed exceeding about one three-hundredth of the velocity of light—that is to say, such a speed as it acquires in falling through a potential of a few volts—it sticks to the next atom it runs up against: even with ten times that speed it can move only a fraction of a millimetre through air at ordinary pressure before it loses its velocity, and, therefore, its power of going through the atoms. When Crookes first saw the cathode-ray stream in full course, it was because he had reduced the number of gas molecules in his bulb to such an extent that an electron could fly in a straight line from end to end of the bulb without going through more than a hundred atoms or so, and the induction coil had given it quite enough speed to do that without turning out of its course, no matter what sort of atoms they were. Incidentally, since atoms can be traversed in this way,

we naturally think of an atom as a very empty affair.

Electrons flying still faster than in the discharge tube are found to constitute a part of the radiation from radioactive substances. Some of the β -rays have velocities nearly equal to that of light and can pass through millions of atoms before their energy is spent. In open air a β -ray may have a course of metres in length, though it is generally broken by encounters with traversed atoms into a path full of corners and irregularities.

It is speed which gives separate existence to the moving electron: and speed which also betrays its presence to us. For, on its way, the electron here and there chips away another electron from an atom which it is crossing and leaves behind it a separation of electricities which may afterwards influence chemical action, as in the case of the phosphorescent screen or photographic plate, or provide a current for the ionisation chamber. We do not know exactly how this removal of electrons is effected, nor why some atoms part with electrons more easily than others, so that the flying electron loses less energy as it goes through: there is much that is obscure in the whole process. But it gives us a ready means of observation, without which, indeed, our knowledge of the electron would be far less than it is.

These electrons which are so made manifest by speed form but a minute fraction of the whole number existing. They are to be found in every body, and in every atom of every body. They form one of the elements of construction of the atom, and it is one of the most immediate aims of present research to find in what way they are built into atomic structure. In every atom there are certain electrons of which one can be removed at the cost of an amount of energy of the order of 10^{-11} ergs. The potential through which an electron must fall so that it acquires this energy is of the order of a few volts. There are other electrons within the atom which are intrinsically far more difficult to remove. On the other hand, some atoms—for example, those of a metal in the solid or liquid condition—have each one or more electrons which are little more than hangers-on, and are, indeed, removed with very little trouble. A block of pure metal is full of such loosely bound electrons, so that if an electric potential difference is maintained across the block an electron flow or electric current is produced. The metal “conducts.”

At sufficiently high temperatures all bodies become conductors; we must imagine that the violent thermal agitation shakes electrons free from their ties to the atoms even when at low temperature the bonds ordinarily remain unbroken. At a high temperature, too, the electrons acquire high velocities as they move to and fro with their proper share of heat energy. At the surface of the hot body the electrons may break away; and hence the “thermionic emission” investigated by O. W. Richardson. So copious is this supply of

electrons at the surface of a hot body that if the latter is made negative in potential relative to its surroundings there is a current discharge which may sometimes be measurable in amperes. Of course, such a current can pass only one way, negatively from the hot body, or positively towards it. So we get the basic principle of the "valve," and so Coolidge provides the electrons for projection against the target in the X-ray bulb which he has designed. At this point we find already the adaptation of our new knowledge of electrons to apparatus of extraordinarily great use to mankind.

If now we plunge a little deeper into our subject we come to certain most fascinating regions of it, where exploration is still in full progress. In one of these we find the most remarkable connection between moving electrons and electromagnetic waves. One, it seems, can always call up the other, and the action obeys certain precise numerical laws.

Let us take as an example the production of X-rays in a Coolidge bulb. A plentiful supply of electrons is provided at the cathode by heating a fine spiral of tungsten wire to a high temperature. A high potential difference between cathode and target is provided by some approximate means, and the electrons are hurled at the target, each possessing an amount of energy equal to the product of the electron charge and the applied potential. Where the electrons strike, some of their energy is converted into electromagnetic waves of very high frequency, the so-called X-rays. Suppose that we measure the energy supplied to each electron—not an easy matter with the usual arrangements, but very easily done if, as in certain experiments of Duane and Hunt at Harvard University, the potential is derived from a great storage battery of 40,000 volts. Suppose, further, that we analyse by the X-ray spectrometer the X-ray radiation that issues from the target. We find that the frequencies of the emitted rays may have a wide range of values, but that the upper limit of the frequencies is always proportional to the energy of the electron, and, therefore, to the potential imposed on the tube. This ratio remains the same no matter what the intensity of the electron discharge, and no matter what the nature of the target. This ratio of electron energy to maximum frequency is a number which has turned up in previous cases where the emission of radiation energy has been measured: it is known as Planck's constant, and denoted by "h." Its value is 6.55×10^{-27} . Although the constant has been met with before, there is probably no instance where the transformation of energy which it governs is so simply displayed or so easily measured as in the case just described.

In certain measurements made by Duane and Hunt and illustrated in Fig. 1, the X-ray spectrometer was set to observe the presence of a certain frequency as soon as it appeared. The potential on the tube was then increased by degrees. The rays of the given frequency appeared as soon as the

energy supplied to the electron was equal to the frequency multiplied by h . As the potential was increased still further these rays increased in intensity, as the figure shows.

It is to be observed that the production of X-rays is no aggregate of individual efforts by separate electrons: each electron produces its own train of X-rays when it strikes the target. There is no sign of any combined action, as, indeed, is evident from the fact that the intensity of the cathode-ray stream is without influence on the frequencies of the X-rays produced.

The crucial point is that when the energy of an electron is handed over in whole or in part, the frequency of the X-ray waves that take over the energy is determined by the quantity of energy handed over. This explains why there is a limit to the frequency of the X-rays: it is because there are some electrons, though only a fraction of the whole number, which give up all their energy to the formation of X-rays at the moment of striking, before they have lost energy in collisions.

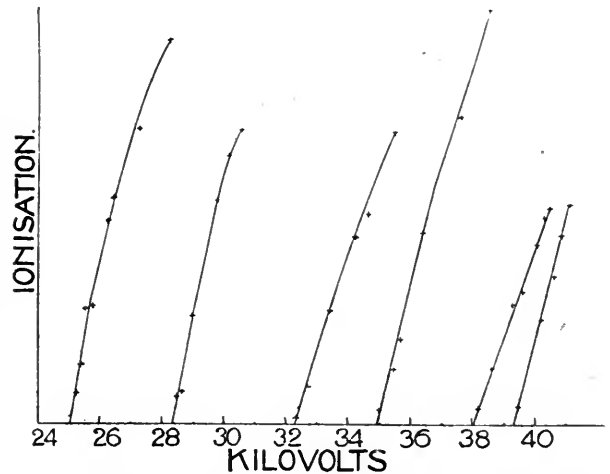

FIG. 1.—From Duane and Hunt, *Physical Review*, 1915, p. 166. Each curve represents the growth in intensity of a certain wave-length as the voltage applied to the X-ray bulb is increased. The wave-lengths are: left to right, 0.488, 0.424, 0.377, 0.345, 0.318, 0.308, all in Angstrom units (10^{-8} cm.).

The rest of the rays, all those which have lower frequencies, will come from electrons that have lost speed in this way, or possibly have transferred only part of their energy. The atom of the target is playing the part of a transformer, and does not determine the frequency, so far as these effects are concerned.

All this is wonderful enough; but the marvel is greatly increased by the discovery that the effect is reciprocal. Just as the swiftly moving electrons excite X-rays, so X-rays when they strike any substance lose their energy, which now appears as the energy of moving electrons. And, again, we find the same variation in the result and the same limit to that variation. Among the electrons so set in motion we find, examining them as soon as possible after their motion has begun, every variety of energy-content up to a certain critical

value which is equal to the frequency of the X-rays multiplied by the same constant h . It is to be observed that we cannot measure all the electron velocities as soon as they exist because some of the motions begin in the body of the substance, into which the X-rays have penetrated, and have lost speed on the way out. Again, therefore, there is nothing against the hypothesis that the energy of every electron set going by waves of given frequency is originally the same, and is determined by the standard condition already given.

Not only in the case of X-rays are these effects observed, but also in the case of light. The only difference is that the frequencies of light vibrations are some 10,000 times less than those of X-rays, and the electron energies correspondingly smaller. When the light waves produce the electrons we have what is known as the photo-electric effect. The production of light by electrons has been much studied recently in experiments to find "resonance-potentials"—that is to say, the magnitudes of potentials which must act on electrons so as to give them enough energy to excite certain particular radiations from atoms on which they fall.

Exactly how this strange transfer of energy from one form to another takes place we do not know: the question is full of puzzles. The magnitudes involved are hard to realise; it helps if we alter their scale of presentment. Suppose that

the target of the X-ray bulb were magnified in size until it was as great as the moon's disc—that is to say, about a hundred million times. The atoms would then be spheres a centimetre or so in diameter. But the electrons would still be invisible to the naked eye. The distance from earth to moon would correspond roughly to the distance that ordinarily separates the bulb from an observer or his apparatus. We now shoot the enlarged electrons at the moon with a certain velocity; let us say that in every second each square yard or square foot or square inch, it does not matter which, receives an electron. A radiation now starts away from the moon which immediately manifests itself (there is no other manifestation whatever) by causing electrons to spring out of bodies on which it falls. They leap out from the earth, here one and there one; from each square mile of sea or land, one a second or thereabouts. They may have various speeds; but none exceed, though some will just reach, the velocity of the original electrons that were fired at the moon. That, reduced again to normal size, is the process that goes on in and about the X-ray bulb: which is part of a universal natural process going on wherever radiation, electron or wave, falls on matter, and which is clearly one of the most important and most fundamental operations in the material world.

(To be continued.)

Obituary.

THE RT. HON. LORD MOULTON OF BANK, F.R.S.

THE news of the sudden death of Lord Moulton on March 9 came as a shock to all who had been associated with his many activities. Notwithstanding his advanced age—he was in his seventy-seventh year—he was so full of vigour that all his friends had looked forward to some further years of activity for the good of the country he loved so well, and for which he rendered such magnificent services. He died in the midst of his work; the very day before his death he was engaged in hearing an appeal at the House of Lords. A short time before, he delivered a speech on behalf of the chemical industries of the country with all his customary lucidity and vigour, and again on February 19 he showed his delightful personal charm as chairman of a "Saturday Evening" at the Savage Club. These random incidents might almost be taken as typical of the outstanding qualities of the man—the brilliant judge and lawyer, the man of science and patriot, and the genial companion whose sympathy and humour helped to brighten many a life, and never more than in the dark days of the war, when he was always ready to cheer and inspire those around him and to lead the way in meeting one difficulty after another.

After his brilliant career previous to the war, in which he had shown himself an adept at science, classics, law, and politics, as well as an athlete

and a linguist, Lord Moulton might well have been content to rest upon his laurels, but unquestionably his greatest achievements were for the cause of his country, when, at the age of seventy, he took up a burden which would have taxed the endurance of the strongest man, and set himself to organise the resources of the country to obtain the explosives necessary for the war. Looking back upon his earlier career, it might almost seem that his numerous activities were directed by destiny towards the great climax of his life. Certainly they formed a unique training which fitted him for his supreme task in a way which could scarcely have been paralleled.

Lord Moulton was born on November 18, 1844, at Madeley, his father being the Rev. James Egan Moulton, a Wesleyan minister. After passing through the Wesleyan school at New Kingswood, near Bath, he entered St. John's College, Cambridge, and had a brilliant career as a student. In 1868 he became Senior Wrangler and first Smith's prizeman, and took a gold medal at London University. He was elected a fellow and lecturer at Christ's. His academic career was not of long duration. In 1874, at the age of about thirty, he was called to the Bar, and speedily became famous as a specialist in patent cases. His scientific training gave him a great advantage in dealing with such subjects, and he was entrusted with many cases involving very large

issues. In his later years it was a delight of his to recall the patent cases on which he had been engaged, and he was able with his wonderful memory to relate the circumstances in close detail. The esteem in which he was held as a scientific investigator was signalised by his election during this time as a fellow of the Royal Society. One of his greatest efforts at the Bar was as counsel for the newly formed Metropolitan Water Board before the Commission on the water supply of London, and in this his mathematical knowledge was of great service to him in dealing with an intricate set of statistics.

Lord Moulton's Parliamentary career commenced in 1885, when he became M.P. for Clapham. Afterwards he contested other seats, ultimately becoming member for Launceston. He was, however, too independent in thought to attune himself readily to party politics. In 1906 he became a Lord Justice of Appeal, and in 1912 a Lord of Appeal and a member of the Judicial Committee of the Privy Council. He was also made a life peer. At the same time, he had numerous other activities in connection with medical research, engineering, etc.

Then came, in 1914, the great struggle which was to give scope for all his wide experience and wonderful energy. Few men had the vision in those early days of the war to foresee its magnitude as Lord Moulton did. For him there could be no peace of mind when he knew that other men were thinking in tons of explosives while he was already thinking in hundreds of tons. He knew the Germans, knew how they had for a generation specialised in organic chemical industry, and knew also that unless this country made a great and immediate effort, the war would end through shortage of supplies on the side of the Allies. Fortunately, he had a power of insistence which enabled him to impose his influence against all resistance and in spite of all difficulties. In November, 1914, he became chairman of a small Advisory Committee on Chemical Products. Two months later, in consequence of his efforts, the Committee on High Explosives ("A 6") was formed under the War Office, and ultimately he became Director-General of the Department of Explosives Supply under the Ministry of Munitions, and obtained a freedom of action which enabled him to make provision for the abundant supplies of explosives which he foresaw to be necessary.

Lord Moulton gathered round him a staff in which he placed entire confidence. The fear of a shortage was always before him, but he laid his plans with courage and prevision. At the beginning of the war picric acid was the standard high explosive. Lord Moulton realised at once that the supply of raw materials was absolutely inadequate. This necessitated the establishment of a new industry—the synthetic phenol industry—to increase the supply of picric acid, and at the same time the manufacture of T.N.T., which was new to this country, had to be inaugurated. As the demands increased, the T.N.T. had to be economised by mixing it with ammonium nitrate.

and this was ultimately done without loss of efficiency. It was characteristic of him that he was untiring in his personal inspection of the explosives factories, and travelled thousands of miles, often at night, to spend Saturdays and Sundays in this way. From end to end of the country his visits were welcomed on account of his helpfulness and encouragement. He and his devoted staff had ultimately the satisfaction of seeing the supplies of explosives increase to such an extent that not only our own needs, but also those of our Allies, were met.

Later in the war the supply of poison gases also came into Lord Moulton's hands. This side of the work was most repugnant to him, but he met it, as a hateful necessity, with his full vigour and with notable success.

By reason of its very efficiency the work was but little heard of, and consequently imperfectly appreciated by the general public. It is pleasant, however, to recall that his efforts were recognised by the conferment of the K.C.B. in 1915 and of the G.B.E. in 1917. He had a host of foreign distinctions, and was a Commander of the Legion of Honour.

After the war Lord Moulton was untiring in his efforts to place the scientific industries of the country on a sound basis. Few, if any, can realise what the country owes to him for his work of the last six years. His self-sacrificing devotion was unbounded. He was a great patriot and a true friend.

R. C. FARMER.

BARON T. KIKUCHI.

MEN of science in this country and in Japan will hear with much regret of the premature death, on March 2, of Baron T. Kikuchi at the age of twenty-seven. The son of a distinguished father, the late Baron Kikuchi, at one time Minister of Education in Japan, he had a distinguished career in the University of Tokyo, specialising in physics under the direction of Prof. Nagaoka. In 1919 he came to England to work in the Cavendish Laboratory under the direction of Sir Ernest Rutherford. His first paper, published in 1920 in the Proceedings of the Royal Society in conjunction with Dr. F. Aston, contained a careful and able examination of the nature and velocity of the swiftly moving striations observed in neon and helium. An account of further independent work on this subject is in course of publication. In the midst of the preparations for the experimental attack on an important physical problem Baron Kikuchi was taken ill and died after a two months' illness in a nursing home in Cambridge. During his illness he was devotedly attended by his young wife, who had come from Japan to join him a few months before. Like his father before him a member of St. John's College, a special memorial service was conducted in the college chapel by the Master, attended by the Vice-Chancellor of the University. The remains were taken to London for cremation.

A man of marked intellectual energy and experimental ability, Baron Kikuchi had been

selected to fill an important post in the new National Physical Laboratory at Tokyo on his return from Europe. His intelligence and charm of manner had gained him many friends both in this country and Japan, who deplore the untimely end of such a young life so full of promise of achievement in science.

E. R.

THE death of GEORGES HUMBERT on January 22 has removed a mathematician of exceptional powers. Humbert may be compared with Clebsch, because, although he may not have invented a new mathematical engine, he showed unexpected uses

of those already provided. In his hands Abel's theorem and Poincaré's researches on Fuchsian functions became magic keys to unlock the treasures of geometry, and give us concrete and elegant images of analytical ideas. One of his most characteristic works is his memoir on hyper-elliptic surfaces, for which he obtained the Bordin prize, and which was published in *Liouville's Journal*. In his later years he was attracted by the theory of numbers, and published several papers on arithmetical forms. Humbert gave lectures at the Ecole Polytechnique, and also at the Collège de France.

M.

Notes.

DR. H. K. ANDERSON, Master of Gonville and Caius College, Cambridge; Prof. W. M. Bayliss, professor of general physiology, University College, London; and Sir William H. Bragg, Quain professor of physics, University of London, have been elected members of the Athenæum Club under the provisions of the rule of the club which empowers the annual election by the committee of a certain number of persons "of distinguished eminence in science, literature, the arts, or for public service."

ON Monday last, March 14, the Albert medal of the Royal Society of Arts was presented to Prof. Albert Michelson, foreign member of the Royal Society, for his discovery of a natural constant which has provided a basis for a standard of length. The award was made last year, but the actual presentation was deferred until Prof. Michelson could come to England to receive it. In the absence of H.R.H. the Duke of Connaught, the president, the medal was presented by Mr. Alan Campbell Swinton, the chairman of the council of the society. By the use of his interferometer Prof. Michelson found the length of the Paris standard metre to be 1,553,164 times the wave-length of the red line of cadmium, and his calculations have since been verified as accurate within a limit of error of one wave-length, or say two-millionths of a millimetre. To the society the award is of especial interest, because in 1774 it offered a prize for an invariable standard of length, and up to the present date there has never been found a successful competitor. As the Albert medal is limited to practical applications of science, the society could not recognise any other of Prof. Michelson's scientific discoveries, but its council was doubtless influenced by an appreciation of their extent and value. His construction of optical gratings, determination of the velocity of light, and precise experiments on the relative motion of æther and matter are of fundamental importance, and his échelon spectroscope has provided physicists and astronomers with a most valuable instrument of high resolving power. Several years ago Prof. Michelson used his interferometer to measure the diameters of the four chief satellites of Jupiter, and suggested its application to the fixed stars. This has now been done at the Mount Wilson Observatory, and a short account of the remarkable results obtained was given in *NATURE* of January 20, p. 676.

THE magnetic research steamer *Carnegie*, of the Carnegie Institution of Washington, returned to San Francisco on February 22 after a scientific expedition to the Indian Ocean, West Australia, New Zealand, Tahiti, and Fanning Islands to investigate the magnetic condition of the earth over ocean areas. The only information as to the results of the voyage yet announced is that the Royal Company Island was sought for in vain. The Royal Company Island or Islands figured on charts of the Southern Ocean for more than a century, having been reported by the Spanish ship *Rafaelo* about 1776 in 49° S., 142° E. Bellingshausen in the Russian Antarctic Expedition appointed the island as a rendezvous for his two ships in January, 1820, but both vessels sought it in vain. Dumont D'Urville on the French Antarctic Expedition in 1840 also searched for the island, but could not find it; still, the name remained on the charts in various positions between 49° and $53^{\circ} 30'$ S. and between 141° and 145° E. The re-discovery of Bouvet Island by the *Valdivia* in 1898, after Cook in 1772 and 1775 and Moore in 1845 had passed within twenty miles without sighting it in their searches, re-awakened doubts as to the non-existence of other islands reported in the Southern Ocean and never seen again. Capt. J. K. Davis in the *Nimrod* of Shackleton's expedition in 1909, and again in the *Aurora* of Mawson's expedition in 1912, sailed over most of the assigned positions and got soundings of more than 2000 fathoms in the vicinity. The work of the *Carnegie* should be held to have completed the difficult task of proving a negative, and so to clear the chart of another iceberg.

THE *Daily Mail* of Saturday last, March 12, publishes a message from its Paris correspondent referring to a prediction by the Abbé Moreux that the next fourteen years will be relatively dry in Western Europe. The alternation of wet and dry periods of about seventeen years each referred to in the report, and in the short leading article upon it, is, however, by no means a new discovery. Indeed, a cycle of precisely the same length and type as that now announced was mentioned more than three hundred years ago by Francis Bacon, and in our own time Prof. E. Brückner, of Berne, has traced its effects in a variety of meteorological phenomena. The Abbé Moreux may have found a new weather-period, but

what is described by the *Daily Mail* is nothing more than Brückner's cycle, which corresponds approximately to the length of three sun-spot periods.

THE Report of the Museum Committee of the Borough of Warrington deals with the four years ending June 30, 1920. In May, 1920, Mr. Charles Madeley, who had been director and librarian for forty-four years, died, and the opportunity was taken to separate the museum from the library and to provide each institution with an independent staff. This undoubtedly is a move in the right direction. The new keeper of the museum is Mr. G. A. Dunlop. The collections have received a number of accessions, among which those of local interest are predominant, and include many specimens collected and determined by the Lancashire and Cheshire Fauna Committee, notably 290 Diptera and 77 Hymenoptera obtained by Col. Fairclough in his own garden.

IN spite of difficulties connected with the delayed progress of the new building and the large amount of work entailed by the visit of the British Association, the thirteenth annual report of the National Museum of Wales records considerable progress in all departments. In the natural sciences and in archæology the museum is becoming, as it ought, the headquarters of investigation in the Principality. Thus Dr. Ethel Thomas, keeper of botany, has set going a primary vegetation survey of Wales in co-operation with field-clubs and school-teachers. Dr. Simpson, keeper of zoology, has started a faunistic survey of Glamorgan in conjunction with the Cardiff Naturalists' Society—an effort that is obviously capable of extension. The archæologists of Wales assembled in congress have expressed the opinion that all finds should be preserved in museums for the control and maintenance of which effective provision has been made, and that local museums should be affiliated to the National Museum.

THE Museum Journal of the University of Pennsylvania for September, 1920, contains a well-illustrated article by Dr. W. C. Farabee on several collections of ancient American gold objects that have lately come into the possession of the museum. These objects are of extraordinary interest in the development of art, and many of them are of great beauty. A number of Sumerian tablets, some of which were described by Dr. Stephen Langdon in 1917 as part of a law code, are here translated for the first time by Père V. Scheil, of Paris, and prove the existence of a code at least 1000 years before the famous code of Hammurabi (*circa* 2000 B.C.). Other articles deal with the gold treasure in the Temple of Baal at Nippur (1300 B.C.) and with ancient Peruvian textiles. The latter is illustrated by coloured plates. We may envy our American friends these treasures of art and learning, but a museum that makes its riches so promptly known in this interesting manner deserves to possess them.

THE study of soils as pursued in agricultural institutes deserves far more attention from geologists than it ordinarily receives. W. G. Ogg and J. Hendrick have made interesting experiments ("Studies

of a Scottish Drift Soil," *Journ. of Agric. Sci.*, vol. x., p. 55) on the absorptive power for ammonia of powdered granite. The considerable result obtained is not dependent on the presence of weathered material, nor does the amount taken up increase as rapidly as the increase of surface due to finer powdering of the sample. When afterwards treated with water, the powdered granite behaves like a soil, since a part of the ammonia remains fixed, probably by adsorption, on the particles of the rock.

THE Norfolk and Norwich Naturalists' Society has recently published a new number of its Transactions (vol. xi., part 1). The issue includes Mr. J. H. Gurney's presidential address, Prof. Boswell's long and authoritative study of the surface and dip of the chalk in Norfolk, and the report of the Blakeney Point Committee. This report is excellent reading; for Blakeney Point throughout the war had its work of national defence, and good stories are told of quiet English men of science mistaken for spies, and of treasure-trove of wreckage washed ashore. Now the "military authorities" are gone, and the men of science are come back to the Point; as it is said by a writer of admirable prose but shockingly bad poetry: *Cedant arma togæ: concedat laurea laudi*. We wish all success to this famous and hard-working society in this fifty-second year of its life; and to Dr. Sidney Long, who has done so much for its welfare.

IN a recent paper (*Journal of Genetics*, vol. x., No. 4) Prof. Punnett and the late Major P. G. Bailey publish some results on the inheritance of egg-colour and broodiness in poultry. The crosses were chiefly between Black Langshans on one hand and Brown Leghorns or Hamburgs on the other. Both broodiness and egg-colour were transmitted by the cock as well as by the hen. Although there is evidence of association between these two characters in inheritance, yet it is found to be possible to establish a non-broody race laying brown eggs. As regards egg-colour, F_1 birds laid eggs of an intermediate tint, and in F_2 there was segregation, with a series of intermediate tints as well as the pure white and dark brown grades. In the reciprocal crosses between Brown Leghorn and Langshan a great difference was found in the eggs laid by F_2 offspring, a preponderance of eggs approaching the colour of the eggs of the female parent in both cases. It is considered, however, that this may have been a coincidence owing to a difference in the composition of the Leghorn strain employed in the two crosses. Broodiness is found to be highly complex, birds sometimes showing the character in one year and not in another, F_1 hens from a cross being usually broody, while in F_2 the proportion of broody to non-broody birds shows great variation in different crosses, and the condition may be due to the action of more than one genetic factor.

ARTICLES V.-VII. in vol. xlii. of the Proceedings of the U.S. National Museum are by Mr. A. C. Kinsey, who writes on the American Cynipidæ or gall-wasps. These contributions are particularly welcome, as students of the family have been few, and there are still large areas of the world from which practically

no collections have yet been made. The biological phenomena concerning these insects are of great interest, especially those bearing upon gall-production, parthenogenesis, and alternation of generations. In article v. the author adds sixteen species to those already known, and eight plates are devoted to portraying the particular types of galls produced by them. Article vi. is devoted to a summary of our knowledge of the life-histories of gall-wasps, together with notes on those of a number of American species. We hope the author will see his way at a future date to study their larvæ and the development of the galls in which the latter live. In article vii. are many interesting observations on the phylogeny and general biology of the family. The author tells us that 86 per cent. of the known species of gall-wasps affect *Quercus*, and are confined to that genus. Another 7 per cent. are confined to species of *Rosa*. The remaining 7 per cent. are found in plants belonging to various natural orders, and it is evident therefrom that 93 per cent. of the known Cynipidæ are restricted to two genera of plants only. Among other features a table is given of the proportions of the sexes which obtain in the various species. In some cases males are unknown, and in others the proportion of this sex to females varies from 1.5 per cent. in *Rhodites rosae* to 55 per cent. in *Aulacidea podagrae*. The author concludes that alternation of generations is a more or less extreme type of seasonal dimorphism, and is primarily due to seasonal environmental conditions.

ACCORDING to the annual report on the Forest Administration of Nigeria for 1919, out of a total estimated forest area of 218,000 square miles only 3143 square miles have so far been permanently reserved as forest, though an additional area of 2558 square miles is in process of reservation; this will bring the area of reserved forests to 2.6 per cent. of the total estimated forest area and less than 1.7 per cent. of the total area of Nigeria. The Director of Forests urges with good reason the necessity for more rapid progress in the reservation of forests up to at least 25 per cent. of the total area of the country, the urgency being the greater from the fact that the forests are otherwise threatened with destruction by shifting cultivation. Scientific forest management is still in its infancy. There are no working plans, and meanwhile the forests are worked under a crude form of selection fellings regulated by a minimum-girth limit, this being the only method of treatment possible with the present small staff. Artificial regeneration has made some slight progress, and the Director of Forests is alive to the possibility, under suitable conditions, of raising plantations with the aid of shifting cultivation—a system found so successful in Burma. The chief timbers extracted are described as mahoganies and cedars, together with *Terminalia superba*, *Mitragyna macrophylla*, *Scottelia kamerunensis*, *Lophira procera*, and *Uapaca Staudtii*. Exports consisted almost entirely of mahogany, to the extent of 8516 logs valued at 115,820l.

A MEMOIR on "North-Western Queensland," issued as Publication 265 by the Queensland Geological Survey (1920), describes a region of metamorphosed

sediments, possibly Silurian, unconformably overlain by Jurassic strata with artesian water, and including important mines of copper and iron. A feature of the memoir is the use of colour in the geological sections, which adds very agreeably to their clearness, as Portlock and the earlier geologists realised in the palmy days of publication.

Now that the question of the relation of kame-mounds and eskers to ice-margins has been once more raised in the British Isles, attention may be directed to the study of the Newington Moraine of New England, extending across Maine, New Hampshire, and Massachusetts, by F. J. Katz and A. Keith (U.S. Geol. Surv., Prof. Paper 108-B). The gravels are sometimes bouldery and unsorted, sometimes well stratified, and the long ridge represents material graduating south-eastward into an outwash-plain of clay and deposited from an ice-front in the sea. Leda-clay sometimes overlaps the moraine material.

It is to be hoped that the new Egyptian Government will continue the series of informing publications now issued by the Geological Survey of Egypt under the Ministry of Finance. In Palæontological Series No. 4 M. R. Fourtau describes the Neogene Echinoderms, and is able to assure us that, thanks to collections made by Messrs. Madgwick and Moon and Hassan Effendi Saddek during the recent exploration of the petroliferous zone, this echinodermal fauna is now completely represented in the Cairo Museum. While the genera as a whole are of Mediterranean types, interesting additions occur which have hitherto been regarded as exclusively Indo-Australian. In the lithographed plates, executed in Paris, the large flattened or domed genera so characteristic of Miocene times are handsomely represented.

THE report of the proceedings of the fourth International Meteorological Conference held in Paris from September 30 to October 6, 1919, has been rendered into English by the Meteorological Office, and is now published by the Air Ministry as Paper M.O. 239. As the last International Conference met so long ago as 1905, there was a wealth of new material to discuss. The meeting dealt with international meteorological organisation in all its branches; the present position of the science with regard to aviation, artillery, transport, and the physics of the air was reviewed, and codes for the transmission of observations on climatology and aerology were discussed. A number of commissions were deputed to report on the preparation of an international meteorological vocabulary and to supervise scientific investigations. Included in the report are nine appendices giving the minutes of meetings of the commissions appointed at the conference; a list of the sources from which the Meteorological Office in London has received data during the past ten years, and a note by M. Bjerknes on the projection and scale of charts.

THE January issue of the Proceedings of the Cambridge Philosophical Society contains a summary by Dr. E. H. Hankin of the papers on flight which he has contributed to the *Aeronautical Journal* during

the past ten years. Dr. Hankin has been able to study under exceptionally good conditions during his residence in India the circumstances which influence the soaring flight of birds, dragon-flies, and flying-fishes. In all cases the wings of the bird, dragon-fly, or fish are more nearly horizontal the faster the flight, and the speeds attained are very similar, *i.e.* from 5 to 10 metres per second for slow, and between 15 and 20 for fast, flight, whether of vulture, dragon-fly, or flying-fish. The regularity of the soaring flight of cranes in flocks disproves the theory which attributes it to chance air-currents. Both dragon-flies and flying-fish use their wings, legs, or abdomen as brakes during soaring flight, and this use discredits the theory that the flight is due to imperceptible wing movements, which, if they existed, the bird or fish could diminish at will. The horizontality of the wings disproves the side-current theory, while observations of soaring in the midst of aerial seeds or feathers which showed no irregularity of motion render the theory of turbulence untenable. Dr. Hankin thinks that direct observation requires to be supplemented by experiment before a satisfactory explanation of soaring flight can be furnished.

THE Collected Researches of the National Physical Laboratory (vol. xv.) is a reprint of eighteen papers dealing with physical, metallurgical, and engineering subjects which have appeared in the proceedings of scientific societies or in the technical Press during the years 1915-19. So many of these papers are of great value that it is difficult to select any one for special comment, but five by Dr. N. Campbell alone or in collaboration with Mr. C. C. Patterson illustrate so well the character of the scientific and industrial problems which the laboratory is called upon to solve that their nature may be indicated. They deal first with the present theory of the high-potential magneto, and show that it does not yet furnish a sufficiently firm basis on which to attempt improvements of the machine. They then consider the nature of the spark at the break in the primary of such a machine, and establish the fact that it is in reality an arc. Lastly, they deal with the effect of the spark discharge in igniting explosive mixtures such as those used in gas- and oil-engines, and show that the energy necessary to initiate an explosion is much less than that supplied in practice at the present time. At several points of the papers it is intimated that the research has been discontinued, and if this is the case it seems unfortunate for the gas-engine industry.

To facilitate the systematic testing of samples of dust from coal-mines made necessary by the Act of 1920, Messrs. A. Gallenkamp and Co. are supplying sets of apparatus (according to the designs of Mr. S. R. Illingworth, of the School of Mines, Treforest) which seem very well adapted for the purpose. The drying is effected in an oven, similar to that used by the U.S. Bureau of Mines, through which dry air is drawn so as to change completely the atmosphere round the samples every six minutes, the outer jacket containing water with 5 per cent. of glycerine. The roasting dishes are of silica with

aluminium lids, and they are inserted at one end of an electric muffle furnace so wound that the temperature gradually increases from front to back to prevent the coking of the freshly introduced samples. The burnt samples are withdrawn from a door at the back after they have stood for some time at the full temperature of 800-850° C. The roasting dishes stand on silica slabs, by which they are pushed in and withdrawn from the furnace. A scheme of weighing and heating two batches of samples alternately is suggested whereby twenty-four samples might be analysed by one chemist in a working day; if the apparatus enables this to be done—and the suggestion appears to be feasible—it will certainly be an improvement on present practice. The scheme of tests does not include the determination of carbon dioxide in "carbonate" dusts. These dusts are coming into use, and a small addition to the apparatus for this purpose might be desirable.

MR. R. D. DUNCAN, of the Radio Engineer Signal Corps of the U.S. Army, contributes a valuable paper on "wired radio" to the Journal of the Franklin Institute for January. By "wired radio" is meant simply the use of high-frequency currents superposed on ordinary telephone or telegraph lines to transmit speech or signals without interfering with the normal working of the line. One of the reasons for originating this research in America was an attempt to utilise the large quantity of radio-telephone apparatus which had been purchased during the war. One advantage of this system is that speech distortion, which causes so much trouble in long-distance wire telephony, is practically eliminated. The attenuation also is much less than had been anticipated. A very interesting and important application of the method is for establishing communication with a train in motion. Experiments carried out on the New York Central Railway are described. The telephone conductors which run parallel to the railway track were used to carry the high-frequency currents, and at the fixed station the transmitting and receiving apparatus were connected between the aerial wire and the earth. In the moving train the apparatus was connected to a closed loop which was placed at the proper angle to the plane of the telephone wires. Employing this system and using a high-frequency power of only two watts, excellent telephony was obtained up to a distance of ninety miles. It was noticed that the signals received in the train varied periodically in intensity when it was in motion. This phenomenon was traced to the existence of "standing waves" on the telephone line.

Engineering for February 18 contains a communication from the Metropolitan-Vickers Electrical Co., Ltd., which gives an explanation of the causes leading to the breakdown of a new 15,000-kw. turbo-alternator at Dalmarnock Station, Glasgow. The insulation on the windings at one end of the machine took fire on December 8, and the whole insulation on this end was destroyed. Another generator was nearly ready, and was installed and set to work one week later. After running for a week sparks were seen issuing from the top of the stator frame, and

the machine was shut down. Examination showed that one of the insulated bolts through the core had broken down near the end plate. These bolts pass through the core in an axial direction and serve to hold the end plates tightly against the laminations. Inspection of the bolts showed that vibration of a more or less serious nature had occurred on several of them. A series of tests revealed the fact that for the particular length and diameter of bolt used a relatively slight tension was sufficient to bring the frequency of the bolts to such a value as to synchronise with the frequency of the whole set, corresponding to the speed of 1500 r.p.m. Re-inspection of the first machine indicated that breakdown was due to the same trouble. A third machine with bolts of a modified design has been running since the end of December and has carried peak loads of 21,000 kw. The new type of bolt has a natural frequency very far below the running frequency of the machine.

IN the notice of a volume on "The Control of Parenthood" which appeared in NATURE for March 3 (pp. 5-6), the reviewer remarked that "Dr. Mary Scharlieb, the doctor of medicine, differs in emphatic terms from Dr. Marie Stopes, the doctor of science and philosophy." Dr. Stopes has written to express the opinion that these words will give readers the

impression that Dr. Mary Scharlieb's "antagonism to birth-control methods is based on medically determined detrimental effects of specified methods," whereas she holds that "under cover of the title of doctor of medicine Dr. Mary Scharlieb voices a religious conviction." We would prefer not to devote space to the difference between these points of view, but among the passages upon which our reviewer founded his statement is one on pp. 105-6 of the book noticed, and we refer Dr. Stopes to this in justification of his remark. But surely she is hasty in thinking that readers of NATURE will read into the meaning of the sentence solely the medical aspects of the subject (which she claims were not decided by the evidence before the Commission). Is it not much more likely that some readers will, as is their wont, see less and some more than the words justify, whilst others will see simply the literal meaning?

STUDENTS of India and the Far East should be interested in the latest catalogue (No. 411) of Mr. F. Edwards, 83 High Street, Marylebone, W.1, which gives particulars of some 1133 books, engravings, and drawings relating to India, Afghanistan, Ceylon, Burma, Tibet, Central Asia, Persia, etc. The catalogue will be sent free by the publisher upon request.

Our Astronomical Column.

THE FIREBALL OF MARCH 2.—Mr. W. F. Denning writes that further observations of this meteor have been received from Mr. Thomas Dick, of Purley, Surrey, Mr. G. Merton, of Woldingham, Surrey, and an observer in Hertfordshire. Mr. Merton did not observe the fireball in flight, but noticed the illumination it caused. He was about to observe a star in his telescope when the whole inside of the observatory was lit up for a few seconds, and he rightly concluded that a large meteor had fallen. From a comparison of all the observations it appears that the radiant point was at about $176^{\circ}+24^{\circ}$, and that the height of the meteor declined from 77 to 34 miles along a path of 61 miles, traversed at a velocity of 20 miles per second. Further observations of an exact character of the apparent course of the meteor amongst the stars would be valuable. It is to be hoped that in future years special attention will be given by meteoric observers to the first few nights of March, for past experiences amply testify to a special abundance of fireballs at this period.

THE ROTATION OF VENUS.—The problem of the rotation period of our nearest planetary neighbour has proved to be one of the most baffling of astronomical enigmas. Before Schiaparelli's announcement that it always turned one face to the sun, its period was supposed to differ little from that of the earth. Since then astronomers have been fairly equally divided between supporters of the short and of the long period.

In the last few weeks Prof. W. H. Pickering, who has been observing the planet in the clear and steady air of Mandeville, Jamaica, has put forward a new solution. He claims to have fixed the period as sixty-eight hours, the axis of rotation lying very nearly in the plane of the orbit, with which it makes an angle of only 4° or 5° . Such a bizarre arrangement does not strike one as probable *a priori*, in view of

the considerable tides which the sun raises on the planet. It prevails in the Uranian system, but the solar tides there are much feebler, since, *ceteris paribus*, they vary as the inverse cube of the distance from the tide-raising body. However, when Prof. Pickering's full evidence for his new period arrives it will be carefully studied, and will doubtless stimulate other observers to use their best endeavours to verify it.

A SIMPLIFIED CALENDAR REFORM.—In view of the difficulty of obtaining agreement on the vexed subject of calendar reform, the Rev. Emilio Fanfani, of Pavia, has published a pamphlet in which he reduces the proposed change to a minimum. His suggestion is to leave the lengths of the months the same as at present, but to put January 1, and in leap year February 29 also, outside the weekly reckoning, calling them simply New Year's Day and Leap Day. Thus the week-days would recur annually on the same calendar dates. The author further recommends that the present year 1921 should be taken as the standard, since Christmas occurs on a Sunday. Thus January 1, 1922, would be New Year's Day and January 2 Sunday, as in 1921. He further recommends the fixing of Easter on April 10, though this is not an essential part of his scheme.

This plan has the recommendation that the calculated dates of future astronomical events are unaffected, and no alteration of astronomical tables is involved. While it does not do all that calendar reformers desire, it is at least better than nothing, and would be a boon in fixing school terms, commercial transactions, the meeting of societies, etc.

Prof. Pio Emanuelli, of the Vatican Observatory, contributes a preface, in which he commends the project to the Commission on Calendar Reform constituted by the International Astronomical Union.

The Inheritance of Acquired Characters.

FOR a generation it has been a cardinal principle of thought and teaching with a majority of biologists that acquired characters are not inherited. Under the influence of Weismann and his doctrine of the independence of germ and soma this position has frequently been adopted even in its extreme form, that the inheritance of acquired characters is an impossibility. Botanists, on the other hand, have usually been less dogmatic on the subject, probably because in higher plants there is no such early segregation of germ-cells and somatic cells as occurs in many animals.

But in recent years new experiments have exhibited the problem in fresh lights, and the tendency to dogmatism which had grown up around the subject is fast disappearing. Prof. E. W. MacBride, in a trenchant article (*Science Progress*, January) which will mark a new stage in the discussion of this problem, subjects various aspects of Weismannism to a searching criticism, and shows how arguments which seemed so triumphantly unanswerable in Weismann's time are no longer in accord with the modern facts of experimental biology.

Perhaps the most fundamental of the defects of Weismannism as a philosophy of the organism was its foundation upon purely morphological conceptions of heredity, variation, and organic structure. While we shall always be indebted to him for the emphasis which he laid upon the chromosomes as a basis of heredity, yet a considerable part of the superstructure which he built on that foundation is no longer in accord with modern experiment. As Prof. MacBride points out, Weismann's view that the differentiation during ontogeny is the result of differential divisions of the chromosomes in mitosis is contrary to the evidence of both experimental embryology and cytology. Rather, the conclusion seems clear that all the nuclei of an organism are equipotential, the splitting of the chromosomes being, as it appears under the microscope, an equal one. If that is the case, then the nuclei may be looked upon as the conservative repositories of many at least of the differences which arise between species, while the mass divisions of the cytoplasm account for the greater part of the differentiation which takes place during development.

Another weakness in Weismannism which Prof. MacBride points out is the assumption that although the germ-cells of an organism might be affected by climate, they could not be modified by the fluids from the body-tissues in which they were immersed. The physiologists, by means of hormones, enzymes, antibodies, cytolytins, etc., have helped to rescue us from the untenable position that the germ-cells are completely insulated within the organism, and the work of various investigators has led us to see that germinal changes can be experimentally produced.

This does not, however, necessarily involve the principle of the inheritance of acquired characters, but it does render it reasonable to suppose that such inheritance may take place. The question then reduces itself to one of unprejudiced evidence, and on this point Prof. MacBride refers to the much-discussed investigations of Kammerer, whose results can now be contradicted only by imputing fraud, and to the perhaps even more important, because incontrovertible, evidence recently obtained by Messrs. Guyer and Smith (see article by Prof. Dendy in *NATURE* for February 3, p. 742) in producing a race of rabbits with defective eyes by the action of a cytolytin on the mother.

It is clear that the Lamarckian principle of use and disuse, as well as the various Neo-Lamarckian subtleties involving the inheritance of acquired characters, will have to be reckoned with seriously in future as an evolutionary factor. There is one point, however, in which we would venture to differ from Prof. MacBride, and that is with regard to the evolutionary significance to be attached to mutations. It is true that many of the mutations studied in plants and animals are more or less pathological or abnormal, and would stand a very poor chance of surviving in equal competition under wild conditions. On the theory of mutations this is to be expected, as well as the occurrence of many lethal factors such as are now known in *Drosophila* and *Oenothera*. But viable mutations, or even those which in some circumstances will have an advantage over the parent species, are by no means unknown. Bridges (*Biol. Bull.*, vol. xxxviii., p. 231) has recently described a mutation in *Drosophila* with white ocelli, which maintained itself in equal numbers in competition with the type in mass-culture for about 175 generations. The character-difference is here insignificant, but in wild species of plants there are innumerable records of single variations which have arisen and perpetuated themselves, having neither an advantage nor a disadvantage in competition with the parent species so far as can be determined.

Mutations are also by no means all *loss* characters. In the *Oenotheras* a series of forms is now known having a whole extra chromosome in their nuclei; and since the doubling of the whole series of chromosomes (tetraploidy) was investigated in *Oenothera gigas*, a large number of genera of plants have been found to contain tetraploid species, showing that this particular type of mutation is not only in a sense progressive, but has also taken part in the phylogeny of various genera and families.

May we not, then, suppose that mutation and the Lamarckian factor have both played their part in evolution, natural selection frequently coming in to adjudicate between mutations, while the Lamarckian factor has been at work in many cases of adaptation?

R. RUGGLES GATES.

Home-grown Wheat.

THE Ministry of Agriculture has instituted a campaign to secure by educational methods an increase in the wheat production of this country. An account of the addresses delivered in connection with this campaign by the principal of the Harper-Adams Agricultural College appeared in the Ministry's General Service for December 11 last. These addresses dealt with the subject from two points of

view: the need for stimulating production and the best methods of raising the average yield.

Though Great Britain obtains its wheat from many parts of the world, and it is scarcely conceivable that a shortage would occur through simultaneous failure of the crops in all these countries, yet it is imperative that our own yield should be increased, since the available figures from other producing countries and

the growing demands from nations which are becoming wheat-eaters all point to a reduced supply for Great Britain. That our production can be increased becomes evident from a comparison of the figures for different years, e.g. in 1868 16,733,000 quarters of wheat were produced compared with 6,677,000 quarters in 1920.

During the war patriotism was certainly one of the controlling factors in the production of home-grown wheat, but now that conditions are more or less normal price becomes the dominant factor. The Agriculture Act has considerably changed the position of the wheat-grower in this country, and with a free and uncontrolled market, as well as a guarantee against loss in the event of the world's price falling below the cost of production, the growing of wheat becomes an attractive scheme. The guarantee is based on the acreage sown, and not on the quantity of grain per acre, and the four-quarters-per-acre basis for the guarantee should be a stimulus to the light-land farmer to grow wheat, while on heavy land and "wheat-land" there is the stimulus of a higher return on account of the greater yields. Probably the best way to increase production is to raise the average yield per acre throughout the country.

The Harper-Adams Agricultural College has been carrying out tests for some years, and the results show what large differences exist between the yielding powers of different varieties. In a three-year average the "Standard" variety of wheat showed a yield of 33 bushels per acre, while "Svalof Iron" headed the list with 56 bushels per acre, so that it is obvious that by using some of the new higher yielding varieties the yield per acre could be considerably increased. At one time Great Britain boasted that her average wheat yield per acre was higher than that of any other country in the world, but the figures for 1910 show that we are now below other countries, the yield for Denmark being 47.5 bushels per acre against 29.1 bushels per acre in Great Britain.

Judicious manuring is one of the surest aids to increased yield, and even at present prices an increase of three bushels per acre amply repays the application of 1 cwt. of sulphate of ammonia. Other points to be considered are the time and the rate of sowing. All available experiments seem to favour the autumn-sown wheat, while it seems very probable that a big saving could be effected by reducing the amount of seed sown per acre.

Hydrography of the Nile Basin.

THE hydrographical data relating to the Nile and its upper reaches were published last year by the Public Works Ministry of Egypt in a report entitled "Nile Control," which was reviewed in these columns on December 30 last. The information was collected for the use of the Technical Commission which was appointed last year to report upon the various projects prepared by the Ministry for controlling and distributing the Nile waters in Egypt and the Sudan. The report of the Commission has now been published ("Report of the Nile Projects Commission," Cairo, 1920). The Commission consisted of two hydraulic engineers of wide experience, Mr. F. S. J. Gebbie, nominated by the Government of India, and Mr. H. F. Cory, nominated by the Government of the United States; also of Dr. G. C. Simpson, nominated by the University of Cambridge as a physicist whose scientific knowledge and experience were desired in connection with problems in water measurement. Criticism of the projects had been rife for many

months, and had culminated in a series of charges being brought against the Ministry of Public Works by Sir W. Willcocks and Col. Kennedy, in which falsification of data and suppression of records were alleged. More than half of the report is taken up by a consideration of these charges by the Commission, which has reported unanimously that there had been no falsification or any fraudulent manipulation of data.

Passing to the consideration of the technical merits of the projects for the dams at Gebel Aulia on the White Nile and at Sennar on the Blue Nile, for the barrage at Nag' Hamadi in Upper Egypt, for a dam on the upper reaches of the Blue Nile and for another on Lake Albert, the Commission reports wholly in favour of each of them. It does not consider that proposals for the construction of reservoirs in the marsh region of the White Nile are worthy of investigation. The further terms of reference, the allocation of the increased supply of available water and the apportionment of cost, produced a minority report from Mr. Cory. On the measurement of river discharges the Commission expresses the opinion that there is no other river in the world for which the discharge is so accurately determined as that of the Nile, and its report bears out what has been fully set out in "Nile Control," that the present-day needs of Egypt and the Sudan demand the highest precision in the control and distribution of the Nile water. The addition of a Physical Department to the Ministry of Public Works indicates that this has been recognised, and it is to be hoped that when a fuller measure of responsibility is placed upon Egyptian administrators they too will realise the necessity for maintaining the highest efficiency in all that concerns the scientific study of the hydrography of the Nile basin.

University and Educational Intelligence.

BIRMINGHAM.—Mr. John G. Garrett has been appointed lecturer and demonstrator in mine surveying, and Mr. John P. Rees lecturer in metal mining.

The following new members of the staff of Queen's Hospital have been appointed University clinical teachers:—Dr. Geoffrey Eden, assistant lecturer on clinical medicine and junior medical tutor, and Mr. W. Gemmill, assistant lecturer on clinical surgery.

EDINBURGH.—The committee organised in 1911 by the late Prof. MacGregor to promote a memorial to Prof. Tait in the form of a second chair of natural philosophy is now in a position to report to the subscribers and others interested that the Tait chair will shortly be established. The funds collected before the war have now been substantially augmented by sums from other sources, and the committee, after conferring with the University Court, has been informed by it that it will be possible to arrange for the foundation of the chair not later than the year 1925, by which time certain funds set aside by the University Court towards the endowment of the chair will have matured. In announcing this gratifying decision the Tait Memorial Committee believes that there are still many of Prof. Tait's former pupils and friends desirous of being associated in the promotion of this lasting memorial to a great natural philosopher. Further and immediate contributions will make it possible to inaugurate the Tait chair of natural philosophy before 1925. Further information may be obtained from the hon. secretary, Dr. C. G. Knott, University of Edinburgh.

GLASGOW.—The Lord Rector is *ex-officio* president of the University Court, and takes the chair at least once during his three years' term of office. On Friday, March 11, Mr. Bonar Law, after his installation in the forenoon, presided at a formal meeting of the Court. The business was of special interest, as testifying to the sympathy and support which the city has for many generations accorded to the University. Securities for 21,050*l.* were received from Sir D. M. Stevenson, Bart., ex-Lord Provost, for the foundation of a Citizenship Trust. The purpose of the Trust is to establish a Stevenson lectureship or chair analogous to the Gifford foundation, "to make provision in Glasgow for instruction in the rights, duties, and obligations of citizens in relation to the city, the State, and the commonwealth of nations; to promote study, inquiry, and research in subjects bearing on local government, national polity, and international comity; and thereby to emphasise the compatibility of civic or local with national patriotism, and of both with full and free international co-operation."

Lord Weir next presented to the Lord Rector a cheque for 30,200*l.* on behalf of the Institution of Engineers and Shipbuilders in Scotland. The sum had been contributed by members and friends of the institution by way of commemorating the centenary of the death of James Watt, formerly mathematical instrument maker to the University, for the purpose of increasing the facilities provided in the James Watt (University) laboratories for the scientific study of engineering. It is proposed to use the fund for the purpose of erecting into James Watt professorships the two lectureships in electrical engineering and in heat engines already established in the department. Lord Weir took the opportunity to announce that the institution had resolved to confer the rare distinction of its honorary membership on Mr. Bonar Law, "formerly iron merchant in Glasgow."

Lastly, it was intimated to the Court that the late Mr. Robert Wylie, chairman of Wylie and Lochhead, Ltd., had bequeathed the residue of his estate for the further endowment of the Regius chair of engineering and of engineering teaching in the James Watt laboratories of the University in commemoration of the benefits conferred on mankind by the labours of James Watt. He had also bequeathed his library of books relating to Glasgow, and all his engravings, etchings, and water-colour drawings. It is understood that the bequest, after the expiry of certain life-rents, will amount to a larger sum than any previous benefaction of the kind.

A large extension of the James Watt laboratories, in which the engineering department of the University is housed, is nearing completion. It has been rendered necessary by the great influx of students after the war. In October, 1920, many applicants had to be denied admission.

DR. F. C. THOMPSON, of the University of Sheffield, has been appointed to the chair of metallurgy in the University of Manchester.

THE PRINCE OF WALES will be present at the London University graduation dinner to be held at the Guildhall on May 5, and, as the recipient of the degrees of Doctor of Science and Master of Commerce, will respond to the toast of "The New Graduates."

ON June 28 the University of Durham will confer the honorary degree of D.Sc. upon Sir E. H. W. Tennyson-d'Eyncourt, director of naval construction at the Admiralty, and Prof. A. Meek, professor of zoology at Armstrong College, Newcastle-upon-Tyne.

NOTICE is given by the Royal Society of Medicine of the award in June next of the William Gibson

research scholarship of 250*l.* for two years for a qualified medical woman. Particulars may be obtained from the secretary of the society, 1 Wimpole Street, W.1.

ON Saturday last the University of Dublin conferred the honorary degree of Sc.D. upon Prof. W. M. Bayliss, professor of general physiology in University College, London; Prof. E. Borel, professor of the theory of functions at the Sorbonne, Paris; and Prof. A. A. Michelson, professor of physics in the University of Chicago.

APPLICATIONS are invited for the John Lucas Walker studentship in pathology in the University of Cambridge. The studentship is of the annual value of 300*l.* and tenable, under certain conditions, for three years. Candidates must be prepared to devote themselves to original research in pathology, and must send their applications, with copies of published work and references, before April 5 next to Prof. Sir German Woodhead, Pathological Laboratory, Medical School, Cambridge.

THE annual report of the Delegates for Forestry of the University of Oxford contains a record of the valuable work which has been accomplished at the school during the past year. More than 100 students, of whom 80 were first-year men, have been attending classes, and temporary assistance in the work of instruction was afforded by the loan of four officers, three of them from the Forestry Commission and one from the India Office. Practical work was undertaken in the Forest of Dean, High Meadow Woods, and Tintern Crown Forests, and in September a party of twenty-five students accompanied the professor on a tour through some of the forests of France. The scheme for raising plants for sale in the Bagley Forest Nursery was abandoned during the year on account of the high cost of labour, but the nursery will be maintained for raising plants for local use and for demonstration purposes. During the year thirty-six students qualified for the diploma in forestry, two of whom, we note, are ladies. The delegates also pay eloquent tribute to the work of Sir William Schlich, who has resigned his professorship after a tenure of fifteen years.

IN the annual report of the Commissioner of Education for the United States for the year ending June, 1920, brief summaries of progress in some phases of education in America are given, together with a short statement of the activities of the Bureau of Education. Formerly the annual report was printed in two large volumes, but four years ago it was decided to issue this form of report biennially and to supplement it with a brief annual sketch, such as the one before us of 134 pages. In the section dealing with higher education attention is directed to the large increase in the numbers of students receiving instruction and to the financial embarrassment in which most of the universities and colleges find themselves. A comparison of the total enrolments for the academic year 1916 with those of 1919 show an increase of 25 per cent. at the 250 institutions from which statistics were obtained. Reference is also made to the low salaries which are being paid at public and private institutions for higher education. Another point of interest is the introduction of general intelligence tests such as are used in the American Army as an alternative to entrance examinations, and it is estimated that some 200 colleges and universities are using such psychological tests. Attempts are also being made by co-operation with industrial associations to bring higher educational institutions into closer relations with the needs of the industries of the country.

Calendar of Scientific Pioneers.

March 17, 1771. Chester Moor Hall died.—An Essex landowner and a lawyer, Hall in 1733 was the first to construct an achromatic telescope.

March 17, 1782. Daniel Bernoulli died.—Trained as a mathematician by his brother Nicholas, Daniel Bernoulli added greatly to the fame of the family. Like Euler, his lifelong friend, he received no fewer than ten prizes from the Paris Academy of Sciences. His best-known work was that on hydrodynamics.

March 17, 1846. Friedrich Wilhelm Bessel died.—One of the greatest of astronomers, Bessel was director of the Königsberg Observatory, where he erected the first of Fraunhofer's heliometers. Among his most important labours were the reduction of Bradley's observations, the determination of the parallax of 61 Cygni, his two catalogues of stars, and in pure mathematics the invention of Bessel's functions.

March 17, 1853. Christian Doppler died.—Doppler was a professor of mathematics at Prague. In 1842, in a paper on the coloured light of double stars, he enunciated the well-known principle which bears his name.

March 18, 1871. Augustus de Morgan died.—The first professor of mathematics in University College, London, de Morgan exercised a great influence by his teaching and writings on mathematics and logic. He was deeply versed in the history of mathematics.

March 18, 1907. Pierre Eugène Marcellin Berthelot died.—Professor of organic chemistry in the Collège de France and secretary to the Paris Academy of Sciences, Berthelot made important researches in thermo-chemistry, explosives, and synthetic chemistry.

March 20, 1727. Sir Isaac Newton died.—Universally recognised as the world's greatest mathematical physicist, Newton was born on Christmas Day, 1642. In 1669 he became Lucasian professor of mathematics at Cambridge, in 1689 was elected Member of Parliament for the University, and in 1699 was made Master of the Mint. From 1703 until his death he was president of the Royal Society. His "Principia" was published in 1687. His grave is in the nave of Westminster Abbey, while his monument—the long inscription on which evoked a protest from Johnson—stands close by. The statue of Newton by Roubillac at Trinity College, Cambridge, bears the words: "Qui genus humanum ingenio superavit."

March 20, 1878. Julius Robert von Mayer died.—One of the founders of the science of thermodynamics, Mayer in 1841 settled at Heilbron as a physician, and his memoir on the mechanical theory of heat was published the following year.

March 21, 1762. Nicolas Louis de Lacaille died.—Lacaille was the first to measure an arc of meridian in South Africa. He published three catalogues of stars, the second of which was based on his work at the Cape of Good Hope in 1750-54.

March 22, 1772. John Canton died.—A private schoolmaster in Spitalfields, Canton was a keen experimentalist. He made improvements in electricity and demonstrated the compressibility of water.

March 23, 1899. Gustav Heinrich Wiedemann died.—The successor in 1877 of Poggenorf as editor of the *Annalen der Physik und Chemie*, Wiedemann was known for his accurate physical determinations and for his monumental work entitled "Die Lehre von der Elektrizität."
E. C. S.

Societies and Academies.

LONDON.

Linnean Society, February 17.—Dr. A. Smith Woodward, president, in the chair.—Prof. G. B. De Toni: A contribution to the teratology of the genus *Datura*, L. A hitherto unreported malformation of the flower of *D. stramonium*. A plant grown in the Botanical Garden at Modena produced flowers of two kinds; normal flowers appeared on the lower part of the plant and produced perfect capsules, but flowers produced in the upper part of the plant later in the year were barren.—Capt. J. Ramsbottom: The collection of plants made by various members of H.M. Salonika Forces. A plant-collecting competition amongst warrant officers, non-commissioned officers, and men was held. The result of the competition was satisfactory, as it also had the effect of centralising effort and attracting a considerable number of other collectors. The district in which the principal collectors were stationed was indicated on a map.—Dr. G. C. Druce: A short account of botanical work in the Shetlands. A *Plantago* from the north of Balta Sound, which may be compared to *P. maritima*, var. *minor*, Hook., renamed by Boswell Syme var. *hirsuta*, was discussed. *Cerastium subtetrandrum*, Murb., *Potamogeton suecicus*, C. Richt., *P. rutilus*, Wolfg., *Rhinanthus borealis*, Druce, and *Poa irrigata*, Lindm., are described as new to the flora. *Nitella nidifica*, Ag., found in the Loch of Stennes, and *Chara canescens*, H. and J. Groves, are new to the Scottish flora.

Geological Society, February 18.—Mr. R. D. Oldham, president, in the chair.—R. D. Oldham: Presidential address: Know your faults. The address was devoted to a consideration of the dangers of a loose use of words. The first instance taken was that of the common classification of faults as normal and reversed. It became generally accepted that normal faults in the technical sense were normal in the dictionary sense, though this is not always in accord with experience. Reversed faults were then considered. A consideration of possible modes of formation led to the conclusion that the words "upthrow" and "downthrow" indicate no more than the relative displacement of the two sides of the fault. Passing on to the word "overthrust," the president pointed out that it implied the two concepts that the upper block was thrust over the lower, and that its displacement was due to the action of some external fault. With regard to the former, there is no means of deciding, from observations within the area of the overthrust, whether the upper or the lower block had been displaced or had remained stationary. With regard to the latter, it was deduced that the movements must have taken place piecemeal, and that the cause must have been generated within the area affected. As it is difficult to conceive of any such action taking place in the dead matter of the upper block, the conclusion is suggested that the originating cause lay in the lower, and the "overthrust" becomes an "under-crawl."

February 23.—Mr. R. D. Oldham, president, in the chair.—Prof. W. J. Sollas: *Saccammina Carteri*, Brady, and the minute structure of the Foraminiferal test. An investigation was made into the composition and structure of the test in the vitreous and porcellanous Foraminifera. In both groups the substance of the test consists wholly of calcite. The distinctive difference lies in the granular and felted structure which characterises the porcellana. Perforate Foraminifera and porcellanous forms occurring in association with *Saccammina* retain the original

structure of their tests; the structure of *Saccamina* is not inconsistent with that of the arenaceous Foraminifera, and thus one is led to assign this fossil to the group originally proposed for it by Brady.—Dr. T. S. Wilson: Notes on the views of the late Prof. Charles Lapworth with regard to spiral movements in rocks during elevation or depression. During Prof. Lapworth's only visit to Wengen Alp, near Lauterbrunnen, he was able to infer the presence of rock-circles (due to spiral movements) some hundreds of feet up the hillside. Prof. Lapworth's theory of wave-movement is applied to solids, and the type of deformation which a cube would undergo if acted upon by wave-crests and wave-troughs from three different directions is discussed. By this method of investigation it is possible to demonstrate the conditions under which shearing would take place in the centre of the cube, along the main septal line between the positive and the negative portion of the fold.

Association of Economic Biologists, March 11.—Sir David Prain in the chair.—Dr. J. Davidson: The cells of plant tissues in relation to cell-sap as the food of Aphids. After describing the sucking apparatus of Aphids, the relation of the stylet to the plant tissues was considered, particular regard being paid to the course of the puncture, the effect upon the cell contents, the tissues affected, and the food value of saps at different ages of the plant. The very interesting relation between the size of Aphids upon various food-plants was discussed in the light of the difficulties that this introduces in specific determinations.—E. R. Speyer: Ceylon Ambrosia beetles and their relation to problems of plant physiology. Of the sixty-six Scolytid beetles in Ceylon associated with Ambrosia fungi, thirty-two belong to the genus *Xyleborus*. The bionomics of these beetles was briefly described, and an account given, illustrated by very fine specimens, of the tunnelling they make in their host trees. The pure cultures of degenerate Ascomycetous fungi maintained by the insects in their tunnels were described, each species of beetle having its own particular fungus, and a number of hypotheses were advanced to explain them. The paper closed with a brief review of the various insect groups which are known to cultivate fungi and of the organisms maintained.

EDINBURGH.

Royal Society, March 7.—Prof. F. O. Bower, president, in the chair.—Prof. A. R. Horne: A graphical method of determining shear influence lines and diagrams of maximum shearing force for a beam subjected to a series of concentrated rolling loads. The paper describes a graphical method of constructing shear influence lines. These lines are of importance to civil engineers in connection with the design of railway bridges and other structures which are subjected to rolling loads. They are of special importance in structures of reinforced concrete. Up to the present it has been the practice to determine these influence lines by calculation, which process becomes very laborious when the number of loads is considerable, as, for example, in the case of the wheel loads of a locomotive. The method is extended to make possible the determination of the maximum shearing force which occurs at each section in the length of the bridge or structure without any calculation being necessary.—Dr. J. M'L. Thompson: Studies in floral morphology. No. 2: The staminal zygomorphy of *Couroupita guianensis*, Aubl. In this communication the development of the remarkable lopsidedness of the flowers of *Couroupita* (the cannon-ball tree) is described. A general description of the tree itself

is provided from the author's observations in Jamaica, and the crowded inflorescences and massive spherical fruits are illustrated. It is shown that the most conspicuous floral features of *Couroupita* are due to the separation of the male organs into two portions during development. The first is a fleshy ring round the style and bearing numerous short stamens, all of which produce small pollen-grains. The second is a long, strap-shaped, fleshy structure which is borne on the outer side of the flower. It ends in a massive ovoid body hanging over the centre of the flower, and carries long, fleshy stamens which produce large pollen-grains. It is this large, fleshy body which is the chief cause of the lopsidedness of the flowers. In the course of its development it assumes remarkable features. At an early stage its component cells become very large compared with those of the remaining male organs. A cellular gigantism is thus begun which is maintained throughout its entire history. It is to this cellular gigantism and to the active growth which accompanies it that the lopsidedness or zygomorphy of the stamens is due. The communication was illustrated by photographs and drawings showing the habit of the cannon-ball tree and the structure of its flowers and fruits, and formed the preface to a general study of the floral characters of the genera with which *Couroupita* is allied.

PARIS.

Academy of Sciences, February 21.—M. Georges Lemoine in the chair.—H. Deslandres and V. Burson: Researches on the atmosphere of stars. The recognition of stars which show the same bright lines as are observed in the sun. As the result of a search for bright chromospheric lines in stars, particularly in stars of the F, G, and K types, the K_2 and H_2 lines have been detected in eight stars and the K_2 line alone in two others, and a list of these stars is given. Only one of these, α Auriga, is of the solar G type.—P. Termier and L. Joleaud: The overlapping fragments of Propiac (Drôme), evidence of a great sheet of alpine origin, pushed, before the Miocene, on to the valley of the Rhône.—F. Widal and P. Valléry-Radot: Desensibilisation and resensibilisation at will in a patient anaphylactised to antipyrine.—G. Gouy: Aplanetism and the law of sines.—C. Guichard: Certain networks which occur in the study of the congruences belonging to a linear complex.—M. de Sparre: Calculation of the ram stroke in a pipe supplying a turbine with strong reaction.—P. Vuillemin: Endogenous zygomorphy in flowers normally actinomorphic.—Sir Ernest Rutherford was elected a correspondent of the Academy for the section of general physics in succession to A. Michelson, elected foreign associate, and Jules Bordet correspondent for the section of medicine and surgery in succession to the late Pierre Morat.—R. Wavre: An equation of Fredholm in the complex domain and its application to the theory of systems of linear equations with an infinity of unknowns.—B. Delaunay: The solution of the indeterminate equation

$$qX^2 - pX^2Y + nXY^2 + Y^3 = 1.$$

—G. Bouligand: Certain modes of determination of the solutions of $\Delta u = \omega^2 u$.—M. Holweck: The absorption of X-rays of great wave-length. Connection between the X-rays and light.—G. Claude: The synthesis of ammonia under very high pressure: the present state of the experiments. In January, 1920, several members of the Academy saw the first working plant outside the laboratory; it produced 6 to 7 litres of liquid ammonia per hour. After various changes in the catalysers, at a second visit on Novem-

ber 20, 1920, the production was 60 to 70 litres of liquid ammonia per hour, or 1.25 tons per day. A compressor has now been built capable of compressing 700 cubic metres of the gas mixture per hour to 900 atmospheres, equivalent to 5 tons of anhydrous ammonia per day.—A. **Portevin**: The electrical resistance of the nickel-steels. A comparison of the resistances of a series of nickel-steels published by the author in 1909 with the measurements given later by O. Boudouard for a similar series shows that the figures are, in general, concordant, except in certain alloys which present large differences. It is now shown that the heat treatment is not without influence on the resistance, the same bar giving different figures according as it was allowed to cool down from 1000° C. in four hours or three days.—A. **Damiens**: Contribution to the study of the system iodine-tellurium. Study of the evaporation. The results confirm the conclusions given in earlier communications based on thermal or metallographic analysis. No evidence of the existence of a tellurium sub-iodide was obtained.—M. **Chopin**: Relations between the mechanical properties of dough and the lightness of the bread produced from it.—J. **Bougault** and P. **Robin**: The iodamidines. Benziodamidine undergoes an unexpected reaction when treated with acetic anhydride, a compound of the latter with benzdi-iodamidine being produced. This is stable in air, but is instantly decomposed by water with liberation of iodine.—A. **Guébbard**: The orthogonality of the systems of ridges of the earth's crust.—R. **Chudeau**: The ancient hydrography of the Sahara.—L. **Cayeux**: The idea of a general submarine metamorphism deduced from the alteration of the Jurassic oolitic iron minerals, contemporary with their deposit.—P. **Glangeaud**: The earthquake of October 3, 1920, which affected a large part of the volcanic regions of the Central Massif. This earthquake was not severe; the second shock, at 4.57 a.m., woke the population and caused oscillations of walls and furniture and the ringing of church bells, but little damage resulted. Earlier seismic disturbances (June to December, 1913) in the same region are recalled, and another, more severe, in August, 1892.—P. **Négris**: The subsidence of the Mediterranean coasts of France.—A. **Briquet**: The lowlands of Picardy south of the Somme.—J. **Pavillard**: The reproduction of *Chaetoceros Eibonii*.—P. **Delauney**: New researches concerning the extraction of the glucosides in some indigenous orchids; the identification of these glucosides with loroglossin. This glucoside has been shown to be present in *Cephalanthera grandiflora*, *Ophrys apifera*, and *Orchis bifolia*. Its identity with the loroglossin extracted by Bourquelot and Bridel from *Loroglossum hircinum* was proved by direct comparison of the melting points and by its reactions.—M. **Molliard**: The teratological phenomena occurring in the floral apparatus of the carrot as the result of injuries.—H. **Harlé**: A double curve representing very exactly sphygmometric oscillations.—MM. **Chaffard**, P. **Brodin**, and **Grigaut**: The arrest of uric acid in the liver. During digestion a proportion up to 50 per cent. of the uric acid entering by the portal vein is retained by the liver. If the animal is fasting, the proportion of uric acid in the blood entering and leaving the liver is unaltered.—A. **Dehorne**: The meiotic process in the spermatogenesis of the salamander and the triton.—C. **Champy**: The correlations between the male sexual characters and the various elements of the testicle in amphibians. Study of *Triton alpestris*.—Anna **Drzewina** and G. **Bohn**: Variations of susceptibility to harmful agents with the number of animals treated.—E. **Rabaud**: Variations in instinct and their production at will in various spiders.—P. **Lesne**: A breeding-ground of

the fruit-fly (*Ceratitis capitata*) in the neighbourhood of Paris. In 1900, 1906, 1914, and 1919 the larvæ of *Ceratitis* were found in late pears at Asnières and Courbevoie, from which it would appear that this insect, originating in tropical countries, has become acclimatised near Paris.—E. **Kayser**: The influence of luminous radiations on azobacter.—H. **Spahlinger**: The treatment of human tuberculosis.—M. **Rappin**: Vaccination in tuberculosis.

WASHINGTON, D.C.

National Academy of Sciences (Proceedings, vol. vi., No. 6, June, 1920).—R. **Pearl** and L. J. **Reed**: The rate of growth of the population of the United States since 1790 and its mathematical representation. Parabolic, logarithmic, and exponential curves of population are discussed, the last giving a particularly close fit and, presumably, being better suited to prediction by extrapolation.—A. G. **Webster**: The Springfield rifle and the Leduc formula. The rifle gives results in accordance with the formula.—T. B. **Johnson**, A. J. **Hill**, and E. B. **Kelsey**: Alkyl amides of isothiocyanetic acid. A report of a practical method of synthesis by which anilides of isothiocyanetic acid may be obtained. It seems safe to conclude that any isothiocyanate formed by interaction of potassium thiocyanate with a secondary chloroacetanilide will be unstable.—H. **Shapley**: Studies of magnitudes in star clusters. XI.: Frequency curves of the absolute magnitude and colour index for 1152 giant stars. The clusters the stars of which are included in the discussion of absolute magnitude are Messier 3, 5, 11, 13, 15, 30, and 68 and N.G.C. 4147 and 7006. The present study is limited to stars brighter than zero magnitude. For the luminosity curves it is restricted to Messier 3, 11, and 13. The results have many points of interest.—T. H. **Gronwall**: The distortion in conformal mapping when the second coefficient in the mapping function has an assigned value.—A. G. **Webster**: The connection of the specific heats with the equation of state of a gas. A critical discussion of the statement that if a fluid obeys a characteristic equation of the form $V=F(P/T)$, the specific heats are independent of the pressure.—F. E. **Bartell**: Anomalous osmose. Anomalous pressures are those which do not conform to the gas law; they may be greater or less than the normal values, and abnormality may be so great as to result in so-called negative osmose. Hypotheses as to the electrical states which may be associated with the membrane system and may account for abnormal osmotic effects are discussed.—A. L. **Foley**: A photographic method of finding the instantaneous velocity of sound-waves at points near the source. The variation of the velocity from 666 metres per second to 380 metres is observed.—T. H. **Gronwall**: Conformal mapping of a family of real conics on another.—S. **Wright**: The relative importance of heredity and environment in determining the piebald pattern of guinea-pigs. A detailed analysis of an extensive series of experiments carried on by the Bureau of Animal Industry since 1906. In the control stock, variations in pattern are determined to about 42 per cent. by heredity and 58 per cent. by irregularity in development, leaving nothing for tangible environmental factors. In the inbred family the corresponding figures are 3 per cent. for heredity, 5 per cent. for tangible environment, and 92 per cent. for irregularity in development. The figures for the mean square deviations check well with theory.—E. W. **Berry**: Fossil plants from the Late Cretaceous of Tennessee. The present discoveries disclose the remains of 124 species complete enough for descriptive purposes, of which 86 are new to science.

Books Received.

Shasta of the Wolves. By Olaf Baker. Pp. vii+276. (London and Sydney: G. G. Harrap and Co., Ltd.) 6s. net.

Anthracene and Anthraquinone. By E. de Barry Barnett. Pp. xi+436. (London: Baillière, Tindall and Cox.) 25s. net.

Fornander Collection of Hawaiian Antiquities and Folk-Lore. By A. Fornander. Third series. Part iii. Pp. iii+359-546. (Honolulu: Bernice Pauahi Bishop Museum.)

Ammonia and the Nitrides: With Special Reference to their Synthesis. By Dr. Edward B. Maxted. Pp. viii+116. (London: J. and A. Churchill.) 7s. 6d. net.

Cocoa and Chocolate: Their Chemistry and Manufacture. By R. Whymper. Revised and enlarged second edition. Pp. xxi+568+xv plates. (London: J. and A. Churchill.) 42s. net.

Lectures on the Principle of Symmetry and its Applications in all Natural Sciences. By Prof. F. M. Jaeger. Second edition. Pp. xii+348. (Amsterdam: "Elsevier" Publishing Co.)

Vorlesungen über Vergleichende Anatomie. 3. Lieferung: Sinnesorgane und Leuchtorgane. By Prof. Otto Butschli. Pp. iii+643-931+xiv. (Berlin: J. Springer.) 48 marks.

Hygiene. By J. Lane Nottter and R. H. Firth. Ninth edition. Pp. xii+540. (London: Longmans, Green and Co.) 10s. 6d. net.

Monographien über die Zeugung beim Menschen. By Dr. Hermann Rohleder. Band v., Die Zeugung bei Hermaphroditen, Kryptorchien, Mikrororchien und Kastraten. Pp. x+143. Band vii., Die künstliche Zeugung (Befruchtung) im Tierreich. Pp. x+128. (Leipzig: G. Thieme.) 42 marks each vol.

Elementary Notes on Conifers. By A. H. Church. (Botanical Memoirs, No. 8.) Pp. 32. (London: Oxford University Press.) 2s. net.

Form-Factors in Coniferæ. By A. H. Church. (Botanical Memoirs, No. 9.) Pp. 28. (London: Oxford University Press.) 2s. net.

The Somatic Organization of the Phæophyceæ. By A. H. Church. (Botanical Memoirs, No. 10.) Pp. 110. (London: Oxford University Press.) 5s. net.

The Origin and Problem of Life: A Psycho-Physiological Study. By A. E. Baines. Pp. xii+97. (London: G. Routledge and Sons, Ltd.; New York: E. P. Dutton and Co.) 3s. 6d. net.

Tables of Physical and Chemical Constants and some Mathematical Functions. By Dr. G. W. C. Kaye and Prof. T. H. Laby. Fourth edition. Pp. vii+161. (London: Longmans, Green and Co.) 14s. net.

Silica and the Silicates. By James A. Audley. (Industrial Chemistry.) Pp. xiv+374. (London: Baillière, Tindall and Cox.) 15s. net.

Analysis of Paint Vehicles, Japans, and Varnishes. By Prof. C. D. Hollev. Pp. ix+203. (New York: J. Wiley and Sons, Inc.; London: Chapman and Hall, Ltd.) 13s. 6d. net.

Prevention of Venereal Disease. (Being the Report of and the Evidence Taken by the Special Committee on Venereal Disease.) Pp. xxxv+236. (London: Williams and Norgate.) 21s. net.

Memoirs of the Geological Survey: England and Wales. The Water Supply of Norfolk from Underground Sources. By William Whitaker. Pp. iv+18z. (London: H.M. Stationery Office.) 10s. net.

The Carnegie United Kingdom Trust. Seventh Annual Report (for the Year ending 31st December, 1920). Pp. iii+62. (East Port, Dunfermline.)

A Practical Handbook of British Birds. Part x. Pp. 81-176. (London: Witherby and Co.) 4s. 6d. net.

Radioaktivität und die Neueste Entwicklung der Lehre von den Chemischen Elementen. By Prof. K. Fajans. Dritte auflage. (Sammlung Vieweg, Haft 45.) Pp. viii+124. (Braunschweig: F. Vieweg und Sohn.) 6.50 marks.

Grundzüge der Einsteinschen Relativitätstheorie. By Prof. August Kopff. Pp. viii+198. (Leipzig: S. Hirzel.) 36 marks.

Edina Geographies. By T. Franklin. Book i.: The British Isles. Pp. 64. 1s. 8d. net. Book ii.: Europe. Pp. 72. 1s. 9d. net. (Edinburgh: W. and A. K. Johnston, Ltd.; London: Macmillan and Co., Ltd.)

A Little Book on Map Projection. By Mary Adams (Dr. W. Garnett). New and revised edition. Pp. viii+112. (London: G. Philip and Son, Ltd.; Liverpool: Philip, Son and Nephew, Ltd.) 5s. 6d. net.

Quaker Aspects of Truth. By Dr. E. Vipont Brown. Pp. 156. (London: The Swarthmore Press, Ltd.) 5s. net.

The Coco-Nut. By Prof. Edwin B. Copeland. Second edition, revised. Pp. xvi+225. (London: Macmillan and Co., Ltd.) 20s. net.

Pure Thought and the Riddle of the Universe. By Francis Sedlak. Vol. i.: Creation of Heaven and Earth. Pp. xv+375. (London: G. Allen and Unwin, Ltd.) 18s. net.

Society for the Preservation of the Fauna of the Empire Journal. New Series. Part. i. Pp. 74. (London: A. L. Humphreys.) 2s. 6d. net.

High-Tension Switchgear. By Henry E. Poole. (Technical Primers.) Pp. ix+118. (London: Sir I. Pitman and Sons, Ltd.) 2s. 6d. net.

Annual Reports on the Progress of Chemistry for 1920. Issued by the Chemical Society. Vol. xvii. Pp. x+264. (London: Gurney and Jackson.) 7s. 6d. net.

Education and World Citizenship. An Essay towards a Science of Education. By J. C. Maxwell Garnett. Pp. x+515. (Cambridge: At the University Press.) 36s. net.

Dictionary of British Scientific Instruments. Issued by the British Optical Instrument Manufacturers' Association. Pp. xii+335. (London: Constable and Co., Ltd.) 21s.

Diary of Societies.

THURSDAY, MARCH 17.

INSTITUTION OF NAVAL ARCHITECTS (at Royal United Service Institution), at 11.—R. J. Walker and S. S. Cook: Mechanical Gears of Double Reduction for Merchant Ships.—E. W. Blockidge: Life-saving Appliances on Cargo and Passenger Vessels.—M. E. Denny: The Design of Balanced Rudders of the Spade Type.

INSTITUTION OF NAVAL ARCHITECTS (at Royal United Service Institution), at 3.—H. B. W. Evans: Standardisation of Data for Airship Calculations.

ROYAL INSTITUTION OF GREAT BRITAIN, at 3.—Dr. G. C. Simpson: The Meteorology of the Antarctic.

CHEMICAL SOCIETY (Annual General Meeting), at 4.

ROYAL SOCIETY, at 4.30.—Lord Rayleigh: The Colour of the Light from the Night Sky.—R. O. Street: The Dissipation of Energy in Permanent Ocean Currents, with Some Relations between Salinities, Temperatures, and Currents.—S. Datta: The Vacuum Arc Spectra of Sodium and Potassium.—W. E. Garner and C. L. Abernethy: Heats of Combustion and Formation of Nitro-compounds. Part I. Benzene, Toluene, Phenol, and Methylamine Series.—E. K. Rideal: The Catalytic Dehydrogenation of Alcohols.

ROYAL COLLEGE OF PHYSICIANS OF LONDON, at 5.—Dr. A. Whitfield: Some Points in the Etiology of Skin Diseases (Lumleian Lectures).

LINNEAN SOCIETY, at 5.—W. B. Alexander: The Vertebrate Fauna of Houtman Abrolhos Islands, West Australia.—Prof. P. Fauvel: Annelides Polychètes de l'Archipel Houtman Abrolhos recueillies,

Prof. W. J. Dakin.—F. Chapman: Sherbornina: A New Genus of Foraminifera from Table Cape, Tasmania.
 ROYAL SOCIETY OF MEDICINE (Dermatology Section), at 5.—T. C. Benians: The Presence of Catalytic Enzymes as an Aid to Diagnosis of Hair Infections.
 ROYAL AERONAUTICAL SOCIETY (at Royal Society of Arts), at 5.30.—Capt. D. Nicolson: Flying-Boat Construction.
 INSTITUTION OF MINING AND METALLURGY (at Geological Society), at 5.30.—E. H. Clifford: Scheme for Working the City Deep Mine at a Depth of 7000 feet (adjourned discussion).—A. E. Pettit: Notes and Records of Mining Costs.
 INSTITUTION OF ELECTRICAL ENGINEERS (at Institution of Civil Engineers), at 6.—Sir William Noble: The Long-distance Telephone System of the United Kingdom.
 INSTITUTION OF CIVIL ENGINEERS (Students' Meeting), at 6.30.—J. T. Chalk: Continuous Beams.
 INSTITUTION OF AUTOMOBILE ENGINEERS (London Graduates' Meeting) (at 23 Victoria Street), at 7.30.—H. B. Benny and D. J. Macklin: Modern Tendencies in Automobile Engine Design.
 SOCIETY OF ARCHITECTS (at 28 Bedford Square), at 8.—H. Bagenal: Acoustics.
 ILLUMINATING ENGINEERING SOCIETY (at Royal Society of Arts), at 8.—Major A. Garrard and Others: Motor-Car Headlights: Ideal Requirements and Practical Solutions.
 INSTITUTION OF NAVAL ARCHITECTS (at Royal United Service Institution), at 8.—Prof. T. B. Abell: A Study of the Framing of Ships.
 RÖNTGEN SOCIETY (in Architecture Theatre, University College), at 8.15.—Dr. E. A. Owen and Miss Phyllis K. Bowes: X-Ray Dosage, with Special Reference to the Barium Platino-cyanide Pastille.
 HARVEIAN SOCIETY (at Town Hall, Paddington Green), at 8.30.—Dr. L. Williams: The Thymus Gland in Everyday Life.

FRIDAY, MARCH 18.

INSTITUTION OF NAVAL ARCHITECTS (at Royal United Service Institution), at 11.—K. G. Finlay: The Spacing of Transverse Bulkheads.—A. M. Robb: Deflections of Bulkheads and of Ships.—J. J. King-Salter: Some Experiments on Tallows in their Use for the Launching of Ships.
 ROYAL SOCIETY OF MEDICINE (Otolaryngology Section), at 5.—J. Faulder and Mr. Colledge: Ears under Modern War Conditions.
 MONTESSORI SOCIETY (at University College), at 5.45.—F. Watts: Common Sense about Intelligence Testing.
 INSTITUTION OF MECHANICAL ENGINEERS, at 6.—Prof. E. G. Coker, K. C. Chakko, and M. S. Ahmed: Contact Pressures and Stresses.
 JUNIOR INSTITUTION OF ENGINEERS, at 8.—T. E. Dimbleby: Hand-operated Appliances for Lifting and Transporting, with Particular Reference to Application in Awkward Circumstances.
 ROYAL SOCIETY OF TROPICAL MEDICINE AND HYGIENE (at Royal Army Medical College, Grosvenor Road), at 8.15.—Col. P. S. Lelean: Models of Some Sanitary Devices for the Tropics.—Lt.-Col. J. C. Kennedy: The Pathological Histology of Tropical Sore.—Lt.-Col. H. Marrian Perry: A Helminthic Infection in Relation to Bacterial Invasion of Tissues.—Major F. N. Coppinger: Preliminary Work in Connection with Detoxicated Dysentery Vaccines.—Dr. J. G. Thomson and Dr. A. Robertson: Association of Charcot-Leyden Crystals with *Entamoeba histolytica*.—Dr. H. St. J. Brooks: *Leptospira icterodes* and *Leptospira icterohaemorrhagiae*.—Dr. P. Manson-Bahr: *Bacillus coli* Infections of Tissues.—Miss E. M. Baxter and Dr. A. J. Eagleton: Can Syringes be Sterilised by Means of Oil?—Dr. A. Castellani and Dr. F. E. Taylor: Identification of Sugars and Other Carbohydrates by a Micrological Method.—C. A. Hoare: Demonstration of Trypanosomiasis of British Sheep.—Lt.-Col. S. P. James: A Case of Leprosy.
 ROYAL SOCIETY OF MEDICINE (Electro-Therapeutics Section), at 8.30.—Prof. W. D. Halliburton: Physiological Advance: The Importance of the Infinitely Little (The Mackenzie-Davidson Memorial Lecture).
 ROYAL INSTITUTION OF GREAT BRITAIN, at 9.—Sir Frederick Bridge: The Researches of a Musical Antiquarian.

SATURDAY, MARCH 19.

BRITISH MYCOLOGICAL SOCIETY (in Botany Lecture Theatre, University College), at 11.—Dr. W. Brown: Studies in the Physiology of Parasitism.—A. D. Cotton: The Ministry of Agriculture's Plant Disease Survey.—Dr. P. Haas: The Use of Carrageen in Place of Agar as a Culture Medium.—Miss A. Lorrain Smith: Lichens and Transmigration.—Mrs. N. L. Alcock: Rhizoctonia Disease of Scots Fir.—Dr. A. S. Horne: A Polymorphic Apophæria.—R. Paulson: Protococcus as the Conidium of a Lichen.
 ROYAL INSTITUTION OF GREAT BRITAIN, at 3.—Sir Ernest Rutherford: Electricity and Matter.

MONDAY, MARCH 21.

INSTITUTE OF ACTUARIES, at 5.—G. S. W. Epps: Superannuation Funds.
 ROYAL SOCIETY OF ARTS, at 8.—Major G. W. C. Kaye: X-rays and their Industrial Applications.
 CHEMICAL INDUSTRY CLUB (at 2 Whitehall Court), at 8.—Dr. W. R. Ormandy and Others: Discussion on Electric Shadows and Wireless Telegraphy.
 ROYAL SOCIETY OF MEDICINE (Odontology Section), at 8.—J. G. Turner: The Relation of Dental Sepsis to Rheumatism and Allied Conditions.
 ROYAL GEOGRAPHICAL SOCIETY (at Æolian Hall), at 8.30.

TUESDAY, MARCH 22.

ROYAL HORTICULTURAL SOCIETY, at 3.—Mrs. Arber: Some Early Herbals.
 INSTITUTION OF CIVIL ENGINEERS, at 5.30.—A. Peake: The Southern and Western Suburbs Ocean Outfall Sewer, Sydney, New South Wales.—W. E. Bush: The Main Drainage of Auckland.

ROYAL SOCIETY OF MEDICINE (Medicine Section), at 5.30.—Dr. Parkes Weber: Thrombosis of the Inferior Vena Cava and Both Renal Veins.—Dr. Nathan Raw: The Treatment of Tuberculosis with Attenuated Tubercle Vaccines.

MINERALOGICAL SOCIETY (at Geological Society), at 5.30.—Dr. G. F. Herbert Smith: Linarite, Caledonite, and Associated Minerals from Cornwall.—Prof. H. Hilton: The Vibrations of a Crystalline Medium.—Prof. R. Ohashi: Augite from Nishigatake, Hizen, Kiu-shu, Japan.—Dr. G. T. Prior: The Adare and Ensisheim Meteorites.—W. Barlow: Model Representing the Atomic Structure of Calcite and Aragonite.

ZOOLOGICAL SOCIETY OF LONDON, at 5.30.—The Secretary: Report on the Additions to the Society's Menagerie during the month of February, 1921.—Prof. J. Cossar Ewart: The Nestling Feathers of the Mallard, with Observations on the Composition, Origin, and History of Feathers.—E. T. Newton: Fossil Bird-remains from Sardinia, Corsica, and Greece, collected by Dr. Forsyth Major.—G. C. Robson: The Molluscan Genus *Cochlitoma* and its Anatomy, with Remarks upon the Variation of Two Closely-allied Forms.—H. E. Andrews: The Oriental Species of the Genus *Callistomimus* (Coleoptera, Carabidae).

BRITISH PSYCHOLOGICAL SOCIETY (Education Section) (at London Day Training College), at 6.—Miss Barbara Low: Psycho-Analysis and the Educator.

ROYAL PHOTOGRAPHIC SOCIETY OF GREAT BRITAIN, at 7.—V. Poliakov and Dr. C. T. Hagberg Wright: Russia: Past and Present.

FARADAY SOCIETY (at Chemical Society), at 8.—Prof. A. W. Porter: Some Aspects of the Scientific Work of the late Lord Rayleigh (Presidential Address).—W. E. Hughes: The Forms of Electro-deposited Iron and the Effect of Acid upon its Structure. Part I. Deposits from the Chloride Bath.—S. Field: The Electrolytic Recovery of Zinc.—Prof. A. Findlay and V. H. Williams: Notes on the Electrolytic Reduction of Glucose.

ROYAL ANTHROPOLOGICAL INSTITUTE, at 8.15.—Dr. F. G. Crookshank: The Significance of Mongolian Imbecility.

WEDNESDAY, MARCH 23.

GEOLOGICAL SOCIETY, at 5.30.—E. B. Bailey: The Structure of the South-West Highlands of Scotland.

CONTENTS.

	PAGE
University Grants and Needs	65
Meteorological Physics. By Sir Napier Shaw, F.R.S.	66
New American Text-books of Botany. By M. D.	69
Theban Tombs. By Prof. W. M. Flinders Petrie	70
Our Bookshelf	70
Letters to the Editor:—	
The International Research Council.—Sir Arthur Schuster, F.R.S.	72
The Constitution of the Alkali Metals.—Dr. F. W. Aston	72
The Designation of Vitamines.—Prof. Henry E. Armstrong, F.R.S.	72
Relativity and the Velocity of Light.—Sir Oliver Lodge, F.R.S.	73
The Peltier Effect and Low-temperature Research.—Sir Oliver Lodge, F.R.S.	73
The Nature of the Emulsoid Colloid State.—Dr. S. E. Sheppard; Prof. James W. McBain	73
The Production of Living <i>Clavellina</i> Zooids in Winter by Experiment.—Dr. J. H. Orton	75
The Elementary Particle of Positive Electricity.—Prof. Andrew H. Patterson	75
New Studies of Sun-fishes made during the "Dana" Expedition, 1920. (Illustrated.) By Dr. Johs. Schmidt	76
Electrons. (With Diagram.) By Sir William Bragg, K.B.E., F.R.S.	79
Obituary:—	
The Rt. Hon. Lord Moulton of Bank, F.R.S. By Dr. R. C. Farmer	82
Baron T. Kikuchi. By E. R.	83
Notes	84
Our Astronomical Column:—	
The Fireball of March 2	88
The Rotation of Venus	88
A Simplified Calendar Reform	88
The Inheritance of Acquired Characters. By Dr. R. Ruggles Gates	89
Home-grown Wheat	89
Hydrography of the Nile Basin	90
University and Educational Intelligence	90
Calendar of Scientific Pioneers	92
Societies and Academies	92
Books Received	95
Diary of Societies	95



THURSDAY, MARCH 24, 1921.

Editorial and Publishing Offices:

MACMILLAN & CO., LTD.,

ST. MARTIN'S STREET, LONDON, W.C.2.

Advertisements and business letters should be
addressed to the Publishers.

Editorial communications to the Editor.

Telegraphic Address: PHUSIS, LONDON.

Telephone Number: GERRARD 8830.

Research and National Progress.

SIR ALFRED MOND, in a speech at the anniversary dinner of the Chemical Society on March 17, said that the attitude of the House of Commons towards research was much the same as that which led to the loss of the dye industry to this country, and it was manifested recently in the attacks made upon his proposal to spend a few hundred pounds on a laboratory where investigations could be carried out on the behaviour of concrete under different conditions. It is evident, therefore, that there are still people in positions of authority who do not understand the significance of research, and prefer the experience of a practical man to the results of the most careful scientific inquiry. Under the stress of competition such experience often represents the principle of the survival of the fittest, and has, therefore, to be given careful consideration; but more often it carries with it many vestigial characters which can be discarded without loss of function, and possibly with profit.

Research does not, however, signify merely the scientific testing of designs and methods with the object of discovering the factors essential to the fulfilment of a particular purpose. It is true that the chief part of industrial research is concerned with problems of this kind, but though the results thus obtained may improve a product or make a process more profitable, they rarely have more than a limited influence upon industrial progress.

NO. 2682, VOL. 107]

The greatest advances are made, not by increasing the effectiveness of known instruments or methods, but by the opening up of completely new fields, and this is more often accomplished by independent and incidental scientific discovery than by the study of particular problems in the light of existing knowledge.

The functions of the industrial research worker are, indeed, those of inventors who, like one of the groups of fellows in Francis Bacon's Solomon's House, devote themselves to the application of experiments "to draw out of them things of use, and practice for man's life, and knowledge." Such workers have a definite object in view, and cannot depart from it into the by-paths which in purely scientific research frequently lead to the most fertile regions. The publications of scientific societies abound in rich fruits of fact and principle garnered from these fields, and from them the inventor or industrial research worker selects what seems to him likely to satisfy his needs. It is the joy of the chase which inspires the scientific huntsman to continue the pursuit of new knowledge, and he is usually content to let others make use of the spoils.

The desire to discover and the insight which discerns practical possibilities in results obtained are thus complementary faculties. To one, progress signifies contributions to the sum of human knowledge; to the other, their profitable exploitation. One type communicates freely to the world whatever it has learned by research; the other seeks to secure patent rights and personal reward for what it devises. Oersted's discovery of the magnetic action of an electric current led eventually to the electric telegraph; Faraday's work on magneto-electricity to the dynamo, and all that is associated with it; Clerk Maxwell and Hertz's to wireless telegraphy; Crookes's tube to X-rays; Fleming's studies of the Edison effect to thermionic valves; the production of ductile tungsten to metallic filament electric lamps, of Perkin's mauve to the synthetic dyes industry, of acetylene to the oxyacetylene welding process, of potassium to the whole electrolytic industry, and of various rare metals to a series of alloys of prime industrial importance. In these and hundreds of other similar examples the seeds were first found by purely scientific workers, and it was usually not until some years later that they were planted and cultivated by ingenious practical men so that the human race could benefit by the fruits from the great trees that have sprung from them.

Just as wealth has to be created before it can

be distributed, so new knowledge has to be gained before it can be applied. The political party which concentrates attention upon inequalities in the distribution of wealth, and neglects to take its production into consideration, presents the same attitude to progress as does the industrialist whose outlook is limited by what he can observe now, and who sees no profit in the extension of it by research. Yet a slight knowledge of modern social and industrial history would be sufficient to convince the most indifferent mind that pure and applied science is the life-blood of a nation in these times. But for this we could not have existed during the past century. After the Napoleonic wars this country was left in much the same difficult and troublous condition that it finds itself in to-day. Then, as now, we came out of the conflict with our soil inviolate, but were faced with widespread social and industrial unrest, due partly to the avarice of landowners and manufacturers, and partly to the ruin of village industries by the use of mechanical power in factories. We were saved from financial disaster at that time by increased output due to the invention of the steam engine, by which mines were freed from water, and coal, iron, and copper were rendered abundantly available. Textile trades were provided with the means for great expansion by the use of factory machinery in connection with the inventions belonging to them, and the advent of the railway and the steamship created further demands for iron and steel, and the coal necessary for their production. Thus it was that, while there was almost constant unrest in every European State, and heavy taxation had produced a condition approaching semi-starvation over a large part of the country, we were able to maintain our credit.

The country was then saved by invention, and we should have maintained the same lead in the chemical and electrical industries if our manufacturers had been alive to the practical value of scientific research, or our politicians had stimulated enterprises associated with its application instead of strangling them with unnecessary legislation. The thing to remember is that, whether we like it or not, we must advance if we are not to be left behind other progressive nations. The only way to keep in the van of modern industrial forces is to provide what other people want which they cannot produce for themselves either so cheaply or so excellently as we can. In view of international competition, it is not possible, in the neutral and open markets of the world, to

increase the selling price of goods which can be produced by other nations unless they are decidedly superior in quality. Craftsmanship counts for something in securing this superiority, but the richest promise in these days lies in the discovery of new knowledge by research and the application of it to industry.

The output of British scientific workers is to-day larger than ever it was, and if industrial development does not proceed from it, the fault will not lie at their doors. Neither can they be blamed if social conditions are not improved by the increase of national wealth through the use of science. Their function is to discover, and faithfully they are performing it; it is for statesmen to see that this creative work is given every encouragement, for manufacturers to make profitable use of it, and for social reformers to ensure that the fruits are used to promote national well-being. Only thus can we make progress and in the future avoid the reproach that science necessarily signifies the desecration of Nature, and the degrading social conditions of the factory towns brought into existence by its users a century ago.

Matter and Motion.

Matter and Motion. By the late Prof. J. Clerk Maxwell. Reprinted with notes and appendices by Sir Joseph Larmor. Pp. xv+163. (London: S.P.C.K.; New York: The Macmillan Co., 1920.) 5s. net.

IN a recent article a well-known musical critic has remarked with perfect truth of musicians—and the same is undoubtedly true of other classes of intellectualists, including men of science—that a man is immune from criticism if by popular acclaim, or in some other way, he has been provided with a halo! If he has such a decoration it is a part of him; he cannot appear without it—whatever he does is right; all his sayings, whether or not they are couched in pure and pellucid English without fault or flaw of expression, are accepted without cavil or question. If an adventurous critic dares to moot some opposing view, it is suggested with the greatest deference and profound apology.

The mode in which this glistening, or rather glistening, appendage is obtained is sometimes obvious enough; at other times it is obscure and mysterious. The recipient may be silently and unannouncedly received in recognition of his merits into the ranks of the great ones, of course without any ceremony of canonisation, for in science there is no official pontiff. In some other cases of a lower grade of sainthood he is received as

the more equivocal result of the applause of a crowd of allies and sympathisers, members perhaps of the same university, pupils and admirers, supporters of all kinds. As a rule, a halo-wearer can do no wrong. This royal prerogative is sometimes mildly disputed, but the disputer generally gets the worst of the discussion, and, unless he is pachydermatous, is duly sorry for himself.

One of the most revered of halo-wearers is Clerk Maxwell, who holds his great place by patent given from the highest source of all such dignity. In his writings originality of thought was accompanied always by felicity of phrase and expression, tempered with a savour of wit which is found only in men of subtle and penetrating humour, that wit which is, above all things, a saving grace in literature, and especially in science. Read his address "On the Mirror Galvanometer," supposed to be delivered to a pupil in an alcove with drawn curtains; in spite of the somewhat unpromising subject, it is as good as—nay, some would say it is much better than—its prototype, "The Splendour Falls on Castle Walls," or, indeed, almost any other lyric in Tennyson's "Princess."

From time to time Clerk Maxwell wrote on elementary science in a way which attracted the attention and enchained the admiration of everyone. The first of these writings was "The Theory of Heat"; the second, published in 1877, was "Matter and Motion." Both were unique. In various respects—*e.g.* in the question of entropy—the book on heat was open to objection, but as a presentation of thermodynamic theory it was, and has remained, unrivalled. We prefer the thermodynamic relations in the form which they take when the steps of temperature, pressure, volume, etc., are infinitesimal, and the notation (easily explained and understood) of infinitesimals is used; but this is a detail of no great importance. Nothing could exceed the elegance of the discussion, the importance of the semi-graphical, semi-analytical treatment of the energetics of the subject, and the theme of available energy.

In "Matter and Motion" the subject was really Newtonian dynamics, a theme which, in spite of the silly exaltations by the popular Press of Einstein above Newton, still remains supreme in dynamics. The first edition had poor and exasperating diagrams, and was not well printed; the present edition has been issued under the editorship of Sir Joseph Larmor, who has given the work everywhere, and in all details, the utmost care and attention. When we consider that the reprint of the original edition is contained in the small compass of 136 of the new pages, it appears marvellous that a view of dynamics so complete in

itself in many respects could be compressed into so few pages of print.

On various interesting topics, such as Gravitation and Light and "The Principle of Least Action," Sir Joseph Larmor has added appendices, while he has inserted as chap. ix. a discussion of "The Equations of Motion of a Connected System," which increases the size of the book by only thirty-nine of the present pages. Needless to say, these additions are models of condensation, and at the same time of absolute clearness and accuracy. The new view of the gravitational field, which Einstein's theory of space and time affords, leads to an explanation of an outstanding discrepancy of observation with theory in the motion of the planet Mercury. This involves a certain warping of the reference frame which must be set up for these motions, and this has been verified by the observations of the solar eclipse of 1919, by the fact that rays of light passing near the sun have been found to be deflected by a certain amount predicted beforehand towards that luminary.

It is difficult also to pick out what were the peculiarly interesting parts of Clerk Maxwell's "Matter and Motion." Every bit of it was distinctive and distinguished, but in some ways the discussion of the hodograph, and the question of absolute velocity of rotation, impressed us most. The chapter on the latter subject was read again and again and pondered continually. There came afterwards the discussions by Love and Mach, which, however rigidly logical and silencing, seemed to us far from convincing. Mach's book was no doubt very valuable, but the touch of the writer, if precise, seemed to lack lightness and, as compared with Maxwell's, that distinction which the magic of genius alone can confer. One might weary of Mach's excellent treatise; of Maxwell one never tired.

It is now possible to make a wider survey of the whole subject. The elegance of the hodographic theory appears very vividly in Maxwell's treatment. It is a great thing to say, but there is scarcely anything among the numerous discoveries of Hamilton in dynamics which so signally illustrates his penetrating genius. The hodograph was hit upon some four or five years before Hamilton by Möbius, as may be verified by consulting his treatise on physical astronomy, "Die Mechanik des Himmels." But application of the idea Möbius makes little or none. With Hamilton the applications are everything; the idea is used to obtain all kinds of beautiful results. That Möbius had anticipated him Hamilton was fully aware, and acknowledges (see the *Life* by Graves) that Möbius might have claimed the

notion; but the claim would have been a barren one.

One thing we miss in Maxwell's discussion—that is, the curious theorem of the splitting of the velocity of the particle describing the orbit into two constant components, one at right angles to the radius vector, and the other perpendicular to the major axis of the orbit. It is curious that there should be this relation.

A propos of the principle of least action, discussed in appendix ii., it is remarkable that if the major axis of an elliptic orbit, for a particle moving, as in the case of Nature, under a force along the radius vector from a focus, and varying as the square of the distance, is given, the action (the space-integral of the momentum round the orbit) is independent of the eccentricity of the orbit. It depends only on the major axis, so that it is the same for a circular orbit as for a long, narrow one. This gives a means of solving various problems.

Connected with this is another theorem that the kinetic energy of the particle at distance r from the same centre of force, in a hyperbolic orbit of semi-transverse axis a (equal to the semi-major axis of the elliptic orbit), exceeds, and in the elliptic orbit falls short of, the expansion $m\mu/r$ of potential energy, from infinity to the distance r , by the time or average of the kinetic energy of the elliptic motion.

One thing we cannot understand in the popular treatment of hodographic theory: Why is it always regarded as an affair of particle dynamics only? If we set up, or imagine set up, a sequence of vectors representing the angular momentum of a rigid body, say that of an aeroplane, the velocity of the extremity of the vector is in magnitude and direction the rate of change of the angular momentum. This might help to prevent that pernicious "ignorance" of the direction of the angular momentum vector, and its variation, which characterises so many uninstructed but apparently influential people. A. GRAY.

A Socialist Commonwealth.

A Constitution for the Socialist Commonwealth of Great Britain. By Sidney and Beatrice Webb. Pp. xviii+364. (London: Longmans, Green, and Co., 1920.) 12s. 6d. net.

IN this volume Mr. and Mrs. Webb set themselves to build "an efficiently working, genuinely democratic constitution" out of the materials that are already to hand. The distinctive feature of the Socialist Commonwealth of Great Britain will be the division of the labours of our present overworked Parliament between two

co-equal bodies, the Social and the Political Parliaments, both elected on a geographical basis by all the adult citizens. The Political Parliament will deal mainly with defence, justice, and foreign affairs, and will have a keen eye to the protection of the liberty of the individual. To the Social Parliament all else falls—labour, health, education, the control of industry, and care for the interests of generations yet unborn. In the hands of the Social Parliament rests also the power of the purse; from which it may be anticipated that the Political Parliament, for all its nominal equality, will have to mind its "p's and q's."

Perhaps the most fruitful part of a very suggestive work is contained in the proposals for the reconstruction of local government. On this the authors speak with ripe experience of actual administration, as well as with their usual wide theoretical knowledge. The unit of local government is to be the ward, though different wards are to be grouped and re-grouped in such a way as to give a unit of appropriate size for the conduct of each municipalised service. Economic efficiency will thus no longer be subservient to the historical accident of municipal boundaries.

Industry will of course be "socialised." Socialisation will take a variety of forms, the common features of which will be production for use and not for profit, and the separation of control from actual administration. Nationalisation, municipalisation (of which a great expansion is anticipated), and organisation on the co-operative principle exhibited by the existing Consumers' Co-operative Movement will be the three great types. The nationalised industries will be administered by a hierarchy of national boards, regional councils, and works or pit committees, responsible to a Standing Committee of the Social Parliament, and goaded into efficiency by the supervision and control of an independent department. Bureaucracy is anathema. A limited share in administration will be accorded to the appropriate organisations of workers, although Mr. and Mrs. Webb believe in the conduct of industry by the community for the community, rather than by the workers for the workers. The charwomen who clean the schools are not to dictate what shall be taught there. Vocational organisations, of the form of our present trade unions and professional associations, will be concerned rather with the protection of the status of the several vocations, the promotion of all kinds of scientific research (on which the authors lay great stress), and the maintenance of professional honour. For a national body elected on a vocational basis, such as a regenerated Trade Union Congress, the authors

see little future in their commonwealth. It may be suggested that in taking this view they are rejecting a method of "functional devolution" likely to be more effective than the Parliamentary dualism which receives their blessing.

The book is interesting, but not light reading. Some of its proposals will no doubt appeal to all readers; all of its proposals to some readers. Universal acceptance *in toto* is, of course, not to be expected. But criticism is easy; construction as difficult as it is urgent. This constitution-making commands the respect of the critic for its concrete and practical character.

BARBARA WOOTTON.

Science for the Young Farmer.

The Chemistry of Crop Production. By Prof. T. B. Wood. Pp. vii+193. (London: W. B. Clive, 1920.) 5s. 6d.

PROBABLY no one in the country is better equipped for the task of writing an elementary book for the young farmer than Prof. Wood. He has had a long teaching experience at Cambridge, and has himself run a farm at a profit; in addition, he has carried out important scientific investigations in agriculture, and was responsible during the war for studying fully the national food supply.

With this equipment on the part of the author, it is not surprising that his little book itself is admirable. It is lucidly written, and gives the student the facts he wants, expressed in language which, if lacking the picturesqueness of the author's daily use, is nevertheless much more vivid than is customary in a student's text-book. At the outset the complexity of the problem is realised, and it is emphasised that soil fertility depends not on one, but on many independent factors, any of which may prove insufficient and set a limit to plant growth. These factors are then studied one by one. Considerable information is given about soil types and the method of characterisation by mechanical analysis; examples are drawn from the surveys of Norfolk by Newman, and of Kent, Surrey, and Sussex by Hall and Russell. Several maps show the distribution of crops in the eastern counties, and illustrate the intense localisation of potatoes and the much wider distribution of wheat. Water supply is discussed in relation to rainfall, and a section on weather and meteorology will give the student much information of interest to him.

The principles of manuring are clearly set forth with many examples which will prove of value to the student. Throughout, considerable stress is

laid on the economic side, prices and probable returns being freely quoted. In future editions it will be well to substitute a paragraph on the basic open-hearth for the present one on the Bessemer process, which is now largely superseded. The catalytic process for preparing ammonia synthetically will also probably deserve mention along with the method for making calcium nitrate and cyanamide from the air.

The last chapter contains an interesting summary of the leading features of British agriculture, showing how greatly grass predominates. This is shown to be connected with the high rainfall and high altitude of much of the country, though it is also influenced by considerations of capital and labour. Of the other crops, most are grown for animals, 63,000,000 tons (including 50,000,000 of grass) being produced for them, as against 1,900,000 tons for human consumption, and 1,400,000 for industries, all reckoned as dry matter. The 63,000,000 tons become 54,000,000 when deduction is made for the horses, and it is shown that the whole of this 54,000,000 tons, *plus* another 8,000,000 tons of imported produce, is taken by animals which will be eaten by human beings; but it yields only 1½ million tons of human food, again expressed as dry matter. The animal as at present managed is not a very efficient converter.

E. J. R.

A Fabre Anthology.

Insect Adventures. By J. H. Fabre. Pp. xii+308. (London: Hodder and Stoughton, Ltd., n.d.) 8s. 6d. net.

IT was a happy thought to adapt for young people, as Miss Louise S. Hasbrouck has done, some of the translations made by Mr. Teixeira de Mattos from Fabre's "Souvenirs Entomologiques." Fabre's studies of animal behaviour appeal to children more organically than any premature analysis, and the great naturalist had a way with him that attracted young folks. Reproaching the anatomical zoologists, he wrote: "You pry into death, I pry into life . . . I write above all for the young. I want to make them love the natural history which you make them hate; and that is why, while keeping strictly to the domain of truth, I avoid your scientific prose, which too often, alas! seems borrowed from some Iroquois idiom." So we have these delightful stories of ants, bees, wasps, flies, beetles, moths, caterpillars, and spiders. There is poetry in the picture of his first pond, with its diamonds and gold dust and "heavenly" beetles, which had all to be cast on the rubbish heap when the boy got

home. "In later years I found out that the diamonds of the duck-pool were rock-crystal, the gold-dust, mica; but the fascination of the pond held good for all that. It was full of secrets that were worth more to me than diamonds and gold."

The autobiographical chapter, "The Boy who Loved Insects," is charming, and we are glad to see the inclusion for young geometricians of the discussion on the logarithmic spiral which Fabre appended to the story of the spider's web. We wish, however, that it had been possible to omit Fabre's unfortunate but characteristic taunting of the evolutionists. He asks where the snail with its spiral shell of lime and the spider with its spiral thread of silk "pick up this science." "We are told that the Mollusc is descended from the Worm. One day the Worm, rendered frisky by the sun, brandished its tail and twisted it into a corkscrew for sheer glee. There and then the plan of the future spiral shell was discovered. This is what is taught quite seriously, in these days, as the very last word in science. The Spider will have none of this theory, for she is not related to the Worm. Yet she is familiar with the logarithmic spiral and uses it in her web. . . . What guides her? Nothing but an inborn skill, whose effects the animal is no more able to control than the flower is able to control the arrangement of its petals and stamens. The spider practises higher geometry without knowing or caring. The thing works of itself, and takes its way from an instinct imposed upon Creation at the start." Now the great observer was within his rights in suggesting that instinct is unanalysable animal-genius, or any other theory of that elusive kind of behaviour, and he was within his rights in stating that in his opinion the widespread occurrence of the logarithmic spiral in Nature pointed to a "Universal Geometrician, whose divine compass has measured all things," but he was not within his rights in travestying the evolution theory.

This is a delightful book, and very pleasantly printed. Only a few blemishes have caught our eye, like Moquin-Tandon; and was not the adjective that Darwin applied to Fabre "inimitable"?

Our Bookshelf.

A Physician's Anthology of English and American Poetry. Selected and arranged by Dr. C. A. Wood and Dr. F. H. Garrison. Pp. xxiii + 346. (London: Humphrey Milford, 1920.) 8s. 6d. net.

WE have got rid of the old convention that all flowers at a funeral must be white: we send them now in all the colours of the rainbow. So is this

wreath, laid on Osler's grave by two men who loved him. They have done well. It is a delightful book: sincere, quiet, companionable, thoughtful, as good a friend as anyone could wish to have in his pocket. Note the place of the apostrophe: it is a book for a doctor, not only a book by two doctors. Here and there, of course, it challenges a reviewer, but that is the way of all anthologies. For instance, there is more of Clough than of Christina Rossetti: and the last poem of all, from Weir Mitchell, is inferior to a similar poem by Stevenson. There is rather too much of Lecky, and even of Matthew Arnold: and Siegfried Sassoon's poems of the War have that imperfection which is criticised in Mrs. de Selincourt's perfect story of "Autumn Crocuses." But these are mere little hole-pickings in a very beautiful and well-wrought fabric.

The preface is admirable: and all that the anthologists say of the influence of the doctor's experiences on the doctor's thoughts is true. But they do not make enough allowance, it may be, for the touch of antagonism between practice and poetry. It may come natural to a doctor to say with Weir of Hermiston, "I ha' no call to be bonny"—in part because he is a man of science, and there is a world of difference between science and poetry; in part because his day's work is essentially objective. He exalts it with his kindly feelings, but it remains an affair of signs and symptoms which do not lend themselves to poetical treatment; rather they cry aloud for medical or surgical treatment.

One more point: there have been, and are, men who are both doctors and poets; but we must not include in that list men who gave up practice for poetry: who "qualified," but did nothing much as practitioners, and later were poets. The medical profession cannot lay claim to Keats or Schiller. But this point lies outside the treasures of "A Physician's Anthology," and we congratulate the good physicians who made so good a selection.

Elements of Statistics. By Prof. Arthur L. Bowley. Fourth edition. Pp. xi + 459. (London: P. S. King and Son, Ltd.; New York: Charles Scribner's Sons, 1920.) 24s. net.

ALTHOUGH Prof. Bowley's "Elements of Statistics" no longer holds the practically unique position as a text-book which it held on its first appearance twenty years ago, yet teachers and students alike will welcome this new and enlarged edition of a work the value of which has been proved by experience in the interval. The second part of the book, which deals with the higher mathematical treatment of statistical methods, has been entirely rewritten, and the author admits his indebtedness to the work on those lines done in recent years by Prof. Edgeworth, Mr. Udny Yule, and others. Prof. Bowley, however, while going beyond the limits set in earlier editions, by assuming now in the reader a knowledge of the

use of the calculus, has endeavoured with a fair amount of success to simplify the proofs of the algebraic formulæ used, so as to keep these within the scope of the average university graduate course in mathematics. More space is devoted to the coefficient of correlation, the too facile use of which by many writers is responsible to-day for much loose reasoning.

Part i. remains on the same lines as in the earlier editions; by reference to particular groups of English statistics it illustrates the general principles guiding the collection, tabulation, and utilisation of results of statistical inquiries, so far as these aims can be reached without the use of any but the most elementary mathematics. Some of the illustrations have been brought up to date, and in particular the chapter dealing with the important subject of index numbers of prices and cost of living has been rewritten, but, in spite of the fear expressed by the author that too much attention to such details might have upset the balance of the work, it seems a pity that he did not take this opportunity of revising thoroughly all the illustrations from official and other publications. This would have made the volume much more alive and attractive to the non-academic reader whose object it is to equip himself as a citizen to understand and criticise the increasing volume of figures with which statements of rival political and social policies are now supported.

The Sea-Shore. By W. P. Pycraft. (The Nature Lover's Series.) Pp. vi+156. (London: S.P.C.K.; New York: The Macmillan Co., 1920.) 4s. 6d. net.

MANY books have been written about the sea-shore and its life, some very good, Miss Newbiggin's by far the best; others good, like Lewes's and J. G. Wood's; others not good at all. Mr. Pycraft's book is very good, for he knows at first hand what he is talking about. He is an expert on sea-shore birds, and he has insight into the *magnalia naturae*. Moreover, the book has the smack of individuality—the first of a "Nature Lover's Series"—aiming at a synoptic view, not of the fauna merely or principally, but of the sea-shore as a region as full of intellectual as of æsthetic delights. Many of those who go to the shore for recreation miss half the fun because they are unaware of the intensely interesting problems all around them. They do not see the significance of things. But Mr. Pycraft's book gives them a jumping-off place. It tells of the gathering together of waters, of shallow seas and deep seas, of cliffs and caves, of pebbles and sand-beaches, of islands and their charm, and of the animal inhabitants of the varied haunts which the sea-shore includes. It is all luminous and illuminating, and, naturally, the treatment of the sea-shore birds is masterly. Mr. Pycraft strikes the genetic note in his physical chapters, and the bionomic note in his natural history. We are sorry that he has deliberately refrained from dealing with the sea-shore plants and with the Algæ, for that was needed to round off the survey. This

defect notwithstanding, the book has a wider horizon than most sea-shore books, and many will be grateful to the author. Even in short books it is surprisingly difficult to avoid sheer casualities like Asterius and the four chisel-like teeth of the sea-urchin, a number immediately raised to five. It is not our experience that a guillemot's egg "rolls round in a circle" when jostled, but we bow to the authority of one of the most scientific of ornithologists. His book is pure gold.

The Encyclopædia and Dictionary of Education.

Part i. (London: Sir Isaac Pitman and Sons, Ltd., 1921.) 2s. net.

THIS is part i. of an "Encyclopædia and Dictionary of Education" being issued under the general editorship of Prof. Foster Watson. The work when complete will comprise nearly 2000 large crown quarto pages. It will contain as many as 2250 separate articles contributed by more than 850 specialists representing most of the chief universities of the world in practically every branch and section of theoretical and practical education. Having regard to the fact of the rapid development of education in all branches, especially in this country, during the last two decades, and its close connection with social and national movements, it is believed that a work dealing systematically with its progress will meet with warm approval.

The subject-matter of education has grown so complex, including its psychological, medical, and other aspects, that it demands for the inquirer, the teacher, and the administrator some authoritative guidance such as this work is designed to give, including clear, accurate, and concise accounts of all types of teaching institutions in the British Isles and Dominions, not only in their historical aspect, but also in their present conditions. In addition, there is passed in review the educational systems of all the important foreign countries. Due prominence has also been given to the lives and teachings of great educationists, and the Board of Education's Regulations have been epitomised in a convenient and simple form.

Each part will be illustrated. A complete list of the contributors is supplied with part i., but we note the absence of the names of any contributors dealing with the important developments and position of education in Germany.

The Mechanical Production of Cold. By Sir J. A. Ewing. Second edition. Pp. x+204. (Cambridge: At the University Press, 1921.) 25s. net.

ALTHOUGH it is more than twelve years since the first edition of Sir J. A. Ewing's book was published, the author has not found it necessary to do more than correct some errors and to modify the text in places where the meaning was obscure. The book therefore is substantially the same as the first edition, a notice of which appeared in NATURE for February 25, 1909 (vol. lxxix., p. 484).

Letters to the Editor.

[The Editor does not hold himself responsible for opinions expressed by his correspondents. Neither can he undertake to return, or to correspond with the writers of, rejected manuscripts intended for this or any other part of NATURE. No notice is taken of anonymous communications.]

Atomic Structure.

In a letter to NATURE of November 25 last Dr. Norman Campbell discusses the problem of the possible consistency of the assumptions about the motion and arrangement of electrons in the atom underlying the interpretation of the series spectra of the elements based on the application of the quantum theory to the nuclear theory of atomic structure, and the apparently widely different assumptions which have been introduced in various recent attempts to develop a theory of atomic constitution capable of accounting for other physical and chemical properties of the elements. Dr. Campbell puts forward the interesting suggestion that the apparent inconsistency under consideration may not be real, but rather appear as a consequence of the formal character of the principles of the quantum theory, which might involve that the pictures of atomic constitution used in explanations of different phenomena may have a totally different aspect, and nevertheless refer to the same reality. In this connection he directs attention especially to the so-called "principle of correspondence," by the establishment of which it has been possible—notwithstanding the fundamental difference between the ordinary theory of electromagnetic radiation and the ideas of the quantum theory—to complete certain deductions based on the quantum theory by other deductions based on the classical theory of radiation.

In so far as it must be confessed that we do not possess a complete theory which enables us to describe in detail the mechanism of emission and absorption of radiation by atomic systems, I naturally agree that the principle of correspondence, like all other notions of the quantum theory, is of a somewhat formal character. But, on the other hand, the fact that it has been possible to establish an intimate connection between the spectrum emitted by an atomic system—deduced according to the quantum theory on the assumption of a certain type of motion of the particles of the atom—and the constitution of the radiation, which, according to the ordinary theory of electromagnetism, would result from the same type of motion, appears to me to afford an argument in favour of the reality of the assumptions of the spectral theory of a kind scarcely compatible with Dr. Campbell's suggestion. On the contrary, if we admit the soundness of the quantum theory of spectra, the principle of correspondence would seem to afford perhaps the strongest inducement to seek an interpretation of the other physical and chemical properties of the elements on the same lines as the interpretation of their series spectra; and in this letter I should like briefly to indicate how it seems possible by an extended use of this principle to overcome certain fundamental difficulties hitherto involved in the attempts to develop a general theory of atomic constitution based on the application of the quantum theory to the nucleus atom.

The common character of theories of atomic constitution has been the endeavour to find configurations and motions of the electrons which would seem to offer an interpretation of the variations of the chemical properties of the elements with the atomic number as they are so clearly exhibited in the well-known periodic law. A consideration of this law

leads directly to the view that the electrons in the atom are arranged in distinctly separate groups, each containing a number of electrons equal to one of the periods in the sequence of the elements, arranged according to increasing atomic number. In the first attempts to obtain a definite picture of the configuration and motion of the electrons in these groups it was assumed that the electrons within each group at any moment were placed at equal angular intervals on a circular orbit with the nucleus at the centre, while in later theories this simple assumption has been replaced by the assumptions that the configurations of electrons within the various groups do not possess such simple axial symmetry, but exhibit a higher degree of symmetry in space, it being assumed, for instance, that the configuration of the electrons at any moment during their motions possesses polyhedral symmetry. All such theories involve, however, the fundamental difficulty that no interpretation is given why these configurations actually appear during the formation of the atom through a process of binding of the electrons by the nucleus, and why the constitution of the atom is essentially stable in the sense that the original configuration is reorganised if it be temporarily disturbed by external agencies. If we reckon with no other forces between the particles except the attraction and repulsion due to their electric charges, such an interpretation claims clearly that there must exist an intimate interaction or "coupling" between the various groups of electrons in the atom which is essentially different from that which might be expected if the electrons in different groups are assumed to move in orbits quite outside each other in such a way that each group may be said to form a "shell" of the atom, the effect of which on the constitution of the outer shells would arise mainly from the compensation of a part of the attraction from the nucleus due to the charge of the electrons.

These considerations are seen to refer to essential features of the nucleus atom, and so far to have no special relation to the character of the quantum theory, which was originally introduced in atomic problems in the hope of obtaining a rational interpretation of the stability of the atom. According to this theory an atomic system possesses a number of distinctive states, the so-called "stationary states," in which the motion can be described by ordinary mechanics, and in which the atom can exist, at any rate for a time, without emission of energy radiation. The characteristic radiation from the atom is emitted only during a transition between two such states, and this process of transition cannot be described by ordinary mechanics, any more than the character of the emitted radiation can be calculated from the motion by the ordinary theory of electro-magnetism, it being, in striking contrast to this theory, assumed that the transition is always followed by an emission of monochromatic radiation the frequency of which is determined simply from the difference of energy in the two states. The application of the quantum theory to atomic problems—which took its starting point from the interpretation of the simple spectrum of hydrogen, for which no *a priori* fixation of the stationary states of the atoms was needed—has in recent years been largely extended by the development of systematic methods for fixing the stationary states corresponding to certain general classes of mechanical motions. While in this way a detailed interpretation of spectroscopic results of a very different kind has been obtained, so far as phenomena which depend essentially on the motion of one electron in the atom were concerned, no definite elucidation has been obtained with regard to the constitution of

atoms containing several electrons, due to the circumstance that the methods of fixing stationary states were not able to remove the arbitrariness in the choice of the number and configurations of the electrons in the various groups, or shells, of the atom. In fact, the only immediate consequence to which they lead is that the motion of every electron in the atom will on a first approximation correspond to one of the stationary states of a system consisting of a particle moving in a central field of force, which in their limit are represented by the various circular or elliptical stationary orbits which appear in Sommerfeld's theory of the fine structure of the hydrogen lines. A way to remove the arbitrariness in question is opened, however, by the introduction of the correspondence principle, which gives expression to the tendency in the quantum theory to see not merely a set of formal rules for fixing the stationary states of atomic systems and the frequency of the radiation emitted by the transitions between these states, but rather an attempt to obtain a rational generalisation of the electromagnetic theory of radiation which exhibits the discontinuous character necessary to account for the essential stability of atoms.

Without entering here on a detailed formulation of the correspondence principle, it may be sufficient for the present purpose to say that it establishes an intimate connection between the character of the motion in the stationary states of an atomic system and the possibility of a transition between two of these states, and therefore offers a basis for a theoretical examination of the process which may be expected to take place during the formation and reorganisation of an atom. For instance, we are led by this principle directly to the conclusion that we cannot expect in actual atoms configurations of the type in which the electrons within each group are arranged in rings or configurations of polyhedral symmetry, because the formation of such configurations would claim that all the electrons within each group should be originally bound by the atom at the same time. On the contrary, it seems necessary to seek the configurations of the electrons in the atoms among such configurations as may be formed by the successive binding of the electrons one by one, a process the last stages of which we may assume to witness in the emission of the series spectra of the elements. Now on the correspondence principle we are actually led to a picture of such a process which not only affords a detailed insight into the structure of these spectra, but also suggests a definite arrangement of the electrons in the atom of a type which seems suitable to interpret the high-frequency spectra and the chemical properties of the elements. Thus from a consideration of the possible transitions between stationary states, corresponding to the various steps of the binding of each of the electrons, we are led in the first place to assume that only the two first electrons move in what may be called one-quantum orbits, which are analogous to that stationary state of a central system which corresponds to the normal state of a system consisting of one electron rotating round a nucleus. The electrons bound after the first two will not be able by a transition between two stationary states to procure a position in the atom equivalent to that of these two electrons, but will move in what may be called multiple-quanta orbits, which correspond to other stationary states of a central system.

The assumption of the presence in the normal state of the atom of such multiple-quanta orbits has already been introduced in various recent theories, as, for instance, in Sommerfeld's work on the high-frequency spectra and in that of Landé on atomic dimen-

sions and crystal structure; but the application of the correspondence principle seems to offer for the first time a rational theoretical basis for these conclusions and for the discussion of the arrangement of the orbits of the electrons bound after the first two. Thus by means of a closer examination of the progress of the binding process this principle offers a simple argument for concluding that these electrons are arranged in groups in a way which reflects the periods exhibited by the chemical properties of the elements within the sequence of increasing atomic numbers. In fact, if we consider the binding of a large number of electrons by a nucleus of high positive charge, this argument suggests that after the first two electrons are bound in one-quantum orbits, the next eight electrons will be bound in two-quanta orbits, the next eighteen in three-quanta orbits, and the next thirty-two in four-quanta orbits.

Although the arrangements of the orbits of the electrons within these groups will exhibit a remarkable degree of spatial symmetry, the groups cannot be said to form simple shells in the sense in which this expression is generally used as regards atomic constitution. In the first place, the argument involves that the electrons within each group do not all play equivalent parts, but are divided into sub-groups corresponding to the different types of multiple-quanta orbits of the same total number of quanta, which represents the various stationary states of an electron moving in a central field. Thus, corresponding to the fact that in such a system there exist two types of two-quanta orbits, three types of three-quanta orbits, and so on, we are led to the view that the above-mentioned group of eight electrons consists of two sub-groups of four electrons each, the group of eighteen electrons of three sub-groups of six electrons each, and the group of thirty-two electrons of four sub-groups of eight electrons each.

Another essential feature of the constitution described lies in the configuration of the orbits of the electrons in the different groups relative to each other. Thus for each group the electrons within certain sub-groups will penetrate during their revolution into regions which are closer to the nucleus than the mean distances of the electrons belonging to groups of fewer-quanta orbits. This circumstance, which is intimately connected with the essential features of the processes of successive binding, gives just that expression for the "coupling" between the different groups which is a necessary condition for the stability of atomic configurations. In fact, this coupling is the predominant feature of the whole picture, and is to be taken as a guide for the interpretation of all details as regards the formation of the different groups and their various sub-groups. Further, the stability of the whole configuration is of such a character that if any one of the electrons is removed from the atom by external agencies not only may the previous configuration be reorganised by a successive displacement of the electrons within the sequence in which they were originally bound by the atom, but also the place of the removed electron may be taken by any one of the electrons belonging to more loosely bound groups or sub-groups through a process of direct transition between two stationary states, accompanied by an emission of a monochromatic radiation. This circumstance—which offers a basis for a detailed interpretation of the characteristic structure of the high-frequency spectra of the elements—is intimately connected with the fact that the electrons in the various sub-groups, although they may be said to play equivalent parts in the harmony of the interatomic motions, are not at every moment arranged in configurations of simple axial or polyhedral sym-

metry as in Sommerfeld's or Landé's work, but that their motions are, on the contrary, linked to each other in such a way that it is possible to remove any one of the electrons from the group by a process whereby the orbits of the remaining electrons are altered in a continuous manner.

These general remarks apply to the constitution and stability of all the groups of electrons in the atom. On the other hand, the simple variations indicated above of the number of electrons in the groups and sub-groups of successive shells hold only for that region in the atom where the attraction from the nucleus compared with the repulsion from the electrons possesses a preponderant influence on the motion of each electron. As regards the arrangements of the electrons bound by the atom at a moment when the charges of the previously bound electrons begin to compensate the greater part of the positive charge of the nucleus, we meet with new features, and a consideration of the conditions for the binding process forces us to assume that new, added electrons are bound in orbits of a number of quanta equal to, or fewer than, that of the electrons in groups previously bound, although during the greater part of their revolution they will move outside the electrons in these groups. Such a stop in the increase, or even decrease, in the number of quanta characterising the orbits corresponding to the motion of the electrons in successive shells takes place, in general, when somewhat more than half the total number of electrons is bound. During the progress of the binding process the electrons will at first still be arranged in groups of the indicated constitution, so that groups of three-quanta orbits will again contain eighteen electrons and those of two-quanta orbits eight electrons. In the neutral atom, however, the electrons bound last and most loosely will, in general, not be able to arrange themselves in such a regular way. In fact, on the surface of the atom we meet with groups of the described constitution only in the elements which belong to the family of inactive gases, the members of which from many points of view have also been acknowledged to be a sort of landmark within the natural system of the elements. For the atoms of these elements we must expect the constitutions indicated by the following symbols:

Helium (2),	Krypton (2,8 ₂ 18 ₈ 8 ₂),
Neon (2,8 ₂),	Xenon (2,8 ₂ 18 ₈ 18 ₈ 8 ₂),
Argon (2,8 ₂ 8 ₂),	Niton (2,8 ₂ 18 ₈ 32 ₁₈ 8 ₂),

where the large figures denote the number of electrons in the groups starting from the innermost one, and the small figures the total number of quanta characterising the orbits of electrons within each group.

These configurations are distinguished by an inherent stability in the sense that it is especially difficult to remove any of the electrons from such atoms so as to form positive ions, and that there will be no tendency for an electron to attach itself to the atom and to form a negative ion. The first effect is due to the large number of electrons in the outermost group; hence the attraction from the nucleus is not compensated to the same extent as in configurations where the outer group consists only of a few electrons, as is the case in those families of elements which in the periodic table follow immediately after the elements of the family of the inactive gases, and, as is well known, possess a distinct electro-positive character. The second effect is due to the regular constitution of the outermost group, which prevents a new electron from entering as a further member of this group. In the elements belonging to the families which in the periodic table precede the family of the inactive gases

we meet in the neutral atom with configurations of the outermost group of electrons which, on the other hand, exhibit a great tendency to complete themselves by the binding of further electrons, resulting in the formation of negative ions.

The general lines of the latter considerations are known from various recent theories of atomic constitution, such as those of A. Kossel and G. Lewis, based on a systematic discussion of chemical evidence. In these theories the electro-positive and electro-negative characters of these families in the periodic table are interpreted by the assumption that the outer electrons in the atoms of the inactive gases are arranged in especially regular and stable configurations, without, however, any attempt to give a detailed picture of the constitution and formation of these groups. In this connection it may be of interest to direct attention to the fundamental difference between the picture of atomic constitution indicated in this letter and that developed by Langmuir on the basis of the assumption of stationary or oscillating electrons in the atom, referred to in Dr. Campbell's letter. Quite apart from the fact that in Langmuir's theory the stability of the configuration of the electrons is considered rather as a postulated property of the atom, for which no detailed *a priori* interpretation is offered, this difference discloses itself clearly by the fact that in Langmuir's theory a constitution of the atoms of the inactive gases is assumed in which the number of electrons is always largest in the outermost shell. Thus the sequence of the number of electrons within the groups of a niton atom is, instead of that indicated above, assumed to be 2, 8, 18, 18, 32, such as the appearance of the periods in the sequence of the elements might seem to claim at first sight.

The assumption of the presence of the larger groups in the interior of the atom, which is an immediate consequence of the argument underlying the present theory, appears, however, to offer not merely a more suitable basis for the interpretation of the general properties of the elements, but especially an immediate interpretation of the appearance of such families of elements within the periodic table, where the chemical properties of successive elements differ only very slightly from each other. The existence of such families appears, in fact, as a direct consequence of the formation of groups containing a larger number of electrons in the interior of the atom when proceeding through the sequence of the elements. Thus in the family of the rare earths we may be assumed to be witnessing the successive formation of an inner group of thirty-two electrons at that place in the atom where formerly the corresponding group possessed only eighteen electrons. In a similar way we may suppose the appearance of the iron, palladium, and platinum families to be witnessing stages of the formation of groups of eighteen electrons. Compared with the appearance of the family of the rare earths, however, the conditions are here somewhat more complicated, because we have to do with the formation of a group which lies closer to the surface of the atom, and where, therefore, the rapid increase in the compensation of the nuclear charge during the progress of the binding process plays a greater part. In fact, we have to do in the cases in question, not, as in the rare earths, with a transformation which in its effects keeps inside one and the same group, and where, therefore, the increase in the number in this group is simply reflected in the number of the elements within the family under consideration, but we are witnesses of a transformation which is accompanied by a confluence of several outer groups of electrons.

In a fuller account which will be published soon

the questions here discussed will be treated in greater detail. In this letter it is my intention only to direct attention to the possibilities which the elaboration of the principles underlying the spectral applications of the quantum theory seems to open for the interpretation of other properties of the elements. In this connection I should also like to mention that it seems possible, from the examination of the change of the spectra of the elements in the presence of magnetic fields, to develop an argument which promises to throw light on the difficulties which have hitherto been involved in the explanation of the characteristic magnetic properties of the elements, and have been discussed in various recent letters in NATURE.

N. BOHR.

Copenhagen, February 14.

The Dimensions of Atoms and Molecules.

CERTAIN relations which are to be traced between the distances separating atoms in a crystal make it possible to estimate the distance between their centres when linked together in chemical combination. On the Lewis-Langmuir theory of atomic constitution, two electro-negative elements when combined hold one or more pairs of electrons in common, so that the outer electron shell of one atom may be regarded as coincident with that of the other at the point where the atoms are linked together. From this point of view, estimates may be made (W. L. Bragg, *Phil. Mag.*, vol. xi., August, 1920) from crystal data of the diameters of these outer shells. The outer shell of neon, for example, was estimated from the apparent diameters of the carbon, nitrogen, oxygen, and fluorine atoms, which show a gradual approximation to a minimum value of 1.30×10^{-8} cm. The diameters of the inert gases as found in this way are given in the second column of the following table:

Gas	Diameter 2σ (Crystals)	Diameter $2\sigma'$ (Viscosity)	Difference $2\sigma' - 2\sigma$
Helium	...	1.89	—
Neon	... 1.30	2.35	1.05
Argon	... 2.05	2.87	0.82
Krypton	... 2.35	3.19	0.84
Xenon	... 2.70	3.51	0.81

In the third column are given Rankine's values (A. O. Rankine, *Proc. Roy. Soc., A*, vol. xcvi., 693, pp. 360-74, February, 1921) for the diameters of the inert gases calculated from their viscosities by Chapman's formula (S. Chapman, *Phil. Trans. Roy. Soc., A*, vol. ccxvi., pp. 279-348, December, 1915). These are considerably greater than the diameters calculated from crystals, but this is not surprising in view of our ignorance both of the field of force surrounding the outer electron shells and of the nature of the electron-sharing which links the atoms together, for it is quite possible that their structures might coalesce to a considerable extent. The constancy of the differences between the two estimates given in the fourth column shows that the increase in the size of the atom as each successive electron shell is added is nearly the same (except in the case of neon), whether measured by viscosity or by the crystal data. Further, Rankine has shown that the molecule Cl_2 behaves as regards its viscosity like two argon atoms with a distance between their centres very closely equal to that calculated from crystals, and that the same is true for the pairs Br_2 and krypton, I_2 and xenon.

We see, therefore, that the evidence both of crystals and viscosity measurements indicates that (a) the elements at the end of any one period in the periodic table are very nearly identical as regards the diameters

of their outer electron shells, and (b) in passing from one period to the next there is a definite increase in the dimensions of the outer electron shell, the absolute amount of this increase estimated by viscosity agreeing closely with that determined from crystal measurements.

A further check on these measurements is afforded by the infra-red absorption spectra of HF, HCl, and HBr. The wave-number difference $\delta\nu$ between successive absorption lines determines the moment of inertia I of the molecule in each case, the formula being

$$\delta\nu = \frac{h}{4\pi^2 c I},$$

where h is Planck's constant and c the velocity of light.

It is therefore possible to calculate the distances between the centres of the nuclei in each molecule, for

$$s^2 = \frac{m + m'}{mm'} \cdot \frac{h}{4\pi^2 c m_n \delta\nu},$$

where m and m' are the atomic weights relative to hydrogen and m_n the mass of the hydrogen atom. The following table gives these distances (E. S. Imes, *Astroph. Journal*, vol. 1, p. 251, 1919). It will be seen that there are again increases in passing from F to Cl and Cl to Br, which agree closely with the increases in the radii σ of the electron shells given by the crystal and viscosity data.

$s \times 10^8$		$\sigma \times 10^8$ (Crystals)	$\sigma' \times 10^8$ (Viscosity)
HF 0.93	Neon (= F) ...	0.65	1.17
HCl 1.28	Argon (= Cl) ...	1.02	1.43
HBr 1.43	Krypton (= Br) ...	1.17	1.58
HI —	Xenon (= I) ...	1.35	1.75

The increase from fluorine to chlorine of 0.35×10^{-8} cm. confirms the estimate given by crystals of 0.37×10^{-8} cm., as against the estimate 0.26×10^{-8} cm. given by viscosity data. It follows from the above that the distance between the hydrogen nucleus and the centre of an electro-negative atom to which it is attached is obtained by adding 0.26×10^{-8} cm. to the radius of the electro-negative atom as given by crystal structures. The radius of the inner electron orbit, according to Bohr's theory, is 0.53×10^{-8} cm., double this value. The crystal data, therefore, predict the value $\delta\nu = 13.0 \text{ cm.}^{-1}$ for the HI molecule, corresponding to a distance 1.61×10^{-8} cm. between their atomic centres.

This evidence is interesting as indicating that the forces binding the atoms together are localised at that part of the electron shell where linking takes place.

W. L. BRAGG.
H. BELL.

Manchester University, March 16.

The International Research Council.

THE object of this council, says Sir Arthur Schuster in NATURE of March 17, is "to reorganise international work which had come to a standstill through the war, and to extend it where found desirable." It may be worth while to consider for a moment how the council has set to work to promote these innocent and laudable ends.

The statutes of the council exclude members of "enemy" countries from every "international" union formed under its auspices until 1931. After that date the statutes may be amended, but only by a two-thirds majority; and amendment is not within the competence of any particular union concerned. "Once an international union is established," says Sir Arthur Schuster, "it become autonomous" except "in a few matters in which a common policy is desirable." He might perhaps have added that these "few matters" include the one and only matter about which there is any difference of opinion; and that, so far as co-operation with "enemy" countries is concerned, any science which consents to form a union loses its autonomy completely. Einstein may attend a congress of physics after 1931 if more than two-thirds, not of the physicists of the world, but of the members of the council, consider it advisable to allow him.

I have some experience of the working of the statutes myself, for I was a member of the committee appointed to consider the formation of a Union of Mathematics. When this committee met I moved, on behalf of the society of which I was a representative, that it was desirable "that any union which should be formed should be thrown open to the mathematicians of all nations at the earliest practicable opportunity." This resolution was rejected, not on the ground that it did not represent the general opinion of mathematicians (as beyond doubt it did), but on the ground that it conflicted with the statutes of the council.

The object of this council is not to promote international co-operation, but to exclude the Germans from it. I do not know who wrote the article in the *Times* of which Sir Arthur Schuster complains, nor have I any direct information as to the decisions of English biologists; but if indeed they have refused to join on the ground that the formation of a union "would perpetuate differences which should be left to time to heal," then they deserve the thanks of every English man of science; and so, too, does the correspondent of the *Times*, who has blurted out what so many of us have been feeling and so few have had the courage or the energy to say. G. H. HARDY.

New College, Oxford, March 21.

Solar Radiation in Relation to Faculae.

IN my letter published in NATURE of January 13, p. 630, it was suggested that the apparent relation between increased solar radiation and sun-spots was due to outbursts of heated gases accompanying the spots. This conclusion seems confirmed by later observations furnished from the Observatory of La Plata by Mr. Bernhard H. Dawson.

Since September there have been eleven cases in which outbursts of faculae were observed on the east edge of the sun, and eight in which they were observed on the west edge. The accompanying table shows the mean values of solar radiation preceding and following the appearance of these faculae. Zero day indicates the day of observation and the numbers are the amounts exceeding 1-900 calories per sq. cm. per minute.

Faculae on East Limb of Sun.

	Before		Days after													
	1	0	1	2	3	4	5	6	7	8	9	10	11	12	13	14
Solar radiation	38	60	42	38	52	49	49	54	49	50	50	44	56	60	59	51

Faculae on West Limb of Sun.

	Days before														After	
	13	12	11	10	9	8	7	6	5	4	3	2	1	0	1	2
Solar radiation	58	44	56	58	49	56	56	55	55	48	51	46	54	62	-	47

NO. 2682, VOL. 107]

These results show a marked maximum of solar radiation on the day of observation whether the faculae were on the east limb or the west limb. After their appearance on the east limb there was a second maximum twelve days later, and there was also a maximum ten to eleven days preceding the observation of faculae on the west limb.

The results are plotted in the accompanying diagram (Fig. 1). It would seem from these results

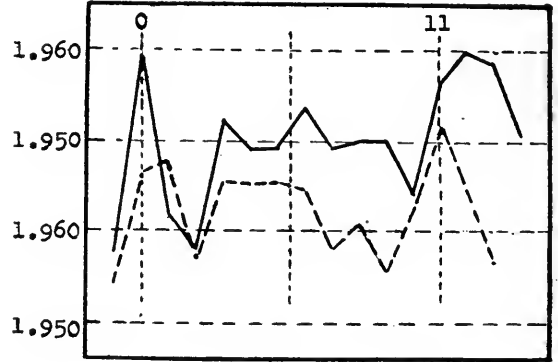

FIG. 1.

that outbreaks of heated gases on the edge of the sun result in increasing the effective radiative surface of the sun, and thus intensify the solar radiation.

H. H. CLAYTON.

Buenos Aires, February 19.

The Sound of Distant Gun-fire.

FATHER SCHAFFERS'S letter in NATURE of March 10 on the audibility of gun-fire sounds when travelling through air prompts me to ask if observations have ever been made upon such sound-waves when passing through the earth's crust. In 1917 I commenced to dig gravel in my garden here. The pit finally reached a depth of 12 ft., and was about 7 ft. long by 6 ft. wide. When I had reached a depth of about 6 ft., and from that point downwards, I constantly heard the sounds of gun-fire, while at the surface they were quite inaudible. The digging out of gravel was carried on at intervals during a period of many months, and I must have heard the sounds dozens of times. C. CARUS-WILSON.

Strawberry Hill.

MANY observations similar to the interesting one recorded by Mr. Carus-Wilson were made during the war. The sounds of gun-fire were heard plainly in excavations, though they were inaudible on the ground above. They were even heard by persons lying with their heads on the ground, but not when sitting up. Mallet remarks that the noise of the firing at the Battle of Jena in 1806 was heard as a low murmur in the fields about Dresden, at a distance of 92 miles, but he adds that "it is almost certain that in this case the noise was transmitted through the earth" (Brit. Assoc. Rep., 1851, p. 283). Grouchy and his officers at Sart-les-Walhain are said to have heard the firing at Waterloo. They "placed their ears to the ground and thus detected plainly the muffled boom of distant guns."

CHARLES DAIVSON.

"Dunster," Cavendish Avenue, Cambridge.

Electrons.¹

By SIR WILLIAM BRAGG, K.B.E., F.R.S.

II.

KEEPING in mind the results already described, we can now appreciate a very remarkable development of electron theory which has been made in the last few years. Spectrum analysis has long been occupied with the extraordinary complications of the light radiation emitted by the various atoms. As a result it appears that the frequencies of the lines in a spectrum often display curious and exact numerical relations, in the form generally involving differences of frequencies of similar lines or groups of lines. For instance, the famous Balmer equation:—

$$\text{Frequency} = \nu = N(1/n_1^2 - 1/n_2^2),$$

where $N = 3.290 \times 10^{15}$, gives the frequencies of series of lines in the hydrogen spectrum. When n_1 is put equal to 2, and n_2 to 3, 4, 5 in succession, the series of values for ν represent the frequencies of the lines in the visible spectrum. If

$$n_1 = 3 \text{ and } n_2 = 4, 5, 6, \dots,$$

in succession, we have the frequencies of lines in the infra-red (Paschen); and if

$$n_1 = 1, n_2 = 2, 3, 4, \dots,$$

we have the frequencies recently shown by Lyman to exist in the ultra-violet.

Now there is nothing in our older conception of the origin of radiation within the atom to give us a clue as to why differences of frequencies should come into these empirical, though most useful, formulæ. We have pictured to ourselves vibrating systems, mechanical or electric, and waves arising therefrom. But what connection between masses or electricities gives us in any simple way equations involving the addition or subtraction of frequencies? We are in a blind alley. Let us, therefore, abandon our preconceptions as to the origin of those lines which we find in the light spectrum and suppose that here also they arise in the same fashion as we actually know that they arise in the cases we have considered above. Suppose that the energy of an emission of radiation is derived from the energy of an electron. It may be the only way in which radiation ever does arise, but it is not necessary to suppose so much at present. It is enough that we carry into the atom the whole process which in X-rays and the photo-electric effect we have observed to take place in part outside. Suppose that within the atom there are certain positions or conditions in which electrons *may* be, each postulating a certain energy associated with the electron; and suppose that sometimes an electron slips from one position to another of lower energy, and that the difference in energies is transformed into wave radiation according to the same law as before, *i.e.*

energy transferred = $h \times$ frequency. Let the energy in these states be $Nh/1^2$; $Nh/2^2$; $Nh/3^2$; etc., and so on. Then all the series yielded by the Balmer formula are accounted for at the same time.

What may these states be? Why not, as Bohr suggests, so many different orbits in which electrons can move round the central positive nucleus in the atom, the nucleus the sure existence of which Rutherford has established? At one time, if we had presumed the existence of these orbits, we should have been inclined to connect them with the direct emission of radiation, and the frequency of that radiation would be the number of revolutions in a second. But now we assume these orbits to persist without radiation, and that radiation arises where the electron steps from one orbit to another; moreover, the frequency of the issuing radiation is determined by the simple rule: Frequency is equal to change of electron energy divided by h . We are not picturing any new process here, or evolving new ideas to fit awkward facts; we are supposing a process to exist in one place which we already know to exist in another.

It is a very remarkable fact that the number N is equal to $2\pi^2me^4/h^3$ within small errors of experiment. Spectrum measurements show that N is equal to 3.29033×10^{15} ; and $2\pi^2me^4/h^3$ is equal, taking the most recent determinations of m , e , and h , to 3.289×10^{15} . Imagine an electron revolving in a circle about the positive nucleus of the hydrogen atom according to the orthodox laws of dynamics with kinetic energy $2\pi^2me^4/n^2h^2 = Nh/n^2$. Its velocity, v , is $2\pi e^2/hn$; the radius, r , of the circular orbit is found by putting $mv^2/r = e^2/r^2$, and is equal to $n^2h^2/4\pi^2e^2m$. The angular momentum is $mvr = nh/2\pi$. If the electron changes its orbit from $n = n_2$ to $n = n_1$, where n_2 is greater than n_1 , its kinetic energy in the new orbit is *greater* than in the old by $Nh(1/n_1^2 - 1/n_2^2)$. But an amount of potential energy has been set free equal to $e^2(1/r_1 - 1/r_2)$, and this is equal to twice the change in kinetic energy, as is easily seen by substituting for the r 's their values as found above. Consequently, the right amount of energy is available for radiation. We can, therefore, following Bohr, define the necessary separate states as those of motion in circular orbits in which the angular momentum is an integral multiple of $h/2\pi$. The simplicity of these expressions is very attractive. But the matter is far from ending here. During the last few years Bohr and Sommerfeld have led an inquiry into the possibilities of this theory which has produced very remarkable results. These are due to a slight modification in the original conception. The different circular orbits which Bohr first pictured have become groups of orbits fixed by laws which are somewhat arbitrary, but not without foundation. A group contains a limited number of orbits

¹ The Twelfth Kelvin Lecture delivered before the Institution of Electrical Engineers on January 13. Continued from p. 82.

in which the electrons may move, and each group corresponds to one of the original circular orbits. Some of the orbits in each group are elliptical. It appears that the energy of the electron would be the same in all the orbits of any one group were it not that when an electron moves in an ellipse its velocity is not always the same. Now a fast-moving electron shows a variation in mass when its speed alters, and this does affect slightly the energy of the orbit. Consequently, the electron that steps from an orbit belonging to one group to an orbit belonging to another group may part with an amount of energy which is not always exactly the same. The frequency of the consequent radiation may, therefore, have two or more values differing slightly from each other: the single spectrum line is doubled or trebled. This is what Sommerfeld calls the "fine structure" of the lines.

Now there is far more than mere speculation in this. The formula which Sommerfeld gives as



FIG. 2.—Model of the arrangement of carbon atoms in the diamond. All the atoms are alike, but those represented by light spheres differ in orientation from those represented by dark spheres.

the result of an analysis which is as reasonable as can be expected does more than account for known effects; it has predicted the existence of numerous lines, and even their intensities, and the predictions have been verified by experiment in the most remarkable way. The story is told in Sommerfeld's work on "Atom-building": a story of the work of himself, Bohr, and others during the last six years or so.

We see that in this fundamental inquiry into the nature and properties of radiation the electron plays a very direct and important part. Our eyes are designed to detect waves, not electrons, and so our first attention is directed to radiation in wave form. But we now find that radiation energy may alternatively be carried by electrons, and that many things become clearer when we appreciate this fact. We can make further progress in our understanding of radiation, and indeed in our understanding of the electron, only by getting to know more about the reciprocal con-

version of one form of energy into the other, since evidently it is one of the most frequent and most fundamental operations in Nature.

So far our conception of the structure of an atom would consist of a positive nucleus and of electrons attached thereto in some way, with the further idea that the energy attached to these electrons can have only certain definite values. Bohr assumes that they have these values because they can move round the core in certain orbits only, and Sommerfeld enlarges this idea, as already explained. But, of course, this can be no more than a partial picture of the whole atomic structure. The atom so conceived cannot fill the part required of it in the building of molecules and crystals.

When we come to examine these structures we find atoms attaching themselves to each other through the action of forces which cannot always be considered as acting from centre to centre. For instance, the arrangement of the carbon atoms



FIG. 3.—An extra ball can be inserted in the model without disturbing other balls.

in a diamond, as recently determined by X-ray methods, is such that every atom is at the centre of gravity of four others, arranged round it in tetrahedral fashion, as shown in the model. The representation of an atom by a smooth sphere and nothing more would be in agreement with the idea that the properties of the atom in any one radial direction are exactly the same as in any other radial direction, and that any forces between two atoms are between centre and centre. But if that were the case, the carbon atoms would pack themselves together more closely than they do. As a matter of fact, if the top of this model is lifted, another carbon atom can be inserted and the top replaced exactly as it was. If a more extensive model were employed, it would be seen that just twice as many atoms could be packed into any volume as are already there. We must conclude that there are definite subcentres of force on the outskirts of the atom, and that in the carbon atoms of which the dia-

mond is composed there are four such sub-centres arranged symmetrically—that is to say, in tetrahedral fashion round the core.

Must not these sub-centres be electrons? And if so, must we not take them to be circulating in small orbits about a local centre? Or, perhaps, as Parson has suggested, the electron is ring-shaped, the electricity revolving round the axis of the ring. In this way we should have electromagnetic forces to link the atoms together.

It is very interesting to observe that, in any case, the carbon atoms in the diamond are not all oriented in exactly the same way. Taking a cleavage or tetrahedral plane as that of reference, half the atoms will be pointing towards the plane and the other half pointing away. This ought to make a difference to the X-ray spectra, and it has been looked for at various times, but without success. Lately, however, the improvement in the X-ray spectrometer has been considerable, and I now have no difficulty in finding the expected effect.² It is clear, I think, that the carbon atom in the diamond is to be represented as to its properties by a tetrahedron, and that the atom has different properties in different directions, or, as the chemist would say, has directed valencies. There can be little doubt that

² There is, in fact, a small second-order spectrum in the reflection of X-rays by the tetrahedral plane.

this is so in all atoms. The suggestion is that some of the electrons in an atom forming part of a crystal are tied down to certain regions on the surface, and that not all, if indeed any, of them are at all times revolving round the central core.

When atom joins up to atom it is these sub-centres that are at work; and since atom to atom and again atom to atom make in the end the crystal, and since the crystalline structure is the basis of all solid structure, and is fundamentally concerned with the strength of materials and their temper and all their physical properties, it is easy to see how great is this minute study of the electron.

If this conception of fixed electrons seems to clash with the orbital motions of Bohr and Sommerfeld, we must remember that the clash is between two pictures both of which are, we know, imperfect. We may expect that on the next occasion when a lecturer tries to tell you what advance has been made in the study of electrons some of these contradictions will have disappeared. Whether it will so turn out or not, I am sure of this, that in the attempt to realise the properties of Nature's unit, the electron, we are working in the true direction towards an understanding of the great problems of radiation and of material structure.

Reformed Cannibals.¹

NEW GUINEA, despite the considerable amount of attention that has been paid to it, has still large areas unexplored, and many peoples about whom nothing is known. Extremely little, even in the "Annual Reports of New Guinea," has been written about the natives of the D'Entrecasteaux group, the large mountainous islands which lie off the north coast of the south-eastern end of New Guinea, although a good deal of information has been collected about some of the peoples on the adjacent mainland and about the Trobriand Islanders farther east. An ideal opportunity was thus open to Mr. Jenness, a distinguished classical student of Balliol, who was one of the first to obtain the Oxford diploma in anthropology. A further advantage he had was in the collaboration with his brother-in-law, the Rev. A. Ballantyne, who for nine years had been a missionary on Goodenough Island.

The result of this partnership is a pleasantly written, sympathetic account of the Goodenough Islanders, which fills up one of the many gaps in our knowledge of the ethnology of New Guinea. The authors have given a succinct account of native life from the economic, social, and psychical points of view, and it is a comfort to students at home to feel that they have here something on which they can rely implicitly. Specialists will naturally turn to particular chapters, but all

¹ "The Northern D'Entrecasteaux." By D. Jenness and the late Rev. A. Ballantyne. With a preface by R. R. Marett. Pp. 219. (Oxford: At the Clarendon Press, 1920.) 12s. 6d. net.

should read the book through in order to get a complete view of the mode of life, actions, ideas, and ideals of the people; these are all interdependent and cannot satisfactorily be studied apart.

We may perhaps attribute the conciseness of the book to the present cost of book-production, but a little more detail in various sections would have added to its value. We are, however, given the hope that other matter may be published later; we trust that this will be the case, and that the material culture will receive fuller treatment, for we learn that the collections have now reached the Pitt-Rivers Museum. We should also like to hear more about the stone sitting-places and their connection with cannibalism, and about the use of memorial- and grave-stones, as these are doubtless connected with one of the great culture migrations into Oceania. Evidently it was not the intention of the authors to enter into the thorny paths of racial or cultural migrations, or even to give parallels among neighbouring people; so they have rigidly confined themselves to what they have themselves noted, and this is all that we can demand of them. A field-observer who is alive to the wider problems will usually be able to appreciate the value of small details which might otherwise be overlooked or considered as too trivial to mention; but in any case generalisation should not be mixed up with description, and our authors have not fallen into this common practice.

The curious custom of chopping off a finger-

joint on the death of a relative seems to have been peculiar to Goodenough. It was first noted by M. H. Moreton, R.M., in his report, Appendix N to the "Annual Report on British New Guinea," 1897-98. He describes which joints are cut off for special relatives, and adds: "They do not, as a rule, disjoint the fingers of the right hand, but, on the occasion of a man distinguishing himself in fighting, the first joint of the third finger of the right hand is lopped off. This custom is

adults shrank from the pain this mutilation caused, so little children were made the victims. . . . Men seldom lose more than two or three finger-joints [never of the thumb or of the right-hand little finger], but it is not at all unusual for a woman to have all the fingers (not the thumbs) of one or even of both hands maimed," but only the terminal phalanges are removed. One lore-learned native said that "all the dead go to Wafolo [an uninhabited district on the north-west side of Fergusson Island] except those with unchopped fingers; these are killed and eaten by some dogs that bar their path."



FIG. 1.—A Kabuna youth, Mud Bay, Goodenough Island. From "The Northern D'Entrecasteaux."



FIG. 2.—Fishing with traps and hauling up a square fish-net, *lata*, Mud Bay, Goodenough Island. From "The Northern D'Entrecasteaux."

falling into disuse. . . . I do not know that the custom of disjointing is practised in a single other district. . . . I have noticed many natives with mutilated left hands." Our authors do not refer to Moreton's statement, nor do they confirm or deny any association between the particular joint and a definite relationship. They describe the method, and say that "in Mud Bay

Mr. Ballantyne's long and intimate knowledge of the natives gives especial authority to the estimate of the psychology of the natives and of their magico-religious beliefs and customs, and it is in this section that the partnership of a missionary and a trained ethnologist is particularly valuable. Thirty-seven excellent photographs add to the interest of this instructive book. A. C. H.

Obituary.

PROF. A. G. NATHORST.

ALFRED GABRIEL NATHORST, who for the greater part of his life was Director of the Palaeobotanical Museum of the Swedish Academy, died at Stockholm on January 20 at seventy years of age. In many respects Nathorst was a remarkable man; precluded by deafness from the ordinary means of communicating with his fellows, he had an almost uncanny power of divining the point of a remark before it was fully expressed in writing on the tablet which he always carried with him: a keen sense of humour, a boyish love of the ridiculous, and a lovable personality made him a delightful companion. Some chance word or incident would lead him to quote verbatim passages from Dickens, especially "The Pickwick Papers," Kipling, or other favourite author; he wrote and spoke English and German with apparent ease,

and some of his papers are written in French. In him, as in comparatively few men, were combined the naturalist's love of the open air and the lust of travel with the patience of the laboratory student.

Nathorst paid his first visit to England in 1872, when he met Sir Charles Lyell, whose "Principles of Geology," as he stated in acknowledging the award of the Lyell medal from the Geological Society in 1904, first attracted him to the study of geology. In 1870 he went to Spitsbergen, where he became familiar with recent Arctic plants, and on his return he investigated fresh-water Pleistocene beds in Denmark, Germany, Switzerland, and England, utilising his knowledge of existing species in tracing the distribution of Arctic plants in Europe during the Glacial period. A series of travel-notes published in 1880 contains many valuable opinions on fossil plants from Meso-

zoic and Tertiary localities in English collections. In 1879 he collected specimens of the dwarf birch at Bridlington, and on later visits he always divided his time between conferences or excursions with Mr. Clement Reid and collecting plants from the Jurassic rocks of Yorkshire. A summary of his work on the distribution of Arctic plants during the Glacial epoch was contributed by him to *NATURE* for January 21, 1892.

In 1907 Nathorst attended the centenary of the Geological Society as a delegate of the Swedish Academy, and received the Sc.D. degree from the University of Cambridge. In 1909 he returned to Cambridge as a delegate to the Darwin celebrations. In 1917, at the age of sixty-seven, in accordance with Swedish custom, he retired from the museum directorship. After his retirement his researches were frequently interrupted by heart trouble, but he had the satisfaction of completing an important memoir, published last year, in continuation of his well-known investigations of the Lower Carboniferous flora of Spitsbergen. Nathorst's contributions to knowledge cover a very wide field—Arctic exploration, stratigraphical and tectonic geology, palæontology in the broadest sense, and recent botany. In 1882 he again visited Spitsbergen, and in 1898 he was the scientific leader of an expedition, primarily in search of Andrée, to Bear Island, King Charles Land, and other regions; it was in the course of this expedition that he circumnavigated Spitsbergen. He described his experiences of two summers in polar seas in an attractive two-volume book written in Swedish and published in 1900, and the scientific results of the voyage, both geological and palæobotanical, have appeared in a succession of valuable papers.

Nathorst's first paper, in 1869, was on Cambrian rocks of Scania, and this was followed by a series of botanical and geological papers. In 1875 he published the first of a long series of contributions to our knowledge of the rich Rhætic floras of Scania, which have thrown a flood of light upon many extinct types, and incidentally have illustrated in a most striking manner the possibilities of the intensive study of the fossil plants of a single region. Though he became more and more absorbed in palæobotanical researches, he always retained an active interest in both geology and botany; the range of his work was exceptionally wide. He had few equals in the extent of his knowledge and in breadth of view.

It is to Nathorst more than to any other man that we owe our knowledge of Arctic floras extending from the Devonian to the Late Tertiary period. His work is characterised by meticulous accuracy, lucidity of presentation, originality, and philosophical treatment. In 1904 he contributed to the French Academy a preliminary account of a remarkable collection of Jurassic plants from Graham Land, on the borders of Antarctica, which demonstrated the almost world-wide distribution of certain ferns and cycadean plants. His palæobotanical papers deal with floras from Japan, the New Siberian Islands, the Arctic regions gener-

ally, Scandinavia, and other parts of the world. By his researches into the Jurassic plants of Yorkshire, Nathorst not only added greatly to knowledge, but also stimulated other workers in the same field, and his friendly invasion of the East Coast increased the activity of some English palæobotanists. His discovery of male flowers of *Williamsonia* and of several new types of the genus is of special interest to English students. An improved method, which he invented, of treating the carbonised or mummified impressions of plants led to fruitful results both from his own researches and from those of others. His demonstration of the true nature of many supposed Palæozoic Algae marked an important advance in accurate knowledge and in experimental methods of research.

Of special interest from the point of view of evolution are Nathorst's discoveries of many new generic types, such as *Pseudobornia*, a primitive Devonian plant combining characters of the Equisetales and the extinct group Sphenophyllales; *Lycostrobus*, a Rhætic lycopodiaceous cone comparable to the large Palæozoic *Lepidostrobi*; *Cephalotheca*, a new Devonian fern with peculiar fertile pinnæ; several new seeds from Lower Carboniferous rocks of Spitsbergen; *Wielandiella*, a remarkable cycadean genus bearing bi-sporangiate flowers and in habit entirely different from that of recent cycads; *Cycadocephalus*, a Rhætic cycadean micro-strobilus; and *Camptopteris*, one of several Rhætic ferns which he described in detail. He also made numerous important additions to our more accurate knowledge of cycadean fronds included in the group *Cycadophyta* (a name instituted by Nathorst), and investigated the past history of the *Ginkgoales*, a group with one existing representative, the maiden-hair tree.

The Palæobotanical Museum of Stockholm, which was worthily housed in a new building, erected by the Government at a cost of 140,000*l.*, a few years before his death, is an epitome of his achievements and a monument of which his native country may be justly proud. In no other country has palæobotanical research received a more generous recognition; it is usually relegated to a position of secondary importance.

It would be difficult to exaggerate the value of Nathorst's contributions to natural knowledge; he devoted his life to research, and it was always a joy to him to give all the assistance he could to other workers who appealed to him for guidance. As a critic he would take infinite pains, and it was never a trouble to him promptly to answer in a letter of almost perfect English the most trivial questions. Those who were among his regular correspondents have lost a true friend, the value and stimulating effect of whose wise counsel and frank but kindly criticism cannot at once be thoroughly appreciated.

Nathorst was fortunately able to retire with the knowledge that his successor and pupil, Dr. Halle, would fully maintain the high standard of palæobotanical work which has long been associated with the Stockholm Museum. A. C. SEWARD.

ADOLF APPELLÖF, who died at Upsala on January 5, was born on the island of Gottland on November 2, 1857. In 1889 he became a conservator of the zoological collections in Bergens Museum, and succeeded to the keepership of the whole department in 1907, being at the same time made professor at the newly established university there. In 1910 he was appointed professor of comparative anatomy at Upsala, which post he held until the end. In his early writings on Cephalopoda, Appellöf showed that similarly hectocotylised arms arose in diverse groups; he threw light on the homologies of the shell in Sepia, Spirula, and Nautilus, and proved the occurrence of a shell in the octopods. Among many works on actinians, that on their development (1900) won for him the Nansen prize. Later he studied the Crustacea, wrote an important work on the decapods of Norway, and won the Joachim Friele gold medal with a memoir on the lobster. Two papers on Pycnogonids of the Arctic should not be forgotten. Such were Appellöf's chief publications; but he did a large amount of investigation into fishery and other zoological problems in expeditions along the Norwegian coast and, on the *Michael Sars*, to the North Sea and North Atlantic. His chief work, however, was the inspiring instruction of youth in the laboratory at Bergen, and later at Upsala and in the biological station of "The Club," which he founded five years ago on Gullmar Fjord. There, among the living sea-creatures and the merry students, Appellöf's cheerful enthusiasm found its untrammelled exercise.

F. A. B.

THE death of MR. HERBERT BYROM RANSOM is announced in *Engineering* for March 11. Mr. Ransom was born in 1867, and was educated at Cheltenham College, and passed through the

engineering course at University College, London. He received his practical training with Messrs. Manlove, Alliott, and Co., Ltd., Nottingham, and became a director of the company in 1902. In 1908 he retired to take up private practice. He was a member of the Institutions of Civil and Mechanical Engineers, and his papers to the former institution were awarded a Miller prize and scholarship, a Watt medal, and a Telford premium.

THE death is reported, in his eighty-third year, of DR. CHARLES H. FERNALD, professor of natural history at the Maine State College (now the University of Maine) from 1871 to 1886, and of zoology and entomology at the Massachusetts Agricultural College from 1886 to 1910. When the Hatch experiment station was established at the latter institution Dr. Fernald became the entomologist of the station. He had contributed largely to scientific journals, and in collaboration with Mr. E. H. Forbush prepared a large work on "The Gypsy Moth," which was published by the State. He was the father of Dr. H. T. Fernald, the present head of the entomological department at the Massachusetts Agricultural College.

THE death of SIR ARTHUR LEWIS WEBB on March 15 is announced in the *Engineer* for March 18. Sir Arthur was born in 1860, and entered the irrigation branch of the Public Works Department of India in 1881, after having passed through the Royal Engineering College at Coopers Hill. He was transferred to the Egyptian Irrigation Department in 1894, and rose to be Under-Secretary for Irrigation and Adviser to the Public Works Ministry. He was created K.C.M.G. in 1912.

Notes.

FOR the meeting of the British Association which will be held at Edinburgh on September 7-14 next the following presidents of Sections have been appointed:—Section A (Mathematics and Physics), Prof. O. W. Richardson; B (Chemistry), Dr. M. O. Forster; C (Geology), Dr. J. S. Flett; D (Zoology), Mr. E. S. Goodrich; E (Geography), Dr. D. G. Hogarth; F (Economics), Mr. W. L. Hichens; G (Engineering), Prof. A. H. Gibson; H (Anthropology), Sir J. Frazer; I (Physiology), Sir W. Morley Fletcher; J (Psychology), Prof. C. Lloyd Morgan; K (Botany), Dr. D. H. Scott; L (Education), Sir W. H. Hadow; and M (Agriculture), Mr. C. S. Orwin. Sir Richard Gregory has been appointed president of the Conference of Delegates of Corresponding Societies. Among the subjects of general interest which are being arranged for discussion at joint sectional meetings are:—The Age of the Earth, Biochemistry, Vocational Training and Tests, The Relation of Genetics to Agriculture, The Proposed Mid-Scotland Canal, and The Origin of the Scottish

NO. 2682, VOL. 107]

People. The president of the association, Sir Edward Thorpe, will deliver his address at the inaugural meeting on Wednesday evening, September 7, and discourses will be given at general evening meetings by Prof. C. E. Inglis on The Evolution of Cantilever Bridge Construction, involving a comparison between the Forth and Quebec bridges, and by Prof. W. A. Herdman, the present president, on Edinburgh and Oceanography. Measures are being taken towards a more effective co-ordination of the daily programmes in order to avoid the clashing of subjects of kindred interest.

THE SECRETARY FOR MINES has appointed Dr. F. H. Hatch to be Technical Adviser to the Mines Department on questions relating to the metalliferous mining industry.

SIR EDWARD THORPE (Great Britain), Prof. Le Chatelier (France), Prof. Ciamician (Italy), and Dr. Ernest Solvay (Belgium) have been elected honorary foreign members of the Chemists' Club, New York.

THE annual Wilbur Wright lecture of the Royal Aeronautical Society for this year is to be delivered by Major G. I. Taylor at the Royal Society of Arts on Tuesday, April 12, at 8 o'clock.

It is announced in *Science* for March 4 that the Bruce gold medal for the year 1921 of the Astronomical Society of the Pacific has been awarded to Dr. H. A. Deslandres, director of the Astrophysical Observatory of Meudon, near Paris, for his "distinguished services to astronomy."

THE International Institute of Anthropology, which has been founded at Paris, will hold a congress at Liège on July 25-August 1. The provisional programme appears in the current issue of the *Revue Anthropologique*, which has been adopted as the organ of the institute and of the Schools of Anthropology of Paris and of Liège. The central office of the institute is at 15 rue de l'Ecole de Médecine, Paris VI.

At the anniversary meeting of the Royal Irish Academy on March 16 Prof. Sydney Young was elected president in succession to the Most Rev. Dr. Bernard, Provost of Trinity College, Dublin, whose period of office has just expired. Prof. C. S. Sherrington, president of the Royal Society, was declared an honorary member in the section of science under the statute by which presidents of the Royal Society are honorary members of the academy.

THE summer meeting of the Institution of Electrical Engineers is to be held in Scotland on June 7-10, and a provisional programme for it has just been issued. Besides a number of visits to places of interest, the reading of the two following papers has been arranged for:—"The Dalmarnock Generating Station," R. B. Mitchell (at the Royal Technical College, Glasgow, on June 7), and "The Hydro-electric Resources of the Scottish Highlands," Prof. Magnus Maclean (in Glasgow University on June 8).

At the meeting of the Royal Geographical Society on Monday, March 21, the president announced that the King has sent a donation of 100*l.* towards the funds of the Mount Everest Expedition. The president added:—"Both his Majesty and her Majesty the Queen take the greatest interest in the expedition, and have questioned me closely as to our plans, the prospects of success, and the composition of the party; and they have assured me of the keen interest with which they will follow the progress of the expedition."

THE election to a Sorby research fellowship at the University of Sheffield will take place in June next. The appointment, subject to regulations, will be for five years, and the emoluments approximately 500*l.* per annum. The object of the fellowship is not the training of men for original research, but to obtain advances in natural knowledge by enabling men of proved ability to devote themselves to research. Applications for the fellowship should be made to the Secretaries of the Royal Society, Burlington House, W.1, by May 31, and such applications should give particulars of the candidate's scientific career and state the nature of the work he proposes to follow if elected.

At the annual general meeting of the Ray Society on March 10 the following officers were re-elected:—*President*: Prof. W. C. McIntosh *Treasurer*: Sir Sidney F. Harmer. *Secretary*: Dr. W. T. Calman. The Right Hon. Lord Rothschild was elected a vice-president, and Mr. E. E. Green, Mr. Chas. Oldham, and Sir David Prain were elected new members of council. The report of the council directed attention to the urgent need for a large increase in the number of subscribers if the society is to avoid the alternatives of raising the rate of subscription or restricting the annual output of publications. It was announced that the first part of the fourth volume of Prof. McIntosh's "British Marine Annelids" was in the press, and would form the issue to subscribers for 1920. Substantial grants towards the cost of publication of this work have been made by the Carnegie Trust for the Universities of Scotland and by the Royal Society.

A SECOND International Congress of Eugenics is to be held in New York City on September 22-28, under the honorary presidency of Dr. Alexander Graham Bell. The president of the congress is Prof. Henry Fairfield Osborn, its treasurer Mr. Madison Grant, hon. secretary Mrs. C. Neville Rolfe (of London), and general secretary Dr. C. C. Little. The papers to be read before the congress fall into four sections:—(1) Studies in human heredity, including the results of research in pure genetics which may be applicable to man. (2) The human family, including the factors that influence the fecundity of different strains and the differential mortality of the eugenically superior and inferior stocks; mate selection to be considered in this section. (3) Human racial differences; in this section will be considered the facts of migrations and the influences of racial characteristics on human history and miscegenation. (4) Applied eugenics; here will be discussed eugenics in relation to the State, to society, and to education. It is desired that all papers from Europe should be in the hands of the general secretary, Dr. C. C. Little, American Museum of Natural History, by May 1, and those from Canada and the United States not later than June 15. Persons having material for exhibition are requested to write at once to Dr. Little, stating its nature and size.

THE annual general meeting of the Chemical Society was held at Burlington House on March 17, when Sir James J. Dobbie, the retiring president, delivered his address. The following new officers and members of council were declared elected:—*President*: Sir James Walker. *Vice-Presidents who have filled the office of President*: Prof. H. E. Armstrong, Sir James J. Dobbie, Prof. W. H. Perkin, Sir William J. Pope, Dr. Alexander Scott, and Sir William A. Tilden. *Other Vice-Presidents*: Prof. F. G. Hopkins, Prof. F. S. Kipping, and Prof. J. F. Thorpe. *Ordinary Members of Council*: Prof. J. S. S. Brame, Dr. C. H. Desch, Mr. E. V. Evans, Mr. H. B. Hartley, Dr. T. S. Patterson, Dr. T. Slater Price, Mr. W. Rintoul, Dr. R. Robinson, and Dr. N. V. Sidgwick. In presenting the Longstaff medal to Prof. J. F. Thorpe the president referred to the importance of the researches on organic chemistry on which Prof. Thorpe and his colleagues had been engaged for many years. The

anniversary dinner was held at the Hotel Cecil the same evening, and was attended by more than two hundred fellows and guests. Sir James J. Dobbie was in the chair. Of the five jubilee past-presidents whom the council desired to entertain as guests of honour only Sir James Dewar and Sir William Tilden were able to be present. After the loyal toasts had been honoured Sir Alfred Mond gave the toast of "The Chemical Society," to which the president replied. The toast of "The Past-Presidents" was proposed by Prof. Harold B. Dixon, and response made by Sir James Dewar and Sir William A. Tilden; whilst Prof. C. Moureu (vice-president of the French Chemical Society), the Hon. Mr. Justice Sargant, and Prof. C. S. Sherrington (president of the Royal Society) replied to the toast of "The Guests," proposed by Prof. F. G. Donnan.

AN Appointments Committee for Russian Scientific and Literary Men has been formed under the chairmanship of Sir Arthur Schuster, among other members being Lord Bryce, Sir Frederic Kenyon, and Prof. Sherrington, president of the Royal Society. Numbers of distinguished Russian scholars, many of whom are destitute, while others are engaged in work for which they are unfitted, are scattered over European countries. It is the object of the committee to bring the names and qualifications of these men to the notice of universities and other institutions which may be able to offer them suitable employment. A list of names of those at present known to the committee has been received, and in it we notice the following:—Assistant-Prof. Vladimir Issaieff, technical chemistry (sugar and fermentation industries); Prof. Anatole Poppen, ophthalmology (specialist in trachoma); Prof. Lazar Rosenthal, bacteriology; Prof. Vadim Yurevich, bacteriology and infectious diseases; Assistant-Prof. Jacob Khlitchieff, naval engineering and shipbuilding; Assistant-Prof. Nicholas Znamensky, applied mechanics; Dr. Leonid Dubitzky, hygiene; Dr. Nicholas Hans, philosophy and psychology; Dr. Boris Perrot, hygiene and tuberculosis; Dr. Serge Chakhotin, zoology and physiology; Dr. Ernest Ferman, hygiene; and Dr. Boris Sokoloff, protozoology. The hon. secretary to the committee is Dr. C. J. Martin, Director, Lister Institute, London, S.W.1, and he will be glad to forward particulars of the careers of the men whose names are given above, or copies of the circular letter inviting anyone who knows of spheres of work in which they could be engaged to communicate with him. Opportunities for providing these stranded scientific workers with positions where their knowledge and experience could be usefully employed must arise from time to time in university and other institutions, and any assistance in bringing information of such possible openings to the notice of the committee would be gratefully welcomed.

AMONG many savage or barbaric races the belief in the dangers which occur in the course of house-building is widely felt. A good account of this is given in a paper by Dr. G. Landtman in *Acta Aca- demica Aboensis*, part i., in relation to the Papuan Kiwai tribe, inhabiting the district at the mouth of

the Fly River in British New Guinea. At present the people can give no exact explanation of the Darimo, or protective figures of the house. They do not seem to represent any definite being or beings. "The gloomy aspect of the figures and the uncanny, if indistinct, ideas associated with them exercise in themselves a powerful effect upon the native mind without any exact interpretation being required. It is enough for the people that the weird forms are possessed of mysterious properties, partly their own and partly those of the medicines applied to them."

THE study of the aborigines of Tasmania will be much advanced by the publication of a descriptive catalogue, prepared by Messrs. W. L. Crowther and C. E. Lord, of the osteological specimens contained in the Tasmanian Museum. The list forms a record of the largest single collection extant of osteological remains of the extinct Tasmanian aboriginal race. It embraces also specimens concerning which data are being gathered for publication, while additional particulars have been added to specimens already in part described. With the exception of the researches of Harper and Clarke, and later of Berry and Robertson, on certain of the crania contained in this list, none of the specimens have been described. Even the complete skeleton of Trucanini, the last of his race, remains to be measured and the indices to be tabulated. Some further specimens in private hands have been traced, and anthropologists will await with interest the completed results of the investigation.

In an interesting review (*Journal of Genetics*, vol. x., No. 4) of the sex-ratios and the various ways in which they have been modified in animals and plants, Mr. Julian S. Huxley discusses the relations of modified sex-ratios to the sex-chromosomes, and adopts the probable hypothesis that in many such cases the normal effect of the presence of one or two X-chromosomes has been overridden by a metabolic effect of some environmental factor. This factor may be delayed fertilisation (producing in frogs chiefly males, and also altering the sex-ratio in cattle), attack of the anthers by a smut in the plant *Lychnis dioica* causing the partial transformation of male plants into hermaphrodites, development of females from male crabs by parasitic castration, and in cattle the partial alteration of a female into a male when twinned with a male owing to the circulation in the blood of substances derived from the male embryo (Lillie). In all such cases the normal effect of the chromosome complex in development has been modified probably by the metabolic influence of substances not present in normal conditions. A similar interpretation is applied to the experiments of Goldschmidt and of Harrison with moths and of Riddle with pigeons. It is pointed out that aberrant sex-ratios may result from differential fertilisation, differential mortality of gametes or zygotes, or the overriding of the chromosome constitution by such external factors as those mentioned. This view is applied to an explanation of a case in the "millions fish" (*Girardinus poeciloides*), where there was first a great preponderance of males, then a lesser preponderance of females, and finally equality in the numbers of the sexes.

THE Scaphopoda (tusk shells) of the eastern coast of America have received careful systematic treatment by Mr. J. B. Henderson, whose account (*U.S. Nat. Mus., Bull.* 111, 1920) is based on the extensive collection in the United States National Museum and in other museums, and on several hundred lots from his own dredgings in the Florida Keys. The species appear to fall into two well-marked groups—a northern cold-water group extending from New England to Cape Hatteras, and having affinities with the species of northern Europe, and an Antillean assemblage.

MAJOR W. S. PATTON contributes to the *Indian Journal of Medical Research* (vol. vii., No. 4, 1920) an account of the Mesopotamian house-flies and their allies, and describes the measures against them which he adopted in the camp at Nasiriyeh, on the Euphrates. The principal means were:—(1) Incineration of manure and excrement to destroy the eggs and larvæ of flies; (2) the burying of fresh manure in the centre of a mound of manure previously accumulated and in which the temperature, owing to fermentation, was already high enough to kill eggs and larvæ—a method originally employed in France by Roubaud and now “thoroughly recommended” for a tropical climate by Major Patton after his experience of its usefulness in Mesopotamia; (3) the drowning of larvæ and pupæ; (4) the use of baited traps to catch adult flies; and (5) the burning at dusk of large numbers of flies which had congregated in the interior of huts erected at suitable points to serve as resting-places for the flies. Kerosene torches were passed rapidly over the walls and roofs of these huts for this purpose.

A LECTURE by Mr. W. B. Brierley on “Personal Impressions of American Biological Research” was given on Tuesday, March 15, at a meeting held at the Imperial College, South Kensington, by the National Union of Scientific Workers. Sir Daniel Hall occupied the chair. Mr. Brierley said that the most striking feature of American agriculture was the almost complete concentration in wide areas of a single crop, so that there were 500 miles together of maize, cotton, or rice, and not much smaller areas of fruit or vegetables for preserving. One consequence of this was that a plant disease ran riot through a whole area, and the field problems confronting the American agricultural biologist were so vast and menacing as almost to destroy the possibility of academic research except in the eastern industrial regions. In the industrial area, containing the older universities, the biological work approximated closely to that done in this country in subject and mode of attack, but in the State universities in the newer agricultural regions—each with its own single crop presenting urgent problems for solution—certain features were noticeable:—(1) An early and extreme specialisation, subjects which were here studied after a degree course in botany (such as plant pathology) being themselves degree courses, and the graduates immediately devoting themselves exclusively to the study of a single type of disease. (2) There was almost no gradation between the academic biologist

of real eminence and the ordinary worker dealing with a limited field of applied science.

THE United States Geological Survey has just issued a monograph (Professional Paper 96) on “The Geology and Ore Deposits of Ely, Nevada,” by Mr. Arthur C. Spencer. This work is notable as giving a very complete account of the occurrences of disseminated copper ore usually spoken of as the porphyry copper deposits. Their importance may be gauged from the fact that, although work upon them only commenced in 1908, in the period between then and 1915 nearly 20,000,000 tons of this ore had been treated, producing nearly 200,000 tons of copper, whilst some 95,000,000 tons of ore have been developed. The ore consists for the most part of monzonite porphyry of various types; true monzonite is a plutonic rock containing about equal amounts of orthoclase and plagioclase, together with hornblende, augite, or mica. The greater part of the monzonite in the Ely district is of the variety known as quartz monzonite, intermediate between granite and granodiorite. This rock appears to carry a certain quantity of primary copper minerals, chiefly chalcopyrite, in quantities sufficient to give about 0.5 per cent. of copper in the unaltered rock. The portions worked as ore have later undergone secondary enrichment; the copper has been leached out from the overlying parts until these contain only about 0.2 per cent. of copper, the leached zone extending to a depth varying between 20 ft. and 200 ft. The cupriferous solutions descending from these upper portions were decomposed lower down, depositing chalcocite and some additional chalcopyrite, thus bringing the copper contents of the workable portion up to 1.5 or 2 per cent.; the thickness of the zone thus enriched appears to be about 300 ft. in most parts. The mode in which these changes have probably been brought about has been carefully studied, and is described in full detail, and the work forms a valuable contribution to our knowledge of ore deposition.

MESSRS. NEGRETTI AND ZAMBRA have designed and produced an instrument called a rainfall rate recorder which registers on a revolving drum a graph of the actual rate of rainfall at any moment in inches per hour. The principle involves weighing the water as it passes down an inclined surface. The inclined surface is a tube in the shape of a spiral, and is suspended at one end of a balanced lever, the other end of which carries the pen. The spacing of the recording scale is more open for the lower than for the higher intensities. The instrument is capable of being made of great use, especially for engineers concerned with main drainage and similar works. An examination of the records obtained suggests that the initial record of a rainfall is fallacious, drops accumulating in the tube and starting with a record much higher than is true, whilst the curve at the end of a rainfall is similarly fallacious owing to drops remaining in the tube. These objections are far from trifling, and require to be got rid of before the instrument is really trustworthy, though when rain is falling heavily the changes in the rate of fall are

very clearly shown. The price of the instrument, with the necessary charts and plant, is 55*l*.

THE *Meteorological Magazine* for January contains a communication from Sir Napier Shaw concerning the possibility of dissipating fog by artificial heating, the subject having been suggested to him by an inquirer who alleged that he "had seen fog disperse over a football ground as the game proceeded." Sir Napier Shaw is clearly very dubious of the possibility of dissipating fog artificially, especially as in a fog the air is in motion and not absolutely still, as is generally supposed. A preliminary survey of the rainfall of 1920 is given; it is said to be divided into two well-marked periods, the first seven months being generally wet and the five later months generally dry. The total for the year was above the average in the west, but there was a deficiency along the east coast of Great Britain. The greatest excess was in Wales, where in places the total was 30 per cent. above the average. For the British Isles as a whole the rainfall in 1920 is estimated as 109 per cent. of the average. The Thames Valley rainfall map for December shows the greatest rainfall during that month to have occurred in the southern areas, in parts of Hampshire and Sussex, where it exceeded 4 in., whilst in the north, around Cambridge, the rainfall was 1.5 in. or less.

A PAPER by Prof. Gabriel Petit published in *La Nature* of October 16, 1920, gives an interesting account of the effect of radio-activity on the fertility of the soil. From the results of experiments on geraniums, chrysanthemums, etc., the author concludes that there is no doubt that radio-active substances exert a very favourable influence on the growth of plants. The experiments show that the treatment is harmful if the radio-active substance is present in too great quantity. Researches are therefore being continued in different parts of the country to decide on the optimum dose and on the best method of application; to discover which of the three kinds of rays—the α , β , or γ —are the most valuable, and whether the rays act on the plant directly or indirectly *via* the soil or *via* the micro-organisms in the soil; and, finally, to decide whether radio-activity has any influence on nitrogen fixation. It is clear that there is an almost unlimited field for experiments, and, in the author's opinion, there will undoubtedly be a great gain for agriculture from the scientific application of radio-active substances.

At the meeting of the Illuminating Engineering Society on March 17 Major A. Garrard read a paper entitled "Motor-car Headlights: Ideal Requirements and Practical Solutions." It was pointed out that the problem involves a compromise between two almost irreconcilable points of view, that of the driver of a car who requires a powerful beam impinging on distant persons and vehicles and that of approaching persons or drivers of other vehicles who are apt to be dazzled by the intense light of such a beam. On the whole, the best practical solution appears to lie in keeping all light below the eye-level, at the same time giving maximum intensity just below the boundary. Several headlights in which an attempt was made to realise this condition were shown at the

meeting. The lecturer suggested that the ideal beam should consist of (1) a bright, penetrating part, very shallow and relatively wide, projected along the road surface below eye-level; (2) a much wider beam, not so bright, illuminating hedges, etc., also all below eye-level; and (3) a generally diffused beam of very low intensity close to the car. He contended that these requirements cannot be met by any simple device or attachment to the ordinary parabolic headlamp, but only by some form of optical projecting apparatus employing at least one lens, which should not be materially more complex or expensive than the headlight of the present day.

THE *Bulletin de la Société d'encouragement pour l'Industrie nationale* for January contains the complete text of the public lecture given by Lt.-Col. Renard in February, 1920, on "The Evolution of Aeronautics during the War." Col. Renard points out that while in the war of 1870-71 the ordinary balloon played an important part, in the recent war its utility was insignificant. On the other hand, the captive balloon, which had been scrapped as out of date by the French military authorities in 1911, was used by the Germans from the very beginning of the war as a means of observation. Before the end of the war captive balloons of 800 to 1000 cubic metres capacity were in constant use. In the same way the development of the dirigible had only reached the stage represented by a volume of 8000 cubic metres in France in 1914, while in Germany Zeppelins of three times that volume had been constructed. The aeroplane had, on the contrary, been developed in France with enthusiasm, and speeds of 120 km. per hour attained. During the war this speed was doubled. Col. Renard urges on his country the importance of developing civil aviation as the best preparation for the next war, which he believes will open by the aerial bombardment of all the principal cities of one of the belligerents.

THE March issue of the *Philosophical Magazine* contains an article by Sir J. J. Thomson on the structure of the molecule and chemical combination, which collects together and amplifies the statements the author has made in his Royal Institution lectures during the past few years. He points out that the nuclear atom with revolving electrons is unstable, and replaces it by a positive nucleus with electrons in equilibrium around it, the equilibrium being secured by the law of action of nucleus and electron being taken as an attraction according to the inverse square of the distance at considerable distances, but as a repulsion at small distances. In these circumstances it is shown that one electron arranges itself at the distance from the nucleus at which attraction changes to repulsion, two arrange themselves on opposite sides of the nucleus, three at the corners of an equilateral triangle, four at the corners of a tetrahedron, and so on up to eight electrons, which arrange themselves in regular order on the surface of a sphere with the nucleus at the centre. When there are more than eight electrons, the first eight form an inner, and the rest an outer, layer, the number of the latter determining the valency of the atom. The properties of the atoms and molecules which are accounted for on this theory are numerous, and the theory seems most fertile.

An important paper on the "corona voltmeter" was read to the American Institute of Electrical Engineers last July by Prof. J. B. Whitehead, of Johns Hopkins University. The principle on which the voltmeter is founded is that a corona forms on a clean, round wire in air at a sharply marked definite value of the voltage dependent only on the pressure and temperature of the air. The voltage at which the corona forms can be observed directly by the eye or by the deflection of a galvanometer in the high-tension circuit, or best by the sound made in a telephone. The wire on which the corona forms is in a chamber the pressure of the air in which can be varied. This instrument gives a higher accuracy than that obtainable by a sphere-gap voltmeter, and the presence of neighbouring conductors does not affect its readings. An instrument on this principle to read 100,000 volts can easily be constructed in any electrical laboratory. The author is making one to read 400,000 volts. In experimenting with these voltmeters on alternating pressures a curious physical law was discovered. If R denotes the maximum potential gradient in kilovolts per cm., and r the radius of the wire in cm., then at 25° C. and 76 cm. pressure the value of R at which the corona appears is given by $R=29.84+9.938/\sqrt{r}$, provided that $1/\sqrt{r}$ is less than 2.26; but if the value of $1/\sqrt{r}$ is greater than 2.26, $R=32.96+8.559/\sqrt{r}$. The reason given as

an explanation of this sudden change in the law is that the laws governing the formation of the positive and negative coronas found with direct voltages are slightly different.

In addition to a large amount of useful statistical information in a paper on fuel oil read by Mr. W. A. White before the North-East Coast Institution of Engineers and Shipbuilders on January 28, there is a section in which the advantages of fuel oil over coal are enumerated for power purposes at sea. Fuel oil lends itself more easily to complete combustion than any solid fuel; owing to the higher heating value there is a saving in dead-weight, and increased space may be devoted to cargo; the conditions governing the speed of the ship are better, and there is economy regarding the necessary crew. In relation to the last-mentioned point, the *Aquitania* while burning coal had a staff of 350 men in connection with the stokeholds, and now on fuel oil this vessel requires some 84 men only. For bunkering the *Aquitania* has four fuel-receiving lines, and 480 tons per hour have been pumped into her bunkers from one barge through one pipeline; the total quantity of fuel required for her round trip could easily be delivered into the bunkers in six hours. Before conversion to oil-burning the *Aquitania* and the *Olympic* each took about 108 hours at each end for coal-bunkering, and employed 50 to 60 men; oil-bunkering employs 3 men only.

Our Astronomical Column.

NEW COMET 1921a.—A comet of the 9th magnitude was discovered by Mr. Reid at the Cape Observatory on March 13. The following observations have been received:

G.M.T.			R.A.			S. Decl.			Place
d.	h.	m.	h.	m.	s.	°	'	"	
March 14	14	51.0	20	14	35.0	18	28	48	Johannesburg
„	18	16 49.7	20	16	56.7	16	20	40	Algiers

Deduced daily motion +35s., N. 31½'. Predicted place March 25d. 16h., R.A. 20h. 21m., S. declination 12° 41'. The comet will rise on that day about 2¼h. before sunrise. It cannot be identical with comet Pons-Winnecke, for the latter passes its ascending node near aphelion, whereas the new comet passed its ascending node about noon on March 12.

Careful search has been made for Pons-Winnecke by several observers without success. Either the comet is unexpectedly faint or it is a long way from the predicted place.

RE-APPEARANCE OF SATURN'S RING.—The *Comptes rendus* of the Paris Academy of Sciences for February 28 contains the observations of this phenomenon made at Strasbourg by MM. A. Danjon and G. Rougier. The smaller equatorial (aperture 16 cm.) was employed. From February 11 to 21 no trace of the ring was visible outside the disc; its shadow on the disc appeared as a black line 0.2" broad.

On February 22, at 9h. G.M.T., the ring was seen as a very narrow bright line with condensations distant 18.2" and 13.8" from the centre of the disc, being strongest on the eastern side. These measures, and the others in the article, are reduced to the mean distance of Saturn from the sun. The visibility of the ring increased perceptibly during the four hours of observation, and on the following night it was quite an easy object. Making use of Barnard's measures of the ring system, the authors show that the condensations measured by them were respectively a

little inside the middle of ring A, and about one-fourth of the width of ring B outside its inner edge. They are not the same as those measured by Barnard in 1907, which were on the outer part of ring B and on the crêpe ring.

The position angle of the ring was measured on February 22; the value found was 85° 14', which is 7' less than the Nautical Almanac value. Measures of Saturn's disc gave for the equatorial diameter 17.65", and for the polar one 15.75"; compression, 1/9.3. It is interesting to note that the equatorial horizontal parallaxes of the sun from the earth and Saturn are practically identical.

The ring will be edgewise to the sun on April 10; after that its dark side will again be turned towards the earth until August 3, when the third passage through the ring plane will take place.

BRAZILIAN NATIONAL OBSERVATORY ANNUAL.—The *Annuario pelo Observatorio Nacional do Rio de Janeiro* for 1921 contains the usual astronomical data, together with expanded refraction tables and a very extensive list of useful constants. There are a full description, with diagrams, of the various wireless time signals, and an essay on the calendar, describing the various suggestions that have lately been put forward for eliminating the inconveniences of the present system.

The magnetic elements for a large number of Brazilian stations are given. Those for Rio de Janeiro are tabulated at twenty-year intervals from 1660 onwards and compared with various formulæ. The latest formula for magnetic declination is that due to Dr. Morize, the present National Astronomer, viz. $5.6^\circ + 0.08^\circ t + 8.0^\circ \sin(0.63^\circ t - 44.1)$, t being reckoned in years from 1850. The largest residual of this formula is 0.44° in 1760. The sine-term has a period of 571 years.

Tide tables for nine Brazilian ports complete the volume.

The Royal Anthropological Institute.

THE anniversary meeting of the Royal Anthropological Institute, which was held on January 25, marks the completion of the fiftieth year of the institute's existence. The institute was founded in 1871 as the result of the amalgamation of two pre-existing societies, the Ethnological Society and the Anthropological Society. The history of these two societies throws a very interesting light on the development of anthropological science in this country. The Ethnological Society was founded in 1843 by Dr. Thomas Hodgkin, of Guy's Hospital, Dr. Richard King, and Dr. Thomas Cowell Prichard. Hodgkin, a prominent member of his profession and a Quaker, had been in 1837 one of the founders of the Aborigines Protection Society; but with others, who, like himself, were more interested in the scientific aspect of the problems with which this society dealt, finding little scope for their interests, he decided to found a society which should deal only with the scientific side. In 1859 Dr. James Hunt became secretary of this society. A man of intensely active mind and tremendous energy, Dr. Hunt was strongly of opinion that the society was too narrow in its aims and lacking in energy. As a result he, with others, seceded, and the Anthropological Society was founded in January, 1863, at a meeting at which Sir Richard Burton took the chair.

An ambitious programme was immediately drawn up, including the popularisation of the subject by means of lectures, the discussion of political and social problems of the day, and the publication of translations of works by prominent Continental anthropologists. Another of Hunt's projects was the foundation of an anthropological college with full teaching staff, subsidised by the Government. Anthropological questions were much in the air at this time, as the result of the publication of "The Origin of Species" and the archaeological discoveries of Boucher de Perthes and Christy and Lartet in France. The Neanderthal skull had been discovered in 1857. The Ethnological Society still confined itself in the main to the backward races, and was urging upon the public the advantage of such studies to the nation in its dealings with its Dependencies. But the Anthropological Society was speculating on the innumerable questions which were then troubling the political world, as well as on the wider pseudo-scientific problems of the day. It not only dealt with such topics as the Aryan question, but also discussed race, nationality, and character as exhibited in the "negro mind," the "Irish mind," and the like.

The two societies, however, at the end of the 'sixties, found themselves in difficulties. The Anthropological Society, notwithstanding its popularity and its very considerable membership, had become heavily indebted through its ambitious policy and lavish expenditure on publications; while the Ethnological Society also found its income inadequate to meet its expenses. The death of Hunt in 1869 paved the way for an amalgamation. Negotiations were brought to a successful termination by the two presidents, Huxley on behalf of the Ethnological Society and Beddoe on behalf of the Anthropological Society. At a meeting held on February 4, 1871, a resolution was passed founding the Anthropological Institute of Great Britain and Ireland, and Lubbock was elected the first president.

The amalgamation was not, however, a final reconciliation, and in 1873 a number of members, who held that the interests of the Anthropological Society were not sufficiently considered, seceded, and formed the Anthropological Society of London. This society,

however, lived for three years only, and in 1876 the majority of the members returned to the institute.

The history of the institute falls into three periods. For the first ten or eleven years after its foundation it was engaged in consolidating its position and in defining its aims. The heavy debt of 1200*l.* which it had inherited from the parent societies was cleared off, largely by private subscription. Notwithstanding a declining membership and a diminishing income, a quarterly Journal was published, which maintained a high standard in quality of material and illustration.

A clearer and more definite conception of the function of such a body as the institute in its relation to the needs of anthropological science was now in process of formulation. The broad generalisations based upon what we should now consider totally inadequate evidence, which had been characteristic of one, if not of both, of the earlier societies, become fewer and tend to disappear. Their place is taken by communications which record the detailed results of careful observation. Such generalisation as there is is becoming cautious, tentative, and more strictly conditioned by the character of the evidence. This line of development was, no doubt, very considerably influenced by the epoch-making work of two distinguished fellows of the institute; in 1872 Evans published his "Ancient Stone Implements," and in the same year Tylor published the second edition of his "Primitive Culture." But the guiding influence of such men as Huxley, Galton, Flower, Busk, Pitt-Rivers, Francks, and Lubbock (the first Lord Avebury), to name a few only of those who were prominent in the counsels of the institute in its early years, could not fail to leave an indelible mark on its character and history.

It is interesting to glance through the volumes of the Journal at this period and to note the names both of fellows and of contributors. Darwin, Romanes, Bagehot, Sir H. S. Maine, Sir J. G. Wilkinson, Sir A. H. Layard, as well as two reigning monarchs, the Emperor of Brazil and the King of Siam, appear in the lists of fellows; while among those contributing to the Journal were Bishop Callaway, Sir R. F. Burton, Owen, Barnard Davis, Herbert Spencer, Col. H. Yule, Vambéry, Sir H. Bartle Frere, and Lieut. D. J. Cameron, the African traveller who was the first to give an account of the natives between 4° and 12° lat.

The second period in the history of the institute may be said to begin about 1880 and to extend to 1898. In the early 'eighties interest in anthropology was growing rapidly. The foundation of the Folklore Society in 1877 may possibly have been the earliest manifestation of this movement. In 1883 the number of fellows of the institute ceased to decline, and an upward movement began, which has continued steadily, if slowly, ever since. In 1883 the University of Oxford founded a readership in anthropology, to which Tylor was appointed. This was the beginning of the systematic teaching of the subject in our universities. In the same year the Pitt-Rivers Museum was founded at Oxford, and the formation of the Archaeological and Ethnological Museum was begun at Cambridge, Baron A. von Hügel being the curator. Human crania had been admitted to the British Museum zoological collections, and in the new building at South Kensington 407 skulls and 10 complete skeletons were on exhibition. It is interesting to note that at this date the collection of the Royal College of Surgeons, which in 1853 had consisted of 18 skeletons and 242 crania, had grown to 89 com-

plete skeletons and 1380 crania, irrespective of the Barnard Davis collection consisting of 24 skeletons and 1539 crania, which had been acquired in 1880.

Shortly afterwards Macalister introduced anthropological work in his lectures at Cambridge. In 1884 Galton instituted an anthropometric laboratory at the Health Exhibition, in which 10,000 individuals were measured, and afterwards installed the laboratory at South Kensington, where it, continued to exist for some years. A similar laboratory was established in Cambridge, and another in Dublin in 1891. In these activities the institute was interested either directly or through its fellows. In 1884 it organised a conference in connection with the Indian and Colonial Exhibition, at which a large number of papers dealing with the native races of the Empire was read. As a direct outcome of the conference a movement was set on foot which led to the foundation of the Imperial Institute as a memorial of the jubilee of Queen Victoria in 1887. The institute also took an active part in fostering the many movements with which Galton was connected, including the study of the physical and mental characteristics of our own population, the use of statistical methods in anthropology, and the introduction into this country of the system of identifying criminals both by anthropometric measurements and by the classification of finger-prints. In 1894 the position of Adviser to the Home Office on Criminal Identification was established, and continued to be held by a fellow of the institute for some years.

The second period comes to an end in 1898. The enthusiasm which characterised the 'eighties and the early 'nineties had begun to wane, but with the intro-

duction of new blood the institute made a vigorous step in a forward direction. The Journal was enlarged, the illustrations in particular being increased in number and improved in quality, and the monthly periodical *Man* was instituted, the first number being published in January, 1901. A broader view was taken of the institute's functions, and it entered upon a period of activity which was continued without interruption until the outbreak of war in 1914.

The institute now began to urge with insistence the practical bearing of anthropology and anthropological data on administrative and legislative problems. The native question in South Africa, physical deterioration, anthropometrics in schools and the medical inspection of school-children, and the necessity for a knowledge of native customs and modes of thought in the government of backward races and as an essential part in the education of administrators of our Dependencies are some only of the numerous questions in connection with which the institute has urged its views upon the public and the Government. These activities were necessarily interrupted by the war. Setting aside this gap of six years, the last period still stands too close for us to gauge the direction of the institute's future development. Though the work of collecting material still goes on apace, and will continue so to do for some time, it may be permissible to hazard a guess that the future line of development must lie in the direction of the comparison and co-ordination of facts in order that these may be presented as an organised body of knowledge, and thus made available for the educationist, the administrator, and the legislator.

E. N. F.

Publications of the U.S. National Research Council.

By J. W. WILLIAMSON.

THE National Research Council of Washington, U.S.A., is the American counterpart of the Department of Scientific and Industrial Research in this country. It was organised in 1916 at the request of the president of the National Academy of Sciences, under its Congressional charter, as a measure of national preparedness; and President Wilson in 1918, by executive order, requested the National Academy of Sciences to perpetuate the National Research Council, and assigned to it definite duties. We have before us a number of publications issued by the National Research Council. It is explained that the Proceedings of the National Academy of Sciences has been designated as the official organ of the National Research Council for the publication of accounts of research, committee and other reports, and minutes. But the Council publishes also at irregular intervals the Bulletin of the National Research Council for the presentation of contributions other than proceedings; and it issues from time to time, under the general title of "The Reprint and Circular Series of the National Research Council," papers published or printed by or for the Council and relating to matters in its designated field of action. Some of these papers have already appeared in scientific and technical journals.

The first four numbers of the Bulletin already issued deal with "The National Importance of Scientific and Industrial Research," "Research Laboratories in Industrial Establishments of the U.S.A.," "Periodical Bibliographies and Abstracts for the Scientific and Technological Journals of the World," and "North American Forest Research." Of the Reprint and Circular Series the first nine numbers cover a wide and diversified area, including reports of

the Patent and Psychology Committees of the National Research Council; papers on problems of refractory materials, solar and terrestrial radiation, sidereal astronomy, and industrial research; and, finally, a "reading list on scientific and industrial research and the service of the chemist to industry."

Some of these publications can, perhaps, better be dealt with by way of separate review, but it may be useful here to direct attention to certain points raised that bear on the general question of scientific research, particularly in its application to industry. The "reading list" referred to above shows the extent of this field, for it contains something like 1100 references to books, pamphlets, and articles under the popular classification of (1) scientific research and (2) industrial research, and the flood continues. As one writer says: "Newspapers, magazines, and periodicals are continually publishing articles on industrial research; vast numbers of people are talking, more or less knowingly, about it; and industries and Governmental Departments, which up to a few years ago had hardly heard of industrial research, are embarking or endeavouring to embark upon the most elaborate research projects."

In all this restless stirring amongst the dry bones there is a great need to keep constantly in mind a few paramount and fundamental principles. The first is that the main instrument of research is man, and not machinery, instruments, or buildings. Mr. Frank B. Jewett, chief engineer of the Western Electric Co., in a paper on "Industrial Research," well says: "The matter of an adequate supply of properly equipped and trained investigators and directors of research is absolutely vital to the growth of industrial research, and I am as sure as one can be of anything

in the world that all of our visions of the benefits to be derived from a large expansion of industrial research will come to naught if we fail to realise or neglect the fact that in the last analysis we are dependent absolutely upon the mental productivity of men, and men alone, and that we must, in consequence, provide adequately for a continuous supply of well-trained workers." It is, and must be, the function of the universities and higher educational institutions to pour out the steady stream of well-equipped and trained investigators that is the first and vital need of the industrial research movement.

Another essential condition for the successful development of industrial research is that there must be concurrently a corresponding growth and development in the domain of fundamental scientific research—what is, perhaps somewhat loosely, called "pure science"—for from the fountains of pure science come the waters that freshen and replenish the streams of applied research. It is worthy of note, and should be reassuring even to those who look with distrust on the more recent developments of industrial research, that in the various papers published by the National Research Council dealing with the application of science to industry there is abundant testimony from men whose main interests are industrial to the truth of this principle. Mr. J. J. Cartv, vice-president of the American Telephone and Telegraph Co., for example, in an address on "Science and the Industries," says: "The pure scientists are the advance guard of civilisation. By their discoveries they furnish to the engineer and industrial chemist and other applied scientists the raw material to be elaborated into manifold agencies for the amelioration of the condition of mankind. Unless the work of the pure scientist is continued and pushed forward with ever-increasing energy, the achievements of the industrial scientist will diminish and degenerate." It is, again, to the universities mainly, if not almost wholly, that we must look for this fundamental, purely scientific research. The publications under review perform not the least useful of their functions in

emphasising the basic importance of the universities in all schemes for the national development of industrial research.

The last point with which in our limited space we can deal is the fundamental question of the organisation of research. Dr. James Rowland Angell, in an address on "The Development of Research in the United States," says: "Scientific men have as yet only achieved the most elementary beginnings of the organisation of scientific interests. Indeed, it has been something of a fetish among scientists that we must rely upon individual inspiration and initiative, and that the individual worker must be safeguarded in every possible way from the corroding influence of administrative organisation." This complaint is not baseless. There are still people who regard the mere suggestion of organising research as a profanation of genius not less desecrating than a proposal to have poetry written by committees; and yet scientific principles and methods are no more out of place in the organisation of research than they are in research itself. It may be long before we reach common agreement as to the main plan, but the science of the organisation of research is as worthy a study as—shall we say?—the science of education or of economics. Dr. Angell, in the address referred to above, observes: "As a matter of fact, large areas of the most needed research lie in territory where properly trained men of talent, given proper conditions of work, may produce constantly and in increasing measure results of the utmost consequence. But one of the conditions of maximal efficiency is that they shall work inside the framework of a general programme in which there is intelligent co-operation in the allocation of the field and in the constant communication of results achieved. Such distribution of responsibility and effort is entirely consonant with the fullest actual initiative which any scientist can desire."

The publications of the National Research Council are a solid contribution to the elucidation of many problems in this new and promising field of national development.

Psychotherapy and War Experience.

INABILITY to see the wood for the trees is not uncommon in writers on most scientific subjects, but the characteristic of many medical exponents of psychotherapy seems rather that to them the wood is invisible because of their proximity to one very large and important tree. Dr. William A. Brend, who contributes a notable article entitled "Psychotherapy and War Experience" to the January issue of the *Edinburgh Review*, is emphatically not one of these. His essay attracts one, apart from the obvious interest and importance of its subject, on account of the balance, the perspective, the background, and the sympathetic appreciation of delicate nuances which the picture displays. It is a lucid and judicious account of the substance of eight publications—not all of them recent—by Freud, Ferenczi, Ernest Jones, Lay, and McCurdy; but it is much more than this, for it gives the general reader some idea of the changes which the psycho-analytic movement has brought about in the outlook of modern psychotherapy. Yet Dr. Brend obviously holds no brief for this school of thought alone. He describes, too, the parts which suggestion (including hypnotism), persuasion, re-education, and modified psycho-analysis have played in alleviating the mental sufferings caused by the war, the unwisdom of encouraging the patient merely to "distract his mind" whether by play or by work, the inadvisability of allowing important lost memories to remain lost, the uses of hypnosis in

recovering repressed experiences, the indispensability of thorough-going psycho-analysis in some cases and its undesirability in others.

"Some knowledge of the principles of the new psychology is desirable for everyone, but that is not to say that a person of normal mentality should, without good reason, allow all his natural repressions to be brought to the surface by anyone who claims to be an analyst."

It is hoped that many will read of the extensive provision of psychotherapy made by the Army since 1916, and at present by the Ministry of Pensions under Sir Lisle Webb, and that they will then inquire what is being done for the civilian. The answer is:

"As far as the ordinary civilian population is concerned, very few facilities for this treatment are available for those who are unable to pay the fees of consultants. One or two clinics have been started on a small scale, but it is now recognised that to cover the ground adequately very large provision of this nature will require to be made, and it is to be hoped that such clinics will eventually be established under the Ministry of Health."

Those of us who almost daily have sadly to tell sufferers that "very few facilities for this treatment are available for those who are unable to pay the fees of consultants" very earnestly share the hope of Dr. Brend.

T. H. PEAR.

University and Educational Intelligence.

CAMBRIDGE.—The election of the first professor to the Sir William Dunn chair of biochemistry will take place on April 19.

Mr. L. J. Comrie and Mr. W. M. H. Greaves, both of St. John's College, have been elected to Isaac Newton studentships in astronomy.

It is proposed to appoint a University lecturer in medical radiology.

The annual report of the General Board of Studies on various University departments refers to the overcrowded state of the laboratories, with the consequent burden on the teaching staff. Cambridge has suffered along with other anatomical schools from a scarcity of subjects for dissection, and, partly as a consequence of overcrowding, other departments also have suffered from difficulties in the supply of material. Various new buildings and extensions of existing buildings are proceeding in the chemical, physical, engineering, biochemical, and parasitological schools.

It is proposed to discontinue the Higher Local Examination, which has been gradually displaced by the Higher School Certificate Examination.

LEEDS.—Her Highness Princess Helena Victoria paid an informal visit to the University on March 15. She was received by the Vice-Chancellor (Sir Michael Sadler) and by the Pro-Vice-Chancellor (Prof. Smithells). Her Highness then inspected several of the departments of the University. In the large physics laboratory was an exhibit consisting in the main of experiments which had been carried out in the department in the preceding year. Among the items shown were the "ultra-micrometer," an instrument described to the British Association at the 1920 meeting, by which distances as small as 10^{-6} cm. could be detected; and a new system of *both way* wireless telephony by which conversation may be carried on in precisely the same manner as in an ordinary telephone. In the department of textile industries the Princess was shown in process of manufacture Herdwick wool (the roughest type of the British wools), Suffolk Down wool (one of the finest of British wools), the finest Australian wool, llama from 14,000 ft. up the Andes, and the under-fibre of the musk-ox (forwarded to the department by Mr. Stefansson, the Canadian explorer). British and Continental methods of manufacture and wool-combing were also shown. In the museum the collection of old fabrics—possibly the finest in the provinces—was supplemented by Indian shawls lent by Sir Michael Sadler.

Mr. R. J. Stewart McDowall, lecturer in the physiology department of the University of Edinburgh, has been appointed to the post of lecturer in experimental physiology and experimental pharmacology.

LONDON.—At a meeting held on March 16 the Senate adopted a resolution for the continuance of the physiological laboratory at the University headquarters at South Kensington until the end of the session 1922-23.

The following doctorates have been conferred by the Senate:—*D.Sc. in Mathematics*: Miss D. M. Wrinch, an internal student of University and King's Colleges, for a thesis entitled "An Asymptotic Formula for the Hypergeometric Function $\Delta_2(z)$." *Ph.D. (Science)*: Miss D. M. Adkins, an internal student of Royal Holloway College, for a thesis entitled "(i) The Economic Value of the Soya Bean" and "(ii) The Digestibility of Germinated Beans." *D.Sc. in Agricultural Chemistry*: Mr. H. E. Annett, an external student, for a thesis entitled "Biological Chemistry."

THE University Extension Board of the University of London arranged during the present session a ses-

sional course of lectures on "The Bases and Frontiers of Physical Science" by Prof. John Cox at Gresham College. The last four lectures of this course, beginning on Friday, April 8, will deal with "The Principle of Relativity."

Two scholarships, each of the yearly value of 300*l.*, are being offered by the Grocers' Company for the encouragement of original research in sanitary science. The scholarships are tenable for one year, but may be renewed for a second or a third year under certain conditions. The election will take place in June next, and applications must be made before May 2, on the prescribed form, to the Clerk of the Grocers' Company, Grocers' Hall, E.C.2.

THE Imperial College of Science and Technology announces a further generous donation by a leader in industry, who desires to remain anonymous, to the fund for the provision of scholarships to enable students of the college to spend a year in post-graduate study at American universities or in works. At present four such students are in America. The present donation will enable four more to be sent for 1921-22.

THE report for 1920 of the Association of Science Teachers, which has just been received, refers to the revised edition of the association's "Book List," which now includes books on zoology, natural history, and astronomy. The list can be obtained from the hon. secretary or from Miss Storr, 12 Angell Park Gardens, S.W.9, price 1*s.* 6*d.* It is intended to publish a supplement at the end of the year. Notice is given of a course of lectures on biological science which the executive hopes to be able to arrange at Oxford during the summer vacation; the probable date for the course is July 29 to August 9, and the fee will be 3*os.* The afternoon session of the general meeting held on January 4 at University College was devoted to a lecture by Dr. J. C. Drummond on vitamins, in which a brief summary was given of our knowledge of these important constituents of food. Representatives of the association have attended meetings of the Consultative Council of University and School Science Teachers, and the subjects discussed are mentioned. Reference is also made to the death of Mr. D. H. Nagel, an appreciation of whom appeared in *NATURE* for October 7 last. Mr. Nagel's place as chairman of the council has been taken by Prof. Weiss, of Manchester.

THE report of the Carnegie Trust for the Universities of Scotland for the year 1919-20 contains a complete financial statement of the work of the executive committee of this foundation during the past year. Grants are made quinquennially in ordinary circumstances, but the difficulties arising out of war conditions made the distribution of interim grants for the years 1918-19 and 1919-20 desirable. A return to the old system was made with the opening of the academic year 1920-21, and details of the grants allocated are given in the appendices. The estimated available income for the five years is 225,000*l.*, and it has been decided that 200,000*l.* shall be distributed among the universities, the remaining 25,000*l.* being set aside to meet extra-mural expenses. The former sum will be divided in the following way:—To St. Andrews, 18.5 per cent.; to Glasgow, 29 per cent.; to Aberdeen, 19.5 per cent.; and to Edinburgh, 33 per cent. More than two-thirds of the sum (141,580*l.*) is earmarked for buildings and permanent equipment, while 32,920*l.* goes for the endowment of professorial chairs and lectureships. In view of the difficult circumstances in which the universities find themselves, a further sum of 40,000*l.* from the reserve

fund has been allotted, which is to be expended mainly on purposes immediately connected with students. The values of research scholarships and fellowships have been raised from 150*l.* and 200*l.* to 200*l.* and 250*l.* per annum respectively. Grants have been made to assist 4912 students in the payment of fees involving an expenditure of 68,591*l.*

At a meeting of the Royal Anthropological Institute held on February 22 Sir Alfred T. Davies, of the Welsh Department of the Board of Education, gave an account of the scheme for the collection of rural lore in Wales by school-children which had been instituted by that Department. The educational object of the scheme had been to quicken the interest of the children in their immediate surroundings and to stimulate their desire for acquiring knowledge through their own efforts. In its original form the object of the scheme was to secure on Ordnance maps, which had been provided out of funds supplied from private sources, the records of traditional names of fields and a record of the state of the land in relation to cultivation at the beginning and the end of the Great War. This record would prove in days to come a valuable source of information as to the economic and social state of Wales at this date. The whole scheme was voluntary so far as teachers were concerned, and those who were interested were invited to secure and record supplementary information such as local folk-lore, local industries, ancient monuments and buildings of note, the names and birthplaces of men who had been born in the district and had afterwards become famous, and other data of the kind. The chief item in the cost was the supply of sheets of the Ordnance map, which had amounted to just over 5*s.* per school. The president, Dr. W. H. R. Rivers, in opening the discussion, said that the point in the scheme which most impressed an anthropologist was the great enthusiasm which it showed for the preservation of the past.

A POWERFUL plea for the organisation of science in Australia has been made by Prof. T. H. Laby, of the University of Melbourne. Prof. Laby points out that while in both Great Britain and America the war period was a time when important changes were made in the organisation of science, no corresponding change occurred in Australia. Science in that continent is organised on a State basis; each of the five States has its Royal Society together with a number of minor scientific societies, but the only society in which the whole Commonwealth is represented is the Australasian Association for the Advancement of Science. This body meets normally once in two years, but, owing to force of circumstances, no meeting has been held during the last seven years. Prof. Laby argues that such a body is unable to take continuous care of Australian science. The world-wide need for the re-organisation of science was expressed in Great Britain by the formation of the Conjoint Board of Scientific Societies, the National Union of Scientific Workers, and the establishment of State-aided research associations; in America a similar movement led to the formation of the National Research Council to "mobilise" the scientific *personnel* and resources of the country. In Prof. Laby's opinion, none of these bodies would meet the whole of Australia's requirements. He advocates rather the formation of a national scientific society or national academy composed of those who are contributing to both pure and applied science which shall have sufficient resources to promote and direct scientific research; further, it should be recognised by the Government as an advisory body, and be capable of safeguarding the professional interests of men of science.

Calendar of Scientific Pioneers.

March 24, 1712. Nehemiah Grew died.—Like Malpighi, Grew is regarded as one of the founders of vegetable anatomy. He practised medicine in Coventry and London, and was secretary of the Royal Society in 1677. In 1682 he published his "Anatomy of Plants." Grew was probably the first to distinguish sexuality in plants.

March 24, 1776. John Harrison died.—A native of Yorkshire, Harrison made several improvements in clocks and watches, and, having settled in London, during the years 1735-59 he produced the first four chronometers. Though when tested at sea for determining the longitude they proved successful, it was only after long delay that Harrison was granted the full award of 20,000*l.* offered by the Act of Parliament of 1713.

March 24, 1849. Johann Wolfgang Döbereiner died.—For some years professor of chemistry at Jena, Döbereiner's chief work was on platinum in a minute state of division and the oxidation products of alcohol. He was the inventor of the Döbereiner lamp.

March 24, 1881. Achille Ernest Oscar Joseph Delesse died.—An Inspector-General of Mines and a president of the Geological Society of France, Delesse paid special attention to the deposits beneath the sea.

March 24, 1905. Pietro Tacchini died.—Distinguished for his investigation of the physics of the sun, Tacchini was the founder of the Società degli Spettroscopisti and the Società Sismologica of Italy, and also of the Mount Etna Observatory. In 1879 he succeeded Secchi as director of the observatory of the Collegio Romano.

March 25, 1915. Karol Stanislaw Olszewski died.—After studying under Bunsen, Olszewski became professor of chemistry at Cracow. Like his countryman Wroblewski, he was a pioneer worker on the liquefaction of gases, and was the first to study argon at very low temperatures.

March 26, 1797. James Hutton died.—The founder of physical and dynamical geology, Hutton gave his views to the world in his paper, "Theory of the Earth," of 1785, and in the book bearing the same title published ten years later.

March 26, 1877. Karl Bremiker died.—While holding a post in the Prussian Board of Trade, Bremiker in his leisure revised some of the star charts of the Berlin Academy. It was with the aid of these charts that Galle first observed Neptune. In later life Bremiker was a director of the Prussian Geodetical Institute.

March 28, 1874. Peter Andreas Hansen died.—Of Danish parentage, Hansen in 1825 succeeded Encke at the Gotha Observatory. His principal researches related to lunar theory and the orbits of comets and planets. His "Tables of the Moon" were published by the British Government, which granted him 1000*l.*

March 30, 1832. Stephen Groombridge died.—A London merchant and a keen astronomer, Groombridge produced an important catalogue of stars.

March 30, 1914. John Henry Poynting died.—Professor of physics in Mason's College and its successor, the University of Birmingham, for thirty-four years, Poynting's original researches referred mainly to the constant of gravity and to the theories of electrodynamics and the pressure of light. E. C. S.

Societies and Academies.

LONDON.

Royal Society, March 10.—Prof. C. S. Sherrington, president, in the chair.—Sir Joseph Larmor: Electro-crystalline properties as conditioned by atomic lattices. The view that the crystal lattice is usually composed of atoms is considered in relation to their ionic charges. Compensating surface charges on certain types of faces of a crystal are required; and inference is drawn with regard to the texture of crystal faces. The alternative view that a bipolar molecule is the crystal-unit would seem to encounter difficulties also as regards pyroelectric effects. Dielectric excitation can be represented as relative displacement of the positive and negative component lattices under the influence of an electric field. If the compound lattice has spiral features, so that the relative shifts of its various components with positive and negative charges are of screw type, chiral optical quality will be involved; a coarse numerical estimate indicates that in quartz and active liquids the twisting relative displacement of the ionic configurations is comparable in amount with their relative elongation. The chiral quality may reside wholly in the crystalline structure, disappearing on fusion or solution; or else the process of dielectric displacements of the positive and negative groups of ions in the crystal-unit may be also itself chiral. In either case, induced static polarity could not be chiral as regards waves so long as those of light; but this process of screw displacement is operative kinetically in the optical rotation by involving a magnetic moment of changing ionic twist induced by the alternating electric field of the radiation. A face of a crystal of cubic type containing both types of ions equally should acquire no true pyroelectric charge. Double refraction induced by strain must be ascribed to bending of ionic lattice structures, or in glass to fragments of such structure.—Prof. A. S. Eddington: A generalisation of Weyl's theory of the electromagnetic and gravitational fields. From the notion of "parallel displacement" used by Weyl in his theory, it is shown that a tensor $*B_{\mu\nu\sigma}$ exists giving a measure of the world-structure at each point. The contracted tensor $*G_{\mu\nu}$, formed by setting $\rho = \sigma$, breaks up into two parts: (1) a symmetrical part which is the gravitational potential $g_{\mu\nu}$ of Einstein's theory, and (2) an antisymmetrical part $F_{\mu\nu}$ (proved to be the curl of a vector) which is identified with the electromagnetic force. The theory explains how, notwithstanding the non-integrability of length in Weyl's geometry, there is a natural gauge; and Einstein's interval is an absolute invariant independent of gauge, and directly comparable with other intervals at a distance. The law of gravitation for empty space in the form finally adopted by Einstein, viz. $G_{\mu\nu} = \lambda g_{\mu\nu}$ follows at once on this theory. All the other recognised field-laws are found by identifying the physical measures with geometrical tensors which satisfy these laws identically. None of these impose any constraint on the possible varieties of world-structure; and there is no reason to introduce a physical principle of stationary action, at least so long as we do not deal with problems of electron structure. Explicit expressions for $*B_{\mu\nu\sigma}$ and $*G_{\mu\nu}$ are found in terms of Einstein's gravitational tensors and a tensor $K_{\mu\nu,\sigma}$ which represents electric and electronic forces. Weyl's theory corresponds to the particular case when $K_{\mu\nu,\sigma}$ is of the form $g_{\mu\nu}\phi_{,\sigma}$.—Prof. T. R. Merton: Spectrophotometry in the visible and ultra-violet spectrum. The application of the neutral wedge to spectrophotometric measurements is extended. The method involves the

"crossing" of the prismatic spectrum with a diffraction spectrum, the relative intensities of the different orders in the diffraction spectrum having been experimentally determined. The method of preparing and calibrating gratings for this purpose is described. The method is applicable to the determination of the relative intensities of lines in discontinuous spectra, but is specially adapted to the study of continuous spectra, absorption spectra, and the study of broadened lines. The method may have a special application in celestial spectroscopy.—Prof. W. A. Bone: Researches upon brown coals and lignites. Part i.: Heat treatment at temperatures below 400° C. as a possible method for enhancing their fuel values. A classification of lignites is made according to their external appearance: (a) Woody or fibrous brown coals. (b) Amorphous or earthy brown coals. (c) Common or brown lignites. (d) Black lignites. Lignites have a moisture content varying between 10 and 50 per cent.; on air-drying they usually disintegrate or crumble to powder. They are devoid of any coking properties, and in the "dry ashless" state usually contain less than 70 per cent. of carbon and more than 20 per cent. of oxygen. Experiments were conducted on the various types of lignites, which were heated in a special form of apparatus that allowed accurate measurement of temperature and amounts of liquid and gaseous products. Chemical change takes place, beginning at a low temperature of about 130° C. and progressing to a temperature at which no condensable hydrocarbons were eliminated from the fuel, termed the "practicable up-grading limit." Steam and carbon dioxide, with a small amount of carbonic oxide and a negligible amount of hydrocarbons, were eliminated. Practically the whole of the potential energy of the lignite is concentrated in the residue obtained by this "up-grading" treatment.—Prof. H. N. Russell: A superior limit to the age of the earth's crust. The method of determining the age of a mineral from the ratio of lead to uranium in its composition may be extended to the earth's crust as a whole. Accepting a radium content of 2.5×10^{-12} (Joly), corresponding to a uranium content of 7×10^{-6} , and a content of lead of 22×10^{-6} (F. W. Clarke), it follows that the age of the crust does not exceed 11×10^9 years, which is reduced to 8×10^9 years, if allowance is made for thorium.—H. Ohshima; Reversal of asymmetry in the plutei of *Echinus miliaris*. In the normal Echinoderm larva the hydrocoele and its associated structures develop on the left side of the larval body. Rarely the reversal of this asymmetry occurs. This abnormality was found in more than 10 per cent. of the artificially reared larvæ of *Echinus miliaris*. It may be a result of (1) change of polarity in the egg, or (2) twin-formation, or, most probably, (3) "compensatory hypertypy," owing to the arrest in development and later atrophy of the normal left hydrocoele. The right anterior coelom is known to have latent potentialities for producing a hydrocoele, which can probably be activated by the stimulus due to the arrest in development of the left hydrocoele. The arrest is probably associated with the obliteration of the pore-canal, through which the hydrocoele has been communicating with the exterior. The occurrence in much lower percentage of the double-hydrocoele larvæ and of those devoid of the hydrocoele within the same culture jars can be similarly explained. If the left hydrocoele regains its communication with the exterior, it will continue to develop with the abnormal right hydrocoele, giving rise to the double-hydrocoele larva. If the right hydrocoele fails to appear while the left hydrocoele is still deprived of its communication with the exterior, a larva devoid of hydrocoele will result.

Physical Society, February 25.—Sir W. H. Bragg, president, in the chair.—R. H. **Humphry**: A note on the hot-wire inclinometer. Two fine platinum wires were stretched parallel to each other in a hole in a copper block and were heated electrically. The changes caused by rotation were investigated with hydrogen, air, and carbon dioxide surrounding the wires. The inclinometer filled with carbon dioxide was much more sensitive than one filled with air. The shape of the curves obtained suggests that the temperature gradient in the region traversed by the wires is nearly uniform.—Prof. E. F. **Herroun** and Prof. E. **Wilson**: The magnetic susceptibility of certain natural and artificial oxides. The susceptibility of ferric oxide as occurring in Nature varies through a wide range, but in the case of artificial preparations the range of variation may be much greater. The passage through the stage of magnetic oxide impresses more pronounced magnetic properties upon the resulting ferric oxide. Heating feebly magnetic ferric oxide with a basic oxide, e.g. lime or magnesia, increases susceptibility (confirming List and others). When higher susceptibility has been produced by heating ferric oxide, removal of the metal leaves the ferric oxide in a magnetic condition. The aluminates formed when ferric oxide is replaced by aluminic oxide show no definite increase in susceptibility.—J. **Guild**: The refractometry of prisms. A generalised formula for the refraction of light through a prism is obtained, and the particular cases pertaining to practical methods of refractometry are deduced from it. The sensitivity of various methods for various prism angles and refractive indices is shown in a series of curves, as is also the liability to error due to errors in auxiliary constants.—T. **Smith**: Tracing rays through an optical system. A further development of the system described by the author in the previous papers of the same title presented to the society; formulæ for skew rays are put into a shape so far as possible similar to those applying to rays in one plane.

Aristotelian Society, March 7.—Prof. A. N. Whitehead in the chair.—Prof. J. E. **Boodin**: Cosmic evolution. Modern science and modern philosophy agree in treating the evolution of our earth as an independent drama. The later levels of evolution are supposed by some magic to emerge from the earlier—life from matter, thought from reflex action. Some have attempted to introduce a *plus* principle, such as an *élan vital* or entelechy. But such a principle would have to be present from the beginning, thus antedating life. It would have to account for the reversed or alternating directions of evolutionary series, and sometimes it would have to lie dormant for long periods of time. It is at best an abstraction of the fact that certain processes have direction. It does not explain the fact. For this we need a cosmic dynamics, and this is found in interaction. Interaction is not merely a speculative principle. No reasonable man could hold that our complicated organs of sight and hearing are developed by chance in the organism without reference to the cosmic environment. It is safe to say that if there were no light patterns there would be no eyes; if there were no sound patterns there would be no ears. Through a long trial and error process and under the control of cosmic patterns the organism develops the appropriate instruments to respond in specific and differential ways to the cosmos. And what shall we say of the various levels of control within the organism? Can we account for the unique type of pattern of creative thought and its control of the lower levels by a chance combination of reflex arcs? Here, too, we must invoke

the principle of cosmic interaction. The development of the organism to think is due as truly to thought patterns communicated through the cosmic continuum as the development of seeing is due to the light patterns acting upon organic matter. And thought patterns, like light patterns, must be communicated from other worlds that are of a level to emit such patterns. We know no other way. In neither case is it the act of thinking or seeing which is communicated. This is due to the interaction of the respective patterns with matter and its properties.

CAMBRIDGE.

Philosophical Society, February 28.—Sir Ernest Rutherford, vice-president, in the chair.—Sir Joseph **Larmor**: The nature of the crystal-reflection of X-rays. The analysis of X-radiation by a crystal suggests the general problem of selective reflection from a medium the properties of which vary periodically with depth according to any assigned law. The equations of this problem reduce to the well-known differential equation discussed by Hill in connection with the lunar theory. The conditions for selective reflection reveal immediately the main characteristics of the solutions of Hill's equation; while the expansions in series which have been worked out for various cases can be applied in numerical illustration of the action of the crystal grating. The laws of reflection from a single sheet of ions are also considered.—Dr. G. F. C. **Searle**: An experiment on focal lines formed by a zone plate. When the axis ON of a zone plate passes through a luminous point P, the zone plate acts as a lens. When ON makes an angle θ with OP, two sets of focal lines take the place of the single set of images. For lines in the plane PON the focal length is independent of θ . The theory is extended to the case in which a wave-front of any form falls at any angle on the zone plate—a case realised by placing between P and O a lens having one face cylindrical.—R. H. **Fowler** and C. N. H. **Lock**: The origin of the disturbances in the initial motion of a shell. The principal part of the disturbance is orientated similarly from round to round, and it is therefore argued that the cause is to be looked for in vibrations of the barrel.—E. K. **Rideal**: The latent heats of vaporisation. The latent heats of evaporation can be derived by calculation with the aid of the quantum theory. Regarding the process of evaporation as a monomolecular chemical reaction, it is possible by means of the effusion formula of Herz and Langmuir, and the equation for monomolecular chemical reaction of Dushman and Rideal, to evaluate the Nernst chemical constants. The expression derived for the chemical constant agrees dimensionally with a modified expression of Lindemann's which was obtained from dimensional considerations.

PARIS.

Academy of Sciences, February 28.—M. Georges Lemoine in the chair.—G. **Humbert**: The ternary forms of Hermite in an imaginary quadratic body (fields $\sqrt{-1}$ and $\sqrt{-2}$).—C. **Richet**, E. **Bachrach**, and H. **Cardot**: The phenomena of anaphylaxis in microorganisms. Studies on the growth of the lactic bacillus in presence of thallium salts. Strains of this organism grown in presence of a small proportion of the poison for several generations become indifferent to it; but if now transferred to a culture medium containing a higher proportion of the thallium salt, growth is much less vigorous than with a lactic strain not accustomed to thallium salts. This may be considered as an anaphylactic phenomenon.—P. **Vuillemin**:

Exogenous xygomorphosis in flowers normally actinomorphic.—G. **Cerf**: Certain systems of Pfaff equations and the transformations of partial differential equations.—D. **Riabouchinski**: The initial movement of a liquid in contact with an obstacle with sharp edges.—A. **Danjon** and G. **Rougier**: The re-appearance of Saturn's ring, observed at the Observatory of Strasbourg, February 22, 1921 (see p. 119).—F. M. **de Laroquette** and S. **Millot**: Experimental data and balance for the estimation of X-rays in radiography and radiotherapy.—M. **de Broglie**: The corpuscular spectra of the elements.—M. **Pariselle**: An achromatic triplet with a large field.—C. **Matignon**: The action of iodine on different metals in the cold. A method for detecting the presence of chlorine in the atmosphere. Metals in thin foil are converted into iodides by contact with iodine. A piece of silver foil coated with potassium iodide forms a delicate test for the presence of chlorine in air; the foil forms part of an electric circuit, chlorine sets free iodine, and the silver iodide immediately formed is a non-conductor.—A. C. **Vournazos**: The bismuthobromocyanides.—M. **Chapas**: The solubility of the isomeric nitroanilines in metaxylene. These isomers differ greatly in solubility, at 15° C. the proportions being 11.6, 1.74, and 0.28 per cent. for the ortho-, meta-, and para-compounds respectively.—O. **Mengel**: Relations between earthquake phenomena and the structure of the Pyrenees.—G. **Guilbert**: A case of destruction by a gale. Various applications of meteorological rules published by the author in earlier communications. Several examples are given in which predictions based on these rules have been justified in detail.—A. **Lumière**: Surface tension and anaphylactic shock. Criticism of a recent paper by W. Kopczevski. Measurements by the author of the relative surface tensions of water, 5 per cent. solution of sodium hyposulphite, blood serum, and the last diluted with an equal volume of sodium hyposulphite solution, do not agree with the corresponding measurements made by W. Kopczevski, and hence the hypothesis of the latter as to the intervention of surface tension in the production of the anaphylactic shock is not confirmed.—A. **Paillet**: Contribution to the study of humoral immunity in insects.—G. **Bertrand** and A. **Compton**: The influence of heat on the activity of salicinase. It is known that the activity of a diastase increases with the temperature, passes through a maximum, and finally decreases to nothing. The most favourable temperature and the temperature at which activity ceases have been frequently treated as physical constants of a ferment, analogous with the melting point and boiling point of a definite substance. It is shown, however, that these two temperatures cannot be considered as constant, since they can be made to vary with the experimental conditions, the most important being the time during which the diastase is allowed to act. The results of a series of experiments on salicinase are given graphically in two curves, the ordinates being temperatures and the abscissæ duration of the action. With salicinase the two curves meet at 70° C.; this is the temperature of maximum activity, and also the highest temperature at which diastase can exist.—A. **Desgrez** and R. **Moog**: The influence of some organic bases and of their chlorohydrates on the activity of pancreatic amylase. The bases triethylamine and trimethylamine reduce the diastatic activity, but the chlorohydrates of these and of methylamine exert a contrary action and increase the activity of pancreatic amylase.—H. **Grenet**, H. **Drouin**, and M. **Caillard**: The study of some leucocytic reactions following on intravenous injections.—H. **Frossard**: The detection of thoracic vibrations in women and children in pleurisy.

ROME.

Reale Accademia nazionale dei Lincei, November 21.—F. D'Ovidio, president, in the chair.—B. **Grassi**: Life of Anopheles, i.—A. **Comessatti**: Geometric theory of binary forms, i. This part deals with directive ideas and their first consequences.—A. **Denjoy**: "Sur les ensembles parfaits présentant le caractère (A)."—E. **Clerici**: New mineral deposit near Rome. The author records the presence of fluorite and barytes in calcareous deposits near the Villa Farnesina and the tomb of the Nasoni.—A. **Contardi**: Transformations of trioxymethylene.—B. **Peyronel**: Ascophorous form of *Rhacodiella castaneae*, the cause of smut in the chestnut. The author has succeeded in cultivating the perfect stage of this fungus, which he refers to the genus *Sclerotinia*.—A. **Clementi**: Relation between the peptidolytic activity of intestinal erepsin and the chemical constitution of the substratum.—U. **Soli**: Bactericidal power of intestinal mucus.

December 5.—V. **Volterra**, vice-president, in the chair.—O. M. **Corbino**: Thermal analogue of Oersted-Ampère effect and electronic theory of metals.—B. **Grassi**: Life of Anopheles, ii. A number of specimens were dyed and set free, and from their disappearance it was inferred that the summer broods live only about ten days to a fortnight. The author now discusses the question as to whether the insects tend to return to the localities where they have already bitten. The results are sufficiently definite to explain why malaria does not spread more frequently to non-infected districts, and to show that it is more important to kill the mosquitoes in houses, particularly those containing malarial cases, than in such localities as pigsties.—A. **Comessatti**: Geometric theory of binary forms, ii. This part deals with the theorem of Bruno and conic co-variants.—E. **Del Vecchio**: Theorems of uniqueness for parabolic linear differential equations of third order, i.—A. **Denjoy**: "Les rapports des ensembles parfaits présentant le caractère (A) et des fonctions admettant une dérivée seconde généralisée."—M. **Pascal**: Superficial circulation, i. The ordinary conception of circulation round a closed curve is generalised, leading to a measure of circulation in the form of a surface integral over a closed surface. This is a vector which satisfies the usual laws of composition and resolution. The extension of problems from two to three dimensions is contemplated, with especial reference to Joukowski's theorem, according to which cyclic motion in a perfect fluid surrounding a moving body gives sustentation without resistance.—A. **Terracini**: A surface of the sixth order and class the asymptotics of which are skew cubics.—R. **Perotti**: Radical bacilli of *Diplo-taxis erucoïdes*. Three forms of bacilli found on the *Diplo-taxis* roots are described which possess the property of attacking and transforming insoluble carbohydrates such as starch. Their action is not pathogenic, and whether they belong to three species or one is left open.—G. **Cusmano**: Intermolecular condensations produced by oxynitric groups. The author discusses the actions of concentrated sulphuric acid on *o*-aminonitroxybenzol and the action of alkali on *o*-hydroxylaminonitroxybenzol.—The Academy has elected Drs. Pirota and Lanciani to the offices of administrator and assistant administrator respectively.

December 19.—F. D'Ovidio, president, in the chair.—G. A. **Maggi**: Propagation of waves of arbitrary form in isotropic media. A mathematical investigation dealing with objections to Prof. Somigliana's proof, according to which only plane, cylindrical, or spherical waves can be propagated in an isotropic medium subject to the usual conditions.—

C. De Stefani: Ligurian fossil sponges, iii. The remains now described were from a calcareous deposit at San Martino, near the Polcevera, and include *Dictyonina lychniscosa*.—E. Del Vecchio: Uniqueness in parabolic equations of the third order, ii.—A. Campetti: Potential of excitement of electrons in mixture of potassium and sodium vapours.—G. Armellini: Secular perturbations in the inclination of the minor planet Hungaria.—D. Maestrini: Action of enzymes, v.: The resistance of phtalein to the action of hydrochloric acid in presence of starch.—S. Sergi: Vertebro-medullary topography of chimpanzee (*Anthropopithecus troglodytes*, female). The methods adopted are, in the main, those of Pfitzner, and the diagram and tables of measurements are applicable to the study of the comparative anatomy of the chimpanzee and of man in regard to the spinal medulla.—A. Comessatti: Geometric theory of binary forms, iii.: System of co-variants of given degree and Sylvester's theorem.

Books Received.

Practical Dairying. By Dora G. Saker. Pp. viii+123. (London: Methuen and Co., Ltd.) 6s. net.

History and Bibliography of Anatomic Illustration in its Relation to Anatomic Science and the Graphic Arts. By Ludwig Choulant. Translated and edited by Dr. Mortimer Frank. Pp. xxvii+435. (Chicago: University of Chicago Press; London: Cambridge University Press.) 10 dollars net.

Journal of the Scottish Meteorological Society. Vol. xviii. Third Series, No. xxxvii. (Edinburgh and London: W. Blackwood and Sons.) 12s. 6d.

Spot and Arc Welding. By H. A. Hornor. (Technological Hand-books.) Pp. vii+296. (London: C. Griffin and Co., Ltd.) 15s.

The Year-Book of the Scientific and Learned Societies of Great Britain and Ireland. Thirty-seventh Annual Issue. Pp. vii+354. (London: C. Griffin and Co., Ltd.) 15s.

Pope's Manual of Nursing Procedure. By Amy E. Pope. Pp. xi+596. (New York and London: G. P. Putnam's Sons.) 15s.

The Chemistry of Synthetic Drugs. By Dr. Percy May. Third edition, revised. Pp. xv+248. (London: Longmans, Green and Co.) 12s. 6d. net.

The Journal of the Institution of Electrical Engineers. Vol. lix., No. 297, January. (London: E. and F. N. Spon, Ltd.) 10s. 6d.

Metabolism and Growth from Birth to Puberty. By Francis G. Benedict and Fritz B. Talbot. (Publication No. 302.) Pp. vi+213. (Washington: Carnegie Institution.)

The Qualitative Analysis of Medicinal Preparations. By H. C. Fuller. Second edition, rewritten. Pp. viii+191. (New York: J. Wiley and Sons, Inc.; London: Chapman and Hall, Ltd.) 12s. 6d. net.

Red Lead and How to Use it in Paint. By Dr. Alvah H. Sabin. Third edition, rewritten and enlarged. Pp. xi+139. (New York: J. Wiley and Sons, Inc.; London: Chapman and Hall, Ltd.) 11s. 6d. net.

A Text-Book of Geology. By Louis V. Pirsson. Part i.: Physical Geology. Part ii.: Historical Geology. Part i., second edition, revised. Pp. viii+470. (New York: J. Wiley and Sons, Inc.; London: Chapman and Hall, Ltd.) 17s. 6d. net.

Chemistry of Pulp and Paper Making. By Edwin Sutermeister. Pp. vii+479+31 plates. (New York: J. Wiley and Sons, Inc.; London: Chapman and Hall, Ltd.) 36s. net.

Œdema and Nephritis: A Critical, Experimental, and Clinical Study of the Physiology and Pathology

of Water Absorption in the Living Organism. By Prof. Martin H. Fischer. Third and enlarged edition. Pp. xvi+922. (New York: J. Wiley and Sons, Inc.; London: Chapman and Hall, Ltd.) 55s. net.

The Chemistry and Analysis of Drugs and Medicines. By Henry C. Fuller. Pp. ix+1072. (New York: J. Wiley and Sons, Inc.; London: Chapman and Hall, Ltd.) 55s. net.

A Textbook of Oceanography. By Dr. J. T. Jenkins. Pp. x+206. (London: Constable and Co., Ltd.) 15s.

A Manual of the Birds of Australia. By Gregory M. Mathews and Tom Iredale. Vol. i.: Orders Casuarii to Columbæ. Pp. xxiv+279+plates. (London: H. F. and G. Witherby.) 3 guineas net.

Das Physikalische Praktikum des Nichtphysikers. By Dr. F. Grunbaum and Dr. R. Lindt. Dritte auflage, by Dr. R. Lindt and Dr. W. Molius. Pp. xvi+414. (Leipzig: G. Thieme.) 72 marks.

Imperial Institute. Monographs on Mineral Resources, with Special Reference to the British Empire. Lead Ores. By T. C. F. Hall. Pp. ix+127. (London: J. Murray.) 6s. net.

The Quarterly Journal of the Geological Society. Vol. lxxvi. Part 1, No. 304, March. Pp. 325-412+xiv+plates. (London: Longmans, Green and Co.) 7s. 6d.

Diary of Societies.

THURSDAY, MARCH 31.

INSTITUTE OF METALS (at Shaftesbury Hotel, Great St. Andrew Street), at 8.—S. L. Archbutt: Aluminium Alloys.

FRIDAY, APRIL 1.

ROYAL SOCIETY OF MEDICINE (Laryngology), at 4.45.
ROYAL SOCIETY OF MEDICINE (Anæsthetics Section), at 8.30.—Dr. R. L. M. Wallis and Dr. C. L. Hewer: A New General Anæsthetic: Its Theory and Practice.

CONTENTS.

	PAGE
Research and National Progress	97
Matter and Motion. By Prof. A. Gray, F.R.S.	98
A Socialist Commonwealth. By Barbara Wootton	100
Science for the Young Farmer. By E. J. R.	101
A Fabre Anthology	101
Our Bookshelf	102
Letters to the Editor:—	
Atomic Structure.—Prof. N. Bohr	104
The Dimensions of Atoms and Molecules.—Prof. W. L. Bragg and H. Bell	107
The International Research Council.—Prof. G. H. Hardy, F.R.S.	107
Solar Radiation in Relation to Facule. (With Diagram.)—H. H. Clayton	108
The Sound of Distant Gun-fire.—C. Carus-Wilson; Dr. Charles Davison	108
Electrons. II. (Illustrated.) By Sir William Bragg, K.B.E., F.R.S.	109
Reformed Cannibals. (Illustrated.) By A. C. H.	111
Obituary:—	
Prof. A. G. Nathorst. By Prof. A. C. Seward, F.R.S.	112
Notes	114
Our Astronomical Column:—	
New Comet 1921a	119
Re-appearance of Saturn's Ring	119
Brazilian National Observatory Annual	119
The Royal Anthropological Institute. By E. N. F.	120
Publications of the U.S. National Research Council. By J. W. Williamson	121
Psychotherapy and War Experience. By Prof. T. H. Pear	122
University and Educational Intelligence	123
Calendar of Scientific Pioneers	124
Societies and Academies	125
Books Received	128
Diary of Societies	128



THURSDAY, MARCH 31, 1921.

Editorial and Publishing Offices:

MACMILLAN & CO., LTD.,

ST. MARTIN'S STREET, LONDON, W.C.2.

Advertisements and business letters should be
addressed to the Publishers.

Editorial communications to the Editor.

Telegraphic Address: PHUSIS, LONDON.

Telephone Number: GERRARD 8830.

Inventions and Grants in Aid.

A NOT inconsiderable result of the Great War and its long continuance was the flood of invention which threatened to overwhelm complacent bureaucracy. That procedure, admirably adapted to a Crimean or a South African campaign, was altogether inadequate for coping with the necessities of a nation in arms; and a people whose very existence as an independent State was threatened became more and more apparent, and at length penetrated the inner fastnesses of officialdom. New weapons of offence, improved systems of attack, and almost superhuman devices for stemming murderous onslaughts were demanded. The exigencies of a situation which had become grave, if not critical, compelled the opening of the ranks of a hitherto jealously guarded profession and the unstinted admission of the efforts of the civilian to whom organisation, the employment of scientific method, and the adoption of the latest invention, through keen competition in the open market, had become daily routine. Thanks to the Press and to many another non-official organisation which proclaimed the advent of a new era in military and naval operations, the inventive faculty of the community was aroused and stimulated to action. To such a length did this proceed that it may not be too much to assert that there was scarcely an occasion when a problem definitely and precisely

formulated did not result in a solution through well-thought-out invention.

The knowing and the wary, before submitting the product of their inventive genius in their country's defence, obtained letters patent, and, for good or for ill, invoked the aid of the law for securing remuneration proportional to their ingenuity or to the proved ability of their inventions. In this respect such a one was wise, for from the First Report of the Royal Commission on Awards to Inventors¹ it is seen that the Commissioners interpreted liberally the sections of the Patent Acts of 1907 and 1919 which gave to the inventor, as against the Crown and its Departments, rights comparable with those prescribed where the mere subject was concerned. As regards inventors who, possibly esteeming their country's interests superior to their own, omitted to exchange a five-pound note for a patent, the Commissioners point out that the exercise of bounty was wholly within the discretion of the Crown, there being no statutory right to payment or reward for the use of their inventions. Nevertheless, it would appear that according to the terms of the Warrant under which the Commissioners were appointed, unpatented inventions were to be investigated, and, where shown to have been used in the service of the Crown, a just measure of compensation was to be recommended. In the instance of a lapsed or expired patent the Commissioners were careful not to recognise any right to compensation, as the invention was open to the world, and, indeed, might have been used by our enemies to our detriment.

As regards subsisting patents, by section 29 of the Patents Act of 1907, a section which inured for some time after the appointment of the Commission, the final arbitrament in the matter of compensation for the use of an invention lay solely with his Majesty's Treasury. By the substituted section 8 of the Patents Act of 1919, where a dispute as to user or as to terms was present, the High Court was given jurisdiction. But, manifestly, it was to the interest of the patentee—and, indeed, of all parties—that disputes should be avoided so far as possible. This desirability, amounting almost to a necessity, was fully recognised by the Commissioners, who considered that an equitable basis for compensation was to be found in the amount that a willing licensor could obtain from a willing licensee bargaining on equal terms. In private bargains the

¹ Royal Commission on Awards to Inventors. First Report. Cmd. 1112. Pp. 13. (London: H.M. Stationery Office.) 2d. net.

consideration was often fixed on the basis of a royalty, and the Commissioners saw no reason for departing from this method of assessment.

Even when this position was reached, it was seen clearly that in estimating payment upon a percentage basis there were still present many special factors which, varying almost in each case, were to be taken into account, as, for example, where an invention which could be supplied at a cheap rate produced consequences out of proportion to the cost of the article. Where some doubt was present as to the validity of a patent, or as to the use of an invention, a more or less empirical discount or deduction had to be made. A deduction was also required where the inventor was in the Government service, in a military, naval, or civil capacity, and had been allowed to patent his invention jointly with an official representative. A further notable instance lay in the case of an official who had been placed in a situation with the full knowledge that the opportunities presented to him might lead to successful invention to which the Government might justly lay claim. In general, such instances were relegated by the Commissioners to the two categories of inventions in respect of which no legal right to compensation was present, and, on the other hand, where the inventor, at the request of a Department of State, or on the broad ground of public policy, had refrained from securing a patent.

As regards that large class of unpatented inventions which came before the Commissioners, applications for reward by originators were considered broadly and with due regard to all the circumstances of the case, and not merely from the stricter legal point of view which was taken up when the patented inventions were under investigation. But, the position having been reached of rewarding patentees upon the basis of "a willing licensor and willing licensee bargaining upon equal terms," it would have been altogether unjust to refuse similar terms to those who abstained from securing recompense as of legal right.

A class of case which presented difficulty was where a general idea or suggestion of extreme importance had been put forward, but had not been extended to a concrete example. Without the idea there could have been no embodiment; without the embodiment the idea would have been useless. The embodiment might have been solely due to the action of Government officials, yet it would manifestly have been unjust to refuse to acknowledge pecuniarily the originator of the

idea. In passing, we may remark that there is to be found here a flaw in the protection afforded by our Patent Law. So often the concrete example which an inventor has put forward is virtually useless until the eye of the expert user has been directed to it and suitable modification effected. Such modification may not have within it, as the law stands, that degree of inventive ingenuity which would secure validity to a patent, but without which, nevertheless, the original invention would prove abortive. This consideration was evidently present to the Commissioners, for in every case their decision depended on how far the inventive idea of each claimant, whether proximately or remotely, caused or contributed to the use by the Crown of the particular invention or device. As the Report puts it, the claimant had to show that his idea or device formed at least a link in the chain of causation leading to the use of the invention.

Those who are in constant touch with inventors know full well how the crudest ideas and the most elementary notions are put forward from time to time in all seriousness and with full belief in their efficacy. It is also common knowledge that when examples perfected by the close attention and prolonged application of the expert, without the slightest knowledge of the suggestions of others, become known, claims to inventorship are made by those who had submitted their immature ideas. So, too, the Commissioners found it necessary to deal with a large number of claims which upon their face showed no reasonable chance of success. In order that the time of the Commissioners might not be frittered away upon applications of a trifling or negligible character, a preliminary sifting was effected by a small committee. If the committee was unfavourable to an investigation by the Commission as a body, full opportunity was given, in all but the most hopeless examples, for the applicant to appear personally to urge his claim. This procedure worked well.

As regards the actual sums recommended to the Treasury for disbursement, they do not appear to have erred on the side of niggardliness. Possibly this was right. When it is remembered how great, over and above normal commercial profits, were those which were secured by contractors and others to whom the manufacture of munitions was deputed, it would seem just that the reward to originators of the designs which were under construction should bear some relation to the excess of profits which the originators, in favour of others, were primarily the cause of bringing into

being. Thus one may see how the whole scale or plane of payment to inventors became raised.

But the Commissioners considered themselves bound by the terms of the Patent Acts and by the state of public opinion, which had slowly crystallised during a long period when such a cataclysm as a world-wide contest was not in contemplation. With respect to those inventions which were not patented, more credit is perhaps due to their originators, since, rather than tie the hands of the Executive by appeal to statute, they were content to leave over the settlement of any claim which might be theirs to calmer times, and to rely upon the just sense of the community for the recognition of their services. In this respect we should like to have seen more acknowledgment of this disinterestedness than is evinced by the Report.

After all, the question arises as to the morality of the recommendation of grants. At a time when so much was at stake, when the call was sounded for the endeavour of every individual towards the single object of winning the war, is it altogether right, it may be asked, that huge sums of money should be paid over by the State to those who, gifted with inventive genius, were successful in solving in a practical manner the problems with which the nation was temporarily confronted? That some recognition should have been accorded, no one could gainsay; but it is a different matter to attempt to recompense on a business footing those who, at a period of grave national stress, might justly have been called upon to exert their utmost towards staving off imminent peril without excessive fee or reward. As regards inventors who took advantage of the protection afforded by Patent Law, and secured thereby legal rights to compensation, the arbiters before whom the question of recompense might finally have come could with fairness and reason have called into review the duty incumbent upon every citizen to employ at such a time every faculty with which he was endowed, and to have recommended reward proportionate thereto.

As it is a "First Report" that we have been considering, we look forward with interest to a supplementary publication, when it is to be hoped that the terms of the Warrants under which the Commissioners were appointed may appear. In the present instance the terms are absent. In the next Report we would also suggest typographical improvement in its presentation, such as the employment of marginal references, a "display" of paragraphs, the grouping of closely allied subject-

matter under informative cross-headings, and a less rigid economy in space and paper. Moreover, a greater freedom in style and exposition would be of assistance to the reader. By the adoption of suggestions such as these, a far more readable document could be secured, and much valuable reasoning and information run less risk of being overlooked. And if the price of two-pence were raised to sixpence, or more, in order to secure these advantages, few would be found to complain. As is the case with so many Reports which emanate from Government sources, the force and value of this First Report are not spent with its publication. The close reasoning with which it is packed, the equitable manner in which the Commission directed its conclusions, and the discrimination which it brought to bear upon the difficult tasks with which it was faced, render the Report a valuable document to all who in any way are, or may be, concerned in assessing compensation or reward for the use of inventions patented or unpatented. Indeed, the Report might well form the basis of a chapter in a classic which concerned itself with the patent system of this country and its administration. We can give it no higher praise.

As regards rewards for future inventions and discoveries, and means for stimulating research, the best method of arriving at satisfactory conclusions is, from the nature of the case, far from settled. Circumstances in respect of men and objects to be secured or aims to be achieved vary to such a degree that principles capable of general application and acceptable to large bodies of workers are difficult to formulate. As described in *NATURE* for February 21, 1918 (vol. c., p. 484), Mr. Walter B. Priest would assimilate the allocation of funds to scientific research through a special Statute modelled upon our Patent Law. Since that time Mr. Priest has continued to keep in the forefront his scheme for the promotion of scientific research, and has adapted it to the work of the Advisory Council of the Department of Scientific and Industrial Research. In a series of memoranda the working of the scheme, as modified by special conditions, is set out at length.² These memoranda, supplementary to the original scheme, were submitted to the Department. In due course Mr. Priest was thanked for his views, and informed that they would receive careful consideration. Mr. Priest is particularly anxious to assist in scientific discovery, for which in-

² The Administration of Grants for Scientific Discoveries. Scheme and Memoranda. By Walter B. Priest. (Privately circulated, 1921.)

adequate remuneration exists on account of patents not being obtainable for them, or for some other cause, but which has effected or contributed to the attainment of any industrial purpose.

The scheme to which attention is again directed would affect the bestowal of grants in the case of discoveries which, for example, elucidated specified phenomena or solved specific problems. The promotion of research by means of rewards, Mr. Priest considers, would also obviate the difficulties connected with the selection of research workers, their remuneration, the duration of their employment, and their control or supervision. The chief purpose of the scheme is to provide trustworthy means for the administration of grants for rewarding the discoverers in the subjects specified in the proposed allocation of the grants. Endeavour has been made to provide for all contingencies, such that no earnest student or investigator need despair of receiving pecuniary assistance at a time when it is most needed.

Mr. Priest is far from sanguine that the methods foreshadowed by the Advisory Council of the Research Department would solve the problems how best to encourage inventors and to assist individual manufacturers who desire assistance. He thinks that a procedure which based awards on personal knowledge of the research worker, or of the individual recommending the research worker, is inequitable, and that the methods of promoting research by grants in aid are fundamentally defective.

The memoranda, which are far too long to be summarised adequately here, may be considered as an advocacy of the system which Mr. Priest has outlined in his draft of a Bill which has for its object the regulation of the allocation of money grants for discoveries in a manner analogous to that of grants of letters patent for inventions.

The Embryology of Crinoids.

Papers from the Department of Marine Biology of the Carnegie Institution of Washington. Vol. xvi. Studies in the Development of Crinoids. By Th. Mortensen. (Publication No. 294.) Pp. v+94+xxviii plates. (Washington: The Carnegie Institution of Washington, 1920.) 6 dollars, post free.

THE early stages in the life-history of recent crinoids have always been regarded with interest, because it was hoped that they would

throw light on the evolution of this class, so rich and various in ancient seas, and on its relation to the other very differently fashioned classes of Echinoderma. Unfortunately, the only forms that have up till now furnished material for the embryologist are the unstalked comatulids, or feather-stars, and in the past such material has come from but a single genus, and from only three closely allied species of it—*Antedon bifida* of our own coasts, *A. mediterranea*, and *A. adriatica*. The accounts of their development by W. B. Carpenter, Bury, Seeliger, and others have shown slight differences, due, in part, probably to specific distinctness of the material. Even if it were not feasible to obtain the early stages of any stalked crinoid, still a study of other species, representing other genera of comatulids, was much to be desired, since it might then be possible to infer which features were peculiar to *Antedon* and which were common to comatulids generally, if not to the whole class Crinoidea. Such a study has now been made by Dr. Mortensen, who has obtained a fairly complete series in four genera, and the pentacrinoid larvæ of two others. His results are set forth in clear English with his usual care, and the memoir is illustrated by admirable drawings from his own pencil. His many interesting results are discussed in a "General Part" which demands the attention of professed morphologists. Here we shall select for comment a few observations that bear on the past history of the class.

The three species of *Isometra*, *Notocrinus*, and *Thaumatometra* from the Antarctic Sea resemble other echinoderms from that region in protecting the brood. *Tropiometra carinata*, from the coral reefs of Tobago, and *Antedon petasus*, of the Scandinavian fjords, set their eggs quite free. These two extremes are clearly modifications of the normal plan in which the eggs cluster round the genital openings, and the pentacrinoids attach themselves to some part of the mother or her immediate neighbourhood. This agrees with the colonial habit of many fossil crinoids, in which the roots of the young are frequently attached to the stem of the putative parent. As in echinoderms generally, protection of the brood appears to involve yolk-laden eggs with meroblastic cleavage; but the normal egg with less yolk retains the regular cleavage.

In its early days the crinoid larva has no mouth, but in the normal plan the primitive gut (archenteron) curves ventrally to meet the invagination (vestibule) into which the mouth afterwards opens. We may infer that there was once a stage in which a larval mouth, opening in that

position, persisted as the mouth of the adult, and this probably represents an ancestral stage of all echinoderms.

The opening of the hydrocoel (the subsequent water-ring) to the exterior has a strange history. First a prolongation from the incipient hydrocoel is cut off as a canal, called parietal. This effects an outer opening (pore No. 1), which afterwards closes. At a later stage a fresh canal (stone-canal) grows out from the water-ring and opens into the remains of the closed parietal canal; and a fresh pore (No. 2) opens from outside into the same parietal canal. Thus the water-ring is for the first time connected with the outer medium. Dr. Mortensen regards pore No. 2 as homologous with the madreporic openings in other echinoderms, and he is probably right. Yet he also regards it as identical with pore No. 1 when speaking of its "temporary obliteration," although several ancient stalked echinoderms, in various classes of Cystidea, have two neighbouring but distinct openings, one of which is plainly a water-pore (pore No. 2), while the other has been regarded as the opening of the parietal canal (pore No. 1). These facts suggest that pore No. 1 never was a water-pore, but may have been a gonopore, or excretory, or both. Close to the parietal canal, in the dorsal mesentery, is a group of cells regarded by Dr. Mortensen, following Russo, as a primary gonad homologous with the genital organ of Holothurians. Dr. Mortensen believes that this structure is soon absorbed, and that the genital organs arise as a new structure connected with the axial organ. If the original cells are not carried over into the subsequent gonad, their genital nature seems unproved. It is not impossible that some persistence may ultimately be detected. Meanwhile, their position harmonises with the suggestion that the genital products were set free into the parietal canal and emerged through its pore (No. 1), which was the gonopore of the cystids.

The crinoid larva normally fixes itself by its anterior end, and the vestibule then moves up towards the future oral end of the pentacrinoid. Thus the cup of the crinoid is erect on a straight stem with a flattened base (like a wineglass). In *Tropiometra* the suctorial disc is weak; many embryos fall to the bottom, and the migration of the vestibule is hindered by pressure; thus the crinoid grows with a curved stem. May not such a cause have initiated the evolution of the curved stems and pendent crowns in *Herpetocrinus* and the *Calceocrinidæ*?

Dr. A. H. Clark has maintained that the anal

plate of comatulids represents the radianal (the lower half of the right posterior radial), while others have homologised it with the other anal (x) of palæozoic inadunate crinoids. Dr. Mortensen believes that his observations fully confirm the latter view, and, further, indicate that x was derived by vertical fission from the upper half of the right posterior radial. This seems a sound hypothesis, and it really differs very little from that implicit in the tentative term "brachianal." Opposed to all these is the fourth hypothesis, that the anal x was an entirely new growth. It must be left to fossils to decide.

Infrabasals have been detected in *Antedon mediterranea* and *A. adriatica*, but not in *A. bifida*; Dr. Mortensen, however, always finds them in that species. *Isometra*, *Fiorometra*, and *Thaumatometra* are the only forms in which he has not found them. In all cases the first cirri are radial in position, as they are in all Crinoidea Dicyclica, whether the infrabasals have atrophied out of existence or no. It is not realised that the position of the cirri depends on the position of the nerves of the aboral system, a position originally governed, no doubt, by the presence or absence of infrabasals, but maintained without regard to the subsequent history of the skeleton.

Dr. Mortensen observes that in the growth of these crinoids the pinnule-bearing brachials no longer make their first appearance as axillaries. Since he admits, however, that each pinnule has the morphological value of an arm, the brachials which bear them are, morphologically, axillaries. That the pinnules did originate as arm-branches is confirmed by palæontological evidence.

Palæontologists have long since given up Lovén's attempt to homologise the elements of the crinoid cup with the apical plates of echinoids. It is satisfactory to find Dr. Mortensen led to the same conclusion. But that is a big subject. We have said enough to show that for this fruitful memoir our Danish colleague and his American publishers deserve the thanks of morphologists, embryologists, and palæontologists.

F. A. BATHER.

Electrical Theory and Relativity.

The Mathematical Theory of Electricity and Magnetism. By J. H. Jeans. Fourth edition. Pp. vii+627. (Cambridge: At the University Press, 1920.) 24s. net.

SINCE the third edition of this volume was published in 1915, the theory of relativity has been developed. It is now recognised that Max-

well's theory that the ultimate seat of electromagnetic and optical phenomena is in the æther may have to be modified or even abandoned. Experiments have proved that natural phenomena go on exactly as if there were no æther. We agree with the author in thinking that "the hypothesis that there is an æther may give a possible explanation of the phenomena, but the hypothesis that there is no æther provides an equally possible and very much simpler explanation." Einstein's theory, unfortunately, although it helps us to discover the laws according to which phenomena occur, cannot lay claim to provide a mechanical explanation of them. Electricians know the importance of discovering the mechanisms by means of which electric and magnetic forces are transmitted through space. When the nature of these mechanisms is discovered, there will probably be a great advance in the practical applications of electricity. The theory of relativity, a very convincing explanation of which is given in this book, proves that it is unnecessary to presuppose an æther. This is welcome, as it is known that highly complex properties must be ascribed to an æther in order that it may explain both electrical and magnetic forces. In the kinetic theory of gases, forces and pressures are explained by a flow of momentum, and a similar explanation might be given of electrical, magnetic, and gravitational forces.

From the practical electrician's point of view, the value of this volume would be increased if the ordinary working formulæ for the high-frequency resistance and inductance of cylindrical wires were given. Kelvin's electrostatic and hydro-kinetic analogies are useful in this connection. The engineer also wants the formula for the capacity between parallel cylindrical wires. The fact that a brush discharge begins at a perfectly definite value of the potential gradient is the principle on which accurate high-pressure voltmeters are constructed, and it is known that the sparking between spherical electrodes occurs at a definite potential gradient. Kelvin's formulæ for the attraction and repulsion of electrified spheres are proved, but no explanation is given of the column headed "Ratio of charges for equilibrium." We doubt whether the average reader would infer from this that spheres electrified with like charges would repel one another when far apart, and attract one another when close together. In conclusion, we can recommend this book to every student who has a sound mathematical training, and every man of science should read the new chapter on the theory of relativity.

A. R.

Mathematical Text-books.

- (1) *The Elements of Plane Geometry*. By Dr. C. Davison. Pp. viii+280 (with answers). (Cambridge: At the University Press, 1920.) 10s. net.
- (2) *A Primer of Trigonometry for Engineers: With Numerous Worked Practical Examples*. By W. G. Dunkley. Pp. viii+171 (with answers). (London: Sir Isaac Pitman and Sons, Ltd., 1920.) 5s. net.
- (3) *Pure Mathematics for Engineers*. By S. B. Gates. With an Introduction by H. A. Webb. Part i., pp. xi+191. Part ii., pp. xi+179. (The New Teaching Series.) (London: Hodder and Stoughton, Ltd., 1920.) 4s. 6d. net each vol.
- (4) *A Second Course in Mathematics for Technical Students*. By P. J. Haler and A. H. Stuart. Pp. viii+363. (London: W. B. Clive, University Tutorial Press, Ltd., 1920.) 6s.
- (5) *Elementary Applied Mathematics: A Practical Course for General Students*. By Prof. W. P. Webber. Pp. ix+115. (New York: John Wiley and Sons, Inc.; London: Chapman and Hall, Ltd., 1920.) 7s. 6d. net.
- (6) *The Laws of Mechanics: A Supplementary Text-book*. By S. H. Stelfox. Pp. xi+201. (London: Methuen and Co., Ltd., 1920.) 6s.
- (7) *Elementary Dynamics: A Text-book for Engineers*. By J. W. Landon. Pp. viii+246. (Cambridge: At the University Press, 1920.) 10s. 6d. net.

(1) **T**HIS is a book in the old style, written by an old hand, and it has all the lucidity that we have learnt to expect of its author. The subject-matter is that of the first six books of Euclid, with the addition of some miscellaneous theorems on such subjects as concurrency and loci. The method and the arrangement are approximately those of Euclid, with some modern improvements. The book is the latest of its kind and probably the best.

The difficulties of a geometry of this type come mostly at the outset. When we went to school, in a less enlightened decade, we were taught that "a straight line lies evenly between its extreme points," and this elusive phrase, which seems to have a meaning, has haunted and mocked us ever since. Dr. Davison says (p. 1):—

"A straight line is sometimes defined as a line which has the same direction from one extreme point to the other. The definition is, however, imperfect owing to the use of the word 'direction,'

to which no meaning has been given. The following definition is free from this objection.

"Def. 1. A straight line is a line such that any part of it, however placed, may be made to lie upon any other part of it."

Alas! there are twenty-five words in this definition, and "no meaning has been given" to at least twenty-one of them. It is here that trouble lies for every beginner, and here lies also one reason why the modern teacher has taken to experimental geometry.

In a geometry which is essentially logical and metrical we should like to find the mechanism of measurement treated more fully. Dr. Davison does define "greater" and "less" in terms of "between" for segments of straight lines; but this is scarcely satisfactory for angles (p. 4), although thereafter the idea of magnitude is supposed to be sufficiently known. Again, in the subject of proportion incommensurables are given only a little paragraph in small type (p. 186). It is to be regretted that the author has not followed Prof. M. J. M. Hill in giving adequate treatment to this important notion.

(2) There is now a great host of books on mathematics for engineers, and most of them are bad. Here is a good book. Mr. Dunkley's programme is modest; it covers the ground as far as the solution of triangles. The main text is clear and sound, and it is incorporated with well-chosen examples of mechanisms which are fully worked out and illustrated with excellent diagrams. Each theme that is entered upon is followed through to the finish in a way that will give mental satisfaction to the student. Mr. Dunkley describes himself as a machine tool designer, and is apparently not a teacher.

(3) These two unhappy volumes are in contrast with the last. The author sets himself the task of covering the whole range of pure mathematics from the beginnings of algebra to volume integration, but it is difficult to see why the book is "for engineers," as there is scarcely a reference to engineering in the whole of it. The quality of the mathematics may be judged by a single citation (p. 97):—

"... for a series to be convergent the following conditions must be satisfied. . . .

"(3) The ratio of each term to the preceding must always be less than 1."

(4) This book is considerably better than the last. Much less ground is covered and there is a large collection of relevant exercises, which is the chief merit of the book. The text is not good. There is the tendency, familiar in such books, to

introduce advanced subjects too early, e.g. infinite series on pp. 28–32 before simple equations. The treatment of the calculus is pedagogically unsound. Thus a differential coefficient is explained graphically as the slope of a graph (p. 150), but the authors say nothing about tangents until the foot of p. 154. When a tangent is at length introduced, it is explained as "the tangent to a circle which most closely coincides with the small portion of the graph on either side of the point." The introduction of differentials (p. 158 *seq.*) without any explanation is to be deprecated. It becomes unpardonably loose later on: " $dy = \frac{1}{3}(3x^2) = x^2$. Hence the integral of $x^2 dx$ is $\frac{1}{3}x^3$ " (p. 181).

(5) "Applied mathematics" does not here mean mechanics. The book is written "to meet the needs of students who want some elementary mathematical training that they can use in everyday affairs." The chief need of American students appears to consist in having every problem turned inside out, and may be judged by the following typical exercise (p. 74):—

"Sold cotton on 5% commission, invested the proceeds in sugar at 2% commission. My whole commission was \$210. What was the price of the sugar and cotton?"

We do not need to work out such problems this side of the pond: we know the price of our sugar before we start; we find it easier.

There is, however, one thing in Prof. Webber's book that we do need, and do not often find in English books, and that is half a dozen pages on statistics.

(6) We like this book. The author calls it "a supplementary text-book," and makes no effort at completeness of exposition, but selects a number of subjects which are not often satisfactorily dealt with in ordinary text-books, and he dwells upon them at length. His style has the *naïveté* and freshness of first discovery, and there is nothing of that supercilious haste that one is accustomed to expect in a book designed for engineers. Although the author does not aim at completeness, he achieves nevertheless a certain continuity and unity. Among subjects that receive a chapter each are:—Dimensional arithmetic, calculus notation, the laws of equilibrium, and velocity diagrams. The last chapter contains an illuminating discussion of four or five examples of applied mechanics.

(7) Mr. Landon's book combines a text on more or less academic lines with well-selected examples from engineering as it is taught in colleges. The examples are clearly stated and neatly worked out, but somehow the author does not seem to dwell

upon them as if he liked them. A special feature is made of the treatment of the "laws of momentum," which replace Newton's laws of motion. This treatment is as follows:—After a cursory reference to mass on p. 2, two chapters are devoted to kinematics. In chap. iii., p. 57, momentum is defined. Then the "first law" appears (p. 58):—

"In any body or system, the total momentum remains constant unless the body or system is acted upon by some external force. . . .

"The first law introduces a new term, viz. force, which may, for the present, be defined thus:—

"Force is that which produces or tends to produce a change of momentum.

"The law is the result of observation."

We prefer Newton, but it is only fair to recognise that "laws" are always a difficulty in elementary mechanics, and on the whole we are inclined to recommend the book. H. B. H.

Our Bookshelf.

Animal Life in South Africa. By S. H. Skaife. With an introduction by Prof. F. Clarke. Pp. x+281. (Cape Town: T. Maskew Miller; Oxford: Basil Blackwell, 1920.) 15s. net.

THIS book is intended to help teachers and pupils in South Africa to get to know some of the common animals of every grade. It is clearly written and abundantly illustrated with simple "thumbnail" sketches, many of which will enable the student to identify what he has seen. More critical sifting of the illustrations would have eliminated a number—e.g. that of *Apus*—which blur the total impression. It is almost impossible, except for men like Huxley, gifted with an unusual educational sense, to write a book useful for teachers and pupils alike, and though Mr. Skaife has done well, he sometimes falls between two stools—being sometimes too simple, sometimes a little difficult. There are also various statements requiring reconsideration, we think; thus we do not believe that the liver-fluke feeds partly on bile, and we are sure that a sea-urchin's teeth do not work up and down in their sheaths. But these are small matters; we mention them only as instances of a kind of defect that might easily be remedied, for the book as a whole is sound and careful, and it will be of great service. The chapters on insects, spiders, scorpions, and ticks are particularly good. We are interested to read that *Peripatus* may be fed on raw minced liver. "A female with twenty to thirty young ones clustering around her like chicks round a hen make a very pretty family party." Two educational remarks seem called for: (1) It is very doubtful whether we are warranted in using a word like "ugly" for such animals as the fishing-frog or *Galeodes*—it seems like undoing one of

the endeavours of Nature-study, which is to show that no wholesome free-living wild creature can be called common or unclean. (2) Is there not more than once—e.g. in regard to flat worms and gapes-worms—a distinct and deplorable tendency to bowdlerise the elementary facts of sex? Because we appreciate Mr. Skaife's good workmanship, we would ask him to reconsider these points. The book appears to be extraordinarily dear.

Anniversaries and Other Poems. By Leonard Huxley. Pp. x+82. (London: John Murray, 1920.) 5s. net.

A BOOK of dignified and melodious poems, in which it is interesting to observe the natural history touches—the child's poetic vision is compared to that of some under-water larval creature, glimpsing the sky, seeing "crooked tops to the tall, straight trees"; the full waves of the floral tide in a southern April, breaking on the hill "with white narcissus for their foam," are contrasted with the shyer coming in the north, with "less of fire and more of dew," and yet with its own exuberance, for

bluebells thick in budding woods
Stretch pool on pool from tree to tree,
All heaven in their dew-drenched floods
Of blue that mock your Midland sea.

Mr. Leonard Huxley is a lover of Nature, both of the great appeals and of the tiniest things that pass from sense to soul, from Nature's heart to man's. Common things are dear to him in themselves, not merely as emblems. Of the speed-well, "blue flower of happy name," he writes:—

It buds on every fallow swell,
And the bright wish it bids me frame
Fills earth as music fills a shell.

Nature may or may not be fathomable, but surely it is still unfathomed, and we are among the heretics who think that of some of its depths not reached by the scientific dredge we get an inkling by the medium of disciplined feeling. Mr. Huxley makes his contribution, a perfectly clear-eyed one, and we do not agree more than a very little with the mood of the last poem, "The Land of Might-Have-Been," "portioned with felicity" though that mood be. The author has gone much further than that.

Mechanism, Life, and Personality: An Examination of the Mechanistic Theory of Life and Mind. By Dr. J. S. Haldane. Second edition. Pp. vii+152. (London: John Murray, 1921.) 6s. net.

THE new edition of Dr. Haldane's little work is substantially the same, so far as subject-matter is concerned, as the first edition, which was reviewed in *NATURE* for October 22, 1914. It is in the fourth lecture, on personality, that the main changes have been made. The whole chapter has been recast, and some additional matter inserted with the object of bringing home to the reader more certainly the meaning of this admittedly difficult subject.

Letters to the Editor.

[The Editor does not hold himself responsible for opinions expressed by his correspondents. Neither can he undertake to return, or to correspond with the writers of, rejected manuscripts intended for this or any other part of NATURE. No notice is taken of anonymous communications.]

The Common Occurrence of Aurora in the South of England.

SEVERAL observers have from time to time reported that the green auroral line ($\lambda 5578$) is commonly observable in the sky at night. I have often tried to see it myself with various instrumental arrangements, but without success. Slipher, however (*Astrophys. Journ.*, 1919), succeeded in photographing the line on every clear night that he tried. He worked at the Lowell Observatory, California, as far south as lat. 35° N.

Stimulated by his results, I have succeeded in photographing the line on many nights for the past month. I do not always get it, and one of the failures has been on a fairly clear night. On the other hand, many of the successes have been on cloudy, though not, of course, extremely dark, nights.

At the present time sun-spot minimum is much nearer than during Slipher's experiments, and for this and other reasons I am inclined to think that I have been dealing with fainter auroras than he did. Success has been due in the main to the use of Marion's new "iso record" plates, which are very sensitive in just the spectral region which is needed.

The programme in view is a systematic comparison of the auroral intensity with sun-spots and magnetic disturbances, and also a comparison of its intensities in different localities in Great Britain and elsewhere. So far as I have been able to learn, the auroral spectrum has not previously been photographed in this country.

RAYLEIGH.

Terling Place, Witham, Essex, March 21

Mount Everest.

AN important event which will add greatly to our knowledge of physical geography, as well as of all branches of science, has come to pass. The permission of the Dalai Lama has been obtained to our entry into Tibet. For this we have to thank Sir Francis Younghusband for his early love of travel, which took him through so many miles of elevated wastes in Central Asia, culminating in his present influence, the result of a successful military expedition, and the presence to-day of a Political Officer in Lhasa, Mr. Bell.

The president of the Royal Geographical Society (*Geographical Journal*, February, p. 73), after summing up what has to be done in the country, says, "Our geography of it must be complete"; he could not say more than he did in these few words.

The changed conditions at once opened up the possibility of knowing more of the highest peak in the world, Mount Everest, the surrounding topography, the best way to it, and, lastly, what will be possible on its flanks. After all, the supreme advance and gain are centred upon the survey of Tibet; if this can be extended at any point on the thousand miles or so between Kashmir territory and Assam, through Rudok, Gartok, Hundes, the northern boundary of Nepal, Sikkim, Bhutan, Aka, etc., our successors may in time look forward to the possession of maps of the whole Himalayan chain, including its northern side. Another great advance will be to

master the secrets of its internal structure and to extend what we at present know of Himalayan geology to where so few with the necessary knowledge have as yet penetrated.

In thinking of a vast country one is led to dream, and in the making of this great map my thoughts tell me that the Tibetans can be employed. Their artistic abilities are great; art they have practised for centuries. Almost alone among the Asiatics I have known they can use a map intelligently; they would soon excel in surveying. When I taught a few Lama draughtsmen perspective they were delighted. Thus I am led to contemplate a branch office of the Indian Survey Department at Lhasa, for instruction there would be better for many reasons than in India.

The Duke of the Abruzzi's expedition to the Mustakh glaciers has been taken as a model for the present one, yet it must not be forgotten that all the conditions are different. In the former case the country was known; it was in a native State under the control of the Indian Government, and not far distant from a well-populated district with a sufficient supply of food. It did not matter how many Europeans were attached to it; it was carried out luxuriously and at great expense—so expensive was it that I fear these great expeditions will render future travel over the same ground almost impossible for the ordinary explorer.

For this first advance into Tibet I would have preferred myself, and taken for a model, the work of Sir Aurel Stein. His topography (the work of two native surveyors) of the Kuenlun range, etc., is excellent, and surveyors with similar training would be the fittest men in Tibet. It is unfortunate that the native surveyors, excellent, really splendid, men as some of them are, have not the education and knowledge to observe and write on the country they map; but we cannot have perfection.

In a recent article on Mount Everest in the *Surrey Advertiser* I said: "Of this I am convinced, the smaller the party and the less fuss made about it the better." This is truer now than when it was first written. From what I read in the papers and from a circular from the president of the Alpine Club the size of the party is indicated and its growth is fast—five and a doctor. To this has to be added the survey party.

A great deal has since been published from various sources regarding what has to be done before Mount Everest is reached; it is mostly imaginative, for we know really nothing, having so little to guide us. No more is known than I knew when I left the top of the Senchal Trigonometrical Station, Darjeeling, in December, 1863. I had been examining the position of Mount Everest far away on the west, and this with a surveyor's eye, noting the points and peaks to be visited and the general lie of the ground. I have a vivid recollection of it; all remains the same and is common knowledge. The best authorities at present are Ryder, Younghusband, and Bruce, for they have seen the Everest mass at shorter distances. Darjeeling is now the terminus of a railway a few hours' run from Calcutta. This fact much affects an expedition starting from it, which is well set forth by Lt.-Col. C. Howard Bury in the *Geographical Journal* for February, p. 121. Still, some things have not altered, and I can confine myself to what I would have done so many years ago had I been deputed to survey the head-waters of the Arun River—of course, with the Tibetans prepared to see me and with political troubles absent, as they are at present. I would have worked precisely as I had done in the previous summer when I surveyed the Pangkong Lake and the high country of Changchingmo (*vide Proc. Royal*

Geograph. Soc., December, 1866). I would have proceeded by the head of the Tambur River, with Hooker as my guide—made the attempt, at any rate, and, failing in that route in Nepal, taken that of the Doukia La and got on to the Arun drainage as soon as possible. I would have gone, preferably alone, with a very small establishment of hillmen, Lepchas or Bhutias—men who know something of the country and of the habits of the people. It is essential also to have a man of position and rank with the party; success depends greatly on him.

I would have taken a very limited store of preserved food, trusting as much as possible to the country for all supplies for my men and myself. Sheep are always procurable; on the Pangkong I lived solely on mutton and the few birds I shot. At that time I had an invaluable man as chuprasie and interpreter; he had come with me from Ladak. Born at Leh, his father was a Kashmiri merchant and his mother a Ladaki. He spoke Hindustani, Punjabi, and Tibetan; he had the assurance and manner of the Indian, with a knowledge of the religion and habits of his mother's race. His religion, Mohammedan, sat lightly upon him, and he was quite at home among Buddhists.

The survey work over a large area is easy, but some of it must be stiff, particularly where the descent off the high plateau commences. The accurate fixing of stations in advance will necessitate going over much ground and take time, for trigonometrical points are few. The base of my work in 1863 would have been in Sikkim, since all surveyed. The present base is the frontier itself, and I fancy a large area of this is known north of Chumbi. It is really only one man's work. To show this, I put on record here how the topography of the Kashmir territory was done, and refer anyone interested to my paper read before the Royal Geographical Society on January 11, 1864, with a map of Baltistan attached. This covers some 4000 square miles plane-tabled in the summers of 1860 and 1861—a most difficult, lofty, and glaciated country, entailing much climbing.

The Duke of the Abruzzi had this map to guide him when he made his expedition to the great Baltoro glacier. This glacier I was fortunate to be the first European to see and follow up to the base of the second highest peak in the Himalayas, and I was then within seventeen miles of the summit.

Having spent the best years of my life on the Himalayas or in sight of them, and collected and written on the fossil and recent fauna, I naturally take a deep interest in the exploration of Tibet which now seems possible. I should be sorry to see any difficulty arise, political or otherwise.

We are living in an extravagant age. Nothing apparently can be done except on a vast scale; more is spent than need be. The size of the expedition may frighten the Tibetans and lead to difficulties, as it did before when another large expedition was to have entered the country.

H. H. GODWIN-AUSTEN.

Nore, Godalming, Surrey, March 16.

Molecular Size and Range of Molecular Attractions in Solutions.

THE dimensions of a molecule of starch, according to the estimate of Lobry de Bruyn, are of the order of 50 Ångström units. Protein molecules containing sulphur in the form of a cystine group, if that sulphur amounts only to 1 per cent., as is commonly the case, must have a molecular weight of not less than 6000; and in the case of hæmoglobin, as is familiar, the percentage of iron points to a molecular weight nearly three times this value. The dimensions of protein

molecules are probably, therefore, of the same order as those of the starch molecule.

The radius of the sphere of molecular attractions is also commonly estimated at 50 Ångström units. This means that in a solution of a substance the molecules of which are of the size attributed to the molecules of starch and many proteins, a molecule of the solute will keep the molecules of the solvent on opposite sides of it at such a distance from each other as to be just out of range of each other's influence. The molecules of the solvent at its surface must tend to behave as if they were in a free surface of the solvent faced by the solute—that is to say, they will be subject to internal pressure the resultant of which will act in a line normal to the surface tending to draw them away from it. Supposing that the molecules are spherical, and that a sphere representing one of them has as its diameter the radius SC (Fig. 1) of the sphere of molecular attraction about a molecule of solvent at its surface at C: if a plane bisecting this sphere of attraction be drawn tangential to the molecule of solute through the line AB, which passes through the molecule of solvent at the point C, then the hemisphere ALB is the space within which other molecules of solvent are all free to exert their attraction upon C, the resultant being a force acting in the direction CL, as would be the case were it in a plane

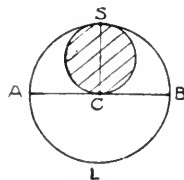

FIG. 1.

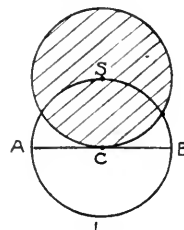

FIG. 2.

surface of the solvent. The other hemisphere ASB is occupied as to one-quarter of its volume by the molecule of solute, and the remaining three-quarters is so disposed that the resultant of the attractions exerted by the molecules of solvent in it which acts in the direction CS is a fraction much smaller than three-quarters of the opposite force acting in the direction CL, and therefore the sum of the two opposing forces is a considerable force in the direction CL, much greater than one-quarter of the internal pressure of a molecule in a plane surface of the solvent; in the case of water, therefore, more than 2500 atmospheres.

If the diameter of the molecule of solute were but half that attributed to the molecule of starch, its volume would be reduced to one-eighth of that in the case presented in Fig. 1, and the fraction of the hemisphere ASB which it would occupy would be one-thirty-second instead of one-quarter. The force acting in the direction CS would be correspondingly increased, and the resultant of this and its opponent would be a force in the direction CL merely somewhat more than one-thirty-second of the internal pressure on a molecule in a plane surface.

In the case of a molecule of the size attributed by Nernst to a molecule of carbon dioxide, little more than one-twentieth of that of a molecule of starch, the fraction of the hemispherical space ASB which it would occupy would be about $1/32000$, and the force tending to remove a molecule of solvent from its surface would be about eight thousand times smaller than that acting on solvent molecules in contact with a molecule of starch, and something of the order of $1/32000$ of the internal pressure in a free plane surface.

If, on the other hand, a suspended particle of dimensions double that of a molecule of starch be considered, the fraction of the hemisphere ASB (Fig. 2) which would be occupied by the suspended particle would be five-eighths, and would include all that part of it where any effective component in the direction CS could be developed, so that the resultant acting on a molecule of the surrounding liquid at C in this case would be considerably more than five-eighths of the full internal pressure at a plane surface.

From such considerations it is clear that in passing from molecules of the dimensions estimated for those that give true solutions to molecules of the size that is compatible only with colloidal solution, if the relation between these dimensions and the radius of the sphere of molecular attraction is such as has been presented, a very great change in the behaviour of a solvent such as water must be observed. Considering only, as has been done in this letter, the relations between the molecules of solvent, the force tending to withdraw these molecules from the surface of molecules of solute will be found to increase eight-thousandfold. The large molecules must be far more unstably dispersed than the small. As soon as they come within a distance of each other which is less than the radius of attraction for the solvent, they will be forced together by the internal pressure of the solvent.

The force tending to remove a molecule of solvent from the surface of a particle 100 Å. in diameter $\frac{5}{8}$ say = 75 per cent. of the internal pressure at a plane surface; a starch molecule 50 Å. in diameter $\frac{1}{4}$ say = 33 per cent.; a molecule 25 Å. in diameter $\frac{1}{32}$ say = 5 per cent.; a CO₂ molecule 2.5 Å. in diameter $\frac{1}{32000}$ say = 0.005 per cent.

In this consideration of the conditions obtaining in solutions no account obviously has been taken of any forces except those in play between the molecules of solvent. The supposition of such forces carries with it the supposition also of similar forces acting between molecules of solute, and especially, too, between them and the molecules of solvent. When there is no attraction between solute and solvent, even the small residuum of unbalanced internal pressure which a particle leaves free to act on the molecules of the dispersing medium when its dimensions are as small as those assigned to the molecule of carbon dioxide must result in its joining up with others of its kind—in fact, in its being insoluble. The difficulty that such considerations taken by themselves leave untouched is the difference between the finite degrees of solubility peculiar to each kind of substance capable of dissolving in a solvent. J. B. LEATHES.

The University, Sheffield.

Oceanographic Research in the British Empire.

IN the interesting leading article in NATURE of March 10, and in the discussion which preceded it, one method of conducting oceanographic research appears to have been practically ignored. We mean its encouragement in permanent institutions and by continued marine surveys in the diverse parts of the British Empire. You have rightly laid stress on the importance of intensive study in particular localities, but we doubt whether research of the kind can be carried out in a satisfactory manner by parties detached for limited periods of time from an expedition of world-wide scope. There is nothing that has struck us more in our own work on the Indian seas and lagoons than the importance of returning again and again to the same place to investigate special problems. For example, in the investigation of the fauna of the Chilka Lake, a small offshoot of the

Bay of Bengal, now being completed by the Zoological Survey of India, the true character of the fauna is being elucidated only by returning year after year and month after month to the same hunting-grounds; and it is not only the fauna to which this applies, for we find that the hydrography also must be studied again and again in years of different climatic conditions and at all seasons. The Chilka Lake is only a minute, almost isolated, fragment of the ocean, but in order to obtain a solid basis for the working out of any oceanographic problem recurrence is necessary, not only because conditions change from time to time—and in many parts of the ocean they change, so far as we know, very little—but also because detailed work on results obtained in the field inevitably opens new vistas, suggests unsuspected sources of error, and reveals paths that ought to be followed out.

We would suggest, therefore, the possibility of giving further encouragement to local oceanographic investigations. Such investigations have hitherto been very largely, though by no means exclusively, of a faunistic nature; for example, Dr. Gilchrist's work on the seas of Africa, that of the Australian Fisheries Department, and last, but not least, that of the R.I.M.S. *Investigator* in Indian seas. There is no reason, however, except the lack of physicists, to use the term in a broad sense, why this should be so, and even zoology, not to mention botany, still offers an unlimited scope for oceanographers. War has interfered with the work of the *Investigator*, but we have every reason to hope that her scientific researches will shortly be resumed under conditions more satisfactory than ever before, and that for at least one month every year the work of the ship will be devoted to purely scientific research. The Madras Fisheries Department already possesses a small marine laboratory in the Gulf of Manaar, and we hope that the Zoological Survey of India will shortly be in a position to open a larger one in the Andaman Islands, the seas round which, perhaps, offer as good opportunities for oceanographic investigations of all kinds as any seas in the world. The interest of the Government of India in work of the kind is proved by the fact that the post of Surgeon-Naturalist to the Marine Survey of India has been in existence since 1875. Shortly before the war the trustees of the Indian Museum, with the approval of the Government, consulted the leading marine biologists throughout the world as to the advisability of granting increased facilities to the Surgeon-Naturalist, and the Government accepted the practically unanimous verdict of the experts by voting additional grants, etc. It has only been the war that has interfered with its generous proposals. We are not acquainted with details as to the encouragement given to oceanographic research in the Dominions, but the instances we have already cited are sufficient to prove that it has not entirely lacked sympathy, even if only from a strictly practical point of view.

Would it not, perhaps, be more feasible to approach the different Governments of the British Empire, which abuts on the seas of all the world, to organise, with the aid of the experts in their employment, separate but co-ordinate research rather than to attempt to set on foot a single colossal expedition the cost of which is admitted at present to be prohibitive, while its course could not be permanent, or, indeed, extend for more than a comparatively few years?

N. ANNANDALE,

Director, Zoological Survey of India.

R. B. SEYMOUR SEWELL,

Surgeon-Naturalist to the Marine Survey of India.

Royal Societies' Club, St. James's Street.

The Sound of Distant Gun fire.

WITH reference to the letter of Father Schaffers in NATURE of March 10, it is certainly a fact that sounds from moderate distances are heard most plainly when there is a wind reversal at a moderate height and when the upper wind comes from the same direction as the sound. At this place the sound of firing off the east end of the Isle of Wight is heard best when a south wind is blowing over a light wind from some other quarter. As regards conditions when the sound of gun-fire from the Front was heard in this country, I do not altogether agree with what Father Schaffers writes. He says that sound-waves are bent upwards "when temperatures are diminishing and the strength of a head wind is increasing with altitude. The former is at its maximum efficiency in summer, when there is a steep gradient over the surface of the earth; the other is nearly always a characteristic of air-flows, since, as a rule, friction against the soil retards the lower strata."

Father Schaffers goes on to say that temperature inversions at moderate heights are rare in summer, and that at all seasons a wind between south-west and north-west—that is, a head wind for sounds coming towards this country from Flanders—generally occupies the whole height of the troposphere. But with anticyclonic weather and with easterly surface winds these conditions are not always realised, and I am under the impression that it was chiefly in such weather that the sounds were best heard. There are certainly many occasions when the temperature gradient is very slight in clear, anticyclonic weather; and in an easterly wind there is often a sharp increase of velocity up to 1 km. or 2 km. before any decrease takes place. Moreover, it often happens in summer, and in other seasons, that no westerly wind is met with at any height up to the top of the troposphere.

There are, therefore, it seems to me, many occasions when a sound-wave might be refracted downwards by an easterly wind and reach the surface a considerable way to the west of the source. Sound-waves that went up at a fairly high angle might get through the strongest part of the easterly wind and never reach the surface, but those which went up at a less angle would be refracted and never get through the easterly wind. I am inclined to think that any cause which occurs to make sounds to be heard at great distances must operate fairly low down in the atmosphere; if the waves went to a great height before being bent down the sounds would seem to come from high up, whereas my experience was that they seemed to come from somewhere near the horizon. If this is the experience of others it should rule out the hydrogen-atmosphere theory; a sound-ray which went up to 100 km., say, and was thence refracted down to the surface at a distance of 200 km. from the source would come down at an angle of 45°, and such sounds would have been attributed by ordinary observers during the war to some aerial fighting.

The question of the propagation of sound-waves in the atmosphere has been very fully dealt with by Mr. S. Fujiwhara (Bulletin of the Central Meteorological Observatory of Japan, vol. ii., Nos. 1 and 4). Mr. Fujiwhara maintains that the abnormal propagation of sounds to great distances, silent regions, and regions of double audibility depend on the wind structure of the atmosphere, and that sound-waves may be reflected in certain conditions of a heterogeneous wind structure. He has taken certain cases of wind structure revealed by pilot-balloon ascents at Ditcham, and

has calculated theoretically the regions of audibility which should be found under the conditions existing at the time; he finds that these agree fairly well with the size and shape of the areas of audibility of explosions of the volcano of Asamayama. He also maintains that the wind structure of the atmosphere at the time of an explosion may be deduced from the areas of audibility.

C. J. P. CAVE.

Ditcham Park, Petersfield, March 21.

Sound Transmitted through Earth.

THE letters from Mr. C. Carus-Wilson and Dr. Charles Davison in NATURE of March 24 prompt me to give the following experience

In June, 1903, I was trekking towards the Victoria Falls. On the night before arrival we "outspanned" some twelve miles to the south, and on retiring to rest on the bare ground I became aware of a curious, rhythmic sound, quite distinct when my ear was pressed against the soil. I told my two brothers, who found they also could hear the pulsation, and one of them suggested that it must be due to the booming of the distant cataract.

To me the most interesting point is not that the sound was transmitted by the earth, but that it was transformed into rhythmic vibration—very different from the constant roar one hears when close to the Falls. Some process of interference would seem to occur and give rise to this result.

REGINALD G. DURRANT.

Rosetree, Marlborough, March 26.

X-rays and their Physiological Effects.

THE death of my brother, Dr. Ironside Bruce, from a hitherto unsuspected danger in the use of X-rays by medical men for purposes of treatment and diagnosis has an aspect other than its personal or medical one. I only write to NATURE because I feel impelled to address an appeal to workers on the purely physical research problems connected with X-rays. I suggest that there is a need for closer association between the latter and medical men practising radiology. The advance in medical knowledge which the X-ray has rendered possible has been immense, and it is becoming practically indispensable in the diagnosis of disease. But it is now clear that its use by practitioners may be curtailed unless some more effective measures of protection for radiologists can be devised.

On many occasions my late brother expressed to me his difficulty in obtaining precise physical knowledge bearing on the nature of the rays and their effects on human tissues. Not many days before his death he returned to this subject, and said that if he recovered he would devote his life to research on protective measures. If a layman might venture an opinion, it would be that medical men generally cannot be expected to conduct research on the methods of production of the rays, or on the exact nature of the various kinds of rays produced by different forms of apparatus. On the other hand, physicists are not ordinarily competent to investigate the purely biological effects of the rays. Hitherto medical men have been lulled into security by the belief that the only injury to be feared was dermatitis, which they believe is caused by rays of low "penetration," and are probably stopped even by ordinary clothing materials. Again, they believe that protective screens of lead glass afford full pro-

tection. We may now doubt whether they do, at any rate in some circumstances.

In the interests, therefore, not only of radiologists, but also of suffering humanity which any curtailment of the facilities for X-ray treatment will affect, I appeal for an organised effort on the part of physicists and biologists in *collaboration* to institute research into the effect of X-rays on living tissues. I have sufficient confidence in science to feel that, as a result, methods will be devised which, while preserving the usefulness of the rays for medical purposes, will guard the devoted band of practitioners against the tragic risk which now stands revealed. I feel that in making this appeal I am discharging a duty imposed upon me by my brother.

March 25.

Since the above was written I have learned that some months ago steps were taken by the Medical Research Council to organise research on the action of radio-active rays on living tissues. With this work prominent physicists will be associated. I am confident that this collaboration will be productive of good results, and I am glad to know that the appeal I ventured to make had already been answered.

A. B. BRUCE.

March 29.

Greenland in Europe.

DURING the present month a new light has been thrown upon the Aberdeen kayak (skin-canoe) referred to in *NATURE* of January 13, p. 648. Fresh information upon this subject is found in a diary of a tour through Scotland in 1760 by the Rev. Francis Gastrell (born 1707; M.A. Oxon. 1728), son of a Bishop of Chester, and owner—by purchase in 1753—of New Place, Stratford-on-Avon. His diary is now preserved in the Shakespeare Museum at Stratford. In a paper read on March 10 before the Edinburgh Bibliographical Society Mr. James Sinton quoted Gastrell's statement that when visiting King's College Chapel, Old Aberdeen, on October 12, 1760, he there saw "a Canoo about seven yards long by two feet wide wh[ic]h about thirty-two years since was driven into the Don with a man in it who was all over hairy & spoke a language wh[ic]h no person there could interpret; he lived but three days, tho all possible care was taken to recover him." This canoe is now in the anthropological museum at Marischal College, Aberdeen. Its exact length is 17 ft. 9 in., its greatest breadth being scarcely 18 in. and its weight 34 lb. Francis Douglas, who saw it in or about the year 1782, describes it as "a canoe taken at sea, with an Indian man in it, about the beginning of this century. He was brought alive to Aberdeen, but died soon after his arrival, and could give no account of himself."

These two statements do not coincide, but there can be little doubt that they relate to the same individual. The hairiness of which Gastrell speaks suggests a non-Mongolian type, but it might only mean an imperfect recollection of the fur hood, shirt, and breeches worn by kayak-men. A similar canoe, captured in Orkney waters, and preserved in Edinburgh in 1696, had with it "the shirt of the barbarous man that was in the boat." Dr. James Wallace (F.R.S. Lond.), writing in 1700, says that "there is another of their boats in the Church of Burra in Orkney." In the same year the Rev. John Brand states that such canoes and canoe-men were then frequently seen upon the coasts of Orkney, "as one about a year ago on Stronsay, and another within these few months on Westray—a gentleman with many others in the Isle

looking on him nigh to the shore,—but when any endeavour to apprehend them they flee away most swiftly."

DAVID MACRITCHIE.

4 Archibald Place, Edinburgh, March 21.

The Peltier Effect and Low-temperature Research.

WITH further reference to the suggestions of Mr. Campbell Swinton and Sir Oliver Lodge contained in *NATURE* of March 10 and 17 that the Peltier effect may disappear at a very low temperature, this appears very improbable from the fact that, as long ago pointed out by myself, there is a continuous transition between metals and non-metals, and this distinction between them does not vanish at low temperatures. Consequently, pairs of elements must always exist with electrothermic differences. The nearly "perfect" metal may become a "perfect" conductor of heat and electricity, and the nearly "perfect" non-metal may become a "perfect" non-conductor at low enough temperatures, but the intermediately graded elements would become neither perfect conductors nor absolute non-conductors, but would behave much like certain elements at ordinary temperatures. The periodic law would enable physicists to predict almost with certainty which elements would exhibit the desired effect best at low temperatures.

It may repay physicists who intend to study these effects to look up papers written by me many years ago, e.g. "Some Remarks on the Connection between Metals and Non-Metals," etc., which occur in the *Chemical News* during the years 1903, 1904, and 1905. Also my book "Researches on the Affinities of the Elements and on the Causes of the Chemical Similarity of Elements and Compounds" (1905). I have been hoping for the opportunity of revising the latter and bringing it up to date, but unfortunately have always been overwhelmed with technical work.

GEOFFREY MARTIN.

109 Corporation Street, Manchester,

March 22.

Relativity and the Velocity of Light.

THE great interest of Mr. Jeans's letter on this subject in *NATURE* of March 10 is, I think, sufficient justification for my letter by which it was evoked.

The argument used by Mr. Jeans to support the proposition that it can be shown that both on the outward and on the inward journey light travels with the same constant velocity is, to me, difficult to follow. Majorana's experiments deal respectively with a source and a reflecting mirror moving relatively to the observer, whereas in the Michelson-Morley experiment both are at rest with the observer. I cannot then see the bearing of Majorana's results upon the question whether β and α remain unchanged in the case given by Mr. Jeans.

I am sorry I misunderstood the words used by Mr. Jeans in his article in *NATURE* of February 17 to imply a belief in the possibility of measuring the velocity of light in a unidirectional course. It appears to me, however, that the truth of this proposition is involved in the affirmation of the proposition referred to in the paragraph above; for the mean velocity of light on its outward and return journeys after reflection from a mirror can be measured. If also its constancy outwardly and inwardly can be affirmed, does it not follow that the velocity on a unidirectional course becomes known, contrary to the principle of relativity?

C. O. BARTRUM.

32 Willoughby Road, Hampstead, March 15.

Stellar Magnitudes and their Determination.

By H. SPENCER JONES, Chief Assistant, The Royal Observatory, Greenwich.

I.—APPARENT MAGNITUDES: (a) VISUAL.

THE magnitude of a star, as determined by direct astronomical observation, is a measure of its *apparent* brightness on a scale which has been precisely defined only within recent years. Hipparchus was, so far as is known, the first to assign magnitudes to the stars, and his results have been preserved for us by Ptolemy in the *Almagest*. The classification of Hipparchus was a crude one, the stars being divided into six classes, all the brightest stars being assigned to the 1st magnitude, and all those only just visible to the naked eye to the 6th. Ptolemy extended the classification by recognising the gradation in brightness between the stars in a given class, this gradation being indicated by the words *μείζων* and *ελάσσων*, used to denote that a star was brighter or fainter than the average star of its class. Ptolemy's estimations were adopted almost universally until the time of Sir William Herschel, who developed a plan for representing various degrees of difference in brightness between stars by the use of arbitrary symbols, and made observations of the magnitudes of nearly three thousand stars. It was not until Argelander carried out the great project of the "Bonn Durchmusterung" (1852 onwards) that magnitudes were first estimated to tenths, and even in this great work the scale adopted, though made to correspond fairly closely with the then existing scales, was an arbitrary, and not a uniform, one.

Sir John Herschel was the first to attempt to formulate a numerical relationship between the apparent brightnesses of stars of successive magnitudes, and he concluded that the best representation was afforded by a relationship according to which a decrease in light in geometrical progression corresponds to an increase in magnitude in arithmetical progression. He also estimated that the actual ratio of the light of a star of the 1st magnitude to one of the 6th is at least 100:1. Herschel's conclusion is in accordance with a psycho-physical law, enunciated by Fechner, that, as a stimulus increases in geometrical progression, the sensation produced by it increases in arithmetical progression, the law being departed from, however, in the case of very intense or very weak stimuli. According to this law, if I_m denotes the apparent brightness of a star of magnitude m , then $I_m : I_{m+\Delta m} = k^{\Delta m}$, where k is a constant, which is called the "light ratio."

Using this relationship, the value of k (or $\log k$) corresponding to various early series of magnitude determinations, after standardisation by various photometric devices, can be found. These show a somewhat wide variation around a mean of about 0.40 for $\log k$. Thus a few values are:—

Herschel	...	0.407	Argelander	...	0.431
Struve	...	0.383	Groombridge	...	0.388

NO. 2683, VOL. 107]

The values are not, in general, constant within any given series. Thus for the "Bonn Durchmusterung" of Argelander we have:—

For magnitudes	3 to 5	...	0.29	
"	"	5 to 6	...	0.30
"	"	6 to 7	...	0.39
"	"	7 to 8	...	0.39
"	"	8 to 9	...	0.44

It was, therefore, suggested by Pogson that the value 0.40 for $\log k$ should be definitely adopted as a basis for accurate photometric determinations of magnitude. This value is in sufficiently close agreement with the values derived from the older series of determinations to ensure that the magnitudes derived on this basis will not deviate greatly from the older estimates. Owing to the convenience of this figure, all modern photometry has been based on this convention, which assigns a value to k of 2.512... The convenience of the figure is due to the facility with which it enables estimates of brightness to be transformed into magnitude differences ($\Delta m = 2.5 \log I_m / I_{m+\Delta m}$). In the case of two stars one of which is 100 times as bright as the other, we then have $\Delta m = 5$ magnitudes, exactly in accordance with Sir John Herschel's estimate.

Having adopted this convention, it becomes necessary, before a magnitude can be assigned to any star, to fix the zero from which the magnitudes are to be estimated, it being agreed that the scale shall be continued in both directions, stars brighter than a star of the 1st magnitude being assigned zero or negative magnitudes. The use of the term "negative magnitude" may be misleading to those who are not astronomers, but the conception is a useful one if the scale of magnitude is to be considered—as theoretically it must be considered—capable of infinite extension at each end. It has the further advantage of not causing a break with the old-established convention that the brighter the star the smaller (algebraically) is the quantity denoting its magnitude. It is convenient so to choose the zero that the modern precise photometric magnitudes shall agree as closely as possible with the older values, which we have seen also corresponded closely with a value of 0.4 for the logarithm of the light ratio. In actual practice the zero has been fixed somewhat indirectly; in the extensive visual photometric work carried out at the Harvard Observatory all the stars were compared with the Polestar, for which a provisional magnitude was assumed. Thus differences of magnitude only were determined. All the magnitudes were finally increased by a quantity so chosen that the mean of the magnitudes deduced for 100 circumpolar stars between the 2nd and 6th magnitudes agreed with the corresponding mean of the values assigned in the "Bonn Durchmusterung." In the

photometric *Durchmusterung* of Müller and Kempf at Potsdam the zero was chosen so that the mean magnitude of 144 selected fundamental stars north of the equator, between magnitudes 4 and 7, should agree with the corresponding value in the "Bonn *Durchmusterung*." The systems of magnitudes derived in these two investigations are not in absolute accordance, as will be seen later.

For the accurate determination of visual magnitudes, some form of photometer is necessary. The two types which have provided the best results are the Zöllner photometer and the meridian photometer of Pickering. The former is illustrated in Fig. 1, the principle of the instrument consisting in the formation of two images in the focal plane of the telescope, one being the image of the star under observation, and the other that of an artificial star the brightness of which can be varied and brought into equality with that of the real

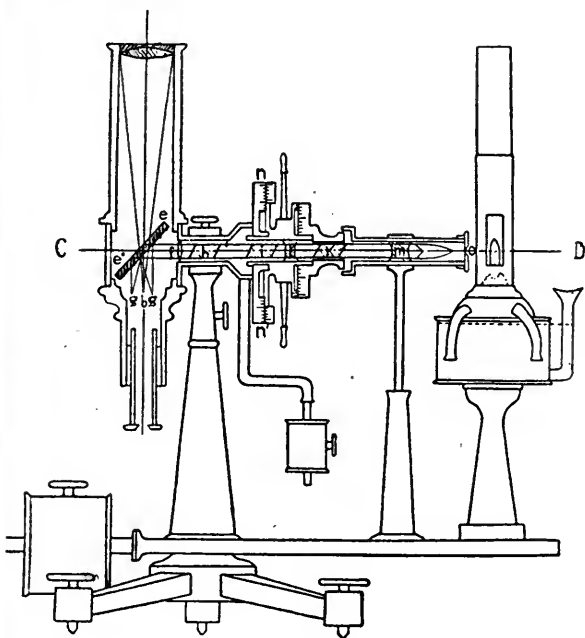

FIG. 1.—The Zöllner Photometer.

star. The light from a standard lamp, giving a constant illumination, passes through a pin-hole in a diaphragm *o*, holes of different sizes being used to simulate stars of different magnitudes. The divergence of the rays passing through the pin-hole is increased by a concave lens, *m*, and it then passes successively through a polarising Nicol, *k*, a thin quartz plate, *l*, cut perpendicularly to its optical axis, a second Nicol, *i*, and a third Nicol, *h*. The Nicol *i* and the quartz plate *l* are fixed relatively to one another, but the Nicol *k* can be rotated, so varying the colour of the light falling on the third Nicol. When the colour agrees as nearly as possible with that of the star under observation, *k* is clamped into position. The Nicol *h* acts as an analyser, and the system *k*, *l*, *i* is turned as a whole relatively to it in order to vary the brightness of the artificial star and bring it

into equality with that of the real star. The light then passes through a lens, *f*, which focusses it in the focal plane of the telescope, after reflection by the plane glass mirror *ee'*, which forms two images of the artificial star of nearly equal brightness by light reflected from its front and back surfaces respectively, the former being somewhat the brighter of the two. There are four positions of the rotating system in which equality can be obtained between the brighter of these images and that of the star under observation, and the reading corresponding to each is observed. Some observers prefer to make the observation by adjusting the brightness of the images of the artificial star so that the real star image is intermediate in brightness between the two images of the artificial star. As differences in brightness only are measured, it is immaterial which procedure is adopted provided it is adhered to throughout. A standard star is then observed in a similar way. If I_1 , I_2 are the angles through which the polarising system is turned in the two cases, from the position corresponding to crossed Nicols, then the ratio in brightness of the two stars is $\sin^2 I_1 : \sin^2 I_2$, and therefore their difference in magnitude is $5 \log (\sin I_1 / \sin I_2)$. All the Potsdam observations were made with two photometers of this type, though differing in some details from that illustrated here; 144 fundamental stars were chosen, which were combined into 432 pairs, and intercompared in order accurately to determine their magnitudes. Every zone star was then compared with an adjacent fundamental star.

The Zöllner photometer is convenient and accurate in use. The colour compensation reduces the subjective errors of personality which are liable to occur when two images of different colours are compared. The colour match can be made much more accurately, however, for yellow and red stars than for white or yellowish-white stars. The principal objection raised against it is the employment of an artificial star—not on the ground of possible variations in its magnitude, for there are types of standard lamps which give very constant illumination, but owing to the fact that the image of the artificial star may not be exactly similar to that of a real star under all conditions of seeing. It is stated by Müller that the tendency is to make bright stars too bright and faint stars too faint, but, provided that the diaphragm or the aperture of the telescope is so chosen that the magnitude of the artificial star does not differ greatly from that of the star under observation, the errors possible on this account are very small. One of the Potsdam photometers was provided with three object glasses which were used in conjunction with three diaphragms. It was found best to use an aperture of 30–40 mm. for stars of magnitudes 2 to 4, of 60–70 mm. for stars of magnitudes 4 to 6, and of 130–140 mm. for stars of magnitudes 6 to 8.

The meridian photometer, devised by Pickering and used at the Harvard Observatory for the very extensive photometric work carried on there under

his direction, is illustrated in Fig. 2. It consists of a horizontal telescope pointing to the west and provided with two similar objectives, A and B, in front of which are placed right-angled prisms, C and D, which reflect the light from two stars into the telescope. The prism D is used only for observing the Pole-star, and can be turned about two perpendicular axes by rods E and F.

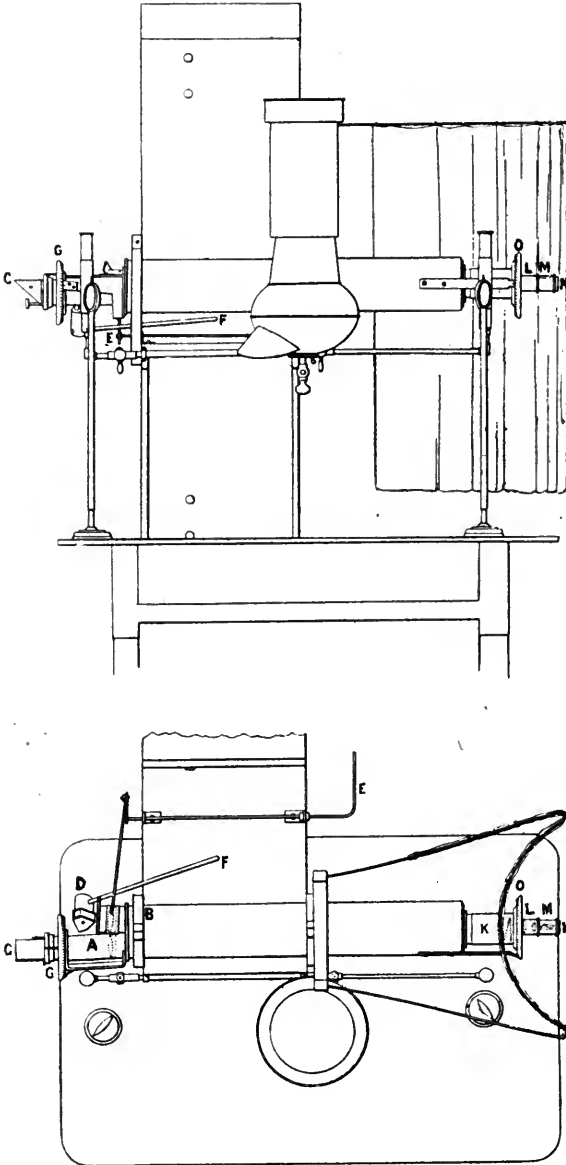

FIG. 2.—The Meridian Photometer.

The prism C can be turned around the axis of the telescope, and its position read by a circle, G, so that a star of any given declination can be observed on the meridian; there is also a slight adjustment for enabling it to be viewed for about one-quarter of an hour before or after meridian passage. A double-image prism, K, made of Iceland spar compensated by glass, is placed near

the focus of the objectives, and divides each pencil of light into two; the angles of the spar and glass prism are so adjusted that the two central pencils (one ordinary and one extraordinary pencil) are made to coincide and to pass nearly through the centre of the eyepiece L. In this way errors which might result from having two emergent pupils or from the pencils passing through different parts of the eyepiece are avoided. In front of the eyepiece is placed a Nicol, M, and an eye-stop, N, cuts off the two outside pencils. A graduated circle, O, is attached to the eyepiece and Nicol, and the four positions of the Nicol are observed in which the two images are equal in brightness. Since the beams from the two stars are polarised at right angles, if I is the angle counted from the position where the image of Polaris disappears, then the ratio of the brightness of the star under comparison to that of Polaris is $\tan^2 I$. In taking the observations, readings are obtained with the image of Polaris first on one side and then on the other side of the star. This photometer is accurate in use, and has the advantage over the Zöllner type that similar images are compared. It has several disadvantages; the two stars are compared through different object glasses which cannot in general be interchanged. Stars of low declination are compared with a star at a very different altitude, so that appreciable errors may occur on account of the variations to which the transparency of the atmosphere is liable; with the Zöllner photometer, on the other hand, a star can always be compared with another of about the same altitude. The optical combination also does not permit of very good images, and there is no provision for matching the colours of the two images. It is also limited in its application to stars near the meridian. At the time the Harvard observations were made the variation in brightness of Polaris had not been discovered. After its discovery, the variation was detected in the residuals, although its total range is quite small.

In another type of photometer which has been greatly used, a neutral wedge of uniformly graduated absorption is employed, and the reading is taken of the position of the wedge when the star under observation just becomes invisible. Owing to the strain on the observer's eyes caused by these observations, which are liable to give rise to personal errors of variable amount, and to the impossibility of obtaining an absolutely neutral-tinted wedge, this type of photometer does not give results of the same order of accuracy as the two described above.

Although the theory of the determination of visual magnitudes is very simple, there are many possible causes of error, mainly of a physiological nature, arising from the necessary use of the human eye. Most of these are more important when very faint stars or stars differing much in colour or brightness are observed, though in the Zöllner photometer difference in colour can be compensated to a certain extent. Errors arising from the observation of stars near the threshold

of visibility should be avoided by reserving them for an instrument of larger aperture. A few causes of error may be referred to briefly: (i) The Purkinje phenomenon is well known; if two lights of different colours—say, a red and a green—appear equally bright to the eye, then, if the intensity of each is increased in the same ratio, the red will appear the brighter; if reduced in the same ratio, the green will appear the brighter. Thus the relative magnitudes of two stars of different colours depend upon the aperture and power with which they are observed. (ii) Connected with this phenomenon is the difficulty of comparing the brightness of two stars when their colour is different with any type of photometer which does not compensate for colour difference. Some observers will estimate a red star as relatively much brighter than will other observers—errors of half a magnitude on this account are not at all uncommon. The use of a red screen has been suggested, but this and similar devices introduce the Purkinje phenomenon. The most satisfactory solution is to use the smallest aperture which gives no perceptible colour. (iii) Errors are possibly due to the two stars being observed on different parts of the retina; two stars which appear equally bright when side by side will not in general appear so when one is above the other. It is advisable always to view the two stars side by side and then to interchange their positions. (iv) There are various errors possible owing to varying accommodation of the eye, particularly when the colours of the two stars differ. The observer should therefore be screened by a dark curtain, and all readings and settings performed by a second observer outside the curtain.

By the study of these and similar types of errors and the best means of avoiding them, the influence of the human element has been reduced as far as possible. With these precautions, the magnitudes having been finally determined with the photometer, it is necessary to apply a correction for atmospheric absorption, which increases with increase of zenith distance. Careful investigation has been made, both at Harvard and at Potsdam, of the amount of this correction at various altitudes, and the effects of differential atmospheric absorption have been allowed for with relatively small uncertainty. But even after all precautions have been taken it is found that there remain systematic differences between different series of observations, and that these occur not only in the case of series made by different observers and with different instruments, but even between different series made by the same observer with the same instrument. In general, the errors are not large, but they cannot be neglected in comparison with the accidental error deduced from the inner agreement between the observations in any one series. The comparison of the brightness of two images in a photometer is a subjective one, and it seems impossible altogether to eliminate errors. In the observations at Potsdam every star was observed an equal number of times by the two observers in order to make the whole series inter-

consistent; but another observer observing with the same photometer would probably obtain results differing systematically according to colour. Different results are also obtained from different instruments. Thus Müller and Kempf find, from a comparison of the "Revised Harvard Photometry" with the "Harvard Photometry," in which the observations were made with different photometers, the following relative differences between white and yellow stars in the two series:—

Magnitude	Mean differences (R. H. P.—H. P.) for white stars <i>minus</i> differences for yellow stars	
	<i>m.</i>	<i>m.</i>
Brighter than	2.0	-0.23
	2.0-3.0	-0.17
	3.0-4.0	-0.10
	4.0-5.0	-0.10
	5.0-6.0	-0.01
	6.0-7.0	+0.05
Fainter than	7.0	+0.21

The Potsdam observations made with the different photometers were intercompared, and corrections derived by which all the observations were reduced to a mean system. The differences, in part, were probably due to differences in the absorptions in the several object glasses used.

The comparison between the final Potsdam results and the Harvard results reveals differences which appear surprisingly large in view of the care devoted to the observations themselves. The differences are mainly dependent upon the colours of the stars; to a much less extent they vary with their brightness. The following mean differences in the sense Potsdam *minus* Harvard are found for the Potsdam colour-classes W (white), GW (yellowish-white), WG (whitish-yellow), G (yellow):—

W, +0.25*m*; GW, +0.22*m*; WG, +0.10*m*; G, 0.00*m*.

The differences show continuous variation with brightness for the range 2*m* to 8*m* as follows:—

W, +0.23*m* to +0.37*m*; GW, +0.20*m* to +0.30*m*;
WG, +0.12*m* to +0.07*m*; G, +0.07*m* to -0.08*m*.

When it is recalled that a difference in magnitude of 0.1*m* corresponds to an error in apparent brightness of nearly 10 per cent., the magnitude of these errors can better be realised. It is also apparent that there is much scope for improvement in the accuracy of magnitude determinations.

The Potsdam visual *Durchmusterung*, comprising all stars in the "Bonn *Durchmusterung*" down to a limit of 7.5*m* on the "Bonn *Durchmusterung*" scale, is probably the most accurate series so far as inner consistency is concerned, the same two observers having observed every star, and instrumental differences having been so far as possible eliminated. If any series of visual photometric observations can be regarded as fundamental, it is this series; but any other fundamental series may be expected to show slight systematic discordances. There is a parallel in the case of meridian observations, in which there

are several fundamental systems, and it is customary to reduce any series of observations to one or other of these fundamental systems. If further series of observations are reduced to the Potsdam system, any future revision of this system can easily be extended to all the observa-

tions based upon it. At present no series has been generally accepted as a standard, and if two determinations of magnitude of a star agree within one-tenth of a magnitude, astronomers now feel very satisfied.

(To be continued.)

The Development and Spread of Civilisation.

By W. J. PERRY, The University, Manchester.

RECENT research suggests that the various forms of human culture are the result of a process of organic growth. Continuity is apparently the key-note of the study of the history of civilisation. But, because it is not possible in each case to supply the missing links, it is incumbent on those who believe in continuity to construct a mechanism of the development and spread of civilisation in all ages and places. The following generalisations suggest how this process has been effected.

It would seem that civilisation—that is to say, the possession of the fundamental arts and crafts necessary for settled corporate life—first appeared in the Near East. There, at some time before 3700 B.C., had apparently been discovered the crafts of agriculture, irrigation, stock-breeding, carpentry, metal-working, stone-working, pottery-making, weaving, and so on. All the rest of the world, so far as can be seen, was at that time peopled only by hunting tribes very low in the scale of culture. These were not long left in possession of their hunting-grounds, for civilisations began to appear in outlying parts of the earth, such as Turkestan, Siberia, China, India, the valley of the Wei in China, the valleys of the Usumacinta and Motagua in Guatemala, Lake Titicaca in Peru, etc. The cultural level of these early centres never exceeded, and rarely approached, that of the Near East. Around these centres appeared later other civilisations, usually progressively lower in cultural level as they became more remote from the centre in space and time. For example, the earliest known civilised settlement of North America was that of the first Maya cities of Guatemala. All the later Maya cities, and the tribes that afterwards occupied the same region, display a definite inferiority of technique in the arts and crafts as compared with these earliest settlements. Northward from Mexico there is a steady drop in the level of culture. Similarly with South America. It is claimed that negro Africa derived practically all its culture, directly or indirectly, from Egypt. As one goes south from Egypt there is, speaking generally, a steady decline in cultural level, the most southerly people of all, the Hottentots and Bushmen, being the lowest. The study of the beginnings of European civilisation reveals a similar condition of affairs. The earliest centre was in the eastern Mediterranean. In no other

region of the continent did ancient civilisation attain to so high a level, and the various stages of development of culture appeared later in time in the outlying parts than in those nearer to this region.

It is natural to seek to interpret these and similar facts. In only one region in the world—the Near East—can progressive development of culture be established in ancient times. In that region civilisation probably first appeared, and there it reached the highest level of antiquity. Everywhere in the world outside the area directly and continuously influenced by this region, the story from the beginning is one of uninterrupted degeneration in arts and crafts. In many instances it is possible in these outlying regions to establish direct filiation of culture, and it is invariably found that the process is accompanied by degeneration in the arts and crafts. Since in any one region, such as America, it is found that, wherever direct cultural sequence can be established, the earlier is the more advanced, and that the earliest known culture is the most advanced of all in the technique of the arts and crafts, it is difficult to account for the facts otherwise than by postulating that the earliest civilisation in such a region was derived from one that preceded it in some other part of the world. Carried to its conclusion, this amounts to claiming that everywhere outside the Near East, even in cases where it cannot be established by direct proof, culture exists by reason of direct filiation—in short, it amounts to postulating continuity in culture. In that way it would be claimed that the civilisations surrounding the original culture centres were derived from them, and that the culture centres themselves were derived from those that preceded them on the earth. The chronological argument would thus lead us to derive all the outlying culture centres from the Near East, and the whole process of cultural development would be one of growth outward from the Near East. This solution would satisfy both the spatial and chronological conditions of the problem.

The indication of a motive will tend to facilitate belief in such a world-wide movement of culture in antiquity. The ancient civilisations in different parts of the earth are fundamentally similar—they are all founded on irrigation—and in their economic, social, political, and religious organisa-

tion they resemble the civilisations of the Near East. Further, in those early days there was a widespread belief in the efficacy of gold and other substances as "givers of life," and there are historical instances of expeditions setting out to seek for the earthly paradise, where such substances could be found—in America there are traditions of the arrival of highly civilised strangers on such an errand. The early sites of civilisation in the outlying parts of the world are near sources of gold, pearls, and other substances formerly credited with life-giving powers. So there is reason for concluding that there was a great movement of culture, the chief motive for which was the search for the elixir of life.

The ancients have left their traces on most of the goldfields and other similar sources of wealth of the earth, and they were apparently searching for others; but this search was abruptly abandoned. Regions that must have hummed with activity in days long past have, during many centuries, been peopled by tribes indifferent to the wealth at their disposal, so that goldfields worked thousands of years ago have only recently been reopened.

It is necessary to account for the fact that the early civilisation of the world carried within itself the germs of its decay and even destruction.

In the Near East appeared the first ruling class known to us. The kings there were from the first intimately associated with the maintenance of the irrigation systems on which such early communities chiefly depended for their food supply. In the earliest civilisations in the outlying parts of the earth there were ruling families so closely allied in their peculiar culture to those of the Near East that there is reason to believe that they were derived thence, directly or indirectly.

The process is known by which the new communities were formed around the old centres of civilisation. Members of the ruling class went out from their homes and imposed themselves elsewhere as a new ruling class, and this process has gone on until the earth has become covered with a network of States formed of a ruling class dominating people differing from them in culture and often in race. From the beginning, ruling classes have possessed beliefs and practices peculiar to themselves; they universally use heraldic emblems, the lion and the eagle playing a prominent part in connection with the kingship; a claim is often made to descent from an ancestor borne to a god by an earthly mother; in the early States we find the belief in a land of the dead in the sky invariably associated with the ruling class; the kings of the earlier States were supposed to be responsible for the welfare of the community; and there is a widespread association between royalty, the building of pyramids, and the preservation of the dead—all of which goes to support the theory that the ruling class of any country is derived from that of some other country, so that all the ruling classes of the world have

originated ultimately by a continuous developing process from one group in the Near East, the place where they can first be detected.

The earliest peoples on the earth used no weapons that we have traces of, and the study of the remains of the Upper Palæolithic and Neolithic ages shows that these peoples were mainly, if not entirely, peaceful. The hunting tribes that live on the earth are all peaceful, and their standard of behaviour and morality is higher than that of civilised communities. War is the accompaniment of ruling classes. In their beginnings in all parts of the earth they did not indulge much in war, except to obtain slaves and victims for sacrifice, but the ruling classes of the daughter States struggled with each other for the possession of power and wealth; and often a military genius arose among them who welded many communities by conquest into an empire that usually fell to pieces on his death or defeat at the hands of some rival. In this way much of the old civilisation of the earth was destroyed, and the arrival of barbarians with ruling classes derived from more advanced peoples can, in a large number of cases, be shown to account for the sudden cessation of the onward march of civilisation into the outlying parts of the earth.

The earliest ruling families claimed to possess the whole realm, and were enabled to divert much of the energies of their subjects to such purposes as the building of temples and palaces, and to the accumulation of the means of upkeep of such establishments. As a result of the combination of the domination of ruling families and their subsequent incessant struggles for power, there has ensued in all parts of the earth the decay and death of civilisations. The domination at home has apparently caused the arts and crafts to decay and become stereotyped, and the warfare engendered by these ruling classes has completed the work of destruction.

It remains to account for the fact that the daughter States were so much more warlike than those that gave rise to them. The explanation suggested by the facts is that the rulers of the original States were chiefly occupied with duties connected with the welfare of the community—for this was the real source of their prestige—and were obliged incessantly to perform ceremonies for that end. They were hide-bound in etiquette, and apparently had but little personal initiative; but the young men who went out to found kingdoms threw over the restraints of their homes, and, with their followers, abandoned themselves to military pursuits, with results that are reflected in the social, economic, and religious life of the communities formed by them. One important consequence of this process was the formation in places of pastoral communities derived from those practising irrigation. These men, with checks and restraints removed, established the most warlike States that the world has known, and these States have ever been distinguished by cruelty beyond any that the world has known. It would seem

that the psychological explanation of this phenomenon lies in the possession by these ruling classes of practically unrestrained power, which has caused them to adopt methods of cruelty.

This system of military domination, being inherently unstable, ultimately began to break down,

and the peoples of Western Europe, released to some extent from the restraints imposed on mankind for so long by their ruling classes, were enabled to begin once more that progressive conquest of Nature which has so often and so rudely been interrupted in the past.

Obituary.

WE record with much regret the death of DR. W. IRONSIDE BRUCE on March 21 at the early age of forty-four. Dr. Bruce was educated at the University of Aberdeen, obtaining the degrees of M.B. and Ch.B. in 1900, and then served as civil surgeon in the South African Field Force. Here he took much interest in the application of X-rays for the diagnosis of war injuries, and afterwards became assistant to the late Sir J. Mackenzie Davidson at Charing Cross Hospital, and on the death of the latter succeeded as medical officer in charge of the X-ray department. Dr. Bruce was intensely interested in the scientific developments of his subject, of which he acquired a very complete knowledge. He published "A System of Radiography with Atlas of the Normal," and in process of time became president of the section of radiology, Royal Society of Medicine, and took a considerable share in the establishment of the diploma in radiology, now given by the University of Cambridge. Some months ago the condition of his health gave rise to anxiety, and it was later found that he was suffering from a severe type of aplastic anæmia, from which he died. Evidence has accumulated that this condition may be caused by the more penetrating radiations both from X-ray tubes and from radium, and there is little doubt that he succumbed as a result of his continuous work in radiology—another X-ray worker who may be described as a martyr to his science.

Lord Lonsdale has received the following letter from Buckingham Palace: "The King has learnt with much regret of the tragic death of Dr. Ironside Bruce, radiologist to the Charing Cross Hospital, and I am commanded to convey to you and the hospital staff his Majesty's sincere sympathy

in the loss of so brilliant a physician, who sacrificed his life in the cause of science and humanity."

SCIENCE and industry alike have suffered a loss by the recent death, at Southall, of MR. S. H. BLICHFELDT, a director of the Maypole Margarine Co. Mr. Blichfeldt was only forty-four years of age. He was of Danish birth, and took up a position as chemist at the Maypole works at Southall in 1906 after having worked for some years at Jørgensen's laboratory in Copenhagen. He was a strong advocate of the application of science to industry, and throughout his work demonstrated the importance of scientific methods in the factory, and the manufacture of margarine in the Maypole Co.'s works was gradually placed upon a really scientific basis as the result of his labours. Mr. Blichfeldt's abilities as a chemist and bacteriologist were widely known to the scientific world, and it is pleasing to note that the Maypole Co. recognised the value of research in industry, and appointed him a director of the company in 1916.

Science for March 11 announces the death on February 2 of PROF. T. MIYAKE, of the Agricultural College of the Imperial University of Tokyo, who was the author of an important work on the entomology of Japan; and on February 24 of DR. F. J. V. SKIFF, director of the Field Museum, at the age of sixty-nine years.

THE death is announced, at eighty-three years of age, of MR. JOHN BURROUGHS, the inspiring American writer on natural history subjects.

Notes.

LECTURING before the Royal Society of Medicine on March 22, Lt.-Col. Nathan Raw gave an account of his work and views on immunity in human tuberculosis. Col. Raw agrees with other investigators that man is attacked by two fundamentally different tuberculous viruses, the human and the bovine. The former is conveyed from person to person by direct infection and mainly attacks the lungs; the other is conveyed by milk from tuberculous cows and develops in the first few years of life. These two types of tubercle bacilli will not live in the body at the same time, and, further, an attack by one virus produces an immunity to the other. The bacilli may be attenuated by cultivating for years outside the body, so that they no longer convey the disease on inoculation into susceptible animals. Vaccines can be pre-

pared from these attenuated cultures, and may be employed for the treatment of tuberculosis in man. Cases of infection with the human bacillus treated with the vaccine of the bovine virus have shown considerable improvement. Animals may be completely immunised against tuberculosis by the use of these attenuated cultures, and Col. Raw expressed the opinion that if all children with a tuberculous family history were vaccinated with the attenuated cultures, an entirely safe procedure, they would be in a much better position to resist infection in after years.

No section of scientific medicine has developed more rapidly in technique than those dealing with vaccines, sera, toxins, antitoxins, and related substances. The real science of these "biologic products" is scarcely a generation old. The use of

them in medical practice has spread in recent years with an epidemic acceleration. Vaccines are not yet quite so commonly used as, say, digitalis or strychnine, but they are among the approved medicaments of the "general practitioner." The same is more or less true of salvarsan and its substitutes. The great drug firms have risen to the demand, and the whole medical position is now such that the public service has found it necessary to consider how the best and safest products shall be secured to the consumer. It is these facts that led to the appointment of the Committee "on control of certain therapeutic substances," with Sir Mackenzie Chalmers, K.C.B., as chairman. The terms of reference covered "the legislative and administrative measures to be taken for the effective control of the quality and authenticity of such therapeutic substances offered for sale to the public as cannot be tested adequately by direct chemical means." This carefully exclusive remit left the Committee to deal with three groups of substances: (1) the biologic products already mentioned; (2) potent synthetic remedies like salvarsan; and (3) preparations like digitalis, strophanthus, pituitary gland, etc. The report (Cmd. 1156, 2d.) deals with all three classes. It makes special recommendations for inspection of the processes of manufacture and testing of the products. The main problem is standardisation. This is supremely difficult for delicately varying biological substances like vaccines or toxins. Recommendations, however, make full provision for the activities of private enterprise. There is an outline of a draft Bill, which no doubt is prepared first for discussion. From the evidence quoted the leading British firms are in favour of more effective control.

It is reported from Rome that a "thunderbolt" fell there on Sunday, March 27, and slightly damaged the base of the Obelisk in the Piazza di San Pietro, but no mention is made of any fragments of the meteorite having been found. The excellent "Introduction to the Study of Meteorites," published by the British Museum (Natural History), refers as follows to several early historical accounts of meteorites associated with Rome:—"A stone, famous through long ages, fell in Phrygia, and was preserved there for many generations. About 204 B.C. it was demanded by King Attalus, and taken with great ceremony to Rome. It is described as 'a black stone in the figure of a cone, circular below and ending in an apex above.' In his History of Rome Livy tells of a shower of stones on the Alban Mount about 652 B.C. which so impressed the Senate that a nine days' solemn festival was decreed. Other instances of the 'rain of stones' in Italy are mentioned by the same author."

THE next ordinary scientific meeting of the Chemical Society will be held at the Institution of Mechanical Engineers on April 7 at 8 p.m., when Dr. F. W. Aston will deliver a lecture entitled "Mass Spectra and Atomic Weights."

In connection with the London Branch of the National Union of Scientific Workers a meeting will be held at 7.30 o'clock on Thursday, April 14, at

52 St. Martin's Lane, W.C.2, when an address will be given by Mr. H. E. Potts on "The Position of Employer and Scientific Worker in Relation to Patent Law."

ON Tuesday next, April 5, at 3 o'clock, Prof. R. A. Sampson, Astronomer-Royal for Scotland, will deliver the first of two lectures at the Royal Institution on (1) Present Position of the Nebular Hypothesis and (2) Measurement of Starlight. The Tyndall lectures will be delivered by Mr. C. T. R. Wilson on Thunderstorms, beginning on Thursday, April 7; and on Saturday, April 9, Dr. H. H. Dale begins a course of two lectures on Poisons and Antidotes. The Friday evening discourse on April 8 will be delivered by Dr. R. H. A. Plimmer on Quality of Protein in Nutrition.

THE officers elected by the Institution of Petroleum Technologists for the session 1921-22 are as follows:—*President*: Prof. J. S. S. Brame. *Vice-Presidents*: Mr. H. Barringer, Sir George Beilby, Sir John Cargill, Bart., the Right Hon. Viscount Cowdray of Cowdray, Mr. A. W. Eastlake, and Sir Thomas H. Holland. *Council*: Mr. A. C. Adams, Mr. H. Allen, Major R. W. Barnett, M.P., Mr. A. Campbell, Mr. E. H. Cunningham Craig, Mr. A. Duckham, Dr. A. E. Dunstan, Mr. J. Kewley, Dr. W. R. Ormandy, Mr. T. C. Palmer, Dr. F. Mollwo Perkin, Mr. R. Redwood, Mr. J. S. Smith, and Prof. W. W. Watts.

THE Joint Committee on British Petrographic Nomenclature appointed by the Geological Society of London and the Mineralogical Society has published a report in the current issue of the *Mineralogical Magazine*. The report deals with ninety rock-names hitherto used with various meanings. Some synonymous terms are considered and seven general recommendations for the formation of rock-names are made. The Geological Society has issued one copy of the report to each of its fellows. A limited number of copies are still available for distribution. Application for copies may be made to Mr. Campbell Smith, British Museum (Natural History), Cromwell Road, S.W.7. The committee is still in being, and it is expected that further meetings will be held.

WE have received the first issue of *Atti della Società Agronomica Italiana*, the purpose of which is to co-ordinate and initiate scientific work in agriculture in Italy, it being considered that the existing agencies are not sufficiently strong. An advisory committee has therefore been formed under the presidency of Senator Grassi, and including Profs. Baglioni, Bonzi, Cuboni, and Pirota. A programme has been drawn up comprising five sections:—(1) Investigations of the best means of utilising poor and arid land, special attention being paid to the phenomena of drought resistance of crops. (2) The study of the yield capacity of wheat in the south of Italy, especially in relation to the physical features of the country and the meteorological data. (3) The control of the insect pests of the olive. (4) The possibility of obtaining potash manures from leucite deposits. (5) The study of the root-rot of the Sicilian citrus-tree. The new organisation will be watched with much interest by agriculturists everywhere, who will heartily wish it success in the study of these important problems.

DR. R. KARSTEN contributes to *Acta Academiae Aboensis*, part i., an elaborate monograph entitled "Contributions to the Sociology of the Indian Tribes of Ecuador," divided into three parts, dealing with agriculture, hunting and fishing, and birth customs respectively. The last includes an account of the magical practices intended to promote the growth of the crops and modes of attracting animals and fish. Many curious details are given regarding birth customs. These are closely connected with peculiar, but vague, ideas of conception and supernatural birth. They do not, like the Arunta of Australia, believe that conception is entirely due to spirit influence, but they think that the influence of the new moon is a potent cause. Monstrous or defective children are the direct result of demoniacal operation, and the same belief extends to the birth of twins, even where there is nothing abnormal in their outer appearance.

If the theory explained in a paper entitled "Buddha's Diadem" by the eminent scholar Dr. L. A. Waddell, and published in *Ostasiatische Zeitschrift* (iii., 2), be accepted, the current views of the development of early Buddhism must be modified. The popular view is that the deification of Buddha, unknown to the orthodox primitive school, did not prevail among the "Northern" school until the age of Kanishka (1st century B.C. to 2nd century A.D.). It is now shown that as early as the 4th or 3rd century B.C. Buddha was invested with the attributes of the supreme Brahman god Nārāyana—Vishnu. One of the two chief conventional symbols of this god was the supernatural diadem, now represented by the curious protuberance of the skull in images of Buddha, the prototype of which is the serpent-hood of Varuna, the Vedic god of the firmament. By the artists of the Gandhāra school Buddha was identified with Apollo, and the skull protuberance became a symbol of divine wisdom, emitting flames which become divine messengers. It was at a later time conceived by Buddhists as the seat of the Dharani, or magical protective spells. In short, the diadem is the lineal descendant of a primeval cosmic ideograph imported into ancient India from the West long before the rise of Buddhism, expressing the divinity in Nature's order, or Law. The paper is attractively written, and forms an important contribution to the study of early Buddhism.

Two recently published maps show some important aspects of the distribution of population in Siberia. They accompany an article in *Petermanns Mitteilungen* for December, 1920, by Dr. A. Schultz entitled "Die Verteilung des Landbesitzes in Sibirien." Of most interest is the location of the colonies of free settlers from European Russia and the colonies of Cossacks. The maps show clearly the small hold in real settlement that Russia has on the rich lands of eastern Siberia, especially the Amur and Ussuri valleys. They illustrate also the strong predominance of Cossacks and native Siberians around the head-waters of the Amur system and Chita and Transbaikalia generally. In western Siberia Russian settlers predominate north of the steppe provinces

and south of the marsh and forest lands. The statistics on which the maps are based date from 1913, or even earlier in some cases, but this is unavoidable; even under the old régime Russian statistics were very slow to appear, and now they are unobtainable.

IN an address on "International Organisation and Public Health," read before the Society of Medical Officers of Health on February 18, Dr. G. S. Buchanan reviewed the International Health Organisation which will shortly come into being as a result of a series of detailed resolutions which were passed by the Assembly of the League of Nations at Geneva last December (*Lancet*, February 26). By the Covenant of the League of Nations the members of the League pledge themselves to take steps in matters of international concern for the prevention and control of disease. These include (1) advising the League in matters affecting health, (2) co-ordination of administrative health authorities in different countries, (3) organisation of means for the more rapid interchange of information on matters such as epidemics where precautionary measures may be required, (4) the revision of international agreements affecting the public health, (5) assisting international labour organisations in securing protection for the worker against sickness, injury, and disease arising out of his employment, and (6) the organisation of missions in connection with matters of health at the request of the League of Nations.

WE have received a brochure entitled "Approved Technique of the Rideal-Walker Test," by Dr. S. Rideal and Mr. Ainslie Walker (H. K. Lewis and Co., 1s. net). It contains a clear and full account of this test, which is employed for estimating the germicidal value of disinfectants, comparing the particular disinfectant with a standard carbolic acid solution under stated conditions. The test was originally devised about 1902, and the present description introduces some modifications of detail, though not of principle. The term "approved" which appears in the title may mislead, as it here means "recommended by the authors," and not a statutory or general approval.

MR. HECTOR COLWELL continues his "History of Electrotherapy" in the *Archives of Radiology and Electrotherapy* for February (No. 247). The work of Duchenne (1806-75) particularly is dealt with. Duchenne was the first to discover that individual muscles can be stimulated electrically by the application of suitable moistened electrodes to the overlying skin, and he is regarded by Mr. Colwell as the founder of modern electro-therapeutics.

THE attention of workers on water-mites (Hydracarina) is directed to the account by Messrs. C. D. Soar and W. Williamson (*Journal of the Quekett Microscopical Club*, vol. xiv., November, 1920) of the twenty-two species of Eylais which occur in Britain.

MR. E. AVERY RICHMOND has published (*Bull. Amer. Mus. Nat. Hist.*, vol. xlii., 1920) some interesting studies on the life-history and biology of water-beetles

of the family Hydrophilidæ, especially on those occurring in the vicinity of Ithaca. Some eighteen genera—examples of all of which have been reared by the author—are dealt with, and keys are given for the determination of the egg-cases, larvæ, and pupæ (so far as they are known) of this family.

AMONG the investigations carried out at the Millport Marine Laboratory, which are recorded in the recently issued annual report for 1919 of the Scottish Marine Biological Association, is one by Mr. R. Elmhirst and Dr. J. H. Paul on the distribution of copper in the blood and "liver" of the Decapod Crustacea during the moulting cycle. It has been found that as moulting approaches the animal accumulates a considerable amount of copper in the "liver," and that this is released into the general circulation when the shell is cast. The amount of copper present varies; in the *Macrura* it may represent 5 per cent. of the ash of the liver; in the *Brachyura* only traces are present; in *Lithodes*—the position of which is regarded as intermediate—the maximum amount is about $2\frac{1}{2}$ per cent. Mr. Elmhirst notes the great abundance in the Laminarian zone of the polyzoon *Membranipora membranacea*, and that animals of various phyla browse on *Membranipora*, e.g. sea-urchins, starfish and brittle stars, lobsters, crabs, and several molluscs, all of which require lime for building their skeletons or shells. Estimations by Mr. Elmhirst and Mr. J. S. Sharpe show that round the shores of Cumbrae the quantity of lime available in the *Membranipora* in August was equivalent to some $3\frac{1}{2}$ tons of metallic calcium. At that season members of the larger crustacea moult inshore among the *Laminaria*, and it is significant also that analyses of the ash of *Membranipora* reveal traces of copper.

IN the Transactions of the New Zealand Institute (lii., pp. 193-239, 1920), Dr. J. E. Holloway continues his studies of the New Zealand species of the genus *Lycopodium* with an account of the structure of the prothallus in five species, belonging to the sections *Phlegmaria* and *Cernua*. The structure, which shows considerable variety, is described in detail, together with the relation of the young plant to the prothallus and the form and distribution of the symbiotic fungus which is universally present, at any rate in later stages of development. The author regards the fungal symbiont as of great importance. He concludes, from a comparative study of the general form and structure of the different *Lycopodium* prothalli, that they are all more or less modified from some primitive type of structure, and that the chief factor in this modification has been the presence of the symbiotic fungus. This primitive type was probably a bulky filament of radial build living at the surface of the ground and containing chlorophyll. The adoption of a fungal habit opened the door to possibilities of modification of this simple type of structure, and the prothallus was able to establish itself in new positions and soils, the different types of habitat resulting in different types of modification of the original structure. When the fungal habit was thoroughly adopted, the early filamentous stage became lost, but in all its forms the *Lycopodium* prothallus has never departed from its

radial build. It is suggested as possible that the varied aspects of the genus as it exists to-day, in the form and structure of the mature plant, have arisen as a natural consequence from the spread of the prothallus to different stations and soils.

WE have received the annual report of the Director of the United States Geological Survey for the year ending June 30, 1918. During the year under review practically all the activities of the Survey were directed to the prosecution of the war and to problems arising from the war; research of a purely scientific nature was in abeyance. Much attention was devoted to the search for minerals, the examination of deposits, and the estimate of available reserves. In the effort to meet the urgent demand for essential minerals, Survey geologists visited not only the mining districts of the United States, but also deposits of potash, nitrate, chrome, and manganese in Central and South America and the West Indies. As a further contribution to the problems of the day, much consideration was paid to the extent to which water-power could, if necessary, replace steam-power. A natural extension of these investigations was the study of the mineral and power resources of the world in general. A number of ingenious diagrams show the work of the various departments of the Survey in relation to the War Departments to which they contributed.

SINCE the memorable work of J. W. Judd on the Mesozoic rocks of Scotland the Geological Survey has been able to add many important details, and the discovery of iron-ore in the Upper Lias of Raasay by H. B. Woodward in 1893 has led to a considerable industry. Dr. G. W. Lee now describes ("The Mesozoic Rocks of Applecross, Raasay, and North-East Skye," Mem. Geol. Surv. Scotland, 1920, 6s.) the western zones in detail, with an interesting series of comparative vertical sections and a geological map of the southern end of Raasay. The iron-ore is oolitic, and passes laterally into siderite. Its composition is held to ally it with chamosite, the green chloritic silicate described in 1820 from Chamoson, west of Sion, in the Rhône vale. Berthier's original analysis, it may be remarked, has been replaced by those of Groth, which bring the composition of chamosite into agreement with the ore of Raasay. Mr. S. S. Buckman concludes from the ammonite fauna that a long interval occurred between the deposition of the oolitic beds and the overlying shales, and Dr. Lee suggests that the mineral change in the former took place during this stratigraphical episode. The presence of green silicates in the oolitic iron-ores of Arenig age in North Wales, which have been ascribed to the alteration of limestone, renders further research into the origin of the Raasay ore desirable.

ALL previous attempts at tabulating chemical analyses of rocks are dwarfed by Professional Paper 99, 1917, United States Geological Survey ("Chemical Analyses of Igneous Rocks," by Dr. H. S. Washington). It is a revised and enlarged edition of Professional Paper 14 (1903), which contained 2881 analyses published between 1884 and 1900. The present volume contains 8602 analyses of igneous rocks published between 1884 and 1913, which have

been carefully scrutinised and graded according to their completeness, accuracy, and the freshness of the material analysed. They are divided into four parts:—(1) Superior analyses of fresh rocks; (2) incomplete analyses of fresh rocks; (3) superior analyses of altered rocks and tuffs; and (4) inferior analyses. Part 1, including 4980 analyses, constitutes the most complete statement yet published of the distribution of rocks in the subdivisions of the quantitative classification of igneous rocks of Cross, Iddings, Pirsson, and Washington (1903), an explanation of which is given in appendix i. The analyses in the other three parts are arranged under their published rock-names. A valuable feature of the arrangement is the geographical grouping of analyses in each subdivision; this brings out the extreme scarcity of trustworthy analyses of rocks of some of the most important petrological areas. In this connection it may be noted that for rocks of the British Isles there are only 264 analyses recorded in the whole book, distributed as follows: 77 in part 1, 9 in part 2, 90 in part 3, and 88 "inferior" analyses in part 4. Dr. Washington's work will be of inestimable value. The complete record of analyses here presented and their arrangement by the quantitative system will facilitate the reviewing of our current nomenclature in the light of the chemical composition of rocks.

DR. C. E. ADAMS, Government Astronomer and Seismologist in New Zealand, and Prof. E. Marsden have recently visited the geophysical observatory at Apia founded in 1902 by the Society of Sciences of Göttingen. Their report appears in the *New Zealand Journal of Science and Technology* (vol. iii., 1920, pp. 157-61). The observatory is the most complete of its kind in the Pacific. The magnetic department provides for the continuous registration of the horizontal component, the vertical component, and the declination. The seismological observatory contains Wiechert seismographs for both horizontal and vertical components of the motion. A recording tide-gauge is maintained in the adjoining harbour. In addition to the usual astronomical and meteorological observations, arrangements have been made for the investigation of the upper atmosphere by means of hand-hauled kites and free balloons. New Zealand having accepted the mandate over Samoa, the authors urge the desirability, with which all will agree, of maintaining the observatory, which is well-equipped and situated, at its full pre-war efficiency.

ONE of the most serious difficulties with which inventors of apparatus for use on aeroplanes during the war had to contend was the absence of any information as to the special circumstances in which the apparatus had to operate and the arrangements which had been made to enable it to function properly in those circumstances. Even now it is not easy for an inventor not engaged in aeroplane construction or design to get to know what apparatus is actually used and in what respects it falls short of the requirements of the service. To all who are interested in the subject an article on aeronautical instruments in the January issue of the *Journal of the Franklin Institute* by Prof. C. E. Mendenhall will

be welcome. It divides them into four groups concerned respectively with the engine, the aeroplane, navigation, and military purposes, and in each group the instruments used and the special difficulties with which they have to contend are described. The article is well illustrated, and gives much valuable information in a compact and readable form.

THE "British Meteorological and Magnetic Year Book," 1917, part 4, has recently been published by the Meteorological Office. It comprises hourly readings of terrestrial magnetism at Eskdalemuir Observatory and summaries of the results obtained in terrestrial magnetism, meteorology, and atmospheric electricity, chiefly from self-recording instruments at the observatories of the Meteorological Office. The work consists mainly of tabular matter. The mean daily variation of the various meteorological elements is given for each month and for the year for the five observatories, Aberdeen, Eskdalemuir, Cahirciveen (Valencia), Richmond (Kew), and Falmouth. C.G.S. units are used for meteorological data, with temperature in absolute degrees. The normal constant for absolute temperature given is 200°. With a normal constant of 273° the resulting values would be in ordinary degrees Centigrade, a system adopted by many meteorologists on the Continent and by some at home. To the uninitiated it gives a reading more easily comprehended, although in the British Isles very occasionally some of the values would be given with the negative sign. For terrestrial magnetism hourly observations are given for each month, with notes of the special features of the disturbances experienced. Notes are given at the end of the volume on the management of the magnetic and electrical instruments and on results of interest, showing the method of observation and the treatment in discussion.

IN two papers communicated to the Rumanian Academy of Sciences for 1920, G. G. Longinescu with G. P. Teodorescu and G. Chaborski respectively describes modified methods for the separation of the metals of the second group in qualitative analysis and of hydrochloric acid in the presence of hydrobromic and hydriodic acids. In the first, ammonium carbonate is used in the separation of the metals of the sub-group instead of ammonium sulphide. Caustic soda is used in the separation of the remaining metals. The separation of a bromide from the mixture with a chloride and iodide is effected by heating with alcohol and sulphuric acid. Hydrochloric acid is evolved, the hydrobromic acid decomposes into bromine which forms ethylene bromide, and the iodine remains principally in the liquid.

THE economics of ship propulsion are dealt with in a paper entitled "Coal, Oil, or Wind," read on December 14 before the Institution of Engineers and Shipbuilders in Scotland by Mr. C. O. Liljegren. So far as ships are concerned, wind only can be used to save fuel. Properly applied, this method of propulsion would mean an enormous saving in fuel and a reduction in the cost of carrying both passengers and freight. Sailing ships can be run at less cost per ton-year than any machine-driven vessel, whatever the price of fuel. The author has studied Sauerbeck's

index, giving prices of forty-five commodities since 1800, together with the records of the prices of French wheat since 1250, and constructs some interesting curves. He is thus led to predict that all fuel will be too high in price for the profitable working of vessels for at least thirty years to come. The motor clipper appears to be the type of the immediate future, in which the auxiliary propulsion machinery would be used in calms only. The following figures are for the year 1913-14, and give the percentage earnings on investments with freight at 20s.:—Motor-ship, two-cycle, 26.0; motor-ship, four-cycle, 36.2; steamship, superheat, 38.5; and motor clipper, auxiliary sailing vessel, 70.2. Comparative figures for the year 1920 with freight at 55s. are as follows:—Motor-ship, four-cycle, 28.5; steamship, superheat, 25.5; motor clipper, 7150 tons, 56.0; and motor clipper, 11,600 tons, 63.0.

AMONG the forthcoming books announced by the Cambridge University Press we notice "Scientific Papers of Henry Cavendish," in 2 vols. Vol. i. (The

Electrical Researches) is a reprint of the volume edited by Clerk Maxwell (1874-79), with additional notes by Sir Joseph Larmor. Some changes have been made in the arrangement of headlines, etc., and it is hoped that the revised volume will bring out more clearly both the extraordinary range and value of Cavendish's work and the magnitude and importance of the task which Clerk Maxwell accomplished in the last five years of his life. The volume also includes a reprint of the biographical sketch of Cavendish which Dr. T. Young contributed to the "Encyclopædia Britannica." Vol. ii. (Chemical and Dynamical), edited by Sir Edward Thorpe, includes the papers published in the Philosophical Transactions and much unpublished material from the papers in the possession of the Duke of Devonshire. It also contains an account of the researches in dynamics, astronomy, geology, and magnetism, in arranging which the editor has been assisted by Sir Joseph Larmor, Sir Archibald Geikie, Sir Frank Dyson, and Dr. C. Chree.

Our Astronomical Column.

PONS-WINNECKE'S COMET.—The failure to find this comet up to the present suggests that the date of perihelion may be later than those assumed. Ephemerides for April have therefore been prepared with the addition of a third assumed date, June 29.5. They are for Greenwich midnight:

T assumed June 13.5.

Date	R.A. h. m. s.	N. Decl. °	Log <i>r</i>	Log Δ
March 31	15 30 23	34 51	0.1519	9.7731
April 8	15 46 15	38 13	0.1306	9.7181
16	16 4 49	41 27	0.1091	9.6600
24	16 26 52	44 39	0.0879	9.5971
May 2	16 54 36	47 40	0.0670	9.5270

T assumed June 21.5.

March 31	14 32 23	39 26	0.1729	9.8064
April 8	14 35 18	42 57	0.1519	9.7602
16	14 36 45	46 20	0.1306	9.7135
24	14 37 40	49 21	0.1091	9.6641
May 2	14 37 12	52 3	0.0879	9.6100

T assumed June 29.5.

March 31	13 39 1	42 1	0.1932	9.8483
April 8	13 33 41	45 1	0.1729	9.8130
16	13 24 58	47 28	0.1519	9.7789
24	13 14 44	49 15	0.1306	9.7452
May 2	13 4 28	50 11	0.1091	9.7092

These three ephemerides define curves near which the comet should be found. Owing to its high north declination it is observable throughout the night.

COMET REID 1921a.—A third observation of this comet was obtained at Algiers on March 25. The following is the orbit deduced from this, combined with those of March 14 and 18:

$T = 1921 \text{ May } 10.297 \text{ G.M.T.}$

$\omega = 64^\circ 25' 24''$

$\Omega = 268^\circ 28' 53''$

$i = 131^\circ 36' 42''$

$\log q = 0.00582$

Ephemeris of Greenwich Midnight.

	R.A. h. m. s.	Decl.	Log <i>r</i>	Log Δ
March 31	20 24 4	7 1 S.	0.0843	0.0928
April 8	20 28 51	2 23 N.	0.0596	0.0012
16	20 34 40	17 2	0.0379	9.9007
24	20 44 29	39 37	0.0206	9.8190
May 2	21 12 30	67 28 N.	0.0095	9.8127

The comet was observed on March 25 in bright moonlight. There is reason to expect that it will attain at least faint naked-eye visibility. The elements do not closely resemble those of any known comet.

LARGE DETONATING FIREBALL.—Mr. Denning writes:—"On March 16, 8h. 33m. G.M.T., a magnificent meteor was observed from Scotland and the north of England. It occasioned a brilliant illumination of sky and landscape, and was followed several minutes afterwards by loud detonations, which some of the observers likened to the bursting of high explosive shells. At Edinburgh the sound came in about 1 minute after the meteor had passed, at Duns the interval was 2½ minutes, at Kelso 80 seconds, while at Berwick-on-Tweed the fireball's flash and sound of disruptive explosions were almost simultaneous. There seems to have been little doubt that the meteor may have fallen in or near the latter town, or in that part of the North Sea contiguous to it.

"A large number of observations were made of the object, but they are mostly of the popular type. It appears highly probable, however, that the meteor moved in a direction from south-west by west to north-east by east, and that its flight was from over Moffat to Berwick-on-Tweed. Its height was about 71 miles at the outset of its luminous career, and after traversing about 75 miles of its path it seems to have been about 24 miles high between Kelso and Coldstream, while at Berwick the meteor gave evidence of very near approach to the earth's surface. The fireball was a late Taurid from a radiant at 80°+22°, but it is rather difficult to fix with accuracy and certainty the point of radiation. The duration of the meteor's flight was about 6 seconds, and this would give a velocity of about 14 miles per second. Up to the time of writing no fragments of the meteor have been found, but they might easily have fallen into the sea unperceived."

The Origin of the South-west Monsoon.¹

By DR. G. C. SIMPSON, F.R.S.

IT has generally been held that the south-west monsoon owes its origin to the great difference of temperature which exists during the summer months between the heated land surface of India and the surrounding oceans, the general idea being that the warm air over the land rises, and damp air from the sea flows into India to take its place, thus resulting in the strong south-west winds, the rainfall itself being due to the cooling of the air as it rises over India.

This theory has to face the difficulties that the temperature over India is much higher in May, before the monsoon sets in, than it is during the monsoon itself; that the temperature is higher in years of bad monsoon than in years of good monsoon; and that the part of India which has the highest temperature and the lowest pressure, and where ascending currents should be the greatest, is a region of practically no rainfall throughout the monsoon.

The true explanation of the south-west monsoon can be obtained only by taking a wide view of the weather conditions over large parts of the earth's surface during the summer months in the northern hemisphere. It is then seen that the south-west winds are not due to the temperature in India, but are a relatively small part of a general circulation of

the atmosphere caused by a region of high pressure over the South Indian Ocean and a region of low pressure which extends over the whole of Central Asia. Air passes northwards from the region of high pressure as the south-west trade winds so far as the equator, where it gets caught up in the circulation around the low pressure over Asia. On account of the particular arrangement of sea and land, combined with deflection of wind currents due to the earth's rotation, this air travels for 4000 miles over the sea before it reaches India, where it arrives in a very warm and exceedingly humid condition. This air, however, would probably sweep right across India to its goal in Central Asia without producing much rainfall if it were not for the unique distribution of mountains around India. From the north of the Mokran coast, right round India, following the line of Afghanistan, the Himalayas, and the mountains of Burma, there extends an unbroken wall of mountains, nowhere lower than 5000 ft., standing directly athwart the air-currents. The mountains catch the air, which is being driven by a pressure distribution extending from the Southern Indian Ocean to the centre of Asia, in a kind of trap, out of which there is no escape except by ascension. The damp, humid air, which begins to rain as soon as it rises 500 ft., is forced to rise between 10,000 ft. and 20,000 ft., and, in consequence, large masses of water are precipitated over the greater part of the Indian area.

¹ Abstract of a paper entitled "The South-west Monsoon," read to the Royal Meteorological Society on Wednesday, March 16.

The Finsbury School of Chemistry.

By PROF. G. T. MORGAN, F.R.S.

THE widespread feeling among scientific workers that the threatened closing of the Finsbury Technical College would be a calamity of national importance has found expression in a petition recently presented to the council of the City and Guilds of London Institute. In this appeal, which is supported by a long list of eminent names representative of every branch of art, science, and technology, the members of the Finsbury Technical College Defence Committee, many of whom are former students of the college, testify to their grateful appreciation of the long-continued benefactions made by the institute to the college, and urge the council to take into consideration all possible sources of assistance in the responsible task of keeping the college open as an institution for higher technical education.

The salving of Finsbury cannot be regarded otherwise than as a prudent step in the conservation of our educational resources at a time when public expenditure on new institutes embodying untried schemes is scarcely likely to meet with popular approval. This anticipated continuance of the college involves, however, a retention in its entirety of the unique system of scientific education given at Finsbury, so that the future of this institution may be a logical and evolutionary development of its former activities. The policy consistently adopted in the past by the City and Guilds of London Institute was to place implicit trust in the judgment of the scientific men appointed to the professoriate of the college. These professors were not tied down by formal curricula, and were allowed complete liberty to teach their respective subjects in their own way.

It is largely this freedom from prescribed courses and examination restraints which has given to the

Finsbury School of Chemistry, founded by Prof. H. E. Armstrong in 1879, its outstanding and distinctive features. From the first its laboratories were a centre of unceasing chemical activity, for they were open to day and evening students, who found unflinching assistance in their preparatory studies and inspiration in research from the hard-working staff whom the professor gathered round him. Among the more salient investigations of the early Finsbury School of Chemistry, which inaugurated a new era in the teaching of this science, were the researches on the laws of substitution among aromatic compounds and on the relationship between colour and chemical constitution, and the important discovery by Armstrong and Miller of the purification of coal-tar hydrocarbons through their sulphonic acids.

With Prof. Meldola's arrival in 1885 the chemical department was brought into even closer association with the synthetic colour industry. The new professor had recently discovered the oxazine blue which still bears his name, and had also made in the works several notable discoveries which afterwards bore fruit either in this country or abroad. The investigations then initiated at Finsbury showed the influence of the earlier industrial experience of its director. The course of substitution in the naphthalene series was the subject of several memoirs, and the researches on azo-compounds originally commenced in the works laboratory were continued throughout the remainder of the professor's lifetime. In collaboration with Mr. F. W. Streatfeild, Meldola instituted an inquiry into the constitution of diazo-amino-compounds and amino-amidines which brought to light unexpected instances of isomerism. In 1900 he discovered the first recorded instance of the replacement of a nitro-group

by hydroxyl during diazotisation. Numerous cases of this substitution have since been noticed and shown to be capable of industrial application in the production of useful mordant dyes.

During the greater part of their joint career at Finsbury, Meldola and Streatfeild had as research assistants at any given time only one or two senior students chosen to work for one session in the professor's laboratory. Streatfeild, however, had a wonderful faculty for dovetailing together instruction and research, and Meldola had the happy knack of furnishing his youthful collaborators with an "Arbeit" which generally blossomed into a contribution to the Chemical Society's Transactions within this annual period of apprenticeship. From 1908 onwards the council of the college provided the professor with a whole-time research assistant, who generally held this coveted post for about three years. The senior students who were fortunate in receiving this more prolonged experience in research have justified their training by gaining responsible industrial appointments within a short time of leaving college.

When the writer succeeded his former teacher in 1916 the work of the Finsbury laboratories was dominated by the exigencies of the war, then entering on its critical stages. The Trench Warfare Department employed in the Finsbury laboratory of applied chemistry a small works plant for smoke-bombs and other munitions, which was not at that critical time to be found in any other London college. In 1917 the institute sanctioned an extension of the

chemical department, and the additional facilities thus provided were promptly made use of by the Chemical Warfare Department, which maintained a staff of research workers at the college until after the armistice. At the same time the chemical school remained in touch with the synthetic colour industry, inasmuch as the new research laboratories afforded accommodation to a group of chemists sent by the British Dyestuffs Corporation to extend their experience of organic synthesis. Other firms also took advantage of the research equipment for applied chemistry which was now being made in the chemical workshop, and several experienced chemists were allotted laboratory facilities for their researches in various branches of chemical technology. The materials required by these research workers were in certain instances prepared by senior students of the chemical department, who thus benefited by being brought at an early stage into contact with the actualities of industrial practice.

With a high tradition of practical laboratory instruction extending over a period of forty years it is not surprising to find that the senior *alumni* of the Finsbury chemistry department now occupy responsible positions in every centre of chemical activity in the British Empire. It is, moreover, a noteworthy consequence of the close association of the college with the industrial life of the country that several important chemical firms are taking an active interest in the Finsbury defence movement, thus showing in a practical manner their appreciation of the training afforded in this historic school of chemistry.

Bacterial Diseases of Farm Crops.

IN certain seasons some of the bacterial diseases which attack farm crops do sufficient damage to become serious economic factors. An instance of this was provided in 1918 by the "halo-blight" of oats which caused much trouble throughout Wisconsin and other parts of the United States (C. Elliott, *Journ. Agric. Research*, 1920, vol. xix., No. 4). The blight appears to be present in oat-fields every season, but attracts attention only when it develops strongly and does serious damage under particularly favourable weather conditions. The epidemics disappear if the weather changes to a type more favourable to the development of the plant.

The halo-blight usually appears as lesions on the leaves, but may occur on the leaf-sheaths and glumes; infected areas show a centre of dead tissue surrounded by a halo-like margin of chlorotic tissue, and they gradually spread and often coalesce until large areas are involved and the whole leaf becomes dry and brown. A typical white organism has been isolated from these lesions, for which the name *Bacterium coronafaciens*, n.sp., is proposed. The organism is a motile rod with rounded ends, sometimes occurring singly or in pairs, but usually in short to long chains. One to several polar flagella have been made out, but no spores have been observed. The bacteria live through winter on the seed, produce primary lesions on the first leaves of seedlings, and are carried to other leaves by wind and rain. Natural infections of halo-blight have been observed only on oats and rye, though artificial inoculations indicate that the organism may be slightly pathogenic on wheat and barley also. Infection takes place more readily on injured than on uninjured parts of the plants. In normal circumstances different varieties of oats show differences in susceptibility to the disease.

Though halo-blight is known to be seed-borne, no practical method of seed treatment has yet been found which will entirely control the disease. Treatment with 1 in 320 formalin, as is used for smut, keeps the blight in check, but is not entirely effective. Heating the seed in a hot-air oven for thirty hours at 100° C. completely checks the disease, but the commercial application of the treatment has not yet been worked out.

An unrecorded bacterial disease, basal glume-rot of wheat, was discovered in 1917 by L. McCulloch (*Journ. Agric. Research*, 1920, vol. xviii., No. 10) on plants obtained from various localities in Canada and the United States. The leaf, head, and grain of wheat are all affected, the diseased portions being discoloured and blackish, and the basal ends of the grains often appear charred. The development of the grain is hindered when the disease appears early in life, but it is possible for the plants to be attacked when the ears are well filled out. Bacteria are abundant in all the discoloured tissues, and are fairly resistant to desiccation, as the organism has been isolated from dry wheat-kernels kept at room-temperature for seventeen months. The organism, for which the name *Bacterium atrofaciens* is proposed, is a white, polar-flagellated rod, producing a green fluorescence in the ordinary culture media. It attacks starch, and will tolerate sodium chloride up to a strength of 5 per cent., above which no growth occurs. Many tests of the reaction of the bacteria have been made, and the optimum growth-temperature appears to be between 25° and 28° C., the thermal death-point being about 48° or 49° C. Ten minutes' exposure to sunlight or forty-four hours' freezing was also found to kill most of the bacteria. No method of controlling the disease is suggested.

W. E. B.

Fatigue and Efficiency in the Iron and Steel Industry.

IN Report No. 5 of the Industrial Fatigue Research Board Dr. H. M. Vernon describes the results of a series of investigations carried out at most of the chief iron and steel centres in the United Kingdom. He points out that there are tremendous variations in the mechanical efficiency of the plant employed in various works and in the efficiency with which human labour is utilised. In most districts the blast furnaces are charged by hand, though four to eight times more men are required than for mechanical charging, and the work is of a much heavier character. In the most efficiently run open-hearth steel furnaces two to three times more charges of steel are worked per week than in the least efficient, whilst the efficiency of rolling mills varies in similar proportion.

The steel-melters, when engaged in mending their furnaces, which they usually do immediately after the molten steel has been drawn off and whilst they are still white-hot, have to undertake one of the most arduous forms of labour known in any industry. Much might be done to lighten this labour, for at some works the average time required for mending is seven times longer than at others; also, owing to the fact that all the furnaces are started at about the same time, they tend to require mending at the same time, so the men frequently cannot relieve one another. This could be remedied by arranging that mending was more evenly spread over the week. Many of the steel furnaces are still charged by hand, in spite of the tremendous labour and delay involved.

The effect of fatigue on health and longevity was studied by Dr. Vernon (in conjunction with Mr. E. A. Rusher) by tabulating the sickness and mortality data of 24,000 iron and steel workers for a six-year period. These data, which had accrued under the National Health Insurance Act, showed that there is a definite relationship between the amount of sickness experienced by the workers and the nature of their occupation. Steel-melters headed the list, and showed 23 per cent. more sickness than the average and 26 per cent. greater mortality. The puddlers of wrought-iron showed a 20 per cent. excess of sickness, the whole of this excess being due to respiratory diseases and rheumatism. Presumably this was because the puddlers usually work alternate 20-minute periods of very hot and heavy work followed by light work or complete rest, during which they tend to catch chills. Other workers at hot and heavy work likewise showed an excess of sickness, whilst workers at ordinary temperatures, such as cranemen and general labourers, showed 9 per cent. less sickness than the average.

University and Educational Intelligence.

MR. JAMES W. LOW, assistant in the natural history department of University College, Dundee, has been appointed lecturer in zoology at Birkbeck College, London.

THE Manchester Education Committee has appointed Prof. B. M. Jones to be principal of the Manchester College of Technology in succession to Principal Garnett. Prof. Jones, who was educated at Oxford, was for some time professor of chemistry at the Government College, Lahore, and more recently professor of chemistry at, and director of, the Edward Davies Chemical Laboratories, Aberystwyth.

Science for February 25 announces that Prof. J. R. Angell was elected president of Yale University at a meeting of the University Corporation on February 20; the new president will take up his duties at the close of the university year. Prof. Angell is a graduate of the University of Michigan, and has been professor of

psychology, dean, and acting president of Chicago University. He has also shown ability as an administrator and a leader of education while acting as chairman of the National Research Council and as president of the Carnegie Corporation.

A LIST of the students and teachers from the Dominions overseas and from foreign countries at present in our universities, which supplements that issued in December last and referred to in *NATURE* of December 30, p. 585, has been issued by the Universities Bureau of the British Empire. Although the information is not yet quite complete, an interesting summary has been compiled showing the numbers which are contributed by each of the continents. Africa sends 1046; America and the West Indies, 676; Asia, 1228, of whom 974 are from India, Burma, and Ceylon; Europe, 703; and Australasia, 282. The grand total to date is thus 3935, of whom about two-thirds are from our overseas Dominions.

THE Carnegie Corporation of New York has entered into an agreement with the Leland Stanford University of California by which it will give large financial support to a research institute which the University is about to establish for the intensive study of the problems of the production, distribution, and consumption of food. The need for such research was first brought to the attention of the Corporation by Mr. Herbert C. Hoover, and it is proposed that the institute shall bear his name. The selection of the University as its home is partly due to the fact that Mr. Hoover has deposited there the documentary material he has collected relative to the economic side of the war. The work of research, for which the laboratories of the University will be made available, is to begin on July 1.

THE *Pioneer Mail* for February 18 publishes extracts from the presidential address delivered by Lt.-Col. J. W. D. Megaw to the Medical Research Section of the Indian Science Congress. Col. Megaw states that of late persistent rumours have been circulated that the Government of India is not prepared to undertake the full responsibility for the School of Tropical Medicine and Hygiene of Calcutta and Bombay because all its funds are wanted for the establishment of a new Imperial Institute of Medical Research in Delhi. The school was established largely through the initiative of Sir Leonard Rogers with funds subscribed by the public and grants from the Government. Col. Megaw alludes to the valuable work done by the school, and pleads earnestly for its proper support, suggesting that the programmes of medical research in India should be considered by an authoritative committee of experts.

La Nature for March 19 gives some extracts from the statistics of attendance at the University of Paris which have been published in *L'Université de Paris*. Before the outbreak of war the total number of students in the University was 17,308; in the succeeding four years there was naturally a big drop, while in 1918 the numbers had risen again to 11,026, a figure only about a thousand short of the 1910 total. In 1919 there was a big influx of students, much as our own universities experienced, and the total rose to 17,761; but surprising figures are given for 1920, from which it appears that only 11,214 students were in attendance. The distribution of the totals among Frenchmen and others and among men and women also reveal some strange facts. The figures for the men classed as "étrangers" for 1920 show a decrease of about one-fifth of the 1913 total, while for women the decrease for the same period is fully two-thirds. The numbers of Frenchmen attending the University have decreased almost by one-half, while the numbers

of French women students increased by a similar amount. In another table are shown the numbers of students who attended at the faculties of law, medicine, science, arts, and pharmacy for the various years. From these it appears that the faculty of science is alone in claiming an increase on previous years in the numbers of its students, the figures given being 1175 for 1913, 1999 for 1919, and 1538 for 1920.

THE seventh annual report of the Carnegie United Kingdom Trust gives an account of the activities of the Trust during 1920. The high cost of materials and labour made it impossible to erect buildings even when the plans had been already approved; indeed, the trustees felt that they ought not to divert labour and material from the urgent needs of housing. Meanwhile, a special reserve of 414,765*l.* has accumulated to meet the claims of those who had been promised building grants. Unfortunately, this sum will be quite inadequate to carry out the work proposed unless there should be a heavy fall in the cost of building. For the quinquennium 1921-25 the trustees allot provisionally 250,000*l.* for library grants of all kinds. They had already promised, in the event of statutory powers being granted to county authorities enabling them to maintain county library schemes, to provide the capital outlay for every county in Great Britain which had not yet adopted a pioneer scheme under the auspices of the trustees. These powers were granted by the Public Libraries Act of 1919, and the trustees will now fulfil their promise. The Trust has continued its support to the Central Library for Students, and now proposes to help the rural libraries to lend to genuine students who may live far from any public library the more expensive books necessary for their studies. Among other grants made during 1920 we notice 4000*l.* to the London School of Economics in connection with the very large extension of its premises, 1000*l.* towards the initial expenses of a library to provide merchant seamen with books while at sea, and 1000*l.* to the National Institute of Psychology. An important function of this institute will be to advise manufacturers as to factory conditions and economy of labour.

DURING the summer term at King's College, Strand, Mr. J. H. Jeans will give four lectures on "Cosmogony and Stellar Evolution" on May 3, 10, 17, and 24 at 5 p.m. The first lecture will deal with observation evidence, the second with the effect of rotation on gaseous masses, the third with the effect of rotation on liquid or semi-liquid masses, and the last with the effect of tidal encounters. Mr. Jeans's intention is to give an account of recent observational and theoretical research in non-technical form so as to be intelligible not only to astronomers and mathematicians, but also to geologists and all acquainted with simple scientific terminology. On May 9, 11, and 13, at 5 p.m. in King's College, Prof. N. Bohr will lecture on "The Quantum Theory of Radiation and the Constitution of the Atom." At University College a course of three lectures on "Oceanography, with Special Reference to the British Isles," will be delivered by Prof. H. N. Dickson on June 17 and 24 and July 1 at 5.30 p.m. It is also announced that the course of lectures entitled "A Historical Review of Meteorological Theory," by Sir Napier Shaw, has been postponed; it will commence on April 29, and one lecture will be given each week until June 10. All the lectures mentioned are intended for advanced students of the University and others interested in such subjects; admission is in all cases free and, with the exception of Sir Napier Shaw's lectures, without ticket. Tickets for Sir Napier Shaw's lectures can be obtained from the Meteorological Office, South Kensington, S.W.7.

Calendar of Scientific Pioneers.

April 1, 1863. Jacob Steiner died.—Referred to as "the greatest geometrical genius since the time of Apollonius," Steiner treated geometry synthetically. A chair of geometry was created especially for him at Berlin.

April 1, 1900. St. George Jackson Mivart died.—Originally a barrister, Mivart took up medical and biological studies, and became well known by his writings. For short periods he held professorships at the Roman Catholic University in London, and also at Louvain.

April 1, 1901. François Marie Raoult died.—From 1870 until his death, Raoult was professor of chemistry at Grenoble. His work on solutions, begun in 1878, had a profound influence on the development of both chemistry and physics. He was awarded the Davy medal in 1892.

April 2, 1872. Samuel Finlay Breese Morse died.—An artist by profession, Morse first transmitted messages by electricity in 1835, exhibited his apparatus in New York in 1837, and in 1844 connected Baltimore and Washington by telegraph. His well-known alphabet was invented during a voyage in 1832.

April 3, 1879. Heinrich Wilhelm Dove died.—A professor of natural philosophy in the University of Berlin, Dove added much to the science of meteorology.

April 3, 1900. Joseph Louis François Bertrand died.—Secretary of the Paris Academy of Sciences and a professor in the Ecole Polytechnique, Bertrand for fifty years was a prominent member of the French mathematical world.

April 4, 1617. John Napier died.—A man of many interests, Napier first published his invention of logarithms in 1614 when sixty-four years of age. His work has been described as one which in the history of British science can be placed as second only to Newton's "Principia."

April 4, 1827. Ernst Florens Friedrich Chladni died.—One of the founders of the science of acoustics, Chladni was of Hungarian extraction, and for some time held the chair of jurisprudence at Leipzig.

April 4, 1870. Heinrich Gustav Magnus died.—A physicist of Berlin, Magnus was an inspiring teacher, and was known for his researches on heat and other subjects.

April 4, 1919. Sir William Crookes died.—Trained as a chemist by Hofmann, Crookes at an early age attained high rank as an investigator. His discovery and study of thallium, invention of the radiometer, study of electric discharges in high vacua, experiments on the rare earths and on glasses, and investigation of psychic phenomena were but a few of the subjects with which he dealt. His work, moreover, in many cases was a starting-point of important modern developments. Knighted in 1897, he received the Order of Merit in 1910, and during 1913-14 served as president of the Royal Society.

April 6, 1829. Niels Henrik Abel died.—Still under twenty-seven years of age when he died, Abel held a place among the greatest mathematicians of his day. His main work related to the theory of elliptical functions.

April 6, 1913. Adolf C. H. Slaby died.—The inventor with Count Arco of a system of wireless telegraphy, Slaby made his first successful experiments in 1897 in the Royal Gardens on the Havel.

E. C. S.

Societies and Academies.

LONDON.

Royal Society, March 17.—Prof. C. S. Sherrington, president, in the chair.—Lord **Rayleigh**: The colour of the light from the night sky. Photographic exposures were made under coloured media selected for isolating various parts of the spectrum. Comparison with direct sunlight or moonlight showed that the night sky was of the same quality as these. Visual comparisons through coloured films showed that a blue film, which was equally bright with a yellow one against the night sky, was brighter against the twilight sky. These comparisons were not embarrassed by colour differences, because the light was so faint as to give purely monochromatic vision. The requirements as regards colour and polarisation of the light would be satisfied if we regarded it as coming from an unresolved background of stars. They would equally be satisfied if we regarded it as due to sunlight scattered by meteoric matter.—R. O. **Street**: The dissipation of energy in permanent ocean currents, with some relations between salinities, temperatures, and currents. On the assumption of slow, non-turbulent motion a formula for the mean rate of energy dissipation in permanent ocean currents is obtained which, when integrated over the whole of the oceans, gives a dissipation at the mean rate of approximately 3×10^{18} ergs per second. Simple relations between the strength of the current, the salinity, and the temperature of the water are also found; satisfactory estimates of the currents in mid-ocean can thus be made.—S. **Datta**: The vacuum arc spectra of sodium and potassium. Definite improvements in the measures for the spectra of sodium and potassium have been obtained by the use of sodium and potassium vapour lamps as sources. With potassium an interesting combination pair indicating satellites to the diffuse series has been observed. The presence of potassium in the sun has been established, and some additional sodium lines have been identified with solar lines.—W. E. **Garner** and C. L. **Abernethy**: Heats of combustion and formation of nitro-compounds. Part I.: Benzene, toluene, phenol, and methylaniline series. In this paper the heats of combustion of all the isomerides of the mono-, di-, and tri-nitro-toluenes and -benzenes, together with a number of nitro-derivatives of phenol and methylaniline, have been determined, and the heats of formation and nitration calculated. The heats of formation and nitration of the isomerides of the di- and tri-nitro-toluenes and -benzenes show considerable variation, the values tending to a minimum when the nitro-groups are adjacent to one another or to a methyl group. The heats of formation in any series increase to a maximum value with the introduction of the nitro-groups, which is reached in the toluene, phenol, and methylaniline series (when symmetrical substitution takes place) at the dinitro-derivative. The introduction of the methyl group into benzene modifies only slightly the shape of the curves showing the heats of formation of the derivatives, but the hydroxyl or methylaniline group has a much greater effect.—E. K. **Rideal**: The catalytic dehydrogenation of alcohols. Application of the approximation formula of the Nernst heat theorem to the equilibria:

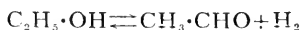

and

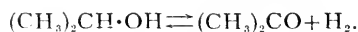

The variation of the dissociation constants with the temperature was determined by means of a constant-volume gas thermometer containing reduced copper as catalytic material. The velocity of decomposition of

the alcohol at the surface of the solid catalyst was found to be much more rapid than the reverse bimolecular reaction. Concordant values for the equilibrium constants at various temperatures could be obtained only at low pressures.

Geological Society, March 9.—Mr. R. D. Oldham, president, in the chair.—W. B. R. **King**: The surface of the marls of the Middle Chalk in the Somme Valley and the neighbouring districts, and the effect on the hydrology. Chalk forms the main deposit of the area; water was obtained for troops largely from boreholes made by the percussion method. The great number of bores enables one to construct a map of the contours of the marl-surface. These curves show that (1) the main anticlinal crest (axis of Artois) is not continuous, but consists of a series of curved axes arranged *en échelon*; (2) the close relationship of the river-systems to the tectonic axes; and (3) the capacity of the Chalk to yield water for boreholes measuring about 6 in. in diameter depends more on the topography of the neighbourhood than on the larger tectonic features, provided about 50 ft. of chalk occurs between the marl-surface and the surface of the water-table in the Chalk.—Dr. Gertrude L. **Elles**: The Bala country: its structure and rock-succession. The detailed mapping of the beds, as now classified, has brought out the structure of the country, and a modification of views previously held with regard to the Bala fault seems to be necessary. It appears to be one of a series of compressional faults affecting the whole of the country south-east of Bala Lake. The initiating structural factor was probably compression of the rocks as a whole against the Harlech Dome, controlled by the resistance offered by the Ordovician volcanic mass to the compressional force. The country was first folded, and then affected by thrust-movements. The six main structural lines of displacement are given. Combined with these major displacements there has been much differential minor thrusting (tears), which is most conspicuous above the Llangower thrust. Comparison is made between the succession here seen and that of other areas in Great Britain, and the faunal features are noted and tabulated.

Zoological Society, March 8.—Sir S. F. Harmer, vice-president, in the chair.—E. G. **Boulenger**: Experiments on colour-changes of the spotted salamander (*Salamandra maculosa*) conducted in the society's Gardens.—Miss Joan B. **Procter**: The variation of the scapula in the Batrachian groups Aglossa and Arcifera.—Dr. W. T. **Calman**: Notes on marine wood-boring animals. II.: Crustacea.—Dr. A. A. **Christie-Linde**: The reproductive organs of the Ascidian *Kükenthalia borealis*, Gottschaldt.—B. P. **Uvarov**: The geographical distribution of Orthopterous insects in the Caucasus and in Western Asia.

PARIS.

Academy of Sciences, March 7.—M. Georges Lemoine in the chair.—G. **Lippmann**: The determination of the axis of rotation and the velocity of rotation of a solid body, and the realisation of a solid body without rotation.—M. **de Sparre**: The maximum yield of turbines.—G. **Julia**: The variation of the function which furnishes the conformal representation of an area on a circle when the contour of the area varies.—B. **Gambier**: Articulate deformable systems and couples of surfaces deduced from them.—A. **Talon**: The reversal of the stresses in bridge lattice bars.—R. **Feret**: The law of equilibrium of solid grains in a vertical ascending current of water. Experiments on the relation between the linear dimensions of solid

particles and the velocity of currents of water maintaining the particles in suspension. Six different minerals were used, and it was found that when the section of the particles was small compared with that of the tube, Stokes's law was applicable.—**A. Perot**: Measurement of the pressure of the solar atmosphere in the magnesium layer and the verification of the principle of relativity.—**H. Soulan**: The influence of light on the conductivity of fluorescent liquids.—**P. L. Mercanton**: The application of stereoscopic vision to the control of glacial variations. The application of stereoscopic vision to two photographs taken with the same camera and from the same spot at an interval of a year showed clearly the changes in the Orny glacier.—**M. Pauthenier**: New applications of the method of charges of very short duration and instantaneous lighting.—**F. Michaud**: Study of the energy of a system of currents.—**H. Chipari**: The apparent mutual actions of magnets and currents plunged in a magnetic liquid.—**J. Barbaudy**: The properties of diagrams. Curves representing the displacement of equilibrium of chemical systems.—**P. Chevenard**: The action of additions on the expansion anomaly of the ferro-nickels; application to the iron-nickel-chromium alloys. The hypothesis of the formation of the compound Ni_2Cr_3 serves to explain the marked effect exerted by chromium on the expansion anomaly of the ferro-nickels.—**S. Posternak**: The systematic nomenclature of the molybdates. A criticism of a recent communication by Forsén on the same subject.—**E. Toporescu**: The removal of lime and magnesia from solution by precipitates of chromium hydroxide. The limiting quantities removed are those corresponding to the formation of $3CaO.Cr_2O_3$ and $3MgO.Cr_2O_3$. Both the lime and magnesia can be removed by washing the precipitate with boiling 5 per cent. solution of ammonium nitrate.—**M. Legrand**: The estimation of maltose and lactose in presence of other reducing sugars. Use of Barfoed's solution. Details of the method are given, with examples of its application to the study of the products of the germination of seeds and to the analysis of milk.—**R. Chudeau**: The changes in the climate of the Sahara during the Quaternary period.—**R. de Litardière**: The dimorphism of the chromosome elements in *Polybodium Schneideri* during the telophase and interphase periods.—**H. Coupin**: A stem with horizontal geotropism. With certain species of lentil cultivated in the dark the stems grow in the horizontal direction. If, after the stem has commenced to grow, it is placed vertical, fresh growth is still horizontal. If the seeds germinate in daylight the stem grows vertically.—**L. Daniel**: Grafts of the sunflower on the Jerusalem artichoke.—**J. Dufrenoy**: The influence of the temperature of the thermal waters of Luchon on their flora. Only the thio bacteria of very small diameter can live in the hottest springs (50° to 62° C.). The formation of sulphur is especially marked between 40° and 50° C.—**E. Chemin**: The action of a parasitic fungus on *Dilesea edulis*.—**L. Bordas**: The general morphology and structure of the digestive apparatus of the Lepidoptera.—**I. Fage**: Some spiders without pulmonary sacs. A description of the spider *Telema tenella*, found in the St. Mary Cave, near La Preste, in the eastern Pyrenees. This spider is blind, and the lungs are replaced by trachean stigmata. The author in 1913 put forward the view that *T. tenella* was the survivor of an extinct fauna, and this is confirmed by the discovery by MM. Alluaud and Jeannel in eastern Africa of a new form, *Apneumonella*.—**L. Bertin**: Preliminary note on the idea of species and variability in the sticklebat.—**A. Peyron**: Tumours of the interstitial gland of the testicle of the horse.

Books Received.

Imperial Mineral Resources Bureau. The Mineral Industry of the British Empire and Foreign Countries (War Period): Zinc. (1913-1919.) Pp. 112. (London: H.M. Stationery Office.) 3s. 6d. net.

The Great Riddle; or, The Action and Effects of Natural Forces and Conditions in the Creation. By Frank Horrridge. Pp. vii+99. (London: Kegan Paul and Co., Ltd.; New York: E. P. Dutton and Co.) 3s. 6d. net.

The Soils and Agriculture of the Southern States. By Hugh H. Bennett. Pp. xviii+399+plates. (New York: The Macmillan Co.; London: Macmillan and Co., Ltd.) 18s. net.

Camping and Woodcraft: A Handbook for Vacation Campers and for Travelers in the Wilderness. By Horace Kephart. Vol. i.: Camping. Pp. 405. (New York: The Macmillan Co.; London: Macmillan and Co., Ltd.) 14s. net.

Elementary Calculus. By Prof. William F. Osgood. Pp. ix+224. (New York: The Macmillan Co.; London: Macmillan and Co., Ltd.) 12s. 6d. net.

Yarn and Cloth Making: An Economic Study. By Mary L. Kissell. Pp. xxvii+252. (New York: The Macmillan Co.; London: Macmillan and Co., Ltd.) 10s. net.

When Buffalo Ran. By George B. Grinnell. Pp. 114. (New Haven: Yale University Press; London: Oxford University Press.) 10s. 6d. net.

A First Grammar of the Adamawa Dialect of the Fulani Language (Fulfulde). By F. W. Taylor. Pp. 135. (Oxford: Clarendon Press.) 10s. 6d. net.

Three Lectures on Fermat's Last Theorem. By L. J. Mordell. Pp. vii+31. (Cambridge: At the University Press.) 4s. net.

Set of Cards for Teaching Chemical Formulæ and Equations. Devised by Mrs. M. Partington. (London: Baird and Tatlock, Ltd.) 1s. 4d.

Imperial Department of Agriculture for the West Indies. Sugar-cane Experiments in the Leeward Islands. Report on Experiments Conducted in Antigua and St. Kitts-Nevis in the Season 1918-19. Part i.: Experiments with Varieties of Sugar-cane. Part ii.: Manurial Experiments with Sugar-cane. Pp. 62. (Barbados: Imperial Commissioner of Agriculture.) 1s.

Air Ministry: Meteorological Office. Report of Proceedings of the Third Meeting of the Commission for Weather Telegraphy, held at the Air Ministry, London, November 22-27, 1920. (M.O. 242.) Pp. 116. (London: H.M. Stationery Office.)

Gesammelte Arbeiten von Rudolf Mewes. I. Abteilung: Raumzeitlehre oder Relativitätstheorie in Geistes- und Naturwissenschaft und Werkkunst. Heft 1: Wissenschaftliche Begründung der Raumzeitlehre oder Relativitätstheorie (1884-94) mit einem geschichtlichen Anhang. By R. Mewes. Pp. 110. 18 marks. Heft 3: Anwendung auf Mechanik und Thermodynamik (Wärmeleitung und Relative Bewegung) 1884-85; nebst Anhang. I. Teil. By R. Mewes. Pp. 64. 8 marks. Heft 4: Anwendung auf die Physik des Aethers (Kraft und Masse) Neuausgabe der Schrift vom Jahre 1892. I. Teil. By R. Mewes. Pp. 134. 18 marks. Heft 5: Anwendung auf die Physik des Aethers (Kraft und Masse) Neuausgabe der Schrift vom Jahre 1894. II. Teil. By R. Mewes. Pp. 160. 20 marks. Heft 7: Anwendung auf Mechanik und Thermodynamik (Fortpflanzungsgeschwindigkeit der Schwerkraftstrahlen) Neuausgabe der Schrift vom Jahre 1896. II. Teil. By R. Mewes. Pp. 95. 8 marks. (Berlin: Rudolf Mewes.)

Diary of Societies.

THURSDAY, MARCH 31.

INSTITUTE OF METALS (at Shaftesbury Hotel, Great St. Andrew Street, W.C.2), at 8.—S. L. Archbutt: Aluminium Alloys.

FRIDAY, APRIL 1.

ROYAL SOCIETY OF MEDICINE (Laryngology Section), at 4.45.
ROYAL SOCIETY OF MEDICINE (Anæsthetics Section), at 8.30.—Dr. R. L. M. Wallis and Dr. C. L. Hewer: A New General Anæsthetic: Its Theory and Practice.

SATURDAY, APRIL 2.

GILBERT WHITE FELLOWSHIP (at 6 Queen Square, W.C.1), at 3.—Sir David Prain: Natural History (Presidential Address).

MONDAY, APRIL 4.

VICTORIA INSTITUTE (at Central Buildings, Westminster), at 4.30.—W. Hoste: Fetishism in Central Africa and Elsewhere.
SOCIETY OF ENGINEERS (at Geological Society), at 5.30.—Lieut. J. C. Ferguson: The Motor-car Pneumatic Tyre.

ROYAL INSTITUTE OF BRITISH ARCHITECTS, at 8.—Sir Lawrence Weaver: The Land Settlement Building Work of the Ministry of Agriculture and Fisheries.

ARISTOTELIAN SOCIETY (at University of London Club, 21 Gower Street), at 8.—Prof. J. Laird, Dr. G. E. Moore, Prof. C. D. Broad, and Prof. G. Dawes Hicks: Symposium on The Character of Cognitive Acts.

SOCIETY OF CHEMICAL INDUSTRY (London Section) (at Chemical Society), at 8.

ROYAL GEOGRAPHICAL SOCIETY (at Æolian Hall), at 8.30.—A. W. Gomme: The Scenery of Greece.

ROYAL SOCIETY OF MEDICINE (Tropical Diseases and Parasitology Section), at 8.30.—Dr. W. B. Alcock: Laboratory Observations on Pensioners who Contracted Malaria in the Late War.—Dr. H. C. Lucey: Observations Bearing on the Reliability of the Large Mono-nuclear Leucocyte Count as an Aid to the Diagnosis of Malaria.

TUESDAY, APRIL 5.

ROYAL INSTITUTION OF GREAT BRITAIN, at 3.—Prof. R. A. Sampson: Present Position of the Nebular Hypothesis.

ROYAL HORTICULTURAL SOCIETY, at 5.—Informal Conference on Plants in Flower at the Time.

INSTITUTION OF CIVIL ENGINEERS, at 5.30.—L. H. Larmuth: Airship Sheds and their Erection.

ROYAL SOCIETY OF MEDICINE (Surgery: Sub-section of Orthopædics), at 5.30.

ZOOLOGICAL SOCIETY OF LONDON, at 5.30.

ROYAL PHOTOGRAPHIC SOCIETY OF GREAT BRITAIN, at 7.—C. M. Thomas: Chemical Methods in Photography.

ROYAL SOCIETY OF MEDICINE (Pathology Section) (at Institute of Pathology, Charing Cross Hospital Medical School), at 8.30.—W. S. Cole and Dr. W. J. Adie: The Quantitative Analysis of the Gastric Contents.—W. S. Cole and Miss J. Aynon: Observations on Post-operative Ketosis.—J. E. Barnard: A Method of Demonstrating the Structure of Bacteria.—Dr. A. B. Rosher: The Agglutinins Present in Normal Sera for B. Enteritidis (Gaertner) and for Bacilli of the B. Supestifer Group.—Dr. G. S. Wilson: Some Points in the Technique of Counting Viable Bacteria.—Dr. H. B. Weir and Dr. W. J. Adie: (a) Infarct of Spleen, followed by Rupture and Hemorrhage; (b) Gumma of Heart, with Hemorrhage Causing Acute Heart-Block.—Dr. W. W. C. Topley, J. E. Barnard, and Dr. G. S. Wilson: A New Technique for Obtaining Bacterial Cultures from a Single Cell.—Dr. W. W. C. Topley and Dr. H. B. Weir: Demonstration of the Lesions found in Some Epidemic Diseases of Mice.—Dr. W. W. C. Topley: The Relation of B. Enteritidis (Gaertner) to Bacilli of the B. Supestifer Group.

WEDNESDAY, APRIL 6.

FARADAY SOCIETY, IRON AND STEEL INSTITUTE, INSTITUTION OF MECHANICAL ENGINEERS, AND INSTITUTE OF METALS, ETC. (at Institution of Mechanical Engineers), at 2.30, 5, and 8.—Joint General Discussion on Failure of Metals under Internal and Prolonged Stress.—Dr. W. Rosenhain: Introductory Address.—Prof. C. H. Desch: Chemical Influences in the Failure of Metals under Stress.—L. Archbutt: Failure of the Lead Sheathing of Telegraph Cables.—Dr. W. H. Hatfield: Mechanism of Failure in Metals from Internal Stress.—J. C. W. Humphrey: Internal Stresses in Relation to Micro-structure.—R. H. N. Vaudrey and W. E. Ballard: Internal Stresses in Brass Tubes.—Dr. F. Rogers: Effects of Prolonged Stress on Metals at High Temperatures.—R. W. Woodward: Corrosion-cracking of Non-Ferrous Materials.—Sir Henry Fowler: Notes on Fractures in Locomotive Boiler Tubes.—D. Hanson: Inter-crystalline Failure in Steel.—J. A. Jones: Inter-crystalline Cracking of Mild Steel in Salt Solution.—H. S. Rawdon: The Presence of Internal Fractures in Steel Rails and their Relation to the Behaviour of the Material under Service Stresses.—H. Moore: The Season-cracking of Brass: Digest of Published Information.—H. Moore and S. Beckinsdale: The Removal of Internal Stress in Brass.—O. W. Ellis: Experiences of Season-cracking during the War.—Dr. F. Rogers: Stress and Season-cracking in Cold Worked Brass Articles.—W. C. Hother-sall: The Spontaneous Cracking of Necks of Small Arm Cart-ridge Cases.—J. Arnott: Note on Phosphor Bronze Bars.

ENOMOLOGICAL SOCIETY OF LONDON, at 8.
SOCIETY OF PUBLIC ANALYSTS AND OTHER ANALYTICAL CHEMISTS (at Chemical Society), at 8.—F. G. H. Tate and J. W. Pooley: Detection and Estimation of Illipé Nut Fat used as a Substitute for Cocoa Butter.—T. F. Harvey and S. Baek: The Estimation of Starchine in Scale Preparations containing Quinine and other Cinechona Alkaloids.—Dr. S. Mallaneh: A Colour Reaction for Aconite.—J. L. Lizius: A Method for the Determination of the Acidity of Coloured Solutions.

ROYAL SOCIETY OF ARTS, at 8.—Prof. A. Barr: The Optophone: An Instrument for enabling the Blind to Read Ordinary Print.

THURSDAY, APRIL 7.

ROYAL INSTITUTION OF GREAT BRITAIN, at 3.—C. T. R. Wilson: Thunderstorms (Tyndall Lectures).

LINNEAN SOCIETY, at 5.—Reginald A. Malby: A Miniature Alpine Garden from January to December.—H. W. Monckton: Exhibition of Various Forms of *Taraxacum erythrospermum*, Andr.

CHILD-STUDY SOCIETY (at Royal Sanitary Institute), at 6.—M. Dainow: Original Research in Vocational Tests.

INSTITUTION OF ELECTRICAL ENGINEERS (at Institution of Civil Engineers), at 6.—K. Baumann: Some Recent Developments in Steam Turbine Practice.

CHEMICAL SOCIETY (at Institution of Mechanical Engineers), at 8.—Dr. F. W. Aston: Mass Spectra and Atomic Weights.

FRIDAY, APRIL 8.

ROYAL ASTRONOMICAL SOCIETY, at 5.

PHYSICAL SOCIETY OF LONDON (at Imperial College of Science), at 5.—Dr. W. J. H. Moll: A New Registering Microphotometer, University of Utrecht.—Sir William Bragg: The Examination of the Structure of Crystals in the Form of Powder by Means of the Ionisation Spectrometer.—H. Parry: A Balance Method of Using the Quadrant Electrometer for the Measurement of Power.

ROYAL SOCIETY OF MEDICINE (Clinical Section), at 5.30.—Dr. Ivor Davies: Hair Ball or Hair Cast of the Stomach and Gastro-Intestinal Tract. A Report of Two Cases with Specimens, and an Abstract of 108 Cases from the Literature.—Dr. M. Cassidy: Report *re* Case of Neoplasm of Lung.

ROYAL INSTITUTION OF GREAT BRITAIN, at 9.—Dr. R. H. A. Plimmer: Quality of Protein in Nutrition.

SATURDAY, APRIL 9.

ROYAL INSTITUTION OF GREAT BRITAIN, at 3.—Dr. M. H. Dale: Poisons and Antidotes.

CONTENTS.

	PAGE
Inventions and Grants in Aid	129
The Embryology of Crinoids. By Dr. F. A. Bather, F.R.S.	132
Electrical Theory and Relativity. By A. R.	133
Mathematical Text-books. By H. B. H.	134
Our Bookshelf	136
Letters to the Editor:—	
The Common Occurrence of Aurora in the South of England.—Right Hon. Lord Rayleigh, F.R.S.	137
Mount Everest.—Lt.-Col. H. H. Godwin-Austen, F.R.S.	137
Molecular Size and Range of Molecular Attractions in Solutions. (<i>With Diagrams.</i>)—Prof. J. B. Leathes, F.R.S.	138
Oceanographic Research in the British Empire.—Dr. N. Annandale and Major R. B. Seymour Sewell	139
The Sound of Distant Gun-fire.—Capt. C. J. P. Cave	140
Sound Transmitted through Earth.—Reginald G. Durrant	140
X-rays and their Physiological Effects.—A. B. Bruce Greenland in Europe.—David MacRitchie	141
The Peltier Effect and Low-temperature Research.—Dr. Geoffrey Martin	141
Relativity and the Velocity of Light.—C. O. Bartrum	141
Stellar Magnitudes and their Determination. I.—Apparent Magnitudes: (a) Visual. (<i>With Diagrams.</i>) By H. Spencer Jones	142
The Development and Spread of Civilisation. By W. J. Perry	146
Obituary	148
Notes	148
Our Astronomical Column:—	
Pons-Winnecke's Comet	153
Comet Reid 1921a	153
Large Detonating Fireball	153
The Origin of the South-west Monsoon. By Dr. G. C. Simpson, F.R.S.	154
The Finsbury School of Chemistry. By Prof. G. T. Morgan, F.R.S.	154
Bacterial Diseases of Farm Crops. By W. E. B.	155
Fatigue and Efficiency in the Iron and Steel Industry	156
University and Educational Intelligence	156
Calendar of Scientific Pioneers	157
Societies and Academies	158
Books Received	159
Diary of Societies	160



THURSDAY, APRIL 7, 1921.

Editorial and Publishing Offices:

MACMILLAN & CO., LTD.,

ST. MARTIN'S STREET, LONDON, W.C.2.

Advertisements and business letters should be
addressed to the Publishers.

Editorial communications to the Editor.

Telegraphic Address: PHUSIS, LONDON.

Telephone Number: GERRARD 8830.

Standardisation of Vaccines, Toxins, and Antitoxins.

WE referred last week to the special measures proposed by Sir Mackenzie Chalmers's Committee for the control of the quality and authenticity of vaccines, toxins, antitoxins, salvarsan, and certain other drugs. What is there in the special circumstances of our time to justify a closer superintendence of the many new therapeutic substances now in common medical use? It might well have been supposed that in the vast technical developments of the last half century "big business" had, through the sheer excellence of its scientific methods, reached a plane where further public control was superfluous. Over a large area of the drug field this is true. If we look back for half a century we can trace, since the medical Acts, a steady growth in the technical standardisation of all the drugs used in medicine. The British Pharmacopœia itself came into existence because experimental pharmacology showed the need for precision of dosage and the consequent standardisation of drugs. The demand made by scientific medicine evoked the best powers of scientific chemistry. To-day there are few fields of applied science that can show greater precision of practice than the drugs now used as therapeutic substances. Standardisation, therefore, and control in one degree or another are accepted methods of securing the consumer not merely against fraud,

but also against inertness and inefficiency in chemical medicines.

But within the half century there have arisen other products not capable of easy standardisation. It is only some thirty years since Koch produced his first "tuberculin." To those who remember the wild rush to Berlin to secure the magic poison and to inject it without afterthought, the memory is full of horror. The damage done by the indiscriminate use of tuberculin alone would justify severe restrictions on the use of all such toxins, and the antitoxins had also to pass their trial. It is only twenty-five years since von Behring's diphtheria antitoxin was given to the world. Immediately, in this and other countries, von Behring's processes of production were imitated, sometimes without his exactness of technique, and the result was here and there a serious disaster. For even the large firms had not evolved the superb machinery they now command, and every person that used the new antitoxin did so with uncertainty and misgiving. Steadily, as methods improved, standards of potency and purity improved with them. Fortunately, diphtheria antitoxin from the beginning was capable of very exact standardisation by controllable units. It was the model for all later antitoxic serums. Of such serums many have since been produced, and some have succeeded as cures. But still more recently the treatment by vaccines has grown by leaps and bounds.

When Koch's tuberculin, which is really a dead-germ vaccine, appeared, many of the "elder statesmen" of medicine prophesied a period of specialised vaccines of endless variety. The period is now upon us. The refinements of technique are almost incredible. Smallpox vaccine was for a century the pioneer. To-day every common cold has its vaccine. This is because bacteriology has been active, methods have grown in scientific precision, and clinical medicine has come to understand the therapeutic value of biological products. But these products vary in potency, in purity, and in danger. In careless hands they may do immense harm; in skilled hands, immense good. But if widespread use and possible occasional danger are relevant grounds for control, the case for the control of these biological products is as strong as the case for the control of other potent and dangerous drugs.

The Committee's remit covered, however, other substances perhaps as dangerous. Salvarsan is a type of product that cannot be adequately tested by direct chemical means. Its toxicity is a primary

factor, and this cannot be tested except biologically. During the war, on account of difficulties with imported salvarsan and its analogues, special provision was made for testing and standardisation. The Medical Research Council undertook the necessary work, and the history of the uses of salvarsan and its substitutes is one of the most striking chapters in the records of the war. What the war started this Committee proposes to continue.

Standardisation, therefore, of biological products and of the more dangerous chemical toxic drugs is loudly called for. As early as 1909 the General Medical Council approached the Government with the suggestion for "the establishment of a public institution for the pharmacological standardisation of potent drugs and of serums." The Medical Research Council within the last few years has actually carried out a certain amount of standardisation. The recommendations of Sir Mackenzie Chalmers's Committee are really only giving effect to views accepted both by scientific experts and by scientific manufacturers. The primary recommendations are that such products as we have named should be subject to supervision and control; that the controlling authority should be the committee of the Privy Council which at present controls the Medical Research Council; that this committee should decide from time to time what substances are to be brought under control and prescribe the methods of standardisation and testing; that the controlling authority should have to assist it an advisory committee representative of the different sections of the kingdom, as well as of the Navy and Army, the General Medical Council, the Medical Research Council, and the Pharmaceutical Society; that there should be a central laboratory under the management of the Medical Research Council for the preparation and maintenance of standards and the testing of market products; that control should include the licensing of manufacturers, the inspection of plant, premises, and processes, and the testing of the finished products; that the primary responsibility for seeing that products conform to standard should lie with the manufacturers; that test samples should be taken from time to time, and also that manufacturers should be required on occasion and for a period to furnish samples of every batch of a substance made. It is also suggested that imported products of the same order should be admitted only by licence, and subjected to equal tests.

In these recommendations and in the argument justifying them we find nothing that should inter-

fere illegitimately with the well-established methods of private enterprise. Indeed, the Committee, in its recommendations, has the support of the leading manufacturing firms, which, with certain slight qualifications, welcome appropriate inspection and standardisation. The draft Bill embodies the recommendations in a workable form. It may require modification in detail, but in principle it seems adequate. It combines a sufficiency of central control with the minimum of trade restriction.

British Dyestuffs Corporation.

THE situation in which the directorate of the British Dyestuffs Corporation finds itself is a remarkable one. At the registration of this company in May, 1919, as a result of amalgamating British Dyes, Ltd., of Huddersfield, with Messrs. Levinstein, Ltd., of Blackley, the appointment of Sir Joseph Turner as commercial managing director, and of Dr. Herbert Levinstein as technical managing director, was designed to maintain the interests of both groups, and to benefit the united enterprise by the special contribution of knowledge and experience which each of these gentlemen was expected to make. At the meeting of shareholders in Manchester on Friday last it was announced that Sir Joseph Turner and Dr. Levinstein, while retaining their seats on the board, have been superseded as managing directors by Sir Henry Birchenough, the chairman of the corporation, Sir William Alexander, and Mr. Vernon Clay.

It is no reflection on the new managing directors to express the opinion that the position thus disclosed must arouse grave misgiving amongst all those who recognise the foundation of a self-supporting synthetic dyemaking industry as a matter of the greatest national importance. Disregarding the woeful absence of harmony which appears to be indicated, the aspect of this rearrangement which causes anxiety to chemists is the fact that, at a time when all the scientific knowledge and commercial energy available in this country should be correlated in a concerted effort to establish an industry which, more than any other, depends for success upon the combination of these factors, two of the most experienced practitioners should be removed from very intimate association therewith.

The proper and perfectly natural request for an investigation put forward by the shareholders met with a cold response from the board, and the

declaration by the chairman that a general meeting is not the occasion for an explanation of such peculiar circumstances is one with which many will sympathise; but the public is entitled to full information at the earliest convenient opportunity. Pending more precise knowledge of the facts, it would not be fair to the late managing directors, or to the board, to pass judgment on their action. If, however, as the published statements at present suggest, incompatibility of temperament is the cause, chemists will regard them as having failed in realising their responsibility to science at a critical juncture; on the other hand, the board can scarcely escape the reproach of having allowed an impossible situation to continue far beyond the point at which a surgical operation had become an obvious necessity. Having regard to the immense scientific and national interests which are involved in the ultimate success of this enterprise, and to the large sum of public money which has been invested in the corporation, its future conduct demands very careful scrutiny.

Alcoholology.

Notes on a Cellar-book. By George Saintsbury. New edition. Pp. xxxi+228. (London: Macmillan and Co., Ltd., 1920.) 7s. 6d. net.

THAT constituent principle of all vinous or spirituous drinks which maketh glad the heart of man, no matter how diverse their origin—and this diversity is something astonishing—is commonly reputed to be alcohol. But since this word, in scientific terminology, has lost its original restricted meaning, and is now used generically to comprehend a multitude of substances, solids as well as liquids, the majority of which are not produced by fermentation, it is desirable to be more precise, and to say that this exhilarating principle is held to be the ethyl alcohol of the chemist. All alcohols are not toxic, although certain of the congeners of ethyl alcohol—such as methyl, propyl, and butyl alcohols—are highly poisonous—far more so, apparently, than ethyl alcohol. On the other hand, glycerin, which is regarded by the chemist as an alcohol, is non-poisonous. Other instances of non-toxic alcohols might be quoted.

The stimulating, as distinct from the toxic, effect on the normal individual of what we usually call alcoholic beverages is a very complex phenomenon. It is partly physiological and partly psychological. To begin with, the liquid must be pleasant, or at least not repugnant,

to the senses. The physiological effect is probably not wholly due to the ethyl alcohol. Perfectly pure ethyl alcohol, in the sense in which the chemist understands the term "pure," is seldom seen, and is certainly never a commercial article. When produced by synthetic processes from inorganic materials it is devoid of all flavour; it is as characterless, indeed, as distilled water. To drink it would afford no pleasure to a sane person. The ethyl alcohol of all fermented liquids, whether they are distilled or not, is accompanied by a variety of substances, such as the alcohols chemically related to ethyl alcohol, as well as ethers, esters, aldehydes, and other products, originally, in the case of wine and cognac, contained in the must or juice of the grape, or, in the case of spirits, derived from the fermented wort of various grains. In the case of liqueurs and cordials, the composition is far more complex by reason of the flavouring or other ingredients present. Some of these may be factitious substances made to simulate natural products, but with widely different physiological properties. The main point is that the substances associated with the ethyl alcohol in wine, beer, spirits, liqueurs, cordials, etc., contribute their effect to the character of the beverage and also to its physiological action; they may, indeed, in certain cases overpower, or mask, that due to the ethyl alcohol alone.

The cult of alcohol is, however, too vast a subject to be treated at greater length in such a notice as the present. It is of an immemorial antiquity. As we are informed, it has occupied mankind at least since the days of Noah, who, in the words of the German song, was certainly "ein frommer Mann," as well as a husbandman. But there were tillers of the ground before the Flood, and even Cain may have planted a vineyard, for it is not expressly stated that Noah was the first to do so. In that case it may have occasioned the first recorded murder, *pace* Prof. Saintsbury, who fails to see any connection between crime and strong drink.

The literature of alcoholology—that is, the literature which treats of the origin, nature, and properties of alcoholic beverages; which sings their praises and extols their benefits; or which, on the other hand, anathematises the wine when it is red, stigmatising it as a mocker, which biteth like a serpent and stingeth like an adder, and which curses strong drink as the source of woe and sorrow, of contention and babbling, of wounds without cause, and redness of eyes—is probably one of the most extensive in the

world. Thousands of volumes have been written upon the subject, and doubtless will continue to be written, for it is of perennial interest, as the book before us testifies.

Prof. Saintsbury does not profess to be more than an amateur alcoholologist. His present treatise, if such it can be termed, has no pretensions to profundity. Serious books on wine, he thinks, have, as a rule, been rather dull, and to be dull on such a subject is worse than a crime—it is a blunder. He discourses freely and pleasantly, and with the lightest possible touch, concerning his reminiscences of the contents of a cellar, accumulated at various times during upwards of half a century, more in the interests of a refined hospitality than of winebibbing and the riotous eating of flesh, as the Wise Man has it. He tells us frankly what he prefers, and on what he sets little store. But he is too wise to be dogmatic. His preferences, he learns, are not always shared by others, and he fears he may occasionally wound worthy feelings by what he writes. To nothing is the old adage, *De gustibus*, etc., more applicable than to a man's drink. The Lord Derby who preferred the gout to a certain brand of sherry would doubtless find people to whom the wine was palatable. Prof. Saintsbury can, however, be emphatic enough at times. He has unmeasured contempt for what he denounces as the dishonesty of the so-called temperance party. To his mind "it is a question whether the most Jesuitical Jesuit of the most heated Protestant imagination has ever outdone a thorough-going temperance advocate in the endless dodgings and windings, suppressions and suggestions of his method." This is *trop de zèle*. There was no occasion to attempt to break a lance with the temperance party. Sensible men will agree with the author that *abusus non tollit usum* is a sufficient reply to what he terms "the unscrupulous exaggeration of partisans," and he would have been well advised to leave it at that. All temperance advocates are not fanatics or faddists, and the opinions of earnest, thoughtful, and conscientious men are worthy of respect. There is such a thing as intemperance in argument as well as in alcohol. Moreover, the spirit of self-denial which actuated thousands of men during the gravest crisis through which this country has ever passed is worthy of a more generous recognition than it receives. Prof. Saintsbury's arguments would have met with very short shrift at the hands of the late Sir Victor Horsley.

These apart, the book affords very pleasant reading, and an idle half-hour may be pleasurably spent in dipping into its pages.

NO. 2684, VOL. 107]

Some Aspects of Psychology.

- (1) *Educational Psychology*. By Dr. Daniel Starch. Pp. xi+473. (New York: The Macmillan Co.; London: Macmillan and Co., Ltd., 1920.) 14s. net.
- (2) *The Psychology of Childhood*. By Dr. Naomi Norsworthy and Dr. Mary Theodora Whitley. (Brief Course Series in Education.) Pp. xix+375. (New York: The Macmillan Co.; London: Macmillan and Co., Ltd., 1920.) 10s. net.
- (3) *Human Psychology*. By Prof. Howard C. Warren. Pp. xx+460. (London: Constable and Co., Ltd., 1920.) 12s. net.
- (4) *Spiritualism and the New Psychology: An Explanation of Spiritualist Phenomena and Beliefs in Terms of Modern Knowledge*. By Dr. Millais Culpin. With an introduction by Prof. Leonard Hill. Pp. xvi+159. (London: Edward Arnold, 1920.) 6s. net.

THOSE who are by nature and training sufficiently eupeptic to digest a diet of well-prepared statistics will find Dr. Starch's "Educational Psychology" (1) to their taste, and will profit by its assimilation. Most English teachers prefer general impressions handed on by tradition from masters of their craft, and endorsed, as they think, by personal experience, to results expressed in coefficients of correlation. But some of them want to know what all this mass of statistical work really comes to, and how far it is helpful as a guide to practice. The author goes far to meet their requirements. After outlining the nature of the problems that arise, he deals (i) with the native equipment of human beings, and (ii) with the psychology of learning, first "in general," and then in the case of sundry recognised school subjects.

The reader will probably turn with special interest to the treatment of certain large questions such as the inheritance of mental traits and the transference of training. As a result of a review of the statistical evidence so far to hand, Dr. Starch concludes that the ultimate achievement of any given individual is due to his inherited ability probably to the extent of from 60 to 90 per cent. and to actual differences in opportunity to the extent of only from 10 to 40 per cent. If, then, nature bears to nurture something like the proportion of three to one, and if there is but little statistical evidence in support of the cherished belief that the outcome of nurture in one generation is so transmitted as to contribute to the inherited nature of the next, it might seem that the rôle of the teacher is less important than he is apt to

claim. But one must remember that the proportion of inherited nature *that is actually realised* in any given individual depends in large measure on his nurture through education. That is where opportunity comes in. It may be true enough that equal opportunities for all do not produce equal abilities in all. None the less, educational opportunity does raise the realisable value of the inherited bequest in capacity, and that in no slight degree. How much we do not know.

As to transference, it is assumed on the "formal discipline" view that training of one sort affects capacities of other sorts, irrespective of identical elements, or of similarity in the activities developed. On the basis of a careful discussion, Dr. Starch concludes that, as a general estimate in the case of closely allied subjects, there is probably from 20 to 30 per cent. of transfer, and from that point down to a very small proportion or none in the case of subjects which have little in common. The book abounds in detail which is worthy of careful study. Few who follow the treatment with understanding and critical judgment can fail to profit in the practice of their profession.

"The Psychology of Childhood" (2) is a contribution to the Brief Course Series in Education published under the editorial supervision of Dr. Paul Monroe. Dr. Naomi Norsworthy, who began the work, and Dr. Mary Theodora Whitley, who has completed it since the death of her colleague, reflect the influence of Prof. Thorndike in the Teachers College of Columbia University, the scene of their activities. The text-book is written with a view to its use in normal schools, and presupposes some knowledge of general psychology. Statistics are freely used, and a section is devoted to the methods adopted in their employment; but the treatment, on the whole, is on lines which are sanctioned by custom, with chapters on sense perception, memory, imagination, habit formation, play, and so forth. Although the lines are familiar, there is a good deal of freshness and individuality. English teachers will read it with profit, but should do so, perhaps, with discretion. For the basis is, in the main, frankly physiological. The inheritance of an individual is in terms of structure in the nerve-system, not in terms of mental states. A baby is not heir to any ideas; he does not even inherit consciousness as such; what he does inherit is a complicated system of neurones acting and developing in accordance with certain laws of growth. A child acts as a human being rather than as an animal because he inherits a human nervous system. No matter

how general a mental trait may be, no matter how minute its character, it is dependent on some connection of the neurones. Possibly Dr. Drever in Edinburgh might suggest to teachers in training some modification of the principles that are current in Columbia University.

It is quite clear from Prof. H. C. Warren's "Human Psychology" (3) that definitions advanced in Princeton would not find ready acceptance at St. Andrews. That is part of the trouble in this field of exposition. If in half a dozen text-books on physics, or works in which physical concepts play a leading part, we found not only such a word as "acceleration," but even the word "physical," used in half a dozen different senses, we should be perplexed and perturbed. Unfortunately, something like this state of matters obtains in psychology. By "conation" Prof. Stout means this; Prof. Alexander that; Prof. Warren something else. For Prof. Titchener it has no scientific meaning. Even the word "mental" is in like case. What is for most psychologists distinctively mental—the flow of *ideas* (somehow defined)—is for Prof. Alexander typically non-mental; and while for some the mind is the "stream of consciousness" (in some sense), for others it is that which gives direction to the stream and, in part at least, makes it flow. Furthermore, the notion that what is mental or psychical is that which is revealed in consciousness—even this is rejected by the exponents of the "new psychology," who urge that its major part is concealed in the unconscious.

Much, of course, depends on the method of approach to the subject, from below through physiology or from above through philosophy. The one (from the other point of view) is either tainted with materialism or tinted by metaphysics. Prof. Warren takes the low-level route from the plains of biology and physiology; and if this method of approach is somewhat out of fashion in England to-day, that is no reason for refusing to one who travels along it with careful steps a patient, if critical, hearing.

For Prof. Warren psychology is the science which deals with the mutual interrelation between an organism and its environment. The interaction between them involves three stages—stimulation, adjustment, and response. Each single interaction is an experience, and the sum-total of such experiences makes up the mental life of the organism. The special structures and types of function which bring about the interaction constitute its mental (or psychical) organisation. The investigation of mental life is the study of experience, whether that experience be accompanied by

any discoverable consciousness or not. Experience may thus include behaviour and consciousness, but need not include the latter. Behaviour, or the action of the organism on its environment, is typically mental (as defined). Consciousness is the subjective accompaniment, or so-called inner aspect, of some, but not of all, modes of behaviour. In the more complex cases of adjustment we know far more about the conscious than the physiological aspect, though we have reason to believe that such an aspect is always present.

The thesis is worked out with commendable consistency; and what G. H. Lewes would have called the metempirical factor is rigorously excluded. One cannot here enter into details or follow up the definitions which the method of treatment carries with it. Since, however, conation bulks so large in much current English discussion, attention may be directed to the attenuated form it here assumes. "We may define conation as the mental state which accompanies any involuntary or automatic movement or any bodily position of which we are aware." It is simply the conscious correlate of behaviour itself. The place, if any, of consciousness in the causal nexus is not discussed.

Dr. Culpin's "Spiritualism and the New Psychology" (4) purports to give an explanation of spiritualist phenomena and beliefs in terms of modern knowledge. By modern knowledge is meant that version of Freudian hypothesis (as presented by Dr. Bernard Hart in his "Psychology of Insanity") which is recapitulated in the first four chapters. The book is brightly written, is flavoured with the spice of satire, and contains much criticism that is not only clever, but also pertinent and acute. It will do much to strengthen the conviction of those who are already convinced. Whether it will alter by a hairbreadth the belief of sundry others is open to question. Still, the missionary effort is warmly commended by Prof. Leonard Hill in an able introduction.

A touch of piquancy marks the position which Dr. Culpin seeks to defend. On one hand, there are certain phenomena which look *as if* disembodied spirits were concerned in their manifestation. On the other, there are certain phenomena which look *as if* memories were stored in "the unconscious." The author argues that wholly erroneous beliefs are founded on the former "as if," and that in the light of "modern knowledge" a valid explanation of them may be given in terms of the latter "as if," supplemented by one or two more of like nature. Whether "memories" in the unconscious are embodied or disembodied, and in what manner they are "stored," are problems

on which no light is thrown. Now a crucial question for scientific thought is this: What is the justification in any given case for passing from "as if" to "is"? No doubt we all jump with fatal facility from one to the other, and fail to realise that "of course it obviously stands to reason that it must be so" falls very far short of "it is so." Dr. Culpin thinks that there is no justification for the *saltum mortale* of the spiritualist. Does he adequately justify his saltatory acceptance of memories, ideas, wishes, thoughts, and the rest, in the unconscious? He must, too, be well aware that there is another "as if" which puts in a claim to be an "is." Thus Prof. Warren (3) says:—

"The popular notion of memory is based upon too close an analogy with perception. Objects in the environment continue to exist even when we do not perceive them. Popular psychology assumes that 'memory objects' (memory images) persist in much the same way. It is true that something remains in the brain after the sensation ceases, which furnishes the basis for future memory images. But what remains is not a 'picture' of the object or event, but merely a record; it is a trace or set or retention effect of some sort in the structure of the neurones or synapses."

There are thus at least three "as ifs" which put in a claim for acceptance—that of Sir Oliver Lodge, that of Dr. Culpin, and that of Prof. Warren. The author's attitude towards Sir Oliver Lodge and his school is clear enough. One would like to know with greater definiteness his attitude towards Prof. Warren and his school. But perhaps their tenets do not fall within "modern knowledge."

C. LL. M.

Physiology for Students.

Essentials of Physiology. By Prof. F. A. Bainbridge and Prof. J. Acworth Menzies. Fourth edition. Pp. viii+497. (London: Longmans, Green, and Co., 1920.) 14s. net.

THE fourth edition of Profs. Bainbridge and Menzies's work differs but little from the previous one; only a few of the sections have been rewritten. As the authors state in the original preface, their object is "to bring together in a concise form the fundamental facts and principles of physiology." They certainly have succeeded, for they do not waste a word, if we omit the tables inserted in the section on the distribution of the cutaneous sensory nerve-endings. We cannot see that the knowledge of the actual minimal pressure stimuli in various parts of the body is of great importance, and these tables, in

our opinion, could have been omitted with no great loss, especially in a volume of this nature.

In some sections, on the other hand, the conciseness has been rather overdone. The chapter on muscle is somewhat condensed, especially the paragraph dealing with visceral muscle, which, as in many other text-books, is quite overshadowed by the record of experiments on the gastrocnemius of the frog. The paragraph on the reaction of the blood, containing, as it does, an explanation of hydrogen-ion concentration, could have been longer and clearer. This subject is usually a very difficult one for the average student, and requires a good deal of explanation. It would have been wise to devote a full paragraph to a description of what hydrogen-ion concentration means, especially as this term is coming into greater use every day.

The section on the gases of the blood is very full, and contains an account of all the recent work. Barcroft's differential apparatus is figured and explained. A very good feature of the book is the illustration of the text with representative tracings. This, we think, is very important for the proper understanding of a subject like physiology, which is, and always must be, practical. The presence of these typical tracings saves the reader from cramming facts, an obvious danger in such a concise book.

The chapter on the ductless glands is well illustrated by photographs of typical cases showing the effects of withdrawal of the various secretions. This is of advantage, as it impresses on the student the close relationship between physiology and the actual practice of medicine. The chapter makes mention of most of the recent important work in endocrinology—*e.g.* there is noticed the work of the Glasgow school under Prof. Noël Paton in connection with the parathyroids and guanidin.

On the whole, the book ought to prove useful for students going up for their second professional examination, after they have gone through the necessary practical classes.

Our Bookshelf.

Applications de la Photographie Aérienne. By L.-P. Clerc. (Encyclopédie Scientifique.) Pp. vi+350+xii+x plates. (Paris: O. Doin et Fils, 1920.) 7.50 francs.

In the production of aerial photographs the results of diverse scientific investigators have been used, but even when the ideal photograph has been obtained, its value is small without a knowledge of its geometrical properties and of the methods by which it can be most fully employed. The

present work deals mainly with the geometrical problems which form the foundation of the use of air-photographs for precise work, and it is the element of precision which makes the aerial picture so valuable. The book is divided into three parts. The first treats briefly of interpretation, and includes the calculation of the heights of objects from their shadows. The second part deals with stereoscopy, and is of great value. It covers the groundwork of the subject very fully, and will be invaluable in working out metrical methods in practice. The third part deals with metrophotography, and contains many of the results discovered by earlier workers in photo-surveys from balloons, together with new work. The general treatment suggests that the author has been more occupied with the theory of the air-photograph than with the results obtained in practice, and in his introduction he refers rather bitterly to the photographic organisation of the French Services. Whatever may have been the situation during the war, M. Clerc must have the satisfaction of knowing that his unique work will greatly assist the future development of scientific air-photography.

H. H. T.

Essays on Early Ornithology and Kindred Subjects. By J. R. McClymont. Pp. vii+35+3 plates. (London: Bernard Quaritch, Ltd., 1920.) 6s.

THE author has been diving in the rather muddy waters of early ornithology, and displays some of his treasures in a beautifully printed book. Marco Polo's *rukh* holds a position in bird-lore intermediate between the utterly fanciful and the badly misinterpreted, say between the Phoenix and the apodous Birds of Paradise. A mythological stream, taking its rise from the *simourgh* of the Persians, and a matter-of-fact stream, taking its rise from observations on some sea-eagle, united into one, which "floated the conception of the *rukh*." An anonymous narrative of the first voyage (1497) of Vasco da Gama to India contains a reference to the penguins and seals of what is now called Mossel Bay. A hundred years afterwards a scurvy-stricken ship found in an island in the bay "many birds called Pynquins and Sea Wolves, that are taken with men's hands" (the baby *Otaria pusilla*?). The third study deals with the birds of the Banda Islands, where nutmeg-trees flourish; the fourth discusses the etymology of the name "Emu," the suggestion being that the Portuguese changed the Arabic name of the cassowary, "Neâma," into "uma ema." The identification of Australian birds mentioned by Dutch explorers in 1697 and of New Zealand birds observed by Crozet in 1772 has all the fascination of a clever game. Mr. McClymont's studies are what we should call luxuries, but they have the merit of scholarship and brevity. There are three fine plates, showing *Casuarus uniappendiculatus*, Blyth (*juv.*), from the British Museum; Hulsius's figure of an "Eme," an immature cassowary with two

wattles, probably *Casuarium galeatus*, Vieill.; and a Masked or Blue-faced Gannet (*Sula cyanops*, *S. personata*) from the Royal Scottish Museum.

The Elder Edda and Ancient Scandinavian Drama. By Dr. Bertha S. Phillpotts. Pp. xi+216. (Cambridge: At the University Press, 1920.) 21s. net.

THE publication of this important monograph on the Elder Edda furnishes a scientific basis for the interpretation of this collection of primitive Icelandic poetry. Up to the present the attempt to localise these poems by differentiating between the literary and historical outlook of the Norwegians and Icelanders has yielded contradictory results, and the same is true of the effort to establish a relative chronology of the poems by attributing cases of similarity of expression or even of metre to direct imitation. In short, the reliance on philology, and on philology alone, as a key to the problem has proved to be fruitless. The line of investigation now followed, based on recent work in connection with the drama generally, and particularly with that of the Greeks, promises more hope of success. The poems are now shown to have originated in primitive folk-drama, for the existence of which ample evidence is adduced. The Eddic poets failed to secure epical expression because they were hampered by this dramatic tradition. The book is not easy reading, because the author has tried to combine the historical with the literary interpretation, and its completion has been hindered by the loss of some notes and manuscript while she was engaged in war work. It is, however, a fine piece of literary criticism, and the translations of passages in the Edda which form an important part of the text are so good that it may be hoped that the author will supply a complete version of this remarkable collection of early poems.

An Introduction to Bacterial Diseases of Plants. By Erwin F. Smith. Pp. xxx+688. (Philadelphia and London: W. B. Saunders Co., 1920.) 50s. net.

THIS treatise, the first of its kind on the bacterial diseases of plants, is written by a recognised authority, whose work epitomises a considerable part of the history of the subject from the time when Burrill discovered, in 1882, that the fire-blight of apple- and pear-trees is due to *Bacillus amylovorus*. Since that time the number of known bacterial diseases in plants has greatly increased, and such diseases have now been described and studied in a large number of orders of flowering plants, as well as in Cycads and Pinaceæ. The first part of this work deals with the general relations of the bacteria to the host plants, the second part with methods of culture and technique—a field in which the author is a past master—while the main body of the work is devoted to a detailed study of fourteen selected diseases, including *Bacterium campestre*, the cause of black-rot in Crucifers; *Bacillus phytophthorus*, which produces a black-rot in potatoes;

B. amylovorus, and *Bacterium tumefaciens*, the cause of crown-gall in many plants. The last-named produces tumours in the plant which the author, in his pioneer studies of cross-inoculation, has not hesitated to compare with cancer. The work is admirably illustrated, and will be of great service to all who are interested in plant pathology. R. R. G.

Highways and Byways in Northumbria. By P. Anderson Graham. Pp. xviii+380. (London: Macmillan and Co., Ltd., 1920.) 7s. 6d. net.

THIS volume is mainly of architectural and archaeological interest, and should prove a delightful companion to all whose interests lie in those directions. Mr. Graham takes his readers up and down the country, missing little that is quaint or has the romance of age. Naturally, he has much to say about the Roman wall and Holy Island, but the book is well balanced, and shows no undue favour to any part of the county. There is some account of the wild cattle of Chillingham, and a few notes on the bird life of the Farne Islands, but otherwise natural history comes in for little notice. More than a hundred sketches by the late Mr. Hugh Thomson add to the charm of the book.

Botany with Agricultural Applications. By Prof. J. N. Martin. Second edition, revised. Pp. xii+604. (New York: John Wiley and Sons, Inc.; London: Chapman and Hall, Ltd., 1920.) 21s. net.

ALTHOUGH another introductory botanical textbook might seem superfluous, yet this one, written especially for agricultural students, has certain features which justify its existence. The first part is concerned with the structure and physiology of seed plants, and a useful feature is the almost exclusive use of plants which are of interest particularly to the farmer in the Middle Western States, where the work was written. The second part takes up all the plant groups, and again plants of economic interest are introduced in many instances. The final chapters form an elementary introduction to the subjects of ecology, variation, heredity, and evolution in plants. Many new drawings are introduced, and although they vary much in quality, some of them will form a useful addition to plant illustrations.

Phytoplankton of the Inland Lakes of Wisconsin. Part i. By G. M. Smith. (Wis. Geol. and Nat. Hist. Survey, Bull. No. 57, Scientific Series, No. 12.) Pp. iii+243+51 plates. (Madison, Wis., 1920.)

THIS work is a systematic treatment of the Myxophyceæ, Phæophyceæ, Heterokontæ, and the Chlorophyceæ, excluding the Desmidiaceæ, of the region mentioned. The large number of forms considered are well illustrated with line drawings, and several new genera and species are described.

Letters to the Editor.

[The Editor does not hold himself responsible for opinions expressed by his correspondents. Neither can he undertake to return, or to correspond with the writers of, rejected manuscripts intended for this or any other part of NATURE. No notice is taken of anonymous communications.]

Light and Electrons.

REFERRING to a paper of mine in the current April issue of the *Philosophical Magazine*, in which a possible generation of electrons is suggested, and assuming that the result obtained by the late Lord Rayleigh (*Phil. Mag.*, August, 1916) for the area of wave-front which can be tapped and have its energy extracted by an infinitely small resonator, viz. something comparable with λ^2/π , holds generally to a fair degree of approximation, the length of a ray of terrestrial sunlight sufficient for an electron is given by $\lambda^2/\pi = 0.01$ c.c., or $l = 3 \times 10^7$ cm. for $\lambda = 3 \times 10^{-5}$, which would pass in the thousandth of a second.

Perhaps Sir W. H. Bragg may be tempted to try whether corpuscles are still projected by radiation reduced in intensity, not continuously but intermittently, by a revolving slit. If there is a critical length of effective beam, it would be instructive to know it.

OLIVER LODGE.

April 3.

Relativity and the Velocity of Light.

As neither Sir Oliver Lodge (*NATURE*, March 17) nor Mr. Bartrum (March 31) appears to find my explanation very satisfying, may I further explain as briefly as may be how and why I consider that the Majorana experiments add valuable new knowledge to that previously yielded by the classical Michelson-Morley experiment?

In discussing this and similar questions there are two distinct avenues of approach. We may think and write in terms of the old-fashioned fixed æther, the FitzGerald-Lorentz contraction, and absolute time, or alternatively in terms of the four-dimensional continuum. But if Mr. Bartrum and myself, or either of us, embark on an argument in which we mix indiscriminately the conceptions of the two schemes, there is bound to be confusion and either apparent or real contradiction. I prefaced my mathematical argument (March 10) by the stipulation that we should "consider the problem in terms of an æther and a FitzGerald-Lorentz contraction." Mr. Bartrum, approaching the problem apparently in terms of the four-dimensional continuum, objects that I have not distinguished between a source and mirror "moving relatively to the observer" and the same appliances "at rest with the observer." My answer is that so long as I argue, as I was doing, in terms of an æther, etc., the distinction does not arise. The observer becomes immaterial, and may move or not as he pleases; the æther provides a fixed standard of measurement. My symbols u , v , α , β referred to velocities measured, in terms of unit-lengths mapped out in a supposed fixed æther, by synchronised clocks ticking absolute seconds. If we argue in terms of the old æther conceptions, such measurements are theoretically possible, although, of course, the relativist maintains that they are in practice impossible. If my argument is read throughout in terms of these conceptions, I believe it will be found consistent, and I hope it will be found convincing.

The problem can, of course, alternatively be stated and discussed in the language of relativity. The light-

source of the Michelson-Morley experiment has a world-line AB and the mirror has a parallel world-line PQ. A light signal is sent from source to mirror and back to the source. Its emission from the source is represented by a point A on the world-line AB, its reflection by a point C on the world-line PQ, and its return to the source by a second point B on the original world-line AB from which it started. The Michelson-Morley experiment gives us knowledge of the absolute interval AB, but none at all of the position of C on the world-line PQ of the mirror. So far as the Michelson-Morley experiment alone is concerned, the directions of AC, CB in the continuum are unknown. My contention is that the experiments of Majorana fix these directions for us, and so fix the position of C.

In the problem under discussion the light signal moves entirely in a two-dimensional section of the continuum, namely, the plane containing the parallel world-lines AB and PCQ. Let us take x and ct for co-ordinates (not necessarily orthogonal) in this plane. These refer to a particular observer, and a second observer will use different axes and co-ordinates, the latter being related to x and ct by the ordinary Lorentz transformation. Because the equation $x^2 - c^2t^2 = 0$ is invariant for the Lorentz transformation, the pair of lines $x = \pm ct$ have the very special property that for every observer, no matter what his velocity of motion, they form the internal and external bisectors of the angle formed by his axes of length and time. A world-line parallel to either of these directions represents for each and every observer motion with the same velocity c , which each observer independently will call the velocity of light. Now Majorana's experiment showed in effect that the direction in the continuum of the world-line of light from a source or mirror moving relative to him was the same as that of the world-line of light from a source or mirror at rest relative to him. The directions were obtained by measuring their inclinations to the experimenter's special axes of time and space, but when the directions have been shown to be the same the observer's axes fade from view and the identity of direction becomes absolute. It now follows that the rays of light in a Michelson-Morley apparatus, moving with any velocity whatever, have world-lines parallel to these two special directions. Or, to come back to common language, both the outgoing and returning signals move with the velocity of light. The conclusion is, of course, subject to the limitations of Majorana's experiments—limitations which, it ought to be added, the author himself states with scrupulous care.

J. H. JEANS.

April 2.

A Difficulty in Einstein's Gravitational Theory.

IN order to obtain from Schwarzschild's equation

$$ds^2 = -\gamma^{-1} \delta r^2 - r^2 \delta \theta^2 - r^2 \sin^2 \theta \delta \phi^2 + \gamma \delta t^2 \quad (1)$$

an expression for the gravitational deflection of light which is independent of direction, it is necessary, as pointed out by Prof. Anderson, to make the substitution $r = (2r_1 + m)^2 / 4r_1$, which gives

$$ds^2 = -\left(\frac{2r_1 + m}{2r_1}\right)^4 \left\{ \delta r_1^2 + r_1^2 \delta \theta^2 + r_1^2 \sin^2 \theta \delta \phi^2 \right\} + \left(\frac{2r_1 - m}{2r_1 + m}\right)^2 \delta t^2 \quad (2)$$

and for the velocity of light

$$\frac{2r_1 - m}{2r_1 + m} \left(\frac{2r_1}{2r_1 + m} \right)^2$$

Here r_1 is now regarded as the radius vector. The transformation, although it gives two values of r_1 , can

in no way alter the apsidal progress determined by Einstein from (1). The "measuring rod," however, does not now alter in length for different orientations, which is a somewhat comforting result.

The gravitational potentials in (2) are not additive, and Prof. Eddington ("Report on Relativity," p. 59) proposes to get over the difficulty by neglecting squares of m/r_1 in (2), which would then give

$$ds^2 = -\left(1 + \frac{2m}{r_1}\right) \left\{ \delta r_1^2 + r_1^2 \delta \theta^2 + r_1^2 \sin^2 \theta \delta \phi^2 \right\} + \left(1 - \frac{2m}{r_1}\right) \delta t^2. \quad (3)$$

so that the contributions of potential would be additive.

Unfortunately, neglecting squares of m leads to a change in the apsidal progress, and it appears that treating (3) as exact gives 4/3 times the apsidal progress calculated from (1). We cannot, therefore, neglect squares of m at an early stage without violating the observations which (1) or (2) was called in to explain. The adjustment is, in fact, so delicate in (1) that we may not approximate at all until the end of the calculation.

What, then, are the exact equations for two finite bodies m_1 and m_2 , both mobile? Here we are not permitted to superpose any velocity which would reduce one of the bodies to rest. GEORGE W. WALKER.

Portsmouth, March 30.

I AM indebted to the Editor's courtesy for the opportunity to comment on the foregoing letter. In deciding whether an approximation is allowable, regard must be had to the problem to which it is to be applied. It is true that equation (3) neglects a term of importance in the motion of the apse, and is therefore not valid for the problem of the perihelion of Mercury; but there may be other problems for which the approximation can be justified. One of these is the calculation of the $G_{\mu\nu}$ for continuous matter on p. 59 of my "Report." My proof starts with the approximate calculation of the line-element in a sphere which is ultimately made *infinitely small*; I think that the justification of the neglect of m^2 , given in § 36 is correct, though the argument is intricate, and I would welcome detailed criticism. But, for example, my formulæ are not sufficiently accurate to give the rotation of the apse-line of a particle moving freely through a diffuse spherical nebula.

Dr. Walker goes on to ask: What are the exact equations for two particles moving freely? He who can supply the answer will have solved one of the biggest mathematical problems of the theory. The problem of two bodies in Einstein's theory is an outstanding challenge, like the problem of three bodies in Newton's theory. The solution will give ds^2 *throughout all time*, and therefore incidentally the tracks of the particles which are the singularities of the solution. I am not satisfied that it has yet been proved that the tracks are periodic—that there is no dissipation of energy by the gravitational waves set up.

A. S. EDDINGTON.

Observatory, Cambridge, April 2.

Atomic Structure.

MY letter in NATURE of November 25 last has served a useful purpose by evoking the very interesting account of his new line of work which Prof. Bohr has given in the issue of March 24. But since he did not deal, and scarcely professed to deal, with my suggestion, perhaps I may try to make clearer what that suggestion is.

The success of Prof. Bohr's theory, and of Sommerfeld's developments of it, is sufficient evidence of the truth of its general assumptions, and therefore of the reality of the ideas on which it is based. "Fixed electron" theories have nothing to set against (e.g.) the weighing of the helium atom by means of its spectrum or the detailed prediction of the structure of the L-rays; moreover, those theories, as Prof. Bohr points out, are empirical and based on no general principle. But the superiority of the "orbital electrons" theory does not alter the fact that there are things which it is very difficult to reconcile with the view that the stationary states of an atom consist of electronic orbits of which the dimensions are comparable with 1 \AA ., and of which the periods are comparable with 10^{-16} sec.

The suggestion that I made is that, by means of a generalised principle of correspondence, the distinction between moving and fixed electrons might be abolished and the conceptions that have proved so fruitful in explaining spectra made available immediately for explaining also such things (if there are such things) as are only explicable by fixed electrons. Thus the distinction would be abolished if "time" had no meaning inside the atom. For the difference between electrons following an orbit and electrons fixed at points on that orbit can only be expressed in terms of temporal conceptions; if all such conceptions are totally invalid in dealing with problems of atomic structure the distinction vanishes.

Expressed in the very crude form demanded by brevity, such a suggestion will doubtless be deemed unacceptable, or even unintelligible. Here I would only mention two considerations, one special and the other general, that have led to it. First, very difficult questions can be asked (and have been asked by Stark) concerning what happens in the interval during which an atom passes from one stationary state to another, and during which it emits or absorbs homogeneous radiation. We might deny that such questions have any meaning, because there is no such thing as an interval during which the transition takes place. It is not merely that the interval is infinitesimally small or zero; it is that the conception of a time interval is not permissible when we are considering the process which we observe as change of radiant energy and explain as change of atomic structure. Secondly, the conception of continuity is very closely associated with that of time. The assumption of the older physics, that all fundamental theories (usually misnamed "laws") were to be expressed by means of differential equations, involved in all but a few instances (which can be explained away) that the variable with respect to which the integration of the equations was to be made, in order to compare the theory with experiment, was the "time." Now it is the characteristic and essential feature of Prof. Bohr's theory that the emission and absorption of homogeneous radiation, which is the outward expression of change of atomic state, is not to be described by a differential equation. Consistency seems to compel us to conclude that it is also not to be described ultimately in terms of conceptions in which "time" plays any part.

NORMAN R. CAMPBELL.

British Plants Available as a Source of Industrial Alcohol.

THE production of cheap alcohol for industrial purposes is a subject much under discussion at the present time, and in considering the question of available materials from which it could be obtained the following notes may be of interest.

. Apart from the mangel and sugar-beet, it is im-

portant to observe to what a large extent sugar is present as a reserve material in many of the ordinary root-crops such as the turnip, swede, etc., and in the other varieties of the genus *Brassica*. It is not generally recognised how much of the nutritive value of cauliflowers, cabbages, brussels-sprouts, etc., is due to the large amount of reserve sugar which these plants contain, and this sugar is not present in the edible parts only, but more particularly in the stalk and petioles, which are extensively used as storage organs.

No quantitative analysis has been undertaken to determine the amount of sugar present in these organs, but a qualitative test with Fehling's solution indicates that the amount of sugar must be considerable. This sugar is directly fermentable by yeast, no hydrolysis being required. If the stem or petiole is crushed under water and boiled to ensure the complete liberation of the cell-sap, and yeast added at a convenient temperature, alcohol can readily be detected by the iodoform test. By the same process it is easily demonstrated that fermentable sugar is also present in the petioles of the swede and turnip.

It is suggested that in the many thousands of tons of cabbage stalks and petioles and of the petioles of the turnips and swedes, at present a by-product of farms and market-gardens, we have a suitable and readily available material which could be collected and utilised as a source of industrial alcohol.

We learn from the returns of the Ministry of Agriculture for 1919 that more than 72,000 acres were devoted to the cultivation of cabbage, sprouts, cauliflower, and broccoli; and upon a single farm in the North of England as many as 40,000 cabbages were grown in the year 1920. The returns of the Ministry of Agriculture estimate that 14,200,000 tons of turnips and swedes were grown in 1920. When these crops are harvested an enormous residue must be annually wasted which would be capable of producing a very large quantity of fermentable sugar. The amount, of course, would fall far short of commercial requirements, but it would be by no means negligible, and might materially add to our resources for the production of alcohol in this country, reducing the importation of raw substances for that purpose, and possibly to some extent also the importation of petrol.

Moreover, many other plants could also be utilised. Comparatively little attention seems, at present, to be given to our native plants which store up large quantities of starch or sugar as reserves. In the Gramineæ sugar is largely employed as a reserve material, and it is not surprising to find that the rhizomes of the couch-grass (*Agropyron repens*) and the uni-internodal corms of the bulbous oat-grass (*Arrhenatherum avenaceum*) possess a large sugar-content, the maximum amount being present in autumn or early winter. This sugar varies with the season of the year; in autumn it is chiefly cane-sugar, which on the approach of spring is converted into glucose previous to being utilised by the plant. In either case the reserve sugar in these plants is fermentable by yeast without any further preparation. Both these grasses are pernicious weeds, and large quantities are annually eradicated from the land.

Another source of raw material worth mentioning for the production of alcohol is the starch which occurs so abundantly in the rhizome of the bracken-fern (*Pteris aquilina*). Although it would seem that this carbohydrate cannot be rendered available for human food, further research may indicate a method for its profitable utilisation for power alcohol, and it may be pointed out that a natural process of hydrolysis would take place in the spring as a necessary part of the plant metabolism. At the

present time there are many hundreds of acres covered with bracken which might with advantage be reclaimed for agricultural purposes, and the first stage in this reclamation might well be the eradication of the *Pteris* rhizome for utilisation in the production of alcohol.

Investigations at the present time tend largely to concentrate upon synthetic processes, or to the exploration of new plants which could be grown for the production of alcohol, or to the extension for this purpose of the acreage of food-crops such as potato, beet, etc. The object of this letter is to direct attention to the enormous amount of suitable materials ready to hand and at present overlooked and unutilised in our own country. The plants already enumerated could be added to (e.g. the roots of the spear thistle, *Carduus lanceolatus*, contain an abundance of inulin), and no doubt systematic search would reveal many more which could be exploited for their unsuspected and valuable carbohydrate reserves. The amount in the aggregate would be very considerable, the cost of collection and manufacture would be relatively small, and an asset might thus be secured which would help towards the solution of a pressing industrial problem.

M. C. POTTER.

Armstrong College, Newcastle-upon-Tyne,

March 9.

Relativity, Space, and Ultimate Reality.

As one who has studied very carefully, so far as his mathematics will take him, the various points of view brought together in NATURE of February 17 by the great exponents of the doctrine of relativity, may I have space to express the conviction that the pressing need at the present stage is a clarified conception about the nature of pure space in relation to objectivity or subjectivity? Let me define the contention.

There is little difficulty now about the modest and reasonable earlier demands of the relativists that spatial directions are significant only in relation to matter, that time cannot be dissociated from space, that we have no criterion of absolute motion, and the like. According to these representations space is contingent upon the existence of matter and energy, so that: extinguish the physical universe, and space as an objective reality vanishes too. But the relativists seem now to be taking the opposite point of view, and in the attempt, so powerfully controverted by Sir Oliver Lodge, to geometrize physics they indicate that space, instead of being conditioned by matter, is itself the foundation of matter and physical forces—which are merely the "outcome of the geometry of the universe," as Prof. Weyl puts it. Herein there seems to lie a discrepancy in the relativist position which needs clearing up.

Now I take it that the following propositions will be conceded:—(1) The geometries of Riemann in any number of dimensions are in themselves purely mathematical conceptions; (2) the particular geometry which fits our actual physical universe constitutes a space-time system of four dimensions; and (3) our sole experience concerning the objectivity of space is derived from the property of matter which we call *extension*, involving the notion of distances. But where are we if we discard a universal connecting medium, a sub-material "æther" connecting all bodies in the universe as a necessary physical condition of every gravitational and electromagnetic field? Banish the æther, and the only physical reality between the members of the solar system is light occupying otherwise "empty space"—a conception difficult to entertain and to reconcile with the relativity of pure

space. A connecting æther, sharing with atomic matter the property of extension, does appear to be necessary to render distance and space between the heavenly bodies objective reality. The æther can, apparently, be reconciled with the Einstein equations.

Relativity has, at any rate, rendered the inestimable intellectual service of bringing physics into contact with metaphysics. In respect to questions of ultimate reality we do appear to some extent to be drifting into a position of philosophical idealism. It is evidently in relation to mind that the physical universe acquires its fullness and richness, and certain qualities of matter can scarcely be thought of as standing alone apart from mind. A case in point is beauty, a quality which was referred to by Sir Oliver Lodge in NATURE of February 17. Beauty differs from the grosser qualities of matter in that its objective foundations, namely, various harmonious dispositions and groupings of parts, are only incidentally, not directly, the expression of physical forces. Consequently, beauty as beauty is relative to mind, a subjective reality, and the sense of it in man a faculty of the spirit.

L. C. W. BONACINA.

27 Tanza Road, Hampstead, N.W.3,
March 20.

Molecular Structure and Energy.

In some recent communications on the structure of molecules based on the Lewis-Langmuir theory the question of the energy of molecules seems to have been left out of account. The models for halogen molecules proposed by Prof. A. O. Rankine (Proc. Roy. Soc., 1921, February), for example, whilst they agree well with the viscosity data, are not in agreement with the specific heats of the gases. The models of the nitrogen and nitric oxide molecules proposed by Langmuir, and those of the carbon dioxide and nitrous oxide molecules proposed by Rankine, are also at variance with the specific heats of these gases.

A molecule composed of atoms rigidly attached in line should have a ratio of specific heats of 1.400. Carbon dioxide and nitrous oxide are assumed to have three atoms in line. The value of c_p/c_v for these gases is of the order of 1.300. If nitrogen consisted of molecules as pictured by Langmuir, *i.e.* having two nuclei inside one perfect sphere, the ratio of specific heats would be 1.667. The value of c_p/c_v for nitrogen is 1.40.

I intend to develop this matter in a little more detail, but it seems worth while pointing out that a discrepancy appears to exist between the facts and the latest theory of atomic and molecular structure, at least as I understand it.

J. R. PARTINGTON.

East London College, Mile End Road, E.1,
March 26.

Oceanographic Research.

ONE can cordially agree with Dr. Annandale and Major Sewell as to the importance of all such intensive local work as they refer to in their letter in NATURE of March 31, p. 139; but is it oceanography?

"The investigation of the fauna of the Chilka Lake . . . a minute, almost isolated, fragment of the ocean" (to use their own words) seems exactly the type of excellent marine biological investigation which has been carried on by many institutions, committees, and individuals in various parts of the world (not the British Empire alone) in the past. Long may such continuous local work flourish and become enlarged in scope by the addition of those hydrographical and biochemical researches which should enable us to

understand better the causes of the observed faunistic distribution.

But these intensive studies of relatively small areas can scarcely be said to touch the great problems of the wide oceans as a whole, and cannot be regarded as an alternative to occasional more general expeditions making traverses of large areas and deep seas. The British Empire has interests beyond the coastal waters of the continents. By all means let us encourage local and minutely detailed work, and also advocate, when the time is opportune, that wider investigation of the open oceans which, in the opinion of many of us, might add much knowledge in various branches of science.

W. A. HERDMAN.

Biological Station, Port Erin, April 4.

Why do Worms Die?

THE middle of March saw the slaughter of millions of worms. Morning by morning the pavements, roads, and pathways were strewn with the dead. Great and small, young and old, of every known species and genus, from *Lumbricus* to *Dendrobæna*, lay prone. Even if they were able to reach the pasture, lawn, or grass-plot alive, they had not the power to burrow and recuperate. What caused their death? I have asked the question for thirty years, but have never found the answer.

Four main theories have been advanced. They are killed, folks say, by (1) parasites, (2) cold, (3) rain, or (4) poison.

The first theory has long been maintained. It was held by Darwin ("Vegetable Mould," p. 14), who said that worms were affected by a parasitic fly. The parasites of worms are of very many kinds, but I have collected large numbers of dead and dying worms and examined them with care, yet have found nothing abnormal in this direction. Since worms are cold-blooded creatures they can endure a low temperature without suffering. Moreover, they are often found dead in the spring when the temperature recorded for the night has not been below 34°.

Darwin (p. 125) speaks of Mr. Scott's surprise when told how long they could endure being submerged, "as he did not know how long worms could survive beneath water." It is practically impossible to drown them in a brief time, such as is allowed for their slaughter day by day at this season of the year. And yet in some way showery weather seems to be essential. After March 21 no showers fell at night, and no worms lay dead in the morning.

There remains the miasma theory. "Nature uses poison gas," says the speculator. This theory would seem good if worms were found dead on tarmac roads, but not on gravel paths, and if they died in a similar way all the year round. But such is not the case. Thus every theory seems to fail.

The worms appear to be paralysed. They crawl at first with vigour, then the rate of progress declines. Eventually they cease to move, die, swell in places or along the whole length of the body, and ultimately become the prey of various scavengers, but are totally ignored by the birds.

It seems clear that the conditions required are warm days and evenings, moisture in the way of showers during the night and early morning, and then a cold snap, but not necessarily a frost. Does the combination of cold and moisture paralyse them? Are the dorsal pores choked? Or are they exhausted in their efforts to regain their closed burrows? At present I am unable to carry out the research and experiments upon which alone a satisfactory judgment can be based. Has anyone ever found the answer?

HILDERIC FRIEND.

"Cathay," Solihull.

Stellar Magnitudes and their Determination.¹

By H. SPENCER JONES, Chief Assistant, The Royal Observatory, Greenwich.

II.—APPARENT MAGNITUDES: (b) PHOTOGRAPHIC.

WITH the application of photography to astronomy it was inevitable that attempts should be made to determine apparent magnitudes by photography. Visual observations are slow, for every star must be compared individually, and the telescope reset for each. Photography effects a great economy in observing time at the telescope, for when a plate is secured its measurement may be undertaken at any convenient time. The photographic plate, however, is sensitive to a different region of the spectrum from the human eye; if a blue and a red star appear of equal brightness to the eye, the former will be recorded as much the brighter by the photographic plate. The photographic and visual scales of magnitude will therefore not agree with one another. The difference, photographic *minus* visual magnitude, for any star is called the "colour-index" of that star, providing as it does a measure of the colour of the star; the redder the star, the larger is its colour-index.

The determination of photographic magnitudes is based upon the two following conventions: (i) the light ratio shall be the same as that adopted for visual magnitudes, its logarithm being, therefore, 0.40; (ii) for stars the spectra of which are of the type A₀ in the Harvard classification (*i.e.* in which the most conspicuous feature is the Balmer series of hydrogen lines), the photographic and visual magnitudes shall be equal. If this holds for stars of, say, the 6th magnitude, it will hold also for stars of all magnitudes, by (i). Stars which are bluer than type A₀ have small negative colour-indices; those which are redder have positive colour-indices, the values for the reddest stars being larger than two magnitudes.

The accurate determination of photographic magnitudes is a problem which is much more complicated than it appears upon the surface, and beset with many difficulties. It consists essentially of two distinct problems: the absolute determination of the magnitudes of a suitably chosen series of stars, and the extension of this series to determine the magnitudes of other stars by comparative methods. Although much work has been done at Harvard, Mount Wilson, Greenwich, and elsewhere, there remain discordances which require further investigation before photographic photometry can be regarded as having been placed upon a definite and satisfactory basis.

The area around the North Pole has been chosen in the northern hemisphere as the most suitable area for the absolute determinations, as it is always available for use for comparative methods. A sequence of stars has been chosen by the Harvard observers, called the "north polar

sequence," which are graded in magnitude so as to provide the necessary basis for comparison, and the magnitudes of these stars have been carefully determined by the use of various methods. The difficulty of the absolute determination of these magnitudes is increased by the complication introduced by the law of photographic action. It has been found that, for a given light intensity, I , the photographic effect produced does not increase uniformly with the time, so that the same photographic effect is not obtained by, say, doubling the intensity and halving the time of exposure. In fact, the relationship between the intensity and the time of exposure required to produce a given photographic effect is of the nature $I^q t = a$ constant, where q is a constant for any given type of plate, but has different values for different types, although averaging somewhat about 0.8. Now most of the methods of determining absolute photographic magnitudes depend upon successive exposures given on the same plate, some means being employed to reduce the intensities during one of the exposures. It is clear that, for all photometric work, the times of the two series of exposures must be exactly equal, and then the comparison of the images obtained from the two exposures only involves the assumption that the intensities which in equal times produce equal photographic effects must be equal.

If, then, the photographic effects produced by a series of stars in the first exposure are denoted by:—

$$i_1, i_2, \dots, i_n, i_{n+1}, \dots, i_m,$$

and by the same stars in an equal exposure, in which the brightness has been reduced in a proportion equal to a difference of Δm in magnitudes, are:—

$$\tilde{i}_1, \tilde{i}_2, \dots, \tilde{i}_n, \tilde{i}_{n+1}, \dots, \tilde{i}_m,$$

then, if $i_s = \tilde{i}_r$, it follows that the magnitudes of stars r and s differ by Δm . In this way, differences of magnitude are determined, as in the case of visual observations with a photometer. The zero of the magnitudes must be chosen in accordance with the convention referred to above.

In practice, of course, it rarely happens that two stars can be found the photographic intensities of which in the two cases are exactly equal. The procedure usually adopted is to estimate the photographic effects against an arbitrary scale, and then to use the known fact that the two images of any one star correspond to a magnitude difference, Δm , in order to determine the values of the scale intervals. The magnitude of every star can then be read off.

Various devices have been used to reduce the intensities by a known amount. One method, which has been extensively used at Greenwich, is

¹ Continued from p. 146.

to place over the object glass of the telescope a coarse grating of parallel wires; from the dimensions of the grating the magnitude difference between the principal and first diffracted image can be calculated. Thus one of the Greenwich gratings, illustrated in Fig. 3, which has wires of diameter 1.72 mm., and a total grating interval of 7.0 mm., produces a magnitude difference of 2.66 m . An enlargement of a portion of a photograph obtained by this grating is shown in Fig. 4.² It will be seen that the first diffracted images are round, but that the second diffracted images are elongated by dispersion, and not suitable for comparison. The use of the grating has the advantage that all the information required can be obtained from one exposure, the principal and diffracted images corresponding to two series of images differing by a known magnitude. Any possibility of

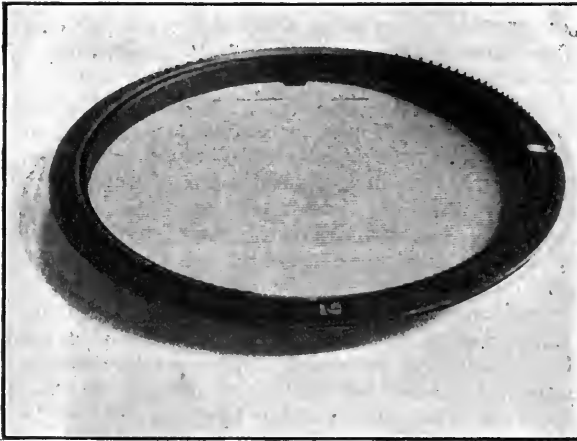

FIG. 3.—Diffraction grating used in stellar photometry.

error, which might otherwise be introduced owing to a change in atmospheric conditions between the exposures, is thus avoided. Other methods which have been employed, principally at Harvard and Mount Wilson, consist in using wire-gauze screens, or rotating sectors, the reduction in luminosity being measured by a photometer in the laboratory in the first case, and calculated in the second case, or in the reduction of the aperture by circular diaphragms. Although the latter method changes the diffraction pattern of the images, no disturbing effects seem thereby to be produced; it is, however, objectionable in the case of a refractor, as the light passes through different parts of the object glass in the two cases, and the difference in absorption introduces errors. Other methods have been employed, but less frequently than those just referred to. It is not convenient to reduce the magnitude too much at one step, as errors are liable to arise. A reduction of

² On account of the difficulty of reproducing satisfactorily faint star images, Figs. 4 and 5 are not actual reproductions of photographs, but are drawn from the photographs. For this reason some of the images do not appear as true discs.

about 5 m is a practicable limit. If stars of a wide range of brightness need to be compared, it is preferable to make the comparison by two steps.

The diameters of the star images increase with the length of exposure. The images are compared with a scale obtained by giving exposures, preferably with the same instrument, on a real or artificial star, the length of the exposures being so graduated that the difference in magnitude between consecutive images is very nearly constant. The sizes of the star images are compared with those of the scale, interpolation to tenths being made between the scale images. The comparison becomes difficult for very bright or very faint stars, so that it is customary to measure only those images which come within a certain interval of the scale; for the brighter and fainter

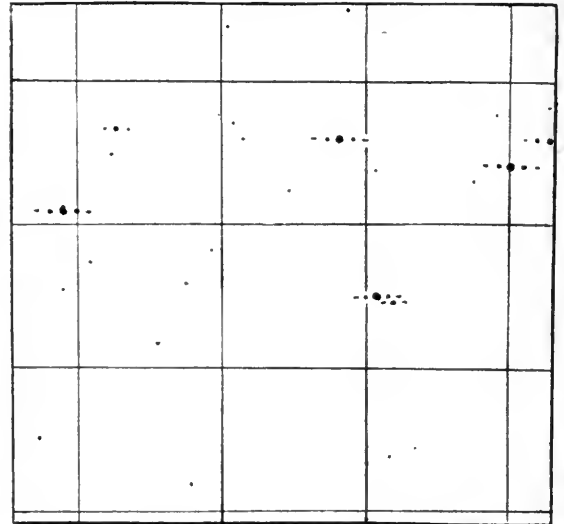

FIG. 4.—Portion of photograph obtained with diffraction grating.

stars, shorter and longer exposures respectively must be given. Corrections have to be determined and applied for the distance of the star image from the centre of the plate, and for atmospheric absorption, the latter as in the case of visual photometry. The former correction arises from the curvature of the field; if focussed exactly at the centre, the edges of the plate are not quite in focus, so affecting the size of the images. It is convenient to make the focus come somewhere between the centre and the edge of the plate.

In this way the magnitudes of the stars comprising the north polar sequence have been determined. There is a good accordance between the several determinations of the magnitudes in the range 10 m –15 m , but in spite of the extensive investigations which have been made, there remain systematic differences between the magnitudes obtained for the brighter stars at Mount Wilson and Harvard which exceed 0.25 m , and this discordance illustrates how much more

difficult is the absolute determination of apparent magnitudes than might be gathered from the above brief account of the theory.

The magnitudes of stars in other areas are based upon those of the north polar sequence. The procedure involves photographing the area in question and the pole area upon the same plate, giving the same exposures, and then comparing the two sets of magnitudes against an arbitrary scale, using the known magnitudes of the pole stars to standardise the scale. Actually, it is customary to expose on the pole, then to give two exposures on the field, followed by another exposure on the pole. In this way the effect of any uniformly progressive change in the sky during the time occupied in taking the plate is eliminated. A portion of a photograph showing a comparison of the polar area with another area is reproduced in Fig. 5. In this figure the pole stars can be distinguished by the fact that the displacement between the two images is not parallel

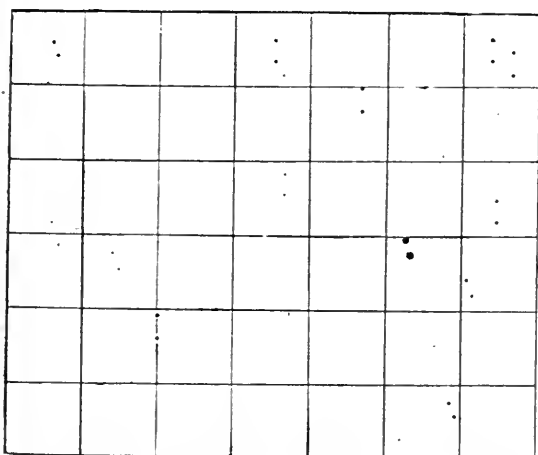

FIG. 5.—Portion of photometry plate showing pole and field stars.

to a *réseau* line. An alternative method of measurement is to measure the diameters of the star images in a micrometer. For a wide range of magnitude, the relationship $m = a + b\sqrt{d}$, in which a , b are constants, and d is the diameter of the image of a star of magnitude m , is found to hold. The constants a and b can be determined by a least squares solution, using the data obtained from the stars of known magnitude.

A slightly different method of procedure is to take photographs at some distance out of focus, the plate meanwhile being given slight periodic motions in two perpendicular directions by means of a device invented by Schwarzschild, and called by him a "Schraffierkassette." The central portion of the image so obtained is uniformly grey; the plate is measured in a comparator, the central portion of the image being seen surrounded by a grey field, the density of which can be varied, produced by a plate with a uniformly graduated density. The position of the latter is varied until the tint of the star image matches that of the surrounding field. The readings can be standardised

by stars of known magnitude. This method possesses the advantage that it is not appreciably affected by bad definition, whereas when images in focus are being dealt with, bad definition causes woolly edges, and the images are not then exactly comparable with those of the scale.

Either a reflecting or a refracting telescope may be employed for the determination of photographic magnitudes. Owing to the absorption produced by the object glass of a refractor, there is a slight relative difference, depending upon the colour of the star, between the magnitudes obtained by the two types of instrument. The differences in magnitude can be expressed as a linear function of the colour-index, and the constants of the relationship require to be determined for each instrument from a comparison of the results obtained from white and red stars. The phenomenon becomes of some importance when the scale of magnitudes is extended to faint stars, for it has been shown by Seares that the faint stars are, on the average, considerably redder than the brighter stars. The effect of this will be to give systematic errors in the case of a refractor equivalent to the errors that would be introduced by the use of an incorrect light ratio.

It is of interest to compare the numbers of the brightest stars down to a limiting magnitude of 7.0m in the case of visual magnitudes with the corresponding numbers in the case of photographic magnitudes. The visual estimates were made at Harvard, the photographic at Greenwich.

Total Number of Stars to Various Limits of Magnitude.

Brighter than	Visual	Photographic
1.0	11	11
" " 2.0	38	41
" " 3.0	111	138
" " 4.0	300	454
" " 5.0	950	1,480
" " 6.0	3,150	4,750
" " 7.0	9,810	14,960

The brightest star, both visually and photographically, is Sirius; its spectrum is of type Ao, so that both visual and photographic magnitudes are $-1.6m$.

The economy in observing time effected by the application of photography to the determination of magnitudes has resulted in visual magnitudes being determined by photographic methods. This is effected by the use of isochromatic plates in conjunction with a yellow filter, which is found by experiment to give a spectral-intensity curve similar to that of the normal human eye. This can be tested by means of the magnitudes determined visually with a photometer, and the visual-scale can then be continued to magnitudes much fainter than those which have been determined visually. For distinction, it is customary to call the magnitudes so determined "photo-visual" magnitudes; photo-visual magnitudes of the stars of the north polar sequence have been determined at Mount Wilson down to a limit of 18m, much

fainter than would ever have been possible by ordinary visual methods.

The photographic and visual or photo-visual magnitudes of a star having been observed, the "colour-index" is at once obtained. There is a marked dependence of the colour-index upon the spectral type of the star. The basis of the classification of the spectra of stars adopted at Harvard, and now universally accepted, was entirely independent of magnitude or colour considerations, and depended solely upon the type of spectrum. The spectra of the types B, A, F, G, K, M were found to show in this order a progressive change from bright-line to absorption spectra, and the order is intimately bound up with the problem of stellar evolution, and also with the temperature of the stars. The colour-indices found in three separate investigations for stars with spectra of different types are given in the table, together with the temperature of the stars, derived by Russell on the hypothesis that the stars radiate as black bodies. In accordance with the convention on which photographic magnitudes are based,

the colour-index for type A₀ is zero in each investigation.

Spectrum	Colour-Index.			
	King	Parkhurst	Schwarzschild	Temperature
B ₀	-0.32	—	—	20,000
B ₅	-0.17	-0.21	-0.20	14,000
A ₀	0.00	0.00	0.00	11,000
A ₅	+0.19	+0.23	+0.20	9,000
F ₀	0.30	0.43	0.40	7,500
F ₅	0.52	0.65	0.60	6,000
G ₀	0.71	0.86	0.84	5,000
G ₅	0.90	1.07	1.10	4,500
K ₀	1.16	1.30	1.35	4,200
K ₅	1.62	1.51	1.80	3,200
M	1.62	1.68	—	3,100
N	—	2.50	—	2,300

It will be seen that the colour-index increases almost uniformly from class to class, and that when either the photographic or visual magnitude, and either the colour-index or the spectral type, are given, it is possible to determine the remaining data with very little uncertainty.

(To be continued.)

Ocean Tides.

By PROF. J. PROUDMAN, University of Liverpool.

THE tides of the oceans form the most magnificent dynamical phenomenon of our planet, and yet we are extremely ignorant of even their main characteristics. It is only in the immediate neighbourhood of land that they become directly observable, and it is practically only here that they have hitherto been observed.

Much has been done in the way of recording coastal tides and in analysing the records obtained, yet very much more remains to be done even for the purpose of preparing accurate commercial predictions. In this connection the most urgent need is the study of the meteorological effects. Owing to these effects, the tide in a harbour on any day may be several feet different from that due to astronomical causes, which alone appears in the tables of predictions. Now this is of the very gravest concern to harbour authorities, for, in docking a large vessel, to get less water than was expected may be very serious, while to refrain needlessly from docking through fear of this possibility is a fruitful source of delay and expense. And this is merely an instance.

The up-and-down motion of the water-surface is accompanied by oscillating currents. Much rough information is in existence concerning the nature of these currents near land, having been gathered chiefly by naval authorities, as it is of the utmost importance in navigation. But the number of places at which accurate observations of currents have been made with modern instruments is extremely small. No such observations are on record, for example, for the Irish Sea. When the problem of predicting the meteorological effects comes to be tackled in a way likely to lead to success, these shallow-water currents, which

are mainly instrumental in producing the local wind effects, will require thorough observation.

But when the tides are viewed scientifically as the oscillations of a great dynamical system, these coastal tides, that almost alone have been observed, appear as the mere fringe, so to speak, of the essential phenomenon. It is in the vast bodies of water constituting the great oceans that the tides have their real being, and the coastal tides themselves will never be completely understood until we know the great oceanic tidal movements. The meteorological disturbances may arise wherever the tides arise, and we want to know, for instance, what effect certain meteorological conditions over the Atlantic will have on the tides in our harbours.

On the side of pure science many problems of wide geodynamical and cosmical interest require as data a knowledge of the ocean tides.

Now it is believed that not a single accurate observation of either tidal elevation or tidal current has ever been made in the deep water of any of the oceans. The best knowledge we possess of mid-ocean tides consists in observations on the shores of oceanic islands, and even this knowledge is not nearly so complete as we could wish.

Mathematically, the tides are "determined" by the size and shape of the ocean basins and certain astronomical data, but the complete solution of the problem is not within the sight of the present generation of mathematicians. If all the possible free oscillations of the oceans could be discovered, then the actual tides could be calculated with ease by a principle which is a generalisation of that of resonance.

Various guesses have been made as to the

nature of the ocean tides, and these have produced several different charts of cotidal lines. By a cotidal line is meant the locus of all points of the ocean surface at which high water occurs at the same instant. The best known of these charts are those of Whewell and Harris, but quite recently a new set of cotidal lines for the world has been published by Sterneck (*Sitz. Akad. Wien*, Bd. 129, 1920).

Whewell's chart was based on the hypothesis that in the Southern Ocean, where the parallels of latitude meet with no great land barriers, powerful tidal waves follow the sun and moon and send off-shoots up the Atlantic, Pacific, and Indian Oceans. Many serious objections have been urged against this.

Harris's charts are based on the principle of resonance, but the details of the application have been rejected by some high authorities. Harris sought in every ocean for regions which, if completely surrounded by land and not subject to the earth's rotation, would have twelve hours for their longest free period of oscillation; and he always found them! He then applied the principle of resonance, ignoring the absence of complete land boundaries and the presence of the earth's rotation.

Sterneck's chart is constructed from the existing observations with the condition that cotidal lines for times differing by six hours shall be as nearly parallel as possible.

These charts differ very widely from one another. In the Pacific Ocean, for example, Harris places three no-tidal points, whilst Sterneck places six.

At the present time there is no method by which we can find out what the ocean tides are except that of directly observing them, and it is high time that serious attempts were made to this end.

If the proposal made by the president of the British Association at Cardiff ever materialises, and a fully equipped oceanographical expedition results, it is very much to be hoped that means will be found of measuring tidal elevations and currents. If trustworthy observations could be

made at only a few mid-ocean stations, the light they would throw on the great tidal movements would be enormous. And, even if this very desirable object proves impracticable—for it will probably require new methods and instruments—it is understood that the expedition would often be in water sufficiently shallow for the methods and instruments already developed. Also, the parties of observers which it is hoped might be landed at the most remote islands could obtain tidal records of very great value.

Hitherto, off-shore tidal observations have been restricted to shallow water, but it has to be confessed that in this country very little attention is being paid to the work. No gauge-records of off-shore elevations appear to have been published by any British authority, though trustworthy records are said to have been taken by the French. In this connection we may mention that there is a discrepancy of about 40 miles between the charts of cotidal lines for the Irish Sea as published by the Admiralty and those of many foreign authorities. Very few British current-meter observations have been published, though in recent years the Scandinavians have worked hard at providing the means of taking them. Bell Dawson has done a notable work in Canadian waters, but where is the band of current measurers in this country that can compare with Nansen, Ekman, Petterson, Jacobsen, Witting, and Helland-Hansen of the Scandinavian countries?

Now, although with the instruments that men of other nationalities have developed we may hope to learn a great deal from the suggested expedition whenever it comes into shallow water, yet preparations ought to be in progress for work in deeper water. Quite near to our shores we could have a small expedition which, besides teaching us much about our own tides, would ever strive to observe in deeper and deeper water, devising such modifications of methods and instruments as the deeper water required, and improving methods and instruments for such depths as had proved practicable at all. It is greatly to be feared that no such efforts are being made.

Obituary.

JOHN BURROUGHS.

THIS veteran naturalist and poet died suddenly while in a train near Buffalo on March 29, within a few days of his eighty-fourth birthday. He was born, a farmer's son, at Roxbury, New York, on April 3, 1837, and had the advantage of a rural education. After about twenty years as school-teacher, journalist, Treasury clerk at Washington, and auditor of United States national banks, he bought a farm at West Park, on the Hudson, and spent the rest of his life fruit-growing, observing, and writing. Year after year he wrote delightful and distinctive essays on natural history and country life, which were re-

ceived with well-deserved popularity. Mention may be made of "Wake Robin" (1871), "Winter Sunshine" (1875), "Birds and Poets" (1877), "Locusts and Wild Honey" (1879), "Pepacton" (1881), "Fresh Fields" (1884), "Signs and Seasons" (1886), and the list might be continued to his "Breath of Life," published a few years ago.

Burroughs also wrote poems and more than one study of Walt Whitman, whom he knew intimately, and for whom he had an enthusiastic reverence. "Whitman: a Study" is certainly a very remarkable book of its kind, and to the influence of Whitman and Emerson it seems just to say that John Burroughs owed much.

Everything that Burroughs wrote was a work of art; he had a picturesque, melodious style without preciosity, and he kept close to his own experiences of wild Nature and country life. Burroughs had a strongly developed scientific mood, but his essays are not so much informative as appreciative, expressing a sympathetic interest in common things and the endless novelty of the seasons. While he had an almost fiery dislike of those who read the man into the beast in a facile way, making an often tawdry homunculus of many a common creature, he had himself a great gift in getting near the character of the birds and animals he studied. It was the true inwardness of Nature-study that Burroughs expressed—a well-informed love of the country. The manner in which he expressed this is probably unsurpassable, and we do not know why his writings should ever grow old.

WE regret to announce the death of PROF. RUTHERFORD J. PYE-SMITH on Wednesday, March 23, at the age of seventy-three years. Prof. Pye-Smith was educated at Guy's Hospital, and became F.R.C.S. in 1875. In the following year he went to Sheffield as a general practitioner, and rapidly made a name for himself as a surgeon. At that time the epoch-making work of Lister on antiseptics was revolutionising surgery, and Prof. Pye-Smith was one of the pioneers of the new methods in England. On the constitution of Sheffield University he was elected professor of surgery, a post which he held until his retirement a few years ago, when he received the title of emeritus professor and the honorary degree of Ch.M. He also represented Sheffield University on the General Medical Council, where his practical experience of the problems of medical education was greatly appreciated.

Notes.

THE KING has been pleased to approve the award of the Royal medals of the Royal Geographical Society as follows:—Founder's medal to Mr. Vilhjalmur Stefansson, for his distinguished services to the Dominion of Canada in the exploration of the Arctic Ocean; and Patron's medal to Gen. Bourgeois, Senator for Alsace, Membre de l'Institut, for his long and eminent services to geography and geodesy as Director of the Service géographique de l'Armée, and president of the Conférence Internationale de la Carte du Monde au Millionième. The council has made the other awards of the society as follows:—The Murchison grant to Comdt. Maury, for his surveys in the Belgian Congo; the Back grant to Miss Marion Newbiggin, for her contribution to geography, particularly of the Balkans; the Cuthbert Peek grant to Capt. J. B. L. Noel, for his reconnaissance of the eastern approaches to Mount Everest and other geographical work; and the Gill memorial to Lt.-Col. M. N. MacLeod, R.E., for his contribution to the theory of survey from air photographs.

A SELECTED series of specimens in illustration of the Neolithic industry from the stone-axe factory of Graig-lwyd, Penmaenmawr, will be exhibited at the rooms of the Royal Anthropological Institute, 50 Great Russell Street, W.C.1, on April 20-23. During the recent investigation of this important site, which was carried out by a committee of the institute, the actual work of excavation being under the direction of Mr. S. Hazzledine Warren, a mass of valuable material was obtained. This included what is probably the finest series of specimens illustrating the manufacture of a stone axe that has ever been found. It is hoped that a more extended exhibition may be arranged where more space is available; but as this is at present uncertain, those who are interested in prehistoric man should not miss the opportunity of examining the selected series. At the close of the exhibition typical series of the implements will be distributed to various museums throughout the country.

THE terms of the resolutions which it is proposed to submit to the Committee of Ways and Means of the House of Commons to fulfil the Government's promise to safeguard British industries have been issued as a White Paper (Cmd. 1219) under the heading "Safeguarding of Industries." In the first resolution it is proposed that an import tax of $33\frac{1}{3}$ per cent. be levied for five years on articles which come under the categories of optical instruments, chemical glassware, scientific and technical instruments of precision such as galvanometers, pyrometers, etc., ignition magnetos, tungsten and its products, and synthetic organic chemicals with the exception of dye-stuffs, irrespective of the country from which they may be imported. The second resolution aims at protection from "dumping," and no time-limit for its operation is given. If such articles are exported to the British Isles at prices below the cost of production, or if depreciation of currency enables foreign manufacturers to sell such goods here at prices below those at which they can be profitably manufactured in this country, an additional import tax of $33\frac{1}{3}$ per cent. of the value of the article is suggested. Such articles imported from Germany would thus be subject to a tax of 50 per cent. of their value by the operation of the reparation measures, a further $33\frac{1}{3}$ per cent. under the first resolution and another $33\frac{1}{3}$ per cent. under the second, making in all an import tax of $116\frac{2}{3}$ per cent. of the value as determined by the wholesale price obtaining in the country of origin.

A PATHETIC document reaches us by way of Canada referring to the distressed condition of a number of retired university professors in Vienna. Among those in greatest need are some annuitants whose names are world-famed. Not everyone whose pension fails can easily start life again as an agricultural labourer. By analogy with the desolated French towns taken over by corresponding English cities, the Continental universities might be allotted to English universities for support; for example, Cambridge might offer to

educate the children of Viennese professors. Better still, the botanists might look after botanists, the chemists after chemists, and this assistance might be organised through our learned societies. The poverty and want of the Vienna intellectuals are confirmed by reports received through the Emergency and War Victims Relief Committee of the Society of Friends (hon. secretary, Miss Ruth Fry, 27 Chancery Lane, W.C.2) in correspondence with their outpost at Singerstrasse 16, Wien I. There is book-hunger as well as food-hunger, and for the relief of the former an Anglo-American Library for Central Europe has been formed (hon. secretary, B. M. Headicar, London School of Economics, Clare Market, W.C.2). Readers of NATURE might offer scientific papers and transactions and short-circuit correspondence by direct communication. The Austrian League of Nations Union (hon. secretary, Herr Arthur Müller, Oesterreichische Völkerbundliga, Burgring 9, Wien I.) is preparing to act as trustees for funds to be devoted to the technical education of the youth of Vienna.

INDIA at the present moment is in a stage of transition, and the form her institutions will take for the next few generations depends on the success of certain enlightened men who are striving against great odds to combat prejudice, ignorance, and self-interest. A clear lead was given to the industries of the country by the work of the Indian Industrial Commission, and in the case of the chemical industries by that of the Chemical Services Committee which was appointed as an outcome of the Commission. Nevertheless, when one reads reports such as that recently published by the Bengal Chamber Committee on the suggestions put forward by the Chemical Services Committee it is difficult to believe that there is any real grasp of the needs of the moment, and that inter-provincial jealousies may not, after all, seriously affect the industrial development of the country. In these circumstances it is pleasant to record the appearance of the first number of the *Journal of Indian Industries and Labour* (Calcutta, published by order of the Government of India), which, in accordance with the foreword written by Sir Thomas Holland, is "one step towards provincial co-operation" and "a medium for communicating to a wider public . . . information that will assist private enterprise." The articles are interesting and well written, a particularly useful feature being the summaries of industrial intelligence by the Director of Industries of each province. On the whole, there is little call for criticism excepting perhaps a statement on p. 5 that cellulose can be converted into starch, which is, to say the least of it, premature. Everyone concerned with this useful and admirable production is certainly to be congratulated.

THE eleventh annual May lecture of the Institute of Metals will be delivered at 8 o'clock on Wednesday, May 4, at the Institution of Mechanical Engineers, by Prof. T. Turner, who will take as his subject "The Casting of Metals."

WITH a portion of the funds at their disposal the trustees of the Captain Scott Memorial Fund have decided to establish a Polar Research Institute in

connection with the new department of geography in the University of Cambridge. In an article entitled "The Future of Polar Exploration" in the *Geographical Journal* for March Mr. F. Debenham gives some details of the scheme. The object is to have a place not only where the results of polar expeditions can be worked out and the manuscripts and log-books deposited, but also where all information in the form of books and samples of equipment can be collected ready for examination. It is hoped eventually to provide a library, map-room, and museum of polar gear and equipment. The funds allotted by the trustees are sufficient for the foundation, but they will not extend to the purchase of material and collections. An institute of this kind developed on the lines suggested would be of service to polar explorers of the future, and the fact that many members of Capt. Scott's scientific staff, including Dr. E. A. Wilson, were from Cambridge gives that University a special claim to have the institute. At the same time Cambridge will find it difficult even with adequate funds to make collections of polar maps and literature equal to those now available in various libraries in London or Edinburgh.

SOME interesting questions relating to the influence of environment on culture in the Congo area were discussed by Mr. E. Torday in a paper on the Batetela read at a meeting of the Royal Anthropological Institute on March 15. The Batetela, having migrated from their original eastern home and penetrated a region of West African culture, exhibit a quaint mixture of East and West African, of forest and grassland culture, mixed with beliefs and customs borrowed from the Akela, the Baluba, the Arab, and even the European. Part settled in the grassland between the Lubefu and the Lomami, while others migrated to the great forests on the banks and north of the Lukenye River. Mr. Torday traced in detail the differences in culture between the grassland dwellers, the Sungu, the forest dwellers, the Bahamba, and a third section, the Olemba, whom he considered as the nearest to the original type of Batetela. In the discussion which followed the reading of the paper both the president, Dr. W. H. R. Rivers, and Prof. Elliot Smith pointed out that Mr. Torday's evidence was equally important for the question of the diffusion and contact of cultures. They instanced the practice of cicatrization, which showed a combination of two elements, as a result of which the cicatrices were arranged in linear patterns, and had afforded Prof. Elliot Smith the only parallel for an example of cicatrization on the skin of a woman found in Nubia dating from 2000 B.C.

ONE more stage in the study of the smaller Oligochaets is marked by the publication of a paper by Welch on "The Genera of the Enchytraeidae" (Trans. Amer. Micro. Soc., vol. xxxix., January, 1921, pp. 25-50). The author recognises 16 genera and approximately 325 species, and supplies a useful bibliography. As there is no country in which these "pot-worms" flourish more luxuriantly than in Great Britain, where about a dozen genera are found, with a vast number of species, this guide to classification should prove valuable to systematists in this country.

IN a short note on the fresh-water isopods known as *Asellus aquaticus* (*Ann. Mag. Nat. Hist.*, ser. 9, vol. v., 1920) Prof. C. Chilton directs the attention of English naturalists to a recent paper by Dr. E. G. Racovitza, who has shown that under the name *aquaticus* two distinct species have been included. This name is retained for the commoner species which has been fully described and figured; the other species has been named *meridianus*, and Prof. Chilton records examples from Tunbridge Wells. For the differences between the species the reader is referred to Prof. Chilton's note or to Dr. Racovitza's paper in *Arch. Zool. Expér.*, vol. lviii., 1919.

SOME years ago the authorities of the American Museum of Natural History founded a journal for the purpose of arousing public interest in the work of the museum. Brightly written by members of the museum staff, and marvellously illustrated, that journal has earned for itself an honoured place all over the world. We might well follow the lead America has set us in this matter. The latest issue (vol. xx., No. 5), among other good things, contains a most interesting article on the unicorn and its horn by the director of the museum, Dr. Frederic A. Lucas, and another, no whit less readable, by Dr. W. D. Matthew on Canadian dinosaurs, while Mr. Malcolm Anderson contributes a most instructive account of North China in winter.

IN his presidential address (printed in *Science* for January 21 last) before the Zoological Section of the American Association for the Advancement of Science at its Chicago meeting Prof. W. M. Wheeler discussed the subject of organisation in research as it appears to a biologist, and pointed out some of the dangers attending post-war efforts in this direction. He mentioned the array of instincts, emotions, and interests on which the activities of the investigator depend and the great diversity of mental aptitude which necessarily accompanies the genius for different types of research. Prof. Wheeler claims that any organisation dealing with research should refrain carefully from interfering in any degree with the free expression of the individual's exceptional aptitudes in his own way. In these days when the amateur in scientific research is passing we need to beware of fettering in any way by Government or other interference the activities of the professional scientific man.

A HUMAN embryo obtained by Dr. Vernon Favell on the fourteenth day after the commencement of the missed menstrual period, and described by Prof. Bryce at a recent meeting of the Anatomical Society of Great Britain and Ireland, is of outstanding interest in that it presents a human stage theoretically essential, but not actually seen hitherto. The stage represented is that in which the annio-embryonal rudiment is solid and connected to the blastocyst wall by a cellular stalk. The specimen consists of a relatively large blastocyst around which moderately extensive areas of plasmodi-trophoblast can be seen. Within the cavity are many scattered amœboid cells, the forerunners of the extra-embryonic mesoderm. The yolk-sac vesicle is relatively small, and a large,

somewhat scattered group of cells lies between it and the annio-embryonal rudiment. The latter consists of an undifferentiated cell mass with spaces suggestive of a process of vacuolisation and connected to the blastocyst wall at one point by a band of cells. The majority of early human embryos previously described have been of necessity in a more or less pathological condition, and the appearances seen cannot be regarded as strictly normal. Prof. Bryce makes no claim that his embryo is exceptional in this respect. He interprets the specimen as one in which the trophoblast vesicle has continued to grow, while the embryonic rudiment has lagged behind or ceased to develop, but has been preserved in an early phase of its differentiation. Further study of the specimen will undoubtedly furnish valuable information, and its detailed description is awaited with considerable interest.

THE final report of the Grain Pests (War) Committee has been drawn up by Prof. W. A. Herdman and was issued during February of the present year. The Committee was appointed by the Council of the Royal Society in June, 1916, as the result of correspondence with the Board of Agriculture, in which the latter requested the Royal Society to initiate investigations "in relation to the damage done to grain by insects." The report gives a concise summary of the conclusions arrived at as the result of the various lines of research carried out. It emphasises the serious importance to the Empire of the elimination of grain pests and the necessity for bringing into being a permanent body capable of dealing with all organisms causing destruction to grain and other stored products. It is hoped that the Department of Scientific and Industrial Research will see its way to make an annual grant of money in order to provide the salaries and equipment of two or three officers specially selected for carrying out researches on those problems which are admittedly urgent. Probably by means of the judicious expenditure of a relatively small sum of money for a few years a great deal of valuable food-stuffs would be saved from destruction by insects and other grain pests.

THE essential characteristics of United States climates is the subject of an article by Prof. R. de C. Ward, of Harvard University, in the *Scientific Monthly* for December last. For descriptive details the United States is subdivided into climatic districts, and these are called the Eastern, the Gulf, the Plains, the Plateau, and the Pacific; with the three last-named a further subdivision between north and south is suggested by the difference of latitude. Temperature, rainfall, and other climatic conditions are given in fair detail for the several districts, and a comparison is made of the different advantages for fruit-growing, farming, and general agriculture. The movements of storms and cyclonic disturbances necessarily enter largely into the general explanation for rains experienced, the disturbances travelling generally from west to east. The article gives a very general idea of the different meteorological conditions which prevail in various parts of the United States, especially with regard to temperature; on the whole, it is shown

to be highly favoured in general climate. The space given to the article is necessarily too limited for great detail.

The December issue of *Terrestrial Magnetism and Atmospheric Electricity* contains the preliminary results of the magnetic survey of the Indian and Southern Oceans carried out by the United States survey ship *Carnegie* during the summer and autumn of last year. The values obtained for the deviation of the compass over the south-easterly course traversed from Colombo to a point about 10° west of the Straits of Sunda differ little from those given in Admiralty Charts 3776 and 3777 for 1917, but over a considerable area of the Indian Ocean directly south of Ceylon, between latitudes 25° and 35° S., the westerly deviations are a degree or more greater than those given in the charts. From this region to Fremantle, and thence to a region in latitude 50° S. directly south of South Australia and Victoria, the new observations agree with the charts, but in the latter area the easterly deviations given in the charts are about 1° too small. For the rest of the course to New Zealand the observations agree fairly well with previous records.

In an address to the students of Faraday House on February 25 Sir Philip Dawson discussed the possibilities of electric traction in connection with heavy railway work. He considered that many railway engineers laid too much stress on standardisation, and this was preventing progress. Great harm can be done by excessive standardisation. The solution advisable for one line of railway might be quite unsuitable for another. He thought that the French Government had made a mistake in standardising 1500 volts direct current for electric traction. Germany, Sweden, and Switzerland had adopted 16,000 volts alternating current as the standard pressure. The United States has not yet introduced any legislation, and side-by-side extensions are going on of 3000-volt direct-current systems and 11,000-volt single-phase alternating systems. Few realised the amount of power required for electric traction, e.g. a train going out of Victoria Station took 2000 kw. (2680 h.p.), and Sir Philip calculated that of the total demand for electricity in the London area contemplated by the Electricity Commissioners about half would be required for the railways. When the suburban electrification of the Brighton system was completed it alone would require 50,000 kw. There had been practically no interference with telegraph and telephone circuits by the large currents used on this railway.

An illustrated account of the new works at Canning Town belonging to the British Glass Industries, Ltd., appears in the *Engineer* for February 25. These works are already in partial operation, and are designed to be the largest glassworks in Great Britain. The plant will consist of nine units, each complete in itself as a glass factory, and the total output of bottles or jars when the works are in full operation will be approximately 600,000 a day. To obtain this output continuous shifts will be employed. The plant is being laid out in conformity with modern practice,

including mechanical mixing and the latest types of melting furnaces and gas-producer and annealing plants. Pyrometric control of temperature is employed in both the melting and annealing furnaces. It is claimed that there is only one fully automatic bottle-making machine in existence—the Owens—all the others requiring the addition of a separate device for feeding the glass into the machine. The type installed at the Canning Town works is the Daubenspeck, which is designed for making wide-mouthed bottles; this machine is made by Messrs. Fraser and Chalmers, of Erith.

An illustrated account of a new type of crankless steam engine appears in *Engineering* for March 11. This engine has been constructed to the designs of Mr. A. G. M. Michell, the inventor of the Michell thrust-block. The engine is enclosed in a cylindrical casing, and the rotating shaft is co-axial with the casing. At the centre of the shaft is a swash-plate, i.e. a plate with its plane inclined to the shaft axis, 62.5° in the experimental engine, but to be made 67.5° in future. There are eight cylinders, four on each side of the swash-plate arranged round the shaft with their axes parallel to the shaft axis. Opposing pistons are connected together by a bar crossing the outside of the swash-plate. Each of the eight pistons bears against the side of the swash-plate through a Michell thrust-pad. The engine is uniflow, i.e. steam acts on one side of the pistons only, and steam is admitted to the cylinders by means of two rotating disc valves, one at each end of the casing, and exhaust at the end of the outer stroke takes place through ports uncovered by the pistons. The design lends itself to very perfect balancing, and tests show that the designed speed of 1200 r.p.m. can be greatly exceeded. The cylinders are each 5 in. in diameter, and 0.92 indicated h.p. per cylinder per 100 r.p.m. has been obtained. The success of this experimental engine is due to the Michell pads, for which the coefficient of friction is of the order 0.002.

OWING to the shortage of edible fats in Germany during the war, attempts were made to produce fatty acids from natural hydrocarbons of the paraffin type which were obtained by the distillation of lignite. The progress made is reviewed in the *Chemical Trade Journal* for December 4 last and in the *Journal of the Society of Chemical Industry* for February 28. Many processes have been described, and the conclusion arrived at is that, although success does not appear to have been attained, the conversion shows promise. Two main groups of methods have been used: (1) The synthesis of fatty acids from hydrocarbons of low molecular weight, such as ethylene and acetylene, by polymerisation and oxidation, and (2) the partial degradation and oxidation of hydrocarbons of high molecular weight. In the Zelinsky process a chlorinated hydrocarbon was treated by the Grignard reaction for the production of fatty acid. This process is said to have been in use in Germany in the later years of the war. Harries treated unsaturated hydrocarbons of high molecular weight with ozone, decomposed the ozonides with steam, and transformed the resulting peroxides into fatty acids by treatment with

caustic alkali. The most promising method, however, is the direct oxidation of a hydrocarbon mixture such as petroleum or paraffin wax by atmospheric oxygen in presence of a catalyst consisting of a resinate of vanadium, manganese, etc. In this process, due to Franck, a net yield of 70-75 per cent. of fatty acids suitable for soap-making, esterification to produce fats, and other purposes is claimed. The process was in operation on a technical scale.

MESSRS. A. GALLENKAMP AND CO., 19-21 Sun Street, E.C.2, have issued a revised catalogue of electric furnaces suitable for a variety of laboratory purposes. The advantages possessed by electric furnaces are evidently receiving due recognition, for Messrs. Gallenkamp state that they have sold more than 1100 furnaces during the past five years. The construction of these furnaces is very simple; a tube or muffle of fused silica is wound with a resistor wire and the exterior well lagged to diminish heat loss. Such furnaces are capable of temperatures up to 1000° C.;

beyond this point it becomes necessary to employ platinum-foil windings and refractory tubes or muffles.

MESSRS. BERNARD QUARITCH, LTD. (11 Grafton Street, W.1), have just issued a catalogue (No. 362) of second-hand books and periodicals ranging over a variety of subjects. The sections most likely to interest readers of NATURE are those devoted to botany, early science, natural and physical sciences, and periodicals. In the latter there are many sets and long runs, some not otherwise easily procurable. Among the items are *Annales de Chimie et de Physique* (1789-1909), the *Journal of Botany* (vols. i.-xlv.), *Philosophical Transactions of the Royal Society* (1665-1918), and *Transactions of the Zoological Society of London* (1833-1915). There is also a set of the publications of the Ray Society (1844-1915).

ERRATUM.—Mr. W. J. Perry writes:—"In the article in NATURE of March 31 entitled 'The Development and Spread of Civilisation,' I inadvertently put 3700 B.C. for a date that should be 3400 B.C."

Our Astronomical Column.

RECENT BRILLIANT FIREBALLS.—Mr. W. F. Denning writes that he has received twenty-five accounts of the brilliant fireball of March 16, and has been able to revise his preliminary deductions, which were based on scanty data. The height of the object was from about 68 to 25 miles from over Moffat to Berwick, path 81 miles and velocity 11 miles per second, radiant point at 72°+12°. The average of a number of estimates of the duration of flight was 7½ seconds. The radiant point does not correspond with any known shower in March, and the position shows that the fireball was overtaking the earth in its orbit and moving with very slow apparent velocity. It is curious that so many fireballs appear to be revolving in direct orbits, but the fact seems clearly proved on ample evidence. It is also a significant feature that many fireballs of the slow-moving type exhibit radiants which are situated on or near the ecliptic.

Splendid fireballs were also observed on March 25 13h. 13m. and March 29 7h. 27m. G.M.T. from the metropolitan district and south-eastern counties. A number of descriptions have been received, but few of them are exact and accurate. The approximate real paths derived from the best data available at the time of writing are:

G.M.T. h. m.	Height at first. Miles.	Height at end. Miles.	Path. Miles.	Velocity. Miles per second.	Radiant.
March 25 13 13	67	56	88	—	181-29
29 7 27	61	47	71	12	48-9 62-10

The former appears to have a possible connection with the comet of 1264, for which Prof. A. S. Herschel computed a radiant at 182.5°-28° on March 25. This comet was a brilliant one, and passed within two millions of miles of the earth's orbit.

The past month of March has furnished large fireballs of unusual numbers and interest, and the popular idea has been to ascribe them to the oncoming comet of Pons-Winnecke, though, as a matter of fact, no connection whatever can be proved.

ANOTHER INVESTIGATION OF THE EINSTEIN SPECTRAL SHIFT.—The *Comptes rendus* of the Paris Academy of Sciences for March 7 contains an investigation by M. A. Perot, communicated by Dr. H. Deslandres. The investigation is based on a study of the mag-

nesium spectrum. The wave-lengths in Ångström units of the lines b_1 , b_2 , b_3 in the arc at atmospheric pressure were found to be 5183.614, 5172.690, and 5167.340 respectively.

Tests were then made at different pressures, and it was found that the value of $d\lambda/\lambda$ per atmosphere is $1.35/10^6$ for b_2 and $1.67/10^6$ for b_1 , so that comparison between b_1 and b_2 should give the pressure of the region where the spectral lines are produced. In this manner, by a discussion of solar and arc spectra obtained by photography in the year 1911, the value of the pressure of the absorbing layer on the sun is found to be equivalent to -6 cm. of mercury \pm 20 cm. Of course, the pressure cannot actually be negative, but it is inferred that it is very low, and, consequently, that nearly the whole of the atmospheric term $1.35/10^6$ must be applied to the solar measures of b_2 to make them comparable with the terrestrial ones. The value of $d\lambda/\lambda$ for sun *minus* arc is then $(1.16+1.35)/10^6$, in good agreement with the Einstein value, which is $2.12/10^6$. The author has failed to notify the regions of the sun to which the measures apply. This should have been done, in view of the considerable differences for different regions found by Mr. Evershed and others.

NOVA AQUILÆ III.—In the Journal of the Manchester Astronomical Society for the sessions 1917-20, which has recently been received, there appears a valuable series of photographs of the spectra of Nova Aquilæ III. taken by Mr. C. F. Butterworth with a 6.3-in. prismatic reflector. The period covered is from June 10 to November 14, 1918, and thirty-six photographs are shown taken on twenty-two days distributed fairly evenly over this period. Although the dispersion obtained was extremely small (243 Å.U. to 1 mm.), the photographs are evidently good enough to stand considerable enlargement and show plenty of detail. The general sequence of changes in the spectrum is well shown, and many of the smaller details—such as the complex structure of the hydrogen bands—may also be detected. The series as a whole forms a useful addition to the observations already published concerning this important nova. In addition, Mr. Butterworth gives a table of measures of the breadths of the more important bright bands at four different stages of the star's career.

The Galvanometric Measurement of Human Emotion.¹

By DR. A. D. WALLER, F.R.S.

WE are all of us familiar, subjectively within ourselves, objectively by the behaviour of our neighbours, with the signs and symptoms of emotion, and with the fact that such signs and symptoms are more or less under voluntary control and can be suppressed or simulated at will. We are moved to or from an object we may desire or fear. We are moved to laughter or to tears by events witnessed and imagined; and whereas all men are moved in the mass by the same general motives of light and dark, food and hunger, love and hate, we know by everyday experience that no two men react in identical fashion to the same motives.

1. Physiologically, all emotions are expressed as neural outbursts from the central nervous system through efferent nerves to muscles and glands; emotion, in general, results in intensified physiological activity at the periphery of the body—muscles and glands, heart and blood-vessels, the face and eyes and skin. A movement of surprise, a palpitation of the heart, a blush, a pallor, a shiver, a rush of tears, a dilated pupil—all these and other signs of emotion consist in sudden local intensifications of the chemical exchanges that are in constant operation between the living cells of the body and the fluid medium by which they are surrounded. We know indeed that all such chemical exchanges are controlled through efferent nerves, and we speak of this control as their trophic action, but we are scarcely prepared at the present day to recognise the close association between signs of emotion and the phenomena of nutrition.

2. The physical sign of emotion is known to psychologists as the psycho-galvanic reflex. It was first definitely revealed to us twelve years ago by Veraguth,² of Zurich, and has since then formed a favourite subject of study by many later observers whom I shall not attempt to enumerate. I joined in the hunt four years ago,³ and was very quickly satisfied that this physical sign affords the most convenient possible gauge and measure of human character and of human temperament, seeing that it declares *how much* a given subject is moved by his thoughts and feelings. A spot of light showing the movements of a galvanometer connected with the palm of the hand exhibits the fluctuating emotions of the person to whom the hand belongs, and if the person be an ordinary normal person it is only the palm of the hand, and not any other part of the skin of the upper extremity, that shows the response. My first point is, then, that the emotive response is, *par excellence*, a palmar phenomenon, and I shall, as my first and chief experiment, undertake to demonstrate this point. (Experiment.)

3. Mr. X. Y. has been good enough to lend himself to my purpose. His hand and his forearm are connected with each of two galvanometers and two Wheatstone bridges. The round spot belongs to the hand circuit, the square spot to the forearm circuit, and balance can be adjusted in each circuit separately by suitable manipulation of the two resistance boxes. In both cases the wiring is such that increased conductivity of the hand or of the forearm gives movement of the spots to my right, *i.e.* any emotive

impulses from the brain down motor nerves to the hand or to the forearm will cause deflection to the right. Let us watch the two spots for a while. I expect you to see that the hand spot behaves irregularly, whereas the arm spot creeps steadily across the scale without showing any of the vagaries of the round spot.

You realise now why I have been at trouble to show the simultaneous behaviour of *two* spots. With only the hand in circuit of one galvanometer you should at first have felt doubtful whether the movements you saw were really due to emotive discharges, and not to otherwise imperceptible muscular twitchings such as are perceived and utilised by thought-readers. It would otherwise have been desirable to set up some very delicate form of myograph to satisfy this doubt. I shall show you presently, by asking the subject to make a least possible movement of one of his fingers, that the round spot—*i.e.* that indicating the electrical resistance of the hand—shows a deflection which is due to a minute disturbance of contact, and, therefore, takes place in the direction opposed to that of an emotive response. I am sure you will realise with me what a mercy it is that the deflection by slight, often quite unavoidable, movement is, in general, the contrary of that of the emotive response.

4. But to return to our experiment. The subject is at rest; both spots are reasonably steady, but by reason of his past experience he knows that an evil moment is approaching. As you may see by the irregular movements of the hand spot, he is beginning to worry, making a picture in his mind of the pain he is about to undergo by steel or fire, and, obviously, this disturbance of quietude creates a condition that is not favourable for recognising or measuring the disturbing effect of any real interference with his comfort. The emotive effects of my threatening language must be allowed to subside. You cannot expect to study rings made by throwing a stone into a pond unless the pond is quiet; you must wait for it to get still. When he comes to rest Mr. X. Y. will react smartly and obviously in response to the suddenly threatened pin-prick or to a real pin-prick. (Trials by pin and matches. Real and imaginary pin-pricks and burns.)

You now, perhaps, feel fairly well satisfied that the statement made a few minutes ago is correct. In the upper limb of a normal person emotive responses to slight excitations are confined to the palm of the hand. The only other part of the body in which they occur is the sole of the foot, but this I shall ask you to take on trust; it really is not necessary that the actual evidence should be brought into court. It would merely be a repetition of what you have just witnessed; and this lantern-plate (Fig. 1) will, after all, afford us the quickest, as well as the most conclusive, evidence.

5. I shall venture to trespass just a little further upon Mr. X. Y.'s endurance to make good one further point, although it is a point that you may already have noticed.

This palmar emotive response is, in my view, to be regarded as caused by a sudden augmentation of electrical conductivity in a membrane or membranes in the fourth arm of the Wheatstone square. That augmentation of conductivity is to be understood as

¹ A discourse delivered at the Royal Institution on February 4.

² "Das Psychogalvanische Reflexphänomen." (Berlin, 1900.)

³ "The Galvanometric Measurement of 'Emotive' Physiological Changes." Proceedings of the Royal Society, B, vol. xc., p. 214, 1917.

produced by a sudden dilatation of ultramicroscopic pores in this membrane or membranes. I am not speaking of visible pores, but of invisible pores such as are postulated in theories of electrical conduction and of osmotic phenomena. I imagine that these invisible pores suddenly dilate when the emotive impulse through efferent nerves reaches the living membrane, just as we see the pupil of the eye dilate with an emotion of surprise. And with this image in my mind I find it extremely interesting to recognise and measure what a very long time it takes for any given stimulus to produce its effect. It takes two seconds before the threat of a pin-prick—or, for the matter of that, an actual pin-prick—or a single induction shock, brings about the sudden dilatation of pores or increased permeability and the increased electrical conductivity that are signified to us by the movement

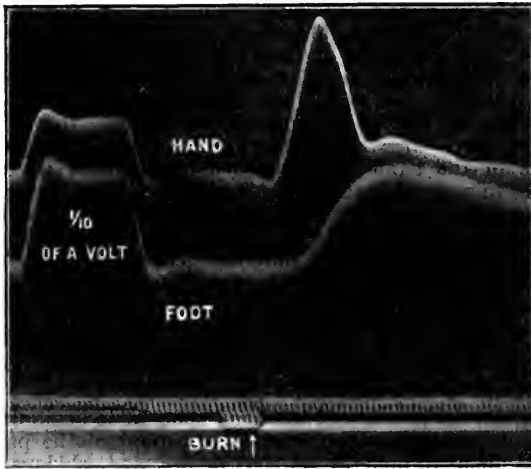

FIG. 1.—This photograph is the simultaneous response of the HAND and of the FOOT of a normal subject, and is given as an example to illustrate the method of investigation by double response. In this example it is evident: (1) that the response occurs sooner and is of shorter duration in the hand (palm) than in the foot (sole). From the time record it can be seen that the lost times in the hand and in the foot are respectively 2 and 4 seconds (approx.), and the durations of response 15 and 40 seconds (approx.). A closer approximation to true time values would require a quicker record to be taken for the lost times and a slower record for the durations. (2) That the response is greater in the hand than in the foot. This magnitude is measured by reference to the initial deflections made by passing a current from $\frac{1}{10}$ volt through each of the two circuits. In this example the hand response is approximately $\frac{1}{10}$, and the foot response approximately $\frac{1}{20}$. The rate of movement of the plate is shown (not very distinctly) in half-seconds. The portion shown in the figure occupied about 45 seconds. A similar procedure by simultaneous double response is required for the mapping out of the body-surface. Obviously the comparison between right and left sides, upper and lower extremities, distal and proximal parts, flexor and extensor aspects, is to be carried out with far greater expedition and certainty by double than it could be by single records.

of the spot of light. How is this long lag of two seconds to be accounted for? Does it occur on the afferent side? Assuredly not. A delay of this sort might be expected to amount to at most one-fifth of a second. Moreover, if we miss out the afferent side altogether, and bring about the response by an artificial explosion down efferent nerves, we shall find the same long delay of two seconds between the muscular movement and the emotive movement, both of which are taking place at the periphery. Therefore, the chief business of the long delay takes place at the periphery, in the skin of the palm of the hand, and its great length is a token that we have to do with impulses conveyed, not along cerebrospinal, but along sympathetic nerves. We may find time later to discuss the question whether

these are vasomotor or secretomotor or trophic nerves.

6. *Dreams* are subjective phenomena occurring in the subconscious state, with which we are all familiar during sleep, and during the hypnotic state, and in the state called "trance." We are familiar also with innumerable objective signs of such subjective phenomena in the shape of descriptions of dreams and in the behaviour of sleep-talkers and sleep-walkers, and, above all, in the extraordinary cases of spiritualistic mediums. These last stand highest in the scale of sensitiveness.

The relative magnitudes of response to a real pin-prick and to a fictitious pin-prick vary with different people under different conditions, but in general they may be divided into two categories, whom we may call *positives* and *imaginatives*.

Positives—in whom little or no disturbance is caused by the threat of a pin-prick, and a real pin-prick is required before any response takes place.

Imaginatives—in whom a large response occurs to the threat—larger, it may be, than the response to the real fact. In not a few of this imaginative class it is almost impossible to take a pure observation of response to fact, for they begin to respond as soon as the operator makes the slightest movement, or else the response is a large one, compounded of fear followed by fact. Here is a confirmatory experiment in evidence of what may be characterised as a dwindling fear, and its revival by fact. (Experiment.)

All men (and, judged by their behaviour, animals also) are more or less imaginative. The kind of diagram you have just seen would represent the responses of nine out of ten of my present hearers to a series of threats with a real shock interpolated in the series. Many of us had an opportunity a few years ago of studying upon our friends and upon ourselves the signs and symptoms of fear during German air raids upon what they called the fortified city of London. The noise and disturbance occasioned by these raids, the false alarms and the warnings by maroons and sirens, afforded a unique opportunity for the exact galvanometric study of the emotions aroused by various kinds of noises. From the purely scientific point of view the opportunity could not be neglected of studying the psychophysical phenomena brought to our doors—phenomena that could not be expected again within the same lifetime. So from the air raid of September 21, 1917, to the last and most prolonged visit of Whitsuntide, 1918, I enlisted the services of volunteers to sit quietly, connected by wires to a galvanometer, and on two occasions I had sitters arranged in connection with recording apparatus which was set going a few minutes before the noise began, so that the emotive response during the whole affair was recorded. Let me show you two or three photographs (Figs. 2 and 3).

These photographs are not merely of interest on their human side, but also have this definite scientific value, that they afford measured records of the largest emotive responses that I have ever witnessed. The responses commonly observed in the laboratory are at most 10 per cent. changes; these air-raid responses have been at least 200 per cent. changes, which I cannot reproduce artificially by any means I care to employ.

7. But to return to our different classes according to sensitiveness. We classified people as positives and imaginatives according as they exhibited greater response to fact or to fiction. Apart from this criterion, we might undertake to arrange people as more or less imaginative according as they give larger or smaller responses to certain standard threats, as of

a pin-prick or the lighting of a match. High in the scale of imaginatives we not infrequently meet with people who can at will either keep quiet, or think thoughts and see visions and hear words of purely imaginary existence without objective physical substratum. It is very interesting to watch the galvanometric signs of subjective phenomena—interesting to the onlooker, but far more interesting to the subject

8. The emotive response is liable to all manner of variations. It varies in different individuals, and in the same individual it varies with different states of mind and body. It varies in magnitude and in its distribution over the limbs with variations in the magnitude of its exciting cause. While it is, in the main, an uncontrollable phenomenon, I call to mind more than one case where to all appearance it has been influenced at will.

9. The distribution of the response over the body is especially interesting. In normal persons it is exclusively palmar (and plantar); the rest of the body-surface is silent. But in "sensitives" it extends up the limbs and the trunk. And a border-land person, according to his state of temper, can react normally to-day, but as a "sensitive" to-morrow. The few spiritualistic mediums whom I have examined have (with one doubtful exception) given the reaction proper to "sensitives," i.e. in the hand and in the forearm.

10. The diurnal variations of the reaction attracted my attention at the very outset of the inquiry. I soon noticed that the same people, when submitted to a standard stimulus at different times of the day, gave responses of very different magnitudes; the responses were at their best about the middle hours of the day, when physiological activity is high, as compared with what was elicited early in the morning and late at night. And the conductivity of the palm of the hand rose and fell during the day (as does the temperature).

I thought it necessary to investigate this diurnal periodicity rather closely to learn how much it might be necessary to take into account the time of day when comparing results obtained on different individuals. So I watched this periodicity on my own hands by means of apparatus set up for the purpose in my dressing-room, so that observations of conductivity could be taken at any convenient time. The observations were recorded to form a graph on squared paper; and it may be remarked, by the way, that throughout the observations the conductivity of my right hand has been found to be higher than that of my left hand.

11. The three weeks over which these observations extended afforded me an admirable opportunity of observing the galvanometric effects of my own normal variations of "temper." Most people are more or less conscious of what may perhaps be called variations of euphoria before breakfast, and of very distinct, if not outwardly evident, variations of euphoria when the morning's letters are read. In order to test this point a photographic recorder was set up in connection with the galvanometer on my dressing-table and I had my letters brought up there and read to me and signalled on the recording plate. Most of the letters made no impression upon me, but I well remember one fortunate morning on which the post included two distinctly effective letters which produced marked effects duly recorded on the photographic plate.

12. One is naturally tempted to ask what relation there may be between the magnitude of the reaction and the mental quality. A first step towards an answer to this question has been taken by Miss Waller, who has made systematic measurements of seventy-three students of medicine, divided according to examination results into an upper and a lower division. The average response was higher in the former than in the latter—e.g. to disturbing questions the average value of the response came out about 50 per cent. higher in the upper division.⁴

13. I have often been asked whether pleasant and painful sensations produce similar or opposed galvano-

⁴ Mary D. Waller, "The Emissive Response of a Class of Seventy-three Students of Medicine measured in Correlation with the Result of a Written Examination," *Lancet*, April 6, 1918.

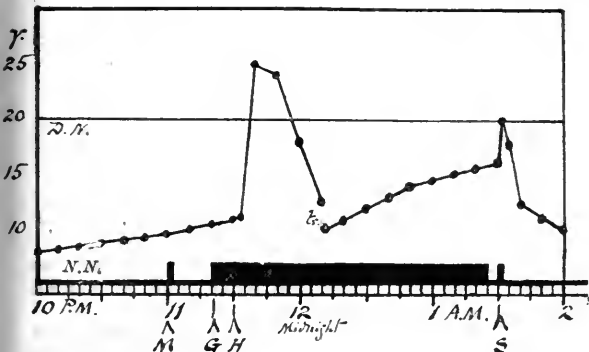

FIG. 2.—Emotivity of A. M. W. during the air-raid on Whitsunday, 1918. (From the *Lancet*.) M indicates the time of the first warning by maroons at 11 p.m. G indicates the commencement of gun-fire. The duration of the disturbance was from 11.20 p.m. to 1.30 a.m. H marks the moment of maximum alarm, when the swelling hum of approaching aeroplanes was most audible. S indicates the second warning by siren at the termination of the disturbance. The electrodes were transferred from the left to the right hand at 12.5. The horizontal lines D.N.—N.N. indicate the average normal day and night conductance of A. M. W., ascertained from other observations.

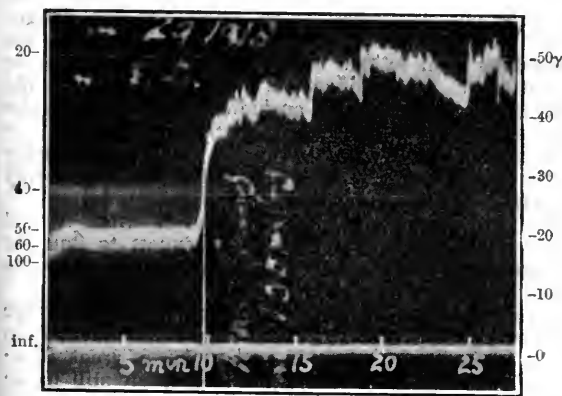

FIG. 3.—Galvanometric record of G de D. during the air-raid of January 29, 1918. (From the *Lancet*.) At the tenth minute of observation the noise of maroons, immediately followed by that of aeroplanes and guns, broke out, and the resistance, which was approximately 60,000 ohms during the first ten minutes before the disturbance, fell to approximately 20,000 ohms during the next 15 minutes. (On the left hand is given the resistance in thousands of ohms, and on the right the conductance in gemmhos.) The measurements are as follows:—

0	...	8.30 p.m.	...	56 × 1000 ohms or 18γ
5	...	8.35 "	...	19γ
10	...	8.40 "	...	37γ
15	...	8.45 "	...	45γ
20	...	8.50 "	...	50γ
25	...	8.55 "	...	50γ
		At 11.30 (all quiet)	...	44 "
			...	23γ

who knows what he (or she) is thinking about. And when it is realised that the galvanometer answers to one's thoughts and temper, it becomes quite an absorbing pastime to sit quietly in an armchair and watch oneself think as one watches the galvanometer move.

metric deflections. The emotive response in its unmistakable form as a sharp movement occurring about two seconds after its exciting cause is always in one direction, *i.e.* in the direction of decreased resistance—increased permeability, poro-dilatation or, if you prefer to think it so, contraction of living matter round pores so as to dilate them. And in many thousands of observations I have never witnessed any similar movement in the opposite direction—*i.e.* in the direction of increased resistance. All that is ever seen in that direction is the gradual remission of a previous deflection in the emotive or excitatory direction. If you regard the question in its psychological aspect, you will soon be satisfied that the matter could not be expected to come out otherwise. Our pleasures and pains are not simple opposites producing opposite physiological effects. Pains are active and exciting states in our conscious life, sharply contrasting with their background. Pleasure is more often merely the subsidence and relief from pain, a gradual recovery of the untroubled state. A pin-prick suddenly excites emotion, and the emotion gradually falls to rest. There is no counterpart pleasure equal and opposite to a pin-prick. Pleasure is of necessity gradual. Too sudden pleasure—joy, as we call it—is exciting, and causes discharge down the nerves that acts precisely like painful excitements and gives rise to electrical effects in the same emotive direction.

14. We distinguished a few moments ago between imaginatives and positives according as threatened pains produced larger or smaller effects than real pains. It is convenient to draw another kind of distinction according to the extent of body-surface over which the response is manifested. The response to "weak" stimuli in the great majority of men and women is exclusively palmar (and plantar). But with "strong" stimuli, and in certain cases with "weak" stimuli as well, the response can also be manifested by the forearm (and by the leg) as well as by the hand (and foot). Such cases may be designated as "sensitives" to distinguish them from the others who are relatively insensitive, but since these others are in a majority, and it would seem inappropriate to designate the majority of mankind as insensitive, it is better to call them "normals." These two labels, "sensitives" and "normals," are not intended to imply any division into two hard-and-fast categories, but rather a scale of differences grading between two extremes. Indeed, I have satisfied myself in at least one case that a subject classified at a first sitting as "normal" was temporarily raised to the degree of "sensitive" in consequence of a rather violent fit of "temper."

It is convenient to reserve the designation "insensitive" for cases low down in the normal scale, giving in response to ordinary stimuli little or no palmar reaction—*i.e.* a doubtful response of the order of 1 per 100 of the initial resistance.

15. Provisionally, then, our observations can be systematised in accordance with the following scheme:

Class.	Emotive Response.		Examples.
	Hand.	Forearm.	
I. Sensitives ... ("Imaginatives")	Yes	Yes	Spiritualistic mediums and others.
II. Normals ...	Yes	No	The majority of men and women.
III. Insensitives ... ("Positives")	No	No	Pythiatics. "Shell shock" cases.
IV. Others ...	—	—	"Shell shock" cases and others.

Class I.—"Sensitives" giving large responses (10 per cent. or more of the original resistance) from the forearm and from the hand.

Class II.—"Normals" giving moderately large response (2 to 5 per cent.) from the hand, but little or no response from the forearm.

Class III.—"Insensitives" giving little or no response (1 per cent.) from the hand, and, of course, also the forearm.

Class IV.—(a) Subjects who, by reason of their state of health, were obviously unfit to undergo examination, and (b) subjects who declared themselves as unable to stand it.

Subjects of Class I. and Class II. include those who were characterised a moment ago as "imaginatives." The three spiritualistic mediums to whom I referred just now were included in Class I. Class III. comprises people of duller imagination, or perhaps of firmer fibre, whom we called "positives."

At this early stage indeed, when the number of properly observed cases is so small and the danger of imperfect observation so great, it seems to me hazardous even to talk about rules and exceptions or to attempt a classification. Nevertheless, if the attempt is made without prejudice, and if the results of observation are recorded in physical units by the side of what in medical parlance is the clinical history of the subject, a preliminary classification is not only permissible, but also necessary.

Let me again refer to the present attempt and make good the point that we may expect to find the unexpected, that so-called regular results may be exceptional and *vice versa*.

16. *Pythiatics.*—Hysterical subjects or, as they are now called, "pythiatics," men as well as women, seem to be exceedingly sensitive and make a great fuss; but when they have been persuaded to sit still in an armchair and connected up with the galvanometer and tested by ordinary stimuli—pin-prick, false and real; match-burn, false and real—lo and behold! they exhibit little or no response. They belong to Class III., that of the "insensitives"; and we are reminded of the fact that in exaggerated—*i.e.* pathological—degree the hysterical or pythiatic state is found to include anæsthesia, loss of sensibility, as a leading symptom. But, of course, more observations are necessary, and more observers.

The Modern Londoner and Long Barrow Man.

AT a meeting of the Royal Anthropological Institute held on March 8, Prof. F. G. Parsons read a paper on "The Modern Londoner and Long Barrow Man," in which he discussed a claim made by Dr. Macdonell and Prof. Karl Pearson that the head shape of Londoners of the seventeenth and eighteenth centuries was more like that of the Long Barrow men than of any other race. Prof. Parsons, however, showed, by a detailed comparison of contours obtained

from thirty male London skulls of the seventeenth and eighteenth centuries dug up in the Clare Market district, and corresponding with the averages obtained by Dr. Macdonell from his London skulls found at Whitechapel and Moorfields, with those of twenty Long Barrow skulls from Yorkshire, Wiltshire, and Gloucestershire, that in the head measurements, in the depth of the orbital openings, in the length of the face, and in other anatomical details the London

skulls differed markedly from those of the Long Barrow men. On the other hand, in every respect these London skulls corresponded more closely with those of Anglo-Saxons than with those of Long Barrow men. Occasionally a Londoner might reproduce the Long Barrow type, as in the case of the notorious thief Jonathan Wild, but these cases were so rare as not to affect the average contour.

Further, the Londoner of to-day had changed his head shape from that of the seventeenth-century Londoner, but it was in the direction of the short-headed mid-European race, and farther away still from the Mediterranean type, of which the Long Barrow men were such good examples.

When the average contours of the modern London skulls were superimposed upon those of the Long Barrow men, it was at once evident that there were two sets of differences, which Prof. Parsons provisionally described as "masticatory" and "respiratory." The former consisted of increased length of skull in front of the auditory meatus, of a tilting forward of the malar bone and outer margin of the orbit, of a greater splay of the zygomatic arch, of an increased width of the ramus of the jaw, and of a flattening of the side of the head. All these changes were just as evident in an average contour of Eskimo skulls as in that of Long Barrow men, and they were all explicable by assuming an increased development of the great masticatory muscles.

The second set of changes between the Long Barrow and London skulls was the deep face and deep orbital openings of the latter, as in all Nordic skulls. The face of the English child at birth closely agrees with that of the Long Barrow man, and at three and five months the orbits and nose have markedly increased in depth from above downward. This is to be attributed to the narrowing and deepening of the nose to adapt the individual to a cold climate, ensuring that the air shall be more perfectly warmed by contact with the turbinated bones which act as radiators. As the nasion moves up the tops of the orbits have to keep pace with it, and so the characteristic depth of the Nordic orbits is accounted for.

It is interesting to note that though the Eskimo agree with the Long Barrow folk in the first set of masticatory characteristics, they differ from them and agree with the Nordic people in the second set of respiratory changes.

Pendulum Operations in India and Burma.¹

THE paper referred to below, recently published by the Survey of India, is an opportune contribution to geodetic knowledge. It gives the results of pendulum observations at 108 stations distributed over mountains, plateaux, plains, and coasts. Col. (now Sir) G. P. Lenox Conyngham, Major Cowie, and Capt. Couchman were the observers. The work extended over six years, 1908-13, and it is evident that unremitting care was bestowed upon it throughout.

This is the first attempt made outside the United States of America to apply to pendulum observations the correction for isostasy, first introduced by Mr. Hayford in 1909 when he was reducing the pendulum observations of America. The deduction of the correction for isostasy for any particular pendulum station involves considerable labour; the whole earth has to be divided into circular concentric zones, with the station as their centre; the mean heights of the several zones, above or below sea-level, have then to be determined *de novo* for each successive station. The

¹ Survey of India. Professional Paper No. 15: "The Pendulum Operations in India and Burma." By Capt. Couchman. (1915.)

application of Hayford's system to the pendulum stations of India is thus a most interesting feature of Capt. Couchman's work, and students of modern geodesy will find his explanations helpful and clear. The final results obtained by Couchman furnish strong evidence in support of Hayford's contention that isostatic compensation is complete at a depth of about 113 km.

Geodesy is a science demanding world-wide co-operation; the results obtained in one continent require to be tested in others. The theory of isostasy initiated in America has now been shown by Capt. Couchman to explain anomalies in Asia. But this is not sufficient; geodetic results and theories should be submitted to an international association for scrutiny. The old International Geodetic Association, which had been endeavouring for fifty years to co-ordinate the surveys of all countries, came to an end in 1914, when the war broke out. If geodesy is to progress, a new international association will have to be formed.

The old association, always sympathetic and anxious to help, had an uphill task; it had to contend with jealousies, and to accept results, whether good or bad, without being able to discriminate or criticise. Its authority rested largely on the personal reputation of the late Prof. Helmert, whose right to the position of director was universally recognised, and whose death during the war was lamented in many countries.

In 1914, when the old association came to an end, two questions were awaiting an international decision, namely, the introduction of a new spheroid of reference and the treatment of isostasy. Obsolete spheroids of reference are still employed by various surveys, and their continuance is due, not to any local belief in their correctness, but to an unwillingness to face the laborious complications of a change until a new spheroid has received international approval.

The problem of isostasy is also awaiting international consideration. In America Hayford and Bowie have worked out a complete system of computations, and in India Crosthwait and Couchman have followed Hayford's lead.² Will the system be accepted in Europe? When this question comes to be considered by the future international association Capt. Couchman's work on the pendulum operations in India will be found a useful and weighty contribution.

University and Educational Intelligence.

NOTICE is given by the University of London that applications for grants from the Dixon Fund for assisting scientific investigations must be made to the Academic Registrar of the University, South Kensington, S.W.7, before May 15 next.

Two further lectures under the scheme for the exchange of lecturers between Holland and England are announced. Both will be given at the rooms of the Royal Society of Medicine, 1 Wimpole Street; the first, by Prof. W. Einthoven, of Leyden, entitled "The Relation of Mechanical and Electrical Phenomena of Muscular Contraction, with Special Reference to the Cardiac Muscle," will be delivered on May 2 at 5 p.m.; and the second, by Prof. Bolke, of Amsterdam, entitled "The Somatic Changes in Affections of the Endocrine Glands and their Significance in the Evolution of Man," on May 12 at 5 p.m. The lectures, which will be delivered in

² In Professional Paper No. 13 (1912) Crosthwait applied Hayford's method to the observations of the plumb-line in India.

English, are addressed to advanced students and others interested in the subject, and admission is free, without ticket.

THE Registrar of the University of Calcutta has submitted an application to the Secretary to the Government of Bengal Education Department (*Pioneer Mail*, March 18) for substantial financial aid for teaching and post-graduate study in accordance with the recommendations of the Calcutta University Commission. For the salaries of the post-graduate staff during the session 1921-22 a sum of $1\frac{1}{2}$ lakhs of rupees (8333l.) is asked. Large grants are also asked for the extension of technological studies in the University College of Science and Technology. It is suggested that part at least of these grants should be recurrent, but for the present year a capital grant of 10 lakhs of rupees (66,666l.) would enable the college to carry on its work. The library of the college is also in need of many standard works of reference, and for this purpose a grant of $1\frac{1}{4}$ lakhs of rupees (8333l.) is considered to be necessary.

THE subject proposed for the Adams prize for the period 1921-22 is "The Theory of the Tides." Applications of mathematical and dynamical theory to the observations already available, the rate of dissipation of tidal energy, the characteristics of tides in shallow seas and estuaries, and the general problem of tidal motion as affected by the earth's rotation are among the suggestions which the adjudicators make for the guidance of candidates. The prize is open to any person who has been at any time a graduate of the University of Cambridge, and is worth about 220l. Each essay must be accompanied by an abstract indicating which portions are considered to be original, and it may be printed, typewritten, or written by someone other than the author. A motto must be affixed to each essay, and a sealed envelope bearing the same motto and containing the candidate's name, degree, and address should be forwarded with the essay. Essays must reach the Registry of Cambridge University on or before December 31, 1922.

AN interesting event of the present month is the International Conference of Students which has just been held at Prague, an account of which has appeared in the *Westminster Gazette*. Prior to the war a society known as the "Corda Fratres," or International Students' Union, was already in existence. It was dissolved in later years, but is now being restored. In November, 1919, when Strasbourg University was celebrating its newly acquired freedom, La Confédération Internationale des Etudiants was formed by France, Belgium, and Czecho-Slovakia, and most of the other chief countries of Europe have since become affiliated. Apparently a necessary preliminary to admission is the existence of a national students' union in the country concerned. This formerly rendered Great Britain, the United States, and other countries ineligible, but it is stated that steps in the desired direction are already being taken. It is hoped that this country will play a part in the movement—one of great benefit to students and to the future of science, which, it is commonly said, knows no national boundaries. One of the unfortunate results of the war has been the accentuation of barriers to free scientific intercourse and exchange of knowledge, scientific men in Russia, Austria, and other countries being exceptionally unfortunate in this respect. This desire for fraternisation between students in the chief countries of Europe is a hopeful sign for the future of civilisation.

THE Royal Commission on University Finances, appointed in October last to inquire into and report

upon a basis for determining the financial obligations of the State of Ontario towards its universities, has presented a report to the Lieutenant-Governor of the State. There are at present five institutions of university standing in Ontario, and the report before us deals with three of them, Toronto, Queen's, and Western Universities. Toronto University is a State institution controlled on its administrative side entirely by the State Government; Queen's and Western Universities are independent, though they have been in receipt of annual grants from the Government which have been determined from year to year. The Commission recognises that higher education can no longer be supported by private individuals, and a definite scheme of State grants for the three universities is recommended. For buildings which are urgently needed it is considered that sums of 1,500,000 dollars, 340,000 dollars, and 800,000 dollars should be given to Toronto, Queen's, and Western Universities respectively. As regards maintenance, it is recommended that for the State University a yearly sum equal to 50 per cent. of the average yearly succession duties should be granted, while for the two independent institutions annual grants, to be adjusted every five years by a Court of Reference, should be made out of consolidated revenue. Should these grants be found insufficient, a direct tax for general educational purposes of one mill per dollar on the value of rateable property of the province is recommended. The question of the control of education in the universities was also discussed, and the Commission concludes that "the State, which gives financial support, has the right (a) to determine how this education may be most effectively and economically carried on, and (b) to exercise supervision over projected developments involving financial outlay."

WE are glad to see that the Library Association is issuing its Subject-Index to Periodicals for the years 1917-19, in continuation of the Class Lists for 1915 and 1916, and to learn that the association proposes to resume the annual publication of these indexes. It has just published in 87 quarto pages "Section F: Education and Child Welfare." As in former lists, the entries are arranged under subject headings, under each of which papers are placed in chronological order of date of publication. The difficulty in framing a thoroughly satisfactory classification for papers which discuss education from many different points of view has been met by introducing frequent cross-references. Among the subject headings we find sections for education in general, education in each country taken separately, higher education, education of children, education of women, secondary education, and teachers. There are also sections for technical education, agricultural education, chemistry teaching, the study of engineering, and the study and teaching of science. We notice also sections on universities and colleges and on many universities taken singly. Among sections coming under the head of child welfare we find child study, abnormal and backward children, care and hygiene of children, employment of children, exceptionally gifted children, and milk. The lists of papers on citizenship, rehabilitation of the disabled, and educational aspects of the European war are well worth examining at the present time. There are altogether in this index 2154 titles of papers taken from 242 English and foreign periodicals published during the three years 1917-19. The total number of periodicals examined by the compilers of the Subject-Index to Periodicals for all the subjects catalogued is now nearly six hundred. We hope that the circulation of these useful class-lists will be sufficient to ensure the continuance of their publication.

Calendar of Scientific Pioneers.

April 7, 1823. Jacques Alexandre César Charles died.—The first to substitute hydrogen for the hot air used in Montgolfier's balloons, Charles was originally a clerk, but rose to be professor of physics in the Conservatoire des Arts et Métiers. He is remembered by "Charles's law."

April 7, 1912. Abbott Lawrence Rotch died.—A pioneer in the study of the upper atmosphere, Rotch in 1885 founded the Blue Hill Observatory, which he bequeathed to Harvard University.

April 9, 1626. Francis Bacon, Lord Verulam, Viscount St. Albans, died.—Bacon was the contemporary of Galileo, Kepler, and Napier. He took all knowledge as his province. His "Novum Organum"—which was written and rewritten several times with the most minute care—entitles him to be considered as one of the leaders in the reformation of modern science. He is buried at St. Albans.

April 9, 1889. Michel Eugène Chevreul died.—For many years Chevreul was connected with the Musée d'Histoire Naturelle. His researches related mainly to the chemistry of fats.

April 10, 1813. Joseph Louis Lagrange died.—Though his parents were of French extraction, Lagrange was born at Turin, where he spent the first thirty years of his life. In 1766, on the invitation of Frederick the Great, he went to Berlin. "The greatest king in Europe" wished to have "the greatest mathematician in Europe" at his Court. On Frederick's death Lagrange accepted an offer of Louis XVI. and removed to Paris. Equally great as an investigator in pure mathematics and in applied mathematics, he has never been surpassed as a mathematical writer.

April 11, 1875. Samuel Heinrich Schwabe died.—The name of Schwabe, who lived and died at Dessau, is imperishably connected with the discovery of the periodicity of sun-spots.

April 11, 1884. Jean Baptiste André Dumas died.—Few scientific men in France have been held in higher esteem than Dumas. His success as a chemist was not less marked than his success as a public man, and in 1882 the French Academy struck a gold medal to commemorate his great services to science. His statue stands at Alais, where he was born in 1800.

April 11, 1895. Julius Lothar Meyer died.—The fellow-student of Roscoe in the laboratory of Bunsen at Heidelberg, Meyer afterwards held chairs of chemistry at Breslau, Neustadt, Karlsruhe, and Tübingen. His name is best known for the share he had in the periodic classification of the elements.

April 11, 1902. Marie Alfred Cornu died.—A brilliant experimentalist, Cornu in 1867 became professor of physics at the Ecole Polytechnique, and in 1896 was elected president of the Paris Academy of Sciences. His original work related mainly to optics. He also made a re-determination of the velocity of light.

April 12, 1897. Edward Drinker Cope died.—Curator to the Academy of Natural Sciences, and later professor of geology and palæontology at Philadelphia, Cope greatly extended the knowledge of fossil vertebrates.

April 13, 1855. Sir Henry Thomas de la Beche died.—Like Murchison, de la Beche left the Army at the end of the Napoleonic wars and devoted himself to geology. He became the first director of the Geological Survey of Great Britain, and founded the Museum of Practical Geology. E. C. S.

Societies and Academies.

LONDON.

Linnean Society, March 17.—Dr. A. Smith Woodward, president, in the chair.—W. B. Alexander: The vertebrate fauna of Houtman Abrolhos Islands, West Australia. Prof. P. Fauvel: "Annélides Polychètes de l'Archipel Houtman Abrolhos, recueillies par M. le Prof. Dakin."—F. Chapman: Sherbornina, a new genus of fossil Foraminifera from Table Cape, Tasmania.—Miss E. L. Turner: Some birds from Texel. The author devoted most of her attention whilst on the Island of Texel to the avocets, ruff and reeve, godwit, and two species of tern, describing the habits of the birds observed, especially during the nesting period.

Mineralogical Society, March 22.—Dr. A. E. H. Tutton in the chair.—Prof. H. Hilton: The vibrations of a crystalline medium. The paper attempts to give an indication of the kind of vibrations which the molecules of a crystal may be expected to make about their positions of equilibrium. The case of an orthorhombic crystal in the form of a rectangular parallelepiped is considered in detail, and the normal modes of the molecular motion are completely determined.—Prof. R. Ohashi: Augite from Nishigatake, Japan. The crystals have been detached from basalt by natural weathering; the specific gravity is 3.338 at 4° C. The prism angle agrees with that of diopside, but that of the pyramid does not. Etched figures show that the crystal belongs to the holosymmetric class. Both the optical properties and chemical composition show that in this augite the diopside molecule predominates.—Dr. G. T. Prior: The chemical composition of the Adare and Ensisheim meteorites. The results of the analyses supported the idea that in meteoric stones the ratio of MgO to FeO in the magnesium silicates varies directly with the ratio of Fe to Ni in the nickel-iron. For Adare these ratios were respectively $4\frac{1}{2}$ and 11, and for Ensisheim 3 and $3\frac{1}{2}$.—W. Barlow: Models representing the atomic structure of calcite and aragonite.

CAMBRIDGE.

Philosophical Society, March 7.—Prof. A. C. Seward, president, in the chair.—Prof. R. C. Punnett: A peculiar case of heredity in the sweet pea.—C. G. Lamb: (1) Insect oases. Certain species of Diptera occur for several consecutive years in extremely localised patches in a certain locality which was characterised by extreme uniformity in respect to its flora, etc. Several of the species are so far only known from that locality, and are of South European distribution. The suggestion was made that the species is putting up its last fight against extinction. (2) Venational abnormalities in Diptera. The great rarity of teratological conditions in the wings of flies other than the Nematocera was illustrated. An exception exists in the Ortalid, *Ptilonota guttata*. The instability of the species is confirmed by the commonness of great diversity in the acrostichal bristles, and by its having afforded the only known dipterous case of Batesonian teratology in an antenna.—Prof. S. J. Hickson: Some Alcyonaria in the Cambridge Museum. Two specimens collected by Darwin in the *Beagle* in the Galapagos Islands in 1835. One is clearly a representative of a species that has not hitherto been described, and the author proposes to name it *Cavernularia Darwinii*. The character which distinguishes it from all other species that have been described is seen in the spicules, which are short rods with two, three, or four knobs at each end. The other specimen preserved by Darwin in the Galapagos Islands is a frag-

ment of a Gorgonid, probably belonging to the genus *Septogorgia*. There are two other species of the genus *Cavernularia* in the collection, one *C. Chuni*, from the coast of Borneo, and the other *C. analabarica*, from the Bay of Bengal. They are the only sea-pens that have been described by the collectors as "washed ashore," and must therefore have either a floating habit or a very feeble attachment to the bottom. Specimens of the genus *Pseudocladochonus* from the coast of Japan have been hitherto recorded only from the Malay Archipelago. They show a remarkable resemblance to the extinct Carboniferous fossil *Cladochonus* of the family *Auloporidæ*, but, as pointed out by Versluys, the resemblance is probably due to convergence. A re-examination of some specimens of the genus *Vergularia* from the coast of Victoria, Australia, shows that they cannot satisfactorily be separated from the British and North Atlantic species *Vergularia mirabilis*. An Alcyonarian belonging to the genus *Sarcodictyon* came from the coast of South Australia, and is difficult to separate from the species *S. catenata*, which has hitherto been recorded only from the British area. These two species offer examples of geographical discontinuity.—**J. Gray**: The mechanism of ciliary movement. The movement of the cilia on the gills of *Mytilus edulis* was described. The effects of acids and of certain metallic ions seem to indicate that the mechanism of ciliary and muscular activity is essentially the same.—**A. B. Appleton**: The influence of function on the conformation of bones. A summary was presented of the effects produced on the mammalian femur of those muscular specialisations characteristic of cursorial, jumping, and arboreal types respectively. Consideration of the maximum effective leverage attainable by the adductor and femorococcygeus muscles in different positions of the thigh was shown to harmonise with some variations in their attachment in various mammalian groups.—**J. T. Saunders**: A note on the hydrogen-ion concentration of some natural waters. The hydrogen-ion concentration of waters occurring naturally in those districts where chalk, gault, or lime is present in the soil or subsoil is remarkably constant. Divergences are caused by the presence of large masses of vegetation, by debris stirred up from the bottoms by currents, or by the presence of sewage or other decaying organic matter.—**P. A. Buxton**: Animal ecology in deserts. The paper recorded some incomplete observations on desert life, the majority made in Mesopotamia under war conditions. Heat, dryness, terrific winds, low relative humidity, great diurnal range of temperature, the heat of the surfaces on which many of the desert animals crouch, and the brilliant direct sunshine are characteristic of the region. Protective coloration is a well-known characteristic of desert animals; it is difficult to see of what advantage it can be to purely nocturnal animals. The coloration of the courser is not efficient, because the bird's legs are long and it casts a sharp black shadow. The animals which are not protectively coloured are black. These are all probably protected by characters other than colour. The development of certain insects is inhibited in summer; probably the inhibitory factor is high temperature or low relative humidity; it is certainly not due to a drying up of the food-plant.—**J. Line**: The biology of the crown gall fungus of lucerne. The thallus of this fungus, *Urobhlyctis alfalfae* (Lagerh.), P. Magnus, is described. Resting spores are developed as simple terminal proliferations from the swollen hyphal ends, no conjugation process taking place. They produce a large number of zoospores on germination, which normally infect only the young adventitious buds of *Medicago sativa* and possibly *M. falcata*, causing the formation of galls.

EDINBURGH.

Royal Society, March 21.—Prof. F. O. Bower in the chair.—Prof. H. Briggs: An experimental analysis of the losses due to evaporation of liquid air contained in vacuum flasks. Liquid air and liquid oxygen are now being employed not only in the laboratory, but also to serve the airman in high flying, for mine rescue apparatus and blasting in mines and quarries, for evacuation plant, and for medical purposes. If a European war were ever to break out again, oxygen would, owing to the probable use of poison gases in enormous quantities, become the chief remedial measure, and would be required on a colossal scale. The experiments described in the paper gave a quantitative measure of the proportion of heat entering a vacuum flask containing liquid air (a) by conduction through the vacuum, (b) by radiation across the vacuum, and (c) by conduction along the neck; they further provided data for calculating the pressure in the vacuum space and the emissivity of the reflected surfaces bounding that space. The purpose of the investigation was to get information to assist in the design of metallic vacuum vessels.—**Dr. J. Marshall**: A generalisation of Lagrange's equations of motion and their Hamiltonian forms.—**Sir T. Muir**: Note on a continuant of Cayley's of the year 1874.

PARIS.

Academy of Sciences, March 14.—M. Georges Lemoine in the chair.—**E. Picard**: The determination of the axis of rotation and velocity of rotation of a solid body.—**H. Douvillé**: A brackish-water fauna at the top of the Lower Cretaceous near Bayonne.—**G. Gouy**: Imperfect aplanetism.—**L. E. Dickson**: The composition of polynomials.—**A. Witz**: An aviation motor admitting of a constant mass, with constant compression at all altitudes.—**Sir George Greenhill** was elected a correspondant for the section of mechanics in succession to the late M. Voigt.—**G. J. Rémouondos**: Couples of algebroid functions of one variable corresponding to the points of an algebraic curve of higher order than unity.—**C. E. Traynard**: Singular hyperelliptic functions.—**N. Abramesco**: Developments in series according to the inverse of given polynomials.—**T. Varopoulos**: Some points in the theory of functions and the theory of numbers.—**A. Denjoy**: A calculation of totalisation.—**T. Carleman**: A class of integral equations with asymmetrical nucleus.—**H. Mellin**: Solution of the general algebraic equation with the aid of the P function.—**J. L. Walsh**: The position of the roots of the derived functions of a polynomial.—**P. Le Rolland**: The deviations from the law of isochronism produced by the suspension strip of the pendulum. The suspension of a pendulum by an elastic strip of metal partially compensates the circular error for large amplitudes, but compensation is not possible at all amplitudes.—**A. Veronnet**: Hypotheses on the formation of new stars.—**J. B. Charcot**: The Island of Jan Mayen. This island was supposed to have been first discovered in 1611 by the Dutch sailor whose name it bears. The descriptions in the "Légende Latine" (ninth century) of the voyages of the Irish monk, Brennain Mac Finlonga (St. Brandan), include such an exact account of this island that the author agrees with E. Beauvois that the Irish monk must have been the first discoverer.—**F. Schrader**: The new universal atlas of Vivien de Saint-Martin and Schrader.—**M. Pariselle**: The hydrates of pyridine. Nine different hydrates of pyridine have been described. From a critical discussion of the data it is concluded that in no case is the evidence sufficient to prove the existence of a definite combination of pyridine and water.—**R. Audubert**: The elementary quantity of energy concerned in solu-

tion. An attempt to discover for the dissolved state a law equivalent to Trouton's law for the gaseous state. Calling ρ the molecular latent heat of solution and T the temperature which corresponds for the state of saturation to an osmotic pressure of one atmosphere, ρ/T should be constant if an analogous relation holds. For various salts in solution this ratio has a value of about 32.—**J. Meunier**: The principles of analysis by means of reducing flames; the detection of traces of manganese in the presence of iron or other substances. The material in the form of powder is carried away as dust in a stream of hydrogen which is ignited and the flame examined spectroscopically.—**L. Forsén**: The constitution and systematic representation of the complex derivatives of the molybdc acids.—**R. Fosse** and **G. Laude**: Syntheses of cyanic acid and urea by the oxidation in alcoholic ammoniacal solution of phenols and aldehydes. The production of ammonium cyanate and urea by the oxidation of ammonia and alcohols is favoured by the presence of copper. Thus with ethyl alcohol the yield of urea is increased from 0.85 to 8.32 grams per 100 c.c. of alcohol by the addition of copper salts. Details of the amounts of urea obtained are given for various alcohols, phenols, and aldehydes.—**M. Godchot**: Some derivatives of thuyamethone.—**O. Bailly**: The action of epichlorohydrin on disodium hydrogen phosphate in aqueous solution and the stability of a monoglyceromonophosphoric ester.—**A. Mailhe**: The preparation of the amines of secondary alcohols. The method of reduction of ketazines by hydrogen in presence of reduced nickel described in an earlier communication has been extended to ketazines of the formula $R \cdot CO \cdot R'$. Several new primary and secondary amines have been prepared.—**P. Gaubert**: The interference colours produced by thin crystalline plates.—**A. Briquet**: The low country of Picardy north of the Somme: the existing shore-line.—**R. Dongier**: The simultaneous oscillations of temperature and wind at the top of the Eiffel Tower and their relation with the Bjerknes steering surface of a depression. Two temperature charts on different days are given, showing the variations of temperature at the summit of the tower and at three lower levels; the variations of the velocities of the wind at the summit are also shown. The diagrams prove the existence of a current of warm air set in motion above the colder layers by forces always present in a depression. This is in good agreement with the views of Bjerknes on the structure of cyclones in movement.—**M. Delcambre**: A case of sudden filling of an atmospheric depression.—**R. Souèges**: The embryogeny of the Scrofulariaceæ: development of the embryo in *Veronica arvensis*.—**P. Nobécourt**: The action of some alkaloids on *Botrytis cinerea*.—**Mlle. D. Kohler**: The variation of organic acids in the course of anthocyanic pigmentation. Details of experiments proving that anthocyanic pigmentation is not accompanied by an increase in the amount of organic acids.—**E. Couvreur** and **X. Chahovitch**: A natural mode of defence against microbe infections in the invertebrates. Micro-organisms (pyocyanic and coli bacilli) are destroyed by the blood and digestive fluids of certain invertebrates.—**A. Thooris**: The morphological classification of fifty champion athletes. Metric verification by radioscopy.—**L. Mercier**: *Aptera pedestris*. The flight muscles in certain Diptera, wingless or with rudimentary wings.—**A. Lécaillon**: The action exerted by concentrated sulphuric acid on the eggs of *Bombyx mori*.—**H. Drouin**: Changes in the absorption by skin and muscular tissue brought about by the addition of lipoids to stannous solutions.—**W. Kpaczewski**: A simple apparatus for measuring surface tension.—**G. Blanc**: Experimental researches on the virus of herpes.

Books Received.

Artificial Light: Its Influence upon Civilization. By M. Luckiesh. (Century Books of Useful Science.) Pp. xiv+366. (London: University of London Press, Ltd.) 12s. 6d. net.

Creative Chemistry: Descriptive of Recent Achievements in the Chemical Industries. By Dr. Edwin C. Slosson. (Century Books of Useful Science.) Pp. xvi+311. (London: University of London Press, Ltd.) 12s. 6d. net.

Field Methods in Petroleum Geology. By Dr. G. H. Cox and others. Pp. xiv+305+xi plates. (New York and London: McGraw-Hill Book Co., Inc.) 24s. net.

The Chemistry of Plant Life. By Dr. Roscoe W. Thatcher. (Agricultural and Biological Publications.) Pp. xvi+268. (New York and London: McGraw-Hill Book Co., Inc.) 18s. net.

The Fauna of British India, including Ceylon and Burma. Mollusca, iii.: Land Operculates (Cyclophoridae, Truncatellidae, Assimineidae, Helicinidae). By G. K. Gude. Pp. xiv+386. (London: Taylor and Francis; Calcutta: Thacker, Spink and Co.; Bombay: Thacker and Co., Ltd.) 35s.

Thoughts of a Nature Lover. By Kenneth Rogers. Pp. 125. (London: Holden and Hardingham, Ltd.) 5s. net.

Municipal Engineering: Surveying the Scope of Municipal Engineering and the Statutory Position, the Appointment, the Training, and the Duties of a Municipal Engineer. By H. Percy Boulnois. (Pitman's Technical Primers.) Pp. vii+103. (London: Sir I. Pitman and Sons, Ltd.) 2s. 6d. net.

The Essentials of Mental Measurement. By Dr. William Brown and Prof. Godfrey H. Thomson. (Cambridge Psychological Library.) Pp. x+216. (Cambridge: At the University Press.) 21s. net.

A Short Manual of Forest Management. By H. Jackson. Pp. x+70. (Cambridge: At the University Press.) 7s. net.

Board of Education. Illustrated Catalogue of the Collections in the Science Museum, South Kensington, with Descriptive and Historical Notes: Machine Tools. Pp. 61+iii plates. (London: H.M. Stationery Office.) 1s. net.

Transactions of the Royal Society of Edinburgh. Vol. liii., part iv., No. 29. Isle of Wight Disease in Hive Bees. Pp. 737-79. (Edinburgh: R. Grant and Son; London: Williams and Norgate.) 9s.

Geological Survey of Nigeria. Bulletin No. 1: The Geology of the Plateau Tin Fields. By Dr. J. D. Falconer. Pp. 55+x plates. (Nigeria.) 10s. net.

Medical Research Council and Department of Scientific and Industrial Research. Reports of the Industrial Fatigue Research Board, No. 11. Preliminary Notes on Atmospheric Conditions in Boot and Shoe Factories. (Boot and Shoe Series, No. 2.) Pp. 60. (London: H.M. Stationery Office.) 3s. net.

A New British Flora: British Wild Flowers in their Natural Haunts. Described by A. R. Horwood. Vol. iii. Pp. xi+251+xviii-xxxi plates. Vol. iv. Pp. xi+257+xxxii-xlix plates. (London: Gresham Publishing Co., Ltd.) 12s. 6d. net each vol.

Bibliographie des Livres Français de Médecine et de Sciences. Publiée par la Section de Médecine du Syndicat des Editeurs. 1908-20. Pp. xiii+146. (Paris.)

Legislative Assembly, New South Wales. Report of the Director-General of Public Health, New South Wales, for the year 1919, including a Report on the Influenza Epidemic, 1919. Pp. v+272+x plates. (Sydney: W. A. Gullick.) 6s. 9d.

Universities and their Freedom. By W. M. Childs. Pp. 56. (London: A. L. Humphreys.) 2s. net.

Joseph Glanvill and Psychical Research in the Seventeenth Century. By H. Stanley Redgrove and I. M. L. Redgrove. Pp. 94. (London: W. Rider and Son, Ltd.) 2s. 6d. net.

Report of the Ninth Annual Conference of Educational Associations held at the University College, London, 1921. Pp. viii+470. (London: Conference Committee, 9 Brunswick Square, W.C.1.) 5s.

The Electro-Deposition of Copper and its Industrial Applications. By Claude W. Denny. (Pitman's Technical Primers.) Pp. xii+108. (London: Sir I. Pitman and Sons, Ltd.) 2s. 6d. net.

Diary of Societies.

THURSDAY, APRIL 7.

ROYAL INSTITUTION OF GREAT BRITAIN, at 3.—C. T. R. Wilson: Thunderstorms (Tyndall Lectures).
 LINNEAN SOCIETY, at 5.—Reginald A. Malby: A Miniature Alpine Garden from January to December.—H. W. Monckton: Exhibition of Various Forms of *Taraxacum erythrospermum*, Andr.
 CHILD-STUDY SOCIETY (at Royal Sanitary Institute), at 6.—M. Dainow: Original Research in Vocational Tests.
 INSTITUTION OF ELECTRICAL ENGINEERS (at Institution of Civil Engineers), at 6.—K. Baumann: Some Recent Developments in Steam Turbine Practice.
 CHEMICAL SOCIETY (at Institution of Mechanical Engineers), at 8.—Dr. F. W. Aston: Mass Spectra and Atomic Weights.

FRIDAY, APRIL 8.

ROYAL ASTRONOMICAL SOCIETY, at 5.—E. A. Milne: Radiative Equilibrium and Spectral Distribution.—E. A. Milne: Radiative Equilibrium in the Outer Layers of a Star: The Temperature Distribution and the Law of Darkening.—Prof. H. H. Turner: Note on Barnard's Observations of Nova Ophiuchi No. 2 (Hind, 1848) and of Nova Persei No. 2 (Anderson, 1901).—Guido Horn d'Arturo: A Spiral Nebula in the Northern Hemisphere of the Milky Way.—Major W. J. S. Lockyer and D. L. Edwards: The Spectrum of δ Cassiopeie in Relation to those of a Cygni and γ Cygni.—Rev. A. L. Cortie: The Ultra-violet Spectrum of Nova Aquilæ 1918 June 10.—Sir W. H. M. Christie: Observations of the Moon, Saturn, etc., made at Prof. W. H. Pickering's Observatory in Jamaica.

PHYSICAL SOCIETY OF LONDON (at Imperial College of Science), at 5.—Dr. W. J. H. Moll: A New Registering Microphotometer.—Sir William Bragg: The Examination of the Structure of Crystals in the Form of Powder by Means of the Ionisation Spectrometer.—H. Parry: A Balance Method of Using the Quadrant Electrometer for the Measurement of Power.

ROYAL SOCIETY OF MEDICINE (Clinical Section), at 5.30.—Dr. Ivor Davies: Hair Ball or Hair Cast of the Stomach and Gastro-Intestinal Tract. A Report of Two Cases with Specimens, and an Abstract of 108 Cases from the Literature.—Dr. M. Cassidy: Report re Case of Neoplasm of Lung.

ROYAL INSTITUTION OF GREAT BRITAIN, at 9.—Dr. R. H. A. Plimmer: Quality of Protein in Nutrition.

SATURDAY, APRIL 9.

ROYAL INSTITUTION OF GREAT BRITAIN, at 3.—Dr. M. H. Dale: Poisons and Antidotes.

MONDAY, APRIL 11.

ROYAL GEOGRAPHICAL SOCIETY (at Lowther Lodge), at 5.—E. Heawood: The World-Map before and after Magellan's Voyage.
 INSTITUTION OF ELECTRICAL ENGINEERS (Informal Meeting) (at Chartered Institute of Patent Agents), at 7.—F. Creedy and Others: Some Characteristics and Applications of Multispeed A.C. Motors.
 INSTITUTION OF MECHANICAL ENGINEERS (Graduates' Meeting), at 7.—L. H. Bedford: Electrolysis as Applied to Engineering.
 SERVATORS' INSTITUTION, at 8.—L. S. Wood: The Forestry Directorate in France.

ROYAL SOCIETY OF ARTS, at 8.—Dr. S. J. Lewis: Recent Applications of the Spectroscope and the Spectrophotometer to Science and Industry.

TUESDAY, APRIL 12.

ROYAL INSTITUTION OF GREAT BRITAIN, at 3.—Prof. R. A. Sampson: The Measurement of Starlight.

ROYAL COLLEGE OF PHYSICIANS OF LONDON, at 5.—Dr. T. Lewis: Observations upon the Nature of Auricular Flutter and Fibrillation (Oliver-Sharppe Lecture).

ROYAL PHOTOGRAPHIC SOCIETY OF GREAT BRITAIN, at 7.—H. M. Lomas: Problems of Kinematography.—R. J. Trump: A Shutterless Continuous Feed Kinematograph.

QUEKETT MICROSCOPICAL CLUB, at 7.30.
 ROYAL AERONAUTICAL SOCIETY (at Royal Society of Arts), at 8.—Major G. L. Taylor: Annual Wilbur Wright Lecture.

ROYAL ANTHROPOLOGICAL INSTITUTE, at 8.15.—L. H. Dudley Buxton: The Ancient and Modern Inhabitants of Malta.

WEDNESDAY, APRIL 13.

ROYAL SOCIETY OF MEDICINE, at 5.—Sir Thomas Harder, Mr. Clayton-Greene, Sir Berkeley Moynihan, Dr. D. Pennington, A. Evans, and Others: The Problems For and Against Team Work in this Country.

ROYAL SOCIETY OF MEDICINE (Proctology Sub-section), at 5.—Mr. Lockhart-Mummery, Sir Charles Gordon-Watson, and Others: Pruritus Ani.

ROYAL SOCIETY OF ARTS, at 8.—Prof. H. E. Armstrong: Low Temperature Carbonisation and Smokeless Fuel.

INSTITUTION OF AUTOMOBILE ENGINEERS (at Institution of Mechanical Engineers), at 8.—G. Watson: A Suggested Programme for Automobile Research.

THURSDAY, APRIL 14.

ROYAL INSTITUTION OF GREAT BRITAIN, at 3.—C. T. R. Wilson: Thunderstorms (Tyndall Lectures).

ROYAL SOCIETY, at 4.30.—*Probable Papers*.—Prof. K. Onnes, Sir Robert Hadfield, and Dr. H. R. Woltjer: The Influence of Low Temperatures on the Magnetic Properties of Alloys of Iron with Nickel and Manganese.—C. N. Hinshelwood and E. J. Bowen: The Influence of Physical Conditions on the Velocity of Decomposition of Certain Crystalline Solids.—N. K. Adam: The Properties and Molecular Structure of Thin Films of Palmitic Acid on Water. Part I.—E. P. Metcalfe and B. Venkatesachar: The Absorption of Light by Electrically Luminescent Mercury Vapour.

ROYAL COLLEGE OF PHYSICIANS OF LONDON, at 5.—Dr. T. Lewis: Observations upon the Nature of Auricular Flutter and Fibrillation (Oliver-Sharppe Lecture).

INSTITUTION OF ELECTRICAL ENGINEERS (at Institution of Civil Engineers), at 6.—E. A. Watson: Magnetos for Ignition Purposes in Internal Combustion Engines.

OIL AND COLOUR CHEMISTS' ASSOCIATION (at 2 Furnival Street), at 7.30.—F. H. Barry: Indian Products of Interest to the Oil and Colour Chemist.

OPTICAL SOCIETY (at Imperial College of Science), at 7.30.—F. Twyman: An Interferometer for the Testing of Camera Lenses.—W. Shackleton: The Testing of Heliograph Mirrors
 RÖNTGEN SOCIETY (at University College), at 8.15.

FRIDAY, APRIL 15.

ROYAL COLLEGE OF SURGEONS OF ENGLAND, at 5.—Prof. A. Keith: Demonstration of the Contents of the Museum.

SATURDAY, APRIL 16.

ROYAL INSTITUTION OF GREAT BRITAIN, at 3.—Dr. H. H. Dale: Poisons and Antidotes.

CONTENTS.

	PAGE
Standardisation of Vaccines, Toxins, and Antitoxins	161
British Dyestuffs Corporation	162
Alcoholology	163
Some Aspects of Psychology. By C. Ll. M.	164
Physiology for Students	166
Our Bookshelf	167
Letters to the Editor:—	
Light and Electrons—Sir Oliver Lodge, F.R.S.	169
Relativity and the Velocity of Light.—J. H. Jeans, Sec. R.S.	169
A Difficulty in Einstein's Gravitational Theory.—George W. Walker, F.R.S.; Prof. A. S. Eddington, F.R.S.	169
Atomic Structure.—Dr. Norman R. Campbell	170
British Plants Available as a Source of Industrial Alcohol.—Prof. M. C. Potter	170
Relativity, Space, and Ultimate Reality.—L. C. W. Bonacina	171
Molecular Structure and Energy.—Prof. J. R. Partington	172
Oceanographic Research.—Prof. W. A. Herdman, F.R.S.	172
Why do Worms Die?—Rev. Hilderich Friend	172
Stellar Magnitudes and their Determination. II.—Apparent Magnitudes: (b) Photographic. (<i>Illustrated</i> .) By H. Spencer Jones	173
Ocean Tides. By Prof. J. Proudman	176
Obituary:—	
John Burroughs	177
Notes	178
Our Astronomical Column:—	
Recent Brilliant Fireballs	182
Another Investigation of the Einstein Spectral Shift	182
Nova Aquilæ III.	182
The Galvanometric Measurement of Human Emotion. (<i>Illustrated</i> .) By Dr. A. D. Waller, F.R.S.	183
The Modern Londoner and Long Barrow Man	186
Pendulum Operations in India and Burma	187
University and Educational Intelligence	187
Calendar of Scientific Pioneers	189
Societies and Academies	189
Books Received	191
Diary of Societies	192



THURSDAY, APRIL 14, 1921.

Editorial and Publishing Offices:

MACMILLAN & CO., LTD.,

ST. MARTIN'S STREET, LONDON, W.C.2.

Advertisements and business letters should be
addressed to the Publishers.

Editorial communications to the Editor.

Telegraphic Address: PHUSIS, LONDON.

Telephone Number: GERRARD 8830.

The Coal Position.

TWO national coal strikes within six months have rudely forced upon the British public the appreciation of the fact that our national economic system is entirely based upon our coal production. We are dependent upon coal in a way that no other nation is; we are living in a country that cannot grow sufficient food to supply the population, and we exist only by virtue of being able to import food to make up the deficiency in our home production, and, needless to say, we can pay for this importation only by our exports. Now coal is practically the only material product that we do export; apart from the relatively small quantity of coal exported as such, we indirectly export coal on a vast scale; when we import Spanish iron ore and export steel rails, or when we import American cotton and export piece goods, we are indirectly exporting coal—the coal that has been used in converting the raw materials into the finished articles that we sell; when a steamer, bunkered in this country, carries goods from any part of the world to any other part, the freight paid to the shipowner is in part payment for coal exported from this country. In its manifold applications coal is the only asset that we possess which enables us to liquidate our indebtedness to other nations, and thus it is that our

coal supply is of vital importance, not only to our prosperity, but even to our very existence.

The factors that have contributed to place us in the premier position (until recently) amongst the world's coal exporters are well known and sufficiently obvious. Until last autumn we maintained that position; when, however, a general coal strike was declared, those countries which had hitherto been dependent upon us for their coal supplies decided that they could not risk being dependent upon the continued disturbances in the coal mining industry of this country with winter coming on apace, and hence made haste to cover their coal requirements wherever they could, and that was, of course, mainly from the United States. Thus, to take France as an example, that country imported in the first eleven months of 1920 about 1,982,000 tons of American coal, of which 1,309,000 tons were imported in October and November. It is far easier to lose a market than to regain it, and the first condition for controlling a market is the ability to supply it steadily as required. This second coal strike is scarcely likely to inspire in our customers abroad any confidence in our ability to fill orders whenever they need coal, and will certainly cause them to look for more trustworthy sources of supply. Our only chance of regaining our leading position would appear to be if we had such pre-eminence both in the quality and in the quantity of our coal resources as would ensure us an advantage over our competitors. This is, however, far from being the case. As regards quality no doubt we hold the first place; no country produces coals equal to ours on the average, and in this respect Nature has dealt generously with us. The question of the quality of coal is, however, not one of very great importance; modern inventions have shown us how to utilise inferior coals for practically any purpose, and it seems quite certain that the limits of the resources of science in this direction have by no means been reached.

It is, after all, more a question of cost than of anything else; the purchaser of coals buys potential thermal units, and he will naturally buy that coal, whatever be its quality, which will give him the maximum number of thermal units at a given price. It is impossible to discuss the coal question in any way adequately without taking the cost of the coal into serious account. Nature has favoured us not only in the quality of our coal, but also in its mode of occurrence and in the comparative ease with which it can be produced; a comparison between, for example, the magnifi-

cent, thick, flat-lying seams of Yorkshire and the steep-lying, contorted, and crushed-up seams of Belgium will illustrate this point, and will incidentally bear tribute to the skill of Belgian engineers and to the steady, hard-working powers of the Belgian coal miners that have enabled them to sustain competition with the odds so much against them. Again, we have the advantage that most of our important coalfields are within easy access of the seaboard and of first-class harbours; had it not been for this fact, it is doubtful whether our coal industry would have maintained its position so long as it has done.

The official estimate of the cost of production of coal in this country for the last quarter of 1920 is 39s. 9-82*d.* per ton, exclusive of interest on capital, amortisation, depreciation, and similar book charges. There are at least three great countries in the world—India, China, and South Africa—where coal can be sold at 6s. per ton, or, say, about one-seventh of what it can be sold at in this country at the pit's mouth. Seeing that these three countries contain nearly one-sixth of the total coal resources of the world, they are obviously formidable competitors potentially, and once they have organised their means of transport so as to distribute economically their cheaply gotten coal, it is surely obvious that our only chance of holding our own is to reduce drastically the cost of coal production in this country. No one needs to be told that this end cannot be attained by ceasing work and drowning out pits; it can only be the result of close, cordial, and unfettered co-operation between miners, technologists, and employers, all directed towards securing the maximum possible output at the lowest possible cost. Unfortunately, our output has been going down steadily; for the last quarter of 1920 the average for the kingdom was only 41.15 tons per person employed, and it is significant that South Wales, where coal is perhaps more easily gotten than in any of our other coalfields, is amongst the lowest in the list. Let it be borne in mind that the above quarterly rate of production corresponds to only 165 tons per annum; it, of course, includes a strike period, but, nevertheless, we may contrast this figure with 260 tons, the output per person per annum in 1913; with 320 tons, the output per person per annum for the decade 1883-92; or even more startlingly with 768 tons, the output per worker in the United States for the year 1917; and it is surely clear that a properly directed effort would enable us to produce coal at a far lower pithead price per ton than that prevailing at

present without necessarily involving any very serious reduction in the miners' wages.

Again, it must be noted that our coal reserves are comparatively unimportant. According to the careful estimates made in 1913, the world's known coal resources amount to about 7,400,000 millions of tons; of this quantity the United States holds more than 3,800,000 millions, or above half. Great Britain's resources, which may be considered as fairly well known, are barely 190,000 millions, or, say, one-twentieth of those of the United States. The entire British Empire is credited with about 1,800,000 millions of tons, of which by far the greater portion, or 1,230,000 millions of tons, is in the Dominion of Canada. The coal in Great Britain constitutes, therefore, only about one-tenth of that in the British Empire. Whilst these figures indicate clearly enough in whose hands the ultimate control of the world's coal supply must rest, they are perhaps less important as regards the near future, with which we are at the present moment more directly concerned, than is the relative producing capacity of the world's chief actual producers. In this respect Great Britain occupies a far more important position. In 1919 the United States produced nearly 494 millions of tons, Great Britain more than 233 millions, and Germany 210 millions, these three countries together being responsible for 80 per cent. of the world's output. Seeing that Great Britain, with reserves amounting to only about 2½ per cent. of the world's total, is producing at the rate of about 20 per cent. of the world's annual output, it is manifest that we are encroaching upon our reserves far more rapidly than anyone else, and the supreme importance to us of not parting with our chief national asset, save at a fair profit, is self-evident.

In this light the complete economic unsoundness of the suggestion that the coal industry should be subsidised out of the national funds becomes glaringly evident, as it would amount to paying the foreigner out of the pockets of the taxpayer for taking from us the most valuable asset that we possess. Cheap coal has been the foundation of our national prosperity, and this prosperity will last only so long as we can produce coal at prices low enough to enable us to compete on fair terms with other nations in the markets of the world. Whenever we are no longer able to do this, our national supremacy, our prosperity, and our independence, for which so many thousands have sacrificed their lives, will have been lost forever.

The Conquest of Venereal Disease.

Prevention of Venereal Disease. By Sir G. Archdall Reid. With an introductory chapter by Sir H. Bryan Donkin. Pp. xviii+447. (London: William Heinemann, Ltd., 1920.) 15s. net.

SIR ARCHDALL REID commences the preface to this volume with the following sentence, characteristic of a man with strong convictions and courage to express them: "If the evidence in this book be true, the public should know."

It is fitting that Sir Bryan Donkin should write an introductory chapter to this very important work, for it was he who first, by a letter to the *Times* in January, 1917, publicly championed the cause of self-disinfection, and set the ball rolling in favour of the only obvious practical method of prevention of venereal disease by the adoption of the scientific principles founded upon the discovery of Metchnikoff and Roux, published in 1906. This showed conclusively that syphilis could be successfully prevented by the prompt use of calomel cream "after the subjects of the experiments, both human and simian, had been carefully inoculated with the poison of this disease."

Sir Bryan rightly gives credit to Dr. H. N. Robson, who courageously advocated this method in a book entitled "Sexual Disease and its Medical Prevention," published in 1909. He also points out that Sir Frederick Mott, a member of the Royal Commission, had written (prior to the war), in an authoritative medical treatise concerning the application of Metchnikoff's experiments, that "it would be well if this were widely known and practised in the civil population," which, we might add, he has continued to advocate ever since.

This work of Sir Archdall Reid is issued under the auspices of the Society for the Prevention of Venereal Disease, and throughout we find evidence of the struggle which has taken place between the National Council for Combating Venereal Disease and the principle of self-disinfection advocated by the former society.

In chap. ii. "The Urgency of the Problem" is discussed, and we quote this very important statement of the author in support thereof: "After every great war a considerable increase of venereal disease has been recorded; the greatest of all wars is not likely to furnish an exception." The author roughly calculates that "some 2,000,000 men suffered during the five years of war."

Referring to his own experience in the prevention of venereal disease at Portsmouth, the

author says: "Towards the end of 1917 it became known at the War Office that a method existed of protecting troops from venereal disease so effective that the rate of infection was reduced to 1.5 per thousand. Arrangements were made to apply this method to the whole Army." It looked at first as if the authorities were going to apply efficiently the simple sanitary instruction by medical officers, and thereafter to institute a vigorous inquiry if any medical officer failed to achieve success. But nothing was done to apply the method in a thorough and efficient manner, and, to quote the author's own words:—

"In the interval between the resolve to introduce the new method and the provision of the new apparatus an incredible thing had happened. At the time of the great German offensive there were, but need not have been, in the venereal hospitals or in depôts as convalescents British, French, and American soldiers, mature and trained men, otherwise fit for active service, sufficient not for an army corps only, but for a great army. All these men had become diseased after the authorities had learned how to prevent disease. They were put out of action, and the Allied cause brought to the verge of ruin by the fanaticism of a few 'influential people' and the complaisance or timidity of a few obliging officials."

The author goes on to say: "I am sure I have not exaggerated as to the effect that the failure to deal resolutely with venereal disease had in the fortunes of the British Army at the time of its greatest need."

We do not agree with all the author says regarding the Final Report of the Royal Commission on Venereal Disease, or with his deductions therefrom; he states that the evidence received indicated that the number of persons who have been infected with syphilis, acquired or congenital, cannot fall below 10 per cent. of the whole population in the large cities, and the percentage affected with gonorrhœa must greatly exceed this proportion. He assumes that, because cases of gonorrhœa are six or seven times as common as those of syphilis, 70-80 per cent. of the population of large towns have suffered from venereal disease. Such a deduction, in our judgment, is not warranted, for there is the obvious fallacy that a man may have several attacks of gonorrhœa, and we do not think he is right, therefore, in asserting that such a large proportion as 30-50 per cent. of the inhabitants of Great Britain have suffered from venereal disease. Sir Archdall Reid is probably correct when he states:—

"Venereal diseases are, in fact, by far the most prevalent of all the more serious diseases. To-

gether they constitute a principal, if not quite the principal, cause of poverty, insanity, paralysis, blindness, heart disease, disfigurement, sterility, disablement, and the life of pain to which many women are condemned. Our hospitals, asylums, and homes for the broken are crowded with their victims. The cost in loss of efficiency, therefore in money, is incalculable. More than anything else they are responsible for the blunting of the moral sense, not only in the people who poison for private profit or pleasure, but also in those who, careless of this vast flood of misery, seek to obstruct the path of the reformer."

Venereal diseases, the author states in chap. iii., on "Instinct and Reason," would die out in a few years if all men and women were chaste; but he points out that sexual love is an instinct in that it is not learned. It develops infallibly as the individual matures, and without antecedent experience it manifests itself at the proper time. Can it, therefore, be hoped that preaching and teaching will make all men and women avoid promiscuous sexual intercourse when social conditions are such as they are?

This and the next chapters on "Development of Mind and Character" and "Inclination and Morality" show philosophic reasoning, and are interesting as embodying the opinions and judgments of an original-minded man of wide knowledge and with experience of human character. The author discusses the moral side of the question, and says: "No one could, or would, be moral unless he had learned to be moral." The instinct, always the same in kind if not in degree, is passed from generation to generation by Nature from the most remote times. He shows how sexual morality changes with religion and racial traditions; he points out that "good teaching by adults in matters sexual is hopelessly out of reach in England"; and, "because the country is not of one mind as regards morals, venereal disease therefore is not likely to be banished or even checked by an improvement in public morality. The only conceivable alteration is sanitation."

A very important statement is the following:—

"There is a terrible superstition very current among the ignorant that venereal disease may be cured by 'passing it on.' Above all, fear of infection causes many men to seek satisfaction of their desires from 'decent' women, as many an unhappy girl has found to her ruin. It is from the ranks of these unfortunates that the whole army of prostitutes is recruited, for no woman voluntarily begins a career of immorality as a prostitute. On the whole, then, as far as I am able to judge, venereal disease does not check immorality, but tends vastly to increase it."

Chap. vi. is an interesting account of "Microbic Diseases" and how they have been efficiently dealt

with by the application of scientific methods. In chap. vii., "Metchnikoff," the author gives an interesting historical account of the origin of venereal disease and its prevalence.

Chap. viii. deals with "The Report of the Royal Commission." The author criticises it most severely, and, we think, unfairly, for not recommending the application of Metchnikoff's discovery as a means of preventing venereal disease, but it must be remembered that the evidence appeared to show that salvarsan treatment in the primary stage would lead to a cure. The author gives the Commission no credit for creating a new public opinion upon the hitherto "hidden plague" and the urgent necessity of preventing it.

We can, however, understand that a reformer like Sir Archdall Reid, with the courage of his convictions, must be forgiven if he attacks relentlessly all who differ, or seemingly differ, from him, because willing to compromise in the hope that public opinion may be more easily changed and brought round to a sensible view.

The National Council was formed to promote the recommendations of the Royal Commission, and it comes in for severe criticism—rightly so, we think—for a number of its medical experts left the National Council to found the Society for the Prevention of Venereal Disease because they felt convinced that the policy of moral suasion, teaching, and fear of the serious consequences of contracting the disease had not had any marked deterrent effect upon promiscuous sexual intercourse and the incidence of venereal disease.

Chap. ix. deals with "Venereal Disease in the Army." This is a very interesting chapter, because the author tells how he successfully dealt with venereal disease. Every man joining was medically examined within twenty-four hours, and instructed by lecture and poster how to avoid infection: first, to avoid exposure to infection; secondly, by self-disinfection immediately after exposure. For this purpose the soldier must carry in his waistcoat pocket a small flat bottle containing 1 in 1000 of solution of permanganate of potash and a swab of cotton-wool. Instructions were given to swab the parts exposed to infection with the disinfectant immediately after intercourse. This simple method, thoroughly carried out, had the effect that venereal disease vanished from his unit. "In two years and four months, during which time 20,000 men must have passed through my hands, only seven men were infected" (p. 130). Does not the author, having regard to the following sentence from p. 132, mean 2000? At the end of this chapter the author states that "200 men belonging to one unit who came for demobilisation from the Continent, and arrived

at our barracks one evening in the last week of April, 1919, furnished thrice as much disease as 2000 in two years and four months."

In chap. x., "Quick Disinfection," the author attacks the policy of the National Council of preaching and treating, and the Army authorities for not adopting the one thing necessary for success—to insist on, and enforce, the careful instruction of the men in the use of the disinfectant.

In chap. xi. the author gives "Comparative Statistics," and he quotes some remarkably satisfactory results of Surgeon-Commander P. H. Boyden: "Amongst 496 men employing this method, one case of syphilis is recorded, but in this case the treatment was used six hours after exposure."

Civilian early-treatment centres were advocated by the National Council, but, as might have been expected, both borough and county councils rejected them as impracticable and costly, and Manchester alone has made a trial of this means of preventing venereal disease. There are 183 treatment centres, and where these are necessary prophylactic measures are more necessary, and it is to be hoped that the Ministry of Health will now see that the simple and inexpensive measure of self-disinfection is the only practical method of dealing with this problem—a procedure which, in the hands of Sir Archdall Reid, has proved so eminently successful, and which the Society for the Prevention of Venereal Disease has consistently advocated.

In chaps. xv. and xvi. Sir Archdall Reid gives an adequate explanation of a misapprehension that might have arisen from the evidence he gave before the Inter-Departmental Committee regarding the trustworthiness of his figures and the value of his work, and it is not surprising that he should make and prove charges of misrepresentation of facts by officials through the mouth of Lord Sandhurst when the latter took part in a debate upon a motion by Lord Willoughby de Broke in the House of Lords. The author in chap. xvii., "Lord Sandhurst's Apologetics," vindicates his position regarding his statistics of venereal disease in Portsmouth Town, which is not the Portsmouth area that was quoted.

The report of a Committee appointed by the Birth Rate Commission to take evidence upon the prevention of venereal disease found in favour of immediate self-disinfection; but the only *sure* method they advised is to avoid promiscuous sexual intercourse. Having regard to the composition of this Committee, Sir Archdall Reid has therefore the satisfaction of knowing that he is a pioneer who has convinced those whom he thought were irreconcilable to his views.

We can cordially recommend this work to all readers of NATURE, on account of its philosophic and scientific character and the fearless courage with which the author has successfully resisted and attacked the authorities who stood in the way of the adoption of scientific methods for the prevention of disease at a critical period of the nation's history.

Plant Evolution.

Studies in Fossil Botany. By Dr. Dukinfield H. Scott. Third edition. Vol. i. *Pteridophyta*. Pp. xxiii + 434. (London: A. and C. Black, Ltd., 1920.) 25s. net.

IN the preface to the first edition of his "Studies," Dr. Scott stated that his object was not to write a manual of fossil botany, but to present to the reader "those results of palæobotanical inquiry which appear to be of fundamental importance from the botanist's point of view." The fact that the third edition of vol. i., which deals with the Pteridophyta, needed as thorough a revision as the second edition shows that recent palæobotanical research has not been barren of results. "The only direct evidence which is possible in questions of descent among plants is from the ancient plants themselves." The interpretation of the evidence is the difficulty; not only did many of the types preserved in the rich plant-bearing beds of the Carboniferous period greatly exceed in size their modern representatives, but they were also more complex in structure. Generalised or synthetic types are common enough, and the inference is usually drawn that these extinct genera indicate the common origin of groups or families now comparatively remote; ancestral stocks are imagined, not discovered. Even the oldest known land plants, though in some respects simpler than those which followed them, appear to be far advanced in their anatomical differentiation, and the mechanism of the plant machine is essentially similar to that of existing plants.

We have, it must be admitted, not progressed very far towards "the completion of the natural system." The farther we penetrate into the past, the more fascinating becomes the search for origins. Lines seem to converge; but it may be that, with our imperfect vision, we see parallel lines of evolution as though they converged. The author, in speaking of *Asteroxylon*, one of the most ancient of terrestrial plants, with his usual caution suggests that the characters of the genus are indicative of a union of the fern and lycopod

groups, but he adds that these characters "may, after all, admit of a different explanation." It may be that he has less faith in common ancestors than he once had, and if this surmise be true he is not alone in this sceptical attitude. Dr. A. H. Church believes that ferns and lycopods represent separate lines of evolution from unicellular flagellates, and, as Dr. Scott remarks, it would be rash to reject Dr. Church's hypothesis of transmigration simply on the ground of the synthetic nature of such a plant as *Asteroxylon*.

Few additions have been made to the earlier chapters of the volume. To that on *Sigillaria* and allied genera an account has been added of a remarkable heterosporous lycopodiaceous cone from the Coal Measures, the genus *Mazocarpon*, described by Dr. Margaret Benson. The section devoted to the ferns, which has been in part rewritten, is a particularly welcome contribution to a puzzling subject. It is now recognised that the ferns did not hold the dominant position in the Palæozoic period formerly assigned to them; there were tree ferns and simpler herbaceous genera exhibiting a wide range in their morphological characters, in some features strikingly similar to modern forms, in others very different. Their origin is an unsolved problem. The admirable work of Dr. Kidston and the late Prof. Gwynne-Vaughan on the fossil *Osmundaceæ* is briefly summarised, and the recent researches of Dr. Gordon, M. Paul Bertrand, and others on the *Botryopteridaceæ* are described and correlated with conspicuous success.

In the last chapter Dr. Scott gives a very good account of the already famous genera *Rhynia*, *Hornea*, and *Asteroxylon*, founded on exceptionally well preserved material from a bed of Middle, or possibly Lower, Devonian chert discovered in 1913 by Dr. Mackie, and thoroughly investigated by Dr. Kidston and Prof. Lang. These plants, admirably described and illustrated in Prof. Bower's lectures, published in *NATURE* for July 29 and August 5, 1920, afford us glimpses of what, so far as we know at present, is the oldest land vegetation; though separated by an interval of several hundred millions of years from existing plants, they exhibit anatomical characters wonderfully similar to those of certain recent types. In some respects these Devonian genera are more primitive than any living *Pteridophytes*, and, like so many extinct plants, they appear to have attributes of phyla that are now widely separated. What was their history? Do they bring us within sight of the transition from algæ to vascular plants suggested by Dr. Arber (in a

NO. 2685, VOL. 107]

posthumous book,¹ to which Dr. Scott refers), and advocated with much ability and ingenuity by Dr. Church in a recent memoir? Whatever the significance of the older Devonian plants may be, botanists have now an opportunity of reading an excellent account of the facts.

It is superfluous to commend Dr. Scott's book to botanists familiar with the earlier editions, but one may express the hope that this up-to-date survey of the field selected for treatment, presented in a form which reflects the greatest credit upon author and publisher, may lead many botanical students to appreciate at their true value the older records of the rocks, and to endeavour to form an unbiassed opinion on the bearing of palæobotanical evidence on the general question of the method by which the plant world has been evolved. As Prof. Bateson says, "we have got to recognise that there has been an evolution." Is it true, as we are often assured, that the study of fossil plants confirms the orthodox views on progressive development, or do the results of modern research into the floras of the past compel us to admit greater ignorance of the course of plant evolution than is generally allowed? The great value of the volume under consideration is that it gives us a well-proportioned statement of the more trustworthy results of palæobotanical inquiry, and provides the student with the means of forming his own conclusions.

A. C. SEWARD.

A Modern Inorganic Chemistry.

A Text-book of Inorganic Chemistry for University Students. By Prof. J. R. Partington. Pp. xii+1062. (London: Macmillan and Co., Ltd., 1921.) 25s.

THE general arrangement of this book is logically worked out on a well-ordered plan, and the author has a straightforward and easy style. The result is a very readable volume, which is, in our opinion, the best of its kind in the language.

The introductory chapters are excellent, as also are those sections dealing with the development of fundamental chemical theories during the nineteenth century. In fact, the historical aspects of the subject are well emphasised throughout. (We must, however, dissent from the desirability of referring atomic weights to the standard $H=1$. The difficulties from the point of view of the student caused by the use of the oxygen standard

¹ This volume, entitled "Devonian Floras," was published in January last.

seem to us to be exaggerated, and the present moment is a particularly unfortunate one for such a departure.) With this broad historical treatment is happily combined an essentially modern outlook when dealing with the details of the subject. The new lines of advance opened up by the development of physical chemistry receive their full meed of recognition, and short chapters are devoted to explaining the principles on which these methods of investigation are based. Some of these chapters are less satisfactory than others. That on voltaic cells, for example, comprising eleven pages, deals with a great range of topics in what is necessarily a compressed and scrappy fashion, and will not convey much to a reader new to the subject.

The descriptive portions of the book have been critically compiled, though we think that more scepticism might have been displayed in assigning definite formulæ to such classes of compounds as basic salts, hydrated oxides, etc. Much recent work is included, and the same applies to the sections dealing with technical processes, where it is pleasant to find an up-to-date treatment of such subjects as sulphuric acid concentration and the Deacon process, and a mention of electrostatic precipitation, flotation processes, and electromagnetic separation. The relative importance of a process is not, however, always reflected by the amount of space it occupies in the text. Blast-furnace copper smelting is less adequately treated than the Welsh process, and electrolytic alkali processes are represented by one obsolete and one obsolescent cell.

Mistakes appear to be very few. Attention may, however, be directed to the fact that in practice calcium cyanamide is not produced in an arc furnace (p. 544); also that Alfred, not Alphonse, Werner is the author of the co-ordination theory of valency (p. 1011).

The only criticism of the book, as a whole, that we are inclined to make is that the author has perhaps been too loath to omit details of minor importance, or, as already indicated, subjects the adequate treatment of which would demand considerably larger space. The volume is large in size, and the price correspondingly high. It contains more material than is required for the average Pass degree, but not enough for the average Honours degree; and these circumstances may adversely affect the use made of it by university students, for whom it is professedly designed. But the book is so good that one must hope that this will not be the case.

It remains to congratulate the publishers on their share of the work.

A. J. A.

Our Bookshelf.

The Subject Index to Periodicals. 1917-19. B-E. Historical, Political, and Economic Sciences. 496 cols. (pp. 248). (London: The Library Association, 1921.) 1l. 1s. net.

THIS section of the "Subject Index to Periodicals," indexing papers on historical, political, and economic sciences, contains above 12,000 entries taken from more than 400 English and foreign periodicals published during the years 1917-19. Though it is not a catalogue of science, the economic problems affecting the development of industrial science are indexed. Folk-lore is no longer included in this list, but has been transferred to List A: Theology and Philosophy. Headings relating to Prehistoric Man and to local Topography are to be included in List G: Fine Art and Archæology. Among the subjects indexed in the present list are "Commercial Aeronautics," "Agriculture," "Chemicals: Manufacture and Industry," "Coal Trade," "Industrial Efficiency," "Electric Industries," "Ethnology," "European War," "Factories," "Fisheries," "Forestry," "Food Supply," "Iron Industry," "Labour," "League of Nations," "Military Art and Science," "Railways," and "Sociology."

Those who are interested in problems connected with the changed economic conditions brought about by the war will find in this list the titles of most of the papers that have been published on these subjects during the three years indexed. The catalogue will also have an historical interest as showing what we were all thinking about during the second half of the war period.

Year-Book of the Scientific and Learned Societies of Great Britain and Ireland. Thirty-seventh Annual Issue. Pp. vi+354. (London: Charles Griffin and Co., Ltd., 1920.) 15s.

WE welcome the thirty-seventh edition of this useful annual, which is invaluable as a guide to the many scientific societies, of local as well as of more general interest, in the United Kingdom. In it will be found a record of the work done in science, literature, and art during the academic year 1919-20, and it is gratifying to note that the small increase in price is balanced by an increase in size of nearly twenty pages, which testifies amply to the further activities of our men of science. The volume is divided into a number of sections dealing respectively with science generally; astronomy; mathematics and physics; chemistry; geography and geology; biology; economics; mechanical sciences; naval and military science; agriculture; law; literature and history; psychology; archæology; and medicine. A noteworthy feature is the inclusion of particulars from scientific institutions and departments connected with Government service. Among these are the Meteorological Office, the National Physical Laboratory, the Geological Survey, the Natural History Museum, the Ministry of Health, the Medical Research Council, the Royal Observa-

tory, and the Imperial Institute. That the work is up to date is shown by the inclusion of the Institute of Physics, which was incorporated during the past year. We have so far noted one omission only—the Imperial Mineral Resources Bureau.

The World of Sound: Six Lectures delivered before a Juvenile Auditory at the Royal Institution, Christmas, 1919. By Sir William Bragg. Pp. viii+196. (London: G. Bell and Sons, Ltd., 1920.) 6s. net.

THOUGH the original purpose of these lectures was to arouse the interest of juveniles in the phenomena of sound and their applications, they must have appealed with equal force to those adults who were so fortunate as to hear them. Here the lectures are put into book form, with necessary diagrams and additional dainty illustrations which add much to the attractiveness of the text. Even to the student who is conversant with the ordinary text-books, much of the information must be new; this is particularly the case in the lecture on "Sounds of the Country," in which are described the methods by which sound-waves are generated by insects and by the passage of wind through the foliage of trees. In the following lecture on "Sounds of the Sea" the most attractive subject is the gradual development of the human ear from the simple rudimentary ear of the fish. The interest of the subject culminates in the last lecture on "Sounds in War," where Sir William Bragg's first-hand knowledge is applied to the description, in the simplest language, of the ingenious devices used in locating submarines, enemy guns on land by "sound-ranging," and the direction of enemy mining operations by the geophone.

The Wild Unmasked. By F. St. Mars. Pp. 376. (London and Edinburgh: W. and R. Chambers, Ltd., 1920.) 6s. net.

THE author has a gift of picturesque vision and delineation. There is no mistaking a strong imaginative power. We see this in the very first sketch of the interior of a wasp's nest and in the life-history of an intrusive parasitic beetle. The day's work of a sparrow-hawk, a water-vole's flitting, a fight between a big rat and a stoat, the adventures of an otter, a fight between a wild cat and a fox—such are some of the subjects of this romantic book. Prominence is given to the competitive side of the struggle for existence, which is one side of the truth, and many pages, like some in Nature's book, are lurid. We are not prepared to accept everything Mr. St. Mars infers, such as the shrew's death from a sudden noise, but the whole book expresses personal observation. What is first-class in the book is its vividness—it is not a study in still life, but in strenuous, palpitating endeavour. What is dubious is the extent to which the author pushes his anthropomorphism. With big-brained animals it seems a legitimate hypothesis, but in regard to sea-anemones it palls. What is more

than dubious, in our judgment, is the occasional use of phraseology like "Mr. Passer," "Mrs. Hare," and pet names for wild animals. They strike a false note. The book would have been finer if it had been less facetious.

An Introduction to the Structure and Reproduction of Plants. By Prof. F. E. Fritch and Dr. E. J. Salisbury. Pp. viii+458+2 plates. (London: G. Bell and Sons, Ltd., 1920.) 15s. net.

THE two parts of this work deal respectively with the anatomy and the life-histories and reproduction of plants. A large number of the anatomical figures are original, and although they vary in quality, many of them are excellent for their purpose. A few, however, show evidence of hasty sketching. As a reference book for first-year university students, it is the most useful we have seen. Although its treatment is fuller in many respects than an average first-year student can compass, yet this is perhaps an error in the right direction. Of special interest may be mentioned the chapters on cell contents, secretory organs, and anatomy in relation to habitat, as well as the final chapter on heredity and evolution. The book will form a very useful addition to the introductory text-books on structural botany.

Annuaire pour l'An 1921, publié par le Bureau des Longitudes. Pp. viii+710+A 42+B 17+C 69. (Paris: Gauthier-Villars et Cie, n.d.) 8 francs net.

THIS widely used handbook contains all the old, well-known features, and in addition some new ones. The astronomical, physical, and political tables are very full; there are useful maps of the magnetic declination, inclination, and horizontal force in France in 1911, also full instructions for constructing sundials, and a set of star maps, with directions for their use. M. G. Bigourdan contributes a useful and lucid article on the proper motions and radial velocities of the stars, addressed to readers who have little previous knowledge of the subject. Gen. Bourgeois contributes a biographical notice of Gen. Bassot (1841-1916), whose name is well known among workers on geodesy. The civil day (commencing at midnight) is used throughout this handbook; this system will become universal at the beginning of 1925.

Lectures on the Principle of Symmetry and its Applications in all Natural Sciences. By Prof. F. M. Jaeger. Second (augmented) edition. Pp. xii+348. (Amsterdam: Publishing Company "Elsevier," 1920.)

THAT a second edition of this inspiring treatise on crystallography has been issued so soon—the first edition was reviewed in NATURE for June 6, 1918—is sufficient guarantee of its worth. Substantially, the volume is the same as the earlier edition, but the author has taken the opportunity to correct a number of minor errors and to make a few additions which the passage of time has shown to be desirable.

Letters to the Editor.

[The Editor does not hold himself responsible for opinions expressed by his correspondents. Neither can he undertake to return, or to correspond with the writers of, rejected manuscripts intended for this or any other part of NATURE. No notice is taken of anonymous communications.]

"Space" or "Æther"?

YOUR readers are indebted to Mr. Bonacina's letter in NATURE of April 7 for a very clear statement of a fundamental point in the relativity controversy, and it is important that the views held with regard to it should be clearly understood. The issue is stated concisely in the sentence "the relativists seem now . . . to indicate that space, instead of being conditioned by matter, is itself the foundation of matter and physical forces." Now it seems clear that if any relativist expresses himself in terms like these he cannot be regarding space as mere emptiness or as the arbitrary co-ordinate system of the pure mathematician; for him it is the substitution of matter, light, and electric force—that is to say, it is the thing which most of us call æther. Since it is not matter, it has not (and we ought not to expect it to have) the material properties of density, elasticity, or even velocity; but it has other dynamical attributes, measured by tensor-expressions, which stand in much the same relation towards it that mass and strain do towards matter. It is, in short, a physical medium. It is sometimes stated that the relativity theory does away with the æther; the defence of this statement must be left to those who make it; I do not think it is the view of Prof. Einstein. It seems more reasonable to say that relativity has added to the importance of the æther by enlarging its functions.

But it must not be thought that the whole issue reduces to a question of terminology. It will naturally be asked: How can those who believe in a physical æther regard gravitation and electromagnetic phenomena as the "outcome of the geometry of the universe"? The phrase is Prof. Weyl's, and reference to his book, "Raum, Zeit, Materie," shows that he believes in a physical æther, and does not mind saying so. "We shall use," he says, "the term 'condition of the world-æther' as synonymous with 'metric' in order to intimate the *real* character of the metric." We must recall that the geometrical quantity called "distance" is none other than the material or æthereal attribute of "extension," as Mr. Bonacina admits. Thus experimental geometry, which comprises the study of distances, is the science of the æther so far as its attribute of extension is concerned. The sentence then means that not only the phenomena immediately recognised as spatial, but also mechanical and electrical phenomena, fall into place in a complete development of the theory of extension—a truly remarkable discovery. They do not introduce any other attribute of the æther. I think it is because physical science is confined to this one attribute of the substratum of the universe that such qualities as beauty lie outside its scope.

The statement that the phenomena of mechanics are the outcome of the geometry of the world implies the complementary statement that the phenomena of experimental geometry are the outcome of the mechanics of the world. Either form expresses the central truth of the generalised relativity theory, but the great advance lies not so much in the conception of the idea as in the discovery of the key to this unification of geometry and mechanics. The unification leaves us with a redundancy of names, and apparently there is some divergence of view as to the

right name for the fundamental substratum of everything. Since it is the medium the condition of which determines light and electromagnetic force, we may call it *æther*; since it is the subject-matter of the science of geometry, we may call it *space*; sometimes, in order to avoid giving preference to either aspect, it is called by Minkowski's term *world*.

A. S. EDDINGTON.

Observatory, Cambridge, April 11.

"Absolute" Temperatures in Meteorological Publications.

IN a note in NATURE of March 31 referring to one of the publications of the Meteorological Office occurs the remark: "The normal constant for absolute temperature given is 200°. With a normal constant of 273° the resulting values would be in ordinary degrees Centigrade, a system adopted by many meteorologists on the Continent and by some at home. To the uninitiated it gives a reading more easily comprehended, although . . . some of the values would be given with the negative sign." Whatever may be the meaning of the "normal constant" for any scale of temperatures, may I express my disagreement with the opinion, and give a reason for doing so? Premising that, when dealing with the upper air, it is not the few, but the great majority of readings that have the negative sign on the Centigrade thermometer, my reason is that, to the uninitiated, negative values are not an aid, but a terrible obstruction to comprehension, because their use implies a process of thinking in two directions, upwards and downwards, at the same time, and keeping the two trains of thought distinct.

Looking into a well-known historical work a few days ago, I came across a perfect analogy of that imperfect system of measurement, one which expresses the difficulty very clearly. The author wrote of something as taking place "at the end of the third century B.C." He was counting time as your annotator would have us count temperature. I understand the time-reference to mean "towards 200 B.C.," the end of the third century being the beginning, not of the fourth, as the ordinary process of measurement would suggest, but of the second. If you substitute "the third degree Centigrade below zero" for "the third century B.C.," you have the same difficulty. It is obvious that in dealing with a single degree, as for a single century (for purposes of estimation of a fraction, for example), you may have to think upwards; but in dealing with a number of degrees or centuries you think downwards. This does not make for easy comprehension, and the only possible excuses for exposing an uninitiated reader or observer to the risks of such a system are either that there is no alternative—or that fractions of a degree do not really matter anyway.

In order to make comprehension easy you have, in fact, to become initiated in the practice of standing on your head; and no doubt after years of practice it becomes easier to stand on your head than to alter the zero of your own thermometer. But the uninitiated ought not to be prayed in aid of the practice. They will not find it anything like so easy as a hoary initiate like myself.

Incidentally, let me say that I know no meteorologists at home who habitually use the Centigrade scale. Many physicists do so; but, being "initiated," they skip quite lightly into the absolute scale when they want to deal with thermodynamics or radiation or any other of the applications of physics that go beyond the mere quotation of a temperature; they skip back again just as easily to Centigrade when the job is done. Skipping from one system of units

to another is recognised as splendid exercise in the process of "initiation"; but for the uninitiated there should be only one system of units, and that the very best there is. Comprehension soon follows when principles are really sound and scientific in the best sense. That is the real advantage of "a normal constant" of 200, which means in this case counting degrees upwards continuously from -273° C.

In order to meet the objection that temperatures expressed in this way are not, strictly speaking, in the absolute scale, I suggested in NATURE some years ago that the scale of Centigrade degrees measured from -273 should be called "tercentesimal."

April 2.

NAPIER SHAW.

Isotopes: Their Number and Classification.

ONE of the most remarkable characteristics of atoms is their predilection for the number 2 or for even numbers. The nuclei of atoms are now considered to be built up from hydrogen nuclei, which may be called positive electrons or protons. Suppose these to be P in number. Combined with these are N negative electrons. Since these N negative electrons may for most purposes be considered to neutralise the charge of N protons, the net positive charge on the nucleus is equal to P-N or M, the Moseley or atomic number. Now it is most remarkable that in about 97-98 per cent. of all atoms N is even; in 90-95 per cent. P is even; and M or P-N is also even in 89 per cent. of the atoms in the surface of the earth and in 98 per cent. of the atoms in the meteorites.

According to the theory of nuclear building published by the writer in 1915 and 1917, not only are the above facts to be expected, but also, as was pointed out specifically by N. F. Hall in the latter year, the number of isotopes should be considerably greater for elements of even than for those of odd atomic number. The recent remarkable positive-ray work of Aston, together with the investigation of magnesium by Dempster, show that eleven elements of even number consist of about three isotopes each, while those of odd number average only 1.44, or more than twice as many when the atomic number is even. The contrast should be very marked in the region of abundant isotopes between atomic numbers 28 and 83, or from nickel to bismuth. Keeping in mind this distinction between odd and even numbers, it may be predicted that nearly three hundred atomic species will be found when all the ninety-two elements are investigated fully, using methods of the present delicacy. An increase in the delicacy of the method of detection will naturally increase the number of isotopes discovered.

The number 2 occurs in another fundamental connection, since in no known permanently existing species of atoms in which the nucleus is complex is the number of protons more than twice the number of electrons, or the ratio N/P is never less than 1/2. This fundamental law was fully discussed in an earlier paper by the writer ("The Stability of Atoms as Related to the Positive and Negative Electrons in their Nuclei," Journ. Amer. Chem. Soc., vol. xlii., pp. 1956-97, 1919). It is of great interest that for 85 per cent. of the atoms of the earth's crust and 80 per cent. of those in the meteorites N/P is neither less nor more than 1/2. Thus most atom nuclei have the formula $(p_2e)_m$, and for such atoms M is almost always a multiple of 2 or an even number, but is odd in the very rare lower isotopes of lithium, boron, and also in nitrogen, which is a moderately rare element on earth, since it makes up only a very small fraction of the material of the earth's crust.

Let us specify the atoms of this important class as those of isotopic number 0. Then the isotopes of magnesium of atomic weights 24, 25, and 26 will have isotopic numbers 0, 1, and 2, and may be specified as Mg 12_0^{24} , 12_0^{25} , and 12_0^{26} , where 12 is the atomic number. It is easily seen that the isotopic number n is the number which, when added to twice the atomic number, gives the atomic weight (P). The Harkins-Wilson equation for atomic weights is $P=2M+2f$, where f has values 0 to 27 for complex nuclei and $-1/2$ for hydrogen. It is now proposed to change this classification of atoms by their f values (loc. cit.) into a classification according to their n values, where n, the isotopic number, takes the place of 2f in the above equation. The isotopic number of uranium is 54, the isotopes of krypton are 6, 8, 10, 11, 12, and 14, those of chlorine are 1 and 3, that of arsenic is 9, those of bromine are 9 and 11, that of

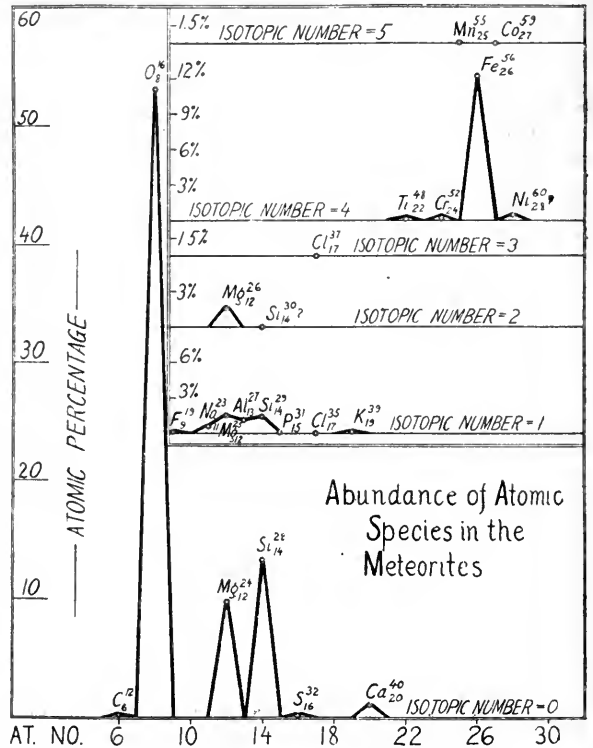

FIG. 1.—The abundance of isotopes as a function of the isotopic number, and as a function of the atomic number. While this figure exhibits the relations in the meteorites, the similar figure for the earth's crust is almost identical, except that the peak for aluminium is higher, and those for magnesium lower.

iodine is 21, etc. It is of interest to note that the isotopic numbers of elements of even atomic number are mostly even, while those of odd atomic number are mostly odd.

The isotopic number may be defined as the number of neutrons (pe) which would have to be added to the atom of the same atomic number, but of zero isotopic number, to give the composition of the nucleus. Thus the formula of any nucleus would be $(p_2e)_m(pe)_n$.

It is of interest to note that most atoms have an isotopic number 0, but that their abundance decreases rapidly to isotopic number 1, which includes sodium, aluminium, and silicon, decreases again to isotopic number 2, and becomes almost zero in isotopic number 3. With isotopic number 4 the abundance rises again to a secondary maximum, and then decreases again (Fig. 1). Thus there is a certain

correspondence between isotopic numbers which differ by 4, or by the formula p_2e_1 , which may be assumed to represent an α -particle plus two cementing or β -electrons. The relations of the light atoms are thus very similar to those of the radio-active atoms.

It may be of interest to note that during an α -change there is no change in the isotopic number; in a β -disintegration the isotopic number decreases by 2. Of these two units one is due to the decrease of the number of negative electrons in the nucleus by one, and the other to the resultant increase of the atomic number (M) by one. The addition of a proton to a nucleus would increase the atomic number and decrease the isotopic number by one each. Thus the addition of a positive electron to the nucleus of $Mg\ 12_2^{26}$ would give 13_1^{27} , which is ordinary aluminium.

The negative electrons in atom nuclei seem to be usually associated in pairs. Thus in the β -disintegrations of the radio-active elements two electrons escape in succession. This pairing may explain the fact that while most atoms have the formula $(p_2e)_M$, with M an even number, extremely few have the same formula when M is odd. Thus if p_2e should prove to be the primary group in atom-building, nevertheless the most abundant group in existing nuclei would be expected to have the formula (p_2e) or that of an α -particle.

WILLIAM D. HARKINS.

University of Chicago, February 4.

Light and Electrons.

WITH reference to Sir Oliver Lodge's letter in NATURE of April 7, some few weeks ago I fitted a flat speculum mirror to a centrifuge capable of being run at 150 revolutions per second. The other arrangements—not yet completed—are as follows:—The image of a brightly illuminated slit is focussed on the mirror; a second slit is placed at a distance of about 10 metres.

(1) The eye is placed behind the second slit and the centrifuge increased in speed until the flash is no longer seen. If the slits are 1 mm. wide a duration of flash of 10^{-7} sec. is attainable. If necessary, the radius of the rotating beam may be increased.

(2) The eye is replaced by a photographic plate. This is a test for electrons released from the sensitiser. Below a certain duration of flash there should be no latent image formed, however often the flash is repeated.

(3) A light-sensitive photo-electric cell is also tested. In this manner Mr. J. H. Poole and I have planned to test the very point raised by Sir Oliver Lodge, and also to seek for evidence respecting the quantum theory of vision.

At present there is only this much to go on. It is stated (Halliburton's "Physiology") that a flash of 1.25×10^{-7} sec. duration is still visible. This (if it is the limit) affords a length of 4×10^8 cm. for the length of the train of waves activating an electron in the retina. If it is allowable to go further we find the energy of a single wave (of green light) to be about 6×10^{-20} erg.

J. JOLY.

Trinity College, Dublin, April 8.

Molecular Structure and Energy.

THE question which Prof. Partington raises in his letter under the above title in NATURE of April 7, p. 172, is an important one which I would prefer should be answered by others more qualified to do so than myself. I intervene principally to correct the im-

pression given in the letter that the structures of the various molecules with which I have dealt in recent communications have been proposed by me. This is not so. All that I have done is to show that the structures of certain polyatomic molecules, including some halogen gases, carbon dioxide, and nitrous oxide, postulated by Lewis and Langmuir are consistent with viscosity data and X-ray crystal data taken together. The procedure deals with the external shapes of the molecules only, and not with the internal energy of their nuclei; and it appears to be justified by the calculations of Prof. S. Chapman (Phil. Trans., vol. ccxvi., p. 347), who says: "... the internal energy which prevents the application of our formulae to the conductivity of polyatomic gases hardly affects viscosity."

Prof. Partington's views appear to be open to criticism even if we leave out of account entirely the necessity for revising earlier ideas of energy partition on the basis of the quantum theory. For example, Langmuir's proposed structure for the nitrogen molecule is not spherically symmetrical in the same sense as are the atoms of the inert gases. There are two separate massive nuclei instead of one, and this involves the possibility of rotational internal energy of the same type as in the oxygen molecule, so that the ratio of the principal specific heats could not be expected to be so high as 1.667. Also, is it not possible, indeed probable, that the nuclei of all polyatomic molecules are capable of vibration to and fro? Such motions are, I believe, known to exist in the gaseous hydrogen halides, as well as the rotations to which attention has recently been directed by Prof. W. L. Bragg and Mr. H. Bell (NATURE, March 24, p. 107).

A. O. RANKINE.

Imperial College of Science and Technology,
April 7.

The Normal Orbit of the Electron in the Atom of Mercury.

RESEARCHES on ionisation and resonance potentials of mercury vapour and on its ultra-violet absorption in a non-luminous state, together with considerations from the serial type of the mercury spectrum, lead to the definite conclusion that in the absence of exciting agencies the spectral electron remains on the orbit 1S, the normal orbit of the atom of mercury. On the other hand, R. Dearle has shown the presence of a strong infra-red absorption band at $\lambda = 10140$, and this fact has suggested the possibility of a second normal orbit in the mercury atom, namely, the orbit 2P. The corresponding ionisation and resonance potentials have, however, never been observed. This problem induced us to make an absorption experiment with non-luminous mercury vapour in the infra-red region, using a photographic method which enabled us easily to reach $\lambda = 11300$ Å. All the photographs showed complete absence of a marked absorption at $\lambda = 10140$, although the pressure of mercury vapour reached 1 atm. The efficiency of the method having been established, the absence of a strong and characteristic absorption of $\lambda = 10140$ by mercury vapour has been shown and the necessity for a second normal orbit is avoided.

A. TERENIN.

Optical Institute, Petrograd, December, 1920.

Doublets in Spectral Series.

THE physicists of Petrograd have recently become acquainted with a paper by Wood and Mohler (Phil. Mag., April, 1919) on resonance in sodium vapour.

When the excitation is produced by D_1 , the ratio of intensities of the two resonating lines D_2 and D_3 , which is very small when the temperature and density are low, rapidly increases to its normal value 2 with the number of atomic collisions per second. This number is thus given statistical significance. Until now there has been no strong evidence (Wood, 1914) as to its invariability at higher temperatures and pressures.

Special investigations on this subject made in 1915 and 1917, and published in Russia, appear to be unknown abroad. The dispersion of the vapour of alkali metals was studied in 1915. For all the first doublets of Na, K, Rb, and Cs the same value 2 was obtained, and it remained constant in spite of a hundredfold density variation; for the second doublets the numbers are simple, but different: 2 (?), 2, 2.5, 4. The numbers 3 and 7 (?) were measured for the third doublets of Rb and Cs. Mr. Touverow (1917) found the same number 2 for the first sodium doublet at the temperature of the arc. There is, therefore, no doubt now as to the constancy of all the above numbers. The experiments on resonance thus show that the statistical value in question first grows rapidly with the temperature and approaches a limiting value, essentially constant. This behaviour has a certain analogy to that of specific heat as caused by departure from equipartition.

D. ROGESTVNSKY.

Petrograd University Physical Institute,
March.

The Resonance Theory of Hearing.

THE discussions which appeared in NATURE in 1918 (vol. cii., pp. 124, 164, 184) on the theory of hearing showed that the opinion has been gaining ground lately that the resonance theory can no longer be regarded as unassailable. The following observation, which is readily explicable if there are resonators in the internal ear, would appear to be inexplicable if there are not:

If the phase of a continuous musical note be suddenly altered by suitable means by π , then the observer hears the sound rapidly die away, to return a moment later with its former intensity. The experiment was performed as follows:

A De la Tour siren was so modified that the wind-chest could be given suddenly a small rotation about the same axis as that of the siren disc. The rotation was limited by fixed stops, so that the angle turned through was equal to one-half the angle between two of the air-holes. In the writer's instrument there were eighteen holes arranged on the circumference, i.e. 20° between two of the holes, and the wind-chest was therefore arranged to rotate through 10° . If, then, this rotation is suddenly effected with the siren in action, a change in the phase of the note of π will be introduced; since, if the rotation of the wind-chest be in the same direction as that of the disc, the time-interval between the puffs of wind through the disc will be $1\frac{1}{2}$ times as great as the normal, because the disc has to rotate through $20^\circ + 10^\circ$; if, on the other hand, the rotation of the wind-chest be in the opposite direction to that of the disc, the time-interval will be one-half the normal, since the disc has to rotate through $20^\circ - 10^\circ$. Each time, then, that this change of phase of π is brought about by rotation of the wind-chest of the siren the observer hears a beat in the musical note. The sound intensity first falls to a low value, then rapidly rises somewhat above the original level (possibly due to successive

contrast), and then returns and stays at the normal intensity. To show that the beat is not of mechanical production the following tests may be applied:

(a) No beat is produced if the wind-chest is rotated slowly.

(b) No beat is produced if, with the disc in rotation, the air-supply be quickly turned off and the wind-chest then rotated suddenly in either direction.

(c) The beat can be heard as clearly at a considerable distance from the instrument as it can quite near to it.

(d) If the rotation of the wind-chest is less than that required to change the phase by π , the beat or temporary waning of the note is correspondingly smaller in intensity.

This temporary waning of the note is readily explained by the resonance theory, because the change in phase will put the later vibrations exactly out of step with those that preceded, and therefore the resonators of the internal ear which are set in vibration by the note will on change of phase first be brought to rest and then be set going again. The temporary waning of the note is therefore readily explained on the resonance theory. Can any of your readers advance an explanation on any of the displacement (e.g. Wrightson's) hypotheses of hearing?

H. HARTRIDGE.

King's College, Cambridge, March 21.

Sexual Organs of Phytophthora.

ATTENTION was directed in NATURE of April 30, 1914 (vol. xciii., p. 226), to the discovery of a rather remarkable mode of development of sexual organs which occurs in certain species of Phytophthora, and was first found in *P. erythroseptica* and then in *P. infestans*, the "potato-blight" fungus. Several other species of the genus are now known to produce sexual organs in this novel fashion, in which the oogonial incept penetrates the antheridium at an early stage, traverses it, emerges, and then swells to form the oogonium proper within which the oospore ultimately develops. It was suggested then that those previously well-known species (such as *P. cactorum*, etc.) in which the antheridium and the oogonium lie side by side, and penetration of the latter by the former occurs laterally, should be excluded from the genus Phytophthora and be placed in a new one, Nozemia. A species (from decaying apples) has now been isolated by Mr. H. A. Lafferty, working here, in which the sexual organs are developed mainly according to the Nozemia type, but occasionally and simultaneously in the same individual according to the Phytophthora type, with amphigynal antheridia. This species, therefore, forms a connecting link between the two groups; and it would seem no longer necessary or desirable to retain the generic name Nozemia.

The object of this letter is to suggest to the various mycologists who are now working with Phytophthoras that they should keep a very careful look-out in cultures of species of the *Cactorum* or *omnivora* (Nozemia) type for the occasional occurrence of sexual organs with amphigynal antheridia; for it seems quite possible that these may be present in such species and have merely been overlooked by previous observers owing to their relatively infrequent occurrence.

I should be very grateful for sub-cultures of any species of Phytophthora that mycologists who have them could spare for further study of this point, and happy to send any I possess in exchange if desired.

GEO. H. PETHYBRIDGE.

Royal College of Science, Dublin, April 7.

Stellar Magnitudes and their Determination.¹

By H. SPENCER JONES, Chief Assistant, The Royal Observatory, Greenwich.

III.—ABSOLUTE MAGNITUDES.

THE absolute magnitude of a star is a measure of its intrinsic luminosity. In order to determine it, the distance of the star must be known. Star distances are so great that it is customary and convenient to express them in angular measure by means of the angle (ϖ) subtended at the star by the radius of the earth's orbit, supposed viewed broadside on from the star. If l is the apparent luminosity of a star at its actual distance, then the apparent luminosity when placed at any definite fixed distance from the sun will give a true relative measure of its intrinsic luminosity: its apparent luminosity being then l/ϖ^2 , its absolute magnitude must differ by a constant from

$$-2.5(\log l - 2 \log \varpi),$$

or from $m + 5 \log \varpi$. There is not entire uniformity amongst astronomers as to the constant distance to which stars must be considered as placed in order to obtain a definite measure of their absolute magnitude; this non-uniformity is not serious, provided the convention adopted is always explicitly stated. The most common practice is to define the absolute magnitude as the value of the apparent magnitude when the star's parallax (ϖ) is one-tenth of a second of arc. If, then, ϖ is expressed in seconds, the absolute magnitude, M , is given by

$$M = m + 5 + 5 \log \varpi.$$

If, on the other hand, a distance corresponding to a parallax of $1''$ is adopted as the standard, the absolute magnitude is given by

$$M = m + 5 \log \varpi.$$

The magnitude m may be either the visual or the photographic apparent magnitude, although it is more general to use the former. There will be a relative difference in the absolute magnitudes of two stars of different colours according to which apparent magnitude is used. To define absolute magnitudes without any ambiguity, it would be necessary to use a bolometric magnitude which would take account of all the energy emitted by the star, whatever its wave-length might be.

The intrinsic luminosity of a star may also be expressed in terms of the luminosity of the sun as a unit, a means of expression which conveys more meaning to the average person. Various measures have been made of the apparent magnitude of the sun, on the scale used for the stars, and the most probable value is now accepted as $-26.5m$. This corresponds to an absolute magnitude for the sun of $5.1M$ or of $0.1M$, according as the distance used in defining absolute magnitude corresponds to a parallax of $0''.1$ or $1''$ respectively. These values are uncertain to the same extent that the value of the apparent magnitude is uncertain, and are, therefore, liable to

future revision. As it is not advisable that the value of a star's luminosity, in terms of the sun's luminosity as a unit, should be liable to frequent change, it would be preferable to adopt a value $-26.6m$ as the apparent magnitude of a hypothetical sun, nearly equal in brightness to our sun, and having the same position in space, and then the absolute magnitude of this hypothetical sun becomes $5.0M$ or $0.0M$, according to the unit of distance adopted. If a distance corresponding to $1''$ (called by general acceptance a *parsec*) is adopted as the unit, then the absolute magnitude will give a direct measure of luminosity in terms of the sun's luminosity as unit, the luminosity being then simply the antilogarithm of $-0.4M$. The convenience of having the zero of absolute magnitude to agree with the brightness of the sun is so great that, in spite of the much more general acceptance hitherto of the scale of absolute magnitudes based on a distance of 10 parsecs ($\varpi = 0''.1$), the time does not seem too late to change the convention. The matter is one which deserves the attention of the International Astronomical Union.

Since the determination of absolute magnitudes necessarily involved, until recently, the determination of the distance of a star and also of its apparent magnitude, and since the former of these quantities is small and liable to a relatively large error in its determination, it follows that absolute magnitudes could be determined only with a much greater uncertainty than attached to determinations of apparent magnitude. Fortunately, we are not dependent for our knowledge of absolute magnitudes simply and solely upon direct trigonometrical determinations of stellar distances; methods have been devised of recent years by which the problem may be attacked by somewhat indirect means.

One particularly interesting method has been worked out at the Mount Wilson Observatory, mainly by Adams, who succeeded in detecting differences in the relative intensities of certain lines in the spectra of various stars of a given spectral type. These spectral differences within the same spectral type are due to differences in density or in surface brightness or both, and indicate differences in absolute magnitude. By using the best determined trigonometrical parallaxes, Adams was able to standardise these relative intensity differences in terms of absolute magnitudes; and using the standardised basis so found, it becomes possible to determine the absolute magnitudes of stars simply from an examination of their spectra. Since the basis of these determinations is the collective results of direct parallax measures, the result for any given star is liable to a much smaller uncertainty than would be the result derived from a direct determination of the parallax of that star, provided the star is at such a distance that the

¹ Continued from p. 176.

uncertainty in the parallax determination begins to become comparable with the value of the parallax (say, $\varpi < 0''.025$ in the case of modern photographic determinations). Adams, therefore, has replaced the determination of each single parallax by a collective result, and has, in effect, reversed the former procedure, so that now, from a determination of the absolute magnitude and the apparent magnitude, the parallax may be derived with a high order of accuracy.

Another indirect method, discovered independently and almost simultaneously by Hertzsprung and Russell, enables a hypothetical value to be derived for the parallax of any physical double star of which the components show even a trace of relative motion. If ϖ is the observed relative motion in seconds of arc per year and s the observed separation of the components in seconds of arc, then the parallax is given by $\varpi^2 = s\omega^2/14.6m$, where m denotes the combined mass in terms of that of the sun as a unit. The masses of the stars do not show a wide variation, and Russell finds that, assuming the mass of the binary system to be double that of the sun, the resulting error in the absolute magnitude deduced from this hypothetical parallax will not exceed $\pm 1.0M$ in 89 per cent. of all the cases.

A third method of some interest may also be briefly referred to. There is a type of variable star the light variation of which is characterised by certain peculiarities which seem to indicate that the variation is due to an actual pulsation in the star. Such variables are termed Cepheids, after the typical example, δ Cephei. In the Magellanic clouds is a large number of these variables, and it was discovered by Miss Leavitt that there is a definite relationship between the periods of these Cepheids and their apparent magnitude, or, since they are all at appreciably the same distance, between their period and absolute magnitude. Their absolute magnitude, however, is not *a priori* known, but the near Cepheids may be used to fix a point on the curve, and then the absolute magnitude of any Cepheid can at once be found if its period is determined. This has the following important application: the large majority of the variables which occur in stellar clusters are of the Cepheid type, and this relationship, therefore, provides a basis for the deter-

mination, with a relatively small uncertainty, of the distances of stellar clusters. The result is the more valuable because the clusters are at such great distances that there is, at present, no reasonable expectation of the possibility of their direct determination. With the aid of the large reflectors at Mount Wilson, much valuable work has been done in determining the apparent magnitudes of cluster stars and, the parallax of the clusters

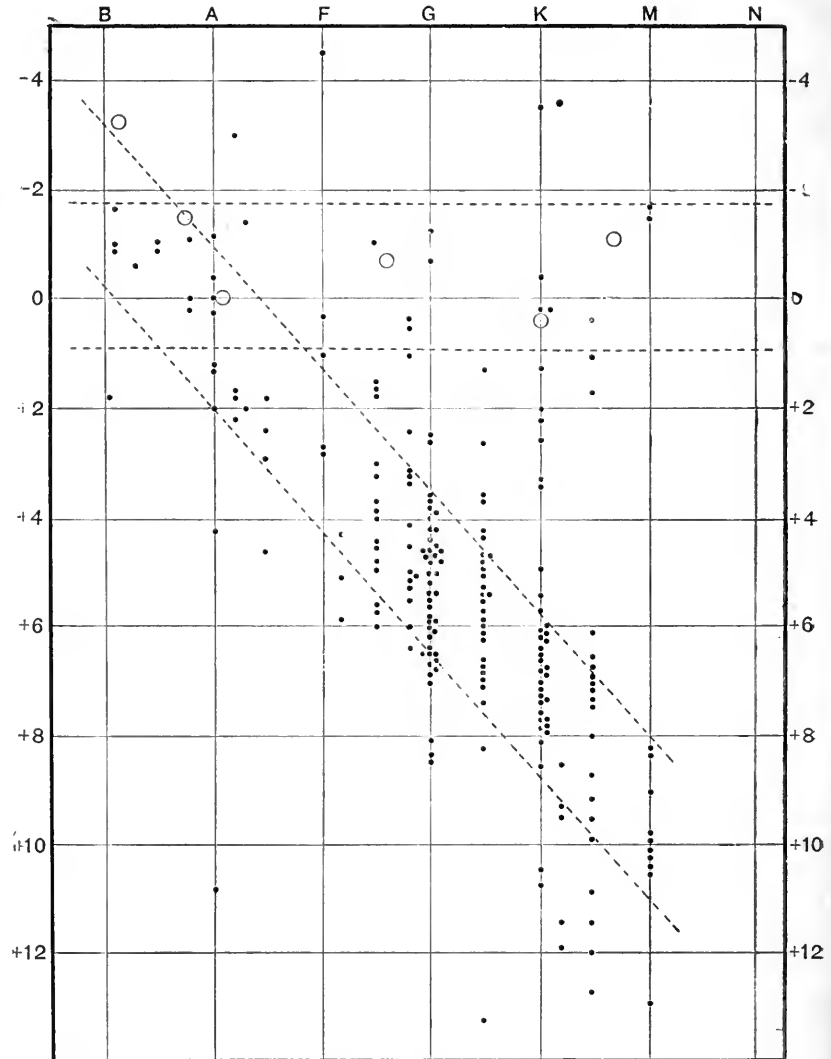

FIG. 6.—Absolute magnitudes of stars in relation to spectral type.

having been determined, these can at once be turned into absolute magnitudes.

It will be evident from the preceding remarks that our knowledge of the absolute magnitudes of stars has within recent years increased very rapidly. What are the absolute magnitudes of the stars in the neighbourhood of the sun? The values show a very marked dependence upon the spectral type of the star. It was shown by Russell that for any given type there is a limiting absolute magnitude below which, in general, stars of that type do not occur. The redder the

star, the fainter may its absolute luminosity be. One of Russell's diagrams, in which the absolute magnitudes are referred to a distance of 10 parsecs, is reproduced in Fig. 6. In this diagram the small dots represent individual stars, the large circles mean values for bright stars of small proper-motion and parallax. It will be seen that the general distribution of the dots is along two lines inclined at an acute angle and intersecting at type B; that this distribution is not the result of the selection of stars for parallax determination on the ground of brightness or size of proper-motion was conclusively shown by Russell. It will also be seen that for the red stars there is a complete separation between the two classes, so that a very red star is intrinsically either very bright or very faint. These facts have given rise to the "giant" and "dwarf" hypothesis, and have led to a recasting within the last few years of the ideas as to stellar evolution which were formerly generally accepted.

The following results emerge from Russell's investigation: (1) Stars of all types occur brighter than zero absolute magnitudes,² and mostly between 0 and $-2M$ —say, about 150 times the luminosity of the sun. These are called "giant" stars. (2) There are no B-type stars, and very few A-type stars, fainter than zero absolute magnitude, or, in other words, all the white stars are intrinsically very bright. (3) All the faint stars, less than, say, $1/50$ the luminosity of the sun, are red and of types K and M. These are called "dwarfs," and comprise all the near stars of large proper-motion. (4) In the intermediate classes, F and G, there is no separation between the giants and the dwarfs. Our sun ($5.0M$) is a

² The unit of absolute magnitude used here is that which corresponds to a parallax of one-tenth of a second of arc.

typical G-type star. In view of these remarks, it is obvious that no precise meaning attaches to a statement such as "The average absolute magnitude of all stars is $+2.7M$."

Shapley's work on the magnitudes of stars in clusters, combined with his determination of the distances of clusters, has shown that the giant stars in clusters, which are the only ones sufficiently bright to appear on the photographs, are of about the same magnitude as the giant stars in our more immediate neighbourhood. Two further points of interest emerge from the investigation: one is that in all the clusters examined in detail the intrinsically brightest giant stars are red stars; this may also be true for the stars near the sun, although the determinations of their absolute magnitude are probably not sufficiently accurate to show it; the other point is the apparent importance of an absolute magnitude of about $-0.2M$. Shapley finds that all Cepheid variables and cluster variables exceed this brightness; moreover, in the luminosity curve which connects the number of stars of any given absolute magnitude with the magnitude, there is a maximum in the curve corresponding to the same magnitude. In Shapley's opinion, this magnitude—corresponding to a luminosity of about 100 times that of the sun—indicates a critical stage in stellar evolution, and, in all probability, is of significance in the theory of a gaseous star. It seems, in fact, probable that by the new methods recently discovered for estimating great distances, combined with the advantages afforded by the large reflecting telescopes at Mount Wilson, we may learn more about absolute magnitudes from a study of clusters at distances corresponding to parallaxes of the order of $0''.00005$ than from the study of the stars which immediately surround us.

Dynamics of Golf Balls.

THE physical principles underlying the flight of a golf ball were clearly laid down by the late Prof. Tait between the years 1890 and 1896.¹ In view of the present agitation over the standardising of the golf ball, it may be of advantage to reconsider some of the problems attacked by Tait and largely solved by him. The investigation led him into a series of researches on impact so as to obtain data for measuring the resilience of the material of which golf balls were then made. Also, by means of a specially constructed ballistic pendulum, measurements were made of the speed of a golf ball impinging on the pendulum placed at a distance of about 6 ft. from the tee. By attaching a tape to the ball, Tait was able to obtain direct measurements of the amount of underspin communicated to the ball at the instant of striking it. Outside observations were also made of the heights of the trajectories of well-driven balls, and of the ranges and times of flight. All these data were skilfully introduced into the mathematical discussion of the form of the tra-

jectory, a problem so difficult as to be capable of solution only by approximate methods. This was done before the days of the rubber-cored ball, and the steady improvement in the manufacture of the golf ball has enabled even very ordinary players to exult in lengths of drive which in Tait's days were beyond the powers of the mightiest exponents.

What Tait established beyond all controversy was that the range of the trajectory of a properly driven ball depended as much upon the underspin as upon the speed of projection. The combined effect of the linear speed and the rotation about a horizontal axis brought into play a force perpendicular to the direction of motion of the ball. Tait gave sound reasons for regarding this force as being proportional to the product of the velocity and the spin. Thus, although the possibility of a long trajectory depends primarily upon the velocity of projection, the range actually attained in any particular case will be governed by the amount of underspin communicated to the ball. If this is too great, the ball will rise too high, and the range will be correspondingly diminished. If the underspin is too small, gravity will pre-

¹ "On the Path of a Rotating Spherical Projectile," *Trans. R.S.E.*, 1893 and 1896; "Some Points in the Physics of Golf," *NATURE*, vols. xliii., xliv., and xlviii.; "Long Driving," *Badminton Magazine*, 1896.

dominate and pull the ball more quickly down to earth, with resulting diminution of range. For every velocity of projection of the ball which leaves the tee in a horizontal direction there will be a best value of underspin enabling it to attain the greatest range in still air. The art of the golfer is to manipulate his club so as to give this necessary amount of underspin.

It is probably not realised by many efficient golfers how much this underspin may be varied by small changes in the position of the line of stroke of the club as it hits the ball. Let us take Tait's maximum estimate of 120 revolutions or about 750 radians per second as the value of the underspin, and consider how far below the centre of mass of the ball the line of impulse must be so as to send the ball off with this spin and a speed of 300 ft. per second. The ball is supposed to be hit horizontally off the tee without any reactionary upward or backward impulse acting on it. The distance x below the centre of mass at which the line of impulse must act so as to give this combination of linear speed and spin has the value $x = k^2\omega/v$, where k is the radius of gyration of the ball, and v and ω are the speed and spin respectively. With $k^2 = 0.276$ in.², and $v = 3600$ in./sec., we find $x = 0.054$ in. A variation of one-hundredth of an inch in this value will change the spin by nearly 20 per cent. Such variations may easily be effected by very slight changes in the lie of the club head.

With a given ball the velocity of projection and the spin are the only factors which are under the control of the player. Once the short time of impact between the club face and the ball is completed, nothing the player can do can influence the flight of the ball. Thereafter all is determined by the combined influence of gravity and the air.

So far as the player is concerned, the velocity of projection depends mainly upon the velocity of the club at the moment it strikes the ball. The weight behind the stroke no doubt has a secondary influence, but the great thing is the *swiftness* of the stroke. For this reason experience has evolved a weight of club which is found most serviceable for the strength of the average man. In an ordinary driver, weighing (say) 1 lb., probably one-third of the weight is in the club head; and if we were to think of the problem as one of simple impact between two masses of which one is at rest, we might work out the relative velocities of club and ball after impact for an assumed value of the coefficient of restitution. But the conditions of the problem are not so simple. The player, by the swing of his body and arms and well-timed effective wrist play, not only imparts a rapid acceleration to the club head up to the moment of impact, but in all probability imparts, unconsciously, perhaps, but none the less effectively, an acceleration *during the time of impact*, short though that be. In spite of the back impulse on the club as it is striking the ball, its velocity is kept up by the unconscious knack of the player. The relative velocity with which the ball leaves the club is e times the momentary velocity of the

club, where e is the coefficient of restitution, and hence the velocity of projection will be $(1+e)$ times the velocity with which the club is moving at the instant club and ball separate.

Outside the factors over which the player has some control, the most important is the resilience of the ball, and the steady improvement in this quality is, of course, at the root of the great increase in lengths of drive. It was this question of resilience which, indeed, started Tait on his investigations on impact. The apparatus designed by him for the purpose was nicknamed the "guillotine." It consisted fundamentally of a weight which, guided by upright parallel slots, was dropped on the ball or other body the elastic properties of which were under investigation. The heights reached by the weight after successive rebounds were recorded automatically on a rotating disc $2\frac{1}{2}$ ft. in diameter. From the record all the facts of the impact could be derived more or less directly, such as the compression of the ball, the duration of the impact, and the value of e , the coefficient of restitution. The weight was made of wood, but its lower face could be, when required, shod with an iron plate.

The recording part of the apparatus has long been dismantled, but the "guillotine" part is still serviceable. In order to compare the values of e for modern golf balls with the values obtained thirty years ago by Tait, impact experiments were recently carried out on sixteen balls of recognised merit—namely, various types of Avon ball, Challenger, Clincher Cross, Dunlop, Silver King, and Spalding. Thanks are due to the Avon India Rubber Co., Ltd., J. P. Cochran, Ltd., North British Rubber Co., Ltd., Dunlop Rubber Co., Ltd., and A. G. Spalding and Bros., Ltd., for their kindness in supplying specimens of balls of the best quality. With the exception of five, all were of greater diameter than the new standard minimum, and only two exceeded the maximum standard weight. Their specific gravities varied from 1.07 to 1.29. On each of these balls the weight of 4.75 lb. was allowed to fall from a height of 9 ft., and the height of the first rebound was noted. The square root of the ratio of these heights gave an approximate value for e , and this was corrected by comparison with Tait's results, which showed that under the conditions of the experiment the ratio of the speeds immediately after and immediately before the impact was greater than the estimate from the corresponding heights by about one-ninth. The average value of e for the sixteen balls mentioned was 0.72, the lowest being 0.71, and the highest 0.75. Tait obtained for the balls he experimented with the value 0.66. He estimated 300 ft. per second as a fairly probable value for the velocity of projection. On the assumptions indicated above, this would imply a velocity of projection of 311 ft./sec. for the ball with coefficient of restitution equal to 0.72.

This does not seem to indicate any very marked superiority in the modern ball—at least, it cannot explain the greatly increased length of drive

attainable in these days. The reason is to be sought in the fact that the conditions of constraint under which the impact experiments are made are essentially different from those under which a golf ball is compressed and distorted as it is propelled freely in its flight. Everyone knows that the high resilience of the rubber-cored ball is derived from the fine rubber thread which is wound on under considerable tension. Before the outer covering is put on, these balls, when dropped from a height of 6 ft. or 7 ft., rebound from stone or metal to a height which indicates that the coefficient of restitution exceeds 0.8. When we consider the manner in which this complex of tightly wound rubber resists any sudden distortion produced by a short-lived blow, we shall probably be prepared to admit that such an elastic complex will resist compression more powerfully than an equal sized ball of vulcanised india-rubber, which Tait found to have a coefficient of restitution greater than 0.8. Any impulse brought to bear upon one part of the rubber-wound ball will produce in every strand of the rubber thread an immediate tightening with corresponding resistance to change of shape.

Let us suppose, then, that, under these conditions, the coefficient of restitution approaches the value unity, say 0.95. If the old gutty with coefficient of restitution 0.66 was propelled with an initial velocity of 300 ft./sec., then this ball, with coefficient of restitution 0.95, will be projected with initial speed of 356 ft./sec. This by itself will not account for an increase of 70 or 80 yards in the length of drive, for, as pointed out by Tait, a greater initial speed means a greater air resistance; and (other things being the same) to add 83 yards to the length of a drive means double the velocity at start. But here, again, we may invoke the influence of the underspin. As already stated, there is for every velocity of projection a definite value of underspin which will enable a given ball to travel its farthest range. Since the upward force produced by the combined action of the linear velocity and spin depends on both these factors, an increased velocity of projection will have to be associated with an increased rate of spin if its greatest range is to be attained. The problem is one which would well repay working out in detail.

If great length of drive is a desideratum in the game of golf, then undoubtedly the "floater" must give way to the heavy ball. This is a simple illustration of the well-known law of atmospheric resistance, the effect of which upon a sphere passing through the air is directly proportional to the surface, and inversely proportional to the mass. The accurate driver finds by experience that a heavy small ball travels farthest through the air. For example, if we make a floater of density unity and of the maximum weight, its diameter will be 1.75 in. The retarding effect of the resistance of the air on this floater will be 17 per cent. greater than the retardation experienced by the new standard ball of minimum size and maximum weight. Again, if we make a floater of the

minimum size, its weight will be only 1.28 oz., and it will experience a retardation due to atmospheric resistance which will be nearly 27 per cent. greater than that experienced by the standard "minimax," to use a word introduced long ago by Kelvin in a different connection. The "minimax" itself experiences slightly less atmospheric resistance than most of the balls mentioned above, being excelled in this respect only by Dunlop 31, Spalding Midget, small Avon de Luxe, and Silver King; but the difference never reaches 2 per cent. It is therefore not surprising that long driving is also attainable with the standard "minimax" ball.

A reference has been made to the radius of gyration of a golf ball as a factor influencing the amount of spin communicated to the ball. The square of the radius of gyration of a uniform sphere is $\frac{2}{3}r^2$, where r is the radius of the sphere. By means of oscillatory experiments, in which the golf ball was supported by a ring-shaped disc hung by a tri-filar suspension from three fixed points, the moments of inertia and radii of gyration of all the golf balls used were determined to an accuracy of about 1 per cent. The moments of inertia expressed in grams and centimetres varied from 86 for the Large Heavy Avon to 66 for the Standard Clincher Cross, and yet the mass of the latter was slightly the greater, being 45.4 grams (1.60 oz.), as compared with 44.6 (1.57 oz.). This great difference in the moments of inertia depends on the distribution of matter within the ball. The value of k^2 for the larger balls was practically the same as the value $\frac{2}{3}r^2$ for the uniform sphere of equal size; but in the case of the small balls k^2 was markedly less than $\frac{2}{3}r^2$, being in some cases as much as 8 per cent. smaller. The reason is that the small balls have a very dense core. It is obvious that with the larger moment of inertia a greater moment of impulse must be given to obtain the same spin. But this is automatically effected, since with the same club the larger ball is struck along a lower line relative to the centre of mass, so that the moment of the impulse is of necessity greater. During the flight of the ball the larger moment of inertia will enable the ball to conserve its spin the better, which will probably have a beneficial effect on the range or carry.

It appears, then, that the length of drive attainable depends on several factors, and of these the most effective are the resilience of the ball and the underspin given at the instant of impact. To drive a long ball is one of the delights of golf, and the ball which travels farthest will be the favourite. By almost all young and vigorous players the floater, because of its lightness, is regarded unfavourably. It lacks, comparatively speaking, steadiness in the air and accuracy on the greens, and cannot possibly be driven so far. It is little wonder that the heavy ball has ousted it in all serious play.

It is not the purpose of this article to touch on the question of standardisation of the golf ball. Its aim is to discuss the physical principles which govern the flight of the ball through the air. But

the physiological and psychological powers or weaknesses of the player are of equal importance. There is a limit to the weight of club which can be most efficiently used by the average man, and there must also be a limit to the weight of the ball. From the point of view of atmospheric resistance, the ratio of the surface to the weight must be kept as low as possible; but too small a surface will diminish the lifting power of the underspin, just as too large a weight will cut down the velocity of projection. The one quality which

must be as perfect as possible is the resilience of the material; but no ball can have a higher coefficient of restitution than unity, and therefore no ball can start on its flight with a velocity greater than twice that of the club head at the instant of impact. Physical and physiological considerations necessarily fix a limit to the range of flight attainable, and probably that limit is now being approximated to. Which, then, is simpler—to standardise or to re-arrange our golf courses?
C. G. K.

Nature in a Himalayan Valley.¹

By LT.-COL. J. H. TULL WALSH.

WE have here the notes made by an officer of the Indian Medical Service in the Hazara valley of the foot-hills, during the years 1914-16. These observations are wide in their range, and were, no doubt, a relief to more serious work. The author is an amateur naturalist, far from works of reference and museum specimens, and the opinions are strictly personal. No man can possess full knowledge in all the branches of science alluded to—for there is compilation as well as observation in this book—but Capt. Hingston has acknowledged his borrowings. The ordinary lover of Nature, who likes a pleasantly written account of geology and animal life in an area not well known to many, will enjoy this book, ignoring opinions with which he may not agree, and errors which the technical naturalist would claim as serious. The general features of the Hazara valley are shown on the map facing p. 4. It is a "slender wedge of British soil" about 120 miles long, its width varying from 56 miles at the base of the wedge to 15 miles at the apex. "To the south its foot-hills sink into the plains of the Punjab; to the north it rises into massive peaks 17,000 ft. in height that blend with the still loftier summits of western Kashmir."

The first five chapters are devoted to ants, harvesting ants, a species placed in the genus *Mymecocystus*, and others. Habits, etc., are freely discussed, and a great deal is written concerning instinct. The author asks too much from instinct, and "folly" (p. 41) is scarcely the correct word to apply to mistakes which are not provided for among instincts inherited by insects. Two

plates (facing pp. 13 and 60) are given of certain ants commonly found in the Hazara valley. While

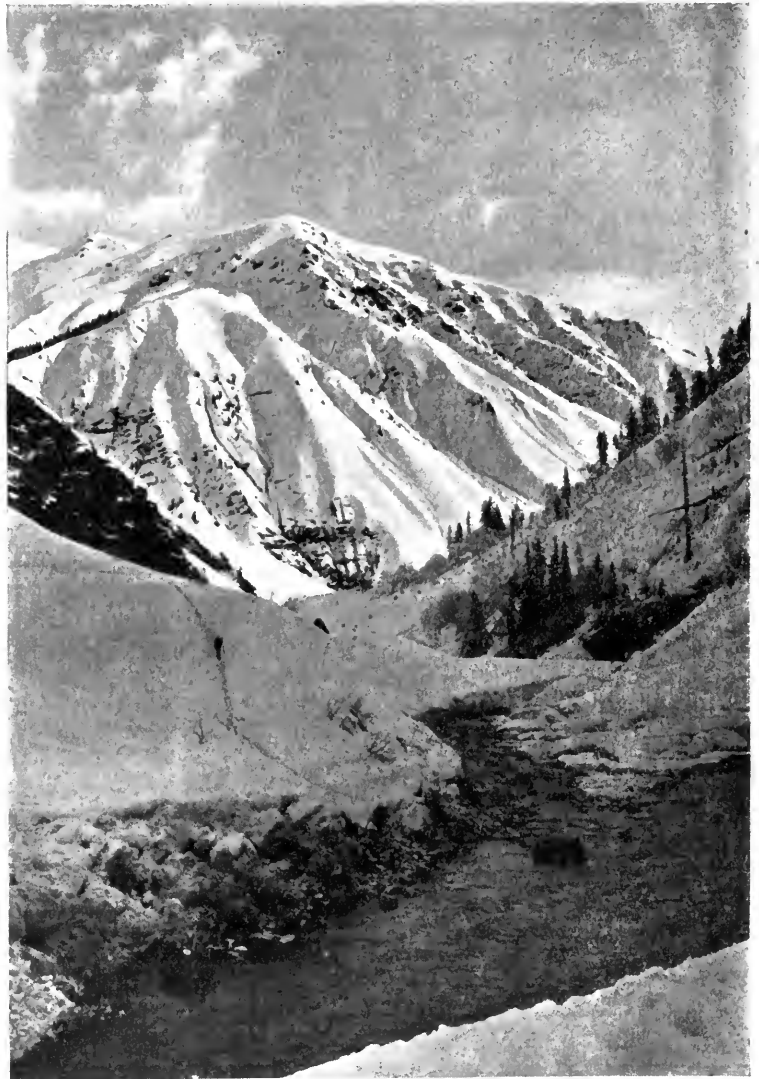

FIG. 1.—In the Himalaya. From "A Naturalist in Himalaya."

on the subject of plates, we think it would have been better to give them numbers. The illustrations themselves are excellent, as our examples prove.

¹ "A Naturalist in Himalaya." By R. W. G. Hingston. Pp. xii+300 +plates. (London: H. F. and G. Witherby, 1920.) 18s. net.

Chaps. vi.-x. deal with geometrical and sheet-building spiders, their work and habits. The miscellaneous contents of chap. x. include "water-boatmen" and "mentality of fishes," as well as the habits of wasps and bees. Interesting observations on mimicry in butterflies—chap. xi.—include *Kallima inachus* and a *Melanitis*, which, like Kal-

attention in chap. xii. Few will agree that the male glow-worm is "not even capable of perceiving a light" given out by the female; and on the pages where the massacre of a flight of winged termites is described there is much repetition of the names of various birds taking part in the orgy. We do not like the somewhat Teu-

tonic view that in Nature "all is war and carnage, greed and cruelty." Animals, including man, must destroy life for food, and no doubt there is even unnecessary killing by some of the carnivora; but, on the whole, Nature is fairly peaceful, and among many orders the unfit are removed in honourable battles between males, while bloodless competition by dance or song governs selection in others.

Among the observations of mammals, that concerning the flying squirrel is very interesting, and the author gives us a beautiful picture—here reproduced (Fig. 2)—of *Petaurista inornata*. The only comment necessary is upon the statement (p. 243) that "the tail of a bird cannot be used as a rudder." Most readers will take the opposite view. Chap. xiv. contains the best account of soaring



FIG. 2.—The Flying Squirrel (*Petaurista inornata*). From "A Naturalist in Himalaya."

lima, resembles dry leaves blown by the wind; and these are compared with *Dophla patala*, which, "coloured a rich green," blends with the fresh foliage; "the *Dophla* alights where it is lost upon the branches, the *Melanitis* seeks concealment on the leaf-strewn ground; the *Dophla* rests with wide-open wings . . . *Melanitis* with wings tightly closed." Glow-worms, termites, and shells receive

ing we have ever read, and the explanation will be welcomed by many who may not be able to observe the phenomenon for themselves. The book ends with a sketch of the geology of the Himalaya based on the work done by the Geological Survey of India. The author acknowledges his indebtedness to the labours of Mr. C. S. Middlemiss.

The Annular Eclipse of April 8.

By DR. A. C. D. CROMMELIN.

FINE weather in most parts of the country favoured observation of this phenomenon. Great public interest was taken in the search for stars. Venus was seen with ease nearly everywhere, Mercury was also undoubtedly observed, and Vega was suspected at Oxford, though not seen by Mr. Mitchell at Mallaig, which is inside the zone of annularity. The lowering of temperature was marked, amounting to as much as 9° F. The diminution of light was striking, probably more so than if the sky had been partially covered with cumulus clouds. The light had the purplish hue that so often prevails in large eclipses; it doubtless arises from the absorption of the solar atmosphere, which is more noticeable in the region near the limb. Successful spectroscopic observations of the reversing layer and chromosphere were made by Profs. Fowler, Newall, and Sampson at

Kensington, Cambridge, and Edinburgh respectively.

At Greenwich efforts were made to improve the determination of contact times by Mr. Innes's method of making a number of rapid measures of the distance between the cusps near the beginning and end of the eclipse. The measures are not yet fully reduced, but it is probable that each contact will be determined within 2 sec. by the combined results.

It can already be stated that the Hansen-Newcomb right ascension of the moon needs to be corrected by about +0.80 sec., which is just double the correction that was applied in the Nautical Almanac eclipse elements. Several photographs were taken near the beginning and end of the eclipse, also near the greatest phase. One of the last, exposed at 8h. 48m. 2s., Greenwich mean

time, is reproduced by kind permission of the Astronomer Royal. The second exposure on the plate was made in order to render a greater length of the reference wires visible; it was found very difficult to orientate the plates of the 1912 eclipse,



FIG. 1.—Partial solar eclipse one minute after greatest phase. Reproduced by permission of the Astronomer Royal.

owing to the small amount of the wires that was registered.

It is curious that the writers of many of the popular accounts of the eclipse speak of it as the only large eclipse visible in London in the last forty years, in forgetfulness of the still larger eclipse of 1912, for which also the weather conditions were favourable.

MR. ELBORN, one of the assistants in the Botany School at Cambridge, has made some interesting observations on the behaviour of leaves during the eclipse on April 8.

It is well known that the stomata (which are minute apertures in the leaves) are open in daylight and shut in darkness. These facts are demonstrable by means of a little instrument called the Horn hygroscope described in my paper "Observations on Stomata" (Phil. Trans., B, vol. exc., 1898, pp. 531-621). It will be seen that as the eclipse came on the readings fell from 3.5 at 8.40 a.m. to 1.5 at 9.38—that is, the stomata closed considerably—and by 11.45 a.m. they had returned to their original condition, as shown by the reading of the hygroscope, viz. 3.4.

The plant used for the experiment was the common *Tropæolum*; the behaviour of its leaves is shown in the following table, the second column giving the readings of the Horn hygroscope:

A.M.		A.M.	
8.40	3.5	9.50	1.5
9.5	3.2	10.4	1.7
9.19	2.4	10.20	2.0
9.21	2.3	10.34	2.8
9.27	1.9	11.1	3.0
9.32	1.7	11.45	3.4
9.38	1.5		

FRANCIS DARWIN.

Brookthorpe, Gloucester, April 11.

THE partial annular eclipse of the sun was well seen in a clear sky in Herefordshire (N. lat. $51^{\circ} 56'$, W. long. $2^{\circ} 38'$). The darkening of the landscape was marked, and the sky in the north assumed a dark purplish-blue colour. It was not dark enough to show any planets or stars even with field-glasses. Birds continued to feed and hop about as usual.

The most remarkable effect observed during the darkest phase was on the sky surrounding the sun. The atmosphere was slightly hazy from the east wind, and on the sky, from the sun as a centre, was projected a radiating series of narrow light and dark rays visible for quite 20° from the sun. It was a pretty phenomenon, and one which I had not observed before.

ELEONORA ARMITAGE.

Dadnor, Herefordshire, April 8.

DURING the maximum phase of the eclipse on April 8 the shadows thrown by trees on a footpath had a strange appearance, the details of boughs and twigs being broken up more or less completely into parallel crescents. At first sight the appearance suggested a modification of the dappled effect of sunlight falling through trees in summer; but the shadows of bare twigs were broken up in the same way, and such scanty foliage as the trees bore was far too thin to give rise to ordinary pin-hole images. Moreover, quite detached shadows were affected. The shadow of a narrow window-bar thrown on a floor was tagged out at each side so as to look like the shadow of a ragged feather from a pheasant's tail.

E. LEONARD GILL.

Hancock Museum, Newcastle-upon-Tyne,
April 9.

Obituary.

PROF. S. W. BURNHAM.

PROF. S. W. BURNHAM, whose death is announced, was born on December 12, 1838, at Thatford, Vermont, U.S.A. His early profession was that of journalist and stenographer at Chicago. Burnham was, however, soon filled with a zeal for astronomical research, in particular double-star observation, in which department he was one of the greatest and most successful workers of all time. In 1870 he became the possessor of an excellent 6-in. refractor by Alvan Clark. In spite of his arduous professional work, he observed with this instrument nightly "till daylight drove him to bed." He discovered 451 pairs with it, nearly all difficult, and some of special interest, being faint, close companions of naked-eye stars (for example, ν Scorpii, mags. 4 and 8,

dist. 0.3"). Burnham had a marvellously acute eye, some of the pairs discovered with the 6-in. taxing the powers of the largest telescopes to separate. His next work was done with the 18½-in. refractor of the Dearborn Observatory, Chicago, from 1877 to 1879; with this he discovered 413 pairs, many of which are recorded in vol. xlv. of *Memoirs of the Royal Astronomical Society*.

Burnham was selected in 1879, on Prof. Newcomb's recommendation, as Prof. Holden's colleague for testing the atmospheric conditions at Mount Hamilton preparatory to the founding of the Lick Observatory. He remained there to observe the transit of Mercury in 1881, and was afterwards on the staff of the Lick Observatory, making still further discoveries and observations,

so that in 1894 he had discovered more than half of the known pairs of which the distance was less than 1".

Burnham afterwards returned to Chicago as professor of practical astronomy at the University. The first volume of the Publications of the Yerkes Observatory consists of his great "General Catalogue of Double Stars," which has become the standard work of reference on the subject. He continued the work of discussing measures and orbits, and of drawing up lists of stars that needed observation, until within a few years of his death.

Burnham was elected a fellow of the Royal Astronomical Society in 1874 on the nomination of the Rev. T. W. Webb, whose "Celestial Objects" had first directed his attention to double stars. He was elected an associate in 1898, having received the gold medal in 1894.

A. C. D. C.

WE announce with regret the death on Thursday, March 31, of Mr. T. E. GATEHOUSE at the age of sixty-six years. Mr. Gatehouse was for some forty years associated with our contemporary, the *Electrical Review*, of which he had become editorial and technical director. As a young man he was a pupil of Robert Sabine, one of the most able pioneers of electrical industry, and later he worked with Sir Charles Wheatstone and Sir Samuel Canning. From these he obtained a broad knowledge of electrical engineering in all its aspects, and especially of telegraphy, both on land and by submarine cable. As a young engineer he also took great interest in schemes for electric lighting, and himself held a number of patents for improvements in both the arc and incandescent lamp systems. In 1881 Mr. Gatehouse joined forces with a fellow-pupil under Sabine, Mr. R. H. Kempe, who was proprietor, with Mr. H. Alabaster, of the *Telegraphic Journal and Electrical Review* (afterwards the *Electrical Review*), and Mr. Gatehouse was made editor, a post which he held until a few years

ago. Failing health compelled him to give up active work as editor, but as editorial and technical director he kept in touch with the journal, and lent his aid in a consultative capacity until a few days before his death occurred.

THE death is announced of MR. SYDNEY FISHER, one of the leading authorities on agriculture in Canada. Mr. Fisher was born in 1850, and educated at McGill University, and later at Cambridge. At the age of thirty-one years he entered the Dominion Parliament, and, with the exception of an interval lasting from 1891-96, was a representative in it continuously until 1911. He made a study of the principles of agriculture, and when Sir Wilfrid Laurier came into power in 1896 was appointed Minister of Agriculture, an office which he held for fifteen years. During his tenure of office Mr. Fisher initiated a progressive agricultural policy, the most important part of which was the establishment, in various parts of the Dominion, of experimental farms, where careful and profitable research has been undertaken. Mr. Fisher will also be remembered as the first vice-president of the International Institute of Agriculture convened at Rome in 1908.

THE death is announced of MR. ALEXANDER WYNTER BLYTH, which occurred on April 1 at the age of seventy-six years. Mr. Blyth was for forty years public analyst for the county of Devon and the borough of St. Marylebone, and a past-president of the Incorporated Society of Medical Officers of Health. He will be best remembered as the author of a number of books on public health, among which are "Foods: their Composition and Analysis," "Poisons: their Effects and Detection," and "A Manual of Public Health." He also communicated a number of papers to the Royal Society, the Chemical Society, and the Royal Sanitary Institute.

Notes.

AT the meeting of the Royal Society on May 5 the Croonian lecture will be delivered by Dr. Henry Head on "Release of Function in the Nervous System."

PROF. J. NORMAN COLLIE, professor of organic chemistry in the University of London, and Sir W. Morley Fletcher, Secretary of the Medical Research Council (Privy Council), have been elected members of the Athenæum under the provisions of the rule of the club which empowers the annual election by the committee of a certain number of persons "of distinguishing eminence in science, literature, the arts, or for public service."

THE Institute of Physics will be inaugurated at a meeting to be held on Wednesday, April 27, at 6 p.m., in the hall of the Institution of Civil Engineers, Great George Street, Westminster. Sir Richard Glazebrook, the president, will preside, and Sir J. J. Thomson will

deliver an address. Mr. A. J. Balfour is expected to be present and to extend a welcome to the institute. Non-members of the institute or of the societies associated with it may obtain tickets of admission on application to the Secretary, 10 Essex Street, Strand, W.C.2.

A GOOD deal of attention has been devoted in the medical, pharmaceutical, and general Press to the provisions of the Draft Regulations drawn up by the Home Office under the Dangerous Drugs Act of 1920. The drugs specified in the draft regulations are opium, morphine, diamorphine, cocaine, and ecgonine, and, with certain exceptions as regards pharmacists, medical men, dentists, and veterinary surgeons, the manufacture, possession, purchase, or sale of any of these drugs is prohibited except to persons duly licensed or otherwise authorised by the Home Office. Apparently a chemist successfully synthesising one of

these drugs, such as morphine, without previously securing a licence for himself and the premises he works in, might be regarded as "manufacturing" the alkaloid, and thereby infringing the regulations. Similarly, he would require a licence before he could acquire and keep any of these drugs in his laboratory, and he would have to produce his stock for the inspection of any constable who desired to see it, and, if any of it had been used or otherwise disposed of, satisfy the constable that a record of the transaction had been kept in the proper form in the appropriate book. The regulations appear to have been prepared without consideration of the fact that drugs of this kind are in common use for purely scientific purposes, and it behoves chemists and others concerned to bring pressure to bear on the Home Office to ensure the exemption of scientific workers from the operation of the regulations when they come into force.

THE half-yearly meeting of the council of the National Union of Scientific Workers was held at the University of London Club on Saturday, April 9, the president, Prof. L. Bairstow, in the chair. It was resolved unanimously that the council views with misgiving the subordination of scientific workers controlling scientific staffs to non-scientific officials in Government Departments; deplors the growing tendency of public bodies to reduce expenditure on education, particularly in neglecting to provide for further institutions for the study of science and technology, and by threatening existing institutions with closure, irrespective of their national utility; and will take steps to oppose the tendency to discriminate, solely on account of sex, between the salaries of scientific workers of the same grade and professional standing. The following two resolutions on secret research in universities were also adopted:—"That this council is of the opinion that it is neither practicable nor desirable that research for Government Departments or other bodies, demanding the maximum privacy in its pursuit and the greatest strictures on publication, should be undertaken under the auspices of a university or of one of its departments"; and "That the executive committee of the union be instructed to direct the attention of university authorities throughout the kingdom to the danger of undertaking (except in a national emergency) research under the Official Secrets Act or similar conditions in university buildings, as the pursuit of such research is hostile to the university tradition of freedom of teaching, research, and intercourse, the freedom of the university scientific worker, and the best interests of education."

It is announced that the biological expedition to Spitsbergen organised in Oxford University is to set out in June. Financial difficulties have been partly overcome, but, according to the *Times*, funds are still inadequate to allow the whole programme to be followed. The expedition, comprising ten or eleven members, will be under the leadership of the Rev. F. C. R. Jourdain, and will devote its attention principally to ornithological work on the west coast, although it is hoped that ice conditions will allow a visit to New Friesland. The promoters have been well advised, in view of their inexperience in Arctic

conditions, to make use of Norwegian hunting sloops, and so have the assistance of expert seamen. If the ice conditions are normal this year, as they promise to be, the expedition should have an interesting time and do some useful biological work, especially on Prince Charles Foreland.

IN commemoration of the quatercentenary of the death of Ferdinand Magellan on April 27, Mr. E. Heawood read a paper to the Royal Geographical Society on April 11 on the world-map before and after Magellan's voyage. Mr. Heawood showed the influence on cartography before Magellan's voyages of the misrepresentations, largely dating from Ptolemy, which reduced the circumference of the globe and extended land areas longitudinally. Thus the voyage across the Pacific did not promise to be so long as it was in reality. One result of Magellan's voyage was to give greater appreciation of the width of the Pacific Ocean, and another, curiously enough, was to bring into renewed prominence the conception of a great southern continent—an idea which dated from high antiquity and was revived by the discovery of Fuegia. Mr. Heawood is not inclined to believe that Magellan Strait was known previous to the Magellan voyages, and thinks that earlier indications of it on maps were prompted by the hope, rather than the knowledge, of its existence.

THE second Herbertson memorial lecture of the Geographical Association was delivered by Dr. H. R. Mill in the map-room of the Royal Geographical Society on April 6. After references to the growth of geographical research in this country and to the career of the late Prof. Herbertson, the lecturer developed the theme of regional geographical study, and illustrated it by a detailed discussion of the problem of mapping the average rainfall of a region on a large scale. The steps by which the relation of average rainfall to the configuration of the land had been established were described, and stress was laid on the practical importance of such maps in planning waterworks and in developing water-power. The importance of amplifying such researches as had been made by establishing a hydrometric survey was insisted on, and the plan of a geography of inland waters laid down. For such work the river-basin was the natural unit, and the Ordnance Survey maps should be adapted to it by the insertion of watershed lines separating the valleys and by a series of levels along the stream-beds. The full description of the river system and *régime* would require the consideration of geological, botanical, and economic conditions as well as of meteorology.

AN account of the twenty-fifth annual Congress of the South-Eastern Union of Scientific Societies was printed in *NATURE* of June 24, 1920. The *South-Eastern Naturalist*, which has just been received, contains the proceedings and transactions of the union during 1920 under the presidency of Sir Edward Brabrook; the papers read at the congress are printed in full, and the reports made by the various committees and sections are given. The annual congress for 1921 will be held at Reading on June 8-11, and the president for 1921-22 is Prof. E. B. Poulton.

IN accordance with the provisions of the will of the late Dr. R. T. Nichols, the Royal Society of Medicine will offer triennially a prize of the value of 250*l.*, open to any British subject, for the most valuable contribution towards "the discovery of the causes and the prevention of death in childbirth from septicæmia." The society is open to receive competing essays for the first award until, at latest, June 30, 1924. The works submitted must be type-written or printed in English, marked "Nichols Prize," and accompanied by the name and address of the author. Work already published will be eligible provided it appeared not earlier than June 30, 1921. Further particulars of the prize are obtainable from the Secretary of the Royal Society of Medicine, 1 Wimpole Street, W.1.

At the fourth annual meeting of the National Association of Industrial Chemists, held at Sheffield recently and presided over by Mr. A. B. Searle, the general secretary's report on the activities and progress of the association during 1920 was read. At present there are nearly 1100 members on the register, and a slight gain in membership has been made. The economic status of the members has been considered by a special committee, and a scale submitted to, and approved by, the national council. These endeavours to obtain better remuneration were upset by unforeseen circumstances, but the experience gained shows that the association has prospects of doing good work in this direction when trade is more normal. Another committee discussed preliminaries with the British Association of Chemists in order to try to bring about an amalgamation, and negotiations are still proceeding. In the interests of the industrial chemist it is regarded as essential that every effort should be made to obtain an organisation strong both numerically and financially, and one that is fully representative of the industrial chemists of Great Britain. It is possible that much headway may be made in this direction by amalgamation with the British Association of Chemists, and possibly by affiliation with the Non-manual Workers' Federation. All communications with reference to the association should be addressed to the General Secretary, The White Building, Fitzalan Square, Sheffield.

UNDER the title of "La Dame de l'éryable" in *L'Anthropologie* (vol. xxx., Nos. 3-4) M. L. Siret publishes an elaborate, fully illustrated paper on the cult of trees in Druidism. The author reviews the occurrence of tree cults in ancient France, with comparative illustrations from the East as far as Nineveh, and certain allied questions such as the extension of Eneolithic commerce towards the north and the exportation of precious metals to the west.

THE myths of the Alsea Indian tribe of Oregon are collected, with the original texts, by Mr. L. I. Frachtenberg in Bulletin No. 67 of the Bureau of American Ethnology. Generally speaking, this mythology is characteristic of that area of the north-west which embraces northern California, Oregon, and Washington. It is typical of the north-west in so far as it is lacking in migration myths such as are

found among certain tribes of the south-west and east. On the other hand, it is intimately connected with the mythology of the tribes of northern California, and it exhibits special points of contact with the folk-lore of their neighbours to the north, especially the Salish. These points of resemblance and contrast are carefully worked out in the introduction to the present volume.

IN the March issue of *Man* Mr. Ainsworth Dickson describes the only survivals of the regalia of the Wavumba tribe in the delta of the Umba River, which formerly marked the coastal boundary of German and British East Africa. They are descendants of a party of Persians who migrated about A.D. 1200 to this district from the plains of Sheraji. About A.D. 1700 the country was swept by a horde of cannibals from the south, and many of the people removed for safety to the adjacent Island of Wassein, where they founded a city. The objects now described consist of drums, horns, and cymbals used at the enthronement of a sultan, and with the ruins of a few mosques and some Durbar customs they form the only material evidence of a once-flourishing Persian colony on African soil.

SOME interesting notes made on a cuckoo during the deposition of its eggs appear in *British Birds* for March. The author, Mr. Edgar Chance, kept a single female under observation throughout the whole of this time, which lasted until no fewer than twenty-one eggs had been laid. All were dropped, at intervals of forty-eight hours, into the nests of meadow pipits, save in the case of the fifteenth egg, for which the nest of a tree-pipit was selected, there being no meadow-pipit's nest available. Deposition always took place in the afternoon, and an egg was never left in a nest until after the first egg of the foster-parents had been laid. On each occasion, after dropping her egg into the nest, she removed one of her dupe's eggs, and this was either swallowed at the nest-side or borne away and disposed of. Apparently only when forced by dire necessity will she leave an egg in a nest in which incubation has commenced.

THE value of the statistics of variation for the study of fossils is discussed at great length by Dr. Hans Klähn in the "Berichte" of the Natural History Society of Freiburg im Breisgau (vol. xxii., part 2, 1920). Numerous tables of measurements of brachiopods, ammonites, and species of *Helix* are given, and various mathematical treatments are attempted to determine the limits of species and varieties. Part of the memoir is a criticism of Wedekind's work on the principles and methods of biostratigraphy.

WE have received some parts of the seventh volume of *Iberica*, a weekly review of the sciences and their applications published in Tortosa. The periodical is well illustrated and written in an attractive manner, containing general articles and summaries besides the usual news and reviews of recent publications. In Spain it cannot fail to spread an interest in the progress of science, while to other countries it affords a

means of obtaining news of Spanish scientific work. One original article gives an account of the Medusæ found on the coast of Catalonia, and another describes the geology of the country between Tortosa and Castellón. There is also an illustrated article on the National Museum of Natural History at Madrid.

AMONG recent publications on mineral oil may be mentioned Bulletin 652, U.S. Geol. Survey, on "The Cushing Oil and Gas Field, Oklahoma," and Bulletin 656 on "Anticlines in the Bighorn Basin, Wyoming." The Cushing field has been opened up since 1912 with such rapidity and success that considerable waste occurred. Its describer, C. H. Beal, believes that the oil and gas have collected from the broad gathering-ground provided by the gentler slope of the anticlinal to the west, the gas arriving first into the crest of the fold, and banking up a following oil-pool west of it. The field in southern Wyoming is in Cretaceous strata, and here again it is pointed out, by D. F. Hewett and C. T. Lupton, that there is most likelihood of oil where upfolds occur near large areas of gently rising beds. The area of supply controls the quantity in the anticlines. In the "Summary of Progress of the Geological Survey of Great Britain for 1919" (1920, 2s. 6d.) some details are given of the recent borings for oil in Derbyshire and Staffordshire. The Lower Carboniferous shales, and not the limestone, are regarded as the probable source of such oil as has been found.

WE have received the fifth list (for 1917) of the earthquakes registered at the observatory of De Bilt, Holland. This station is provided with a pair of Galitzin seismographs, a Wiechert astatic seismograph, and a pair of Bosch horizontal pendulums. The catalogue, which is one of the most complete issued, gives for each of the 394 earthquakes recorded the time, period, and amplitude of every phase, with a summary of the times of the principal phases at other observatories and the position of the epicentre when that is known. The munitions explosion in the north of England on October 1, 1917, was manifested in Holland by the rattling of windows, etc., while that of East London on January 19, 1917, apparently passed unnoticed.

THE Danish Meteorological Institute has published the issue for 1920 of the annual report on the state of the ice in the Arctic seas. The year showed several peculiarities in amount and distribution, although information was lacking from many regions. In the Barents Sea ice was much scarcer than usual, and there was open water as far east as Novaya Zemlya all the summer, while even the Kara Sea offered fewer difficulties than in normal years. On the west coast of Spitsbergen the condition differed little from the normal, but Storfjord was exceptionally free from ice in late summer. There is little information from the east coast of Greenland, but more ice than usual passed round Cape Farewell into Davis Strait. This meant that the ice must have been packed close against the east coast, since the shores of Iceland were practically free from ice throughout the year.

NO. 2685, VOL. 107]

On the Newfoundland Banks icebergs were numerous, and drifted somewhat further south than usual during the first half of the year. In Davis Strait and Melville Bay the ice was more abundant than usual during the spring and early summer.

THE index-numbers of vols. xxiii. of the Physics and Electrical Engineering Sections of *Science Abstracts* complete the volumes for the year 1920. As compared with the volumes for 1919, the Physics Section with its 750 pages shows an increase of about 90 pages, and the Electrical Engineering Section with 633 pages an increase of 150 pages. The number of physics abstracts has increased from 1580 to nearly 1670, and that of the electrical engineering abstracts from 940 to nearly 1120. These changes bring the two volumes back to pre-war dimensions, although the number of articles abstracted is still considerably below the pre-war number. Unless there is a marked change in the importance of the articles abstracted, this increase in the average length of an abstract cannot be regarded as altogether satisfactory. Apart from this tendency, the volumes retain their positions as annual records of the progress of physics and electrical engineering, with which no worker who requires accurate and up-to-date information can afford to dispense.

AN interesting paper by Mr. G. Stead was read to the Institution of Electrical Engineers on March 16 in which the effect of electron emission on the temperature of the filament and anode of a thermionic valve was investigated. It was found that the temperature at any point on a tungsten filament which was emitting electrons was altered by the passage of the emission current through the filament and by the latent heat of evaporation of the electrons. Direct measurements were made with an optical pyrometer of the temperature along the emitting filament. It was found that the distribution of temperature was unsymmetrical, the negative limb being hotter than the positive limb. An account is also given of measurements of the temperature of an anode undergoing electron bombardment. The curve obtained, which shows the relation between the anode temperature and the number of watts dissipated by the anode per sq. cm. of surface, will prove useful to manufacturers.

ON March 17 Sir William Noble read a paper to the Institution of Electrical Engineers on "The Long-distance Telephone System of the United Kingdom." It deals mainly with the improvements that have been made in line-plant design during the last ten years. The recent expansion of long-distance telephony has led to a congestion of the pole lines along roads, railways, and canals. Improvements, however, in underground long-distance telephone cables have led to a solution of the difficulty, and practically all the new trunk lines are, in consequence, underground. The three-electrode thermionic amplifier can be used as a telephone repeater, and its general introduction has revolutionised long-distance communication schemes. Amplifiers can also be used to obtain duplexing—that is, both-way working of the line. "Wired wireless" or, as it is better called, "high-frequency carrier-wave

telephony" was also discussed, but its practical use in this country would be very limited.

THE sensitising of photographic emulsions for green has always presented difficulties. The well-known "gap in the green" of orthochromatic plates, which caused certain natural greens to be rendered too dark, is perhaps the most notable of the irregularities. We learn from a communication of Dr. König's in this month's Colour Supplement of the *British Journal of Photography* that Dr. Robert Schuloff, of the Höchst dye works, has prepared a new dye, "pinaflavol," which Dr. Eder finds to be "the long-required green sensitiser, having a maximum at about the line E, falling sharply to D, and extending without gaps to F. . . . It yields a strong, even, spectrum band over the whole of the green, blue, and violet." The rapid fall of sensitiveness at D is of especial advantage in three-colour photography, as the green record can be taken with a yellow filter which can easily be obtained of great transparency to green. Hitherto it has been necessary to cut off the red as well as the blue by means of a green filter, and all green filters reduce very notably the very colour that it is desired that they should transmit. Pinaflavol is used in the same manner as the cyanine and isocyanine sensitisers.

THE salving of the Italian battleship *Leonardo da Vinci* forms the subject of an illustrated article in the *Engineer* for March 18. This ship was blown up at anchor at Taranto in 1916, the rent in the hull measuring more than 500 sq. ft. and extending up both sides. The vessel settled down by the stern, capsized to port, and sank in six fathoms of water. She is 650 ft. long, the displacement is 22,380 tons, and she is armed with thirteen 12-in. guns. Being extremely valuable, a committee was set up to report

on different schemes of salvage and to arrange for carrying out the work. It was finally decided to refloat the ship upside down by means of compressed air, to tow her into the Taranto dry dock, and there to repair the damage so that she could afterwards be righted at sea. The superstructure, turrets, guns, etc., were detached and left provisionally at the bottom of the sea in order to permit the vessel to enter the dry dock in an inverted state. The whole of the projected work has now been accomplished, and the ship was righted on January 24 last. The salvage of this vessel constitutes a most remarkable and unprecedented feat. It is also notable from the engineering point of view, since it has proved possibilities for the use of compressed air which had not previously been put to the test.

A VERY useful catalogue (New Series, No. 1) of second-hand books and journals dealing with zoology has just been received from Messrs. Wheldon and Wesley, Ltd., 38 Great Queen Street, W.C.2. It contains the titles of no fewer than 2481 works (many from the library of the late F. Du Cane Godman) in the departments of Pisces, Reptilia and Batrachia, Aves, Mammalia, Anthropology, Domestic Quadrupeds and Birds, General Systems and Early Treatises, and General Faunas; also text-books and miscellanea. The catalogue can be obtained free of charge upon application to the publishers.

ON p. 85 of our issue for March 17 we referred to Mr. A. C. Kinsey's papers on American Cynipidae or gall-wasps. Owing to an oversight they were attributed to the Proceedings of the U.S. National Museum, whereas they were published in Bulletin 42 of the American Museum of Natural History.

Our Astronomical Column.

DISCOVERY OF PONS-WINNECKE'S COMET.—The comet Pons-Winnecke was detected by Prof. Barnard on April 10d. 21h. 17-0m. G.M.T., R.A. 15h. 54m. 38s., N. decl. $36^{\circ} 38'$. Daily motion $50'$ in north following direction. The indicated date of perihelion is June 11 or 12. There will be a fairly close approach to the earth, but no collision. Meteors are very probable about June 27.

REID'S COMET.—This comet is brightening and coming into a more convenient position for European observers. Many observations are reported, the latest being made at Copenhagen by Miss Vinter-Hansen: G.M.T. April 4, 14h. 47-9m., apparent R.A. 20h. 26m. 31-40s., apparent S. declination $2^{\circ} 38' 5''$.

On April 2 the comet was described as small and bright, about 8th magnitude, with strong central condensation, no tail seen, but moon bright. It remained visible in the dawn as long as 9th magnitude stars. The orbit and ephemeris given in NATURE for March 31 are not much in error, and there is every reason to anticipate that the comet will attain faint naked-eye visibility. It will pass close to the North Pole in mid-May.

DOUBLE STARS.—Mr. J. Jackson contributes an article on this subject to the *Observatory* for March,

NO. 2685, VOL. 107]

in which he examines the criteria for distinguishing physical pairs from optical ones. It is pointed out that two stars of the 9th magnitude, or brighter, within $5''$ of each other are likely to form a physical pair. Wide pairs with appreciable relative motion are in most cases optical; without appreciable relative motion their state is doubtful unless there is a considerable common proper motion.

If the relative motion of a pair of stars is less than P.M./10, they are probably binary. Some observers have been very reluctant to admit the first principle, and have questioned the binary character even of such obvious pairs as β Cygni.

Mr. Jackson applies his principles to selected portions of Burnham's General Catalogue, classifying several stars as obviously binary, others as almost certainly optical. He passes on to consider the hypothetical parallax, on the assumption that the mass of each system is twice that of the sun. He shows that this may often be estimated, even if only a small portion of the orbit has been observed; where its value is large the star should be put on the list of parallax stars. If the observed parallax is not very different from the hypothetical one, the star is probably a physical binary. Thus β 4972 and β 7514 are shown to be respectively physical and optical.

The Internal Physics of Metals.

THE general discussion on the failure of metals under internal and prolonged stress, held on Wednesday, April 6, was of special interest for several reasons. In the first place, being arranged jointly by the Faraday Society, the Institution of Mechanical Engineers, the Iron and Steel Institute, the Institute of Metals, the Institute of Shipbuilders in Scotland, and the East Coast Institution of Engineers, it constituted a symposium which united the physicist, the metallurgist, and the engineer in the discussion of a problem which can be solved only by the co-operation of all three. The problem itself, also, is of no small interest, whether viewed from the practical point of view of the engineer who is concerned with the adequate safety and permanence of his works, or from the scientific point of view as a question of the internal physics of metals and of solids in general.

Briefly, we have first the long-known phenomenon miscalled "season-cracking" in brass. A cold-drawn rod or tube, or a spinning such as a cup, may appear to be perfectly sound and good when first made, but after a time, which may be a matter of hours or of years, it breaks, seemingly spontaneously. Such fracture we now know is the result of the prolonged operation of an internal stress which existed in the finished article as the result of undue deformations applied to the metal during manufacture, and this stress has in time proved sufficient to pull the constituent crystals apart. This is a type of fracture quite different from that which the same metal undergoes if broken in the ordinary way in a tensile test, when fracture occurs through the crystals themselves, and not through their junctions.

Until 1919 this phenomenon stood as an isolated, but important, fact in connection with brass, but then it was discovered that other metals, such as certain aluminium alloys, lead, and even steel, could undergo similar inter-crystalline fracture after the lapse of time if left, under suitable conditions, exposed to a sufficiently severe and continuously acting stress. In view of these discoveries Rosenhain and Archbutt put forward the suggestion that inter-crystalline fractures of this type arise as a consequence of the existence of an amorphous layer between adjacent metallic crystals; such a layer is regarded as consisting of a highly viscous, under-cooled liquid, and should, therefore, be subject to a minute amount of movement—either true viscous flow or visco-elastic displacement—under the action of long-continued stress. If, then, the form of the crystal boundaries is such as to favour easy relative displacement, inter-crystalline fracture will ultimately result, while if the boundaries between crystals are irregular or rough, displacement will soon be checked and no fracture occur. Rosenhain and Archbutt found that in their aluminium alloy they could produce at will a micro-structure with smooth boundaries in which failure under stress might occur within an hour, while in another condition the same material would resist failure for many years, and probably indefinitely. Similar results were obtained with lead, and in the case of steel also indications of a powerful effect arising from the nature of the crystal boundaries were found.

More recently Moore and his collaborators at Woolwich have shown that the selective action of certain chemical reagents, such as mercury salts and ammonia on inter-crystalline material, in the case of brass, plays a most important part in the process of "season-cracking"; indeed, they go so far as to say that, in brass at all events, such chemical action is essential to the occurrence of the phenomenon. In reply to this contention Rosenhain and Archbutt have recently shown that while even in their special alloy, in which the phenomena are most strictly analogous to those in brass, but more rapid, and therefore more readily studied, chemical action—in that case by air or water vapour, or both—also affects the process, yet it serves, not as the prime cause, but as an accelerator. Specimens of their alloy which fail, when left in the air, in a few hours, withstand the same stress for several days when kept in a high vacuum or in hydrogen; yet they ultimately fail even in the total absence of chemical action, and it is suggested that severely stressed brass will do so also, given time enough.

The main discussion, however, did not turn upon the relatively minor differences between the views of Moore and of Rosenhain, but rather upon the general question of the existence of the supposed inter-crystalline amorphous layer and its properties. Here it seems that some of the metallurgists who wished to dispose of this theory on *a priori* grounds—that the existence of such a layer in "highly crystalline" materials like metals was not possible—adopted a somewhat unintelligent and unscientific attitude. They cannot surely claim to have so intimate a knowledge of the behaviour of atoms during crystallisation as to entitle them to say that when two growing crystals approach each other the process of crystallisation *must* continue until the last layer of atoms is in some way forced to assume some orientation common to both the adjacent space-lattices. Nor can they dispute that a highly viscous liquid may behave as a hard and brittle quasi-solid under forces as ordinarily applied, *i.e.* at relatively rapid rates, and may yet undergo flow or visco-elastic displacements if sufficient time is allowed.

It is not, perhaps, possible to say that the actual existence of amorphous inter-crystalline layers in metals is proved, but it must be admitted that there is more than a strong *prima facie* case for the theory, and, further, that it serves to explain and unify a very large range of phenomena which otherwise lack explanation or correlation. The theory of an amorphous inter-crystalline layer must at least be regarded as an extremely helpful hypothesis which has been gaining steadily in strength from the accumulation of experimental evidence during the past ten years. Whether it will ever be possible to place it on a surer foundation it is difficult to predict, but our methods of studying the internal structure of matter have made such great progress in recent years that more is to be anticipated. Meanwhile, so far as inter-crystalline fracture under prolonged stress is concerned, it remains the only tangible explanation which was put forward during the discussion.

Mongolian Imbecility.

DR. F. C. CRUIKSHANK read a paper on March 22 at a meeting of the Royal Anthropological Institute entitled "The Ethnological Significance of Mongolian Imbecility." He pointed out that Robert Chambers eighty years ago directed attention to the occurrence in England of persons who in adult

life are yet a "kind of children" and "of the Mongolian type." In 1866 Dr. Langdon Down definitely described a type of idiocy that he called Mongolian, and that has been recognised ever since by physicians. The homologies of these imbeciles have been discussed by medical men from various points of view, but it

is generally held that their resemblances to racial Mongols are only "accidental." Dr. Cruikshank, however, maintained that many of the characteristics of these children are really Mongoloid, while others are definitely simian and exhibit convergence towards the orangoid rather than the chimpanzoid or general type of great ape. It was pointed out that "Mongolian imbeciles" adopt the *horizontal* disposition of the lower limbs in sitting that is characteristic of racial Mongols and of orangs, in contradistinction to the *vertical* disposition adopted by negroes and other non-Mongoloid races, chimpanzees, and gorillas. The correlation of the "habitual posture" with various structural peculiarities was insisted upon and discussed.

An attempt had been made to explain away these homologies by reference to the hypothesis of gland-balance influence on racial peculiarities, first put forward by Dr. Cruikshank in the *Lancet* in 1912. He maintained, however, that this hypothesis was by itself inadequate, and that it was necessary to invoke the notion of a line of common descent, even though in consequence it became impossible to avoid acceptance of some such polyphyletic scheme of human origin as that of Klaatsh. While there was abundant evidence, both historic and prehistoric, making it impossible to exclude the persistence in Western Europe of sufficient "Mongolian" blood to account for the Mongolian characteristics of these unfinished children we call "Mongolian imbeciles," the orangoid homologies were not thus explained. Further precise anatomical study was required, not only of the Mongolian imbeciles, but also of the many Western "Mongoloids" who are not actually imbecile and of the Mongolian races themselves.

Finally, it was shown that while "Mongolian" imbeciles converge towards the orang, there is another type of mental defect recognised in Europe whereof the subjects converge markedly in respect of their simian homologies towards the chimpanzee and away

from the orang. There was need then for the coordination of the observations of the physicians and the anthropologists in the free discussion of their observations.

In the course of the discussion which followed the reading of the paper, Prof. Keith, while congratulating the author on his work as a pioneer in this subject, maintained that the homologies to which he had directed attention were superficial. Mongolism, he held, was pathological, and arose out of some defect in the working of the complicated internal mechanism which was a common inheritance of man and the anthropoids. Of this working we knew little except that in certain obscure conditions it gave rise to such abnormalities as acromegaly, cretinism, Mongolism, and the like. Dr. Langdon Down directed attention to certain peculiarities in "Mongolian" imbeciles which had not been mentioned by the author. The iris was frequently spotted and lacking in colour, the hair grew further down the back of the neck than in the normal, and the sides of the face were often covered with a down. Prof. Elliot Smith expressed the view that Mongoloids were purely pathological specimens, and directed attention to the recent investigations of certain Dutch physicians which indicated that these abnormalities were due to an interference with pre-natal growth in the seventh week of intra-uterine existence, and occurred in the offspring of young or worn-out mothers. Dr. F. C. Shrubbsall described a number of cases observed among defective children in the London area, and adduced statistics in support of the view that they occurred with greatest frequency in exhausted mothers. They were often followed by a miscarriage.

In his reply Dr. Cruikshank maintained that the view that the Mongoloid arose from a disturbance of the gland-balance or from an interference with pre-natal growth was not inconsistent with his theory of common descent.

The Alaskan Salmon.

IN an article of exceptional interest contributed to the *Scientific Monthly* for February, Prof. Barton W. Evermann, an American ichthyologist of eminence, asks this question: Can the Alaskan salmon fisheries be saved? These Pacific salmon are of economic value for the whole world. The first cannery was erected and operated in 1878, and by 1918 the number had grown to 135. The pack was 8159 cases in 1878, and in 1914 about 2,500,000, the highest figure yet reached. In 1919 the total pack had been reduced to about 1,250,000 cases, and there is every reason to fear that the decrease is progressive. The most fertile fishery in the world is thus in danger of practical extinction (from the commercial point of view, at all events) owing to ruthless exploitation unchecked by legislation and almost unguided by State-directed investigation.

There are five species of Pacific salmon (*Oncorhynchus* spp.), all of which have much the same life-history. They are anadromous, the adults ascending rivers in order to spawn. They die, males and females alike, as soon as they have spawned; not one of them ever returns to the sea. For a brief period of a week or two in every year each varietal species is represented only by the developing eggs, and no parent ever sees its offspring—surely something quite unique in the vertebrate sub-kingdom! The young fish remain in the rivers for one to several years, and then descend to the sea. Each river contains one variety, or elementary species, recognisable to the fishermen and zoologists (this is the case for

the sockeye, *O. nerka*, at all events), and it is the result of the "home stream" condition. The fry reared in one river are said invariably to return to the waters in which they have been reared. In all cases the sockeye seeks streams which have lakes as their head-waters, and the result is that the conditions under which they are reared are highly individualised. These conditions are most peculiar and of exceptional biological interest, demanding the fullest investigation. One would hesitate to believe in them were not the statements made so positively and on the authority of ichthyologists of distinction.

How to arrest the decline which seems to threaten the very existence of an industry of world-importance is, however, the author's chief concern. Restriction of the annual quantity of fish packed is, of course, the only practicable remedy, but so powerful are the interests involved and so hand-to-mouth are the great financial enterprises that any suggestion of the kind is certain to arouse intense opposition, and it can scarcely be expected in these days that any conceivable Government will have so much courage as to take the steps that the conditions obviously indicate. But investigation must precede any such restriction. It appears that hatching out fry artificially has had no apparent effect—at least, with the methods so far employed—and so restriction seems to be the only remedy, the productivity of each river being found and the rate of exploitation fixed at the highest point compatible with undiminished yield. In a river methods of investigation are possible that could not

be followed in the sea. It is practicable to "rack" the rivers, permitting the ascent of the fish only through a narrow gap. It is even possible to count the fish that so pass during short sample times that can be averaged. Then the ratio of fish ascending to spawn to the run of fish four or five years later (when the hatched fry return from the sea) can be calculated. Comparisons over a number of years can so be made and a maximum degree of exploitation permitted. The method is, of course, much more complex than is here indicated, but it is all highly practicable. To such statistical investigation would, of course, be added a prolonged study of the spawning-beds in the head-waters, even the artificial improvement and control of the spawning and the elimination of the natural enemies of the very young fry. To some extent such investigations have been carried out—in spite, it is said, of the opposition of the Secretary of Commerce, whose non-appreciation of the value of scientific investigation was all that might have been expected.

Now, however, the commercial interests are threatened and the administrative attitude is likely to change—with results of value not only to the industry, but also to general biology.

J. J.

Recent Applications of Interference Methods.¹

PROF. MICHELSON said that since the armistice he had been interested in three questions: the measurement of the earth tides, a re-determination of the velocity of light, and the measurement of the diameters of fixed stars.

In the first of these problems the experiment reduced itself to the measurement of the difference in the movements of the free surfaces of water at the extremities of a long pipe submerged in the ground. Preliminary work was carried out with microscopes, but the final records were obtained from the movements of interference fringes. Records were taken at intervals of two hours on a kinematograph which worked continuously for a year. The results obtained were plotted, and found to agree very closely with those calculated from theory.

In the re-determination of the velocity of light the arrangement ultimately to be employed was the same as that previously used by Prof. Michelson, except that a much longer distance—say, twenty-five miles—was contemplated. This was to permit a larger angular movement of the rotating mirror, which in this case consisted of an octagon of glass rotating at about 1000 revolutions per second. If the speed were so adjusted that the octagon described 45° during the time taken by light to pass to the distant mirror and back, the returning beam would be undeviated. This condition could be determined to a much higher degree of precision than was possible for the angular measurements involved in previous determinations. The application of interference to this work lay in the method of making the angles of the octagon very accurately equal.

The third problem, that of measuring the diameters of the stars, was solved on lines which Prof. Michelson had applied many years ago to the measurement of the separation of double stars. The method consists in varying the separation of two slits in front of the object-glass of a large telescope until the visibility of the parallel diffraction fringes seen in the focal plane of the telescope is a minimum. No exist-

ing telescope is of large enough aperture for this condition to be reached in the case of single stars; but by attaching an arrangement of mirrors in front of the large 100-in. telescope at Mount Wilson Observatory, which in effect increased its aperture to 20 ft., it had been possible to obtain a result for the star α Orionis, the fringes from which disappeared when the slits were separated by about 10 ft. This corresponded to an angular diameter of just under a twentieth of a second.

University and Educational Intelligence.

PROF. G. ELLIOT SMITH is delivering two lectures, one at Groningen University on April 14 and the other at the University of Utrecht on April 16, entitled "Vision and Evolution." These lectures are being given under the auspices of the Dutch Royal Academy of Sciences, and form part of the scheme for the exchange of lecturers between this country and Holland which has been referred to recently in these columns.

THE Summer School of Civics, organised by the Civic Education League, is to be held this year at Guildford (Surrey) on July 30–August 14. Courses on economics, anthropology, social biology, maternity and child welfare, sociology, civics, and social psychology will be among those offered; while practical training in the presentation of civics (through public speaking, etc.) and in the regional approach to civics will also be provided. Full particulars may be had from the secretary, Miss Margaret Tatton, Leplay House, 65 Belgrave Road, Westminster, S.W.1.

THE governing body of Emmanuel College, Cambridge, is offering a research studentship of the annual value of 150*l.*, which will be tenable for two years and renewable in exceptional circumstances for a third year. The studentship is offered to a research student commencing residence at the college in October next, and applications should reach the Master of Emmanuel not later than September 17. The award, which will be made on the evidence submitted by the candidates, should include two certificates of good character, an account of their career with the names of professors or teachers under whom they have studied, a statement of the proposed line of research, and evidence of ability to undertake that particular class of work.

WHEN the closing of the Finsbury Technical College was announced by the City and Guilds Institute in July last the many friends of the college began to take steps to avert the threatened disaster. A defence committee, consisting principally of old students, was formed, and it presented a petition to the governing body signed by many workers in all branches of science and by others connected with industry and with some of the City Companies who felt that all possible steps should be taken to continue the college. The professional institutes and learned societies presented a memorial signed by their presidents, and other bodies, including the National Union of Scientific Workers, took such other action as seemed likely to help. The strong hope that, with the assistance of the London County Council and the Board of Education, the future of the college might be assured for the next five years was recently expressed by the governing body to the defence committee and the institutions concerned. The success of the negotiations is now announced, and it may be hoped that the permanence of the college will in the meantime be assured without its distinctive character being in any way impaired.

¹ Abstract of the Sixth Guthrie Lecture, delivered before the Physical Society of London on March 11 by Prof. A. A. Michelson, of the University of Chicago.

THE annual report, covering the period February, 1920–February, 1921, of the University College (London) Committee has just been issued. During the year 2833 whole-time students were enrolled, of whom more than 40 per cent. were women; for evening and vacation courses there were 389 and 287 enrolments respectively, and in each case there were more than twice as many women as men. The figures quoted for whole-time students include 383 who are engaged on post-graduate and research work. The report contains a record of the principal activities of the college during the year, and also the annual financial statements, according to which the expenditure has been nearly 119,000*l.* The revenue from fees was 45,000*l.*, and a further sum of about 71,000*l.* was provided by income from endowments, donations, and grants, leaving a deficit for the year of some 2600*l.* The most important benefaction which has been received is the Rockefeller gift for medical education. By the terms of the trust deed the Rockefeller Foundation has offered to give 400,000*l.* to University College Hospital Medical School to assist in building and equipping a clinical unit such as the college authorities may consider desirable, and a further sum of 435,000*l.* will be given towards the support of clinical facilities and teaching; the University of London, on behalf of University College, is offered a sum of 190,000*l.* to assist in extending the anatomy and physiology schools at the college, and a further sum of 180,000*l.* to form an endowment for laboratory teaching. In every case the original plans of the college authorities will be the basis of all the changes made. The total sum of money which is being placed at the disposal of the college amounts to no less than 1,205,000*l.*

A SPECIAL luncheon was held on April 7 at the Royal Hotel, Bristol, in connection with the movement to re-establish the West of England in its former position of leadership in the new era of progress upon which the Empire is now entering. The Vice-Chancellor of the University of Bristol, Sir Isambard Owen, after referring to the proud record of the West of England from the fifteenth century until the period following the Napoleonic wars, pointed out that in the present period of reconstruction it still retains its dominant natural advantages, together with a relatively much greater increase of population than the rest of the country. In this new era, when exact scientific knowledge and the capacity to use it are the foundations of progress, the universities are the pivot of the educational system, in that they are directly and indirectly responsible for the training of the teachers in our schools, so that no class can remain indifferent to the welfare of the universities. The University of Bristol is fortunate in possessing an unencumbered site of 13½ acres near the heart of the city, and through the princely generosity of the late Mr. H. O. Wills and his sons, Messrs. G. A. and H. H. Wills, it is being housed in a pile of university buildings unsurpassed in this country outside Oxford and Cambridge. What is now required is money for endowments, for staff, and for working capital, and an appeal is to be made for public support. In common with the other English universities, Bristol is overcrowded with students in every faculty, whilst income has shrunk to less than half its pre-war value. Government support is increasing, the neighbouring counties are promising grants, but private benefactions are urgently required, and they are essential to ensure the freedom and independence of the University and to provide the highest knowledge and intellectual training for all who are capable of profiting by it. The universities are ready to rise to their privileges if only the people who can will aid them financially.

Calendar of Scientific Pioneers.

April 14, 1895. James Dwight Dana died.—Professor of natural history and geology at Yale, Dana, like Darwin, laid the foundation of his work during scientific voyages in the southern seas. He had a world-wide reputation as a zoologist, geologist, and mineralogist.

April 15, 1894. Jean Charles Gallissard de Marignac died.—A native of Switzerland, Marignac was professor of chemistry at Geneva. To test Prout's hypothesis he determined with extreme care the atomic weights of twenty-eight of the elements. He also studied problems in physical chemistry.

April 16, 1788. George Louis Leclerc, Comte de Buffon, died.—As director of the Jardin des Plantes and as author of the "Histoire Naturelle," Buffon invested science with new dignity and interest. Fertile in ideas, he helped to pave the way for the modern theory of evolution.

April 16, 1883. Sigismund Wroblewski died.—Wroblewski spent six years as an exile in Siberia. Afterwards, when professor of physics at Cracow, he did important work in the condensation of gases at low temperatures.

April 16, 1901. Henry Augustus Rowland died.—Like Langley, Rowland began life as an engineer. In 1876 he became the first professor of physics in the Johns Hopkins University. He redetermined the value of the ohm and the mechanical equivalent of heat, and made fundamental studies of the solar spectrum. His diffraction grating was described in 1882. At his death his remains were cremated and buried beneath his famous ruling engine.

April 16, 1914. George William Hill died.—One of the greatest masters of dynamical astronomy, Hill was for thirty years connected with the American Nautical Almanac. Newcomb was his colleague.

April 17, 1905. Otto Wilhelm von Struve died.—In 1861 Struve succeeded his father as director of Pulkowa Observatory, adding greatly to the reputation of what Gould called the astronomical capital of the world.

April 18, 1873. Justus von Liebig died.—Born in 1803, Liebig at the age of twenty-three became professor of chemistry in the small town of Giessen, which by his teaching and discoveries and great personality he made the Mecca of young students of chemistry. One of the most illustrious chemists of his age, his work on agricultural chemistry raised him to the rank of a benefactor of mankind. He died at Munich, whither he had removed in 1852.

April 19, 1882. Charles Robert Darwin died.—Through Henslow, the Cambridge botanist, Darwin became naturalist to H.M.S. *Beagle* and spent five years exploring the South Seas. In 1842 he settled at Down, in Kent. His views, with those of Wallace, on natural selection were given to the Linnean Society in July, 1858, and the following year he published his "Origin of Species." Marking as it does a turning-point in the history of thought, this work was the first of a series which made Darwin the great inspiring leader of evolutionary biology.

April 19, 1906. Pierre Curie died.—The discoverer with his brother in 1883 of piezo-electricity, Curie with his wife, Marie Sklodowska, while studying pitchblende in 1898, announced the existence of polonium and radium. At the time of his death Curie was professor of physics at the Sorbonne.

April 20, 1786. John Goodricke died.—The son of a Yorkshire gentleman, Goodricke three years before his death, when only nineteen years of age, received the Copley medal for his discovery of the period and cause of the changes in the variable star Algol. E. C. S.

Societies and Academies.

LONDON.

Zoological Society, March 22.—Sir S. F. Harmer, vice-president, in the chair.—Prof. J. C. Ewart: The nestling feathers of the mallard, with observations on the composition, origin, and history of feathers.—E. T. Newton: Fossil bones of birds which had been collected by Dr. Forsyth Major from caves in Sardinia, Corsica, and Greece.—G. C. Robson: The molluscan genus *Cochlitoma* and its anatomy, with remarks upon the variation of two closely allied forms.—H. E. Andrews: The Oriental species of the genus *Callistomimus* (Coleoptera, Carabidæ).

Geological Society, March 23.—Mr. R. D. Oldham, president, in the chair.—E. B. Bailey: The structure of the south-west Highlands of Scotland. Evidence is given for allotting the south-west Highlands to three great structural divisions in descending order as follows:—Loch Awe Nappe, Itay Nappe, and Ballappel Foundation. The two lower of these divisions are themselves structural complexes. All available evidence points consistently to movement from the north-west during the development of these structural divisions. In a general way there is a close relationship between depth of cover and degree of metamorphism. No metamorphic inversions have been noted, and it is clear that crystallisation continued until the close of the early nappe-movements. In Cowal a peculiar type of metamorphism reigned, both in pre-anticlinal and in anticlinal times, wherefore it would seem that the early and late movements of the south-west Highlands are but successive chapters of a continuous history of mountain-building.

PARIS.

Academy of Sciences, March 21.—M. Georges Lemoine in the chair.—MM. H. Deslandres and Burson: Researches on the atmosphere of the stars. The recognition of the upper layer in some stars and comparison with the sun. The H_3 and K_3 lines (hydrogen and calcium) have been found in the spectra of ϵ Geminorum and α Orionis, and have proved to be about five times larger than in the sun. Hence it is concluded that the upper atmosphere in these two stars has a greater density or a stronger electrical field than in the sun.—L. Lecornu: The experimental determination of the movement of a solid.—E. Bouty: The interpretation by dielectric cohesion of a celebrated experiment of Sir J. J. Thomson.—P. Sabatier and B. Kubota: Catalytic hydrogenation with copper. Experiments with copper prepared by reducing the hydroxide at about 200° C. as a catalyst. The substances reduced included benzaldehyde, acetophenone, benzoquinone, benzoylpropanone, and phthalic anhydride.—G. Julia: Two consequences of the functional differential equation deduced from the conformal representation.—G. Valiron: The zeros of integral functions of infinite order.—A. Sartory, L. Scheffler, P. Pellissier, and C. Vaucher: A method of evaporation, concentration, and desiccation of organic or mineral substances. A current of cool, dry air is passed over the material to be dried, and the moisture thus taken up removed from the air by freezing, the whole forming a circulating system. Some results are given.—M. and L. de Broglie: Bohr's model atom and corpuscular spectra. Some consequences of this theory of the atom are developed and compared with experiment. In some cases the results predicted are in agreement with the experimental results; in others, additional experiments are required.—F. Michaud: The energy of a system of currents. Conditions of stability of equilibrium.—H. Chipart: The mutual

(apparent) actions of magnets and currents plunged in a magnetic liquid.—R. Audubert: The mechanism of the energy exchanges in the electro-chemical passage of an atom to the state of ion.—A. Bigot: The contraction on drying of kaolins and clays. The materials examined were moulded into briquettes, either as pastes of varying consistency or dry, then allowed to dry slowly, and the losses in weight and alterations in length determined. The results obtained with six substances are given in a diagram.—E. Passemard: The alluvial terraces of Nive and their relations with the Mousterian screen of Olha.—P. Scherischewsky: Dry mist. A discussion of the difference between dry mist and fog and of the meteorological conditions peculiar to each, with special reference to the effects on aviation.—L. Armand: The nuclear phenomena of heterotypical kinesis in *Lobelia urens* and in some Campanulaceæ.—C. A. Bey: The utilisation of the stems of various annual plants in view of the production of mechanical energy necessary for agricultural work in the valley of the Niger. From a calculation of the amount of energy required for growing cotton it is shown that this could be obtained from a power gas plant manufacturing a weak gas, the raw material being plant products grown annually, timber being excluded.—H. Herissey: The hydrolysis of α -methyl-*d*-mannoside by soluble ferments. The most advantageous source of *d*-mannosidase is germinated lucerne seed.—G. Bertrand and R. Vladesco: The causes in the variation in the amount of zinc in vertebrate animals: the influence of age. The amount of zinc present is at its maximum in young individuals. This is opposed to the results obtained by S. Giava, and the causes of this disagreement are discussed.—R. Fosse and Mlle. N. Rouchel-man: The formation of urea in the liver after death. Proof of the formation of urea in the liver after death is given; this property of the liver is destroyed by heating to 100° C.—A. Lumière and H. Couturier: Pregnancy and the phenomena of anaphylactic shock. Guinea-pigs in a state of pregnancy are immune from anaphylactic shock.—J. Pellegrin: The subfossil otoliths of the fishes of the southern Sahara and their significance.—E. F. Galiano: The chemico-tactic reactions of the flagellated *Chilomonas*.—Mme. Anna Drzewina and G. Bohn: The defence of animals grouped together against poisons. In an earlier communication on the poisonous action of colloidal silver on the *Convolvula* it was shown that isolated individuals were much less resistant than grouped individuals. Similar experiments on the larvæ of *Rana fusca* are now described, with results confirming the earlier work. The larvæ appear to emit a protective substance, and when the individuals are grouped the defence is efficacious.—MM. Alezais and Peyron: The mode of development of the so-called mixed tumours and cylindroma of the region of the face.

WASHINGTON, D.C.

National Academy of Sciences (Proceedings, vol. vi., No. 7, July, 1920).—H. S. Reed: The dynamics of a fluctuating growth-rate. A detailed discussion of various formulæ proposed on chemical, biochemical, or empirical grounds for the representation of the rate of growth, with illustrative statistics obtained from measurements on young apricot-trees. There are three distinct intra-seasonal cycles of growth, in each of which the growth resembles the rate of autocatalytic reaction.—A. J. Lotka: Analytical note on certain rhythmic relations in organic systems. In cases hitherto considered on the basis of chemical dynamics, oscillations have been found to be damped instead of periodic. It is shown, however, that in certain special cases the oscillations may be undamped

and the rhythm indefinitely continued. The results are suggestive of possible interpretations of rhythmic processes in physiology.—H. S. Vandiver: The class-number of the field $\Omega(e^{2\pi i/p^n})$ and the second case of Fermat's last theorem.—C. W. Metz: Observation on the sterility of mutant hybrids in *Drosophila virilis*. Sterility in the rugose-glazed and rugose-wax hybrids is accounted for by assuming dominance of sterility instead of an incompatibility, as was done previously when only rugose-glazed were known.—H. A. Cheplin and L. F. Rettger: Studies on the transformation of the intestinal flora, with special reference to the implantation of *Bacillus acidophilus*. I.: Feeding experiments with albino rats. *B. butyricus* is incapable of accommodating itself to intestinal conditions. *B. acidophilus*, however, submits readily to implantation, at least in the white rat. The beneficial results attributed to various forms of sour-milk products have in all probability been due to the milk as such.—R. Pearl: A single numerical index of the age-distribution of a population. The function here discussed gives a substantially accurate indication of the essential nature of the age-distribution.—M. M. Metcalf: An important method of studying problems of relationship and of geographical distribution. The author shows the value of the method of studying relationships between groups of animals and plants and their geographical distribution and migration routes by means of a comparison of the distribution of the hosts with that of their parasites.—F. V. Coville: The influence of cold in stimulating the growth of plants. The common beliefs that trees and shrubs become dormant because of the cold, and that warm weather is of itself sufficient cause of the beginning of new growth in spring, are both erroneous.—L. B. Loeb: The nature of the negative carriers produced in pure hydrogen and nitrogen by photo-electrons. In pure nitrogen and hydrogen gas the electrons do not attach themselves to the molecules to form ions in any appreciable quantities.—W. F. Durand: Shock or water-ram in pipe-lines with imperfect reflection at the discharge end, and including the effects of friction and non-uniform change of valve opening.

Books Received.

The Electronic Conception of Valence and the Constitution of Benzene. By Prof. H. S. Fry. (Monographs on Inorganic and Physical Chemistry.) Pp. xviii+300. (London: Longmans, Green and Co.) 16s. net.

How to Measure. By Prof. G. M. Wilson and Prof. Kremer J. Hoke. Pp. vii+285. (New York: The Macmillan Co.; London: Macmillan and Co., Ltd.) 12s. net.

Chemical Technology and Analysis of Oils, Fats, and Waxes. By Dr. J. Lewkowitzsch. Sixth edition, entirely re-written and enlarged. Edited by George H. Warburton. (In three vols.) Vol. i. Pp. xviii+682. (London: Macmillan and Co., Ltd.) 36s. net.

Agricultural Meteorology: The Effect of Weather on Crops. By I. Warren Smith. (Rural Text-book Series.) Pp. xxiv+304+vi plates. (New York: The Macmillan Co.; London: Macmillan and Co., Ltd.) 13s. net.

Map Reading. By G. H. C. Dale. Pp. ix+170. (London: Macmillan and Co., Ltd.) 7s. 6d. net.

The Heart and the Aorta: Studies in Clinical Radiology. By Prof. H. Vaquez and E. Bordet. Translated from the second French edition by Dr. James A. Honeij and J. Macey. Pp. xvii+256. (New

Haven: Yale University Press; London: Oxford University Press.) 25s. net.

Reports of the Progress of Applied Chemistry. Issued by the Society of Chemical Industry. Vol. v., 1920. Pp. 626. (London: Society of Chemical Industry.) 15s.

Das Raum-zeit-Problem bei Kant und Einstein. By Dr. Ilse Schneider. Pp. 75. (Berlin: J. Springer.) 12 marks.

Die Quantentheorie ihr Ursprung und ihre Entwicklung. By Fritz Reiche. Pp. vi+231. (Berlin: J. Springer.) 34 marks.

Survey of India. Professional Paper, No. 19. Experiments in Aeroplane Photo Surveying. By Major C. G. Lewis and Capt. H. G. Salmond. Pp. iii+53+3 plates. (Dehra Dun: The Trigonometrical Survey.) 3s.

A Text-book of Electro-Chemistry. By Prof. Max le Blanc. Translated from the fourth enlarged German edition by Dr. W. R. Whitney and Dr. J. W. Brown. Pp. xiv+338. (New York: The Macmillan Co.; London: Macmillan and Co., Ltd.) 18s. net.

Diary of Societies.

THURSDAY, APRIL 14.

ROYAL INSTITUTION OF GREAT BRITAIN, at 3.—C. T. R. Wilson: Thunderstorms (Tyndall Lectures).

ROYAL SOCIETY, at 4.30.—Prof. K. Onnes, Sir Robert Hadfield, and Dr. H. R. Woltjer: The Influence of Low Temperatures on the Magnetic Properties of Alloys of Iron with Nickel and Manganese.—C. N. Hinshelwood and E. J. Bowen: The Influence of Physical Conditions on the Velocity of Decomposition of certain Crystalline Solids.—Prof. H. Briggs: The Adsorption of Gas by Charcoal, Silica, and other Substances.—N. K. Adam: The Properties and Molecular Structure of Thin Films of Palmitic Acid on Water. Part i.—E. P. Metcalfe and B. Venkatesachar: The Absorption of Light by Electrically Luminescent Mercury Vapour.

ROYAL COLLEGE OF PHYSICIANS OF LONDON, at 5.—Dr. T. Lewis: Observations upon the Nature of Auricular Flutter and Fibrillation (Oliver-Sharpey Lecture).

INSTITUTION OF ELECTRICAL ENGINEERS (at Institution of Civil Engineers), at 6.—E. A. Watson: Magnetos for Ignition Purposes in Internal Combustion Engines.

OIL AND COLOUR CHEMISTS' ASSOCIATION (at 2 Farnival Street), at 7.30.—F. H. Barry: Indian Products of Interest to the Oil and Colour Chemist.

CONCRETE INSTITUTE, at 7.30.

OPTICAL SOCIETY (at Imperial College of Science), at 7.30.—F. Twyman: An Interferometer for the Testing of Camera Lenses.—W. Shackleton: The Testing of Heliograph Mirrors

RÖNTGEN SOCIETY (at University College), at 8.15.

HARVEIAN SOCIETY OF LONDON (at Paddington Town Hall), at 8.30.—D. C. L. Fitzwilliams: The Nævi of Children and their Treatment.

FRIDAY, APRIL 15.

ROYAL COLLEGE OF SURGEONS OF ENGLAND, at 5.—Prof. A. Keith: Demonstration of the Contents of the Museum.

INSTITUTION OF CIVIL ENGINEERS (Students' Meeting), at 6.30.—E. A. Phillipson: The Increased Efficiency of the Locomotive.

JUNIOR INSTITUTION OF ENGINEERS, at 8.—C. R. Sams: The Metering of Steam.

SATURDAY, APRIL 16.

ROYAL INSTITUTION OF GREAT BRITAIN, at 3.—Dr. H. H. Dale: Poisons and Antidotes.

MONDAY, APRIL 18.

ROYAL COLLEGE OF SURGEONS OF ENGLAND, at 5.—Prof. S. J. Shattock: Demonstration on Pathological Specimens in the Museum.

ROYAL INSTITUTE OF BRITISH ARCHITECTS, at 8.—A. E. Munby: The Utility of Research on Building Materials

ROYAL SOCIETY OF ARTS, at 8.—Dr. S. J. Lewis: Recent Applications of the Spectroscope and the Spectrophotometer to Science and Industry.

CHEMICAL INDUSTRY CLUB (2 Whitehall Court), at 8.—Dr. A. Rule: India.

ROYAL GEOGRAPHICAL SOCIETY (at Eolian Hall), at 8.30.—Brig.-Gen. Sir Percy Sykes: South Persia and the Great War.

TUESDAY, APRIL 19.

ROYAL INSTITUTION OF GREAT BRITAIN, at 3.—Prof. A. Keith: Darwin's Theory of Man's Origin in the Light of Present-Day Evidence.

ROYAL HORTICULTURAL SOCIETY, at 3.

ROYAL SOCIETY OF MEDICINE (Therapeutics and Pharmacology Section) (Annual General Meeting), at 4.30.—Sir Leonard Rogers: Treatment of Leprosy and Tuberculosis with Sodium Gynocardate.

—Dr. R. E. Walker: The Action and Uses of Kaolin in the Treatment of Asiatic Cholera.

ROYAL SOCIETY OF MEDICINE, at 5.—General Meeting

ROYAL STATISTICAL SOCIETY (at Surveyors' Institution), at 5.15.—R. J. A. Pearson: A Comparison of Pre-war and Post-war Production Costs in Engineering.—N. Crump: A Review of Recent Foreign Exchange Fluctuations.

INSTITUTION OF CIVIL ENGINEERS, at 5.30.—Sir Murdoch Macdonald and H. E. Hurst: The Measurement of the Discharge of the Nile through the Sluices of the Assuan Dam.

INSTITUTION OF PETROLEUM TECHNOLOGISTS (at Royal Society of Arts), at 5.30.—A. W. Davison: Education and Training of a Driller.

ZOOLOGICAL SOCIETY OF LONDON, at 5.30.—The Secretary: Report on the Additions to the Society's Menagerie during the Month of March, 1921.—Mrs. J. Longstaff: Observations on the Habits of the Snail, *Cochlitoma zebra*, var. *fulgurata*, and *Cochlitoma zebra*, var. *obesa*, Pfeiffer, in Confinement.—R. I. Pocock: The External Characters and Classification of the Procyonidae (Racoons, etc.).—M. A. Smith: New or Little-known Reptiles and Batrachians from Southern Annam (Indo-China).

ROYAL PHOTOGRAPHIC SOCIETY OF GREAT BRITAIN, at 7.—A. Pereira: From Camera to Cinema: The Printing of a Film.

ROYAL ANTHROPOLOGICAL INSTITUTE, at 8.15.—S. H. Warren: Report on Excavations at the Stone Axe Factory of Graig-lwyd in 1920.

ROYAL SOCIETY OF MEDICINE (Pathology Section) (Annual General Meeting), at 8.30.—Sir Lenthal Cheate: Parenchymatous Inflammation of the Breast.—A. T. Glenn, Miss K. Allen, and Dr. R. A. O'Brien.—(1) Schick Reaction; (2) Diptheria Prophylactic Immunisation with Toxin Anti-toxin Mixture.—Dr. E. H. Kettle and Dr. Joan Ross: Study of the Endotheliomata.

WEDNESDAY, APRIL 20.

SOCIETY OF GLASS TECHNOLOGY (Annual General Meeting) (at University College), at 2.30.—Presidential Address.—G. Dowse and E. Leigh: Automatic Glass Feeding Devices.

ROYAL METEOROLOGICAL SOCIETY, at 5.—C. E. P. Brooks: The Evolution of Climate in North-West Europe.—Lieut. G. C. Steele: Discussion on A Brief Review of the Influence of Meteorology on Naval Warfare.

ROYAL SOCIETY OF MEDICINE (History of Medicine Section), at 5.—Dr. T. Wilson Parry: The Prehistoric Trephined Skulls of Great Britain, with Description of Operations Performed.—Dr. F. G. Chandler: The History of the Diagnosis and Treatment of Empyema.

GEOLOGICAL SOCIETY OF LONDON, at 5.30.—J. A. Douglas: Geological Sections through the Andes of Peru and Bolivia; III. From Callao to the River Perene.—Prof. O. T. Jones: The Valentin Series.

ROYAL SOCIETY OF ARTS, at 8.—Sir James Cantlie: (1) Thomson's Apparatus for Armless Men. (2) X-ray Motor Ambulance Service for the United Kingdom.

ROYAL MICROSCOPICAL SOCIETY, at 8.—Rev. J. S. Pratt: Mr. Fred. Enoch's Method of Mounting Heads of Insects without Pressure.—F. Martin Duncan: The Presence of Two Spermathecae in the Rare Mole Flea (*Hystriochrysa talpae*), and the Flea as a Distributor of a Tyroglyphid.—H. Crowther: A Coal-dust Explosion as Seen through the Microscope.—Capt. F. Oppenheimer: Some Suggestions regarding the Mechanical Design of Microscopes.

THURSDAY, APRIL 21.

ROYAL INSTITUTION OF GREAT BRITAIN, at 3.—Prof. H. S. Foxwell: Nationalisation and Bureaucracy.

ROYAL SOCIETY, at 4.30.—*Probable Papers*.—Prof. J. Joly: A Quantum Theory of Colour Vision.—Prof. A. V. Hill: The Energy involved in the Electric Change in Muscle and Nerve.—H. M. Kyle: The Asymmetry, Metamorphosis, and Origin of Flat Fishes.—T. L. Prankerd: Studies in the Cytology of the Statolith Apparatus in Plants, viewed in Relation to their Habit and Biological Requirements.

ROYAL SOCIETY OF MEDICINE (Dermatology Section), at 5.

LINNEAN SOCIETY, at 5.—Prof. K. Newstead: Some Observations on the Natural History of the Upper Shiri River, Nyasaland.

LONDON MATHEMATICAL SOCIETY (at Royal Astronomical Society), at 5.

INSTITUTION OF MINING AND METALLURGY (Annual General Meeting) (at Geological Society), at 5.30.—F. W. Harbord: Presidential Address.

CHILD-STUDY SOCIETY (at Royal Sanitary Institute), at 6.—Dr. J. E. Borland: The Musical Training of Children.

THE CHEMICAL SOCIETY, at 8.—F. Challenger and C. F. Allpress: Organo-derivatives of Bismuth. Part iv.: The Interaction of the Halogen Derivatives of Tertiary Aromatic Bismuthines with Organo-derivatives of Magnesium and Mercury.—J. A. N. Friend: A Colloid Theory of the Corrosion and Passivity of Iron and of the Oxidation of Ferrous Salts.—G. T. Morgan and J. D. Smith: Researches on Co-ordination and Residual Affinity. Part iv.: The Constitution of Simple and Complex Cobaltic Quinoneoxime Lakes.—G. T. Morgan and H. Burgess: Non-aromatic Diazonium Salts. Part vi.: 3:5-Dimethylisooxazole-4-diazonium Salts and their Azo-derivatives.—E. de B. Barnett and J. W. Cook: Studies in the Anthracene Series. Part i.—J. B. Firth: Some Factors governing the Sorptive Capacity of Charcoal. Sorption of Ammonia by Coconut Charcoal.—N. V. Sidgwick and E. K. Ewbank: The Influence of Position on the Solubilities of the Substituted Benzoic Acids.—N. V. Sidgwick and W. M. Aldous: Influence of Position on the Solubility and Volatility of the Mono- and Di-nitrophenols.—N. V. Sidgwick and H. E. Rubie: The Solubility and Volatility of the Chloro- and Nitro-anilines and their Acetyl Derivatives.—G. A. R. Kon: The Formation and Stability of *spiro*-Compounds. Part iv.: The Formation of Ketones derived from Open-chain and Cyclic Glutaric Acids by the Thermal Decomposition of their Calcium Salts.—W. J. Jenkins: Interaction of Acetylene and Mercuric Chloride. Part ii.—J. Read and H. G. Smith: Researches on Piperitone. Part i.: The Occurrence, Isolation, and Characterisation of Piperitone.

INSTITUTE OF METALS (at Sir John Cass Technical Institute), at 8.—Dr. W. R. Ormandy: Refractories.

RÖNTGEN SOCIETY (at University College), at 8.15.—Prof. A. M. Tyndall and E. G. Hill: A New Form of Stereo-fluoroscope.—Descriptions and Demonstrations of New X-ray, Electrical, and Photographic Apparatus.

FRIDAY, APRIL 22.

ASSOCIATION OF ECONOMIC BIOLOGISTS (in Botanical Lecture Theatre, Imperial College of Science), at 2.30.—W. A. Millard: Green Plant Matter as a "Decoy" for Actinomyces Scabies in the Soil.—E. H. Richards: The Action of Bacteria and Protozoa in Conserving the Nitrogen in Sewage.—G. P. Wiltshire: The Methods of Infection of the Apple Canker Fungus.

ROYAL SOCIETY OF ARTS (Indian Section), at 4.30.—Lt.-Col. Sir Edward W. M. Grigg: The Common Service of the British and Indian Peoples to the World (Sir George Birdwood Memorial Lecture).

ROYAL SOCIETY OF MEDICINE (Study of Disease in Children Section), at 5.

ROYAL COLLEGE OF SURGEONS OF ENGLAND, at 5.—Prof. A. Keith: Demonstration on the Contents of the Museum.

PHYSICAL SOCIETY OF LONDON (at Imperial College of Science), at 5.—W. N. Bond: The Effect of Viscosity on the Flow through an Orifice.—Dr. A. Griffiths and Constance H. Griffiths: The Viscosity of Water at Low Rates of Shear.—G. F. Partridge and B. S. Smith: A Method of Measuring Frequencies.

INSTITUTION OF MECHANICAL ENGINEERS, at 6.—Sir Richard T. Glazebrook: Limit Gauging.

ROYAL SOCIETY OF MEDICINE (Epidemiology and State Medicine Section), at 8.30.—Dr. W. M. Willoughby: Collated Experiences of Plague on Ships.

ROYAL INSTITUTION OF GREAT BRITAIN, at 9.—Sir James Walker: Electro-synthesis in Organic Chemistry.

SATURDAY, APRIL 23.

ROYAL INSTITUTION OF GREAT BRITAIN, at 3.—H. Y. Oldham: The Great Epoch of Exploration; (1) Portugal.

CONTENTS

	PAGE
The Coal Position	193
The Conquest of Venereal Disease	195
Plant Evolution. By Prof. A. C. Seward, F.R.S.	197
A Modern Inorganic Chemistry. By A. J. A.	198
Our Bookshelf	199
Letters to the Editor:—	
"Space" or "Aether"?—Prof. A. S. Eddington, F.R.S.	201
"Absolute" Temperatures in Meteorological Publications.—Sir Napier Shaw, F.R.S.	201
Isotopes: Their Number and Classification. (<i>With Diagram</i>)—Prof. William D. Harkins.	202
Light and Electrons—Prof. J. Joly, F.R.S.	203
Molecular Structure and Energy.—Prof. A. O. Rankine	203
The Normal Orbit of the Electron in the Atom of Mercury.—A. Terenin	203
Doublets in Spectral Series.—D. Rogestvensky	203
The Resonance Theory of Hearing.—Dr. H. Hart-ridge	204
Sexual Organs of Phytophthora.—Prof. Geo. H. Pethybridge	204
Stellar Magnitudes and their Determination, III.—Absolute Magnitudes. (<i>With Diagram</i>). By H. Spencer Jones	205
Dynamics of Golf Balls. By C. G. K.	207
Nature in a Himalayan Valley. (<i>Illustrated</i>). By Lt.-Col. J. H. Tuill Walsh	210
The Annular Eclipse of April 8. (<i>Illustrated</i>). By Dr. A. C. D. Crommelin; Sir Francis Darwin, F.R.S.; Eleonora Armitage; E. Leonard Gill	211
Obituary:—Prof. S. W. Burnham. By A. C. D. C.	212
Notes	213
Our Astronomical Column:—Discovery of Pons-Winnecke's Comet	217
Reid's Comet	217
Double Stars	217
The Internal Physics of Metals	218
Mongolian Imbecility	218
The Alaskan Salmon. By J. J.	219
Recent Applications of Interference Methods	220
University and Educational Intelligence	220
Calendar of Scientific Pioneers	221
Societies and Academies	222
Books Received	223
Diary of Societies	223

(INDEX.)



THURSDAY, APRIL 21, 1921.

Editorial and Publishing Offices:

MACMILLAN & CO., LTD.,

ST. MARTIN'S STREET, LONDON, W.C.2.

Advertisements and business letters should be
addressed to the Publishers.

Editorial communications to the Editor.

Telegraphic Address: PHUSIS, LONDON.

Telephone Number: GERRARD 8830.

University Grants in the Civil Service Estimates.

IN view of the recent economy campaign, the debate on the Education Estimates for the present financial year, on April 12, was awaited with interest, but apparently the economists did not get the same support in the House of Commons as was given in certain quarters outside. The Estimates were passed without alteration, and the vote for grants in aid of Universities and institutions of University rank was agreed to without discussion. This means that there is an addition of half a million to the annual University grant, together with a special non-recurrent grant of 500,000*l.* for superannuation purposes.

Under the heads of education, science, and art (Civil Service Estimates, Class IV.) the total estimate for the United Kingdom for the year 1921-22 is 67,038,295*l.*, of which sum 1,500,000*l.* is allocated to Universities and institutions of University rank. That is to say, these higher institutions will receive about one-forty-fourth of the total estimate. On the face of it this seems far too small a proportion, and a closer examination confirms the view. The fact is that the Government has been slow to recognise the necessity of greater financial assistance for the Universities, and perhaps the Universities have not been importunate enough on their part.

While this additional annual grant will be welcomed, it is scarcely necessary to say that it is insufficient to meet the present needs. University teachers are notoriously underpaid, so much so

that grave doubts are felt as to the supply of adequately qualified teaching power in the future. Even if the new grant were solely devoted to increases in salaries it would be insufficient. For example, with the same allocation as last year, in the case of one of these institutions it would mean no more than an average all-round increase of about 20 per cent. With University salaries at their present level such an increase would most assuredly not meet the exigencies of the moment. But the salary problem is not the only one with which the University is faced. Other pressing financial needs will have to be met, and, while the new grant will tend to ease the strain, one cannot but feel that it is hopelessly inadequate.

It is illuminating to compare this state of affairs with the provision made by the Government for the Civil Services. On p. 7 of the Estimates will be found a statement regarding the rate of bonus applicable to salaries and wages. This rate ranges from 130 per cent. of the pre-war remuneration in the case of small incomes to 45 per cent. in the case of the larger incomes, the maximum bonus payable being limited to 750*l.* per annum (500*l.* in certain cases). Thus, to take one example, the estimated bonus for the Administrative Staff of the Board of Education for the year 1921-22 is 209,915*l.*, which works out as an average all-round increase of about 67 per cent. upon pre-war salaries and wages. Similarly the bonus proposed under the heads of administration and inspection for the United Kingdom is not far short of half a million, with almost the same percentage increase. This is the sort of provision the Government makes for its own Services. Having in mind the index figure for the cost of living, we are not prepared to say that this provision as a whole is excessive. Our contention is that in the present financial strain it is the duty of the Government to give special assistance to the Universities, and at least to treat them as liberally as its own Services.

If it is argued that the Government has increased its subsidies it must be remembered that the field over which the grants have been distributed has been gradually extending. An inspection of the Estimates on p. 54 shows that four London medical schools are receiving for the year 1921-22 in the aggregate 26,030*l.* over and above what they received in the previous year. If we interpret a footnote correctly, this slice out of the grant is to make provision for clinical units. No doubt this is a necessary object, but it is seriously to be questioned whether it was one of the purposes

contemplated when the grant was originally made. One would think that such provision should be made by special Parliamentary vote. Further, on the same page, it will be seen that the sum of 80,000*l.* is allocated to five institutions which did not receive a penny from this source in the year 1920-21. Two of them—Oxford and Cambridge—are each to receive 30,000*l.* Now we do not for a moment begrudge them these grants. But, by extending the field of the distribution, a large sum, in the cases just mentioned 106,030*l.*, has been diverted from institutions which otherwise would have benefited from it, and this fact ought not to be overlooked.

It cannot be too strongly urged that Universities and institutions of University rank are in an anomalous position in that they are compelled by force of circumstances to look to the Government for assistance. Their financial burdens, largely due to the crisis through which the country is passing, cannot be met from their normal sources of income. Benefactions are problematic. To raise the fees to meet the additional and necessary costs would be to make them so high as to prevent a large number of deserving students from entering the University, with ultimate loss to the community and nation. Already the fees charged are considerably larger than those which prevail in the United States of America. It is facts such as these which make the problem of University finance so difficult and the necessity of further Government assistance so imperative.

If our legislators have any doubt about this necessity, let them examine the figures on p. 54 of the Estimates, and note the relative disparity between the grants for England and Scotland. Six Scottish institutions are to receive 180,000*l.*, whereas forty-two English institutions will get only 591,180*l.*! A footnote makes it clear that the Scottish estimate includes 72,000*l.* awarded by Scottish Acts of Parliament in 1889 and 1892 respectively. The right of Scotland to so large a sum is not questioned, since, no doubt, when these Acts were passed the Scots were willing to forgo other privileges in order to make better provision for their own higher education. Our point, however, is this: whatever may be the genesis of the grant or grants, the total sum is relatively much larger than that assigned to England. If such a sum is necessary for Scotland—and we do not doubt it is—surely the Government should see that a proportionate sum should be given to England.

One other point. The Estimates provide for a sum of 500,000*l.* for superannuation purposes. This is intended to be a special non-recurrent grant in aid of certain Universities, colleges, medical schools, etc., to assist them to provide retrospective benefits for senior members of the staffs under the Federated Superannuation System of the Universities. In a previous issue we have already criticised the proposal and expressed the opinion that this sum will fall far short of the amount necessary for the purposes indicated. Unless a grave injustice is done to the senior members of the staffs, the grant will have greatly to be increased, or an opportunity given them to come under the School Teachers (Superannuation) Act. It is certain that a very large number of University teachers would gladly avail themselves of the latter alternative.

Colloidal Theory.

An Introduction to Theoretical and Applied Colloid Chemistry: "The World of Neglected Dimensions." By Dr. Wolfgang Ostwald. Authorised translation from the German by Prof. Martin H. Fischer. Pp. xv+232. (New York: John Wiley and Sons, Inc.; London: Chapman and Hall, Ltd., 1917.) 11*s.* 6*d.* net.

The Chemistry of Colloids. Part 1, *Kolloid-chemie.* By Prof. Richard Zsigmondy. Translated by Prof. Ellwood B. Spear. Part 2, *Industrial Colloidal Chemistry.* By Prof. Ellwood B. Spear. Pp. vii+288. (New York: John Wiley and Sons, Inc.; London: Chapman and Hall, Ltd., 1917.) 13*s.* 6*d.* net.

AFTER reading the books the titles of which stand at the head of this article, one is inclined to ask whether the word "colloid" as it has come to be used does refer to a definable state of matter, or whether it is not, in fact, used as a convenient label for a heterogeneous group of states which have only this in common, that they are not easily assimilated to the ordinary doctrines of molecular physics.

It is agreed that the word refers to systems in which one state of matter is dispersed through another, but it is claimed that there are no natural boundaries between such systems and coarse settling suspensions on one hand, and true molecular solutions on the other.

Having convinced themselves that there are no natural limits, both Dr. Ostwald and Prof. Zsigmondy select arbitrarily certain sizes of particles or degrees of dispersion and define mixtures which lie between as colloidal. This

is a mere confession of weakness, and every step of the argument on which it is based seems open to challenge. It is pure topography, and as such of little value. The colloidal state does, in fact, touch solution on one hand, and suspensions on the other, but it is not a matter simply, or even primarily, of scale. The distinctive quality of the state consists in certain constraints which may fairly be called frictional constraints, from which comes the characteristic inertia of colloidal systems noticed by Graham. An ideal suspension in which the relation between particles and fluid medium was one of simple repulsion would be free from such constraints. Its sole characteristic would be a uniform distribution of the particles—this follows from considerations of entropy—so that, if appropriate external restraints operated, the system would manifest an osmotic pressure.

An ideal suspension of this kind is the ideal gas of colloids, and the distinction between it and the simplest colloidal solution lies in the fact that the particles react with the fluid, the energy associated with the reaction being of the type known as surface energy, but modified by the excessive curvature of the surfaces. Each particle acts as a strain centre, the molecules about it being orientated more or less with respect to its centre, and the total effect is an increase in the rigidity and a decrease in the mobility of the fluid—a decrease that is in the number of molecules which cross unit area of a plane surface in the interior in unit time. Any constraint which the particles exert on the molecules of the fluid will therefore tend to increase their own diffusive energy, and the osmotic pressure would be greater than that of an ideal suspension, just as when true solution is exothermic the osmotic pressure is greater than that given by the gas equation.

The energy peculiar to such systems may be classified as capillary and electrical, namely, a contact potential difference between the particles and the medium. We are ignorant of the quantitative relations between the two, but stability is least when the contact potential difference vanishes—that is to say, at the isoelectric point. This feature is almost always and quite wrongly described by saying that coagulation occurs at the isoelectric point. Coagulation, of course, occurs over a range which is determined by the magnitude of the forces operating to produce agglutination and precipitation.

It is obvious that two particles which come within range of each other will or will not agglutinate according as the variation of surface energy with the distance between their centres is positive or negative. If it be negative

there will be a buffer action similar to that which may often be observed between drops of one fluid floating on the surface of another. A finite amount of work must be done to bring about agglutination, and this is an instance of one of the frictional constraints characteristic of colloids. Third components are practically always present in minute amount in actual sols condensed on to the particles. They decrease the chances of agglutination because they decrease the energy of the interface between particle and fluid, and, therefore, help to make the variation of the energy with the distance between centres negative.

We may note in passing that the diffusive energy is concerned only with the distribution of the particles. The size of the particles—that is to say, whether they do or do not agglutinate or completely fuse on “contact”—is determined by the variation of energy mentioned above. A striking example is offered by the system ether–water. If the ether phase be distributed through the water by shaking, the drops are brought into contact again by the external aggregating force gravity, and, once in contact, they immediately fuse. If, however, a trace of iodine be added, gravity brings the drops together; but they do not fuse, because of the local influences of the iodine upon the local variation of energy on “contact.”

Having got so far, it does not need much imagination to see that the reason why colloidal particles do not fuse must be essentially the same as the reason why solid faces do not weld when pressed together.

There would be little difficulty in defining the colloidal state if the relations between the components were only those mentioned above. It is at the other end of the scale where sols shade into true solutions in a perplexing way, not because of variation in the size of the particles, but because true solution exists side by side with true colloidal dispersion.

Broadly, there are two types to consider: those in which true solution involves, or seems to involve, the entire colloidal component—*e.g.* silica—and some proteins in water; and those in which the solute is a salt, one ion of which is highly insoluble, in which case the dispersed phase consists of aggregates of this ion with unionised molecules. Such systems are salts of proteins and of fatty acids in water, and the remarkable feature is that though the “colloidal” ion may grow to such a size as almost to reach the limits of microscopic vision, the electric charge it carries is the area of its surface multiplied by a constant.

To return now to the delimitation of the col-

loidal state. It should be such as to include at one extreme bacteria growing in a medium. It has been shown quantitatively that agglutination of bacteria occurs when the contact potential difference at the surface of the bacteria is destroyed. They, therefore, present a characteristic feature. At the other extreme there would be such a system as turned up accidentally during the war at a certain factory. An oil was found to form with water a stable emulsion remarkable for the size of the drops, which averaged nearly 2 millimetres in diameter. When the drops were broken up by violent shaking they slowly grew to the characteristic large size, and at constant temperatures persisted for months, forming a system defined by a distinct curvature of the interfaces fixed probably by frictional constraints. Clearly delimitation can neither be simply dimensional nor is it to be found in the chemical make-up; it must be sought and is to be found in the presence of characteristic constraints.

Both books present in a fair way the contemporary views of colloidal theory. It is to the theory that criticism is directed, not to their presentation of it. Each book has its peculiar merits. Prof. Zsigmondy, for instance, is particularly good and complete in all that refers to the ultra-microscopy of colloids.

Dr. Ostwald's book gives the substance of lectures delivered in America at the invitation of certain universities. It is a good introduction to the elements of the subject. One special feature may be noticed. The book was completed before the war, and the first preface is dated 1914. Publication was deferred for obvious reasons, and the second preface, dated 1915, was written whilst the author was actually at the front. From that agony of unrest the author sends a message of peace, as dignified as it is just, to his colleagues in what were then enemy countries. For that message of goodwill I for one thank him.

W. B. HARDY.

The Epistemological Problem.

- (1) *A Study in Realism*. By Prof. J. Laird. Pp. xii + 228. (Cambridge: At the University Press, 1920.) 14s. net.
- (2) *Studies in Contemporary Metaphysics*. By Prof. R. F. A. Hoernlé. Pp. ix + 314. (London: Kegan Paul, Trench, Trubner, and Co., Ltd., 1920.) 16s. net.

(1) "Il faut bien plus de principes que vous ne pensez pour démontrer ce dont personne ne doute," observes Malebranche in his "Entre-

NO. 2686, VOL. 107]

tiens Métaphysiques." This came to mind in reading the quotation from his adversary Arnauld which Prof. Laird has placed at the head of the introduction to his "Study in Realism." There can be no knowledge without object known, is the gist of Arnauld's remark. How undeniable! And yet Prof. Laird has to write a book and hint to us that he finds it difficult to keep his study within reasonable bounds. The realists are all alike; they disarm their adversaries by the naïveté of their definition, only to discover that there is no end to the diversity of meanings their professedly obvious affirmation may cover. "If the shade of Reid could visit these regions to-day it would greet Mr. Prichard, of Oxford; but it would be startled by Mr. Alexander, bewildered by Mr. Russell, and distressed by Mr. Holt. Indeed, one is tempted to think that any realism defined to the quick becomes nothing but the definer's private philosophy." Such is one realist's confession.

This troublesome problem of knowledge, however, is one to which searchers for truth, whatever be the scientific direction of their inquiry, cannot be indifferent. It is impossible to avoid its challenge, although it is not one of the great problems of philosophy. It is not, like the immortality of the soul, the nature of the world, and the existence of God, one of the problems which concern the whence, the why, and the whither of human existence. The epistemological problem is in effect the River Styx of the higher world of philosophy, but there is no Charon who can be bribed with a fee to ferry us to the other side.

Why is realism called a theory? It is not a theory in any proper meaning of the term. It is simply an assumption concerning the reality of things and the knowing relation, and the contention that the assumption is consistent with the facts. The assumption is that the object of knowledge is independent of the knowing, and that knowledge is discovery, the independent things or objects being directly revealed or given to the mind. This is the ordinary assumption of common sense, but neither the plain man nor the scientific researcher calls it a theory or requires a theory. It is the philosopher who wants a theory. The argument of the realist seems to be that if the assumption can be proved to be consistent with the facts of perception, memory, imagination, and such like processes, it will then become a theory. To this the reply is, "Can the Ethiopian change his skin?"

Prof. Laird is delightful to read. However difficult and abstruse the argument, it is bright with

witty remarks and humour. He covers a large ground, and every chapter is packed tight with matter. This makes his work easier to recommend to the reader than to describe or epitomise. We may select one or two points of special interest. One of the most awkward of the realist's problems is to determine the exact status of "images." This problem is discussed in a chapter entitled "The Stuff of Fancy." It begins by directing attention to a very serious defect in our vocabulary. We have one and the same word, "imagination," for images of scenes we remember or anticipate, and for fancies. We have, indeed, the two terms "imagination" and "fancy," but they are in ordinary discourse interchangeable. It is a difficulty the present writer has found in trying to present Croce's æsthetic theory in English. Our words "imagination" and "fancy" do not follow the same articulation of meaning as the Italian words "fantasia" and "immaginazione." This reference to Croce is not casual. If anyone is interested in a direct opposition between two philosophical theories of the nature of imagery, he will find it by comparing the first chapter of Croce's "Estetica" with Prof. Laird's theory concerning the "Stuff of Fancy." "Images, in a word, are parts of the physical world *imaged*, and that is what we discover through the fancy," concludes Prof. Laird. "Lo spirito non intuisce se non facendo, formando, esprimendo," says Croce.

Realism is very clear and emphatic in affirming the existence of the object, and that the knowledge of it is the mind's discovery; but there is another kind of existence—namely, that of the mind itself. Does the mind discover this existent? Prof. Laird finds no difficulty in answering "Yes." The argument is given in the chapter entitled "The Mind." In neurological theory he follows Sherrington. In philosophical theory his main contention is that in introspection we inspect awareness, but the act of inspection is different from the act of which it is aware. Our minds, he adds, are rich enough to contain a multitude of awarenesses almost at the same moment.

(2) The same problems are discussed in "Studies in Contemporary Metaphysics," and there is the touch of nature making realist and idealist kin in the underlying motive of Prof. Laird's epilogue and of Prof. Hoernlé's prologue. Both philosophers feel the need of justifying the human instinct to philosophise. Both give practically the same answer, and both have the same distinctly sad refrain. "Is the pursuit of philosophy worth while?" "Those who have de-

voted themselves to it have found it so, and they alone are in a position to judge."

The idealist's difficulty, unlike the realist's, is not concerned with the first step. The idealist has no initial assumption to negotiate; his difficulty is with the journey's end. The paradox in his case is that knowledge begins with the consciousness of an absence, with a datum the characteristic mark of which is partiality and incompleteness, while it presents to the mind a task to be accomplished. Knowledge is therefore ideality from the start, and its highest attainment in integration—the concrete universal, the absolute—appears elusive, and its objectivity unconvincing.

Prof. Hoernlé criticises, at times with brilliant effectiveness, the various constructive efforts which have been and are being brought to bear on the epistemological problem. His six years at Harvard have evidently been occupied with a vigorous championship of idealism in the homeland of new realism and behaviourism. The most arresting chapter in his deeply interesting book is that entitled "Saving the Appearances." Not only does he there offer us a constructive theory of his own, but he also demonstrates the absolute bankruptcy of realism when face to face with the demands, not of the plain man, but of the scientific worker. It is the physicist and biologist who must have the secondary qualities restored to the objective world. It is the realist who has filched them, and the idealist who alone, in Prof. Hoernlé's view, can restore them.

In these two books we have the controversy between contemporary realism and idealism represented by sturdy champions, though at present neither can claim to be bestriding a prostrate foe.

H. WILDON CARR.

Vertebrate Morphology.

Vertebrate Zoölogy. By Prof. H. H. Newman. Pp. xiii+432. (New York: The Macmillan Co.; London: Macmillan and Co., Ltd., 1920.) 16s. net.

THE leading feature of this book is an attempt to interpret the structure of vertebrate animals in terms of the "axial gradient theory." This theory, enunciated by the author's colleague, Prof. Child, is based upon certain facts of vertebrate development. These show that along the three axes of the body—longitudinal, vertical, and transverse—the rate of differentiation is not uniform, but progresses more rapidly in one direction than in the reverse. Thus the head develops faster and farther than the tail; the

dorsal organs (such as the nervous system) than the ventral; and the tissues adjacent to the middle line than the outer tissues. The flow of matter and energy along these axes is apparently faster in certain directions, or the developmental impulses are transmitted more rapidly in these directions, than in others.

In order to test this view, the author has performed a number of experiments. He has placed the developing eggs of certain fish in water to which were added substances, such as alcohol and cyanides, that lessened the rate of natural development, and he placed others under adverse conditions, such as intense cold or diminished oxygen pressure. The results of these experiments, made by Prof. Newman, show that those embryos which survived exhibited most retardation in those regions where normal specimens normally reared undergo their most rapid development. On continuing these experiments, however, he found that a certain number of the experimental animals recovered from this inhibitory effect, and that this recovery is most marked in the very regions which had previously been most depressed. For example, the development of the head was at first retarded, but if the fish survived this first period of life under experimental conditions, then the development of its head was accelerated, and, indeed, to such a degree as to render it incapable of continued existence. These non-viable embryos exhibited the strangest appearance. Some "consisted of nothing but isolated eyes"; others "merely of heads with large rolling eyes and a tiny indifferentiated appendage that stands for the rest of the body"; others, again, "became broad and flat, like a skate, or high and compressed, like a sunfish. In fact, a good assortment of experimental monsters will furnish parallels to most of the stock types of form-distortion seen in the specialised and degenerate groups of fishes" (p. 161). We can only regret that the author has not reproduced figures and descriptions of these interesting monsters, or given references to the literature.

These results lead the author to seek for a cause which has acted upon growth and development during the course of animal history somewhat in the way that the depressing agency of his experiments has led to modification of form. The problem is to explain the elongated newt and the truncated frog; in other words, the tendency of animal groups to cephalisation, to abbreviation of the abdominal and caudal regions in the more highly organised members of most classes. Here he has nothing to offer us. He speaks, as so many American writers on biology do, of "the

ageing of the hereditary chromatin" as an internal factor that has operated in preserving, for example, the neoteric or perennially youthful type of body, or in other ways. He attempts to correlate the elongated form of body with the effect of low temperatures acting as a depressing agent. We are put off with phrases such as "lowered rates of chemical metabolism" and "racial senescence," expressions which really have no scientific content. The moral of all this is that we do not know enough evolutionary physiology to enforce conclusions drawn from our anatomical and developmental records of animal structure by conclusions based on corresponding records of their past and present living processes. The anatomical evidence alone leads to such melancholy exhibitions of inconclusive reasoning as are found in the discussions on animal phylogeny in this book; and if the author has not been successful in applying physiological tests to animal pedigrees, we can but applaud his courage in making the attempt.

F. W. G.

Ancient Metal Implements.

Tools and Weapons: Illustrated by the Egyptian Collection in University College, London, and 2000 Outlines from Other Sources. By Prof. W. M. Flinders Petrie. (British School of Archaeology in Egypt and Egyptian Research Account, Twenty-second Year, 1916.) Pp. vii+71+1xxix plates. (London: British School of Archaeology in Egypt; Constable and Co., Ltd.; Bernard Quaritch, 1917.) 35s. net.

ONE of the ever-present problems of archaeology is the degree of interdependence in which the ancient civilisations stood to one another in the matter of customs, religion, and the material objects of everyday life. Where undoubted importations occur the question becomes simple, but in the early ages of man's civilisation these imports are more often lacking, and the sole evidence available comes from a typological comparison of various classes of objects. In the volume under review Prof. Flinders Petrie has devoted himself to a study of Egyptian implements other than most of the stone types, and by the aid of numerous figures of similar implements from other countries, chiefly in Europe and Western Asia, he has sought to demonstrate the part played by Egypt in the invention and development of the various tools and weapons known to the ancient world.

If one fact emerges more clearly than another from this study, it is the extraordinarily small

measure in which Egypt exerted influence on, or was influenced by, other lands. In the subject of investigation, as in many other respects, Egypt stands apart. At the outset of her metal age it is only natural that she should have borrowed from Cyprus some of the copper forms current there; but, apart from the scalloped axe borrowed from Syria about the Fifth Dynasty, there is no other important instance of the borrowing and subsequent development of any form throughout her history. Other weapons, pins and the like, of European and Western Asiatic forms, are for the most part importations due to commerce or invasions. The non-adaptation of many of the most useful European developments of the middle and late Bronze age, particularly the socket, makes it difficult to accept a Sicilian origin for the recurved knife (K.135). Why is it bronze in Sicily and iron in Egypt, when neither Sicily nor Egypt was using iron, and why is this peculiar form found and not the equally peculiar Sicilian notched razor (X.44)? It is regrettable that no mention is made of the smith's hoard from Cyprus (Dussaud, *op. cit.*, Fig. 180), which contains many parallels to Egyptian types. The idea (p. 30) that the sword or dagger with winged flanks at the top of the blade is a scattered type is probably quite erroneous. D.163, cited as one example, is indubitably a halberd of a form peculiar to Western Europe, and thus the wings served a purpose entirely different from that of the wings of D.161 and D.162. D.162 is certainly Minoan in origin, so that this type is in reality confined to the Ægean and Greece of Minoan times.

Though restricting himself to such classes of implements as actually occur in Egypt, Prof. Petrie has much that is suggestive to say about many European forms. Particularly interesting are his remarks on the pretended Ægean copper ingots of double-axe form, and the very numerous figures of European implements over and above the Egyptian examples provide a valuable *corpus* for archæological study. The work throughout brims over with instances of Prof. Petrie's ingenuity in offering practical explanations of details of form and technique. The paragraphs and plates dealing with bronze-casting and stone-cutting are a useful adjunct to what he has already written on these subjects in his "Arts and Crafts of Ancient Egypt," though even to Prof. Petrie the material used in the latter art as applied to the harder rocks remains a mystery.

A few misprints have been noticed. On p. 20, §48C, C.25 should be C.26; on p. 46, l. 34, "durite" is of course diorite; and the references for K.130 and 137 are M.A. XXI. VI., not v.

Our Bookshelf.

Report of the Ninth Annual Conference of Educational Associations held at the University College, London, 1921. Pp. viii+470. (London: Conference Committee, 9 Brunswick Square, London, W.C.1, 1921.) 5s.

It is stated in the preface to this highly important report that the ninth annual Conference of Educational Associations was even more successful than any of its predecessors. The report includes the proceedings of thirty-seven out of the forty-six various educational associations which are affiliated to the National Conference, which extended from December 29 to January 8. The conference was presided over by Viscount Burnham, whose Committee, under his guidance, has done such admirable work in relation to the financial position of the teachers in elementary and secondary schools. The various associations meet together under the auspices of the Teachers' Guild of Great Britain and Ireland, and some of them take the occasion to hold their annual meetings, and afterwards throw their meetings open to any members attending the conference.

The proceedings of the conference began at Bedford College with an inaugural address by Prof. J. Adams, of the University of London, on "Instinct and Education." Two joint conferences were held. The first discussed "The Use of Psycho-analysis in Education," and was so largely attended that an extra joint conference was afterwards held at which the subject was further considered; while the second dealt with the important question of "How Best Can a Feeling of Professional Solidarity be Created and Maintained among Teachers?" at which Viscount Burnham presided. This was held on the last day of the conference, and was but meagrely attended. It was, unfortunately, held in the absence of any official representatives of the large body of primary teachers.

The conference was attended by 2200 members of the affiliated societies, as well as by nearly 1000 visitors. Arrangements are in course of preparation for the next conference to begin on December 28 or 29 next, when it is expected that further associations will have joined the conference.

In Farthest Burma. By Capt. F. Kingdon Ward. Pp. 311. (London: Seeley, Service, and Co., Ltd., 1921.) 25s. net.

CAPT. KINGDON WARD left Myitkyina, the rail-head in Upper Burma, in April, 1914, on a journey to the little-known frontier lands around the head streams of the Irrawaddi, with the object of continuing the botanical researches which had previously taken him to Yunnan and the Burmese frontier. His course was by the Nmaiha valley, with a deviation *via* the Ngawchanghka valley and an ascent of Imaw Bum, to the frontier post at Kawnglu. Thence he passed by Langtao to Fort

Hertz, the outlying British station founded in 1914 in response to Chinese designs on this remote part of Burma. Capt. Ward has much to say about the isolated plain of Hkamti Long, where Fort Hertz lies, and the curious dwindling remnant of the Shans who inhabit this fertile plain hemmed in by the Kachins. The narrative, without being thrilling, has a sustained interest throughout, for the author not only shows considerable descriptive power, but he also avoids boring his readers with the details of camp and trail which loom so large in many travel volumes. What Capt. Ward has to say about the routes on the frontier in relation to Chinese policy deserves careful attention, for he writes with knowledge and authority on this remote and neglected corner of the Empire. The illustrations are excellent, but the two maps are disappointing.

Six Papers by Lord Lister, with a Short Biography and Explanatory Notes. By Sir Rickman J. Godlee. (Medical Classics Series.) Pp. vii+194+iv plates. (London: John Bale, Sons, and Danielsson, Ltd., 1921.) 10s. net.

DR. CHARLES SINGER, general editor of "The Classics of Medicine" series, has made a good beginning. We are to have, in due time, Ambroise Paré, Laennec, Auenbrugger, Hippocrates, Galen. Meanwhile, we have Sir Rickman Godlee's admirable selection of six of Lister's papers, with a short introductory memoir—too short, indeed, for those of us who are not familiar with Godlee's Life of Lister. Plainly, the difficulty was to decide, in all the wealth of Lister's published writings, what to leave out. It may be that the interest of the paper on anæsthetics (1861) is impaired by the progress of sixty years. But the other five papers, which cover the long period from 1857 to 1890, are of everlasting value. They give us, in Lister's own words, the course and the development of Lister's own work. For the present generation of young physicians and surgeons, they are a sure guide to the principles on which antiseptic and aseptic surgery was founded and built.

But this book is something more than a handful of reprints, for the explanatory notes to each paper are as good as good can be, and the introductory memoir is delightfully written. In short measure, it is perfect. To all of us who knew Lister it recalls with singular vividness the look of his face, the sound of his voice, the temper of his life and work—a man pure in heart, gentle, patient, laborious, self-critical, thankful to be of service to mankind.

A New British Flora: British Wild Flowers in their Natural Haunts. Described by A. R. Horwood. (In six vols.) Vol. i., pp. ix+244; vol. ii., pp. xi+243+xvii plates. (London: The Gresham Publishing Co., Ltd., 1919.) 12s. 6d. net per vol.

THE first two volumes of this work have appeared. It is evidently intended for the naturalist rather

than for the botanist as such, although it aims at dealing with British plants from the ecological point of view. The first volume, which is introductory, includes an account of the origin of the British flora and of the floral regions of the world; geological and altitudinal maps of the British Isles, and chapters on insect pollination, seed dispersal, and similar topics. The second volume deals with plants of the fields and meadows, corn-fields, and the sea-coast. The work is illustrated by many coloured plates from drawings by Fitch, and by a large number of photographs of the plants in the field, many of which are excellent. The drawing (vol. i., p. 147) which is supposed to illustrate heterostyly in *Primula* does not really illustrate anything. Popular names, folk-lore, and points of natural history interest are included with regard to each plant. As a semi-popular work this should serve a useful purpose in directing the attention of naturalists to the ecological point of view with regard to plants.

The Nature of Enzyme Action. By Prof. W. M. Bayliss. Fourth edition. (Monographs on Biochemistry.) Pp. viii+190. (London: Longmans, Green, and Co., 1919.) 7s. 6d. net.

THE appearance of a fourth edition of this admirable monograph testifies to the fact that the work has earned the suffrage of research workers and students alike. The author has been at pains to keep the successive editions abreast of the rapidly growing knowledge of the subject. The present issue differs from its predecessor chiefly in the fact that the chapter on the mode of action of enzymes has been rewritten.

To those unacquainted with the earlier editions it may be said that the object of the book is not merely to give an account of enzymes, but also to define the relation of these "biocatalysts" to catalysts in general.

The Practical Electrician's Pocket Book for 1921.

Edited by H. T. Crewe. Twenty-third annual issue. Pp. lxxii+522. (London: S. Rentell and Co., Ltd., n.d.) 3s. net.

THIS pocket-book will prove useful to all engaged in industries in which electricity is employed. It contains the rules and regulations for electrical installations, the standard wire tables, useful hints about electrical machines and apparatus, and *résumés* of the theory of steam and gas engines, photometry and pyrometry. The information given is trustworthy.

A Book of Gardening for the Sub-Tropics. By Mary Stout and Madeline Agar. Pp. 200. (London: H. F. and G. Witherby, 1921.) 6s. net.

THIS little book is designed for those who, living abroad, wish to know something about gardening under sub-tropical conditions. It applies particularly to the Cairo district, and includes such topics as propagation, pests, roses, and chrysanthemums, and a calendar for the flower-garden.

Letters to the Editor.

[The Editor does not hold himself responsible for opinions expressed by his correspondents. Neither can he undertake to return, or to correspond with the writers of, rejected manuscripts intended for this or any other part of NATURE. No notice is taken of anonymous communications.]

The Quantum Theory and Homogeneous Vibrations.

IN the quantum theory as usually presented a finite amount of energy is associated with a periodic disturbance which is called "homogeneous." I desire to raise the question whether the use of that term is defensible. Both in optics and in acoustics the word "homogeneity" has acquired a definite meaning which is inconsistent with its application to quanta. In fact, the affirmation of quanta involves a denial of homogeneity. To avoid misunderstandings and obscurities we must either abandon the hitherto recognised definition of that word as applied to oscillations, or avoid its use in the formulation of the quantum theory. I submit that the second alternative is preferable.

A homogeneous vibration as hitherto understood is unlimited in time, just as a homogeneous wave is unlimited in space; a disturbance having velocities proportional to $\cos nt$ is homogeneous only if it applies to all values of t , however great, on the positive and negative sides. As soon as limits are imposed the oscillation ceases to be homogeneous. The radiation of a quantum, if expressed by a circular function, being necessarily limited in time, it follows that homogeneity is impossible. If the velocity of the oscillator be represented by $e^{-kt} \cos nt$, the exponential factor admits quanta because it allows us to assign a finite value to the total energy, but it destroys at the same time the homogeneity. When analysed practically by the spectroscope or theoretically by Fourier's theorem, all frequencies are represented, though when k is small nearly the entire energy is concentrated in a narrow region closely adjoining that of the maximum intensity which takes place at frequency $\sqrt{n^2 - k^2}$. We must conclude that the radiation associated with a quantum is not homogeneous, though its effective energy is confined to a narrow region of frequencies. If an expression be required to represent the nearly homogeneous radiation of a quantum, we shall perhaps commit ourselves least to any definite views by calling it simply a "quantum radiation."

ARTHUR SCHUSTER.

Yeldall, Twyford, Berks, April 10.

Variation in a Fern.

IN the Croonian lecture (Proc. Roy. Soc., B, vol. xci., p. 368) I said that the prothallia of a variegated *Adiantum* were entirely green, though the ferns which arise from them may be green, or variegated, or white. This statement should be corrected, for I find that though the prothallia look all green when growing on the soil, some of them have lighter, occasionally almost white, patches, which are seen as soon as the prothallia are examined by transmitted light. These patches of cells are sharply defined, usually forming radiating bands widening peripherally. In some cases the light tissue is an island of cells entirely surrounded by the green cells. The plastids in the light cells are at least as numerous as those of the green cells, but they are smaller and pale in colour, being mostly a faint green, though

sometimes almost colourless. The development of this kind of variegation will need careful study. It is difficult to avoid the inference that genetic segregation does here occur in haploid tissue, but the process is not necessarily postponed, as I suggested, to the formation of the germ-cells.

W. BATESON.

The John Innes Horticultural Institution,
April 14.

The "Flight" of Flying-fish.

I HAVE recently received the following information on the "flight" of flying-fish from Prof. Wood-Jones, the well-known anatomist and naturalist. His conclusions based on his own observations must carry weight, and, in my opinion, should finally settle the points in dispute.

DAVID WILSON-BARKER.

Many years ago I watched flying-fish daily for hours on end, and I think that observations made, as were mine at that time, from the long overhang of the bow-sheaves of a cable ship are far better than those made by casual observers from the decks of a passenger vessel; for, in the first place, the observation is made many yards ahead of the cut water, and the fish can be observed swimming just below the water and then breaking its surface and taking "flight"; and, in the second, observations can be taken when the ship is steaming no more than $1\frac{1}{2}$ knots. As a result of my spell in cable ships in the Indian Ocean I had no doubt as to the manner of "flight" of flying-fish, and, though directly antagonistic ideas seem prevalent to-day, I still, after a further series of observations, have no doubt that flying-fish gather all their impulse by the lateral movements of their tail as they leave the water and then sustain themselves in the air by what would now be termed "planing."

In order to check my previous conclusions, I made observations and notes on this matter during a journey to Australia last year, and also during a trip to Honolulu and back. On both these occasions I took care to interest any children in the question, for children are commonly good judges in such things. On both occasions I secured a specimen which came aboard, and the accompanying rough figures are made from the dissection of one of these.

These observations may be summarised as follows:

(1) Flying-fish when disturbed by an oncoming vessel dart about beneath the surface with the greatest rapidity. Some members of a shoal seek safety by their speed below water with their *pectoral fins tight adpressed to their sides*; some with a rush break the surface of the water, *spread their pectoral fins, and plane away*.

(2) The impulse is gathered by the final very rapid lateral movements of the tail as the fish leaves the water.

(3) When the fish springs into the air it quivers all over. This quivering is seen in the spread pectoral fins, but this is not a very rapid wing-stroke—as seen, say, in a drone-fly; it is merely the vibration due to the great rush with which the creature cleaves the water.

(4) Once launched in the air the pectoral fins are spread out as planes and remain motionless.

(5) Fresh impetus can be gained from time to time by the tail dropping to the water and powerful lateral movements being produced with the enlarged lower fluke of the caudal fin.

(6) Change of direction can be produced (just as it can in a planing bird) by lateral tilt of the body.

(7) Rise and fall are certainly possible (due to forcing up of air by waves), but I have been unable to observe any cant of the planes which produces this.

(8) The fish can easily outstrip a vessel doing 17 knots.

(9) The majority of fish turn into the wind when launching themselves. On December 12, 1919, simultaneous observations were made by two observers for periods of $1\frac{1}{2}$ minutes upon the windward and leeward sides of the ship. Twice as many fish "flew" to windward as to leeward. In some counts the results were as high as eight to windward without a single fish going to leeward.

(10) They can remain in the air for at least half a minute (I fancy I have seen much longer flights when in the cable ships). On December 18, 1919, the following flights were timed:—10 seconds (three times), 15 seconds (four times), 25 seconds, with tail

muscle being downwards and forwards, and not downwards and backwards.

(15) The structure of these muscles is altogether unlike that familiar in muscles performing the short, quick strokes of flight, but is entirely what would be expected of muscles acting tonically as spreaders of planes.

F. WOOD-JONES.

University of Adelaide.

"Space" or "Æther"?

PROF. EDDINGTON (NATURE, April 14, p. 201) challenges those of us who have asserted that "relativity does away with the æther" to defend our statement. He himself provides our defence. He tells us that *his* æther—the æther that relativity does *not* do away with—"has not . . . density, elasticity, or even velocity." But *our* æther—the æther of pre-relativity days, which relativity *has* done away with—has all those properties. In particular, it has the last. The nineteenth-century æther simply was a system relative to which light had the normal and invariable velocity c ; so that the velocity of light relative to a system which had, relative to the æther, the velocity v was $c+v$. That statement conveys the very meaning and essence of the old æther; deny it, and the Fizeau and Michelson-Morley experiments lose all significance.

Prof. Eddington's word "æther" has neither the denotations nor the connotations of the old word. His use of it will receive the support of Humpty-Dumpty, but not of those who consider that accuracy of thought is intimately dependent upon the constancy of the meaning of the words used to express it.

NORMAN R. CAMPBELL.

I AM indebted to Prof. Eddington (NATURE, April 14, p. 201) for pointing so decisively to the full issues of my argument (NATURE, April 7, p. 171). The position may be clinched thus:—The relativists may take away *pure space* as an objective entity, but in so doing they are "ætherising" or materialising the space of the physical universe. So the physicists get back their "æther" with something more; and "space," a fundamental fact of human experience which has been such a metaphysical enigma right down the ages, at least becomes intelligible as the substratum of matter. The identification of

æther and space provides a mechanism of the universe, and will enable us to picture physically what is meant by such phrases as "world-lines" and "twists in space."

Prof. Eddington's reason why the quality of beauty is not included in physical science and my own are metaphysically identical, and the two propositions, very differently framed, confirm one another.

April 16.

L. C. W. BONACINA.

Meteors on the Moon.

THE reported failure of Prof. Goddard to obtain pecuniary support for his project to discharge a giant rocket at the moon leads me to ask a question which astronomers may answer. Why is it that no observer has ever reported the descent of a meteor upon the surface of our satellite? It seems reasonable to suppose that meteoric falls must occur there as upon the surface of the earth. According to the accepted estimate, the earth receives about 20,000,000 meteorites per diem. If that holds good, *mutatis mutandis* for

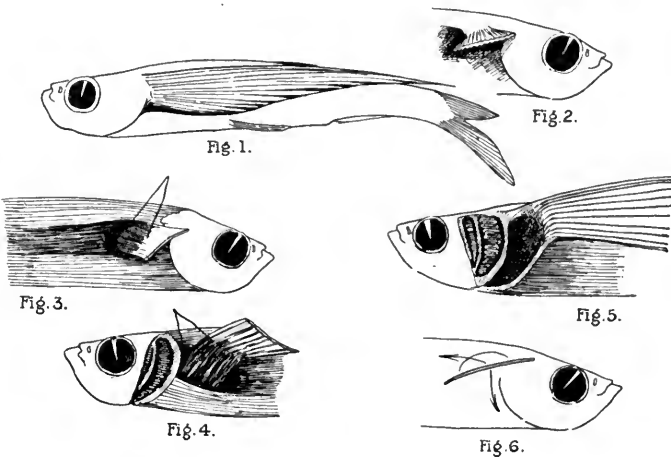

FIG. 1.—General lines upon which the fish is built.

FIG. 2.—The pectoral fin was placed in the position of flight, and the specimen then hardened in formalin. The right fin is represented cut through near its base.

FIG. 3.—Dissection of the dorsal or posterior muscle (tinted), showing the depression in the general longitudinal muscle mass of the body into which the fin fits when hauled up and back by its retractor muscle. The tinted muscles in Figs. 3 and 4 are indicated by the lines A.

FIG. 4.—Dissection of the ventral or anterior muscle (tinted). Numerous tendons pass the fin-rays from small pale muscle. Evidently the muscle hauls the rays and spreads the wing like a fan.

FIG. 5.—The ventral muscle removed to show the depression in the gill base skeleton which it occupies.

FIG. 6.—Diagram to show direction of action of the two muscle masses.

splashes (twice), 28 seconds (numerous tail splashes, once), and 30 seconds (numerous tail splashes, once).

(11) The dorsally situated mouth and the enlarged ventral fluke of the tail-fin tell clearly that the fish is one designed to make rushes *upwards* through the water in search of food.

(12) Its "flight" is only an extension of the flight of the garfish. These fish also launch themselves into the air, and without any planing, but merely by their impetus, travel for a sufficiently long and rapid "flight" to carry them—like a hurled spear—right through the sail of a boat.

(13) Only two main muscle masses are attached to the base of the pectoral fin. The posterior muscle pulls the fin upwards and backwards and folds it into the "slot" for its reception. The anterior muscle pulls the fin downwards and forwards and spreads it as a plane.

(14) These muscles do not produce "flight" movements of the fin, the stroke of the ventral (anterior)

the moon, our luminary must receive about 2,000,000 in twenty-four hours. The great majority of these would necessarily be invisible. One-half of the number would fall on her averted face. Of the remainder more would fall during sunlight than during the hours of darkness. Of those that fell during hours of darkness the greater number would be concealed by terrestrial cloud. Of those that were not so concealed one-half would fall on the illuminated part of the moon's disc, and, perhaps, be rendered invisible by the lunar brightness. It is easy to see that large abatements must therefore be made from the number of falls if we wish to estimate the probability of making a successful observation. This consideration has a bearing, by the way, on the reasonableness of expecting to be able to witness the arrival of Prof. Goddard's projected rocket if the aim were good and a hit secured; but that is by the way.

If, in consideration of all these adverse contingencies, we reduce the estimate of impacts to 1 per cent. of the above-quoted figure, we have 20,000 hits on an average moonlight night. Why has not one of them ever been observed? Among the number of meteorites must be a certain proportion weighing one or two hundredweight or more. When masses of that magnitude enter our atmosphere they grow incandescent and light up a whole countryside, it may be for some seconds. That is the result of impact upon our yielding atmosphere. If they reached the surface of the earth, as presumably they do that of the moon, with cosmic velocities ranging up to 40 miles a second, would they not break up there with an outburst of light like that of a nova among the stars? Furthermore, as these impacts must include not only single masses of considerable size, but also meteoric showers, the areas affected must presumably at times be large enough to be quite observable through a good telescope. It may be suggested that when the fall is normal, or at any large angle to the moon's surface, the projectile buries itself too deeply in the substance of the moon to be visible. But among the arrivals must be some that arrive at grazing, or something like grazing, incidence on the moon, penetrating little, or not at all, beneath its surface. Why are their glowing paths never seen and the furrows which must so have been ploughed, in the course of ages, upon the moon's ancient surface never described to us?

Probably there is an easy answer to these questions, but, even if easy, it would be interesting to those of us who are not astronomers.

J. W. GORDON.

11 King's Bench Walk, Temple, E.C.4, April 12.

THE question of meteors on the moon is not now raised for the first time. In my article on astronomy in "Science in Modern Life," vol. i., p. 35 (I give this, not as being the first mention of the subject, but because it is the most accessible source), I wrote:—"There is one puzzling question raised by Prof. Shaler, *i.e.* how is it that the fall of meteors on the moon, which must be as dense as those falling on the earth, has not covered all the markings with a veil and obliterated the differences of tint? It has, however, been calculated that even if the atmospheric density at the surface be only $1/10,000$ of that on earth (a quantity which it may well exceed), then, since the rate of decrease is so much slower than on the earth, at a height of something over 40 miles the densities of the atmospheres would be equal, and at still greater heights that of the moon would be the denser. Now most of the meteors that enter our air are completely burnt up at greater heights than this, so that the thin lunar atmosphere may actually be as effective for stopping meteors as our own."

It is comparatively rarely that meteors reach the

earth's surface, and when they do so the speed has been so diminished by friction that there is no intense flash. The above reasoning makes it quite possible that the conditions on the moon are similar. If so, an impact-flash bright enough to be seen from the earth would be extremely rare, and then it would be seen only if an observer with a powerful telescope happened to be looking at the right spot at the right moment. There are also very few meteors the flash of which in the atmosphere of the earth would be bright enough to be seen from the moon. Some furrows on the Mount Wilson lunar photographs might, however, possibly be due to meteor falls.

ANDREW C. D. CROMMELIN.

Calendar Reform.

THE simplified calendar proposed by the Rev. E. Fanfani and described in NATURE of March 17, p. 88, is apparently inspired by a sound principle, viz. to make the minimum of change in existing conditions. It is, however, very desirable, if the months are otherwise to remain unchanged, to secure that the existing inequality in the lengths of the half-years and quarters should be corrected.

The late Prof. Millosevitch, of Rome, with whom I corresponded on the subject, expressed the view that this was the greatest—indeed, in his opinion, the only great—defect of the present calendar. This object can be effected by taking a day from August and adding it to February—a change which was suggested in NATURE of February 23, 1911, although its value was not, I think, fully appreciated at the time. This change can be made without altering the date of the vernal equinox (as fixed by the Papal Bull of February 23, 1582) by adding the day taken from August to the February of the following year. This alteration has the important advantage of giving us four quarters each containing three months and (the 365th and 366th days being apart from the week) exactly thirteen weeks. A common measure for the relation of monthly and weekly values would thus be available—a matter of much importance in accounting.

As regards the exact relation to be established between month-day and week-day, if, as M. Fanfani proposes, the leap day is to be left in its present position, which is in several respects desirable, facilities should be provided for terminating a quarterly period at the end of February. This is best accomplished by beginning with a Sunday on December 1. That would be the permanent date of Advent Sunday—the true *beginning* of the ecclesiastical year. The *central* day of the ecclesiastical year would then be May 31, which might be most appropriately selected for exclusion from the weekly series.

Of the five (or for the next 279 years four) dates of Easter Sunday possible under such a calendar one would be April 12. When Easter Sunday fell on that day Pentecost would fall on May 31. If Easter Sunday were fixed for that day, May 31 would be the annual permanent Pentecost, the founders' day of the Christian Church.

If Easter Day were allowed to oscillate over the four possible Sundays, it would be ascertained by the existing Easter tables without disturbance, and still always fall during evening moonlight.

Ecclesiastically, I submit that these proposals are equally simple with, and present superior advantages to, those suggested by M. Fanfani. From the point of view of legal administration, commerce, and accounting they are effective in removing the defects in the working of our present calendar.

The above changes could be introduced without any disturbance or interruption in 1924-25.

March 19.

ALEXR. PHILIP.

The Hall of the Age of Man in the American Museum.¹

By PROF. HENRY FAIRFIELD OSBORN.

AN important event in the American Museum of Natural History is the approaching completion of the Hall of the Age of Man. This hall has been planned as a climax to the series of collections in invertebrate and vertebrate palæontology, arranged so that the student or visitor will begin with the Hall of Invertebrates, dating back to the Cambrian, and pass in geologic and palæontologic sequence through a series of five halls surrounding the south-east court, to be devoted to the Age of Fishes; the Age of Amphibians, of Permian and Triassic Reptiles; the Age of Jurassic Reptiles, including the giant Sauro-poda; to the Cretaceous Reptiles; into the Age of Mammals; and finally into the Hall of the Age of Man. This will afford effective exhibition of the collections in vertebrate palæontology which

arranged in ascending order from an introductory genealogical tree of the Primates to the races which overran Europe in Neolithic times. On the floor space surrounding these central cases are shown some of the chief types of mammals of the four continents, Africa, Eurasia, North and South America, which was also the great theatre of human evolution during late Pliocene and Pleistocene times.

Around the walls, above the cases, is a series of four large mural paintings which present the mammalian life of these continents during the final period of maximum glaciation and the close of the immediately preceding Third Glaciation period. This is the reindeer and mammoth period in Central Europe, of the late loess period of northern France, of the loess deposition of the



FIG. 1.—The most common of the many extinct rhinoceroses is the *Rhinoceros antiquitatis* or woolly rhinoceros of Europe and Siberia. This species was most like the square-mouthed or white rhinoceros of Africa nearly extinct to-day. It was protected from the wintry blasts by a heavy coat of long hair and a thick undercoat of fine wool. This brown wool was found in a good state of preservation on the side of the face of one specimen discovered in the ice-fields of Siberia, and is now in the Museum of Petrograd. In the distance can be seen a group of mammoths and a line of saigas—an extinct species of antelope. The rhinoceros kept closely to the ice-sheet and never wandered so far south as did the mammoth. It was a plains-dweller, living on grass and small herbs.

began in 1891 and extend from the first appearance of vertebrate life to the very close of the Pleistocene of North America. These collections now include about 25,000 catalogued specimens, chiefly from North and South America, but there are also specimens from Eurasia, Africa, and Australia, obtained either by museum expeditions or by exchange.

The Hall of the Age of Man is of especial interest because it affords the first opportunity of working out in palæontology the general theory of exhibition which prevails throughout the American Museum—namely, to present animals, extinct as well as living, in their environment. In this hall what is actually known of the history of man is presented in a series of ten central cases

Pampean region of South America, and of the loess deposition on the Missouri River in the latitude of Kansas, where the native American horse appeared for the last time on the American continent. These murals represent the four seasons of the year in mid-Glacial time. Thus the woolly rhinoceros, the saiga antelope, and the woolly mammoth are shown (Fig. 1) in a midwinter steppe scene of northern France. The succeeding mural (Fig. 2) represents early spring, herds of mammoth and of reindeer migrating northward. This is the most authentic of the murals, because it is based upon the painting, drawing, and sculpture of the contemporary Crô-Magnon race (Fig. 4). Midsummer is depicted on the Missouri River in the latitude of Kansas (Fig. 3); the least-known animal in this stage is *Bison regius*, which is represented in the American Museum by a gigantic head and horns, the only

¹ The present article was prepared at the request of the Editor as an abstract from an article with the same title which appeared in the popular journal of the American Museum, *Natural History*, vol. xx., May-June, 1920, No. 3.



FIG. 2.—Early spring — "The Reindeer and Mammoth on the River Somme, France."—It is thought not improbable that herds of mammoth, rhinoceroses, and reindeer migrated northward and southward with the seasonal changes. This mural represents a northward march in the spring. As the mammoth was faithfully depicted by the Crô-Magnon artists—especially in the cavern at Font-de-Gaume—and as mammoth skeletons have been well preserved, there can be little doubt that the present representation by Knight is a close likeness of this huge proboscidean. The woolly mammoth resembled greatly an Indian elephant, but was somewhat larger, was covered with coarser hair, and had larger and differently curved tusks. Whole carcasses of these beasts have been found frozen in the ice-fields of Siberia, where they probably survived later than in Europe.

type of this species thus far found. The autumn scene of this series is in northern New Jersey, the place of discovery of the deer-moose, or *Cervalces*, of the northerly range of the tapir, and of the North American coypu type of rodents known as *Castoroides*.

On the opposite side of the hall, facing the four seasonal series, are other murals, which represent the life of the Pampean region, the ground sloths, glyptodonts, toxodonts, and macrauchenias, in a series of groups. Very careful studies of the superb fauna of southern California are now being made for murals, which will depict the life discovered in the tarpools in the vicinity of Los Angeles, where occurs the most remarkable collection of extinct mammals so far found in the whole history of palæontology, since the entire fauna of early and middle Pleistocene times is represented, including the three types of mammoth—the imperial, the Columbian, and the woolly—the bison, the horse, the camel, the sabretoothed tiger, and the giant lion, *Felis atrox*. It is intended to show here the entire mammalian and avian fauna of the period. Studies upon the animals in these murals now extend over eight-years, and other years of additional study will be needed. The restorations themselves are preceded by models. The naturalness of the scenes is aided by kinema reproductions secured by recent museum expeditions of similar scenes among existing large mammals of Africa and from drawings made in early days in Africa, when the mammals were still in their primitive number and variety.

Materials in the central cases devoted to human prehistory are placed in ascending order, beginning with replicas of the Trinil man of Dubois, the Piltdown man of Smith Woodward, and the Heidelberg man of Schoetensack. In the final arrangement each will occupy an entire case showing the geologic position of the find, replicas of the original materials, the author's restorations, and museum restorations by Prof. McGregor. It is noteworthy that a hundred years of fossil hunting in various parts of the world have yielded only these three individual types of human and prehuman ancestors. As soon as the period of human burial begins, in the closing centuries of the long period when the Neanderthal race covered western Europe, skeletal remains become very abundant, and it will require two large cases to exhibit replicas and restorations of the Neanderthal species of man successively discovered near Gibraltar, Neanderthal, Spy, Krapina, at many points in the Dordogne Valley, and most recently in Spain. The masterly work of Boule on this race is supplemented by the exhaustive anatomical studies of McGregor and other anatomists which form the materials on which the first of the murals depicting life in the Old Stone age is founded; this is the beginning of the Cave period, and a group of Neanderthals is represented in a flint quarry in front of the Grotto Le Moustier, which gives its name to the whole period of Mousterian culture.

The second of the human murals (Fig. 4) is that for which the evidence is most authentic, inasmuch as we have several complete skeletons of Crô-Magnon man, giving us the entire anatomy; also the lamps, the ornaments, the insignia of the chieftains, the materials showing the methods of preparing the paints, and, still more remarkable, the actual painting of the procession of the mammoths, which is taken as the central feature of this restoration. It would appear that the highly evolved Crô-Magnon race entered Europe from the east and drove out the Neanderthals. There is little evidence of inter-marriage between these two widely distinct races, although two of the skeletons of the burial at La Ferrassie show characters which may be so interpreted. The contrast between the Crô-Magnon heads and those of the Neanderthals is as wide as it possibly could be. The Crô-Magnons are people like ourselves in point of evolution, and the characters of the head and cranium reflect their moral and spiritual potentialities, while the body skeleton points to a physically perfect race.

The concluding mural of the human series represents a group of stag-hunters depicted as men of the northern fair-haired race living along the southern shores of the Baltic in the earliest phase of the Neolithic—the stage known as the Campignian from the remains of huts and rudely finished implements found near Campigny, in France. If of Nordic affinity, this race was courageous, warlike, hardy, and probably of lower intelligence than the Crô-Magnons. It is still, however, an open question to what primary branch of European stock this race of Campigny belonged.

In each of the central cases the culture element is associated with the skeleton wherever it has been found to show correlation between the mental development and the industrial or artistic stage. The tests of a museum exhibition series are, first, that it meets the specialist's demand for accuracy; secondly, that the exhibits are arranged in such a way as to attract and arouse the interest of the people; and thirdly, that the aroused interest leads to a more careful examination of materials and to at least a dawning comprehension of what they signify. The central cases and the models and murals which seek to interpret them appear to stand all three tests admirably. They arouse the interest of increasing numbers of visitors,² and it is noticeable that the Old Stone age and the cave man are finding their way into the current intellectual life of the American people, who, in general, are far behind their European contemporaries in their general knowledge of the rudiments of anthropology and archaeology. This exhibition series presents the facts of human evolution in a simple and convincing way.

The collections of original fossils brought together in the Hall of the Age of Man are worthy of supplementing the human series found in the

² The annual attendance is now above a million. Sunday attendances during January, 1921, averaged 12,500. By its contract with the City of New York the museum now receives 350,000 dollars annually from the Municipality of New York.



FIG. 3.—Midsummer.—“The Mastodon, Royal Bison, and Horse on the Missouri River, in the Latitude of Kansas. —This mural presents a summer scene in a region of North America south of the farthest advance of the ice-sheet. The great mastodon (left) with flat, elongated head and extremely short, massive legs survived in America to a time contemporary with man in Europe, but no mastodons lived in Europe at such a late period. In the centre of the picture are seen the royal bison (*Bison regius*), the gigantic forerunners of our present bison. On the right is a group of the last species of native American horse (*Equus Scotti*), which disappeared before the appearance of man on the North American continent.”

central cases. They cover the complete evolution of the Proboscidea, from the early stages in the life of this great order described by Andrews in the genera *Phiomia* and *Palæomastodon* from the Fayûm region of northern Africa. This collection carries us back into an early period in the Age of Mammals, the Oligocene, for it has been deemed wise to present here the entire history of the evolution of the Proboscidea, which, taken altogether, is the most majestic line of evolution thus far discovered. It is possible that the ancestors of man were the companions of the proboscidean race from the beginning, because the *Propliopithecus*, the companion of the *Palæomastodon* in the Fayûm, is at least structurally ancestral to the higher apes and man—in other words, it is a possible prehuman link, for it is conceivable that

the true *Mastodon americanus* of the eastern American forests in the late Pleistocene. This race reaches its climax in the massive *M. americanus*, represented in the famous specimen known as the Warren mastodon, which was presented to the museum by the late J. Pierpont Morgan. Nearby is the complete skeleton of the American woolly mammoth, *Elephas primigenius*, above which towers the partial skeleton of the imperial mammoth, *E. imperator*.

The south-west quarter of the hall is devoted to the Cope Pampean Collection, chiefly consisting of mounted skeletons of the ground sloth family and the glyptodonts, and of the sabre-toothed tiger of the Pampean region. With these are casts of the skeletons of three other characteristic South American animals, the Macrau-



FIG. 4.—Contemporaneously with the disappearance of the last Glacial period in Europe, a highly evolved race in no respect inferior to modern man entered that continent from the east and drove out or exterminated the Neanderthal race, of which they were both the mental and physical superiors. Their cultural capacity is indicated not alone by their physiognomy and the cubic content of their brain, but has also been demonstrated by the handiwork and especially the artistic productions which they have left in the caves of southern Europe. The Palæolithic murals and sculptures in relief found on the walls of limestone grottoes in France and Spain indicate greater artistic sense and ability than have been found among any other uncivilised people. The mural above, painted by Knight for the Hall of the Age of Man, represents four Crô-Magnon artists at work on the famous procession of mammoths as found in the cave of Font-de-Gaume, Dordogne, France. The two half-kneeling figures are holding lamps made of hollowed-out stones. The artist standing half erect is engaged in incising the outlines of a mammoth on the limestone wall with a sharp flint; the other artist is laying on the colours, employing a shoulder-bone for a pallet. The kneeling figure is preparing colours from red or yellow ochre. The clothed man to the left is a chieftain who carries a *bâton de commandement* on his staff as an insignia of his rank.

from such an animal the anthropoids and human lines diverged.

The higher Proboscidea include two complete skeletons and several skulls of the superb race of long-jawed mastodons which have recently been shown by the studies of Dr. Matsumoto to be the true descendants of *Phiomia* of northern Egypt through the classic narrow-toothed mastodon, *M. angustidens*, of Central France in Miocene times. This very vigorous and successful race, starting from Egypt, reached North America at the close of the Miocene, spread all over the present region of the United States during Pliocene times, and then became entirely extinct.

It now appears that the Egyptian form of *Palæomastodon* is, as its happily chosen name indicates, actually an ancient mastodon which gave rise to

chenia, *Toxodon*, and *Hippidium*.³ To demonstrate the American migration of both the sloths and glyptodonts into North America in late Pliocene times, there is also a series of North American ground sloths and glyptodonts, chiefly derived from the explorations of the museum in Texas and Mexico, and from the region of the Rancho La Brea tarpoools of southern California, where the sloths occurred in very great abundance.

This scheme of arrangement whereby interest is centred in the fauna fits in with that of the remainder of the hall showing the wonderful climax in the Age of Mammals, when a similar mammalian fauna covered the tem-

³ The valuable collections obtained from the Miocene of Patagonia and certain early Tertiary North American fossil mammals are also assembled here as affording light on the origin and early history of this marvellous Pampean fauna of South America.

perate regions of the entire northern hemisphere as far south as North Africa and Mexico, which appear to have been the southern limit of the great waves of migration of the various types of mammoths from Central Asia. This is, in fact, the climax in the history of such diverse families as the proboscideans, camels, horses, bison, and the great carnivora that preyed upon them. The impression created by the collection in a single hall of all these various types is that the period just preceding the final great glaciation of the northern hemisphere witnessed the assemblage of the most superb land mammals that the earth has produced. It is virtually the climax of the Age of Mammals, and marks the beginning of what

has since proved to be the close of the Age of Mammals, because the elimination which began from natural causes during the early stages of human evolution, and reached the dimensions of a cataclysm as the Ice age progressed, has now been accelerated by the introduction of firearms. By the middle of the present century man will be alone amid the ruins of the mammalian world he has destroyed. The period of the Age of Mammals will have entirely closed, and the Age of Man will have reached a numerical climax, from which some statisticians believe it will probably recede, because we are approaching the point of the over-population of the earth in three of the five great continents.

The Rise and Development of the Sussex Iron Industry.

A PAPER of considerable interest on this subject was recently read before the Newcomen Society (formed two years ago for the study of the history of engineering and technology) by Mr. Rhys Jenkins. He pointed out that although the industry in Sussex has been extinct for a hundred years, the district is historically one of great importance, for it was here that the blast-furnace was first used in England, and afterwards spread to what are now the chief iron-making districts in the Midlands, the North, and South Wales. Although it is customary to speak of the district as Sussex, it embraces parts of Kent, Surrey, and Hampshire; in fact, it is the Weald between the North and South Downs. Sites of old iron works exist from a little beyond Haslemere on the west to Sissinghurst on the east.

It appears that iron was manufactured in the Weald in early times, and there are clear indications of the existence of the industry during the Roman occupation. It is supposed to have waned with the coming of the Anglo-Saxons, and the indications of its existence are very scanty until Norman times are reached. Down to about the fifteenth century the iron was made by a direct process—*i.e.* the ore was reduced directly to malleable iron. Its production must have been on quite a small scale. At some period in the latter half of the fifteenth century, however, the blast-furnace was introduced into Sussex, and proved to be the forerunner of the modern process in which the ore is first smelted with the production of fluid pig-iron, and afterwards converted either into wrought iron or into one of the many varieties of steel. It was the blast-furnace which started the Wealden iron industry on its career of prosperity, and soon Sussex became the premier iron-producing district of England. It must not be imagined that there was ever anything in the nature of a "black country," for, although there were a great many works, they were scattered over a wide area, and they were small. The only fuel employed was charcoal, and the power was derived from the streams.

Mr. Jenkins reviewed at some length the evidence available, and came to the conclusion that the blast-furnace, together with the finery process for converting cast iron into malleable iron, had been introduced into England before the year 1500; by that date there were certainly three furnaces at work—namely, at Buxted, Hartfield, and Newbridge. The iron workers were of French origin, and this points to the method of manufacture having been borrowed from France. No doubt the old direct method of manufacture did not disappear at once, but it is probable that by the middle of the sixteenth century it had been entirely displaced. By that time a number of native workmen had been trained in the new process, and the total number of works in the district, according to a return made in the year 1548, was fifty-three, of which about half were furnaces. The new works were established as near as possible to the sea-coast; clearly the object was to reduce, so far as possible, the expensive land transport. Every reduction in the cost of carriage placed the Sussex maker on a more favourable footing, as against the foreigner, in the London market.

The direct process had been carried out on a small scale, and produced a bloom weighing from 100 lb. to 200 lb. at a time. The manufacture could be carried on with few appliances and inexpensive erections, and entirely by human labour. It needed only a small capital outlay; obviously it was the industry of the small man. All this was changed with the coming of the blast-furnace. The furnaces, with the finery, chafery, and hammer, were comparatively expensive structures. The furnace bellows and the hammer called for more power than could be conveniently applied by workmen, so water-power was pressed into service. This meant the acquisition of an existing mill, possibly of a number of water rights, and the construction of dams or bays to form the furnace and hammer ponds, once so common a feature in Sussex. All this required an outlay of capital, probably in many cases the ownership of land, etc.; in short, iron-making was transformed

from a craft, such as that of the blacksmith, to something approaching modern capitalistic production.

In 1543 occurred a great event in the history of the industry—the founding of the first cast-iron gun at Buxted. The makers were Ralph Hogge and Peter Bawde. Hogge was the owner of the furnace, and Bawde one of the founders of bronze guns in the service of the king. The former knew how to work a furnace, and could furnish the molten iron; the latter was an expert gun-founder in bronze, and was learned in the proportions of the various pieces. The guns thus cast were very successful. As compared with bronze guns there was an enormous saving in cost, even after the founder had made a good profit and paid the carriage to London. The manufacture of these guns rapidly became a prominent feature in the Sussex trade. It seems to have been the first manufacturing industry in which the English distinguished themselves. During the reign of Elizabeth and onwards to the time of Charles II. English cast-iron guns were in demand all over the Continent. The historian Hume remarks: "Shipbuilding and the founding of iron cannon

were the sole 'arts' in which the English excelled. They seem, indeed, to have possessed alone the secret of the latter, and great complaints were made every Parliament against the exportation of English ordnance." Mr. Jenkins considers that the most likely explanation of this is that the Sussex men had invented some better and cheaper method of making the moulds than that which had been in use by the founders of bronze guns.

About the middle of the sixteenth century a public outcry against the consumption of wood by the iron works was raised, and in Parliament repeated objections were urged against the works both on this ground and on the impolicy of exporting ordnance.

Mr. Jenkins carries his survey down to the time of the Protectorate, from which it appears that in 1658 there were thirty-five furnaces and forty-five forges operating in the Weald, of which twenty-seven furnaces and forty-two forges were in Sussex. This appears to have been the culminating point of the iron trade of the Weald. Consideration of the further progress and decline of the industry in later years is reserved for another occasion.

Long-distance Telephony.

THE progress which is being made in long-distance telephony is exemplified in the interesting demonstration last week under the direction of Col. Carty in which conversations were carried on over a composite route of more than 5500 miles made up of a 115-mile section of submarine cable from Havana to Key West, overhead lines through Washington and New York, and right across the continent through San Francisco to Los Angeles, and, for the sake of completeness, including a 29-mile stretch of "wireless" to St. Catalina Island, in the Pacific.

There is, of course, nothing remarkable in the last-mentioned section in the point of distance, as wireless telephony is in some ways less handicapped by distance than line working; but the fact that the wireless apparatus was successfully linked up with so long a land line is noteworthy. The cable section, on the other hand, is of a length which has hitherto been beyond the limits of submarine telephony, for, as is well known, the capacity effects inseparable from such cables produce a distortion of the current waves which, when their amplitude is sufficient for audibility, renders articulation unrecognisable. The earlier telephone cables relied upon artificially introduced inductance to counteract this effect of capacity, but, in the circuit we are speaking of, the problem has been further solved by the use of thermionic repeaters, so that waves of much smaller amplitude can be employed in the cable. The *Times* points out that the Havana-Key West cable is of British manufacture, and is arranged to carry, in

addition to one telephone communication, four simultaneous telegraph messages.

The capacity effect of overhead land lines is also present, but is not nearly so serious as that of cables. Inductance coils, or Pupin coils, as they are called after their inventor, were employed in the New York-San Francisco line when American trans-continental telephony was first accomplished before the days of the thermionic valve; but it has now been found possible to remove them altogether by establishing repeater stations at 250-mile intervals along the line. The same method can be, and is being, applied to assist speech over the shorter underground cables used for trunk lines in England; but, even with such assistance, it is only by the use of overhead lines that distances of thousands of miles can be bridged over by line telephony.

The demonstrations show that there is nothing technically impossible in telephoning between England and India or the Cape, for example, where only short submarine connecting links are required; but whether it would be commercially possible, owing to the great expense and difficulty of patrolling and maintaining so long an overhead line passing through every kind of territory, is another matter.

The problem of transmitting speech over such long, uninterrupted lengths of cable as across the Atlantic is not yet solved, nor does its solution appear likely in the near future. The only possibilities in this direction are those of wireless telephony, which, in the case of communication between Europe and America, is already within

the range of physical, if not of commercial, practicability. Indeed, there are many fields where wireless telephony already rivals telephony over the metallic circuit, especially now that methods of linking up the two have been perfected, and we look forward with interest to the results of

the experiments now being made with the view of establishing a commercial wireless telephone service between London and Birmingham, and the competition which appears likely between cable and wireless telephony from England to Holland.

Obituary.

BY the death at Cambridge, on April 9, of DR. RICHARD HENRY VERNON, at thirty-six years of age, the younger generation of chemists in this country has suffered a serious loss. The elder son of the late Hon. William Vernon, Dr. Vernon was educated abroad and took the degree of Ph.D. at the Zurich Polytechnic. At the close of his course at Zurich the war broke out, and although his health had always been delicate he hastened to offer his services and enlisted as a private, receiving later a commission in the Dorset Regiment. After having been invalided home, he worked for the Chemical Warfare Committee, first at the Imperial College of Science, and afterwards in the University Chemical Laboratory, Cambridge. He was then sent to the Shell Filling Factory at Chittingen, where his health became seriously affected. After the armistice he returned to Cambridge, and was appointed to the official position of assistant to the professor of chemistry. Dr. Vernon possessed in a remarkable degree the special sense of the organic chemist, and his manipulative ability was quite exceptional. His work on tellurium, which led to the discovery of the isomeric dimethyltellurium iodides, had an important bearing on the stereochemistry of elements of higher atomic weight and impressed all who had seen it with his powers. He had a personality of singular charm and attractiveness that rapidly won the friendship of all with whom he was brought into contact.

WE notice with much regret the announcement of the death, on April 13, of MR. HOWARD PAYN in his eighty-first year. In his early life Mr. Payn qualified as a barrister, but never practised. In middle life, after some years' service on a Sugar Commission, he became greatly interested in astronomy, and in 1899 entered Sir Norman Lockyer's laboratory at South Kensington as a volunteer worker. Mr. Payn took part in the eclipse expedition to Santa Pola, Spain, in 1900, and obtained a fine series of photographs of the corona and prominences with a lens of 16-ft. focal length. In 1905 he was with Sir

Norman Lockyer's eclipse party at Palma, Majorca, but the spectroscopic photographs which he had planned to take were only partially successful, on account of clouds. In collaboration with Prof. Fowler, he was among the first to investigate the vacuum arc spectra of metallic elements, and to show that enhanced lines are strongly developed under these conditions. Mr. Payn also rendered considerable assistance to Sir Norman Lockyer in his work on "Stone Circles." He died in a nursing home at Hounslow after a long illness, and will be greatly missed by his many friends.

THE sudden and unexpected death, from heart failure, of DR. HERBERT HAVILAND FIELD, at the age of fifty-two, is a great loss to scientific workers. Some thirty years ago Field, then an American student at Paris, left the path of biological research for the less inviting road of bibliography. His aim was to provide a bibliographic service by cards of standard size. Each card carried numbers according to a modification of the Dewey decimal system, enabling it to be sorted mechanically into place according to the classification desired. Later he became associated with the bibliographic section of *Zoologischer Anzeiger*, and eventually founded at Zurich the well-known Concilium Bibliographicum, which has had the support of the Swiss Government and of various American funds. There he died at his work. It is to be hoped, especially in the present circumstances of the International Catalogue, that the institution he founded will continue and expand.

WE much regret to announce the death, on Monday, April 11, at the age of seventy-seven years, of PROF. ARNOLD WILLIAM REINOLD, F.R.S., lately professor of physics in the Royal Naval College, Greenwich.

WE regret to record the death, on April 9, of MR. BERTRAM BLOUNT, the well-known chemist, at fifty-four years of age; and, on April 13, of MR. R. A. ROLFE, of the Royal Botanic Gardens, Kew, at sixty-five years of age.

Notes.

WITH the intention of saving the lives of numberless birds of bright plumage slaughtered in foreign lands for no better purpose than unnatural decoration, a "Bill to prohibit the importation of the plumage of birds and the sale or possession of plumage illegally imported" has again been introduced in the

House of Commons, and on April 13 passed the second reading by a majority of 143 votes against 25. The scope of the Bill is wide. As it stands, it prohibits the importation of all birds' plumes excepting those of African ostriches and eider-ducks, of birds imported alive, of birds ordinarily used in the United

Kingdom as articles of diet, and such plumes as have been imported by a passenger for personal use. A special proviso allows the Board of Trade to grant a licence permitting the importation of plumage "for any natural history or other museum, or for the purpose of scientific research, or for any other special purpose." Opinions in the House of Commons varied as to the probable efficiency of the Bill in its aim of protecting decorative birds. It is obvious that such a decree cannot approach in effectiveness measures of strict protection which might be enforced in the countries which the birds themselves inhabit, nor can it compare with a possible international agreement regulating the use of bird-plumages, but in at least two ways it should make for a reduction of the massacre of birds. In the first place, it should to a very great extent banish the use of imported birds' plumes for decoration in the United Kingdom, and to that extent the actual demand would be reduced. It may also, by dislocating the centre of dispersal in London, permanently disorganise the world-market, and so reduce opportunity for the disposal of skins, and with this the activities of the plume-hunters. In the second place, the moral effect of the final adoption of the Bill would probably be great, and other countries would follow the United Kingdom in endeavouring to protect, without as well as within their own boundaries, "birds attractive in appearance," and perhaps it may be added (as the Nebraskan law adds) "cheerful in song."

THE Corn Sales Bill came up for second reading in the House of Commons on April 14. Its object is to provide for greater uniformity in the weights and measures used in the sale of corn and other crops. At the present time in different districts the quarter of wheat might be 480 lb., 496 lb., 500 lb., 504 lb., or 588 lb. in weight, and even greater variations exist in the case of rye and oats. The Bill provides that all dealings in corn should be made by weight in terms of the hundredweight of 112 imperial standard pounds, the result of this being that the ordinary sack of wheat would be reduced from 18 to 16 stone. Opposition was raised on the grounds that the whole of the futures market in this country is based on the decimal system, and that inconvenience would be caused if all dealings in centals had to be transformed into the 112-lb. measure. It was suggested that the unit of 100 lb. should be substituted for that of 112 lb. proposed in the Bill, but this amendment could not be made until a later stage. The second reading was agreed to without a division.

DR. W. EAGLE CLARKE retired on March 14, under the Civil Service age-limit, from the keepership of the Natural History Department of the Royal Scottish Museum. During his service of thirty-three years he has been mainly responsible for the growth of this museum, and the period of his keepership, to which he was promoted on the retirement of Dr. R. H. Traquair in 1906, has been specially fruitful in the development of the natural history collections as regards both cabinet and exhibited material. Under his supervision the exhibited systematic collections have been entirely rearranged and revised with the view of increasing

their æsthetic and educational as well as their scientific value, and many biological groups of birds and mammals have been introduced with great effect. Dr. Eagle Clarke has now been appointed honorary supervisor of the bird collections in the museum. He intends to devote his leisure to the editing of new editions of Saunders's "Manual of British Birds" and Yarrell's "History of British Birds." The vacancy caused by the retirement of Dr. Eagle Clarke has been filled by the promotion of Dr. James Ritchie, who entered the service of the museum, after competitive examination, in 1907.

THE inaugural meeting of the Indian Botanical Society, established "for uniting the botanists and promoting the botanical interests of India," was held under the historic banyan-tree in the Calcutta Botanic Garden at the time of the eighth Indian Science Congress in January last. A booklet has been issued describing the origin of the society, its aims and its provisional constitution, and giving a list of the original members, eighty-one in all. The president for the year is Dr. Winfield Dudgeon, of the Ewing Christian College, Allahabad; the vice-president, Dr. W. Burns, of the College of Agriculture, Pooana; and the secretary and treasurer, Mr. Shiv Ram Kashyap, Government College, Lahore. The society does not contemplate any official publication, but members are encouraged to support the *Journal of Indian Botany*. Meetings will be held annually in conjunction with the Indian Science Congress, and the programme for the meeting will be prepared by the executive council in co-operation with the officers of the botany section of the congress. The membership is widely representative of botany and its applications to agriculture and forestry throughout the Empire.

WE learn from the *Pioneer Mail* of March 4 that on February 23 the Viceroy inaugurated the Institution of Engineers (India) in Calcutta. The institution was formed last September as a result of the desire of engineers in India to form a corporate body to safeguard their interests and to provide a means of exchange of views on engineering questions; the institution was open to professional engineers of all nations. In declaring the institution duly inaugurated, the Viceroy emphasised the importance of such a body to a country like India with a growing industrial side, and congratulated the members on the form of their constitution, by which provision was made for the admission of junior members to the council, so that there should be little risk of the council getting out of touch with the aspirations of the younger generation of engineers. The relation of the new institution to the Government of India was also enlarged upon, and its importance as an unofficial advisory body, both as regards industrial questions and with reference to technical education, was discussed.

DURING the interval that has elapsed since the publication of the Report of the Empire Cotton Growing Committee considerable progress has been made towards the establishment of a permanent organisation competent to carry into effect the recommendations contained in the report. The permanent body

will be known as the Empire Cotton Growing Corporation, and will be incorporated under Royal charter. Meanwhile, the present Committee has been making careful inquiry from the Governments of the Dominions, Colonies, and Protectorates as to the means by which the development of cotton-growing within the Empire may best be promoted. From more than one of the Governments approached the suggestion has been made that specially qualified men should be appointed to advise the local Agricultural Departments on matters connected with cotton-growing within their respective areas. To assist the proposed corporation the Empire Cotton Growing Committee is prepared to receive now from suitably qualified persons statements of their scientific attainments and/or experience of tropical agriculture, with the view of compiling a register of men whose services overseas may be useful in the development of cotton-growing, either in consultation or by appointment as cotton experts. The register is intended to be available for reference by the corporation now in course of formation, but it is unlikely that appointments can be made for the next few months. All communications, which will be regarded as confidential to the members of the council of the corporation, should be addressed to the Secretary, Empire Cotton Growing Committee, Board of Trade, Great George Street, London, S.W.1.

THE Civil Service Commissioners announce that an open competitive examination for not fewer than twenty situations as assistant examiner in the Patent Office, Department of the Board of Trade, will be held in London in July next, commencing on July 12. The limits of age are twenty and twenty-five, with extension for service in H.M. Forces. Regulations and forms of application will be sent in response to requests by letter addressed to the Secretary, Civil Service Commission, Burlington Gardens, London, W.1, on and after April 25.

"THE Early Chronology of Sumer and Egypt and Similarities of their Culture" is the subject of a lecture to be delivered by Prof. S. Langdon at the Royal Society's rooms at Burlington House on Wednesday, April 27, at 8.30. The lecture is arranged by the Egypt Exploration Society, and tickets can be obtained gratis on application to the Secretary, 13 Tavistock Square, W.C.1.

PROF. G. H. PARKER has been appointed director of the Harvard Zoological Laboratory in succession to Prof. E. L. Mark, who will retire at the close of the academic year after having spent forty-four years in the service of the University. The new director has been a member of the teaching staff at Harvard since his graduation in 1887, and has held a full professorship of zoology since 1906.

THE Government has accepted the invitation of the Spanish Government to participate in the third International Fishery Congress, which will be held at Santander on July 31-August 8, and has appointed as its representative Mr. H. G. Maurice, Fisheries Secretary.

DON JOSÉ RODRIGUEZ CARRACIDO, Rector of the University of Madrid, has been elected president of the Spanish Association for the Advancement of Science.

THE fourth Silvanus Thompson memorial lecture of the Röntgen Society will be delivered on Thursday, May 19, by Prof. A. V. Hill, of the University of Manchester. The subject will be "Electrical Instruments and Phenomena in Physiology."

IN the Journal of the Royal Anthropological Institute (vol. 1., January-June, 1920) Prof. A. C. Haddon contributes an elaborate monograph on the outriggers of Indonesian canoes. The present focus of outrigger canoes is the Moluccas, and it is suggested that from Indonesia, if not actually from the Moluccas, migrations took place at various times, each with its special type of canoe or with some partial modification, the earliest types of canoes or outriggers being those that went furthest, while those that started last have a more limited distribution. The paper is well illustrated with woodcuts, and furnished with an ample bibliography of the subject.

MR. T. SHEPPARD has republished from the Transactions of the East Riding Antiquarian Society (vol. xxii., 1920) a paper on the origin of the materials used in the manufacture of prehistoric stone weapons in East Yorkshire. Curiously enough, for a considerable distance in any direction this area does not produce a single rock *in situ* which is suitable for making stone implements. The Yorkshire Chalk, which surrounds Holderness and forms the Wold area, has furnished many thousands of implements, but, though it contains flints, it produces only a form of this material which, owing to its brittle nature, is useless for the purpose. Holderness, on the contrary, a rubbish-heap deposited at the close of the Great Ice age, contains boulders, large and small, derived from Scotland, the Lake District, Teesdale, the coast of Durham and Yorkshire, and even Scandinavia, which supply large quantities of black and pink flints, excellent material available for the ancient flint-workers. Mr. Sheppard's paper, which is supplied with numerous good illustrations, gives full details of this ancient industry.

FOR the moment smallpox has sunk almost to vanishing point, but this is just the time to read the carefully prepared pamphlet by Dr. Mary Scharlieb on vaccination (Research Defence Society, 1s.). Last year's experience in Scotland shows that smallpox is once more "on the move." During demobilisation thorough inspection of soldiers and civilians stopped many cases at the ports, but now that the Baltic and the Mediterranean are both open the chances of fresh importations have multiplied enormously. Under the new regulations the port sanitary authorities will be better equipped for handling the ordinary infections, including smallpox, at the ports; but the danger of outbreaks, now that the numbers of susceptibles have grown to be a large fraction of the community, will increase as foreign trade increases. Dr. Scharlieb gives an orthodox *résumé* of the historical facts about vaccination, and the whole pamphlet is an appeal to

the reason of the anti-vaccinationists. "It would appear," she says, "to be advisable to substitute argument for compulsion." She deals in some detail with the "Leicester experiment." "The Leicester method, as advocated by Dr. Millard, includes vaccinations as general as possible when an outbreak occurs." When Dr. Scharlieb says, "The incubation period of vaccinia is shorter than that of variola, eight or nine days as against twelve," the words imply that these are two distinct diseases. The modern view is that "vaccinia" is simply the effect of inoculating the cow or calf with smallpox virus, and is not any more a separate disease than human tuberculosis inoculated on a cow would be. But the virus, cultivated on the calf through several generations, loses its capacity to produce general infection. As this is a cardinal point in the anti-vaccination argument, the Research Defence Society might well devote a special paper to it. The "portion of the Gloucester cemetery" shown as frontispiece is an eloquent comment on Nature's way with the unvaccinated.

WE note with much satisfaction that Major Stanley Flower's efforts to restore the well-nigh exterminated cattle-egret to Egypt have been abundantly rewarded. Mr. J. L. Bonhote, in the Report on the Zoological Service for the Years 1914-18, published in connection with the Giza Zoological Gardens, gives a long and able summary of the steps taken to bring about this much-to-be-desired end. When this apparently hopeless task was begun the bird had been all but exterminated by plume-hunters. Mr. Bonhote is now able to report colonies numbering several thousands, and the birds appear to be still extending their range. In this achievement, made possible by the enlightened action of Lord Kitchener when British Agent and Consul-General, Major Flower has rendered a signal service to Egypt, for the cattle-egret as a destroyer of ticks on cattle and of noxious insects of many kinds has no rival, and therefore the establishment and preservation of large colonies of this bird are of vital importance to the country.

THAT the woodcock will, on occasion, transport its young by carrying them in mid-air is now a well-established fact. A few other species are said to have been seen performing this feat. Mr. J. H. Gurney in the April issue of *British Birds* writes to say that on May 12, 1920, he found a long-eared owl covering four young ones under a gorse bush. "The situation was somewhat unusual, and so was her subsequent behaviour, for she carried two of her nestlings, in consequence of their being looked at, more than twenty yards and deposited them on a pair of young Scotch firs, where they presented a very comical appearance." It would be interesting to know whether she carried off the remaining nestlings to the trees or transferred the two in the trees back to the nest when the cause of her alarm was removed. In the same communication—"Ornithological Notes from Norfolk for 1920"—Mr. Gurney shows that at least two pairs of bitterns reared young in Norfolk during that year. This, indeed, demonstrates the efficiency of the protection afforded to rare breeding birds in Norfolk.

NO. 2686, VOL. 107]

IN an article entitled "Facts about Rattlesnakes," published by the *Los Angeles Times*, and copied by the *Dallas Saturday Night* of June 26, 1920, Mr. W. S. Griswold describes many of the peculiar habits of these snakes. The commensal trait in *Crotalus cerastes* is certainly the most interesting. The horned rattlesnake, the author observes, takes up its abode in the burrow of a prairie-dog, which burrow is also sometimes shared by the small prairie-owl, all these three creatures living amicably together. He explains that the prairie-dogs' holes form the only possible shelter in the arid plains, and that being always near water they make doubly attractive retreats. "In return for this hospitality the rattlesnake," it is remarked, "takes charge of the census, and thoughtfully prevents the prairie-dog from accumulating a larger family than he can conveniently support." According to Dr. Gadow, this instance of commensalism is an exaggeration, the original inhabitants deserting the hole when the rattlesnake intrudes. Mr. Griswold's version is, however, quite credible when one considers the case of the Tuatara lizard, which excavates a hole which it shares with a petrel, and, although invariably tolerant of the petrel and its family, will not allow a second Tuatara to enter.

A CORRESPONDENT who travels frequently from the south-west of England to London states that, in his opinion, at this time of year vegetation, notably the flowering-trees, is generally more advanced as the metropolis is approached, and he asks whether others have made similar observations. Mr. J. Edmund Clark, who is largely responsible for the phenological reports of the Royal Meteorological Society, has very kindly forwarded us some particulars bearing upon the subject which do not appear to support our correspondent's statement except in the case of the hazel. The following are, for example, the dates of flowering for some trees during 1919 in south-west and south-east England:

	Hazel	Blackthorn	Horse-chestnut	May	Rose
S.W. England ...	Feb. 9	March 31	May 2	May 10	June 6
S.E. " ...	" 3	April 5	" 7	" 11	" 6

Records for 1920 are not yet available. The figures, of course, give no trustworthy indication of the time of flowering of cultivated fruit-trees, which probably constitute the greater part of the flowering trees in the neighbourhood of London.

IF segregation of Mendelian factors is determined by the separation of pairs of chromosomes during germ-cell formation, then there should be no Mendelian segregation in parthenogenetic eggs in which the full chromosome complement is retained. Prof. W. E. Agar has adduced further evidence on this point (*Journal of Genetics*, vol. x., No. 4) in a continuation of his breeding experiments with the Cladoceran *Daphnia*, which reproduces for the most part parthenogenetically. In a cross between *D. obtusa* and *D. pulex*, one of the hybrid offspring was bred parthenogenetically for ten generations. The most conspicuous difference between the species is in the relative lengths of two of the abdominal spines. The F₁ hybrid was intermediate as regards this ratio, and statistical treatment of the measurements of its

parthenogenetic offspring failed to show any segregation towards either parent. It is concluded that in such a clone segregation does not take place. The results would be more complete if it were also shown that in sexual reproduction of this hybrid segregation did take place in F_2 or later generations. Such a result would also be interesting as indicating whether the difference between the parent species depends on a single factor or on a larger number of genetic differences. Prof. Agar has shown that each species contains a large number of clones, each of which will perpetuate its differences in parthenogenetic reproduction.

THE 1920 report of the council of the British Research Association for the Woollen and Worsted Industries has just been issued. The chief feature in the report is a fully illustrated description of the research laboratories and workshops at present being fitted up in Leeds. In addition to paying 5400l. for the property upon which the central laboratories are being installed, 2000l. has been advanced for the purchase of a site for an experimental carding installation in Huddersfield. The director, Major H. J. W. Bliss, is gradually building up staffs for the physics and colloid chemistry, chemistry, engineering, and biology departments, and, although fundamental soundness is not being sacrificed to the too prevalent desire for quick returns, useful researches have already been taken in hand. Thus four publications (Nos. 7, 8, 9, and 10) on important problems have been issued to subscribers, and there are indications of useful work nearing completion on spinning, oils, scouring and milling, and last, but not least, those fundamental problems which no private firm can be expected to undertake. The sheep-breeding experiments, from the wool point of view, in which the association is collaborating with other bodies—notably the Agricultural Departments of England and Scotland—are deemed so important that a special pamphlet has been issued as an appendix to the annual report. Many useful breeding experiments are being made this season—largely under the stimulating influence of Prof. Cossar Ewart, of the University of Edinburgh—and it is hoped from these comparatively small-scale experiments to obtain useful data for others on a much larger scale. It is evident also from this appendix that, in addition to producing new crosses, the association is anxious to improve the present breeds, and in conjunction with the Royal Agricultural Society and other show committees it is about to engage in battle against "grey hair," "kemps," and a deterioration in "wool quality," following mistaken ideas on the relationships of wool and physique.

AN interesting point is made in Water-Paper 418 of the U.S. Geological Survey, on "Mineral Springs of Alaska," where it is remarked that permanent ground-frost surviving in the region from the Glacial epoch has an important influence in diminishing the mineral content of surface-waters. In Seward Peninsula alluvium has been found frozen to depths of more than 200 ft., while on hill slopes facing northward ice occurs within 2 ft. of the surface. Erosion, moreover, is prevented by the general covering of

moss, grass, and forest. A. H. Brooks, the author of this section of the paper, indicates a more normal composition for river-waters derived from the mountainous regions, where streams flowing from the snows cut deeply into rock.

THE noble genus *Nelumbo* is now represented by two species only, the Indian lotus of Asia and northern Australia and the American lotus or great water-lily, found in eastern America from Ontario to 7° S. lat. in Brazil. E. W. Berry (U.S. Geol. Surv., Prof. Paper 108-E) describes a new species from the Eocene of Meridian, Mississippi, resembling some of the European fossil forms, and he gives a world-map showing how the long history of the genus is revealed by its Cretaceous, Cainozoic, and present distribution. The author attributes the southward migration of *Nelumbo* to the inclemency of the Glacial epoch, and its entire disappearance from the Old World west of the Caspian to the natural obstacles presented by European structure, which prevented its escape southward into Africa.

THE *Meteorological Magazine* for March contains an article by Dr. J. S. Owens on London smoke-fogs. The method adopted by the Atmospheric Pollution Committee for measuring the impurities deposited from the air by large open-topped gauges is acknowledged as insufficient. It has now been supplemented by a method of ascertaining the quantity of suspended matter in the air. An automatic instrument is made to filter a fixed volume of air through a small disc of white filter-paper at short intervals, and a measure is made of the impurities left behind on the filter-paper. Continuous records have been obtained from three stations in different parts of London during the past winter. The records for foggy days are kept separate from days with ordinary weather, and the records for ordinary week-days, excluding Saturdays and Sundays, are kept separate from the results for Saturdays and Sundays respectively. The air is purest between midnight and early morning, and the amount of impurity rapidly increases at about 6 or 7 a.m., reaching its maximum at about 11 a.m. on week-days and at noon on Sundays. A subsidiary maximum is shown at about 5 p.m., after which the impurities rapidly decrease. It is shown, with probably some approximation to truth, that the impurities are due to domestic smoke rather than to industrial furnaces. The author acknowledges that at present the data are scanty, but expresses the hope that further results will prove instructive.

THE discovery by Sir E. Rutherford two years ago that α -particles from radium C on their passage through nitrogen or oxygen produced a small number of particles with range 1.3 times that of the original particles made it possible that the swift particles from thorium C discovered by Rutherford and Wood in 1914 might have been produced by the passage of the α -particles of range 8.6 cm. through the mica screen used in the experiments. In the April issue of the *Philosophical Magazine* Dr. Wood shows that this is not the case, and Sir E. Rutherford describes how he has obtained, by the aid of a powerful source of thorium C presented to him by Dr. H. McCoy, of Chicago, a sufficient number of the long-range par-

ticles to determine their bending in a magnetic field. By this means he shows that these swift particles are ordinary α -particles of mass 4, and not doubly charged particles of mass 3, such as are produced by the passage of α -particles through nitrogen and oxygen.

MESSRS. PASTORELLI AND RAPKIN, of 46 Hatton Garden, E.C.1, have issued a new list of their glass and metal hydrometers and specific-gravity instruments for use in chemical laboratories and for industrial purposes. The list includes not only all the hydrometers generally used in laboratory and technological determinations, those of Twaddell being particularly well represented, but also an extensive variety of salinometers and saccharometers. It is interesting to see that hydrometers have now a wide application in industry, being no longer confined to brewing and distilling, but required for petrol and other oils; by electricians for accumulators; in the meat-pickling trade; in laundries for testing starch; as "lactometers" for milk; by tanners, who call them "barkometers"; while there is even a special hatter's hydrometer for shellac solutions.

MR. JOHN MURRAY is to publish for Lord Haldane a work entitled "The Reign of Relativity," in which the principle of relativity will be dealt with in its

philosophical aspect, and not merely as interpreted in mathematical physics. The departments of biology, psychology, the State, and religion will be considered in the investigation, and illustrations of the principle of relativity in this wider application will be drawn from literature, art, religion, and recent physical and natural science. Another book in Mr. Murray's new announcement list is "The Great Malaria Problem and its Solution," by Sir Ronald Ross. The work will be largely an autobiographical record of the inception, progress, and ultimate success of the campaign against malaria.

MR. R. F. GRANGER, of Lenton Fields Climatological Station, Nottingham, who made naked-eye observations of the partial eclipse of the sun on April 8, writes to say that he saw Venus clearly, though he could see no stars. He noticed that faint cloud formed at 8.15 and disappeared at 9.0; "it probably lay in the damp layer at the top of the turbulent region, and appeared to be formed by direct cooling." Daisies closed, but chickens took no notice of the darkness.

ERRATUM.—NATURE of April 14, p. 218, 1st col., line 6 from bottom: For F. C. Cruikshank read F. G. Crookshank.

Our Astronomical Column.

PONS-WINNECKE'S COMET.—The following provisional elements of Pons-Winnecke's comet have been deduced with the aid of the recent observations.

T 1921 June 13.950 G.M.T., ω 177° 41' 37", node 93° 24' 19", incl. 19° 11' 31", log a 0.51403, e 0.69138, q 1.008.

Ephemeris for Greenwich Midnight.

	Date	R.A.		Decl.	Log r	Log Δ
		h. m.	s.			
April	18	16	12	39 36 N.	0.1050	9.6378
	20	16	17	40 21	0.0996	9.6213
	22	16	23	41 6	0.0942	9.6043
	24	16	29	41 53	0.0889	9.5868
	26	16	35	42 42	0.0836	9.5696
	28	16	42	43 18	0.0783	9.5505
May	30	16	50	44 0	0.0731	9.5313
	2	16	58	44 39	0.0680	9.5114
	4	17	6	45 19	0.0630	9.4911
	6	17	16	45 54	0.0580	9.4699
	8	17	26	46 28	0.0532	9.4481
	10	17	38	46 56	0.0486	9.4253
	12	17	51	47 18	0.0440	9.4017

The comet will be nearest the earth (distance 12,500,000 miles) on June 6. The earth passes the node on June 25, about nine days after the comet.

REID'S COMET.—This comet was on the verge of naked-eye visibility more than a week ago. It should be easily so visible when the moon is out of the way. M. Ebell has computed new elements from which the following ephemeris (for Greenwich midnight) is taken. The elements differ only slightly from those given in NATURE for March 31. T is May 10.01 and log q 0.00403:

	Date	R.A.		N. Decl.	
		h. m.	s.	°	'
April	22	20	41	54	33 44
	24	20	45	20	40 16
	26	20	49	36	47 11
	28	20	55	22	54 20
	30	21	3	32	61 29
May	2	21	16	10	68 24
	4	21	38	8	74 53
	6	22	24	22	80 37
	8	0	31	22	84 49
	10	4	27	37	84 50

Values of log r, log Δ : April 22, 0.0223, 9.8292; April 30, 0.0096, 9.8017; May 8, 0.0042, 9.8640. The high north declination will facilitate observation.

Mr. W. F. Denning writes:—"Reid's comet was faintly visible to the naked eye on the morning of April 16 at 3.20 G.M.T. The comet's perihelion will occur on May 10 next, and when the moon leaves the evening sky about April 24-25 the comet should be easily visible. It will then be situated in Cygnus and a few degrees south of α Cygni. Its motion is carrying it rapidly northwards, so that on May 2 the comet will be found 2° or 3° south-west of β Cephei. It should be readily found with a field-glass, and will probably be easily within reach of the unaided eye."

FIXED CALCIUM LINES IN EARLY TYPE STARS.—Since the discovery in 1904 of the fact that the H and K lines of calcium in the star δ Orionis did not share in the large displacements common to all the other lines, a similar effect has been observed in many other stars. A considerable amount of literature has thus accumulated on this subject of "fixed" calcium lines, which has now been collected and discussed by Mr. R. K. Young in a very useful summary published in the Journal of the Royal Astronomical Society of Canada (vol. xiv., p. 389). It appears that nearly all the stars having this peculiar characteristic are of early B type, and this forms a strong argument against the theory that the stationary calcium lines have their origin in a cloud of vapour lying between us and the star. It is also difficult to account for their origin by assuming an extended nebulosity enveloping the star and not partaking in its motion, since in a very close pair of stars observed by Plaskett only one showed this effect; and in the Pleiades, which are known to be surrounded by such a nebula, the effect is not seen at all. The author holds the opinion that the calcium vapour giving rise to the fixed lines forms part of the star's own atmosphere, but is much more extended than the proper reversing layer.

The New Star of 1912—Nova Geminorum II.¹

By MAJOR WILLIAM J. S. LOCKYER.

THOUGH new stars are of comparatively rare occurrence, several have appeared during the past few years, and much attention has been devoted to their study. Many observatories which have now taken up the spectroscopic examination of celestial objects, and are therefore equipped with spectroscopic apparatus of various kinds, have together secured a great amount of material which was lacking for the study of the earlier novæ.

Such was the case with the new star which was discovered by Enebo in Norway on the evening of March 12, 1912. This star appeared in the constellation of Gemini and is known as Nova Geminorum II., since it is the second nova that has shown itself in that constellation.

The star was, fortunately, discovered before it had attained its greatest brilliancy, as was also the case with the most recent new star, Nova Cygni III. (1920). On March 10, 1912, Nova Geminorum was less than a star of the eleventh magnitude, and it attained its maximum on March 14, being then of magnitude 3.37. After that it faded very rapidly, diminishing with fluctuations which were irregular in both period and amount.

The Solar Physics Observatory at Cambridge was fortunate enough to secure a very fine series of photographs taken by Mr. Stratton during the months of March and April, 1912—so good a series, in fact, that it required only a few photographs from other observatories to fill up the gaps. Most of these were supplied from the Allegheny and Bonn Observatories. Other photographs were taken of the later stages of the nova's career, but longer intervals between these only were required, as the spectral changes were slow. The measurement of all the photographs was completed in 1914, but owing to the outbreak of war the work of discussion could not be taken up until Mr. Stratton's return to the observatory in February, 1919. His discovery of the identification of many lines in the nova's spectrum with nitrogen, oxygen, and helium lines, which were greatly displaced from their normal positions, facilitated the work.

A discussion of all these photographs has now been published, and Mr. Stratton, who undertook it, has presented us with a work which gives a valuable insight into the nature of the changes which the spectrum of this nova underwent. The volume will thus greatly assist other workers who are discussing their observations of later novæ, and will possibly give them clues as to what kind of changes may be expected or how to look for them.

Since the spectrum of a nova is changing constantly, and sometimes with very considerable rapidity, especially about the time of maximum brilliancy, every photograph of its spectrum, wherever taken, may prove useful in the elucidation of the nova problem. Since the puzzling changes in the spectra are much more likely to be understood if the time interval between successive spectrograms can be greatly reduced, the author puts forward the view that for a complete elucidation of the problems involved all the spectra secured for any one nova should be placed at the disposal of a single investigator. There should be no difficulty in carrying out such a suggestion, provided that each observatory which takes some of the photographs and wishes to discuss them may do so prior to handing them over for the final inquiry.

One marked feature of this research is that it deals with photographs of the nova taken with instruments giving both large- and small-scale spectra. As the spectra of novæ at some stages consist of a mixture of broad, diffuse bands, together with very sharply defined lines, the former are seen and measured at their best in the small-scale spectra, while the latter are practically seen only in the large-scale spectra.

The discussion of the observations has led the author to differentiate between seven different stages in the spectrum of this nova. One cannot do better than quote from p. 9 the summary he gives of the different stages, as space forbids one to elaborate the information:

"(1) An absorption spectrum of type A₅ displaced, with weak radiations undisplaced (1912 March 13).

"(2) An absorption spectrum of type A₂b (α Cygni) displaced, with radiation spectrum undisplaced and with many absorptions doubled (1912 March 15-21).

"(3) Superposed absorption spectra of types A₂b (α Cygni) and B₂ (γ Orionis) displaced by separate amounts, together with an α Cygni radiation spectrum undisplaced. The γ Orionis absorption spectrum increases in strength compared with the α Cygni absorption spectrum, and accompanying bright bands of γ Orionis type gradually appear and increase in strength (1912 March 22-31).

"(4) α Cygni and γ Orionis radiation spectra undisplaced (1912 April 8).

"(5) γ Orionis and nebular radiation spectra undisplaced (1912 April 22).

"(6) Nebular radiation spectrum (1912 December 6).

"(7) Nebular and Wolf-Rayet radiation spectra (1914 February 22)."

The author enters fully into the method he adopted for differentiating between the types of spectra referred to in Nos. (1) to (3) above, and shows how by employing a displacement factor from known lines he was able to tie up lines of other elements, the displacement factor varying according to the date of the photograph examined. Thus, to take one instance, out of 108 strong lines in α Cygni, 79, according to this method, appeared displaced in the nova on March 15; reasons are given for the absence of many of the remaining lines.

As to the cause of the outburst of the new star, based on the spectroscopic evidence here brought together, the author does not commit himself, for he says that a final theory of novæ cannot yet be written. With regard to the most hopeful theory at present put forward, suggesting the collision of a star with a dark nebula and the consequent terrific action causing a tremendous outstreaming of glowing gases from the central body and the final formation of a planetary nebula with a Wolf-Rayet star as nucleus, the author says we "must await modification as further facts come to light."

In his preface Prof. Newall states that this vol. iv. of the Annals will be followed by memoirs on Nova Persei (1901) and on Nova Aquilæ III. (1918). The latter star, he says, "seems likely to afford more insight into the nature of the outburst of a nova than all the other new stars that have been studied with the help of the spectroscope."

While reference has only briefly been made to some of the main points in this volume on Nova Geminorum II., there are many other features in the nova's spectrum which Mr. Stratton has discussed very minutely, such as the undisplaced calcium lines, the structure of bright bands, etc. Two plates accompany the volume illustrating the spectra both as a whole and in parts.

¹ Annals of the Solar Physics Observatory, Cambridge. Vol. iv., part i.: "The Spectrum of Nova Geminorum II." By F. J. M. Stratton. Under the direction of Prof. H. F. Newall. Pp. viii+71+11 plates. (Cambridge: At the University Press, 1920.)

Gold-coloured Teeth of Sheep.

IN a paper "On Dental Encrustations and the So-called 'Gold-plating' of Sheep's Teeth," published in the Proceedings of the Linnean Society of New South Wales (August 25, 1920), Mr. Thos. Steel gives an account of the so-called "gold-plating" and encrustations on the teeth of sheep and other animals. He states that the popular idea is so strong that the jaws of sheep are still taken from time to time to the Sydney Mint with the object of selling them for the gold supposed to be present.

Mr. Steel refers to papers published in the Proceedings of the Royal Society of New South Wales and of the Sydney Section of the Society of Chemical Industry in 1905, in which Prof. Livingside showed that the encrustation is due to tartar deposited from the saliva in thin films. The golden colour and appearance are proved to be due to the reflection of light from the overlapping of the thin films, and in composition the deposit consists of impure calcium phosphate and organic matter, and not of iron pyrites, as confidently asserted by correspondents in *NATURE* (vol. xcix., 1917, pp. 264, 284, 290, and 306, and vol. c., 1917, p. 106), to account for which various "fantastic" explanations are given. Prof. Livingside stated that the deposit can be easily separated in thin flakes like mica with the point of a penknife, or even a pin, and that if a flake held on the point of a pin be placed in a match- or candle-flame it blackens, inflames, and leaves a white fusible residue; hence neither a knowledge of chemistry nor the use of any chemical apparatus is necessary to prove the absence of gold and of iron pyrites.

Mr. Steel has unearthed a forgotten statement by the late Dr. George Bennett in his "Wanderings of a Naturalist" (1834, p. 204) that the yellow "metallic substance" sometimes found on the teeth of sheep, oxen, and kangaroos, and frequently mistaken for gold, is simply tartar deposited from the saliva. Dr. Bennett quotes an analysis of the ordinary deposit on human teeth by Berzelius, who obtained results very similar to those of Mr. Steel. Mr. Steel had exceptional opportunities for obtaining large quantities of the coating, and was able to make quantitative analyses of the encrustations from the teeth of sheep, oxen, horses, etc., taken from the stocks of bones

passing through a large bone-charcoal factory in Sydney; from other sources he obtained sufficient material from the teeth of the camel, dromedary, rhinoceros, and even man. They consist mainly of calcium phosphate, with small amounts of magnesia, carbon dioxide, a little sand, from 16.20 per cent. to 24.65 per cent. of organic matter, and from 3.85 per cent. to 11.65 per cent. of water. Mr. Steel gives a table of the percentage composition of the encrustation from the teeth of man, sheep, ox, camel, dromedary, and rhinoceros and, for comparison, the analyses of the cement layer (crusta petrosa) of the teeth of the babirusa, ox, and camel. He points out the very interesting fact that the tartar has much the same composition as mammalian bone.

The rhinoceros and babirusa encrustations differ from the others by containing very little calcium phosphate, although in lustrous flakes like that of the sheep and ox; in man it is chalky-looking without the metallic or nacreous lustre.

The coating may vary from a thin film to a quarter of an inch in thickness; the black coating common on the teeth of sheep and oxen has the same composition as the "metallic" deposits. The teeth of carnivora and rodents are usually very clean except when old, and so are those of pigs; those of snakes, lizards, and fish are free from deposit; it is present on the teeth of the crocodile and killer-whale, and also on teeth of the tapir, eland, bison, bears, and most of the Australian marsupials, including the fossil marsupial teeth from the Wellington Cave, New South Wales. Mr. Steel refers to the huge projecting teeth observed by Miklouho-Maclay in natives of Taui or Admiralty Islands (*NATURE*, vol. xvi., 1877, p. 251), due to an enormous deposit of tartar caused by chewing betel-nut and lime; the percentage of lime found in it by Salkowski was more than 45 per cent. (*Nehr. Berlin. Ges. Anthropol.*, 1881, p. 219).

The investigation shows a large amount of very careful and painstaking work, and should be of interest to anatomists and dentists, especially as the alleged occurrence of gold or pyrites on teeth has been reported again and again for centuries, and will probably continue to be so reported from time to time.

The History of Metamorphic Insects.

REFERENCE has been made in *NATURE* to most of the series of remarkable entomological papers which Dr. R. J. Tillyard has communicated during the last few years to the Linnean Society of New South Wales, and which have been published in that society's Proceedings (vols. xli.-xliv.). These papers are worthy of the most careful attention of students of insects, because the author combines the power of intensive research into details of structure with a true instinct for those details that are of real importance in the elucidation of relationships, and with a broad morphological outlook on the group under consideration. He has the faith—which many of our younger naturalists, shut in to the study of the inheritance of varietal and specific characters, lack—that a knowledge of the phylogeny of large systematic groups is attainable, but he realises that such knowledge can come only through a careful comparison of recent adult and immature with extinct forms. Thus his evolutionary speculations are raised on surer foundations than those which contented many of his predecessors.

Attention may be especially directed to Dr. Tillyard's exposition of the wing-venation of the group of orders which he terms the "Panorpid complex" (*Proc. Linn. Soc., N.S.W.*, vol. xlv., part 3, 1919), this group comprising the Neuroptera (Planipennia and Megaloptera), Mecoptera, Trichoptera, Lepidoptera, and Diptera, together with three extinct (Permian or Triassic) orders, the Paramecoptera, Protomecoptera, and Paratrachoptera, the types of which were described by the author from Australian fossils. Wing-venation has been generally regarded as a trustworthy guide to the affinities of the families and orders of insects, but entomologists lacked a reasonable morphological interpretation of the complicated array of facts until Comstock and Needham showed how the correspondence of the main series of longitudinal nervures could be traced through members of various orders, the detection of homologies being greatly facilitated by a study of the tracheal tubes which provisionally mark out the venation in the nymphal or pupal wing. Dr. Tillyard adopts generally the Comstock homologies and nomenclature, but his opportunities of studying archaic

Australasian forms of the Neuroptera and Mecoptera, both in the adult and pupal stages, have enabled him to suggest amendments which may be expected to win general acceptance. His insistence on the importance of the earliest pupal tracheation, and on the recognition of the longitudinal nervures by the presence of characteristic strong bristles (the *macrotrichia*), which are absent on the cross-nervules, and the scars of which can be distinguished in fossil wings, is particularly weighty.

The three extinct orders mentioned above are regarded by Dr. Tillyard as arising collaterally with the Mecoptera and Neuroptera in Permian times, one Permian fossil (*Permochorista*) from the coal-beds of New South Wales being definitely referred to the Mecoptera, and another (*Belmontia*) from the same beds to the new order Paramecoptera (see Proc. Linn. Soc., N.S.W., vol. xlv., part 2, 1919); while *Protopsychoptis* and *Archpsychoptis* from the Upper Trias of Queensland are classed with the planipennian Neuroptera, the Lower Triassic *Triadosialis*—a

European (German) fossil—standing near the base of the megalopteroid group. The extinct Paramecoptera are believed by Dr. Tillyard to be ancestral to both the Trichoptera and the Lepidoptera, while Upper Triassic fossils from Queensland (*Aristopsyche*, etc.) belonging to the Paratrachoptera suggest that this latter order gave rise to the Diptera (see *t.c.*, part 1, 1919).

From this summary it will be realised that all the principal orders of metabolous insects (the Endopterygota of Sharp), with the exception of the Coleoptera and the Hymenoptera, are brought into a series of reasonably probable relationships. Even if later discoveries may compel some modifications in the details of Dr. Tillyard's genealogical scheme, it seems impossible to doubt that he is on the track of real affinities, and that the other two great metamorphic orders, the beetles and the Hymenoptera, will ultimately be shown to have such relationship to this "Panorpid complex" that the whole endopterygote assemblage cannot but be regarded as forming a natural monophyletic group.

G. H. C.

Oil in Western Sinai.

By H. B. MILNER.

THE opening up of a new petroliferous region in any country is usually a matter of more than ordinary interest, not only to oil technologists, but also to the general business public. In Western Sinai we recognise one of the latest developments of oilfield enterprise, and from our knowledge of the Egyptian fields (to which this new region is geologically similar), as well as from the data published by the Petroleum Research Expedition of Egypt in a Preliminary General Report on Western Sinai (Cairo: Government Press, 1920), the prospects in this part of the peninsula would seem to be exceedingly promising.

For some time past it has been known from surface and other indications that the tract of country stretching southwards from Suez along the western coast of Sinai is petroliferous in many places, but it has remained for Dr. Hume and his staff of geologists to carry out the necessary geological investigations in elucidation of the structure of the country and for the selection of the most favourable localities for drilling test wells.

The actual belt of country examined lies between Suez and El Tor, a distance of about 220 km. along the coast. Of the various localities at which oil indications are promising those of Abu Durba and Gebel Tanka seem to be pre-eminent, and in the former instance a well-site has already been fixed; in the Gebel Tanka area there are three separate oil prospects which have received attention, and two sites for deep test wells are indicated at present.

With regard to the relative geological positions of the various oil horizons within the belt, from the information supplied in the report it is evident that there are at least two of these, an upper situate between the Middle Eocene limestones and Lower

Miocene marls and a lower occurring at the junction of the Cretaceous beds with the underlying Nubian sandstones. In the Gebel Tanka area both the upper and lower horizons are present, but drilling to the lower oil-bearing strata is advocated, as the Eocene limestones are not deemed here to be profitable commercially. In the Abu Durba area only the lower horizon is present, but drilling would not be to such a depth as in the former case, as the Tertiary beds are absent.

Tectonically, so far as present evidence shows, two definite systems of folding have been established within this region, one known as the Hammam Faraun-Useit anticline and the other as the Gebel Araba anticline. The former is the more important feature from the oil point of view, since many of the reported indications (including those of the Gebel Tanka area) are associated with it. The latter is more doubtful in this respect, as the surface indications are less numerous, but it is evident that with progress in mapping a great deal more information will be obtained which should define the system with more precision, and thus indicate the chances of future exploration for oil in the sediments affected thereby.

Not only has the Petroleum Research Expedition done valuable work in reporting on the oil potentialities of this region; it has also made an important contribution to our geological knowledge of Western Sinai which, even if the oil prospect prove unfavourable, well warrants the survey made. Two other reports of the expedition (Bulletins 3 and 4) deal in greater detail with the oil occurrences at Gebel Tanka and Gebel Nezzazat (Sinai), and should be read in conjunction with the general report (Bulletin 2) described above.

Genetics of Cereals.

SINCE the well-known experiments of Biffen, in which the rust resistance of wheat to *Puccinia glumarum* was shown to behave as a simple Mendelian recessive character, numerous amplifying investigations have taken place. In Swedish experiments Nilsson-Ehle obtained less regular results,

finding usually a lack of dominance and segregation in indefinite ratios. In the meantime, extensive studies have been made of the black stem-rust, *Puccinia graminis tritici*, which causes enormous losses in American wheat crops. It has been shown that numerous biologic forms of this fungus exist

which differ in their action on particular wheat varieties. Rust nurseries have been established for isolating, and experimenting with the effects of, various races of rust. It was found that numerous biologic forms of this fungus sometimes existed in the same locality, a wheat variety being susceptible to some and resistant to others. This greatly complicates the work of breeding for rust resistance, but an emmer wheat from India has been found to be resistant to all forms of rust yet encountered. The conception of bridging species, or the modification in virulence of a fungus by growth on an intermediate host, is being discredited by the further investigation of these biologic races.

In a recent paper by Messrs. H. K. Hayes, J. H. Parker, and C. Kurtzweil (*Journ. Agric. Research*, vol. xix., No. 11) the authors studied the inheritance of rust resistance and its correlation with botanical characters in crosses between *Triticum vulgare* and varieties of *T. durum* and *T. dicoccum*. To eliminate the presence of different biologic races of the fungus, all barberry bushes were eradicated and the wheat-plants sprayed with spores from the rust nursery. The common wheats, such as Marquis, were susceptible, the durums, such as Kubanka, "commercially resistant," while the emmer varieties were practically immune. In crosses between emmer and common wheats resistance was found to be partially dominant, while in crosses between durum and common wheats susceptibility was completely dominant. In F_2 and F_3 generations segregation occurred, with indications of linkage between durum or emmer head characters and rust resistance. Some of the resistant types obtained were more resistant than the original parents. This study contains a number of other valuable observations.

In connection with the work of Engledow (referred to in NATURE of September 30, 1920, p. 158) on the lateral florets of barley, it was shown that *Hordeum intermedium Haxtoni*, which is intermediate between two-rowed and six-rowed barley in the fertility of its lateral florets, occurs as a homozygous form which will breed true, and that it represents a unifactorial difference from *hexastichum*. The production of *Haxtoni* in a number of crosses is described by H. V. Harlan and H. K. Hayes (*Journ. Agric. Res.*, vol. xix., No. 11), and an explanation of the difference between two-rowed and six-rowed barley on a two-factor hypothesis is suggested. The six-rowed barleys are believed to be homozygous for the presence of an epistatic factor, the *intermedium* homozygous for the absence of the epistatic factor and for the presence of the hypostatic factor, the two-rowed barleys being homozygous for the absence of both factors. R. R. G.

University and Educational Intelligence.

MR. A. R. HINKS, the Gresham lecturer on astronomy, will deliver a course of four free public lectures on "Recent Work on the Nebulæ" at Gresham College, Basinghall Street, E.C.2, on April 26-29 at 6 o'clock.

THE Vienna correspondent of the *Lancet* states that by an Order of the Austrian Board of Education the fees payable by students of the medical faculties of Austrian universities have been increased in such a way that for this summer term and onwards foreigners will have to pay more heavily than Austrians. For graduation the increase for foreigners is 1000 per cent. of the present fee, while for tuition, etc., an increase of 2500 per cent. is to be made; the general increase

for Austrian students will be 50 per cent. The object of this preferential treatment is to compensate in part for the rate of exchange, which is now so favourable to foreigners, but the foreign student will still be able to study at a very small expenditure, for it is calculated that classes of four and six hours weekly will cost only 8s. and 12s. respectively per term. The increase was also rendered necessary by the action of the Rockefeller Foundation in making their grant of 60,000 dollars conditional on increasing the fees of foreign students. It was considered unjust that an impoverished State should enable foreign students to obtain a first-class medical education at a cost far below that of equivalent education in their own countries.

THE foundation-stone of the new University of Lucknow was laid on Saturday, March 19, by Sir Harcourt Butler, Lieutenant-Governor of the United Provinces (*Pioneer Mail*, March 25). An address of welcome was presented by the Vice-Chancellor, Rai G. A. Chakravarty Bahadur, in the course of which it was mentioned that an attempt would be made to resuscitate national ideals in the new University. After laying the foundation-stone Sir Harcourt Butler delivered an address, paying eloquent tribute to the generosity of the people of Oudh which had made possible the foundation of a university. He said that whereas at the convocation speeches at Allahabad University he had urged the importance of scientific training and research, at Lucknow, an ancient centre of literature and poetry, he made a special plea for the study of the humanities. The University should be organised according to modern ideas, which in many particulars, such as in teaching and residence, conform with indigenous ideals of education. On March 21, when the first annual meeting of the court of the University was held under the presidency of the Vice-Chancellor, it was announced that a sum of nearly 30 lakhs of rupees had been promised in subscriptions.

THE President of the Board of Education has constituted an Adult Education Committee to promote the development of liberal education for adults, and in particular to bring together national organisations concerned with the provision of adult education, so as to secure mutual help and prevent overlapping and waste of effort; to further the establishment of local voluntary organisations for the purpose and of arrangements for co-operation with local education authorities; and to advise the Board of Education upon any matters which the Board may refer to the Committee. The members of the Committee are:—The Bishop of Manchester (chairman), Dr. J. G. Adami, Alderman F. Askew, Mr. C. W. Bowerman, M.P., the Rev. D. H. S. Cranage, Lord Gorell, Mr. B. S. Gott, Prof. J. A. Green, Miss Grace Hadow, Mr. Alfred Holmes, the Rev. F. E. Hutchinson, Prof. F. B. Jevons, Prof. J. Harry Jones, Mr. C. L. Kingsford, Mr. John Lea, Mr. J. M. Mactavish, Mr. Albert Mansbridge, Prof. J. H. Muirhead, Sir Isambard Owen, the Rev. R. St. J. Parry, Lt.-Col. H. A. Powell, Mr. W. R. Rae, Sir Harry R. Reichel, Mr. Arnold Rowntree, Mr. A. L. Smith, Mr. R. H. Tawney, Mr. G. Thompson, Mr. H. Pilkington Turner, Dr. R. Mullineux Walmsley, Miss Phebe Walters, and the Rev. Basil A. Yeaxlee. Mr. C. O. G. Douie, an assistant principal under the Board of Education, is secretary. Mr. E. K. Chambers and Col. M. Earle will attend meetings on behalf of the Board of Education and the Army Council.

Calendar of Scientific Pioneers.

April 21, 1793. John Michell died.—A fellow of Queens' College, Cambridge, Michell became a clergyman, and in 1762 was appointed Woodwardian professor of geology in the University of Cambridge. Magnetism, electricity, and astronomy all engaged his attention, and shortly before his death he devised the apparatus afterwards used by Cavendish to measure the density of the earth.

April 21, 1825. Johann Friedrich Pfaff died.—The friend of Schiller and the rival of Gauss, Pfaff studied mathematics under Kästner and worked at astronomy with Bode. His original researches were mainly in the domain of the calculus and differential equations. Pfaff was born in 1765. From 1788 to 1810 he was professor of mathematics at Helmstadt, and from 1810 onwards held the chair of mathematics at Halle.

April 23, 1874. John Phillips died.—In his youth the constant companion of his uncle, William Smith, the geologist, Phillips held the chairs of geology at King's College, London, at Dublin, and at Oxford. For his contributions to geology and palæontology he received the Wollaston medal from the Geological Society, which he served as president during 1859-60.

April 25, 1840. Siméon Denis Poisson died.—Poisson all his life—first as student, then as professor and examiner—was connected with the Ecole Polytechnique, where he gained the friendship of Lagrange, Laplace, and Legendre. Besides his separate works he published some three hundred memoirs, the chief of which are on the theory of electricity and magnetism and on celestial mechanics. Always working, he replied to one who urged him to rest: "La vie: c'est le travail."

April 25, 1882. Johann Carl Friedrich Zöllner died.—Well known for his investigations in photometry, spectrum analysis, and the constitution of the sun, Zöllner from 1872 was professor of physical astronomy at Leipzig.

April 25, 1914. Eduard Suess died.—Born in London in 1831, Suess was educated at Prague and at Vienna, where at the age of twenty he entered the Imperial Museum. In 1867 he became professor of geology in Vienna University. His great treatise, "Das Antlitz der Erde," which occupied him twenty-five years, was a comprehensive survey of all that had been accomplished in elucidating the geological structure of the earth. He held various public offices, and served as president of the Academy of Sciences of Vienna.

April 26, 1835. Henry Kater died.—Joining the Army as an ensign in 1794, Kater for a time assisted Lambton on the Trigonometrical Survey of India. Placed on half-pay in 1814, he devoted himself to scientific pursuits, and was especially known for his pendulum experiments, his work on weights and measures, and his invention of the floating collimator.

April 26, 1920. Srinivasa Ramanujan died.—Distinguished for his researches in pure mathematics, Ramanujan was the first Indian fellow of the Royal Society. A Brahmin by caste, he was born at Erode in 1887, became a student at Madras University, and was enabled to spend the years 1914-19 in England, where his brilliant work led to his being elected F.R.S. in 1918. He died at Chetput, Madras.

April 27, 1521. Ferdinand Magellan died.—The contemporary of Columbus and Vasco da Gama, Magellan—or Magalhães—came of a noble Portuguese family. Sailing from Portugal in September, 1519, towards the end of 1520 he discovered the strait that bears his name and so reached the Pacific. He met his death in a fight with natives in the Philippines.

E. C. S.

Societies and Academies.

LONDON.

Royal Microscopical Society, March 16.—Prof. John Eyre, president, in the chair.—J. H. Pledge: The use of light-filters in microscopy. The advantages gained are: control of contrast in the stained and the coloured preparations from both the visual and the photographic points of view; aid in resolution of fine structure; improvement in the definition given by ordinary achromatic objectives; modification of the unpleasantness to the eye of artificial-light sources by "equivalent daylight" filters; and the possibility of moderating the intensity of illumination of the microscopic field by light-filters of neutral tint of suitable density. Forms of light-filters mostly in use are chiefly dyed gelatine cemented between protecting cover-glasses, but dye solutions in glass-cells are also used. To obtain maximum contrast a light-filter complementary in colour to that of the preparation should be used.

Faraday Society, March 22.—Prof. A. W. Porter, president, in the chair.—Prof. A. W. Porter: Presidential address: Some aspects of the scientific work of the late Lord Rayleigh. The experimental part of Rayleigh's work could be divided into that requiring elaborate apparatus and laborious application, and investigations in which the apparatus was of the simplest kind. The latter was a type of investigation in which Rayleigh specially delighted. His mathematical work was always looking forward to its applications. Illustrations were given of the great use he made of the method of dimensions when problems (especially those in hydrodynamics) cannot be yet solved in any other way. His work on intrinsic pressure was outlined and contrasted with more recent work of the Dutch school of physicists. Finally, his mentality was further characterised by references to his excursions into problems dealt with by the Society of Psychical Research. His position was summed up by saying that although Rayleigh founded no school, yet he so advanced knowledge of physics in all its branches as to stand out as one of the leaders in scientific achievement.—S. Field: The electrolytic recovery of zinc. Abundant supplies of low-grade and complex ores are available in Great Britain which are not amenable to distillation, but respond readily to electrolytic treatment. Sulphide ores are calcined to oxide and a predetermined proportion of sulphate. The calcine is leached with acid zinc sulphate liquors from the electrolytic cells. Special treatment avoids gel formation, and admits of high extraction and easy filtration. The zinc sulphate solution is too impure for efficient deposition. The methods of purification worked out are given in some detail. Ni and Co constitute two commonly met and insidious impurities. The purified liquors containing not more than 3 to 5 parts Co and 0.2 part Ni per 1,000,000 are acidified and electrolysed between lead anodes and aluminium cathodes. The cells, arranged in cascade, absorb 3.35 volts and give a current efficiency of 90 per cent., representing about 3200 k.w.h. per ton of zinc cathodes. Subsidiary power is amply covered by 800 k.w.h. per ton; 4000 k.w.h. covers all power. At 0.33d. per unit, power costs are 5l. 11s. per ton of cathode zinc. The cathodes are melted and yield ingots assaying at least 99.95 per cent. of zinc.—Prof. A. Findlay and V. H. Williams: Note on the electrolytic reduction of glucose. The authors have studied the electrolytic reduction of glucose under varying conditions of temperature, current density, and current concentration, and using both graphite and lead electrodes. No appreciable amount of hexa-

hydric alcohol was obtained, the reduction being apparently interfered with by the production of formic acid and a pentose.—W. E. Hughes: The forms of electro-deposited iron and the effect of acid upon its structure. Part i.: Deposits from the chloride bath. Structures found in iron deposits formed in chloride baths are varieties of two general types, the normal and the fibrous. The type obtained depends upon conditions prevailing during deposition, the fibrous type being characteristic of deposits formed in (a) acid and (b) agitated solutions. Macroscopic features correspond to definite microscopic structure.

Zoological Society, April 5.—Prof E. W. MacBride, vice-president, in the chair.—G. J. Arrow: A revision of the Melolonthine beetles of the genus *Ectinohoplia*.—J. H. Lloyd: Abnormalities in the common frog (*Rana temporaria*).—S. Hirst: Some new and little-known Acari, mostly parasitic in habit. The author illustrated his paper by exhibiting under microscopes (1) a preparation of a Sarcoptid mite (*Otodectes cynotis*, var. *cati*) showing the well-developed system of tracheal tubes, and (2) a preparation of the mite (*Tarsonemus Woodi*) from bees affected with Isle of Wight bee disease.—Dr. C. F. Sonntag: The comparative anatomy of the tongues of the Mammalia. III., Fam. 2, Cercopithecidae: with notes on the comparative physiology of the tongues and stomachs of the Langurs.

Linnean Society, April 7.—Dr. A. Smith Woodward, president, in the chair.—H. W. Monckton: The distribution of *Taraxacum erythrospermum*, Andr., in the south-east of England. The author explained that he had for some years noticed a small form of dandelion with deeply cut leaves and red seed growing abundantly on a football ground at Wellington College, Berkshire. It belongs to the group of varieties named *erythrospermum*. The geological formation is Upper Bagshot Sand (Barton Beds). He had seen the same variety on the similar sandy soil of Puttenham Heath, Surrey (Lower Greensand), on the Thames Gravel near Old Windsor, Berkshire, and on walls at West Drayton and other places. It is not confined to areas of sand or gravel, for the author exhibited specimens from the London Clay of Ashted Common, near Epsom, Surrey.—R. A. Malby: A miniature alpine garden from January to December. Amongst the subjects shown in lantern-slides by the lecturer may be mentioned *Saxifraga Burseriana*, *S. Grisebachii*, *S. Striburyi*, *S. longifolia*, *S. Cotyledon*, var. *islandica*, *Anemone vernalis*, *A. sulbhurea*, *Nymphaea Mooreana*, *Primula frondosa*, *P. denticulata*, *P. marginata*, *P. Juliae*, *Iris sibirica*, *I. gracilipes*, *Campanula Allionii*, *C. pusilla*, *C. garganica*, *Shortia galacifolia*, *S. wulfra*, *Petrocallis pyrenaica*, *Crocus speciosus*, *Narcissus Johnstoni*, *N. monophyllus*, *N. triandrus*, *N. minimus*, *Oxalis enneaphylla*, and *O. lobata*.

Physical Society, April 8.—Mr. W. R. Cooper in the chair.—Dr. W. J. H. Moll: A new registering microphotometer. A diminished image of a slit, on which the filament of a half-watt lamp is focussed, is projected by a microscope objective on the photographic plate or other object of which the absorption is to be measured. A second similar objective focusses an image of the slit, magnified up to its original size, on a second slit behind which is mounted a sensitive thermopile of the author's own design connected to an improved D'Arsonval galvanometer. The photographic plate is given a slow motion at right angles to the beam of light, and the spot from the galvanometer is focussed on a rotating drum of photographic paper. The arrangement is dead beat and so quick in response that intensity curves of close spectrum

lines, Zeeman triplets, etc., are accurately recorded.—Sir W. H. Bragg: Application of the ionisation spectrometer to the determination of the structure of minute crystals. Crystals in the form of powder can be examined by the ionisation method. The powder is pasted on a flat surface and placed on the spectrometer table in the position ordinarily occupied by the face of a single crystal. A bulb current of 1 milliampere is sufficient to give satisfactory records.—H. Parry: A balance method of using the quadrant electrometer for the measurement of power. The method involves the use of a potential-divider across the supply circuit, and a standard non-inductive resistance in series with the load. An ammeter and a voltmeter are employed to measure the supply voltage and the load current.

DUBLIN

Royal Dublin Society, March 22.—Dr. F. E. Hackett in the chair.—H. A. Lafferty: The "browning" and "stem-break" disease of cultivated flax caused by *Polyspora lini*, n. gen. et sp. In the "stem-break" phase of the disease the stems of affected plants become partially or entirely broken across a little above ground-level comparatively early in the season, and affected plants generally fall over and die prematurely. In "browning" the upper portions of the plants in particular exhibit numerous diseased areas; this takes place about pulling time. A fungus, *Polyspora lini*, n. gen. et sp., was isolated, and proved to be the cause of both phases of the disease. The seed is also attacked, and transmission of the disease occurs by sowing infected seed. The fungus is widely distributed. No means of carrying out seed disinfection on a practical scale have been devised.—H. H. Poole: The electrical conductivity of some dielectrics. A large, steady potential difference obtained by thermionic rectifying valves was applied to the opposite faces of a thin sheet of the dielectric which was kept at a constant known temperature in an oven. The potential difference was measured by a rotating contact-maker, alternately charging a small condenser and discharging it through a dead-beat galvanometer. The conduction current was measured by a sensitive galvanometer. The logarithm of the electrical conductivity when plotted against the potential gradient gave a set of right lines, corresponding to different temperatures, in the case of glass. With mica a greater range of gradient was available, and the lines exhibited slight curvature.

PARIS.

Academy of Sciences, March 29.—M. Georges Lemoine in the chair.—M. Hamy: The approximation of functions of large numbers.—C. Depéret and P. Fallot: The age of the lignite formations of the Island of Majorca.—C. E. Guillaume: The compulsory adoption of the metric system by the Japanese Empire. The metric system has been legal in Japan since 1893, and is now compulsory. The system will also be adopted shortly in China and Siam.—C. E. Traynard: Certain singular hyper-elliptic surfaces.—J. Andrade: The optical determination of rolling resistance.—P. Le Rolland: The movement of a pendulum with elastic suspension.—L. and E. Bloch: Some spark spectra in the extreme ultra-violet. The ultra-violet spark spectra of zinc, cadmium, and lead are given for wave-lengths between the limits 1850 and 1400.—M. de Broglie: Corpuscular spectra. The laws of photo-electrical emission for high frequencies.—L. Bull: The brightness of the electric spark. The photometric method based on the photographic comparison with an electric arc is used, taking the duration of the spark exposure as 1/500,000 second. The actinic

intensity of the spark is not less than 160 times that of the electric arc.—**M. Dussaud**: An apparatus for projecting an image of any object on a screen 3 metres square in a lighted room, with a current of 3 amperes.—**P. Jolibois**: A photographic method of registering chemical reactions accompanied by a variation in pressure. The mercury manometer tube has a fine platinum wire stretched throughout its length, and the variations in the resistance of this wire serve as a measure of the height of the manometer. The temperature at which the reaction under study is proceeding is measured by a thermo-couple, and the double galvanometer of Le Chatelier and Saladin is employed to record the temperature and pressure simultaneously. Some possible applications are described.—**H. Joly**: The geology and physical geography of the Rio Guadiato depression (Sierra Morena, Spain). This depression is due to the tectonic structure of this part of the Sierra Morena, which recalls that of the Franco-Belgian coal basin.—**A. Carpentier**: Discovery of the genus *Plinthiotheca* in the Westphalian in the north of France.—**J. de Vilmorin**: The crossing of peas with coloured pods.—**A. A. Mendes-Corrêa**: Some sexual differences in the skeleton of the superior limbs. A discussion of the problem of determining the sex of a skeleton.—**M. Doyon**: The physiological properties of the nucleic acids of the lymphatic ganglia and of the thymus. The conditions for obtaining a thymo-nucleic acid very active on blood. The lymphatic ganglia of the ox and the thymus glands of the calf are specially recommended as sources of nucleic acids. Full details of the technique of extraction are given.—**J. Legendre** and **A. Oliveau**: The rôle of the domestic rabbit in the attraction and nutrition of *Anopheles maculipennis*. This *Anopheles* during its period of activity in the spring seeks the blood of mammals as food, with a marked preference for the blood of the domestic rabbit. In the presence of man, cattle, horses, pigs, fowls, and rabbits, the preference for the rabbit amounts to protection for man and other animals.

ROME.

Reale Accademia nazionale dei Lincei, January 2.—**Prof. V. Volterra**, vice-president, in the chair.—**G. Ciamician** and **C. Ravenna**: Influence of organic substances on plant development. The substances experimented on include pyrocatechin, guaiacol, morphine, codeine, theobromine, caffeine, atropine, and cocaine.—**B. Grassi**: Can *Anopheles* propagate malaria directly? At Fiumicino a baby a few months old caught malaria in a house visited eight days previously by an infected youth. In another case a woman recovering from the fever was visited by two friends, who stayed only a few hours in the house, but developed symptoms on returning to Rome. From examinations of the *Anopheles* in the district the author considers it doubtful whether infection could have taken place otherwise than by direct transmission, and hopes to test the matter by experiment with some individual who is willing to undergo the necessary tests.—**F. Bottazzi**: The posterior salivary gland of the Cephalopod, iv. Secretive activity of the gland under various experimental conditions.—**O. Lazzarino**: Equations of rotation about a fixed point of a solid with cavities filled with viscous liquids.—**C. Severini**: Integral equations.—**L. Tonelli**: Two propositions of Lindeberg and Levi in the calculus of variations, i.—**V. Sabatini**: Unity of the Vulsinio system. This system consists principally of two large craters, one of Latera and the other of Bolsena, the latter having no equally large counterpart in Europe. The probability of these having a common focus or communicating foci appears better justified than in the

parallel case of the Cimini system.—**G. Cotronei**: Causal morphology of eye development in the toad.—**E. Remotti**: Variations in the specific weight of eggs of Teleosteans during development in shallow or deep water.—**S. Sergi**: Vertebro-medullary topography of chimpanzee, ii.—**Prof. Castelnovo** was elected secretary of the Academy.

January 16.—**Prof. F. D'Ovidio**, president, in the chair.—**G. Pellizzari**: Synthesis of *o*-phenylenedicyanoguanidine from *o*-phenylenediamine.—**A. Comessatti**: Geometric theory of binary forms, iv. Typical representation of co-variants.—**S. Lefschetz**: "Sur le théorème d'existence des fonctions abéliennes."—**G. Castelnovo**: Abelian functions, i. Intermediary functions.—**E. Bompiani**: Metric invariants and co-variants in deformations of surfaces, iv.—**R. Serini**: Dirichlet's symmetrical cylinder problem.—**N. Paravano** and **C. Mazzetti**: Transformation of light into heavy magnesia. It is found that the change takes place at comparatively low temperatures, but the rate of transformation increases continuously with increase of temperature.

February 6.—**Prof. V. Volterra**, vice-president, in the chair.—Original contributions by fellows:—**C. Segre**: Foci of second order of infinite systems of planes, and hyperspatial curves with a double infinity of plurisecant planes.—**G. Ciamician** and **R. Ciusa**: Constitution of benzol and heterocyclic nuclei.—**G. Bruni**: Solubility of crystalline substances in caoutchouc. Caoutchouc can be regarded as a thick liquid and its solvent power varies, being greatest for the aromatic series and least for minerals. Vulcanised rubber has the character of a saturated solution of sulphur in presence of free sulphur.—**F. Millosevich**: Minerals of Latian province. During excavations in the Peperino at Albano melilite was discovered in some blocks in crystals of somewhat exceptional purity.—Papers communicated by fellows:—**Prof. A. Lo Surdo**: Synthetic helium and neon.—**Dr. M. Ferrari**: Beryl from Piona (on the left bank of the Lake of Como near Colico).—**C. Jucci**: Uratic deposits in the fat of Termites.—The chairman, **Prof. Volterra**, announced the death of **Prof. Giuseppe Colombo** on January 16. The Academy has also lost the foreign fellows, **Profs. Waldeyer** and **Federow**. **Prof. Mattiolo** contributed a notice of the work of the late **Prof. Pier Andrea Saccardo**. For the Royal prize for astronomy four candidates submitted lists of papers. The chairman announced that a prize had been offered by the King in commemoration of the late **Prof. Augusto Righi** for the best work on experimental physics contributed by one of **Prof. Righi's** former pupils at Bologna.

Books Received.

Tidal Power. By **A. M. A. Struben**. (Pitman's Technical Series.) Pp. xii+115. (London: Sir I. Pitman and Sons, Ltd.) 2s. 6d. net.

Continuous Wave Wireless Telegraphy. By **Prof. W. H. Eccles**. Part i. Pp. vii+407. (London: Wireless Press, Ltd.) 25s. net.

Social Decay and Regeneration. By **R. Austin Freeman**. Pp. xx+345. (London: Constable and Co., Ltd.) 18s.

The Alpha, Beta, Gamma Navigation Tables. By **H. B. Goodwin**. Pp. iv+54. (London: J. D. Potter.) 8s.

Annuaire de l'Académie Royale des Sciences, 1921. Pp. 452. (Bruxelles: M. Lamertin.)

Diagnosis of Protozoa and Worms Parasitic in Man. By **Prof. R. W. Hegner** and **Prof. W. W. Cort**. Pp. 72. (Baltimore, Md.: Johns Hopkins University.)

British Museum (Natural History). British Antarctic (*Terra Nova*) Expedition, 1910. Natural History Report: Zoology. Vol. iii., No. 7, Crustacea. Part v., Ostracoda. By R. W. Barney. Pp. 175-90. 4s. 6d. Vol. iii., No. 8, Crustacea. Part vi., Tanaiacea and Isopoda. By Dr. W. M. Tattersall. Pp. 191-258+xi plates. 21s. Vol. vi., No. 1, Protozoa. Part i., Parasitic Protozoa. By Dr. H. M. Woodcock and Olive Lodge. Pp. 24+3 plates. 9s. (London: British Museum (Natural History).)

Relativity, the Electron Theory, and Gravitation. By E. Cunningham. (Monographs on Physics.) Second edition. Pp. vii+148. (London: Longmans, Green and Co.) 10s. 6d. net.

A Text-book of Botany for Medical and Pharmaceutical Students. By Prof. J. Small. Pp. x+681. (London: J. and A. Churchill.) 25s. net.

Chromium Ore. By W. G. Rumbold. (Imperial Institute Monographs on Mineral Resources, with Special Reference to the British Empire.) Pp. ix+58. (London: J. Murray.) 3s. 6d. net.

Freshwater Fishes and How to Identify Them. By Dr. S. C. Johnson and W. B. Johnson. Pp. 64. (London: The Epworth Press.) 1s. 9d. net.

Ministry of Public Works, Egypt: Physical Department. Meteorological Report for the Year 1915. Pp. x+122. (Cairo: Government Press.) P.T.30.

Department of Agriculture and Technical Instruction for Ireland: Fisheries Branch. Scientific Investigations, 1920. No. 2, Sponges of the Coasts of Ireland. By Jane Stephens. II.: The Tetraxonida (concluded). Pp. 75+vi plates. (Dublin and London: H.M. Stationery Office.) 3s. net.

Studies in the History and Method of Science. Edited by Charles Singer. Vol. ii. Pp. xxii+559+iv plates. (Oxford: Clarendon Press.) 48s. net.

Parallaxes of 260 Stars derived from Photographs made at the Leander McCormick Observatory. By Prof. S. A. Mitchell and others. Pp. v+695. (New York: Columbia University Press.)

The British Freshwater Rhizopoda and Heliozoa. Vol. v., Heliozoa. By G. H. Wailles. Pp. xi+72+plates lxiv-lxxiv. (London: Ray Society.)

A Handbook on Cotton and Tobacco Cultivation in Nyasaland. A Guide to Prospective Settlers. By J. Stewart J. McCall. Pp. 85. (Zomba: Government Printer.)

British Museum (Natural History). No. 7, Report on Cetacea Stranded on the British Coasts during 1919 and 1920. By Sir S. F. Harmer. Pp. 18. (London: British Museum (Natural History).) 4s.

Primitive Society: The Beginnings of the Family and the Reckoning of Descent. By Dr. Edwin S. Hartland. Pp. v+180. (London: Methuen and Co., Ltd.) 6s. net.

Electrical Engineering. By Dr. T. F. Wall. Pp. xi+491. (London: Methuen and Co., Ltd.) 21s.

Vocational Chemistry for Students of Agriculture and Home Economics. By Prof. John J. Willaman. (Farm Life Text Series.) Pp. ix+294. (Philadelphia and London: J. B. Lippincott Co.) 8s. 6d. net.

Agricultural Economics. By Prof. James E. Boyle. (College Texts: Agriculture.) Pp. ix+448. (Philadelphia, Chicago, and London: J. B. Lippincott Co.) 12s. 6d. net.

Ministry of Munitions and Department of Scientific and Industrial Research. Technical Records of Explosives Supply, 1915-18, No. 1. Recovery of Sulphuric and Nitric Acids from Acids used in the Manu-

facture of Explosives: Denitration and Absorption. Pp. viii+56. (London: H.M. Stationery Office.) 12s. 6d. net.

The Dynamics of the Airplane. By Prof. Kenneth P. Williams. (Mathematical Monographs, No. 21.) Pp. viii+138. (New York: J. Wiley and Sons, Inc.; London: Chapman and Hall, Ltd.) 13s. 6d. net.

The Elements of Theoretical and Descriptive Astronomy. By Charles J. White. Eighth edition, revised by Paul P. Blackburn. Pp. xi+309+ix plates. (New York: J. Wiley and Sons, Inc.; London: Chapman and Hall, Ltd.) 17s. 6d. net.

Handbuch der Pharmakognosie. By A. Tschirch. Band III., Lieferung i. Pp. 64+i plate. (Leipzig: C. H. Tauchnitz.) 10 marks.

The Story Book of the Fields. By J. H. Fabre. Pp. 271. (London: Hodder and Stoughton, Ltd.) 8s. 6d. net.

The Tin Resources of the British Empire. By N. M. Penzer. (The Raw Materials of Industry.) Pp. x+358. (London: W. Rider and Son, Ltd.) 15s. net.

An Introduction to the Psychological Problems of Industry. By Frank Watts. Pp. 240. (London: G. Allen and Unwin, Ltd.) 12s. 6d. net.

University of London: Galton Laboratory for National Eugenics. Eugenics Lecture Series, xiii.: Side Lights on the Evolution of Man. By Karl Pearson. Pp. 27+vii plates. (London: Cambridge University Press.) 3s. net.

Kritische Bemerkungen zu den Grundlagen der Relativitätstheorie. By Prof. H. Dingler. Pp. 29. (Leipzig: S. Hirzel.) 3 marks.

Diary of Societies.

THURSDAY, APRIL 21.

- ROYAL INSTITUTION OF GREAT BRITAIN, at 3.—Prof. H. S. Foxwell: Nationalisation and Bureaucracy.
- ROYAL SOCIETY, at 4.30.—Prof. J. Joly: A Quantum Theory of Colour Vision.—Prof. A. V. Hill: The Energy involved in the Electric Change in Muscle and Nerve.—H. M. Kyle: The Asymmetry, Metamorphosis, and Origin of Flat Fishes.—T. L. Prankerd: Studies in the Cytology of the Statolith Apparatus in Plants, viewed in Relation to their Habit and Biological Requirements.
- ROYAL SOCIETY OF MEDICINE (Dermatology Section), at 5.
- LINNEAN SOCIETY, at 5.—Prof. K. Newstead: Some Observations on the Natural History of the Upper Shiri River, Nyasaland.
- LONDON MATHEMATICAL SOCIETY (at Royal Astronomical Society), at 5.—L. J. Mordell: Note on Papers by Mr. Darling and Prof. Rogers.—Pandit Oudh Upadhyaya: (1) Cyclotomic Quinquection; (2) A Generalisation of a Theorem of Booth.—C. Krishnamachary and M. Bhimasena Rao: Properties of Eulerian and Prepared Bernoullian Numbers.
- INSTITUTION OF MINING AND METALLURGY (Annual General Meeting) (at Geological Society), at 5.30.—F. W. Harbord: Presidential Address.
- CHILD-STUDY SOCIETY (at Royal Sanitary Institute), at 6.—Dr. J. E. Borland: The Musical Training of Children.
- THE CHEMICAL SOCIETY, at 8.—F. Challenger and C. F. Allpress: Organo-derivatives of Bismuth. Part iv.: The Interaction of the Halogen Derivatives of Tertiary Aromatic Bismuthines with Organo-derivatives of Magnesium and Mercury.—J. A. N. Friend: A Colloid Theory of the Corrosion and Passivity of Iron and of the Oxidation of Ferrous Salts.—G. T. Morgan and J. D. Smith: Researches on Co-ordination and Residual Affinity. Part iv.: The Constitution of Simple and Complex Cobaltic Quinoneoxime Lakes.—G. T. Morgan and H. Burgess: Non-aromatic Diazonium Salts. Part vi.: 3:5-Dimethylisooxazole-4-diazonium Salts and their Azo-derivatives.—E. de B. Barnett and J. W. Cook: Studies in the Anthracene Series. Part i.—J. B. Firth: Some Factors governing the Sorptive Capacity of Charcoal. Sorption of Ammonia by Coconut Charcoal.—N. V. Sidgwick and E. K. Ewbank: The Influence of Position on the Solubilities of the Substituted Benzoic Acids.—N. V. Sidgwick and W. M. Aldons: Influence of Position on the Solubility and Volatility of the Mono- and Di-nitrophenols.—N. V. Sidgwick and H. E. Rubie: The Solubility and Volatility of the Chloro- and Nitro-anilines and their Acetyl Derivatives.—G. A. R. Kon: The Formation and Stability of *spiro*-Compounds. Part iv.: The Formation of Ketones derived from Open-chain and Cyclic Glutaric Acids by the Thermal Decomposition of their Calcium Salts.—W. J. Jenkins: Interaction of Acetylene and Mercuric Chloride.

Part ii.—J. Read and H. G. Smith: Researches on Piperitone. Part i.: The Occurrence, Isolation, and Characterisation of Piperitone.

INSTITUTE OF METALS (at Sir John Cass Technical Institute), at 8.—Dr. W. R. Ormandy: Refractories.

RÖNTGEN SOCIETY (in Physics Theatre, University College), at 8.15.—Prof. A. M. Tyndall and E. G. Hill: A New Form of Stereofluoroscope.—Descriptions and Demonstrations of X-ray, Electrical, and Photographic Apparatus.—The British Thomson-Houston Co., Ltd.: A New Current Stabilising Device for Use with the Coolidge Tube; The Potter-Bucky Diaphragm.—H. B. Gough: Investigation in the Measurement of High Tension Currents.—Solus Electrical Co.: Rotating Deep Therapy Tube-holder; New Centrifugal Mercury Gas and Paraffin Interrupter; Pneumatic Cassette.—C. Andrews: X-rays and Propaganda.—R. S. Wright: The Episcopo.—Dr. L. Levy: Further Points in the Manipulation of Impex Plates.—A. E. Dean: New Interrupter.

FRIDAY, APRIL 22.

ASSOCIATION OF ECONOMIC BIOLOGISTS (in Botanical Lecture Theatre, Imperial College of Science), at 2.30.—W. A. Millard: Green Plant Matter as a "Decey" for Actinomycetes Scabies in the Soil.—E. H. Richards: The Action of Bacteria and Protozoa in Conserving the Nitrogen in Sewage.—G. P. Wiltshire: The Methods of Infection of the Apple Canker Fungus.

ROYAL SOCIETY OF ARTS (Indian Section), at 4.30.—Lt.-Col. Sir Edward W. M. Grigg: The Common Service of the British and Indian Peoples to the World (Sir George Birdwood Memorial Lecture).

ROYAL SOCIETY OF MEDICINE (Study of Disease in Children Section), at 5.

ROYAL COLLEGE OF SURGEONS OF ENGLAND, at 5.—Prof. A. Keith: Demonstration on the Contents of the Museum.

PHYSICAL SOCIETY OF LONDON (at Imperial College of Science), at 5.—W. N. Bond: The Effect of Viscosity on the Flow through an Orifice.—Dr. A. Griffiths and Constance H. Griffiths: The Viscosity of Water at Low Rates of Shear.—G. F. Partridge and B. S. Smith: A Method of Measuring Frequencies.

INSTITUTION OF MECHANICAL ENGINEERS, at 6.—Sir Richard T. Glazebrook: Limit Gauging.

SOCIOLOGICAL SOCIETY, SOUTH-EASTERN UNION OF SCIENTIFIC SOCIETIES, AND REGIONAL ASSOCIATION (Joint Meeting) (at Linnean Society), at 6.—G. Morris: The Saffron Walden Survey.

INSTITUTION OF ELECTRICAL ENGINEERS (Students' Section) (at Finsbury Technical College), at 6.30.—R. C. Hawkins: Searchlights as used for Coast Defence Work.

TECHNICAL INSPECTION ASSOCIATION (at Royal Society of Arts), at 7.30.—A. S. E. Ackermann: Physical Properties of Clay.

JUNIOR INSTITUTION OF ENGINEERS, at 8.—H. P. H. Anderson: Construction and Working of Marine Water-tight Doors.

ROYAL SOCIETY OF MEDICINE (Epidemiology and State Medicine Section), at 8.30.—Dr. W. M. Willoughby: Collated Experiences of Plague on Ships.

ROYAL INSTITUTION OF GREAT BRITAIN, at 9.—Sir James Walker: Electro-synthesis in Organic Chemistry.

SATURDAY, APRIL 23.

ROYAL INSTITUTION OF GREAT BRITAIN, at 3.—H. Y. Oldham: The Great Epoch of Exploration; (1) Portugal.

MONDAY, APRIL 25.

ROYAL SOCIETY OF MEDICINE (Special General Meeting), at 5.

ROYAL COLLEGE OF SURGEONS OF ENGLAND, at 5.—Prof. S. G. Shattock: Demonstration on Pathological Specimens in the Museum.

INSTITUTE OF ACTUARIES, at 5.—C. W. Kenchington: Modern Developments in the Methods of Industrial Assurance Valuations.

INSTITUTION OF ELECTRICAL ENGINEERS (Informal Meeting) (at Chartered Institute of Patent Agents), at 7.—C. L. Lipman and Others: Engineering in Russia.

ROYAL SOCIETY OF ARTS, at 8.—Dr. S. J. Lewis: Recent Applications of the Spectroscope and the Spectrophotometer to Science and Industry.

ROYAL SOCIETY OF MEDICINE (Odontology Section), at 8.—G. G. Campion and J. Millard: Some Notes on the Growth of the Face.

TUESDAY, APRIL 26.

ROYAL INSTITUTION, at 3.—Prof. A. Keith: Darwin's Theory of Man's Origin in the Light of Present-Day Evidence.

INSTITUTION OF CIVIL ENGINEERS.—Special General Meeting, at 5.15. Annual General Meeting, at 5.30.

ROYAL PHOTOGRAPHIC SOCIETY OF GREAT BRITAIN, at 7.—Chapman Jones: Memorial Lecture on the Life and Work of the late Sir William de Wiveleslie Abney.

ILLUMINATING ENGINEERING SOCIETY (at Royal Society of Arts), at 8.—W. J. Jones: Ship-lighting in Relation to Comfort, Safety, and Efficiency.

ROYAL ANTHROPOLOGICAL INSTITUTE, at 8.15.—A. Grimble: From Birth to Death in the Gilbert Islands.

WEDNESDAY, APRIL 27.

ROYAL INSTITUTION OF GREAT BRITAIN, at 3.—Prof. H. S. Foxwell: Nationalisation and Bureaucracy.

INSTITUTION OF PETROLEUM TECHNOLOGISTS (at Royal Society of Arts), at 5.30.—Dr. T. O. Bosworth: The Oilfields of Northern Canada.

ROYAL SANITARY INSTITUTE, at 5.30.—Col. C. H. Melville: Some Lessons of the War.

INSTITUTE OF PHYSICS (at Institution of Civil Engineers) (Inaugural Meeting), at 6.—Sir J. J. Thomson and Others: Addresses.

INSTITUTION OF AUTOMOBILE ENGINEERS (at Institution of Mechanical Engineers), at 7.—H. L. Heathote: The Ball Bearing—in the Making, under Test, and on Service.

ROYAL SOCIETY OF ARTS, at 8.—Sir James P. Hinohlife: Research in the Wool Industry.

EGYPT EXPLORATION SOCIETY (at Royal Society), at 8.30.—Prof. S. Langdon: Early Chronology of Sumer and Egypt and Similarities of their Culture.

THURSDAY, APRIL 28.

ROYAL INSTITUTION OF GREAT BRITAIN, at 3.

ROYAL SOCIETY, at 4.30.—*Probable Papers*.—Prof. H. Lamb and R. V. Southwell: The Vibrations of a Spinning Disc.—Dr. W. Rosenhain: The Hardness of Solid Solutions.—W. Hartree and Prof. A. V. Hill: A Method of Analysing Galvanometer Records.—F. H. Newman: A New Form of Wehnelt Interrupter.—T. L. Ibbs: Some Experiments on Thermal Diffusion.—B. N. Chakravarty: The Diffraction of Light Incident at Nearly the Critical Angle on the Boundary between Two Media.

INSTITUTION OF ELECTRICAL ENGINEERS (at Institution of Civil Engineers), at 6.—Discussion on Tariffs.—J. R. Blaikie: Electricity Supply—Present Conditions and the Hopkinson Principles.—J. W. Beauchamp: Multi-Part Tariffs for Domestic Electricity Supply.

ROYAL SOCIETY OF MEDICINE (Urology Section), at 8.30.

FRIDAY, APRIL 29.

ROYAL COLLEGE OF SURGEONS OF ENGLAND, at 5.—Prof. A. Keith: Demonstration on the Contents of the Museum.

INSTITUTION OF ELECTRICAL ENGINEERS (Students' Section) (at City and Guilds (Engineering) College) (Annual General Meeting), at 6.30.—A. C. Warren: Radio-telegraphic Transmitting Apparatus.

ROYAL INSTITUTION OF GREAT BRITAIN, at 9.—Sir Frank W. Dyson: Advances in Astronomy.

SATURDAY, APRIL 30.

ROYAL INSTITUTION OF GREAT BRITAIN, at 3.—H. Y. Oldham: The Great Epoch of Exploration; (2) Spain.

CONTENTS.

	PAGE
University Grants in the Civil Service Estimates	225
Colloidal Theory. By W. B. Hardy, F.R.S.	226
The Epistemological Problem. By Prof. H. Wildon Carr	228
Vertebrate Morphology. By F. W. G.	229
Ancient Metal Implements	230
Our Bookshelf	231
Letters to the Editor:—	
The Quantum Theory and Homogeneous Vibrations.—	
Sir Arthur Schuster, F.R.S.	233
Variegation in a Fern.—Dr. W. Bateson, F.R.S.	233
The "Flight" of Flying-fish. (<i>Illustrated.</i>)—Sir	
David Wilson-Barker; Prof. F. Wood-Jones	233
"Space" or "Ether"?—Dr. Norman R. Campbell; L. C. W. Bonacina	234
Meteors on the Moon.—J. W. Gordon, K.C.; Dr. Andrew C. D. Crommelin	234
Calendar Reform.—Alexr. Philip	235
The Hall of the Age of Man in the American Museum. (<i>Illustrated.</i>) By Prof. Henry Fairfield Osborn	236
The Rise and Development of the Sussex Iron Industry	240
Long-distance Telephony	241
Obituary	242
Notes	242
Our Astronomical Column:—	
Pons-Winnecke's Comet	247
Reid's Comet	247
Fixed Calcium Lines in Early Type Stars	247
The New Star of 1912—Nova Geminorum II. By Major William J. S. Lockyer	248
Gold-coloured Teeth of Sheep	249
The History of Metamorphic Insects. By G. H. C.	249
Oil in Western Sinai. By H. B. Milner	250
Genetics of Cereals. By R. R. G.	250
University and Educational Intelligence	251
Calendar of Scientific Pioneers	252
Societies and Academies	252
Books Received	254
Diary of Societies	255



THURSDAY, APRIL 28, 1921.

Editorial and Publishing Offices:

MACMILLAN & CO., LTD.,

ST. MARTIN'S STREET, LONDON, W.C.2.

Advertisements and business letters should be
addressed to the Publishers.

Editorial communications to the Editor.

Telegraphic Address: PHUSIS, LONDON.

Telephone Number: GERRARD 8830.

Agriculture and Fisheries in the Civil Service Estimates.

THE vote to complete the sum of 3,211,605*l.* for the salaries and expenses of the Ministry of Agriculture and Fisheries during the year 1921-22 was agreed to by the House of Commons on April 19. The amount of the vote shows a reduction of 2,156,107*l.* as compared with last year's Estimates; but three-quarters of this is due to the discontinuance of services arising out of the war. We view some of the decreases with mixed feelings; but before mentioning them specifically it is of interest to refer to one or two promising aspects of the Ministry's activities to which Sir A. Griffith-Boscawen directed attention in submitting the Estimates.

Considerable progress has been made with the Land Settlement Scheme for ex-Service men; 48,580 applications have been received, some of which have been rejected for various reasons, and it is estimated that 30,000 men will ultimately be settled. At the present time about 12,000 men are already provided with holdings of 250,000 acres in the aggregate, and about 160,000 acres more are needed to complete the settlement. The scheme inevitably entails losses, foreseen from the beginning, and these may reach as much as 40 per cent. For the first seven years the losses will be made good to the county councils by the State, and after that the capital value will be written down to the then market value, and the holdings handed over on a self-supporting basis

to the county councils. In spite of the loss, it is considered that the settlement of 30,000 ex-Service men on the land will prove a valuable asset to the State.

Foot-and-mouth disease still provides a great problem, as it has as yet proved to be impossible to determine how the infection is brought into the country. Although no trace of the disease can be found in Ireland, certain animals imported there have developed the disease within the incubating period, so that a quarantine of fourteen days at the ports is essential for some time to come. During 1920 there were ninety-four outbreaks in this country, involving the slaughter of more than 2000 cattle and 8000 sheep, with other animals, the net compensation paid being 115,000*l.* This policy of slaughter as compared with that of isolation and cure seems to be justified. In France, where the latter method is adopted, 855,161 cattle were affected in 1919-20, and the loss in the value of the animals was 5,000,000*l.* Muzzling against rabies has proved successful in preventing outbreaks for several months, except for a solitary case at Southampton, and loss through rats has been reduced by the campaign against them vigorously carried on since the passing of the Rats and Mice Destruction Act.

The project for manufacturing beet sugar at Kelham is so far advanced that it is hoped that the factory will be in running order this year. Meanwhile a further loan of 125,000*l.* on mortgage is being made to the undertaking to meet the heavy initial costs of working.

The various councils and committees set up by the Agricultural Acts of 1919 and 1920 are in full working order, and are proving very useful. The policy adopted is that of decentralisation, as it is felt that there should be as little control as possible from Whitehall, but that the powers for insisting on good cultivation should be in the hands of the local committees, the members of which possess that local knowledge and interest which cannot possibly be had at headquarters. Both tenant farmers and labourers now enjoy a greater feeling of security on account of the new clauses dealing with compensation. Apparently, too, the guaranteed prices for wheat and oats are effectively checking the tendency to lay down land to grass, as this year the trade in grass seeds has been normal, with no exceptional buying.

All this is satisfactory enough; but the same can scarcely be said of the position of agricultural

education and research in the Estimates, which show the following reductions compared with the Estimates for last year:—Agricultural and dairy education (grants in aid), 33,000*l.*; agricultural research (grants in aid), 6100*l.*; agricultural research, 61,190*l.*; experiments and instruction in fruit preservation, 8745*l.* The only increase under the head of agricultural education and research is that of 3650*l.* for the National Institute of Agricultural Botany and Seed Testing Station. By the side of these great reductions we have an increase of 94,000*l.* in the estimate for salaries in the agricultural branch of the Ministry.

The Estimates for the Fisheries Department of the Ministry show similar decreases for research and similar increases on the administrative side. The differences may be summarised as follows:—

	1920-21.	1921-22.
Administration, salaries, wages, allowances, legal and incidental expenses. All this properly called <i>Administrative Expenditure.</i>	62,969 <i>l.</i>	85,434 <i>l.</i>
The <i>increased</i> expenditure for 1921-22 is 22,465 <i>l.</i>		
Fishery research in general and fishery research grants in aid. <i>Scientific Research.</i>	59,700 <i>l.</i>	35,025 <i>l.</i>
The <i>decreased</i> expenditure for 1921-22 is 24,675 <i>l.</i>		
Shellfish research and development, development of inshore fisheries, economic destruction of inshore pests, elvers distribution scheme. <i>Development of Inshore Fisheries based on Scientific Research.</i>	62,580 <i>l.</i>	32,405 <i>l.</i>
The <i>decreased</i> expenditure for 1921-22 is 30,175 <i>l.</i>		

It will be seen that in each branch of the Ministry there has been a considerable increase in the cost of administration—that is, the cost of carrying out duties that are apart from scientific research and development. In the Fisheries Department, for example, the administrative staff employed in 1920-21 (secretaries, principals, clerks, writing assistants, typists, etc.) numbered sixty-two; but it is ninety-one in 1921-22. The inspectorial staff (that is, inspectors, technical assistants, fishery officers, surveyors, collectors of statistics, messengers,

charwomen, etc.) was forty-eight in 1920-21; but it is sixty-two in 1921-22. Against that we have a scientific staff of eighteen in 1920-21, and of twenty-one in 1921-22.

We search in vain for a justification of the increased expenditure on administration. The condition of the fishery industry is one of unprecedented depression. Big breaks in wages are contemplated or have been effected, and labour troubles are threatened. The withdrawal of the herring bounties is likely to lead to the laying up of half the East Coast fleets. Exporting has largely diminished. Inshore fishing is decadent. Either administration is impotent when confronted with such economic tendencies, or it thrives upon them. In the face of such industrial depression it is difficult to find a reason for the large increase in the cost of administering the fishery statutes. Frankly, we do not understand why the Ministry largely increases its administrative machinery while economising on development (which is surely the means of counteracting industrial depression) and on research (which provides the *rationale* for successful development). Obviously these Estimates ought to be explained and justified, if possible, for otherwise they suggest an incompetent administration, or a degree of misunderstood economy and control exerted by the Treasury against the better judgment of the Ministry. We might be inclined to take the latter view were it not for the increased cost of purely administrative services, which must have been suggested by the Ministry itself.

It is true that in the debate in the House of Commons Mr. Acland directed attention to the increased expenditure on administration and to the decreased provision for research, but no satisfactory explanation was forthcoming. So far as we are concerned, the opportunity for criticism is afforded only after Parliament has voted the money; and it will be the same next year, unless some body of scientific men obtains early copies of the Estimates and provides suitable representatives in Parliament with material evidence in support of their case for consideration. Criticism of the Estimates is, however, very difficult because of the form in which they are issued. It is impossible to resist the impression that the statement of the expenditure incurred and contemplated is made so as to convey the least possible information as to detail. This impression may be a mistaken one, but if it is the fault lies in the manner in which the Estimates are framed and published.

A Sportsman-Naturalist.

Field Observations on British Birds. By a Sportsman-Naturalist (the late Dr. F. M. Ogilvie). Edited by Henry Balfour. With foreword by Mrs. J. Massie. Pp. xvi+228+vi plates. (London: Selwyn and Blount, 1920.) 25s. net.

THE late Dr. F. M. Ogilvie (1861-1918) was an observer of birds from boyhood, and he enjoyed considerable opportunities on the seamarshes at Sizewell, in Suffolk, and on his property of Barcaldine, in Argyllshire, of following his bent. He was by profession an oculist, and in this, as well as in his hobbies of ornithology and orchid-culture, he showed "the vigour of an able man with the scientific interest, who was steadfast and thorough in all that he took in hand." He published only a few papers, but he delivered eight popular lectures to the Ashmolean Natural History Society of Oxfordshire between the years 1902 and 1916, and these have been edited and put into publishable form by his friend, Mr. Henry Balfour, who has also added judicious footnotes. Naturalists, Mr. Balfour tells us in his preface, will find in these lectures "many shrewd and original remarks, based upon careful observations in the field, by one of the keenest and most cautious of ornithologists."

Of the young golden plover Dr. Ogilvie writes:

"As long as the parents are uttering their alarm note, so long will these little fluffy balls, only hatched perhaps a few hours ago, remain squatted and motionless, with their necks stretched out, their bodies buried in the golden moss, so that all the lighter underparts, including the light eye streak, are hidden from view. . . . I have myself never found a very young nestling Ringed Plover, though I have often looked for them. I have found them when they are a few weeks old, but never directly after they have hatched. I have specimens of them in the latter state, but I obtained them all by hatching eggs out in an incubator. Yet I have constantly been over ground where I knew the birds were breeding freely, and where nestlings must have been quite plentiful."

The invisible young birds are stone-coloured, with black-tipped down.

On the breeding-ground the redshanks are quite fearless, coming to meet the intruder and sweeping by within a few yards, executing all kinds of fanciful aerial flights.

"At this season, too, they possess a curious fondness for perching, a habit I have never observed in winter. . . . It is a point of some interest how a wading bird, with toes formed as a Redshank's are, is able to perch, and to perch securely, on anything so thin and round

as a telegraph wire. Their swaying to and fro is not due to the insecurity of their foothold, for you observe birds that have lighted on a gatepost or barway executing precisely the same movements."

The redshanks make false nests in the second half of March,

"little depressions scrubbed out on the ground with a few bits of rushes and grass roughly arranged in them. They look like the work of a 'prentice hand—of a Redshank who was lacking in experience, and was trying to get his 'hand in' before taking to the serious work of nest-building. What the meaning or the objects of these false nests is, I have no idea, nor whether both males and females are engaged in making them, or whether it is only the male. Most of our Norfolk and Suffolk gunners hold the latter view; why, I don't know, and call them cocks' nests."

Now there is little that is new in these observations, but their record reveals directness, sincerity, and caution, and if we knew them before we like to see them again through another man's eyes.

Gannets frequently fly fifty miles or more to their fishing-ground, but in spite of the labour thus involved they collect far more food than they require, a fact unpleasantly conspicuous in the colony.

"Gannets, feeding as they do on surface-swimming fish, are dependent for their supply on the weather. If a gale arises, as often happens in an English summer, the fish swim at a greater depth, and beyond the ken of the Gannets' keen eyes. If the gale continues for three or four days, during the whole of that time the bird will catch nothing, and it is possible that the fear of such a catastrophe occurring is at the root of the habit, and that the bird's instinct teaches him always to keep a day or two's supplies in hand, as long as he is able to do so."

This is not exactly how the theory would be stated by one versed in modern comparative psychology, but the suggestion is a sound one, for though normally a victorious bird, the gannet is, like most other pelagic sea-fowl, in a sad plight when stormy weather lasts for two or three days.

"The Shag's—and, indeed, all the Cormorants'—method of diving is absolutely characteristic. He really springs right out of the water, turns over in the air, and takes a noiseless header; but the body is so close to the water throughout this manœuvre, and the action is so quick, easy and free of effort, that one hardly follows the middle stage where the body of the bird is really out of the water altogether, the moment when his paddles are just leaving the water with his kick off, and

the beak is just meeting the water to complete the downward half of the semicircle which he describes."

How different from the submergence method seen in the true divers! One cannot but admire a picture like this. The Manx shearwaters sleep in their burrows by day, and start out on their labours as dusk begins to gather.

"They have a curiously silent flight, gliding past one in the gathering gloom like ghosts indeed. I know no bird, except perhaps some of the owls, whose flight is so absolutely noiseless. The effect is curiously uncanny; they appear suddenly out of the darkness and disappear again like spirits of another world."

Dr. Ogilvie's study of the grey partridge affords an interesting illustration of our relative ignorance of a very common bird. In cold, frosty weather the partridges huddle up closely at night, "shoulder to shoulder, forming a circle with their tails in the centre"; yet J. G. Millais writes to the editor to say that the "jugging" birds he has seen had their heads directed inwards. "During the period of incubation, the scent is suppressed entirely, or so little is left that you may take a first-rate dog within a foot of a sitting bird over and over again, and he will not evince the smallest interest in the locality." But does anyone know precisely how this life-saving suppression of scent is effected? When suddenly threatened with danger the parent partridges utter the warning cry, and the chicks

"squat flat upon the ground, as if they were trying to squeeze themselves into the very earth itself, with nothing to show the presence of life but their little black, beady eyes. As long as the danger remains imminent, the parents keep up an incessant chuck-chucking, and the chicks remain absolutely still and motionless. This instinct in itself is very curious, for it is evidently inborn. A chick that is only two or three hours old will 'squat' at the warning cry, with the same celerity and certainty as a chick of three or four weeks. It can be no question of learning by experience and parental training. It will squat at that cry, and at that cry only, though not from any knowledge of the safety so acquired. Partridges reared under a hen never squat, although danger is threatening, and the foster mother is clucking in a dreadful fluster. . . . The necessary stimulus is absent, and that stimulus is supplied by one particular cry of the parents and nothing else."

Except for the sentence: "This instinct in itself is very curious, for it is evidently inborn," this record of observations is admirable, and the whole account of partridges gives the reader a clear impression of the author's grip and carefulness.

In regard to the snipe's "drumming," there is

a fair-minded discussion of the four theories, the author holding firmly that the rapidly beating wings, whether they themselves hum or not, throw a strong current of air on to the outermost feathers of the tail, setting them in vibration which produces sound-waves. As to the position of the orbits,

"a snipe, with its eyes placed as they are, can get the very last fraction out of its bill, as it struggles for a worm half an inch further down in the mud, and yet see all that is going on round it, and be ready for any emergency that the fates have in store."

The cry of the stone curlew is

"a weird discordant clamour, with something uncanny and blood-curdling about it, as though an inferno had suddenly been let loose on earth. We call them 'shriek owls' on this account, and it is not a bad name. Their wild cries ringing out loud and clear, then suddenly ceasing and intensifying the silence of the still summer night, are something suggestive of murder and sudden death."

Regarding the much-discussed serrated claw of the nightjar (also found in the bittern, gannet, heron, and courser), Dr. Ogilvie suggested that it was "a vestigial remnant from some bygone ancestor, which has long since lost its original function, and is now, perhaps, of little service to these latter-day descendants." The editor, whose notes form a valuable addition to his friend's book, remarks that an objection to this theory is to be found in the fact that the pectination is not found in the nestling, but develops later, an unusual feature of vestigial structures.

The rhythmical movements of the cuckoo's stomach during digestion press the hairs of the hairy caterpillars against particular areas of the mucous wall and embed them in the epithelium. Are they shed after a time? Are they ejected as pellets? Do they impede digestion? Are they responsible for a large mortality among the immature cuckoos? These are interesting questions which the author raises, but he need not have asked: "Do the implanted hairs actually take root and grow in their new situation?" Nevertheless, particular attention is paid to the food of certain birds, and there is much information on the subject in his book; thus he maintains that the sparrow-hawk is not so black as it is painted, nor the kestrel so innocent.

Dr. Ogilvie was a sportsman-naturalist, and the sportsman's interests are prominent in these pages, but, on the whole, they are kept in subjection to the interests of ornithology, and the result is what we venture to call a very happy, as well as a very scientific, book.

British Iron Ores.

Memoirs of the Geological Survey. Special Reports on the Mineral Resources of Great Britain. Vol. xii., *Iron Ores (continued). Bedded Ores of the Lias, Oolites, and Later Formations in England.* By G. W. Lamplugh, C. B. Wedd, and J. Pringle. 1920. 12s. 6d. Vol. xiii., *Iron Ores (continued). Pre-Carboniferous and Carboniferous Bedded Ores of England and Wales.* By Sir A. Strahan, Dr. W. Gibson, T. C. Cantrill, Dr. R. L. Sherlock, and Henry Dewey. 1920. 7s. 6d. (His Majesty's Stationery Office.)

THESE two volumes complete the series of six volumes devoted to an account of the iron ores of Great Britain, which will probably form the most enduring monument of Sir Aubrey Strahan's tenure of the Directorship of the Geological Survey. We now need only an account of the iron ores of Ireland, which are far from being negligible, in order to complete our knowledge of the iron-ore resources of the British Isles; the iron industry of this country is deeply indebted to Sir Aubrey Strahan for the invaluable information which he has placed at its disposal in this series of reports. It cannot be suggested that the work has been done before its time; the last official account of British iron ores was issued so far back as 1856 to 1862, when Sir Roderick I. Murchison was Director of the Geological Survey, and this consisted for the most part of a collection of analyses of ores made under the direction of Dr. John Percy.

The best evidence of the care and accuracy with which these analyses were made under the instructions of "the father of British metallurgy" is to be found in the fact that they are still often quoted, and many of them are repeated even in the reports now under consideration. The whole character of the iron industry has, however, been radically transformed within the last sixty years, and ores that were then comparatively neglected are to-day of the highest importance, whilst those that were then being most actively worked are now almost abandoned. This is especially true of the ores to which the present two volumes refer; at that time the bedded ironstones of the Coal Measures formed the mainstay of the iron manufacture of England, whilst the ores of the Lias and of the later formations had scarcely been touched; to-day the great bulk of English iron is made from the latter ores, the Carboniferous iron ores being worked only on a very small scale for quite special purposes in a few districts.

The pre-Carboniferous bedded ironstones are
NO. 2687, VOL. 107]

not to-day of any great importance, but they have been fully and carefully described, and rightly so, for it is scarcely possible as yet to foresee what their economic importance may some day be. The authors might have pointed out with advantage the close correspondence between these ores and the ores that have formed the basis of an important industry in Normandy, the latter being also bedded deposits of Oolitic ores consisting essentially of siliceous carbonate of iron, occurring just below the Armorican grit of Ordovician age.

The chief interest in the iron ores of Carboniferous age will probably attach to the estimates of the quantity of such ore that may still remain. Sir Aubrey Strahan's estimate is close upon 7230 million tons; large as this figure is, it is no doubt far below the quantity that actually exists; but it is equally beyond doubt that it is far in excess of the quantity that will ever be wrought. In illustration of the former thesis, the ironstones of Northumberland and Durham may be referred to. The only figure that Sir Aubrey Strahan gives for these is 1,500,000 tons for Redesdale and district; these particular ores occur at various horizons in the Carboniferous Limestone series, and have been worked only at a few points where they happen to outcrop, as at Redesdale, Bellingham, Haltwhistle, etc. The yield of ironstone is stated by two different authorities to have been respectively 8470 and 9680 tons of ironstone per acre, so that the estimate of quantity here given corresponds to less than 200 acres. Yet these ores are known in places some miles apart; they accompany beds of coal that are notable for their persistence, and there is no reason whatever for assuming that the ironstones are an outcrop formation and do not continue in depth.

It is, therefore, quite possible that these ironstones may extend over many hundreds of square miles, and, if so, the estimate of the quantity of ore given in the report is but a minute fraction of the amount that actually exists in this area. Furthermore, the ironstones of the Coal Measures are altogether omitted from the calculation; yet these ironstones were actually worked, and a century ago gave rise to a quite important iron industry in the northern part of Durham and the adjoining parts of Northumberland, in many places, such as Waldrige Fell, Urpeth, Birtley, Wylam, Hedley, Tow Law, Bedlington, etc., covering an area of probably quite 200 square miles. Mr. William Cargill estimated the yield at Shotley Bridge to be 5324 tons per acre; this appears to have been one of the richest sections, and if, for

the sake of illustration, it is assumed that the average contents were only 2500 tons per acre, the total quantity of this ore could be estimated at 320 million tons. Furthermore, there are no grounds for assuming that these ores are limited to the area above-mentioned; they may quite well underlie the entire coal-field. For these counties, therefore, it may be asserted without hesitation that the estimate in the report falls very far short of the truth. At the same time it may be said with equal certainty that very little, if any, of this ironstone is ever likely to be wrought, so that, however greatly Sir Aubrey Strahan may have under-estimated the quantity of ironstone that exists in this part of England, the error is of no practical importance whatever.

The chief practical interest attaches to the report on the ores of the Lias, Oolites, and later formations, for it is to these that the British ironmaster must look for his ore supplies in the future. The work has been done in a most thorough and painstaking fashion, and will no doubt remain the standard work of reference on this subject for many years to come. Most of the figures have already been given in the Summary of Progress of the Geological Survey for 1917, but it is greatly to be regretted that the present volume nowhere tabulates the results now arrived at, as has been done for the Carboniferous ores. The Summary above quoted gives as the total amount of reserves of these ores in England more or less developed 1765 million tons, and as the probable additional reserves 2093 millions, or a total of 3858 million tons. The present report gives figures that do not differ very greatly from these, except as regards the Northampton ore. Apparently the total quantity of this ore is now given as 2308 million tons to be gotten from the counties of Northampton, Lincoln and Rutland, exclusive, apparently, of possible reserves, whilst the Summary of Progress gave as the known reserves 1252 millions, and as the probable reserves 976 millions, or a total of 2228 million tons. The grand total now arrived at apparently amounts to 4154 million tons, so that without insisting on minute exactitude, which is obviously out of the question in such matters, the British ironmaster may take comfort in the thought that he has probably something like 4000 million tons of ore at his disposal, and it is interesting to note that about one-half of this is represented by the Northampton ironstone.

These figures are eminently satisfactory, and Sir Aubrey Strahan deserves sincere thanks for this contribution to our knowledge, as well as hearty congratulations on the conclusion of this excellent piece of work.

H. LOUIS.

NO. 2687, VOL. 107]

Physical and Inorganic Chemistry.

Recent Advances in Physical and Inorganic Chemistry. By Prof. A. W. Stewart. With an Introduction by Sir William Ramsay. Fourth edition. Pp. xvi+286+v plates. (London: Longmans, Green, and Co., 1920) 18s. net.

THE popularity of Prof. Stewart's book shows that it meets the requirements of certain kinds of readers. It can scarcely appeal to the serious student of physical and inorganic chemistry. A good deal of the material dealt with would not commonly be said to belong to either of the branches of chemistry indicated in the title. Much of it is pure physics, such as the long descriptions of X-rays and positive rays, and it is noteworthy that in just these cases good recent monographs by experts, not too large or beyond the capacity of students, are available. Would it not have been wiser to utilise this space for the description of some less accessible recent advances in inorganic or physical chemistry?

In other cases, notably in the account of the fixation of nitrogen, the author does not appear to have been very critical in his choice of material. A whole chapter is devoted to the permutites, which cannot be said to have any general interest, and have a restricted industrial application. With such matters as the production and utilisation of ozone not dealt with, one could well have spared such unimportant details as these.

The chapter on absorption spectra seems out of place, since it deals mainly with organic chemistry, and the general conclusions drawn from the mass of work described are lamentably vague. It may be that "one atom has the effect of stimulating another into a certain state of vibration, while other atoms have not this power," but the statement does not take us much further, and reminds one of the conclusion reached by many workers in this and allied fields a few years ago, that the effects were somehow due to "motions of the electrons." These vague generalisations are not of much service.

It is doubtful whether a whole chapter on artificial transmutation is wise in a book which can be intended only for students. So little which is certain can yet be said in this field that it would perhaps have been wiser to use the space for some more definite advance. After devoting a whole page to the "transmutation" experiments of Ramsay and Cameron, the author can only add that a careful repetition of the work led to negative results. The reviewer is also under the impression that Sir E. Rutherford has modified his views on "H-particles," and in any case this

work is really too new and controversial to present to comparative beginners, for whom the book appears to be intended.

Prof. Stewart seems to have a quarrel with facts; he thinks that hypotheses are unduly neglected by a certain school of chemists, and he reproaches physical chemists with not knowing enough about organic chemistry. It must be admitted, however, that hypotheses may run wild unless brought into some relation with experiment, and that comparatively few chemists find it possible to become really conversant with two such extensive branches of the science as organic and physical chemistry. To quarrel with mathematics as an aid to chemistry is also a little unfair. Even if it serves no other purpose, a smattering of the principles of mathematics might lead one to pause before committing oneself to a statement such as the following: "The possibility of negative mass suggests itself, and the atomic weight might be regarded as the algebraic sum of the positive and negative masses within the atom." Many strange old hypotheses have been galvanised into life again during the last few years, but this is surely the first reappearance of the theory of phlogiston.

The Bohr atom, we learn, has "not even satisfied the purely physical requirements of an atomic hypothesis." In addition, the "plain chemist," for whom Prof. Stewart says he has written, might not understand the "few elementary exercises in the calculus" which would be required for its elucidation. The reviewer must, however, entirely disagree with the suggestion that such matters were omitted to make room for "material of more practical interest."

The last chapter is full of assertions with which no thoughtful student of physical chemistry could for a moment agree. A personal attack on Ostwald is scarcely the sort of thing to include, as a whole chapter, in a "students'" book, even if the criticism were better informed than is the case in the present essay. It is to be hoped that this wholly unnecessary and entirely one-sided attack will disappear from future editions.

J. R. PARTINGTON.

Our Bookshelf.

A Diplomat in Japan. By the Right Hon. Sir Ernest Satow. Pp. 427. (London: Seeley, Service, and Co., Ltd., 1921.) 32s. net.

THE author of this important work ranks as one of the greatest living authorities in this country on the tangled and critical politics of the Far East. His diplomatic career included an almost

continuous residence in Japan from 1862 to 1882, and culminated in his tenure of the post of British Minister in Peking during the eventful years succeeding the Boxer rising of 1900. He has thus had almost unrivalled opportunities of watching the wonderful evolution of Japan from the position of a relatively weak feudal State, distracted by the struggles between rival *daimyōs*, to its present status as a great World Power with a highly centralised administration. In these circumstances it is to be hoped that the present book, interesting and useful as it is, may be only the first instalment of a more ambitious work which shall give us a critical interpretation of the deeper issues underlying the transition from the old to the new Japan, and a reasoned comparison of the social forces at work in the Empire of the Mikado with those affecting the development of her great neighbour on the mainland. Such a contribution to Western knowledge of the Far East is greatly needed.

In the volume under notice Sir Ernest Satow has contented himself with acting as showman of a marvellous pageant the culmination of which in the Japanese revolution of 1868 involved the downfall of the Shogunate and of feudalism, the restoration of the undivided authority of the Mikado, and the inauguration of the present Meiji era (Age of Enlightenment). The book consists mainly of an extremely graphic record of six years (1862-68), based upon the author's diaries written by him in his early days as a student-interpreter in Japan, when his youthful imagination was captured by the fascination of a wholly unfamiliar society, and when he was consumed by an insatiable curiosity to read and understand what had long been for Europeans a sealed and mysterious land. The book abounds in vivid descriptions of scenery, customs, men, and events. The account of one of the first overland journeys made by Europeans (from Ozaka to Yedo) is among the best of its kind. The personal narrative is sufficiently interspersed with historical explanations—e.g. chap. iii., "Political Conditions in Japan"—to enable the reader to appreciate the significance of the events described.

P. M. ROXBV.

Hydro-Electric Survey of India. Vol. ii.: *Second Report on the Water-Power Resources of India, ascertained during the Season 1919-20* by F. E. Bull and J. W. Meares. Pp. 123. (Calcutta: Government Printing Press, 1920.) R.1 6 annas.

THE investigation of the water resources of India has been in hand for some time. The preliminary report, issued in the autumn of 1919, gave an account of the initiation of the Survey and the preparations made by Mr. Barlow in conjunction with Mr. Meares up to the time of the death of the former. The second volume, now issued, contains a *résumé* of the work which has been done since Mr. F. E. Bull took over the chief engineering, with Mr. Meares as electrical adviser. The itinerary consists of a series of visits to officers

specially engaged in the Survey, checking their reconnaissances, and making further researches in British India and the Native States.

Part i. of the report consists of a note by Mr. Meares on the general principles of development and storage of water for electrical purposes, compiled for the guidance of those making local investigations, and exhibits the standard form in which it is recommended that the data collected should be recorded. Part ii. deals with administrative matters connected with the Survey. Part iii. contains the results of the reconnaissances made by the chief engineer and the electrical adviser, together with observations on the provincial surveys. Decisions were made as to the suitability or otherwise of various localities for further investigation. Difficulties, however, were encountered which prevented in several cases any very effective progress, and it is stated that until additional staff can be recruited and an adequate supply of survey instruments assured it will not be possible for the work to proceed on more satisfactory lines.

BRYSSON CUNNINGHAM.

The Principles of Politics: An Introduction to the Study of the Evolution of Political Ideas. By Prof. A. R. Lord. Pp. 308. (Oxford: At the Clarendon Press, 1921.) 8s. 6d. net.

PROF. LORD modestly describes his book as a bridge for students from Sir Frederick Pollock's "History of the Science of Politics" to Dr. Bosanquet's "Philosophical Theory of the State." In this task he has succeeded well. His style is eminently readable, his arguments are clear, and his information is accurate. His analyses of political theories are supported by apt quotations, in the selection of which—e.g. from Spinoza's political writings and from the *Federalist*—he has departed, with excellent effect, from the traditional text-book grooves. The introductory chapter gives a good account of the influence of the Renaissance and the Reformation on political theory. There follows a chapter on the social contract, three chapters on different theories of sovereignty, one on democracy and representation, one on the notion of law, three on the theory of rights, and lastly a conclusion in which Prof. Lord sums up his own positive point of view, which is that of the classical idealist theory of the State, as developed, under the influence of Kant and Hegel, by T. H. Green and Bosanquet. It is a little to be regretted that Prof. Lord's scheme did not permit him to touch on the recent criticisms of this theory by writers like Graham Wallas, G. D. H. Cole, H. J. Laski, R. H. Tawney, and many others. He keeps strictly to historical materials. Hobbes, Locke, Rousseau, and Spinoza are the prominent figures, with Machiavelli, Bentham, and Burke in the second rank. No nineteenth-century theorists find mention except Mill and Spencer, and these only in the discussion of individualism. However, within these self-imposed limits Prof. Lord has written a book which teachers and students of political theory alike will find useful.

R. F. A. H.

Abnormal Psychology and its Educational Applications. By F. Watts. Pp. 191. (London: George Allen and Unwin, Ltd., 1921.) 7s. 6d. net.

THE first edition of this book, published under the title of "Echo Personalities," received notice in NATURE for July 17, 1919, under the title "Abnormal Psychology and Education." When a second edition was asked for, the author accepted the obvious suggestion and adopted a title which is more likely to indicate the scope of the book. Few changes have been made in the new edition; the chapters have been usefully subdivided, while those on psychopathology and the development of personality, and on the psychology of the defective mind and its influence on teaching methods, have received considerable additions. The chapter on the psychology of the supernormal mind finds no place in the new edition.

Tables of Physical and Chemical Constants, and some Mathematical Functions. By Dr. G. W. C. Kaye and Prof. T. H. Laby. Fourth edition. Pp. vii+161. (London: Longmans, Green, and Co., 1921.) 14s. net.

THE changes which have been made in the new edition of this valuable manual of constants are mostly matters of detail. All the chemical data have been recalculated on the basis of the international atomic weights, and, with the co-operation of Dr. E. Griffiths, of the National Physical Laboratory, a revision of the heat tables has been attempted. Tables of atomic numbers, spark-gap voltages, X-ray wave-lengths, and terrestrial magnetic constants also find a place in the new edition, and more extended tables of the relative value of the acceleration of gravity have been added. The first edition received detailed notice in NATURE of February 8, 1912.

The Theory of Relativity. By Prof. R. D. Carmichael. Second edition. (Mathematical Monographs, No. 12.) Pp. 112. (New York: John Wiley and Sons, Inc.; London: Chapman and Hall, Ltd., 1920.) 8s. 6d. net.

THE earlier portion of Dr. Carmichael's book is a reprint of the first edition, which received notice in NATURE for March 12, 1914. The later pages, which are grouped together under one large chapter with twelve subheadings, deal with the generalised theory of relativity. The new chapter opens with a brief summary of results obtained from the restricted theory, and an account of the general theory follows. Sufficient detail is given to provide some explanation of the general theory of gravitation, the nature of the three phenomena by which experimental proof of the theory may be expected, and the connection between the generalised theory and Maxwell's electromagnetic equations. Applications of the theory other than those which are immediately associated with the fundamental ideas or with phenomena for testing the validity of the theory have been omitted in order that attention may be directed more readily to the more novel aspects of the theory.

Letters to the Editor.

[The Editor does not hold himself responsible for opinions expressed by his correspondents. Neither can he undertake to return, or to correspond with the writers of, rejected manuscripts intended for this or any other part of NATURE. No notice is taken of anonymous communications.]

The Internal Physics of Metals.

I NOTICE in an article in NATURE of April 14 on "The Internal Physics of Metals" considerable importance is given to the idea of the existence of an amorphous or vitreous layer between the crystals composing metals and alloys, and certain seasonal changes in them are attributed to the presence of this layer. The remark is made that until 1919 the phenomenon of "season cracking" was considered to be an isolated one, and recognised only in brass.

"Season cracking" is, however, only an extreme case of the secular relief of strain which occurs in all metals which have been subjected to cold working.

It may be of interest to some of your readers to learn that this state of strain in cold-worked metals and its cause had been dealt with in a paper read before the Faraday Society in 1904, while in the May lecture to the Institute of Metals in 1911 an illustration was exhibited of the partial relief of strain by cracking which had occurred within twenty-four hours. In these papers, and in others communicated to the Royal Society, the change from the crystalline to the vitreous state brought about by mechanical disturbance and "flow" was shown to occur in metals and other crystalline substances. The effects of this change of state on the chemical, electrical, acoustical, optical, and mechanical properties of the substances were dealt with, and were all shown to be associated with a condition of strain which could be completely relieved by the restoration of the fully crystallised condition by raising the mass to a temperature far short of its melting point.

It was suggested that the changes of structure which are produced by the cold working of metals could be accounted for by the occurrence of liquid-like flow at all internal rubbing surfaces, followed by almost instantaneous resolidification of the liquid phase, thus producing a hard cement, binding together the broken and distorted remains of the original crystal grains. In wire-drawing, for example, an entirely new "texture" is developed even in pure metals. The crystal grains are drawn out into fibres, which are embedded in and cemented together by the portion of the metal which had passed through the liquid phase as the wire flowed through the hole in the draw-plate. Owing to the greater solubility of the metal which has flowed into the vitreous state, the first effect of a solvent on the wire is to dissolve away the cementing material and to expose the fibrous structure.

"Season cracking" seems, therefore, to depend (1) on the free flow of the metal during drawing, for the greater the production of the liquid phase the greater will be the shrinkage at the moment of resolidification, and the greater will be the resulting state of strain in the hardened metal; and (2) on the subsequent action of a solvent which, by removing or breaking up the vitreous skin and cementing material, will enable the elastically strained fibres or layers to spring apart. The solvent may be mercury, or an acid or saline liquid, or acid vapours or even water vapour in the atmosphere. A piece of hard rolled metal foil is thoroughly springy and resilient, but this resilience is completely removed and the foil

becomes soft if the vitreous layer on the surfaces of the foil is removed by a solvent.

GEORGE BEILBY.

April 21.

SIR GEORGE BEILBY'S work on the generation of amorphous metal as the result of "flow" during plastic straining or surface polishing of metals is so well known and appreciated that a contribution from him to the discussion of "season cracking" is very welcome. At the general discussion on this subject the fullest reference to his work in first indicating the existence of metal in an amorphous condition was made. Sir George Beilby's letter, however, appears to be based mainly upon the brief article in NATURE of April 14 rather than on the full discussion of the subject, of which that article could not give more than a very brief account from one particular point of view. No doubt for that reason Sir George Beilby has apparently missed some of the main points of the discussion, and has made a suggestion with regard to "season cracking" which is not easily reconciled with the known facts.

Thus, one reason why special importance is attached to an amorphous inter-crystalline layer or "cement" which exists in entirely unstrained metals is that fracture in "season cracking" follows the boundaries of the original crystals, and does not follow the lines of flow or slip within the crystals upon which Sir George Beilby's amorphous metal is formed. Further, it has now been clearly shown that fracture essentially of the nature of "season cracking" can and does occur under the prolonged application of external stress in fully annealed, or even cast, metal in which there has been no formation of Sir George Beilby's amorphous metal as the result of plastic strain. It follows, therefore, that the amorphous metal generated by plastic strain must be regarded as playing only an indirect part in the phenomena of "season cracking," that part being so to stiffen and harden the metal that it can carry an internal stress high enough to bring about the gradual separation of the crystals along their original boundaries.

With regard to the statement that prior to 1919 "season cracking" had been regarded as an isolated phenomenon confined to brass, this is true in the sense that until the publication of Rosenhain and Archbutt's paper it had not been recognised that this type of inter-crystalline fracture under prolonged stress could occur in other metals than brass, and possibly nickel-silver, whereas it was then shown that it also occurs in lead, in aluminium alloys, and even in steel.

THE WRITER OF THE ARTICLE.

Biological Terminology.

MR. CUNNINGHAM writes (NATURE, February 24, p. 528): "It is a mere matter of terms and synonyms. The modern biologist would say that the normal hand was hereditary, or innate, or due to certain factors or genes in the chromosomes which usually are handed on unchanged 'down the germ-tract'; that the sixth digit was a mutation, due to some change in the genes in the chromosomes, and therefore gametogenic; and that the scar was due to an injury which resulted in regenerative processes producing new tissue. . . . Sir Bryan Donkin writes that like exactly begets like when parent and child develop under like conditions; if we say, then, that the differences due to unlike conditions are acquired characters, what is the objection?"

The objection is that what is true of individuals is not necessarily true of characters, and that Mr. Cunningham's thoughts drift to and fro,

now comparing individuals and now characters. Moreover, he makes distinctions where there are no differences. As a consequence, he is convinced that I contradict myself, and so on. Taken by itself, not a statement he makes is incorrect. Taken as a part of a whole, every statement is incorrect. It is quite true that a hand and a sixth digit are germinal, but the scar also takes origin in germinal potentiality. It is true that the scar is a response to the stimulus of injury, and in that sense acquired; but injury is not the only form of nurture, and hands and sixth digits are as much products of nurture and as much situated in the soma as scars.

Is not the following true?—(1) All likenesses between individuals are innate *and* acquired. For example, men have similar hands because, (a) having started with similar germinal potentialities, and (b) experienced similar nurtures, they have (c) developed similar characters. (2) All unlikenesses between individuals are innate *or* acquired. Thus a sixth digit indicates an unlikeness (variation) which has a germinal origin; for under similar nurtures the individuals develop differently. A scar indicates an acquired or somatic unlikeness (modification); for this unlikeness develops only when unlike nurture is experienced by the individual. (3) All characters as such (e.g. when compared together) are innate *and* acquired. Thus a hand is founded on germinal potentiality, and, therefore, is innate; it develops under the influence of nurture, and, therefore, is acquired; and it is situated in the soma, and, therefore, is somatic. The same is true of every character that can be thought of. It follows that while it is correct to distinguish differences between individuals by the terms "innate" and "acquired," it is incorrect so to distinguish characters. A sixth digit indicates an innate difference, but is not in itself especially innate. A scar indicates an acquired difference, but is not in itself especially acquired. If the matter be considered, it will be found that while some biology (e.g. the theory of natural selection and the Mendelian theory) is founded on the belief that differences between individuals are innate *or* acquired, much the greater part of biology—or, at least, of biological literature (e.g. the Lamarckian and Neo-Darwinian hypotheses)—is based on the assumption that all characters are so distinguishable.

It is admitted that in the germ-cell are, not the characters of the individual, but only potentialities for developing them in response to fitting nurture. Therefore, nothing but potentialities can be transmitted. It follows that when, using a colloquialism which is pardonable, since it neither deceives nor confuses, we say that a child "inherits" his parent's hand, we can mean only that the child, having inherited a like potentiality, has under similar conditions developed a similar character. We then mean that the child is like the parent both by nature and by nurture, both by inheritance and by acquirement. If we used our words with the same meanings, we should say that a child inherits his parent's scar when he develops it under the same conditions as the parent did (in response to injury). The child would then be like the parent both by nature and by nurture. He would really have "inherited" in the only sense in which the word has meaning. But, misled by his misuse of words, the biologist will have none of this. He would regard the scar as inherited only if the child reproduced it in a way in which the parent did not and could not have produced it, only if the child were unlike the parent both by nature and by nurture, only if the child had varied so profoundly and improbably from his progenitors that the scar, this ancient and vitally useful product of evolution, is now produced

(and the whole course of evolution upset) under some other influence as a useless and burdensome thing. The misuse of the words "innate," "acquired," and "inherited" conceals the enormity of the notion and gives it an air of probability. As a consequence, biologists have debated for a century as to whether evolution follows the "transmission" of "acquired" characters, and to-day biologists using "exact methods" are trying to ascertain what characters are "innate," and therefore worthy of the attention of the student, and what "acquired," and therefore unworthy of his attention.

When employed to describe differences between individuals, the words "innate," "acquired," and "inherit" are used intelligibly with their ordinary dictionary meanings. When applied to characters they cannot have these meanings. They have then no meanings, or technical meanings. It is claimed that they have the latter. But, as has appeared in this correspondence, no technical meanings can be thought of which accord with past or present usage. Moreover, the claim is unhistorical; for, as may be seen by an examination of literature, biologists have never intended to give their words technical meanings. Their very synonyms, "germinal," "blastogenic," "somatogenic," and the like, were coined to give greater definiteness to the naive belief that, while "some characters have their representatives in the germ-plasm," others are products of "heat, light, moisture, and the like." Historically, all biologists have limited the term "acquired" to characters which develop in response to glaringly obvious stimuli, and applied the term "innate" to all other characters. For example, the musculature of the blacksmith has been termed "acquired," while those of the child, the youth, and the ordinary man which have developed in response to precisely the same stimulus (use) have been termed "innate."

"Innate," "acquired," and "inherit" are the chief terms of biology. We see that the first two have sometimes clear meanings and sometimes no meanings, and that "inherit" sometimes means "inherit" and sometimes its direct opposite, "vary." I daresay that most readers of this correspondence think I am engaged in a mere logomachy. But with the chief terms in such a state of vagueness and confusion, how is it possible to build a science? Confusion is sure to follow. It has followed. As Dr. Norman R. Campbell has well said (NATURE, April 21, p. 234): "Accuracy of thought is intimately dependent upon the constancy of the meaning of the words used to express it." Consider the chaos of biological sects and opinions. Consider the controversies, always unending in the face of abundant evidence, and, therefore, as clearly products of mere prejudice as religious or political disputes. Consider the fact that, alone among interpretative sciences, biology has no body of truth accepted by all its students with the sole exception of the supposition that living beings have arisen through evolution. Consider the parochial littleness of biology, which has more tremendous problems ripe and ready for solution than any other science. Consider the enormous masses of neglected evidence—for example, that available from physiology and pathology and that which demonstrates the evolution of the power of developing in response to functional activity. Consider what happens when a humble outsider such as myself brings his difficulties to biologists. He is told pontifically that he is doing harm, or conceitedly that biologists are quite capable of conducting their deliberations without his help, and so on. The feelings of awe and admiration excited in the humble inquirer are then likely to be—well, of no importance.

What is biology? Who are biologists? So far as I am able to judge, biology is commonly regarded as a side-show of natural history; and any zoologist and botanist is supposed to be, *ex officio*, a biologist. But biology is an interpretative science, and systematic zoology and botany are purely descriptive. They may furnish valuable evidence, but they do not necessarily do so. The zoologist or botanist trained in observation and description may interpret skilfully, but such skill is not a necessary outcome of his studies. Zoologists and botanists have themselves proclaimed the inadequacy of their evidence by founding the experimental and biometric schools, which began as violently opposed sects, and so continue.

To my thinking, biology is that science which sits at the hub of all the studies concerned with life—zoology, botany, physiology, psychology, medicine, bacteriology, embryology, anatomy, palæontology, sociology, even pedagogy and history—gathers evidence from them all, and deals especially with problems too big or deep for these individual studies, e.g. problems of heredity, evolution, development, and the like. If the biologist be controlled by the rules which ordinarily guide scientific procedure—for example, the rule that all verifiable and relevant facts (no matter how, or by whom, or when, or where collected) are equal before science, by the rule that all hypotheses must be crucially tested (*i.e.* so tested by *fresh* and *unlike* facts that every alternative hypothesis is rendered inconceivably as true), and by the rule that a fully established theory must be accepted as true regardless of all preconceptions—then a very splendid future immediately awaits not only biology, but also science in general; for the claim of science to the deciding voice in the settlement of numerous burning problems of immense importance will become irresistible.

By way of demonstrating that I am not vapouring, I shall venture to give one or two examples of evidence ignored and problems neglected by biology "as she is spoke" in a future communication. Meanwhile, there is a little more in Mr. Cunningham's letter with which it is necessary to deal. He says that naturalists would not admit that man, as an animal, is "higher" than an insect. It is pleasant to find him so careful of meanings; but will he please excuse the expression as "technical"? It is in common use and deceives no one. He declares that I give no evidence of the evolution of the power of developing in response to use. Is there any need? A man develops from birth to death mainly in response to this influence; does Mr. Cunningham believe that a butterfly develops in the same way to an equal extent? Consider mind. All learning, thought, intelligence, and reason depend on the growth of the mind through functional activity. Mr. Cunningham has done magnificent work on hormones. Does he think a beetle could learn what he has taught? What is intelligence but a power of developing in response to experience, of growing mentally in response to functional activity? What is stupidity but a "natural" or "acquired" incapacity so to profit? A human infant can learn, but has not learned. A human idiot cannot learn, and has not learned. A normal man can learn, and has learned. Almost all that separates the normal adult mentally from the infant and the idiot develops in response to use. The perfect idiot cannot even learn to walk or to speak. From the human point of view every dog is an imbecile, every cat an idiot, every beetle a perfect idiot. The beetle is more efficient than the human idiot merely because he is more completely equipped with instincts and instinctive actions, which, unlike human habits, habitual actions, and the rest, do not develop through use.

For example, the beetle does not learn to use his limbs. Does not the difference between man and the beetle indicate an evolution of the power of developing in response to use? What more evidence does Mr. Cunningham want?

G. ARCHDALL REID.

9 Victoria Road South, Southsea, April 23.

The "Flight" of Flying-fish.

IN NATURE of April 21 Prof. Wood-Jones presents some interesting observations on the "flight" of flying-fish made from an especially favourable vantage-point—the overhanging bow-sheaves of a cable ship.

While crossing the Gulf of Mexico on various occasions I made some observations on the same subject with the aid of powerful binoculars (Görz prismatic, magnifying 12 diameters). With these I had been used to following birds in flight, and with a little practice found that I could keep flying-fish under continuous observation during their passage through the air.

I can confirm Prof. Wood-Jones's account in the following important particulars:—

(1) The initial impulse is always given by rapid lateral strokes of the tail as the fish leaves the water. Since the lower lobe of the caudal fin is elongated, the fish can continue to propel itself in this manner for some time while the whole of its body is out of the water. On very calm days the moving lower lobe of the tail leaves a track in the water in the form of an interrupted line. Presumably the interruptions represent the times of violent lateral motion. The uninterrupted sections of line are each 2-3 in. long, the interruptions rather longer, the whole line often continuing for 5-6 ft. After this, of course, the fish rises wholly into the air.

(2) The fish may regain impetus by again vibrating its tail when it has dropped far enough for the lower tail-lobe to be once more in the water. Fresh impetus may be gained in this way once, twice, or even three times in a flight without the body ever touching the water.

(3) The pectoral fins are usually held stiffly out, as Prof. Wood-Jones states, and act as planes. I have, however, on several occasions seen rapid vibration of the pectoral fins for a short period; but whether this was actual "flight," as I at the time supposed, or whether it was due, as Prof. Wood-Jones suggests, to a passive vibration caused by the air meeting the fin at a certain angle, I am unable to say. The impression made upon me at the time was that the *normal* means of propulsion in air was the tail, but that the pectoral fins *could* be used as supplementary flying organs on occasion. Of the truth of the first part of this impression I have no doubt whatever; Prof. Wood-Jones's anatomical studies make me doubt the second part. However, a good binocular in the hands of anyone trained to field observation will put the matter to the test.

JULIAN S. HUXLEY.

New College, Oxford, April 25.

The Concept of "Space" in Physics.

PROF. EDDINGTON (NATURE, April 14, p. 201) expresses well the properties that a substratum of matter, light, and electric force should have, and the reasons for combining space and æther, the two different, but always co-existing, substrata of the older physics, into one. What is not clear is why he stops there. The ancient rule, "Entities are not to be multiplied beyond necessity," is as applicable now as ever. If a physical æther is to be postulated, it is for those who advocate it to show their reason for doing so,

not for those who doubt it to offer arguments against it. So far as I can see, neither the old æther nor the new is more than a metaphysical concept of no utility, either in understanding natural phenomena or in predicting new ones, and accordingly neither forms part of the subject-matter of physics. In Prof. Eddington's own development of the theory he never makes any use of this concept. What he assumes is that physical laws can be expressed by differential equations with a certain mathematical property, and the whole of the verifiable results are deduced from this; but this assumption was chosen, not because it corresponded to any known property of space-time or æther, but because mathematically it was the simplest possible. The theory is not based on the concept of space-time, but on an unstated relation between physical laws and mathematical simplicity. Reasons why such an assumption is needed in any theory of scientific knowledge are given in a forthcoming paper by Dr. Wrinch and myself, and are independent of any views on the ultimate nature of the world, except that quantitative inference is possible.

Again, I must dissent from the statement of the interrelation of experimental geometry and mechanics. The essential feature of geometry, as the term is used by geometers, is that it is purely logical and not experimental. Consequently, "experimental geometry" is a contradiction in terms, and can neither have an outcome nor be one. The subject-matter of the mechanics of the world is the relations between the measured positions of bodies at different measured times; all the concepts involved in this statement are well-known physical magnitudes, and I see no use in trying to redefine them in terms of others that are either totally hypothetical or, at best, less comprehensible than those already in existence.

HAROLD JEFFREYS.

Meteorological Office, South Kensington,
S.W.7.

The Origin of "Churning at 62°" on Dairy Thermometers.

WILL you permit me through NATURE to ask the following question: Why do the makers of floating dairy thermometers, both in the United Kingdom and in the United States, so mark their thermometers that 62° F. is said to be "churning temperature," when dairying experts in both countries are in agreement that it should be taken as 56° F.?

I recently had occasion to make myself familiar with the agricultural literature published in this country between 1831 and 1855, and found that where churning temperatures are given it is stated to be 50° to 55° F., and in doing so reference is usually made to experiments carried out by the Highland Society of Scotland in 1828 on the best temperature for churning butter. Various American authorities in dairying have commented on this curious marking of dairy thermometers, and have come to the conclusion that it is a "mystery" how dairy thermometer-makers arrived at the figure 62° F., and why they persist in recording on the thermometers they are making to-day that 62° F. is "churning temperature."

Perhaps some of your readers may be able to throw light on this "mystery."

R. HEDGER WALLACE.

April 12.

A FIRM of manufacturers of thermometers, Messrs. Pastorelli and Rapkin, Ltd., to which we submitted Mr. Hedger Wallace's inquiry, informs us that though
NO. 2687, VOL. 107]

they have supplied tens of thousands of dairy thermometers in recent years, they do not know the origin of the mark "churning at 62°," and no one has ever suggested to them before that this temperature is incorrect. Dr. W. Goodwin, principal of the Midland Agricultural and Dairy College, has favoured us with the following opinion upon the subject:

"I do not know that marking dairy thermometers with a churning temperature of 62° is such a common practice as Mr. Hedger Wallace indicates. Many such thermometers are just marked with the degrees only, and these are what we always recommend for our students. It is quite impossible to fix a churning temperature owing to the large number of factors which have to be taken into account. For example, thickness of cream, the degree of ripeness of the cream, the temperature prevailing at the time, the breed of the cow, and even such other factors as feeding and period of lactation, come into consideration. I agree with Mr. Hedger Wallace that 62° is generally too high, unless the churning is taking place in very cold weather, and I venture as an explanation that possibly this old custom dates back to the time when whole milk was churned, as this necessitates a higher temperature than in the case of separated or skimmed cream. It would be of interest to find how the churning temperature of 62° has arisen, but I can think of no justification for it. Probably on some popular make of thermometer this point was fixed, and has been blindly copied ever since."—ED. NATURE.

Young's Interference Experiment.

YOUNG'S interference experiment is a very difficult one to perform as he describes it. If slits are used for the apertures it requires a distance of two yards from the first slit to the double slit, and two yards from the double slit to the observer, and also a very bright source, the sun or the crater of the electric arc. For this reason the experiment is seldom performed, Fresnel's biprism or mirrors being substituted for it in laboratory courses.

If, however, the double slit is mounted on the table of a spectrometer the experiment can easily be performed with an electric incandescent lamp or a sodium flame, and the bands are considerably brighter than with the other arrangement, though not so bright as the bands produced with a biprism. The double slit can be made by painting a piece of glass dead-black and then drawing two parallel scratches on it with the point of a penknife. If the scratches are six-tenths of a millimetre apart, a natural distance to draw them, the separation of the successive bands is about three minutes in the field of the telescope, and ten or twelve bands can be counted. This method of performing the experiment is not mentioned in the textbooks, and so it appears worth while to direct attention to it here.

It should also be stated that the diffraction bands produced by a straight edge are undoubtedly more easily observed with a spectrometer than with the expensive optical benches sold for the purpose. The diffracting edge—the blade of a penknife, for example—is mounted vertically on the prism table, and the telescope object-glass removed. The bands are then seen in the field, the distance between the first two maxima being about four minutes with a spectrometer of average size. In the formula for their position the a becomes infinite and cancels, and the angular distance from the edge of the geometrical shadow is $\sqrt{\{2n-1\}\lambda/b}$.

R. A. HOUSTOUN.

University of Glasgow, April 16.

The Electrodeless Discharge in Sodium Vapour.

By placing a primary Tesla coil about a highly exhausted pyrex bulb containing metallic sodium, and enclosing the whole in an oven, the writer has obtained a brilliant electrodeless discharge at a temperature in the neighbourhood of 300° C. Observation with a Hilger constant deviation spectroscope revealed, in addition to the D lines, doublets at 6162 (and 6158), at 5688 (and 5683), at 4667, at 4497, as well as faint probable doublets at 5153, at 4980, and at 4572—lines all to be found in the arc spectrum. After two or three hours' continuous heating the discharge was almost as brilliant as initially, although the bulb on removal from the oven had the usual brown colour resulting from the action of the hot vapour.

The writer has under way a further study of this type of discharge with sodium and with other metallic vapours, and hopes that with more violent excitation than was used in the above case interesting spectroscopic data may be obtained.

JOHN K. ROBERTSON.

Queen's University, Kingston, Canada,

April 7.

High-speed Aircraft Propellers and the Destruction of Gnats.

SOME of your readers may be interested in an incident which took place during the testing of a propeller at the Royal Aircraft Establishment, South Farnborough. The propeller was being revolved at a very high speed, such that the tips of the blade were moving at about 1000 ft. per second. The test was carried out in the open, and the noise was such that in the neighbourhood of the propeller it was impossible to make oneself heard. Moreover, the noise gave an unpleasant physiological sensation. The interesting fact to your readers is that apparently this noise attracted very large numbers of gnats, and most of these lost their lives by being drawn through the propeller, which on being stopped was found to be covered with their blood and portions of their bodies.

At the commencement of the test, and even when running with a tip-speed of 800 ft. per second, there was no sign of any flying insects, nor was the day such that one would expect them.

I have been present at many such tests, though never at such a high speed, but I have not noticed such an occurrence before.

HENRY C. WATTS.

April 21.

Why do Worms Die?

THE REV. H. FRIEND'S letter in NATURE of April 7 recalls an observation made towards the end of last November with respect to the death of worms. A shallow gutter or water-drain by the side of a road near Sidmouth had become filled with dead leaves (principally of *Populus alba*) during the late autumn. These by accumulation and pressure had formed a firm, compact bed in the drain. During a night at the end of November last we had exceptionally heavy rain, and the next morning, on passing along the road in the forenoon, my attention was immediately arrested by the number of worms (of several species) lying dead outside the shallow water-drain. In the space of about 20 ft. I counted upwards of a hundred worms. They had evidently crawled out from the bed of dead leaves to the firm surface of the road and died there. My conclusion was that they had crawled out from the gutter in a half-drowned condition and beyond the chance of recovery. A curious point was that they all (irrespective of size and species) appeared to have crawled to about the same distance, so that they formed a fairly even line running parallel with the gutter.

G. T. HARRIS.

Vegetation around London Earlier than in the Provinces.

NATURE of April 21, in the Notes columns, p. 245, mentions that a correspondent who travels frequently from the south-west of England to London finds at this time of year vegetation, notably the flowering trees, generally more advanced as the metropolis is approached. In the past I have frequently noticed the spring vegetation in London to be more forward than thirty or forty miles outside. Commonly, in visiting East Grinstead from London, I have noticed and remarked on the lateness of spring vegetation compared with the metropolitan suburbs. This year at Tulse Hill, and generally in the south of London, the pear- and apple-trees were in fairly full blossom at the commencement of March, whilst at Eastbourne similar vegetation was fully three weeks later. The dates from the Phenological Report for 1919 published by the Royal Meteorological Society referred to in your Note can scarcely claim to determine the general difference between south-west and south-east England. The early months of 1919 were abnormally cold and wet, and on April 27 a snowstorm of considerable severity occurred in the south of England.

CHAS. HARDING.

2 Bakewell Road, Eastbourne, April 21.

A Modern Inorganic Chemistry.

IN a very able and courteous review of my "Text-book of Inorganic Chemistry" which appeared in NATURE of April 14, "A. J. A." makes two statements which I think might be misleading to many readers. He states that "in practice calcium cyanamide is not produced in an arc furnace." The Stockholms Superfosfat Fabriks Aktiebolag, Stockholm, make 20,000 tons of cyanamide annually in arc furnaces, and since this modern so-called "continuous cyanamide process" is referred to most respectfully in the report of the Nitrogen Products Committee, I thought it worthy of mention—in an imperfect manner, it is true. It is quite possible that of the two cells described for the manufacture of electrolytic alkali, one is "obsolete" and the other "obsolescent." It is five years since I saw one described in some text-books as "quite obsolete" operating with great activity; doubtless it has now gone out of use. Since these two cells, however, were the only ones I could find authoritatively described as in use, or as having been in use, in this country, I preferred to describe them rather than cells existing only in patent specifications.

J. R. PARTINGTON.

My knowledge of the continuous cyanamide process is confined to what appears in the Nitrogen Products Committee's report, and I am afraid I did not know that the preliminary heating of the carbide necessary before it can absorb nitrogen was carried out by electric arc heating. The arc itself is, of course, at a temperature far above that at which nitrogen can be absorbed by carbide.

With reference to Prof. Partington's second point, there is nothing in his description of electrolytic alkali cells to indicate that he is only dealing with processes used in this country, and there is no lack of authoritative descriptions of cells used abroad, where electrolytic alkali has assumed greater importance than has been the case here in the past. Even so, I think I am right in saying that the Castner-Kellner rocking cell is no longer used to produce alkali for the market, and, this being so, it appears a pity to devote to it such a disproportionate amount of attention. "Obsolescent" is, I imagine, a fair description of the Hargreaves-Bird cell.

THE REVIEWER.

The High Pamir.¹

THE term "Pamir," when strictly used, connotes the level floor of a wide-based mountain-valley in the uplands that connect the Hindu-Kush and Karakoram ranges to the south with the Alai and Tianshan ranges to the north. On its eastern side this tract rises rather abruptly from Kashgar; westward, it descends more gradually to Ferghana.

While nearly horizontal from end to end, the surface of such a valley-floor is usually undulating, and is almost always drained by a central stream with a boulder-strewn bed which is depressed somewhat below the level of the main valley-floor. Often such streams widen into a lake or lakes with low, bare banks; in the case of one Pamir—the Alichur—the lake is at the western end and has mountainous shores. The rivers of the eastern valleys flow towards the Kashgar plain; the western streams flow to join the Oxus. The valley-floors are generally 12,000 to 14,000 ft. above sea-level, often 5 miles wide, and sometimes exceed 50 miles in length. The slopes overlooking them that have a western or southern exposure usually have huge bare basal screes of talus, and are steeper than the less barren slopes that look east or north. Conflicting views have been advanced as to the formation of these striking flat-floored valleys. Whatever the true explanation may be, they are now being steadily filled up as the result of disintegration of the slopes on either side.

The ranges which separate these valleys are loftier in the eastern portion of this region than elsewhere; one eastern peak, Mustagh-ata, is 27,500 ft. high. Some of the north-western peaks exceed 23,000 ft.; the south-western ranges are only 17,000 to 20,000 ft. high. The latter extend further west than the portion of the region marked by the presence of flat valley-floors, the streams of which, now flowing with more rapid descent, find their way to the Oxus through narrow glens and mountain-gorges.

Ser Marco Polo, six hundred years ago, had heard of this elevated region. He knew that the word "Pamer" signifies a plain, but he appears to have thought that there was in the region only one great plain, "twelve days' journey in length." Modern Russian writers also apply the name "Pamir" to the whole of this upland tract. But they regard, with justice, the ranges that separate the various valley-floors as of most physiological consequence, and, therefore, include in the Pamir that area in which the valleys between these ranges are steep and narrow, as well as the portion in which the valleys are flat and wide, terming the former Low Pamir and the latter High Pamir. English authors also extend the meaning of the word "Pamir," but in another sense. As used by us, the term connotes not only the floor

of a wide mountain-valley, but also the slopes that bound it on either hand. The "High Pamir" of the Russian traveller we therefore speak of as "The Pamirs."

The climate of this region is rigorous, for the winters are long. July and August are the only months when its plants grow and flower. Though the days are then mostly bright, and the thermometer, an hour before sunset on an August afternoon, may register 75° F., the temperature during the ensuing night may be 14° F., and even in July snowstorms occur. As a rule, however, bitterly cold winds blow day after day until sunset, and, even when the days are calm, brief but violent evening gales may sweep down the mountain-slopes, carrying with them gravel and stones. At noon on an overcast August day the water welling from a hot spring may be partly converted into ice as it trickles away. The air is dry; in 1898 the average humidity was 38 in July and 21 in August. Periods of more than three months may pass without falls of rain or snow. Even on the high passes in March the snow is rarely so deep as to impede travel, for at 12,500 ft., the elevation at which the Kirghiz seek winter-quarters, it does not prevent their herds from finding pasturage.

Seen from a high divide, the valley-floors below appear brown save for the narrow green belts which skirt the rivers. One looks north over a valley to a brown mountain-slope the wide screes of which resemble darker shadows; or south to another mountain-slope with a green zone close under its snow-fields, green patches near its mountain-streams, and usually a fainter green tinge elsewhere. In the clear atmosphere, the lines of the watercourses that score the mountain-slopes are well defined, and seem deeper than elsewhere on slopes facing east or west. This appearance is deceptive; what from afar are taken for the shadows of deep clefts one finds on closer view to be lines of vegetation along the south side of each shallow stream-bed (Fig. 1). The reaction of the vegetation both to exposure and to moisture at the root is, in this region, so marked as to be perceptible miles away.

Our floristic knowledge of the High Pamir is considerable. Before 1890 Russian travellers had visited the region. In 1891 Sir F. E. Young-husband collected a few plants in the Taghdumbash, an eastern Pamir. In 1895 an Indian Pamir Boundary Commission, approaching by way of Gilgit and Bozai Gumbaz, entered the region from the south on July 20, and remained there until September 16. During this period Lt.-Col. Alcock was able to visit the eastern end of the Great, and to make a thorough botanical investigation of the Little, Pamir. A list of the species collected, prepared by Mr. J. F. Duthie, was published in Alcock's "Report on the Natural History Results" of this Commission on April 12, 1898. In June, 1898, a Danish expedition, led by

¹ "The Second Danish Pamir Expedition. Conducted by Lieut. O. Olufsen. Studies in the Vegetation of Pamir." By Ove Paulsen. Pp. ix+132. (Copenhagen: Gyldendalske Boghandel, 1920.)

Lieut. (now Prof.) O. Olufsen, entered the High Pamir by the Kisil-art pass (14,300 ft.) on its northern border, spent a month in camp near Lake Jashil-kul (13,500 ft.) in the Alichur Pamir, and in September marched south to the western end of the Great Pamir, and thence through Wakhan and Goran to Chorock (7000 ft.) in Shugnan. After wintering there from November, 1898, to February, 1899, the expedition retraced its steps and left the High Pamir by the Kisil-art at the end of March. The floristic results of this expedition have been published in numerous papers, mainly by Prof. Paulsen, a member of the expedition. In 1901, and again in 1904, the

we find that, while many plants are common to all, some are peculiar to each. We still await an equally careful survey of the Pamirs with streams that flow eastward, and of the slopes which overlook Kashgar.

While the last word cannot yet be said with regard to the phytogeography of the High Pamir, B. Fedtschenko, probably justifiably, felt, after his first visit in 1901, that the time was ripe for an ecological review of its vegetation. In this he recognised eight distinct plant-associations—aquatics; river-bed bushes; plants of the haughs along the river-banks; plants of the bluffs between the haughs and the true valley-floor; "desert"

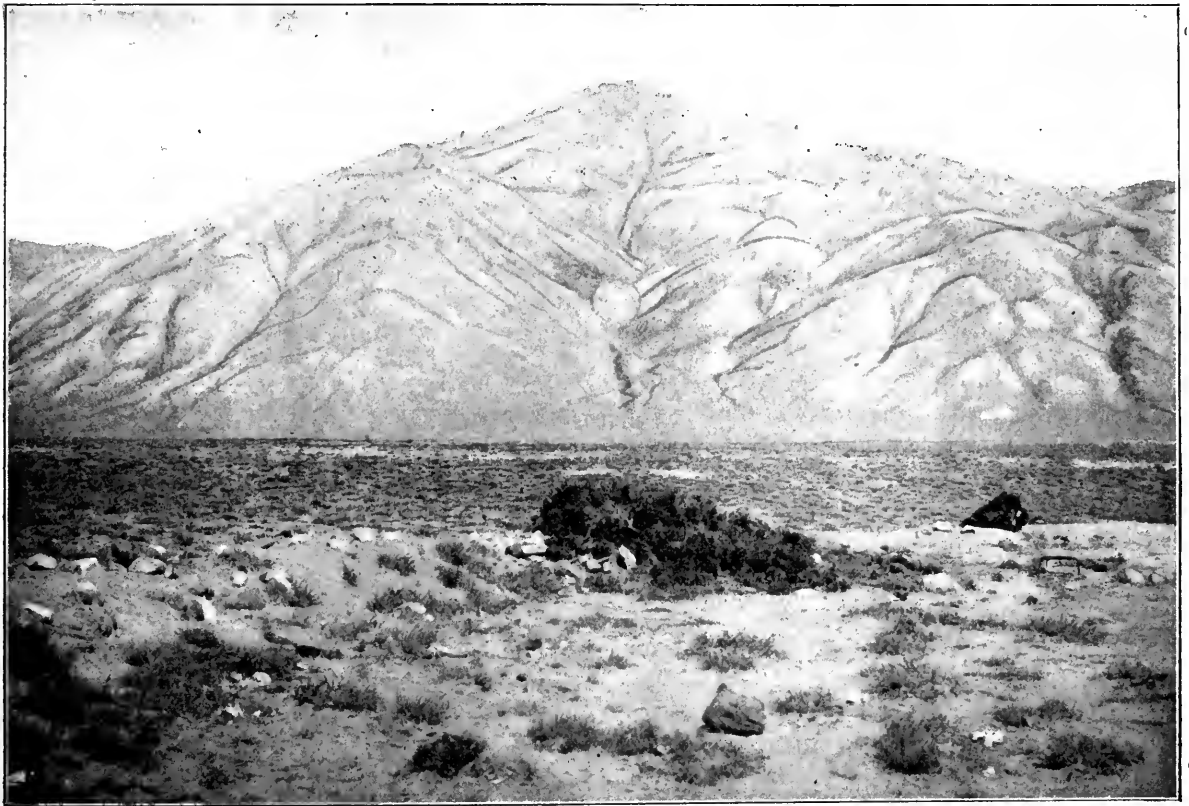

FIG. 1.—The plain east of Mardjanaj. In the foreground a heap of fuel, tufts and stems especially of *Artemisia*, *Eurotia*, and *Chrysanthemum amiricum*. The mountain behind shows dark vegetation lines in furrows of dry watercourses. From "Studies in the Vegetation of Pamir."

High Pamir was traversed by Mme. Olga Fedtschenko and her son, Mr. Boris Fedtschenko, both well-known authorities on the flora of Turkestan. The route of the Danish expedition was followed in both cases, so that Alcock is still our only authority for the area investigated by him. The systematic results of these journeys have been incorporated by Mme. Fedtschenko in a "Flore du Pamir," published in 1903, with supplements in 1904, 1905, 1907, and 1909. However, our knowledge of High Pamir plants is probably still incomplete. All the valleys investigated by Alcock, by the Danish party, and by the Fedtschenkos are drained by rivers which flow to join the Oxus, and, even as regards these Pamirs,

vegetation of the actual undulating valley-floor and of the major portion of the downs and slopes enclosing the valleys; patches of alpine meadow along brooks fed by melting snows; alpine meadows close under the snow-line; and willow-thickets in one particular sheltered ravine in the Jaman-tal. In summarising his results Fedtschenko has grouped these associations, with an additional salt-marsh-association, in three distinct plant-formations—meadows, subdivided into alpine patches, damp-meadows, and salt-marshes; stony wastes, including what he terms "Eurotia desert" and the vegetation of the bluffs leading from the valley-floor to the riverside haughs; and woody formation, including the *Myricaria*

bushes of boulder-strewn stream-beds and river-banks, and the willow thickets of the Jaman-tal.

In his careful ecological study of the results of the Danish expedition, Paulsen, with arguments that compel conviction, suggests that these "stony wastes" scarcely fall within the "desert" category. Fedtschenko's "Eurotia desert," in particular, Paulsen prefers to regard as "fell," using this term with a connotation corresponding with that of the word "forest," to signify that the plants involved show adaptation to cold and snow rather than accommodation to drought and heat. High Pamir plants display few expressions of adaptation to drought; their habit and their histology alike suggest that they are more influenced by strong light than by dry air. Further, they agree more closely, on the whole, with alpine than with arctic plants, and their structure suggests that they are affected more markedly by the altitude at which they grow than by the climate they have to endure.

The formations recognised by Paulsen for the dry High Pamir are four in number, and are named, from characteristic species in each, the *Trigonella*-, the *Eurotia*-, the *Arenaria*-, and the *Poa attenuata*-formations. Of these the *Trigonella*-formation is defined as the vegetation, largely xerophytic, of the valley-floors of the High Pamir, and the *Eurotia*-formation as the xerophytic vegetation on mountain-slopes with a southern or a western exposure; the *Arenaria*-formation is a special association, only seen well-developed near Lake Jashil-kul, which is a transition between the *Trigonella*-formation and the mesophytic vegetation on mountain-slopes exposed to the north; and the *Poa attenuata*-formation includes all the mesophytic associations of mountain-slopes with a northern aspect. In his comparison of the two systems, Paulsen regards Fedtschenko's alpine meadows as identical with his own *Poa attenuata*-formation; unites Fedtschenko's damp-meadows and salt-marshes in what he himself terms "swamp-meadow"; and recognises Fedtschenko's "woody formation." As regards Fedtschenko's "Eurotia desert" and "Bluff" associations, Paulsen's concordance is of a tentative nature; he suggests that the former may be his own *Trigonella*-formation, the latter his own *Eurotia*-formation. Clearly, however, the *Eurotia* desert of Fedtschenko includes the *Trigonella*-, the *Arenaria*-, and the *Eurotia*-formations of Paulsen, who apparently does not regard Fedtschenko's "Bluff" association as a definite entity. There is nothing save Fedtschenko's expression "and so forth" to support the suggestion that this author's "Abhänge u.s.w." may include mountain-slopes with a southern exposure; the "Bluff" association plants mentioned by Fedtschenko are not met with on the slopes to the north or east of a flat valley-floor. Interesting though this particular plant-association may be, a student of the High Pamir vegetation may be excused if he regards it as being, like the "woody formation" in the boulder-strewn river-beds, an intruding element that, favoured by special conditions, has extended up-

wards from the narrow valleys of the Low Pamir. For the sake of convenience we may also exclude the floating and submerged plant-associations of the marshes and lakes, not as being devoid of interest, but as not being distinctive of the High Pamir.

When the vegetation characteristic of these Pamirs is regarded from the English traveller's point of view, account must be taken both of the open surface of the valley-floor and of the slopes that rise from it on either hand. In dealing with the open surface we may begin with the green ribbon of vegetation that skirts the streams and fringes the lakes. This green belt includes two marked plant-associations: water-meadows or marshes, characterised by the presence of tufted sedges; and haughs of mountain meadow grasses mixed with which are many gay alpine plants. These High Pamir marshes may furnish, all told, some forty species, whereof a score are to be expected in any single Pamir. The haughs may supply about fifty species, of which one-half to two-thirds may be present in any one valley. These two plant-associations constitute one plant-formation, composed exclusively of mesophytic plants. In this respect it does not differ from the *Poa attenuata*-formation of the slopes with a northern exposure that bound the valley to the south or the west. Though as rich in species as the rest of the valley-floor, this green belt is less interesting ecologically than the open surface above the Bluff.

That open surface, notwithstanding its bare appearance as seen from above, is far from being devoid of vegetation. If the flora be of a poor type, that type is highly developed, and is made up of scattered tufted xerophytes with an admixture of cushion-plants. The individual plant-clumps are often a yard or more through, and usually a pace or two apart, so that, where vegetation occurs at all, it clothes approximately half the ground, though scattered irregularly over the valley-floor are many bare stretches of hard sand and shingle, variable in extent, and often coated with a saline efflorescence. Sometimes such saline spots sustain a few halophilous species, which thus constitute a distinct plant-association, while in the vicinity of the hot springs that occur in some of these high valleys a few peculiar species constitute yet another association. Excluding these two relatively unimportant elements, the vegetation of the High Pamir valley-floors, taken as a whole, is remarkably uniform throughout the region, and may be regarded as a distinct plant-formation. The number of species involved varies somewhat in different valleys; thirty may perhaps be a fair expectation for a particular Pamir; fifty is about the number for the High Pamir as a whole. The formation is, then, about as rich in species as the riverside mesophytic one, but in this case the species most plentiful in any single Pamir are, with few exceptions, those most plentiful in all the valleys.

Along the route followed by the Danish expedition and the Russian travellers the slopes that

overlook the valleys from the north or the east differ greatly from the anticlinal ones. The great screes along the base of a northern or eastern range are nearly, if not quite, bare; the rocky stream-beds and the open slopes are sparingly furnished with some of the more drought-resisting members of the plant-formation on the valley-floor below. The Little Pamir, however, is described by Alcock as having grassy downs on either hand. The long axis of that Pamir runs from west-south-west to east-north-east. We may therefore conclude that the slope which looks south also looks sufficiently east to escape extreme desiccation, while the one which looks north does not look sufficiently west to bring about that condition. The western influence on this slope may explain the absence from Duthie's Little Pamir list of many of the species present in some of the other Pamirs, in spite of the fact that Alcock collected every plant he saw except a rhubarb never met with in flower. In valleys other than the Little Pamir the total number of species recorded from mountain-slopes looking south or west scarcely reaches a score, all of them distinctly xerophytic in character.

On slopes with an eastern, and especially with a northern, aspect a relatively luxuriant flora, rich in species of a more or less mesophytic character, makes its appearance and constitutes a plant-formation closely related to, and perhaps not really distinct from, the mesophytic formation in the haughs along the banks of the main stream below. The two formations are, in fact, continuous through the mesophytic vegetation that accompanies the streams, fed from snow-fields or small glaciers, the broad channels of which open on the valley-floor at right angles, and cross that floor in order to join the river. Nearly four times as many species are met with on mountain-slopes with a northern exposure as may be found on those that front the sun. The increase in amount of vegetation is even more marked than the increase in the number of species. The poor and open furniture of the sun-baked slopes looking south or west gives place to a plant-covering usually closer, on these moister slopes that face the north, than on the open valley-floor.

The relationship between the vegetation of a flat Pamir and that of the containing slopes is fully understood only if it be realised that the valley-floor plant-formation is a "complex" of at least three distinct plant-associations. When this floor is quite horizontal all the species of the formation may be intermingled; but this condition is rare. Usually the surface is undulating, and more plants are to be found on the rises than in the depressions. Some species in the depressions grow equally freely on the rises; a few prefer the depressions; one or two are confined to them. On the rises the plants on the side facing north or east differ from those on the side facing west or south, and this arrangement is repeated with every rise from end to end of a Pamir. Though these slopes are never very pronounced, the adjustment between the species concerned and

the conditions that affect them is so fine that, even when the inclination is too slight to be perceptible to the eye or the muscular sense, the alternating bands of species appropriate to the anticlinal exposures demonstrate undulation of surface, and reveal the effect due to the enjoyment of a greater or less amount of heat and light, and of a larger or smaller supply of moisture.

Cushion-plants like *Acantholimon diapensioides*, one of the commonest of High Pamir plants, may occur on either aspect of a rise or in the depressions between successive rises; they may even be met with occasionally on the screes. In spite of this wide power of accommodation, *Acantholimon* does not appear on slopes exposed to the north. The very xerophytic *Eurotia ceratoides*, another common and widespread species, is, however, almost confined to the southern or western aspect of the undulations; this plant may occasionally be found on the screes, and is perhaps the species most characteristic of dry mountain-slopes facing the south. These slopes, indeed, rather than the valley-floor, might be looked upon as the distinctive home of *Eurotia*, were it not that the genus invades from the valley-floor those mountain-slopes that face the north. In many places these latter slopes show faintly that alternation of ridge and depression which is so marked a feature of the valley-floor. The depressions on such a hillside provide a footing for vertical bands of green vegetation composed wholly of mesophytic plants; the ridges between, even when barely perceptible to the eye, are marked by the presence of sparsely scattered small tufts of *Eurotia*. The grass *Stipa orientalis*, another common High Pamir plant, grows freely on either face of the undulations in the valley-floor, but avoids the intervening depressions. It is as much at home on high slopes facing west or south as is *Eurotia*; often these two are the only plants to be found on such dry slopes.

Among the valley-floor plants that are confined to the eastern or northern aspect of the undulations is *Trigonella Emodi*, and it is on this account that Paulsen has termed the vegetation of the valley-floor the *Trigonella*-formation. It has, however, to be noted that this species has not been recorded from the Little Pamir, although from Alcock's account the vegetation of that valley-floor is essentially the same as the vegetation of the other flat Pamirs. A species that occurs only in the depressions on the valley-floor is *Arenaria Meyeri*. This plant gives its name to the *Arenaria*-formation of Paulsen, a local plant-formation which links the vegetation of the valley-floor with that of the slopes exposed to the north. The species most distinctive of these high mountain-slopes with a northern aspect is *Poa attenuata* (Fig. 2), which Paulsen does not record from any valley-floor, but which, it would appear from what Alcock tells us, may be found in the Little Pamir not only on the mountain-slopes to the south, but also on the open surface of the valley, and even on the downs to the north. On this and on other mountain-grasses feed the herds of

Marco Polo's "exceeding great wild sheep, having horns, some of them six spans long," the "forms" of which, Alcock tells us, are to be

had been told that in this region "are excellent pastures, so that in them a lean horse or an ox may be fat in ten days." Five hundred years later the same opinion was expressed in very nearly the same words, for Lieut. J. Wood, who journeyed to the sources of the Oxus eighty years ago, was assured by the Kirghiz that "the grass of the Pamir is so rich that a sorry horse is here brought into good condition in less than twenty days." The experience of the Pamir Boundary Commission of 1895 did not belie these older estimates, for Alcock informs us that, "of the many pack-animals met with on our return march from Gilgit to Kashmir, none approached our baggage-ponies in condition."

Pamir air may perhaps assist the Pamir grass, for the climate of these lofty uplands is as healthy as it is severe. Paulsen describes in poetic terms the sense of well-being experienced by the Danish explorers during their halt near Lake Jashil-kul in August, 1898. Their days, it is fair to admit, were days of gentle breeze or calm. If such halcyon seasons be a feature of the valley sheltered by the Shatyr-tash, that Pamir is favoured beyond those that lie between the Ak-baital pass and the Alai range, or those between the Chargush pass and the Hindu-Kush.

However this may be, Prof. Paulsen, in these "Studies," has provided an account of the High Pamir and its vegetation so clear and so fascinating that his readers must feel prepared to face the bitter winds experienced by Alcock in the Aksu Pamir in 1895, and by Fedtschenko in the Karakul Pamir in 1904, should fate

afford any of them an opportunity of visiting the region and subjecting the eastern valleys to the careful study bestowed by him and his companions on so many of the western ones.



FIG. 2.—*Poa attenuata*, Trin. (about half natural size). From "Studies in the Vegetation of Pamir."

found especially on the bare, unstable scree to the north of a Pamir. The economic botanist knows that *Ovis poli* is not the only creature which finds this herbage wholesome. Marco Polo

Primitive Chronology.

By DR. J. L. E. DREYER.

THE study of the ideas of uncivilised races with regard to chronology has generally been left to travellers who derived their information from natives among whom they dwelt for only a short time. The progress of civilisation among such races has often made it difficult to obtain trustworthy information about the way in which the

division of time was formerly regulated among them. When attempts have been made to collate the information to be found in books of travel and in works on ethnography, as has been done in the ninth chapter of Ginzler's "Handbook of Chronology" (vol. ii.), the result has been a collection of scraps rather than a systematically

arranged account of the first steps made by mankind towards a knowledge of the division of time. The detailed work on this subject by Prof. Nilsson,¹ of Lund, is, therefore, a most welcome addition to the literature of chronology, and, being based on a thorough study of the immense number of publications on the ways of primitive nations, it is fit to form an introduction to the great work of Ginzler, which chiefly deals with the chronological systems of more advanced races.

To the lowest tribes of mankind the seasons are the earliest units of time. Except in the tropics, hot and cold seasons succeed each other, and where the year is not spoken of, the number of summers or winters which have elapsed since a certain event took place is the earliest way of describing intervals of time. This practice is often continued in more civilised times—*e.g.* in the Middle Ages among Scandinavians and Anglo-Saxons time was reckoned in winters. In some localities the atmospheric conditions are such that two divisions of the year may be distinguished by the winds, as in the Marshall Islands, where months of calm and months of squalls succeed each other. In other places there are regularly recurring dry and wet seasons. People who engage in agriculture often divide the year into a greater number of seasons, eight or nine, according to their occupations, and even in China there is found, alongside the luni-solar year and its subdivisions, another system of dividing the year into twenty-four parts, the names of which refer partly to the weather, partly to other phenomena. In northern India there were originally (as there still are in Burma) three seasons, a hot, a rainy, and a cold, among which two or three transitional ones were later interpolated. Similarly, the Indo-European nations had three seasons—winter, spring, and summer—which were later subdivided into shorter seasons of ploughing-time, hay-making-time, etc.

Though we have spoken of the year being subdivided into various parts, this must not be understood as meaning that the use of the solar year is as old as the time-indications referring to natural phenomena. Not seldom the dry and rainy or warm and cold seasons are counted without being combined into a year. In Iceland there still exists a curious calendar, which divides the year into two parts—*misseri*—and the people count so many *misseri*, not years. Until midsummer (or midwinter) they reckon forwards, and say that so many weeks of summer (or winter) have passed; after that they say that so many weeks remain. The climatic year is a cycle which has no regular beginning, but the agricultural year has a natural beginning, which is generally marked by the rising of a certain star or group of stars, often the Pleiades, before sunrise (the heliacal rising).

The word for "year" is usually one referring

¹ "Primitive Time-reckoning: A Study in the Origins and First Development of the Art of Counting Time among the Primitive and Early Culture Peoples." By Prof. Martin P. Nilsson. (Skrifter Utgivna av Humanistiska Vetenskaps-samfundet i Lund, I.) Pp. xiii+384. (Lund: C. W. K. Gleerup; London: Humphrey Milford; Oxford University Press, 1920.) 21s. net.

to produce, but among the lowest races only a few years are counted, perhaps three or four; everything further back is merely said to have happened "some time ago." This is often sufficient, as such savages are frequently not interested in their own age or in that of other people, but only in that of their cattle. As to epochs from which the years may be counted, it is not until the beginning of history that the accession of kings is used for this purpose. Before that time some unusual event marks an epoch, such as a very severe winter or a great war, and as culture progresses such events multiply; and when their succession is known, a longer period is the result. This method of distinguishing the years was employed in ancient Babylonia, in the days of the Sumerian kingdom of Ur, in the second half of the third millennium B.C. The king's accession marks only one year, the others being named by events in the religious cult and politics. Similarly, in the older period of Egyptian history each year is described by an official name borrowed from the festivals—*e.g.* those of the king's accession, of the worship of Horus, of the sowing, etc.

The natural subdivision of the year is formed by the period of revolution of the moon with regard to the sun, or, what comes to the same thing, the period of its changing appearance, its phases. Man's attention must have been directed to the moon from the very infancy of time, as the course of the moon from the first appearance of the new to the disappearance of the old is short enough to be surveyed by the undeveloped intellect. Almost everywhere the "month" as a unit of measure is denoted by the same word as the moon. At first no attention was paid to the number of days in the month, and many primitive peoples cannot even count as far as thirty. But the changing form of the moon is sufficient as an indicator of time, and greater refinement of observation is by degrees attained until every day of the moon's revolution is described by a name. Such names often not only refer to the phases of the moon, but also indicate its position in the sky. The first appearance of the lunar crescent is an important event carefully watched for and often celebrated as a feast day. The full moon also gives rise to special feasts; half Africa dances in the light of the full moon. So did the ancient Iberians and many others.

The next step in the progress of primitive chronology is to group a number of months together into a cycle. At first, uncivilised peoples with an undeveloped faculty of counting can numerically determine only a couple of months before or after the time of the moon at the moment visible in the heavens. The months are then given names from the principal agricultural operations going on when the moon appears and while it lasts, and this often leads to the same moon having several names. If all the names in use among Melanesians were counted, the year of the natives would seem to be made up of twenty or thirty months. At this stage the question how

many months there are in the year does not exist, and in some cases the reckoning by moons is not even extended to the whole year. There is a time when nothing particular happens and nobody takes the trouble to observe or name the moons; such a period is, for instance, the depth of winter in the far north. It is next realised that the succession of seasons is intimately connected with the motion of the sun. In northern countries it is noticed by people having a fixed dwelling-place that as midsummer is drawing near the sun is rising further and further north until a limit is reached. In this way the date of the summer solstice, and similarly that of the winter solstice, are determined, and a rough idea of the length of the year is obtained, and is improved by observing the heliacal risings of

certain stars. It is thus found that the year is longer than twelve moons, and shorter than thirteen, and the next problem is how to make the lunar months fit into the solar year by the occasional interpolation or omission of a month. This is the beginning of scientific chronology as we see it arise and developed among the Babylonians and the Greeks.

Prof. Nilsson's valuable work was written by him in Swedish, and translated into English by a colleague in the University of Lund. The translator has followed the original closely, sometimes too closely, and he uses some curious expressions, such as "the phases of the stars," or the "shifting year" of the Egyptians (meaning their vague year). But these are trifling faults in an otherwise excellent book.

Obituary.

PROF. A. W. REINOLD, F.R.S.

ARNOLD WILLIAM REINOLD, who died on April 11, was born at Hull on June 19, 1843, and was the son of John Henry Arnold Reinold, a shipbroker at that place. He was educated at St. Peter's School, York, and matriculated at Brasenose College, Oxford, in 1863, as an open Somerset scholar. He had a distinguished career as a mathematician, obtaining the University junior and senior mathematical scholarships, first classes in mathematics, moderations, and finals, and in the School of Natural Science. In 1866 he was elected to a fellowship at Merton, and in 1869 became Lee's reader in physics and a senior student at Christ Church. He was the late Prof. Clifton's first demonstrator in the Clarendon Laboratory, being succeeded by A. W. Rücker.

In 1873 Reinold was appointed professor of physics at the Royal Naval College, Greenwich. His life-work was done here, as he held the post for thirty-five years, retiring in 1908 on reaching the age limit, and being made a C.B. in 1911. This professorship was a new appointment, so that a laboratory and courses of physics had to be organised; the laboratory buildings were part of the sick quarters of the old hospital, and finally occupied a considerable amount of space. Besides our own naval officers, gunnery and torpedo lieutenants, naval architects and engineers, etc., there were occasionally foreign students working here, and Reinold received a medal from the Emperor of China in recognition of work with Chinese students. It was at Greenwich that he collaborated with Rücker in a series of investigations on the properties of liquid films, the first paper appearing in the Proc. Roy. Soc. for 1877, and the final one in the Phil. Trans. for 1893, with several between. He was a lecturer at Guy's Hospital for most of his time at Greenwich, and a joint editor for several editions of Ganot's "Physics."

Reinold was signally devoid of any hobbies, and seemed to have no recreations. His interests

apart from his work were mainly in the Physical Society, of which he was an original member, if not one of the founders, acting as secretary from the beginning until 1888, when he became president for two years; and in the Royal Society, of which he became a fellow in 1883, and on the council of which he served for some years. He was a sensitive man with a charming manner, and was liked by all who came in contact with him, being always courteous and gentlemanly in the fullest sense. Reinold retained his activities, mental and otherwise, to the end, which occurred very suddenly; he had just undertaken to write an obituary notice for the Royal Society of his old chief, Prof. Clifton. Married about 1866 to Miss Marian Studdy Owen, he leaves a family of one daughter and three sons.

W. N. S.

ROBERT ALLEN ROLFE.

SYSTEMATIC botanists, and especially orchidologists, have sustained a grievous loss by the death on April 13, after rather more than three months' illness, of Mr. R. A. Rolfe, who, for upwards of forty years, was an assistant in the Herbarium of the Royal Botanic Gardens, Kew. Mr. Rolfe was born at Ruddington, near Nottingham, on May 12, 1855. He joined the Kew Herbarium staff in 1880, as a result of a public competitive examination, having previously gained some experience among cultivated plants in the famous gardens at Welbeck Abbey, Notts, and at Kew. It was anticipated that he would retire from service next month, and a visit to Central America was projected, for which a grant in aid had actually been voted by the Government Grant Board of the Royal Society.

Mr. Rolfe's contributions to botanical literature have been numerous and important. For many years past he was the generally accepted authority in this country on the Orchidaceæ; it might truthfully be said that his reputation was world-wide. He founded the *Orchid Review* in 1893, and edited and wrote to a large extent the twenty-eight

annual volumes published. He paid attention to several widely different groups of plants, while he was keenly interested in the problems concerning hybridisation.

Mr. Rolfe was elected an associate of the Linnean Society in 1885. He received many distinctions. In February last he was awarded the Victoria medal of the Royal Horticultural Society and the gold medal of the Veitch Memorial Trust Fund. Mr. Rolfe's work was well done. He was esteemed by all who knew him, and his many amiable qualities won for him the affectionate regard of his numerous colleagues and friends.

PROF. ISAO IJIMA, who died of apoplexy in Tokyo on March 14, was born in 1861, and received his training as a zoologist in Tokyo from Prof. C. O. Whitman; and his first papers, on the leech *Nepheleis*, were contributed to the *Quarterly Journal of Microscopical Science* and *Zoologischer Anzeiger* (1882). Continuing the study of various worms, he was attracted to the laboratory of Leuckart; but after his return to Japan, about 1890, he began a long series of researches on the

beautiful Hexactinellid sponges of the neighbouring seas. In a series of papers published in the *Journal of the College of Science of Tokyo University*, Ijima threw light on the structure and development of many of these siliceous sponges. On the death of Mitsukuri, Ijima became senior professor of zoology at Tokyo University. Though administrative duties checked the flow of papers, he had prepared the manuscript of a large monograph on the Hexactinellidæ, which, it is to be hoped, will soon see the light. Ijima was a good shot, a keen fisherman, an all-round naturalist, and a charming companion. He leaves many friends and a succession of distinguished pupils.

THE death is announced, in *Science* of April 8, of DR. JOHN IRIDELLE DILLARD HINDS, at the age of seventy-three years. Dr. Hinds was one of the founders of the American Chemical Society, and for forty years acted as professor of chemistry, first in Cumberland University and later in the University of Nashville and Peabody College. At the time of his death he was chemist to the Geological Survey of Tennessee.

Notes.

THE first of the two annual soirées of the Royal Society will be held at Burlington House on Wednesday, May 11.

IN consequence of industrial disturbances, the Congress of Radiology, fixed for April 14 and following days, has been postponed until the spring of 1922.

IT is announced that the King has approved the conferment of the honour of knighthood on Dr. James Craig, King's professor of medicine at Trinity College, Dublin, and president of the Royal College of Physicians of Ireland.

THE *British Medical Journal* for April 16 states that the Government of Panama has assigned the sum of 10,000,000 dollars for the erection in Panama of the proposed Institute for Tropical Diseases in memory of the late Surg.-Gen. Gorgas.

NOTICE is given by the Ministry of Agriculture and Fisheries that applications for grants in aid of scientific investigations bearing on agriculture will be received until May 15 next. Copies of form A.230/I., giving particulars of the conditions under which the grants will be made, are obtainable from the Secretary of the Ministry of Agriculture and Fisheries, Whitehall Place, S.W.1.

IT is announced in *Science* for March 25 that the American Engineering Council has joined with the National Association of Manufacturers, the American Patent Law Association, the American Chemical Society, and the National Research Council in a movement to bring about reforms in the United States Patent Office. A committee on patents has been appointed which is representative of mechanical, electrical, civil, mining, and metallurgical engineers in the United States in order to deal with this subject.

THE subjects for discussion at the seventh International Fisheries Congress, which will be held at Santander, in Spain, on July 31-August 8, are:— (1) Oceanography, physical, biological, and meteorological; (2) technique of sea- and river-fishing; (3) fish, oyster, and mussel culture; (4) the industrial exploitation of the produce of the fisheries; (5) social problems; and (6) statistics and legislation. Papers for consideration ought to be sent to the Secretary-General of the Congress (*via* the Ministry of Agriculture and Fisheries) before June 1. The British Fisheries Society (which expects to be in being very shortly) is opening a subscription for the purchase of medals (six at 45s. each and six at 21s. each), and it is proposed that these should be awarded by the society for the two best papers in each of the above sections of the congress. The society invites British writers to submit papers.

THE Faraday Society is organising a general discussion on physico-chemical problems relating to the soil to be held during the afternoon and evening of May 31 in the rooms of the Chemical Society, London, and presided over by Sir Daniel Hall, Chief Scientific Adviser to the Board of Agriculture. The discussion will be opened by Dr. E. J. Russell, director of the Rothamsted Experimental Station, who will give a general survey of the subject. A series of papers dealing with soil moisture, organic constituents, adsorption, and colloidal phenomena will then be put forward as a basis for discussion. It is expected that among those present will be Prof. Sven Oden, of the University of Upsala. Further particulars of the meeting may be obtained from the Secretary of the Faraday Society, 10 Essex Street, London, W.C.2.

THREE Chadwick public lectures on "Fever in England: Their Prevention and Control" will be delivered by Dr. William Hunter at the lecture-room of the Medical Society of London, 11 Chandos Street, Cavendish Square, W.1, on May 5, 12, and 19 at 5.15 p.m. The lectures are intended as a review of the progress made in the science of public health during the past century, special attention being given to the Public Health Acts (1848-1918). The first lecture will deal with sanitary reforms achieved during the period 1800-70; in the second the effects of the establishment of fever hospitals and the recognition of the value of antiseptic measures and protective inoculation during the period 1871-90 will be discussed; and in the third lecture, covering the period 1891-1920, the effects of compulsory notification and isolation will be described and some account given of the present position of medical knowledge on the subjects of typhus and relapsing fevers, measles, whooping cough, and influenza. Admission to the lectures is free in all cases.

THE presentation of the first award of the Kelvin medal will be made by the Right Hon. A. J. Balfour in the hall of the Institution of Civil Engineers to Dr. W. C. Unwin on Wednesday, May 4, at 4 o'clock. The medal was founded in 1914, principally by British and American engineers, to commemorate the achievements of Lord Kelvin in those branches of science which are especially applicable to engineering. The award is dealt with by a committee of the presidents of the representative British engineering institutions after their consideration of recommendations received from similar bodies in all parts of the world, and, in accordance with the terms of the trust, it is made to the person whom the committee finds to be most worthy to receive this recognition of pre-eminence in the branches of engineering with which Lord Kelvin's scientific work and researches were identified.

THE council of the Institution of Mining and Metallurgy presented the thirtieth annual report (for the year ending December 31, 1920) at the annual general meeting held on April 21. During the year a joint conference was held with representatives of the Institution of Mining Engineers with the view of promoting co-operation between the two bodies. The recommendations of the conference were adopted, with the result that the Institution of Mining Engineers will in future be accommodated in the house of the Institution of Mining and Metallurgy; each body will retain its identity, but they will be administered by one secretariat. The important question of the registration of engineers came into prominence during the year, when the council of the Institution of Civil Engineers decided to promote a Bill in Parliament for the registration of civil engineers. While accepting the principle of registration, the council of the Institution of Mining and Metallurgy deprecated the control over all branches of the profession of engineering which this Bill would confer, and, in company with other bodies representing various branches of the profession, protested to the council of the Institution of Civil Engineers. The latter has

since decided not to proceed with the Bill, but to apply for a supplemental Royal Charter to authorise the use of "Chartered Civil Engineer" by its members. Two awards have been made by the Institution of Mining and Metallurgy during the past year; the institution's gold medal has been awarded to Sir Thomas Kirke Rose, in recognition of his services in the advancement of metallurgical science, with special reference to the metallurgy of gold, and the New Consolidated Gold Fields, Ltd., gold medal and premium of 40 guineas to Mr. H. Livingstone Sulman, for his paper "A Contribution to the Study of Flotation." Mr. F. W. Harbord has been elected president for the year 1921-22 in succession to Mr. F. Merricks.

THE Peabody Museum, Harvard University, issues in vol. viii., No. 1, of its Proceedings an account of the excavation of an Indian village site and cemetery near Madisonville, Ohio, which has furnished much interesting archaeological material. In all, 1236 bodies were exhumed, probably belonging to the Shawnee tribe, and occupied prior to 1672. Three forms of burial—horizontal, contracted, and in a sitting posture—were observed; they indicate a grouping resulting from numerous simultaneous interments or a species of division into family lots. There was no consistent rule of orientation, but the south, east, and south-east were generally selected. Full details of the skeletons, with the objects associated with them, are given.

IN the Journal of the Royal Anthropological Institute (vol. 1., January-June, 1920) Mr. J. H. Hutton gives a curious account of a form of lycanthropy current in Assam among the Naga tribes. All these people regard the ultimate ancestry of man and the tiger or leopard as very intimately associated. Man and the tiger are still regarded as brothers, and if an Angami kills a tiger he says, "The gods have killed a tiger in the jungle," never "I have killed a tiger"; while the village priest proclaims a day of abstinence from work "on account of the death of an elder brother." Though the Angamis suppose that lycanthropy exists and can be acquired, they do not indulge in it themselves, but believe in the existence of a village far to the east peopled by lycanthropists—a belief perhaps based on the claim of the Changs to possess the faculty of taking tiger or other animal forms. The soul usually enters the leopard during sleep and returns to the human body with daylight, but it may remain in the leopard for several days at a time, in which case the human body, though conscious, is lethargic. The soul, however, is more or less conscious of its experiences in leopard form, and can to some extent remember and relate them when it has returned to its human consciousness.

WE have received Bulletin No. 2 of the Bureau of Bio-Technology (January, 1921), a newly established quarterly publication issued from the biological department of Messrs. Murphy and Son, of Leeds. Although it runs to only 25 pages, it contains two articles of considerable interest. One concerns the destruction of stored malt by the agency of a Dermestid beetle, *Trogoderma khapra*, Arrow. This

species has been recorded as an occasional rarity, but there appears to be no previous instance of its occurring in sufficient numbers to cause appreciable damage. There seems to be no doubt that the presence of this beetle is due to infected shipments of barley from Karachi and other Indian ports. The second article refers to Nematode worms in relation to leather manufacture, these organisms being found in large numbers during the process of removing wool from skins by means of "sweating." It is undoubtedly a healthy sign that a business house deems it worth while to issue a periodical of this nature. Apart from any function by way of advertisement, it should serve as an outlet for the publication of research work carried out in the firm's own laboratories. It is well printed and the illustrations adequately fulfil the purpose intended.

THE evolution of the lachrymal bone in vertebrate animals is discussed at great length and illustrated with nearly 200 beautiful figures by Dr. W. K. Gregory in one of his studies of comparative myology and osteology (Bull. Amer. Mus. Nat. Hist., vol. xlii., No. 4). The bone can now be traced back by almost every gradation to a dermal plate in the circumorbital ring of certain Devonian fishes. In the earliest amphibians this and the other bones of the circumorbital series become better differentiated, and in early reptiles the anterior part of the lachrymal is covered by the progressive upgrowth of the maxilla. In mammals the lachrymal and jugal are the only two parts of the primitive circumorbital series remaining, and the lachrymal is reduced as the upgrowth of the maxilla increases. There can be no doubt that the lachrymal of mammals is homologous with the bone similarly named in reptiles. The anatomy of the lachrymal and malar fossæ in the skull of horses and other hoofed mammals is also discussed by Dr. Gregory (No. 5). He concludes that the large lachrymal fossa of the extinct horse was occupied neither by a facial gland nor by muscle, but by the end of a greatly enlarged nasal diverticulum. The malar fossa seems to have lodged part of one of the lip-muscles.

THE structure and uses of balsa wood are fully described by Mr. R. C. Carpenter in Trans. Amer. Soc. Civil Engineers (vol. lxxxi., No. 125, 1917). This wood is the lightest known, a cubic foot weighing only 7.3 lb., yet its strength is fully half that of spruce. It has been used for rafts, floats, and life-preservers, and is now much employed, since it is a non-conductor of heat, for ice-boxes and refrigerators. Frozen butter sent from Virginia in a small balsa box arrived after an eight days' journey in summer weather at Los Angeles still hard and frozen. It is possible that containers made of balsa wood will eventually displace thermos flasks. Untreated balsa wood is of little value for most purposes because it soon rots and decays in consequence of its liability to absorb water. This has been overcome by R. A. Marr's process of waterproofing timber with a bath of which the chief ingredient is paraffin. Balsa wood is the product of various species of *Ochroma*, trees allied to *Bombax*, which have lately been elucidated by Prof. W. W. Rowlee in Journ. Washington Acad. Sciences (vol. ix., p. 157, 1919). The best known is *Ochroma lagopus*, Swartz, which occurs wild in

Cuba and Jamaica. Eight other species, including seven new to science, occur in the tropical forests of America, ranging from Guatemala and Honduras to Ecuador and Bolivia. *Ochroma limonensis*, Rowlee, is extraordinarily rapid in growth; a seedling in Costa Rica was 16 in. in diameter at the end of three years, and this individual is said to be in no way exceptional.

THE Geological Survey of Western Australia has published a series of memoirs intended especially to aid prospectors and miners. In addition to sections dealing with the occurrence, distribution, and production of the various minerals, there are a number of chapters designed to teach the prospector the rudiments of geology, mineralogy, and petrology so far as these are of use in discovering or developing the mineral resources of the country.

THE Imperial Mineral Resources Bureau has issued a small volume of statistical and technical information upon zinc covering the period 1913-19. It contains an excellent review of the zinc industry at the close of 1919 by Mr. Gilbert Rigg. Unfortunately, sufficient care has not been bestowed upon the all-important statistical portion; thus for 1913 the production of zinc-ore in the United Kingdom is given as 17,294 tons, capable of producing 5823 tons of spelter, while the quantity of imported ore is given as 64,670 tons. The production of smelted zinc is given as 66,000 tons, so that the quantity of imported ore given above must be assumed to have yielded about 60,000 tons of spelter, which is clearly quite impossible. Surely, too, an official British publication should not use the term "long" tons when "statute" tons are meant.

THE Meteorological Department of the Government of India has issued its report on the administration in 1919-20. Observations in connection with the upper air have been developed on behalf of the aviators who are from time to time crossing India. Storm warnings for stations in the Bay of Bengal and in the Arabian Sea are said to have been carried out successfully. It is, however, admitted that the warning of the storm which caused much damage to life and property in eastern Bengal on the night of September 24, 1919, was inadequate. Inland stations were not communicated with until early evening, and were then informed that a "slight to moderate storm" was expected. Special arrangements have been made to avoid the repetition of a similar mishap. The storm, which was tracked from September 22-25, developed rapidly as it approached, and crossed the Bengal coast as a cyclone about noon on September 24. It reached Dacca at about 2.30 a.m. on September 25, and finally broke up on that day in the Assam hills. At the centre the deficiency of pressure was about $1\frac{1}{4}$ in., and the calm area at least 15 miles in diameter. The total loss of life is estimated at 3500. The value of property destroyed was probably greater than in any storm in Bengal for the last two hundred years, but the destruction of human life was probably greater in the Bakarganj cyclone of 1876. An additional terror was caused by a vivid red glow appearing in the sky during the period of the lull. Details are given of the several storms which occurred during the

year. Flood warnings are issued, and the results are said to be very satisfactory. Rainfall data were received for publication from nearly three thousand stations for the year.

In the January issue of the *Journal de Physique* Prof. G. Bruhat, of the University of Lille, deals with some conclusions with regard to the variation of the specific heats of substances at low temperatures, in partial accordance with experiment, to which Nernst's theory of the solid or liquid state at absolute zero leads. The values of the specific heats of the same substance in different physical states at the lowest temperatures for which observations are available cannot be held to confirm the theory that the entropy of each modification tends to the same value at absolute zero. All that can be said at present is that Nernst's hypothesis is not contradicted by observation. Prof. Bruhat also points out that while the difference between the energies of two modifications of the same substance may be expanded in a series in ascending powers of temperature differences near the points of observation, there is no justification for continuing this expansion down to absolute zero.

MR. L. W. AUSTEN, of the U.S. Naval Radio Research Laboratory, contributes an interesting paper to the *Journal of the Washington Academy of Sciences* for March on the wave-front angle in radio-telegraphy. He gives the results of experiments made with a pivoted, straight-wire, antenna system mounted at the top of a 55-ft. wooden pole in such a way that it is capable of rotation about a vertical and a horizontal axis. The results show that for wave-lengths greater than 10,000 metres the deviation of the wave-front from the vertical cannot much exceed 3° . The average value of the deviation of the waves from Nauen, 3600 miles away, was 3.4° . It was found that the waves from San Diego, although they passed overland for 2000 miles, were practically vertical. Observations were made to see whether the well-known shift in the apparent direction of a sending station at night as determined by a radio compass was accompanied by any corresponding phenomenon in the value of the deviation of the wave-front. Although the apparent direction of the station shifted at times by as much as 30° , no appreciable change in the deviation of the wave-front could be detected.

THERE are many cases in engineering in which intense loading pressures are inevitable; for example, knife-edges, the line-contact of gear-wheels, the contact pressure of the wheels of a locomotive on the rails, etc. The results of a long investigation on contact pressures and stresses are given in a paper read before the Institution of Mechanical Engineers on March 18 by Prof. E. G. Coker, K. C. Chakko, and M. S. Ahmed. It is not possible to do justice to this paper in a short note. The authors have determined the stress distribution in a number of cases, e.g. the distribution of stresses, over different bearing areas, of a rectangular block pressed against another flat surface of greater area by a load applied at the centre of the opposite face. Another matter investigated is the effect on the strength of tensile

test-specimens of the minute indentations required for the attachment of extensometers and of the pressures produced by the extensometer grips. The latter case has been worked out completely, and diagrams giving the stress distribution are included in the paper. Prof. Dalby has abandoned the ordinary method of attaching his extensometer and uses special test-specimens having collars against which the mechanism of the extensometer presses lightly. The authors of the present paper have investigated the effect of the collars of the Dalby specimen, and find that there is ample justification for the use of this form of test-piece. The paper constitutes an extremely valuable record of the special methods of testing by means of polarised light with which Prof. Coker's name has long been associated.

WE welcome the first number of *Photographic Abstracts*, for it fills a distinct gap in scientific literature. This is not the first attempt of the Royal Photographic Society to do work of this sort, but it is the first time that the scheme has been properly financed and arranged by an enthusiastic committee, assisted by a large staff of efficient abstractors. The abstracts are classified under eleven headings:—Colour photography; cinematography; manufacture of photographic materials; photographic appliances (cameras, etc.); photographic optics; photo-mechanical processes; radiography; applications of photography (astronomy, spectroscopy, photomicrography, etc.); sensitometry, actinometry, photometry; theory of photography; and photographic processes. This first number is a distinctly creditable production, although the publication committee apologises for not having attained the ideal that it had in mind.

OUR knowledge concerning the chemical structure of catechin has been considerably increased by the series of papers recently published by Dr. Nierenstein and his collaborators, entitled respectively "The Constitution of Catechin, Parts I.-III.," and "Studies in the Chroman Series" (*Journ. Chem. Soc.*, 1920, vol. cxvii., and 1921, vol. cxix.). A successful effort has been made to complete the work of Ryan and Walsh, who attempted to decide between the chroman structure proposed for catechin by A. G. Perkin and the coumaran structure suggested by Kostanecki and Lampe. Acacatechin and several derivatives have now been synthetically produced and proved to be identical with acacatechin and its derivatives obtained from natural sources. This work of Dr. Nierenstein proves that catechin is a chroman, but that the chroman formula suggested by Perkin requires some modification, as acacatechin is 2:4:6:3':4'-penta-hydroxy-3-phenylchroman.

THE new list of announcements just issued by Messrs. Macmillan and Co., Ltd., contains the titles of many works of scientific interest. Among the books to be published between now and the end of June is one by Sir Clifford Allbutt entitled "Greek Medicine in Rome," being the Fitzpatrick lectures on the History of Medicine delivered at the Royal College of Physicians of London in 1909-10, with other historical essays. The essays will deal with Byzantine medicine; the Finlayson memorial lecture; Salerno; public medical

service and the growth of hospitals; a chair of medicine in the fifteenth century; the rise of the experimental method in Oxford; medicine in 1800; medicine in the twentieth century; and Palissy, Bacon, and the revival of natural science. Another work in the list is "A Treatise on Probability," by J. M. Keynes, the author of "The Economic Consequences of the Peace." It will be in five parts on, respectively, fundamental ideas, fundamental theorems, induction and analogy, some philosophical applications of probability, and the foundations of statistical inference. In addition, there will be an extensive bibliography. Messrs. Macmillan will also publish "The Angami Nagas, with some Notes on Neighbouring Tribes," by J. H. Hutton. It will appear under the direction of the Assam Administration.

A WORK entitled "Pre-history," by M. C. Burkitt, is announced for publication in the autumn by the

Cambridge University Press. It will be a study of early cultures in Europe and the Mediterranean basin, and contain a preface by the Abbé Breuil, with whom the author has collaborated in the study of prehistoric caves in France and Spain. Another autumn publication of the same publishers will be "A Manual of Seismology," by Dr. C. Davison, which will summarise present knowledge on the subject. It will be issued in the Cambridge Geological Series.

MESSRS. H. K. LEWIS AND CO., LTD., 136 Gower Street, W.C.1, have just published at 1s. net a Supplementary Catalogue for 1918-20 of their medical and scientific circulating library; also, gratis, their list of new books and new editions added to the library in January to March of the present year. The two catalogues should be in the hands of all who wish to be kept informed of the latest books in medical and general science.

Our Astronomical Column.

THE ACCELERATIONS OF THE SUN AND MOON.—The Journal of the British Astronomical Association for January contains an address by Dr. Harold Jeffreys on this subject. He starts by quoting the results obtained by Dr. J. K. Fotheringham from ancient observations of eclipses and other phenomena (Mon. Not. R.A.S., December, 1920), viz. 21.6" for the moon and 3" for the sun. These are the velocities gained per century per century; on the less logical system that gives the space gained in a century the figures are halved. Of the lunar figure 12.2" is due to the diminution of eccentricity of the earth's orbit. The remaining 9.4" for the moon and 3" for the sun are ascribed to tidal friction, which diminishes the earth's rotational speed, thus lengthening the day. It would, at first sight, appear that the effect on the moon should be thirteen times that on the sun, this being the ratio of their mean motions. Since, however, the mutual action of moon and earth does not alter the moment of momentum of the system, a retardation of the earth's rotation is accompanied by a recession of the moon and the consequent lengthening of her period, which cancels a considerable part of the apparent acceleration due to the slower rotation. Dr. Jeffreys notes that the theoretical values of solar and lunar accelerations due to tidal friction are uncertain, and may be anywhere between 1 to 3 and 1 to 10. He then describes in detail the recent work of Major G. I. Taylor and himself (already described in this column) which determined the regions on the earth's surface where the friction is taking place; the Bering Sea is the largest contributor, but the action in the Irish Sea is quite sensible.

1646 SPECTROSCOPIC PARALLAXES.—The *Astrophysical Journal* for January last contains an important list of 1646 spectroscopic parallaxes by W. S. Adams, A. H. Joy, G. Strömberg, and Cora G. Burwell. The paper commences with a re-discussion of the spectral graduation tables in the light of the extensive series of trigonometrical parallaxes recently published, especially those at the Allegheny, McCormick, Yerkes, and Mount Wilson observatories. In the case of the Cepheid variables and giant M stars use has also been made of the parallactic motions, since these stars are, in the main, too remote to lay much stress on their trigonometrical parallaxes.

The new list includes revised values for 495 of the stars in the 1917 list. It is satisfactory that many A stars are now included in the list, which formerly

did not extend beyond F. A few of the larger or more interesting results are quoted below, marked S, the trigonometrical results (T) being given for comparison:

OAN 4961, P.M. 0.53", S 0.100", no T; Aldebaran, S 0.096", T 0.055"; Capella, S 0.076", T 0.067"; Betelgeux, S 0.012", T 0.021"; Castor (faint distant companion), S 0.091", T 0.079"; Pollux, S 0.126", T 0.064"; Boss 2199, S 0.110", T 0.081"; Regulus (companion), S 0.052", T 0.033"; Boss 3047, S 0.105", T 0.235" (only one determination); Arcturus, S 0.158", T 0.075"; γ Serpentis, S 0.120", T 0.063"; Antares, S 0.017", T 0.029"; λ Sagittarii, S 0.115", T 0.060"; β^1 Cygni, S 0.033", T 0.000"; β Aquilae, S 0.100", T 0.076"; and Boss 5976, S 0.209", T 0.172".

For the peculiar variable or nova 7:1917 Serpentis the value of S is 0.003", the absolute magnitude being 2.9.

Several large parallaxes have not been quoted, since they are practically replicas of the accepted values.

A CATALOGUE OF RADIAL VELOCITIES.—Many workers in stellar statistics must have felt the inconvenience of having to ransack the publications of several observatories in order to obtain complete details of known radial velocities. The need for a catalogue has at last been supplied by Mr. J. Voûte, who was for some time at the Cape Observatory determining stellar parallaxes. While he does not claim that his catalogue is absolutely complete, it includes all the stars, 2071 in number, for which radial velocities were given in publications that were accessible in the library of the Cape Observatory. It is arranged in a convenient form, giving R.A. and declination for 1900, magnitude, proper motion, spectral type, radial velocity, parallax, and galactic longitude and latitude.

The numbers of stars of each spectral type are:—Oe 6, B 310, A 358, F 257, G 309, K 517, M 153, R 11, and nebulae and clusters 148. The largest + and - radial velocities for each type in km./sec. are:—B, +102, -38; A, +96, -170; F, +339, -325; G, +301, -242; K, +177, -132; and M, +98, -185. There appears to be a distinct maximum for types F and G.

The work was published at Weltevreden, Java, by Boekhandel, Visser, and Co.

A statistical study of the results by Prof. George Forbes was presented at the March meeting of the Royal Astronomical Society.

The Microstructure of Coal.

A VALUABLE and original paper on the economic selection of coal was contributed at the autumn meeting of the Iron and Steel Institute by Mr. A. L. Booth. The method usually adopted is to carry out a proximate chemical analysis, which at the best is very unsatisfactory and of little real use, to collate the results with practical experience, and to make a trial on some particular plant. Only too often it proves to be unsatisfactory, and trouble arises from the fact that two coals can have practically the same appearance and give the same analysis, and yet be totally different in behaviour. This occurs quite frequently, and does not seem to be realised by fuel-users generally. Sir W. G. Armstrong, Whitworth, and Co.'s works, with which Mr. Booth is connected, use some 250,000 tons of coal per annum for different purposes, and it was the unsatisfactory nature of chemical methods of classification which led to experiments being made with the microscope to ascertain whether a more trustworthy method could not be devised. The method adopted was as follows:

Sections were cut of a large number of typical pieces of coal from different sources. Some had been proved over a period of years to be suited to a particular class of work, while others had proved unsatisfactory for the same class of work. All were carefully examined under the microscope. It was soon seen that there were three main types, and that each type was suitable for certain classes of work. Further investigation rendered it possible to decide how far a departure from the typical member could be made without getting into difficulties.

The method of cutting sections is similar to that used in making rock sections, but is considerably more difficult and requires more patience. A piece of coal is selected and, if soft and cracked, treated with a transparent, colourless binder. One side of the coal is then ground down, using carborundum powders of finer and finer grades, finishing off with a water of Ayr stone. The result should be a smooth, flat face. The coal is then mounted in Canada balsam on a piece of glass, the face being well pressed against it. When the balsam is set, a slice of coal is cut off and ground down until it transmits light.

In his paper Mr. Booth considers only coals in commercial use in this country, and these fall into three main types: (1) "Humic," composed of leaves, stems, and broken-down woody tissue, together with some spores. (2) "Spore" coals, in which both "micro-" and "mega-" spores predominate. (3) Cannel coals.

The spores are the reproductive organs of the plants, and correspond with the pollen and ovules in present-day flowering plants. The micro-spores are very small, while some of the mega-spores are about $\frac{1}{2}$ in. in diameter. The cannel coals contain small, round, yellow bodies. It will be realised, of course, that these three classes merge into one another. Humic coals occur containing more and more spores, while spore coals become more cannellised as the yellow bodies merge with the spores. This is where microscopic work is necessary to enable a decision to be

made as to what a particular sample of coal can be used for. The author shows sixteen coloured photomicrographs of thin sections of specimens of the three main types at magnifications varying from 50 to 560 diameters.

So far as the main economic uses of coal are concerned, the study of their microscopic structure has resulted in the following conclusions:

For steam-raising, humic coals which contain a fair proportion of spores are the most suitable. These coals coke fairly well, and give a good, hot fire without too long a flame. For town-gas manufacture humic coals are also suitable, and for this purpose those which swell on heating and burn with a long flame are the best. They give a good yield of gas and by-products. Some humic coals containing much yellow substance constitute the best coking coals, and should be reserved for that purpose.

For producer-gas work the spore coals are necessary. The best coals for non-recovery producers are those which have been partially cannellised. They do not soften, the coke is very fragile, and the fixed carbon is very high. This is a necessary feature in producer practice. If the ash is not very fusible it is possible to work these coals with a low blast saturation, and thus get a dry gas with a high carbon monoxide content, the flame of which has a higher radiating power than the hydrogen flame. In recovery work, coal containing more humic matter may be used, because here a primary low-temperature distillation takes place, and through the high saturation of the blast the tendency to swell is checked.

For direct-fired furnaces (e.g. reheating and reverberatory) the hard coals are used. These are almost true cannels, and are usually dull-looking. They are free-burning, having no tendency to coke, and unless iron be present through infiltration it is difficult to fuse the ash.

The microscope has not only been found helpful in the selection of coals, but in some cases it is also of use in deciding whether or no it would pay to wash them, and will explain why an apparently good and clean coal has, for instance, a high ash-content. In such a case a washing may be quite useless. In the event of a shortage of a particular class of fuel the more detailed knowledge of coal which the microscopic study gives will enable the best substitutes to be used; and to obtain satisfactory working with the substitute, any necessary alterations in the running of a plant can be made without waiting for adverse effects to develop.

The author states in conclusion that coal from the same seam is generally very uniform, and mentions that sections cut from a given seam, but delivered on dates twelve years apart, showed that the coal is of the same type. As he says, perhaps one day it will be possible to buy coal to specification as we now buy steel.

Mr. Booth's paper is very timely, and indicates what a considerable saving could be made if the present output of coal were scientifically utilised in the manner indicated.

The Cretaceous-Tertiary Boundary in North America.¹

By PROF. A. C. SEWARD, F.R.S.

ONE of the most difficult problems with which American geologists and palæontologists are confronted is the correlation of the Later Cretaceous and Lower Tertiary strata in the different regions of

¹ Department of the Interior, United States Geological Survey. Professional Paper No. 101: "Geology and Palæontology of the Raton Mesa and other Regions in Colorado and New Mexico." By Willis T. Lee and F. H. Knowlton.

the United States. The Professional Paper by Messrs. Lee and Knowlton is concerned with some of the Cretaceous and Tertiary rocks in the Rocky Mountains region of Colorado and New Mexico. A considerable area in the interior of North America was occupied by a Cretaceous sea, and it was part of this area which was afterwards uplifted as the Rocky Moun-

tains chain. This crust-folding was followed by the deposition of plant-bearing Tertiary strata. The Raton Mesa region is rich in coal-bearing beds containing a large number of flowering plants, with a few twigs of conifers and fragments of sterile fern-fronds. The flowering plants are, unfortunately, represented almost exclusively by detached leaves.

Different views have been held on the geological age of these sediments. Lesquereux referred them to the Tertiary period, and later geologists regarded them as Cretaceous. The evidence now brought forward points to the occurrence of two distinct formations, the Vermejo formation below separated by a well-marked unconformity from the overlying Raton formation. It is believed that this unconformity marks the boundary between the Cretaceous and Tertiary systems in Colorado and New Mexico. In the interval represented by the unconformity there was widespread erosion of the uplifted floor of the Cretaceous sea before the deposition of the Lower Tertiary Raton formation.

From a geological point of view the conclusions based on a considerable mass of information are of great interest as a contribution towards a more precise determination of the Cretaceous-Tertiary boundary. Both the Vermejo and Raton formations are rich in fossil plants, Dicotyledons being the most abundant in each flora; the Vermejo flora is correlated with the Montana flora, while the Raton flora is believed to be Eocene. A noteworthy feature of the Raton flora is the inclusion of some exceptionally fine specimens of palm-leaves, but, as Mr. Knowlton states, it is impossible to refer most of them to a definite position on leaf-characters only.

The palæobotanical portion of the volume is well illustrated and the specimens are concisely described. It is, however, unfortunate that little attempt is made to compare the plants with species other than American. The application of the names of recent genera to many of the specimens, though in accordance with a common practice, suggests a lack of appreciation of the difficulties of systematic work when leaves only are available. In many cases it is clearly impossible to accept the generic determinations of both fern fragments and dicotyledonous leaves without hesitation.

Mr. Knowlton has done good service by rendering available much new material, and the excellent illustrations will enable students of palæogeography to institute comparisons between the American and other types. The absence of conifers in the Raton flora as contrasted with their comparative abundance in the older Vermejo flora is an interesting feature, though it is scarcely safe to assume, as Mr. Knowlton does, that the group was unrepresented in the contemporary vegetation of the district.

The greater part of the volume is devoted to Mr. Lee's extended researches, which include the results of field work in many districts and a very useful correlation of the formations in the Raton Mesa region with those in other parts of the continent.

The investigation of the later Cretaceous and earlier Tertiary floras has acquired a fresh importance in view of the recent work of Mrs. Reid, who is ably carrying on the researches initiated by the late Mr. Clement Reid on the younger Tertiary floras. The recognition of many Chinese types of flowering plants in the Pliocene beds of western Europe, as Mrs. Reid has shown, throws light on the interrelationships of floras that are now widely separated. A critical analysis of the older Tertiary floras in both the Old and the New World should enable us to obtain a deeper insight into the early history of the Angiosperms. One of the difficulties in the way of a comprehensive survey of fossil floras is that of correlation, and it is only by the co-operation of stratigraphical geologists and palæobotanists that this difficulty can be met. American investigators have realised the importance of such collaboration, and their example might with advantage be followed more closely in this country. It may be said that if the accurate determination of fossil leaves, especially those of Angiosperms, is impossible, why attempt it? The answer is that palæobotanists do not, as a rule, sufficiently avail themselves of the assistance of experienced systematists, and are too ready to be satisfied with resemblances based upon characters which are common to several recent genera. Though many fossil leaves referred to recent genera are valueless as accurate data, this is no reason for assuming that greater accuracy in the analyses of floras is unattainable.

Isle of Wight Disease in Hive Bees.¹

By DR. A. D. IMMS.

ISLE OF WIGHT disease is the most serious menace to apiculture in Great Britain. The prevalence of this complaint and the present high cost of bee appliances and of stocks render it extremely doubtful whether any profit can be derived from the keeping of bees solely for honey production. Many bee-keepers find it more profitable to supply bees and queens, together with the necessary apparatus, and hundreds who take up bee-keeping relinquish it after a short time as being non-productive.

The disease has continued without interruption from about the year 1902 until the present time, and no epidemic of an equally permanent and extensive nature has so far been indisputably recognised outside the British Isles. The first preliminary investigation

into its cause was carried out in the Isle of Wight in 1907 by the present writer, who described many of its symptoms, but was unable to discover any protozoa connected with it. In 1912 and 1913 Graham Smith and others put forward the theory that it was due to *Nosema apis*. More recent work by Anderson and Rennie and by Rennie and Harvey indicates that Isle of Wight disease and disease due to *Nosema* are two distinct complaints exhibiting different symptoms and pathological conditions.

In the first of the papers under review the causal organism of Isle of Wight disease is definitely stated to be a new species of mite, *Tarsonemus Woodi*. This Acarine was found in every one of 110 stocks reported by trustworthy bee-keepers, or certified by the investigators themselves, as suffering from Isle of Wight disease. The investigation involved an examination individually of at least 700 bees, and it was discovered that in every instance where symptoms of Isle of Wight disease were evident the mite was also present. No exception has been found. The parasite occupies

¹ "Isle of Wight Disease in Hive Bees." (1) "The Etiology of the Disease." By Dr. J. Rennie, P. R. White, and Elsie J. Harvey (pp. 739-54). (2) "The Pathology of Isle of Wight Disease in Hive Bees." By P. R. White (pp. 756-64). (3) "Isle of Wight Disease in Hive Bees—Experiments on Infection with *Tarsonemus Woodi*, n.sp." By Elsie J. Harvey (pp. 765-67). (4) "Isle of Wight Disease in Hive Bees—Acarine Disease: The Organism Associated with the Disease—*Tarsonemus Woodi*, n.sp." By Dr. J. Rennie (pp. 768-79, pl. 1, fig. 2). Trans. Royal Soc. Edinburgh, vol. lii., part iv., No. 29, 1921.

a very restricted region of the insect, being confined to the respiratory system, and only to those tracheæ which are associated with the anterior pair of spiracles. All stages of the Acarine were met with—eggs, larvæ, and adults; they occur within the tracheal tubes extending from the spiracles inwards. The tracheæ become darkened and ultimately black by the increasing deposition of chitin.

In studying the pathology of the disease Mr. P. B. White points out that the mites perforate the tracheæ and live upon the body fluids of their hosts, and he also raises the question, which is extremely difficult to answer, whether they exercise any toxic action also. When present in large numbers they entail the obstruction of the respiratory system of the head and thorax, thereby reducing the efficiency of the respiratory exchange of the organs supplied. In order to obtain some idea of the effects actually arising from the mechanical obstruction of the spiracles, a series of experiments was carried out upon healthy bees. The first spiracle of one or both sides of each bee was closed by means of melted paraffin-wax. Upon closure of one spiracle the experimental bees at once lost the power of flight, but otherwise remained active in their movements. After a lapse of several days the bees became more sluggish, and about the sixth or seventh day examples were noted with dislocated wings and other features which commonly accompany Isle of Wight disease. The thoracic musculature in many cases exhibited atrophy of the same type as had been found in bees infected with the Tarsonemus. In those experiments in which the first spiracle of each side was closed the power of flight was at once lost as before, but after twenty-four to forty-eight hours the bees developed a reeling gait and appeared to be continually falling over their own heads. It was seldom that any survived the third day.

As Mr. White points out, though too close a parallel must not be drawn with the natural disease, these experiments give a basis to the view that the rôle of the Tarsonemus in partially preventing thoracic respiration is of prime importance in the disease, possibly in itself capable of occasioning all the symptoms by which we are wont to diagnose the disease and the muscle atrophy so often associated with it.

There is evidently much still to be discovered; we know as yet very little concerning the migratory stage of the parasites, and provisional experiments in producing artificial infection have so far yielded inconclusive results. The reason for the parasite selecting the first pair of spiracles as its sole means of entry also needs elucidation. The authors of these researches are to be congratulated upon their discoveries, and it is quite evident that the whole subject of bee diseases is the most pressing problem in apiculture in this country to-day; in fact, the future of bee-keeping is dependent upon their thorough investigation.

University and Educational Intelligence.

CAMBRIDGE.—Prof. F. G. Hopkins has been elected to the Sir William Dunn professorship of biochemistry.

Sir Napier Shaw will give the Rede lecture on June 9 on the subject of "The Air and its Ways."

Mr. H. G. Carter has been appointed curator of the herbarium.

It is proposed to make a grant of 75*l.* from the Worts Fund to Prof. Seward towards defraying the

expenses of an expedition to Greenland undertaken by Mr. R. E. Holthurn and himself for the purpose of collecting fossil plants from Cretaceous and Tertiary rocks on Disco Island and the mainland and of studying the recent vegetation.

Steps are being taken towards an agreed solution at an early date of the problem of the position of women in the University. It is already clear, however, that the latest proposal will not be acceptable to a considerable section of University opinion, though it may carry with it moderate opinion, and also secure the support of those who voted in December for Report A.

LONDON.—The following public lectures will be delivered at King's College during the Easter term. Admission to public lectures is free and without ticket, except when otherwise stated:—A course of three lectures on Wednesdays, May 18 and 25 and June 1, at 5.30 p.m., by Prof. A. P. Newton, on "The Universities of the Dominions and the United States of America."

In the department of science a lecture or lectures will be delivered by Prof. Einstein early in May. The date and title will be announced later.

A course of four lectures on Tuesdays, May 3, 10, 17, and 24, at 5 p.m., by Mr. J. H. Jeans, secretary of the Royal Society, on "Cosmogony and Stellar Evolution."

In the department of philosophy a course of four lectures on Tuesdays, May 10, 17, 24, and 31, at 5.30 p.m., on "The Present Issue between Realism and Idealism," by Prof. H. Wildon Carr.

In the department of engineering a course of four special lectures for post-graduate and other advanced students on Tuesdays, beginning May 3, at 5.30 p.m., on "Cascade Work in Induction Motors," by Mr. L. J. Hunt. This course is free only to the regular students of the faculty of engineering.

A HOLIDAY course in geology will be held at the School of Metalliferous Mining, Camborne, Cornwall, on July 18–August 27. The course will deal with economic geology, with special reference to West Cornwall, and will consist of lectures and laboratory and field work. The programme includes the mapping of areas both on the surface and underground, a number of excursions to localities around Camborne of interest to geologists, and work in the school dealing with rock-forming minerals, rocks, the mechanical analysis of alluvial sands, and methods of dressing the products. Students wishing to enter for it should apply to the Registrar, School of Metalliferous Mining, Camborne.

It is announced that Prof. E. Cohen, of Utrecht, will give two lectures on "Metastability of Matter and its Bearings on Chemistry and Physics," probably at University College, London, on May 10 and 12 at 5.30 p.m. Two lectures by Prof. H. E. Armstrong on "Enzymes in Relation to Plant Growth" have also been provisionally arranged; they will be delivered at King's College on June 3 and 10 at 5 p.m. Another course, of three lectures, by Prof. E. W. MacBride, on "Recent Advances in Experimental Embryology," will probably be given at the Imperial College of Science and Technology on June 7, 8, and 9 at 5 p.m. These courses of lectures are intended for advanced students of chemistry, agriculture, and zoology respectively and others interested in these subjects. In all cases admission will be free and without ticket.

Calendar of Scientific Pioneers.

April 28, 1842. Sir Charles Bell died.—Famous for his important discoveries in anatomy, Bell in 1807 distinguished between the sensory and the motor nerves in the brain. Born in Edinburgh in 1774, his principal appointment was the professorship of anatomy and surgery to the London College of Surgeons.

April 28, 1858. Johannes Peter Müller died.—A professor first at Bonn and then at Berlin, Müller has been referred to as the founder of modern physiology. He extended the knowledge of the mechanism of voice, speech, and hearing and of the properties of the lymph, chyle, and blood. Helmholtz, Du Bois Reymond, and Ludwig were among his pupils.

April 28, 1903. Josiah Willard Gibbs died.—Called by Ostwald the founder of chemical energetics, Gibbs enunciated the phase rule and was the first to apply the second law of thermodynamics to the exhaustive discussion of the relation between chemical, electrical, and thermal energy and capacity for external work. For thirty years he was professor of mathematical physics in Yale University.

April 30, 1865. Robert Fitzroy died.—The commander for eight years of H.M.S. *Beagle*, in which Darwin sailed as naturalist, Fitzroy in 1854 became the first head of the Meteorological Department of the Board of Trade, where he instituted a system of storm warnings and daily weather forecasts in 1860-61.

April 30, 1876. Antoine Jérôme Balard died.—The discoverer in 1826 of the element bromine, Balard held various appointments at Montpellier, and then succeeded Thénard in the chair of chemistry in the Faculty of Sciences in Paris.

May 1, 1796. Alexandre Gui Pingre died.—In 1751 Pingre became director of the observatory at St. Geneviève in Paris. He travelled abroad to observe the transit of Venus of 1769, verified Lacaille's work on eclipses, and wrote an important book on comets.

May 1, 1891. Eduard Schönfeld died.—The successor of Argelander at Bonn, Schönfeld continued the great survey of the heavens and formed a catalogue of 133,659 stars between 2° and 23° south declination.

May 2, 1519. Leonardo da Vinci died.—One of the most remarkable and versatile geniuses of any age, Leonardo in turn was painter, sculptor, engineer, and architect, and studied physics, biology, and philosophy. As a man of science he was essentially a fore-runner, and anticipated by centuries developments which have but recently been witnessed.

May 4, 1677. Isaac Barrow died.—The first to hold the Lucasian chair of mathematics at Cambridge, Barrow relinquished this post in 1669 in favour of his pupil Newton. At the time of his death Barrow was Master of Trinity College.

May 4, 1827. Mark Beaufoy died.—Beaufoy was the first Englishman to climb Mont Blanc, which he did six days after Saussure. As a scientific investigator he made experiments on the form of ships, carried out magnetical observations to determine the law of diurnal variation, and studied the eclipses of Jupiter's satellites.

May 4, 1892. Karl August Dohrn died.—The father of Anton Dohrn, the zoologist, Karl Dohrn was well known for his writings on entomology. He was a merchant in Stettin, where he died.

May 4, 1916. Prince Boris Galitzin died.—Well known for his inventions and his writings on seismology, Galitzin was professor of physics in the Academy of Sciences of Petrograd. E. C. S.

Societies and Academies.

LONDON.

Royal Society, April 14.—Prof. C. S. Sherrington, president, in the chair.—Prof. K. Onnes, Sir R. Hadfield, and Dr. H. R. Woltjer: The influence of low temperatures on the magnetic properties of alloys of iron with nickel and manganese. A series of iron-manganese and iron-nickel alloys with a range of percentages of manganese and nickel respectively has been tested in order to investigate the influence of cooling to very low temperatures (liquid hydrogen and liquid helium) on their magnetic properties, especially to ascertain whether the iron-manganese alloys which are non-magnetic at atmospheric temperature become magnetic by so doing. Samples are tested quickly one after another at a temperature of 20° K. The iron-manganese alloys containing the higher percentages of manganese cannot be made magnetic at atmospheric temperature by cooling to the boiling point of liquid hydrogen or liquid helium. The existence of one magnetic and one non-magnetic, or at most slightly magnetic, manganese-iron compound is probable, and the non-magnetic properties of the higher manganese-iron alloys may be explained by their means.—C. N. Hinshelwood and E. J. Bowen: The influence of physical conditions on the velocity of decomposition of certain crystalline solids. The velocity of decomposition by heat of potassium permanganate and ammonium bichromate. For solids the temperature coefficient of the reaction velocity does not allow calculation of a "heat of activation" or "critical increment" of the reacting molecule, according to the method of Trautz, Lewis, and others, for various physical reasons connected with the propagation of the reaction from the surface into the interior. The lowering of the velocity of decomposition of potassium permanganate in solid solution in potassium perchlorate indicates that the heat of activation of the permanganate is increased by the physical process of solid mixture. By equating this assumed increase in the heat of activation to the observed heat of solid mixture obtained from the calorimetric measurements of Sommerfeld, approximate quantitative agreement is found between the observed rates of decomposition of potassium permanganate in various solid solutions and those calculated.—Prof. H. Briggs: The adsorption of gas by charcoal, silica, and other substances. The method of determining the adsorptive capacity of a substance at liquid-air temperature is described, and results are given of the capacity and manner of preparation or occurrence of thirty-six substances. Charcoal and silica are compared, especially as relates to nitrogen and hydrogen, to illustrate preferential adsorption; the influence of chemical composition on gas adsorption is discussed. The effect of the compressibility of the initial layer when the density of an adsorbent is determined by the immersion method is considered. An evaluation is made of (a) the volume of solid matter, (b) that of the interstitial space between the granules, and (c) that of the internal gaseous space for silica and coconut charcoal. The density of the nitrogen adsorbed at -190° C. by silica and charcoal is calculated from experimental data. From these results it is possible to estimate the error affecting the density of charcoal ascertained from water-immersion. The conditions affecting adsorption at low and high saturation are given. The presence of capillaries is not sufficient to account for adsorption. A high-capacity silica may be deactivated, but remain porous. Graphite, which has no pores, adsorbs gas at -190° C. The evidence leads to the conclusion

that deactivated silica is vitreous. A vitreous solid, like a crystal, is probably a polymer. Activation is considered to be the effect of disrupting the solid polymers.—N. K. **Adam**: The properties and molecular structure of thin films of palmitic acid on water. Part i. Langmuir's views have been confirmed and extended. Films on water exhibit a resistance to lateral compression commencing at 22×10^{-16} sq. cm. per molecule, and increases linearly with reduction of area until the force is sufficient to buckle the film. Collapse then sets in, and no further increase of force is regularly found necessary to diminish the area to zero. A metastable condition of increased resistance to collapse may occur. The compression curves point to the resistance being due to repulsion between the insoluble molecules, arranged in a single layer on the surface, each molecule being attracted to the water by its carboxyl group. When collapse of the uni-molecular film occurs, the molecules ejected are seen to aggregate into fine lines many molecules in thickness. The observed areas agree with the dimensions calculated from molecular volume studies, and the compressibility of the films is of the same order as for liquids in bulk. The effect of acidity of the water on the films may be due to the greater attraction of alkaline solutions than acid for carboxyl groups. The observations indicate that the molecules are immersed further in alkaline than in acid solutions, even when alkalinity is insufficient to cause complete solution. In still more alkaline solutions immersion becomes complete, and the molecules probably pass from the film into aggregates, having the hydrocarbon chains in the centre and the carboxyl groups on the surface. This structure is suggested for the "ionic micelle" of soap solutions.—E. P. **Metcalfe** and B. **Venkatesachar**: The absorption of light by electrically luminescent mercury vapour. Mercury vapour at low pressures, rendered luminous by the passage of small electric currents, exerts powerful selective absorption. A list of wave-lengths found to be absorbed is given. Photometric observations are recorded on the absorption and emission of 5461 Å. by columns of mercury vapour of different lengths and carrying different currents. The relation between the ratio (emission/absorption) and the current density is linear. The lines 5461 Å. and 4359 Å. have been reversed so as to appear dark lines on the white-light spectrum of a carbon arc and of the sun. The reversal of 5461 Å. has been studied in detail.

Zoological Society, April 19.—Sir S. F. Harmer, vice-president, in the chair.—Mrs. J. **Longstaff**: Observations on the habits of the snail, *Cochlitoma zebra*, var. *fulgurata*, and *C. zebra*, var. *obesa*, Pfeiffer, in confinement.—R. I. **Pocock**: The external characters and classification of the Procyonidæ (raccoons, etc.).—Dr. M. A. **Smith**: New or little-known reptiles and batrachians from southern Annam (Indo-China).

Royal Meteorological Society, April 20.—Mr. R. H. Hooker, president, in the chair.—C. E. P. **Brooks**: The evolution of climate in north-west Europe. Commencing with the last (Würmian) Glacial period, the slow variations of climate in north-west Europe are studied in connection with changes in the land and sea distribution, and also with possible astronomical influences. Several successive "phases" are distinguished:—(1) The close of the Glacial period, 30000–18000 B.C. (2) The retreat of the glaciers, 18000–6000 B.C. (3) The continental phase, about 5000 B.C. (4) The maritime phase, about 4000 B.C. (5) The forest phase, about 3000 B.C. (6) The peat-bog phase, about 500 B.C. (7) The recent phase. Charts are

drawn to illustrate the probable meteorological conditions associated with each of these phases, and especially the gradual development of the present system of storm-tracks, the Mediterranean being the oldest. The cessation of the peat-bog phase is shown to be contemporaneous with a marked drop in Huntington's curves of rainfall in California and south-western Asia. The whole series of changes in north-west Europe is compared with the corresponding post-Glacial series in North America, which is shown to be similar in its general lines, but not always contemporaneous. Finally, a section is devoted to Pettersson's astronomical tidal theory, which is found to fit in very well with the changes after 3000 B.C., but not before.—Lieut. G. C. **Steele**: A brief review of the influence of meteorology on naval warfare. In almost every action fought in the late war some reference was made to the state of the weather. The last five years have seen new acquisitions to naval service, most notably the C.M.B., a naval air wing, and such weapons as the smoke screen, and even the possibility of the use of poisonous gas at sea. Analysing the effect of meteorological conditions on these new arms, the last two are seen to be contingent on weather conditions, and the others are so in a large degree. Modern invention has thus not overcome the influence of meteorology on naval warfare. Its influence can be traced also in the policy of ship construction. For example, in a programme of shipbuilding the general climatology of the sea or ocean forming the probable theatre of war in a great measure determines the gun-range at which an action will be fought, and, consequently, the amount of armour to be allocated under these conditions.

PARIS.

Academy of Sciences, April 4.—M. Georges Lemoine in the chair.—The president announced the death of M. Vallier, correspondent of the Academy.—E. L. **Rouvier**: A work relating to the French fauna. Remarks on a memoir on Echinoderms by R. Koehler, published by the French Federation of Natural Science.—G. **Gouy**: The calculation of the coma. The calculations in a recent note assumed that the aberration on the axis of the lens is zero. A first approximation is now given for the case when the aberration is sensible.—M. **Lugeon**: A new example of striation of a river-bed. The Lower Ardèche, between Vallon and Saint-Martin, presents striations resembling those of the banks of the Yadkin, in North Carolina, described by the author in 1913.—G. **Julia**: A functional differential equation analogous to Hadamard's equation.—A. **Denjoy**: The determination of functions presenting a certain complex character of soivability.—T. **Varapoulos**: The theorem of Landau and multiform functions.—F. **Carlson**: The series of Dirichlet.—H. **Godard**: Observations of the Reid comet made at the Observatory of Bordeaux (38-cm. equatorial). The apparent positions and the positions of the comparison stars are given for March 30 and 31 and April 1. The comet was about 10.5 magnitude on March 31.—P. **Chofardet**: Observations of the Reid comet (1921a) made with the *coudé* equatorial at the Besançon Observatory. Positions given for March 30 and 31 and April 1.—J. **Guillaume**: Observations of the Reid comet made with the *coudé* equatorial at the Observatory of Lyons. Positions given for March 28, 30, and 31. The comet is circular, less than 1' in diameter, with a central condensation; magnitude 9.5.—C. E. **Brazier**: The comparability of anemometers. A direct comparison in the open air of eight types of anemometers, all previously well standardised in the laboratory, showed that unless the inclination of the com-

plex movements of the air constituting natural wind was below 10° , the indications of the different instruments were not comparable. Instruments of the Richard type give low figures, whilst the other types give too high readings.—M. **Pescara**: The results of some recent trials of a helicopter.—P. **Painlevé**: Remarks on the preceding communication.—M. **Marage**: The evolution of the graphical method.—L. and E. **Bloch**: The spark spectra of iron and cobalt in the extreme ultra-violet. Tables of the wavelengths of lines in the extreme ultra-violet are given between the limits $\lambda=1845$ and 1456 .—A. **Bigot**: Kaolins, clays, and bauxites. Variations of volume under the action of heat. The results with five materials are shown in a diagram. The changes in length of the briquettes were measured for each 100° rise of temperature up to the softening points of the materials.—M. **Barlot**: The electrical phenomena accompanying the displacement of metals.—M. **Ehrmann**: An important orogenic movement at the commencement of the Cretaceous period in the Kabylië des Babors.—J. **Thoulet**: The oceanic circulation and the density of sea-water. The density is rapidly determined by the dipping refractometer and the use of appropriate tables.—C. **Vaurabourg**: The density and refractive indices of sea-water. Tables are given showing the relation between the refractive index and density of sea-water for temperatures between 0° C. and 30° C. (5° intervals) and for densities ranging from 1.032 to 1.000.—G. **Kühnholtz-Lordat**: Dynamical phytogeography of the dunes of the Gulf of Lyons.—J. **Pavillard**: *Gymnodinium pseudonoctiluca*. This rare organism, discovered in 1884 by G. Pouchert, and again in 1890, was abundant in the Gulf of Lyons in 1907. It does not appear to be identical with the *Gymnodinium* found by Miss M. Lebour at Plymouth.—J. **Politis**: The brown corpuscles causing the browning of the vine. The brown corpuscles are not the cysts of a parasite (Debray) or excretion products (Viala and Sauvageau), but result from a transformation of granular mitochondria.—R. **Poisson**: Spermatogenesis and the exceptional chromosome in *Naucoris maculatus*.—A. **Paillet**: Rôle of the secretions in the extracellular destruction of micro-organisms in insects. Remarks on a recent communication of MM. Couvreur and Chaovitch.—R. **Bayeux**: The reducing power of the organic liquids and tissues of some marine animals. An application of the methylene-blue reduction method of H. Roger.—M. **Weinberg** and L. **Kepinow**: The leuco-agglutinines.

Books Received.

The Mechanical Principles of the Aeroplane. By Dr. S. Brodetsky. Pp. vii+272. (London: J. and A. Churchill.) 21s. net.

Mathematical Papers for Admission into the Royal Military Academy and the Royal Military College, and Papers in Elementary Engineering for Naval Cadets and Royal Air Force for the Years 1911-20. Edited by R. M. Milne. (London: Macmillan and Co., Ltd.) 10s. 6d.

Mutations and Evolution. By Dr. R. Ruggles Gates. (New Phytologist Reprint, No. 12.) Pp. vii+118. (London: Wheldon and Wesley, Ltd.) 6s.

Meteorology: An Introductory Treatise. By Dr. A. E. M. Geddes. Pp. xx+390+xx plates. (London: Blackie and Son, Ltd.) 21s. net.

Telephotography. By Cyril F. Lan-Davis. Second edition by L. B. Booth. Pp. xii+116. (London: G. Routledge and Sons, Ltd.; New York: E. P. Dutton and Co.) 3s. 6d. net.

Fijian Society; or, The Sociology and Psychology

of the Fijians. By the Rev. W. Deane. Pp. xv+255. (London: Macmillan and Co., Ltd.) 16s. net.

Text-Book of Land Drainage. By Joseph A. Jeffery. (Rural Text-Book Series.) Pp. xx+256. (New York: The Macmillan Co.; London: Macmillan and Co., Ltd.) 10s. 6d. net.

Management of Dairy Plants. By Prof. M. Mortensen. Pp. xvi+358. (New York: The Macmillan Co.; London: Macmillan and Co., Ltd.) 12s. 6d. net.

The Practical Value of Ethnology. By Dr. A. C. Haddon. (Conway Memorial Lecture.) Pp. 64. (London: Watts and Co.) 1s. net.

The Backbone of Africa: A Record of Travel during the Great War. By Sir Alfred Sharpe. Pp. 232. (London: H. F. and G. Witherby.) 16s. net.

Sun, Sand, and Somals: Leaves from the Note-Book of a District Commissioner in British Somaliland. By Major H. Rayne. Pp. 223+12 plates. (London: H. F. and G. Witherby.) 12s. 6d. net.

Counsels and Ideals from the Writings of William Osler. Second edition. Pp. xxiv+355. (London: Oxford University Press.) 8s. 6d. net.

The Geology of the British Empire. By Dr. F. R. C. Reed. Pp. viii+480. (London: E. Arnold.) 40s. net.

Elements of Natural Science. By W. Bernard Smith. Part i. Pp. viii+207. (London: E. Arnold.) 5s. net.

The Modern Teacher: Essays on Educational Aims and Methods. Edited by A. Watson Bain. Pp. xv+272. (London: Methuen and Co., Ltd.) 10s. 6d. net.

Department of Scientific and Industrial Research: Fuel Research Board. The Winning, Preparation, and Use of Peat in Ireland. Reports and other Documents. Pp. 76. (London: H.M. Stationery Office.) 3s. net.

Department of Scientific and Industrial Research: Building Research Board. Special Report No. 1: Sand-Lime and other Concrete Bricks. By H. O. Weller. Pp. 11. (London: H.M. Stationery Office.) 3d. net.

The Carnegie Foundation for the Advancement of Teaching. Fifteenth Annual Report of the President and of the Treasurer. Pp. vi+171. (New York City.)

A Brief Account of Radio-Activity. By Prof. F. P. Venable. Pp. vi+54. (Boston: D. C. Heath and Co.; London: G. G. Harrap and Co., Ltd.) 3s. 6d. net.

Experimental Organic Chemistry. By Prof. Augustus P. West. (New-World Science Series.) Pp. xiii+460. (London: G. G. Harrap and Co., Ltd.) 10s. 6d. net.

Energétique générale. By Dr. Félix Michaud. Pp. vii+220. (Paris: Gauthier-Villars et Cie.) 10 francs.

Vergleichende Biologische Formenkunde der Fossilen niederen Tiere. By Prof. Edgar Dacque. Erste Hälfte. Pp. viii+336. (Berlin: Gebrüder Borntraeger.) 06 marks.

Human Physiology. By Prof. L. Luciani. Vol. v.: Metabolism—Temperature—Reproduction, etc. Pp. viii+422. (London: Macmillan and Co., Ltd.) 30s. net.

Diary of Societies.

THURSDAY, APRIL 28.

ROYAL INSTITUTION OF GREAT BRITAIN, at 3.
 INSTITUTE OF PATHOLOGY AND RESEARCH (St. Mary's Hospital, Paddington), at 4.30.—Sir Almoth E. Wright: Acidosis and Acidæmia, with Special Reference to Scurvy and Shock.
 ROYAL SOCIETY, at 4.30.—Prof. H. Lamb and R. V. Southwell: The Vibrations of a Spinning Disc.—Dr. W. Rosenhain: The Hardness of Solid Solutions.—W. Hartree and Prof. A. V. Hill: A Method of Analysing Galvanometer Records.—F. H. Newman: A New Form of Wheat Interrupter.—T. L. Ibbs: Some Experiments on Thermal Diffusion.—B. N. Chak-

ravarty: The Diffraction of Light Incident at Nearly the Critical Angle on the Boundary between Two Media.
 BOTANICAL SOCIETY (Regent's Park), at 5.30.
 INSTITUTION OF ELECTRICAL ENGINEERS (at Institution of Civil Engineers), at 6.—Discussion on Tariffs.—J. R. Blaikie: Electricity Supply—Present Conditions and the Hopkinson Principles.—J. W. Beauchamp: Multi-Part Tariffs for Domestic Electricity Supply.
 CONCRETE INSTITUTE, at 7.30.—Prof. F. C. Lea: The Elastic Modulus of Concrete.
 ROYAL SOCIETY OF MEDICINE (Urology Section), at 8.30.—R. Thompson: Treatment of Epispadias and of Extroversion of the Bladder, with Some Remarks relating to their Origin and Anatomy.

FRIDAY, APRIL 29.

ROYAL COLLEGE OF SURGEONS OF ENGLAND, at 5.—Prof. A. Keith: Demonstration on the Contents of the Museum.
 INSTITUTION OF ELECTRICAL ENGINEERS (Students' Section) (at City and Guilds (Engineering) College) (Annual General Meeting), at 6.30.—A. C. Warren: Radio-telegraphic Transmitting Apparatus.
 JUNIOR INSTITUTION OF ENGINEERS, at 8.—W. A. Tookey: Rambling Remarks on Expert Evidence.
 ROYAL INSTITUTION OF GREAT BRITAIN, at 9.—Sir Frank W. Dyson: Advances in Astronomy.

SATURDAY, APRIL 30.

ROYAL INSTITUTION OF GREAT BRITAIN, at 3.—H. Y. Oldham: The Great Epoch of Exploration; (2) Spain.

MONDAY, MAY 2.

VICTORIA INSTITUTE (at Central Buildings, Westminster), at 4.30.—Rev. J. Gosset-Tanner: The Tripartite Nature of Man.
 ROYAL INSTITUTION OF GREAT BRITAIN, at 5.—Annual Meeting.
 ROYAL COLLEGE OF SURGEONS OF ENGLAND, at 5.—Prof. S. G. Shattock: Demonstration on Pathological Specimens in the Museum.
 SOCIETY OF ENGINEERS (INC.) (at Geological Society), at 5.30.—A. S. E. Ackermann: The Physical Properties of Clay (third paper).

ARISTOTELIAN SOCIETY (at University of London Club), at 8.—Miss H. D. Oakeley: Prof. Driesch's Attempt to Combine a Philosophy of Knowledge and a Philosophy of Life.
 ROYAL INSTITUTE OF BRITISH ARCHITECTS, at 8.
 SOCIETY OF CHEMICAL INDUSTRY (at Chemical Society), at 8.
 ROYAL GEOGRAPHICAL SOCIETY (at Eolian Hall), at 8.30.
 ROYAL SOCIETY OF MEDICINE (Tropical Diseases and Parasitology Section), at 8.30.—Dr. A. F. MacCallan: The Ankylostomiasis Campaign in Egypt, 1913-1915.—Sir Leonard Rogers: The Mortality and Prognosis of Cholera treated by the Author's Hypertonic Saline Method, based on 2000 Cases.

TUESDAY, MAY 3.

ROYAL HORTICULTURAL SOCIETY, at 3.
 ROYAL INSTITUTION OF GREAT BRITAIN, at 3.—Prof. A. Keith: Darwin's Theory of Man's Origin in the Light of Present-Day Evidence.
 ROYAL SOCIETY OF ARTS (Indian Section), at 4.30.—W. Raitt: Paper-dulp Supplies from India.
 ROYAL PHOTOGRAPHIC SOCIETY OF GREAT BRITAIN, at 7.—H. S. Watkins: Colour Photography.
 ROYAL ANTHROPOLOGICAL INSTITUTE (at Royal Society), at 8.15.—J. Reid Moir: An Early Chellean Palaeolithic Workshop Site in the Pliocene Forest-bed of Cromer, Norfolk.

WEDNESDAY, MAY 4.

THE INSTITUTION OF CIVIL ENGINEERS, at 4.—Presentation of the Kelvin Medal to Dr. W. C. Unwin by the Right Hon. A. J. Balfour.
 ROYAL SOCIETY OF ARTS, at 4.30.—Sir Geoffrey Butler: Anglo-American Relations: A Personal Impression.
 GEOLOGICAL SOCIETY OF LONDON, at 5.30.—Miss I. A. MacDonald and Dr. A. G. Trueman: The Evolution of Certain Liassic Gastropoda, with Special Reference to their Use in Stratigraphy.—H. Hamshaw Thomas: An Otokaria-like Plant from South Africa.—Dr. A. B. Walkom: Nummulospermum, gen. nov.: the Probable Megasporengium of Glossoteris.

ENTOMOLOGICAL SOCIETY OF LONDON, at 8.
 INSTITUTE OF METALS (at Institution of Mechanical Engineers), at 8.—Prof. T. Turner: The Casting of Metals (Annual May Lecture).
 SOCIETY OF PUBLIC ANALYSTS AND OTHER ANALYTICAL CHEMISTS (at Chemical Society), at 8.—F. G. H. Tate and J. W. Pooley: Detection and Estimation of Illipe Nut Fat used as a Substitute for Cocoa Butter.—G. W. Monier Williams: Notes and Demonstration on Apparatus for determining Hydrogen Ion Concentration.—E. Paul: Note on the Oil of Oats.—H. Atkinson: Estimation of Potassium in Presence of Sodium, Magnesium, Sulphates, and Phosphates.

THURSDAY, MAY 5.

IRON AND STEEL INSTITUTE (Annual Meeting) (at Institution of Civil Engineers), at 10 and 2.30.—H. Brearley: The Welding of Steel in relation to the Occurrence of Pipe Blow Holes and Segregates in Ingots.—Dr. J. E. Stead: Solid Solution of Oxygen in Iron.—H. T. Ringrose: Scientific Control of Combustion.—J. E. Fletcher: Open-hearth and Other Slags—their Composition and Graphic Methods for determining their Constitution.—S. H. Fowles: Notes on the Cleaning of Blast-furnace Gas.
 ROYAL INSTITUTION OF GREAT BRITAIN, at 3.—Dr. C. S. Myers: Psychological Studies: (1) The Localisation of Sound.
 ROYAL SOCIETY, at 4.30.—Dr. H. Head: Release of Function in the Nervous System (Croonian Lecture).
 LINNEAN SOCIETY, at 5.—Prof. J. Stanley Gardiner: Reports on Collections from the Indian Ocean for Issue in the Society's

Forthcoming Transactions, vol. xviii.—E. R. Speyer: Insects in Relation to Reproduction in Coniferous Trees.—Prof. W. J. Dakin: The Collections from the Houtman Abrolhos Islands in 1913.

CHILD-STUDY SOCIETY (at Royal Sanitary Institute), at 6.—Miss F. E. Webb and Others: Individual Training in the School.
 INSTITUTION OF ELECTRICAL ENGINEERS (at Institution of Civil Engineers), at 6.—Discussion on Tariffs (continued).

CHEMICAL SOCIETY, at 8.
 ROYAL SOCIETY OF MEDICINE (Obstetrics and Gynecology Section), at 8.—Annual General Meeting.—H. Curtis: Angioma of the Vagina Spontaneously Evacuated.—Dr. A. E. Giles and Others: The Causes and Treatment of Sterility.

FRIDAY, MAY 6.

IRON AND STEEL INSTITUTE (Annual Meeting) (at Institution of Civil Engineers), at 10 and 2.30.—S. N. Brayshaw: The Prevention of Hardening Cracks, and the Effect of Controlling the Recalescence of a Tungsten Tool Steel.—Dr. J. Newton Friend: The Protection of Iron with Paint against Atmospheric Corrosion.—K. Honda, T. Matsushita, and S. Idei: The Cause of Quenching Cracks.—W. E. Hughes: Slip-lines and Twinning in Electrodeposited Iron.—A. Westgren: Röntgen Spectrographic Investigations of Iron and Steel.—J. H. Whiteley: Cupric Etching Effects produced by Phosphorus and Oxygen in Iron.
 ROYAL SOCIETY OF MEDICINE (Laryngology Section), at 4.45.—Annual General Meeting.

ROYAL ASTRONOMICAL SOCIETY (Geophysical Discussion), at 5.—Sir Napier Shaw, Col. E. Gold, W. H. Dines, and F. J. W. Whipple: The Structure of the Atmosphere up to 20 kilometres. Chairman: Dr. G. C. Simpson.
 ROYAL INSTITUTION OF GREAT BRITAIN, at 9.—Sir Robert Robertson: War Developments of Explosives.

SATURDAY, MAY 7.

ROYAL INSTITUTION OF GREAT BRITAIN, at 3.—Prof. E. C. C. Baly: Chemical Reaction.

CONTENTS.

PAGE

Agriculture and Fisheries in the Civil Service Estimates	257
A Sportsman-Naturalist	259
British Iron Ores. By Prof. H. Louis	261
Physical and Inorganic Chemistry. By Prof. J. R. Partington	262
Our Bookshelf	263
Letters to the Editor:—	
The Internal Physics of Metals.—Sir George Beilby, F.R.S.; The Writer of the Article	265
Biological Terminology.—Sir G. Archdall Reid, K.B.E.	265
The "Flight" of Flying-fish.—Julian S. Huxley	267
The Concept of "Space" in Physics.—Dr. Harold Jeffreys	267
The Origin of "Churning at 62°" on Dairy Thermometers.—R. Hedger Wallace	268
Young's Interference Experiment.—Dr. R. A. Houston	268
The Electroless Discharge in Sodium Vapour.—Prof. John K. Robertson	269
High-speed Aircraft Propellers and the Destruction of Gnats.—Henry C. Watts	269
Why do Worms Die?—G. T. Harris	269
Vegetation around London Earlier than in the Provinces.—Chas. Harding	269
A Modern Inorganic Chemistry.—Prof. J. R. Partington; The Reviewer	269
The High Pamir. (Illustrated)	270
Primitive Chronology. By Dr. J. L. E. Dreyer	274
Obituary:—	
Prof. A. W. Reinold, F.R.S. By W. N. S.	276
Robert Allen Rolfe	276
Notes	277
Our Astronomical Column:—	
The Accelerations of the Sun and Moon	281
1646 Spectroscopic Parallaxes	281
A Catalogue of Radial Velocities	281
The Microstructure of Coal	282
The Cretaceous-Tertiary Boundary in North America. By Prof. A. C. Seward, F.R.S.	282
Isle of Wight Disease in Hive Bees. By Dr. A. D. Imms	283
University and Educational Intelligence	284
Calendar of Scientific Pioneers	285
Societies and Academies	285
Books Received	287
Diary of Societies	287



THURSDAY, MAY 5, 1921.

Editorial and Publishing Offices:

MACMILLAN & CO., LTD.,

ST. MARTIN'S STREET, LONDON, W.C.2.

Advertisements and business letters should be
addressed to the Publishers.

Editorial communications to the Editor.

Telegraphic Address: PHUSIS, LONDON.

Telephone Number: GERRARD 8830.

Physics a Profession.

FIFTY years ago, as Sir J. J. Thomson pointed out in his address at the inauguration of the Institute of Physics on April 27, there could be no profession of physics. There were a few laboratories—the oldest at the Royal Institution, founded by Count Rumford; the home of Young and Faraday. They could be counted almost on the fingers of the two hands. There were laboratories in Scottish universities. Kelvin was at work at Glasgow, Tait at Edinburgh, Balfour Stewart at Manchester, Carey Foster was teaching at University College, London, Clifton had built the Clarendon Laboratory at Oxford, Maxwell had only recently resigned his professorship at King's College (he went to Cambridge in 1871). The Cavendish Laboratory was being planned; the seventh Duke of Devonshire had written to the Vice-Chancellor:

"I find in the report . . . recommending the establishment of a professor and demonstrator of experimental physics that the building and apparatus required for this department are estimated to cost 6300*l*. I am desirous to assist the University in carrying this recommendation into effect and shall accordingly be prepared to find the funds required for the building and apparatus."

¹ The tender ultimately accepted for the building was 845*l*, exclusive of gas, water, and heating.

Maxwell, in his inaugural lecture, said:

"Our principal work in the laboratory must be to acquaint ourselves with all kinds of scientific methods, to compare them and estimate their value. It will, I think, be a result worthy of our University, and more likely to be accomplished here than in any private laboratory, if by the free and full discussion of the relative value of different scientific procedures we succeed in forming a school of scientific criticism, and in assisting the development of the doctrine of method."

Physics as a profession by which numbers of men would earn a livelihood and at the same time revolutionise the daily life of the world by bringing into it knowledge acquired in the laboratory and the study never entered Maxwell's thoughts. Contrast this, as Sir Joseph Thomson did, with the position at present—a university or technical school in almost every great town, each with its well-equipped physical laboratory, its keen professor and its enthusiastic students; laboratories in all the larger schools, with a staff of teachers numbering many hundreds. Fifty years ago the army of physicists was small in numbers; its generals were great men, but they had few of the rank and file to command. To-day our leaders in physical science have under their direction a host of willing privates ready to assist in advancing further the boundaries of knowledge and to adapt the discoveries of those leaders to the requirements of modern life. So it has come about that an Institute of Physics was needed; the attendance at the inaugural meeting on April 27 gave evidence of the need; for there is now a profession of physics.

"Up to the present," to quote from the memorandum explaining the objects and methods of the institute, "the physicist has hardly been recognised as a member of one of the professions. His work will become more and more important in the future both in science and industry, and one of the aims of the institute is to accelerate the growth of the recognition of his position and value. The science of chemistry has already secured a belated recognition of its value to the nation, but there has been so far little or no recognition of the equally important claims of physics and the physicist, although the application of physical knowledge and physical methods is no less vital to the country."

Both Mr. A. J. Balfour and Sir Joseph Thomson placed physics on a higher pedestal than this. Mr. Balfour pointed out that to give a physical explanation of a phenomenon was one of the highest aims of scientific inquiry, and Sir Joseph reminded us that at Cambridge not many years

ago chemistry was counted one of the "other branches of physics."

Some of us in the early days of the war faced very sadly the difficulty of bringing home to some of our rulers the value of physics and the services physicists could render. Five years of trial have enforced the lesson, and now it is widely realised that in many branches of work the physicist is able to give much-needed help; opportunities are open to him in widely different directions.

It may be useful to consider some of these. Fifty years ago a few ill-paid teaching posts were all to which a physicist could aspire. The love of discovery, the desire to fathom the secrets of Nature, to give a physical explanation, bringing into their due relation facts apparently disjointed and diverse, brought their own reward—a reward sufficient for the few who devoted their lives to science. And this still remains. Much has been learned; but Nature still hides many secrets, and for the man who can unravel these there is still an ample reward. But the task of nearly all professional physicists must be humbler far. They can assist the work of the discoverer by reducing the period of suspense which, as Sir Joseph Thomson pointed out, will always elapse between a great discovery and the full realisation of its meaning; they can check some of its consequences, indicate the directions in which it may be of service, or carry out supplementary investigations under the guidance of the discoverer himself.

Such would be the work of the young student in the university laboratory training for his profession. And the openings in that profession are very numerous; at present it is hard to find men to fill them; the heads of the fighting Services have realised their need of the physicist. At Woolwich there is a well-equipped laboratory employing a number of highly skilled men. Gunnery has its problems which only the trained physicist can solve, and calls to its assistance the help of the meteorologist and the engineer. Sound ranging, the methods of protection against aircraft, signalling, the use of wireless telegraphy, the application of the petrol engine to transport work, and a host of other questions, are examples of the need for physicists in military work.

Nor is the Air Service less dependent on the physicist. Questions which he alone can solve are brought before every meeting of the Aeronautical Research Committee, and it is only lack of funds that prevents a far larger number

of physicists from being employed at the National Physical Laboratory, at Farnborough, and at the other experimental stations of the Air Ministry.

In the Naval Service steps have lately been taken to organise more fully the Scientific Services. Mr. F. E. Smith, the recently appointed Admiralty Director of Scientific Research, gave some account of these at the Cardiff meeting of the British Association last August. For certain parts of the work it is hoped to utilise the opportunities afforded by the National Physical Laboratory, and an admirable building has been erected at Teddington in which work of a strictly confidential character can be carried on; the Signal School at Portsmouth has been reorganised; while work on the petrol engine, commenced during the war under Sir Dugald Clerk at the Imperial College, is now being continued in a special Admiralty laboratory.

Other Government Services, as well as private firms and individuals, have access to the National Physical Laboratory, where, according to the last report, well over one hundred scientific assistants are employed. In the Government service alone there is now engaged a large class of professional physicists occupying permanent posts with reasonable opportunities for advancement and, in the majority of cases, superannuation privileges.

Or, again, turning to another class of service, many, possibly most, of the Research Associations established under the Department of Scientific and Industrial Research depend on the physicist for their investigations, while in almost every large industry there is a demand for his work. The need for an Institute of Physics to care for the professional interests of the large number of men who have already embraced the profession, and of the still larger number who will be required so soon as trade revives, and may hope by their work to advance the date of its revival and to accelerate its progress, is amply proved. The object of the institute will be to promote the efficiency and usefulness of its members by setting up a high standard of professional and general education and knowledge, and by compelling the observance of strict rules of personal conduct as a condition of membership; an association of men who, in Mr. Balfour's words, "by the growth of science and invention would give comfort and leisure where at present discomfort and labour were the only means of producing an article," and by their example would teach our people how to use their leisure.

Polar Exploration.

The Lands of Silence: A History of Arctic and Antarctic Exploration. By Sir Clements R. Markham. Pp. xii + 539. (Cambridge: At the University Press, 1921.) 45s. net.

IT is impossible to bear in mind, while reading this book, that it is the posthumous work of an octogenarian. To those who knew the author in the great days of Antarctic propaganda twenty-five years ago, these enthusiastic appreciations of old explorers bring back the very tones of the eager living voice. No man ever did more to make the glories of the past live again in the exploits of his own day, and Sir Clements Markham will always be remembered as a potent force in exploration and an inspiring historian. He was a hero-worshipper whose incense has imparted an undying charm to the memory of the Elizabethan adventurers and to the officers of the Franklin search. He was a stimulating guide to the young explorers whom he sent out to the Antarctic, and he supported the men of his choice through thick and thin, rewarding them while living, and honouring them when dead.

If this beautifully named and stately volume on "The Lands of Silence" were intended merely as a popular series of impressions and appreciations, we could only praise it as the most moving of all the romances of discovery. But it claims to be a history; it is written by the one man whose active life embraced sixty years of experience in polar voyages; it is edited by Dr. F. F. H. Guillemard, whose brilliant studies in historical geography are unrivalled for conscientious completeness; and it is published by the Cambridge University Press. Even so, we would hesitate to look critically into the work of a very old man in his last year of life if the book had shown any signs of senile weakness. The remarkable fact is that it does not. The manner is the manner of Sir Clements Markham in his prime; the opinions are those that he always held and gloried in proclaiming, and we feel that readers of a new generation should be warned that in many cases the opinions of the author are not shared by the majority of polar students.

At the outset the polar regions are defined as extending from the Poles to about 70° latitude, and the sub-Arctic and sub-Antarctic from 70° to 60°. This would exclude a large part of Greenland from the Arctic regions, and remove South Georgia and the Sandwich group from the sub-Antarctic zone; but as no subsequent attention is paid to the definitions they do not in any way limit the scope of the book, which practically treats of all explorations into icy seas.

While Sir Clements Markham deprecates mere record-breaking attempts to reach the Poles, and lays some stress on the importance of studying oceanography, meteorology, geology, and natural history in polar areas, he insists strongly that the real use of polar discovery is as a nursery for seamen, and as an opportunity for naval officers to win distinction in time of peace. Hence his sympathies go out most spontaneously to those explorers who face difficult conditions without the aid of animal or mechanical transport. Polar research, as distinct from exploration, makes a less strong appeal, and the account of the great international circumpolar investigations of 1882 is cold and incomplete. No mention is made of the Antarctic series of stations, which was as important a part of the main scheme as the Arctic series. The indifference to scientific work and workers is often apparent, sometimes in curious ways. While copious biographical details are given even of the most junior naval officers in every British expedition, Sir Douglas Mawson is almost the only British man of science so treated. In many cases the Christian names of men of science are not mentioned, and often not even their initials, so that identification is not always easy, even with the aid of the index. The latter does distinguish "Bruce, Mr.," from "Bruce, Commander Wilfrid," but less than justice is done to Dr. W. S. Bruce in the text, which is sadly restrained as to the work of the *Scotia*. The scientific staff of the Scottish expedition is barely referred to, and Mr. R. C. Mossman, who established the most southerly meteorological station in the world, and kept it going for several years, is not mentioned at all. The expeditions of Capt. Scott are allowed to throw a shadow over those of all other Antarctic explorers.

The committee of the Royal Society, which co-operated with that of the Royal Geographical Society in planning the *Discovery* expedition, was not suffered gladly by Sir Clements, who says: "Yet there was long and tedious opposition from joint committees, special committees, and sub-committees, and all the complicated apparatus which our junction with the Royal Society involved, harder to force a way through than the most impenetrable of ice-packs" (p. 448). The description of the circumstances which led to the selection of the leader and other members of the expedition is suggestive reading when coupled with the note on a chief of the scientific staff "who, perhaps fortunately, did not go out" (pp. 447, 453). A useful chronological supplement containing several names not mentioned in the text, and an excellent bibliography by Mr. Edward Heawood, correct some of the

false perspectives created by the very irregular treatment of different expeditions.

In dealing with the northern journeys of Admiral Peary, Sir Clements Markham takes a strongly adverse view of the ability of that explorer to fix his latitude near the Pole (not to put the case too high), and in this he differs from the considered judgment of the Royal Geographical Society, which, after testing the observations, presented Peary with its gold medal, the highest possible mark of confidence in his ability and integrity. The statement on p. 229 as to Kane's description of the Arctic Highlanders being the best ignores the exhaustive anthropometric work of Peary and his comrades during their years of residence with the tribe. At the other end of the earth Borchgrevink is also treated with scant sympathy, and no stress is laid on the fact that he was the first to face the unknown conditions of a winter on Antarctic land, nor is the great discovery of his expedition, that the Ice Barrier of Ross had retreated many miles since it was first seen, even mentioned; but that discovery is actually credited to Scott's expedition (*cf.* pp. 433 and 457).

An obvious oversight in reading the second voyage of Captain Cook has led Sir Clements to credit that great navigator with having been the first to see the continental land of Antarctica when at his extreme south position, $71^{\circ} 10' S.$, in the Pacific. Cook, however, distinctly states that he saw no land on that occasion. He believed in the existence of an Antarctic continent on theoretical grounds, and said that "it is probable we have seen part of it," referring undoubtedly to his discovery of Sandwich Land south-east of his Isle of Georgia; but the insularity of that land was shown by Bellingshausen, to whom, or to Wilkes, or to Dumont D'Urville is due such credit as a first glimpse may convey. As Sir Clements left those parts incomplete, Dr. Guillemard gives a fairly proportioned description of the work of Roald Amundsen in the North-west Passage and at the South Pole, and also of Sir Ernest Shackleton's first expedition. The history stops short of Sir Ernest Shackleton's great adventure in the *Endurance*, which, however, is noted in the chronology.

As to future work, Sir Clements Markham indicates that Antarctic advance can be made most easily along coasts which face the east. This is undoubtedly true in the case of Victoria Land, but we cannot agree with the view that it is so in Graham Land, where the western side has always been found more accessible than the eastern. The lead of an east-facing coast is not a sufficient guide for explorers, and we hold to the view that the next Antarctic expedition should be an effort

to circumnavigate Antarctica, following the coast westward from Queen Mary Land to Coats Land, and from the west side of Graham Land to King Edward Land.

HUGH ROBERT MILL.

Marine Deposits.

Geologie des Meeresbodens. By Prof. K. Andrée. Band ii. : *Die Bodenbeschaffenheit und nutzbare Materialien am Meeresboden.* Pp. xx+689+7 Tafeln. (Leipzig: Gebrüder Borntraeger, 1920.) 92 marks.

THE geology of the sea-floor is geology in the making, since the most important and significant sedimentary rocks were laid down in the sea. The study of these deposits received a great impulse on the discovery by the *Challenger* Expedition of the unexpected contrast between the marginal and deep-sea formations; and the monograph by Murray and Renard on the deep-sea deposits ranks as one of the most epoch-making of the *Challenger* reports. Since its appearance the literature on the subject has been voluminous and is unusually scattered, for the processes of marine sedimentation involve large parts of oceanography, physical geography, and geology, and, in addition to the literature of those sciences, essential data are contained in the serials of applied science and in fugitive newspaper reports.

The geology of modern marine deposits has now been resurveyed by Prof. Andrée in a summary of current knowledge of the subject, which this volume completes by a detailed description of marine deposits and by a short account of their economic products. The work is the more convenient for reference as it follows the ordinarily accepted lines of treatment. The first sections deal with marine sedimentation, including the study of wave action and shore deposits, coastal transport, and the mineralogical and organic structure of shore sands, mud, coral reefs, and serpula-atolls. The salt beds thrown down by the evaporation of seawater are grouped as the Halmyrogene products, adopting Krummel's term. In this section of the book Prof. Andrée discusses, among other problems, those of coral reefs; and he maintains that recent investigations and the borings at Funafuti have brilliantly and firmly established Darwin's theory of the origin of coral islands. Passing to the coastal shelf, he describes its deposits, and summarises modern evidence as to the depth of current action; he accepts it, on the evidence of the exposure of hard rocks, which he explains as swept clear of mud, at depths of more than 5000 ft.

Such bare rock surfaces, however, have also been explained as due to recent subsidence or submarine eruptions, and are not alone conclusive evidence of deep-sea currents. The wide distribution of land material at sea by the wind is illustrated by a map of the tropical Atlantic showing the areas reached by African dust.

The deposits next outside the continental shelf are classified by Prof. Andrée as the Hemipelagic group, a term introduced by Krummel, of which among the most interesting are the glauconites. The Eupelagic, the typical oceanic deposits, include the true oozes, for which the author conveniently accepts the term Schlamm, although it has been used by Walther and Penck as the equivalent of mud. It would be an advantage if German authorities adopted the author's nomenclature. The account of the abyssal oozes is especially full and instructive. Prof. Andrée discusses various attempts to estimate geological time by the accumulation of the deep-sea deposits; but comparison of the rapid rate indicated, according to Murray, by the covering of cables, with the extremely slow rates claimed by Lohmann, justifies the author's conclusion that the materials are still too scanty and contradictory to yield trustworthy conclusions.

The last sections of the book deal with the stratigraphy of the younger marine deposits and with the quantity of radium in the sediments. An account is given of the geographical distribution of the various deposits in the different oceans, which is illustrated by an excellent map. The final chapter on the useful materials found on the sea-floor is the most scanty and least satisfying; marine placers, for example, are dismissed in a short paragraph. In connection with these deposits, the author remarks, regarding the much discussed question of the occurrence of gold in sea-water, that its presence has not yet been proved; he considers that the belief in gold as a constituent of sea-water rests on gold introduced in the reagents. This conclusion is, however, difficult to reconcile with the blank results obtained by Prof. Liversidge in the test analyses of pure water conducted at the same time as those of his samples of sea-waters.

J. W. GREGORY.

Study of Plants in the Field.

The Outdoor Botanist. By A. R. Horwood. Pp. 284+20 plates. (London: T. Fisher Unwin, Ltd., 1920.) 18s. net.

THE sub-title of this work, "A Simple Manual for the Study of British Plants in the Field," indicates the main purpose of the author, who dedicates the book to the veteran field-

botanist, Dr. G. Claridge Druce. To achieve a knowledge of the living plant, he says, let the botanist take to the field—*i.e.* be an outdoor botanist. As it is necessary "at the outset to make collections," the first chapter is devoted to methods of collecting and preserving plants, and he gives many useful hints to beginners. The several types of collections which may be made to illustrate particular aspects of the subject are also indicated.

Following this introduction is a long chapter—occupying more than a third of the volume—on ecology, "the study of the homes of plants, their mode of occurrence in the field, and the factors of their environment." Certainly here is an opportunity for the British outdoor botanist; but a perusal of the pages shows that the author has forgotten his original purpose, judging from the frequent references to exotic vegetation—*e.g.* mangrove swamps, desert plants in Asia and Africa, palms and wind witches, and others ranging from the Dead Sea and the Alps to the Badlands of North America. The sources of information here are too obvious for this to be the result of "study in the field," but rather what the author calls "armchair work"; no attempt is made to relate it to British ecology. The subject-matter is confused and rendered difficult for a beginner to appreciate by the absence of proper subject classification and sub-headings, and the whole reads like a collection of brief statements on plant habitats and communities. Misleading and contradictory statements are frequent—*e.g.* on p. 84, and again on p. 103, we are told that "the initial stage of a large proportion of the vegetation of the country is woodland." P. 91: "A wood association on a dry soil is a damp oakwood association." On p. 103 it becomes a "dry oakwood," and a "damp oakwood" is the typical woodland on "clay and loam." P. 74: "There is a pressure exerted by the atmosphere which increases with altitude." P. 76: "In a variety of ways temperature affects plants. It does not vary like the water supply"; and on the same page: "In peaty soils the water is inaccessible to plants, so they are xerophytic."

The author is on rather safer ground in the next chapter, on "Field Botany and Survey Work," and in a discursive way gives some sound advice on note-taking and sketching, and on avoiding work on too wide a field, advice which the author himself evidently finds a difficulty in following. Plans are given illustrating his "field to field" work, and he explains the use of squares, grids, and transects. Chapters follow on "Botany and Scenery," "Phenology," and "Nature Diaries," concluding with "Hints to the Teacher." There

is also a glossary which, like much of the work, needs revision—*e.g.* "palisade tissue" is defined as the "water-conducting region of plant stems," and "chloroplasts" as "chlorophyll cells." With one of his dicta we heartily agree: "Since ecology and physiology are really complementary, neither can be adequately studied without the other." The volume includes a number of illustrations from photographs, many of which are exceedingly good and very well reproduced.

An Historical Catalogue of Science.

Bibliotheca Chemico-mathematica. Compiled and annotated by H. Z. and H. C. S. Vol. i. Pp. xii+428+plates. Vol. ii. Pp. 535+plates. (London: Henry Sotheran and Co., 1921.) 3l. 3s. net.

THE mental stimulus to be gained by the study of the historical development of science is of much greater value than is sometimes supposed. He who follows, from the first vague beginnings, the efforts of many workers in various lands, leading at length to some great discovery, whether of practical or of theoretical significance, will be apt to ask himself the question: "Could not I also do something to help forward human knowledge?"

In this sale catalogue of more than 17,000 books on mathematics, astronomy, physics, chemistry, engineering, meteorology, and allied subjects there is ample opportunity for anyone to pick out books relating to his own special department. The search is rendered easy by a subject index.

The volumes comprise two catalogues arranged according to authors' names, together with a supplement, and give the date of publication and present price of each book. The whole work is due to Heinrich Zeitlinger, of Linz, and it is said to contain nearly all the standard works on the subjects catalogued, and most of the earlier works of historical importance.

The most striking features of the catalogue are the fascinating illustrations. They are prepared by a photographic process, and give excellent facsimile representations of title-pages, woodcuts, diagrams, and letterpress taken from more than one hundred books celebrated either for their quaintness or for having announced new discoveries of far-reaching importance. Thus there is a reproduction, on a reduced scale, of Galileo's famous proposition that a body starting from rest under uniform acceleration moves distances proportional to the square of the time. This is photographed from the first edition of his "Discorsi e Dimostrazioni Matematiche," published at

NO. 2688, VOL. 107]

Leyden, in 1638. Another facsimile is taken from Huygens's "Traité de la Lumière," published in 1690, in which he deduced the equality of the angles of incidence and reflection from the wave theory of light. There are also beautiful reproductions from Kepler's "Dioptrice," published in 1611. The selected pages discuss the refraction of light and the formation of images by convex lenses.

Some pages from "De Beghinselen der Weeghconst," by Simon Stevinus, of Bruges, published in 1586, contain propositions on the inclined plane (triangle of forces), levers, and laws of floating bodies. Among other curious illustrations, we find an early velocipede from a book by Ovenden, dated 1774, and an early railway train, in which stage coaches, complete with driver, guard with coach-horn, and luggage on the roof, are being drawn by a quaint locomotive with a single rope.

Another illustration shows a very early electric telegraph devised in 1816 by Sir Francis Ronalds. The invention was offered to the Admiralty, but Sir Francis was officially answered that, now the French War was over, telegraphs of any kind were totally unnecessary, and that no other method of signalling than the semaphore then in use would be adopted.

From "Mathematicall Magick," by Bishop Wilkins (1648), are given some illustrations of perpetual motion. As it is obvious that the machines could not work, we wonder whether the Bishop, who was the first secretary to the Royal Society, ever tried the experiments!

These few examples will show that the illustrations are mainly selected to show great discoveries in their early stages.

Maps and Map-reading.

- (1) *Topographic Maps and Sketch Mapping.* By Prof. J. K. Finch. Pp. xi+175. (New York: John Wiley and Sons, Inc.; London: Chapman and Hall, Ltd., 1920.) 13s. 6d. net.
- (2) *Ordnance Survey Maps: Their Meaning and Use. With Descriptions of Typical 1-in. Sheets.* By Dr. Marion I. Newbigin. Second edition. Pp. 128. (Edinburgh: W. and A. K. Johnston, Ltd.; London: Macmillan and Co., Ltd., 1920.) 2s. net.
- (3) *Notes on Geological Map-reading.* By A. Harker. Pp. 64. (Cambridge: W. Heffer and Sons, Ltd., 1920.) 3s. 6d. net.

(1) **A**S the author states in his preface, this book was the outcome of the demand for instruction in map-reading and field sketching

brought about by the war, and it is one of many owing their appearance to the same cause.

Part i. deals with map-reading, and the surveys of the United States, France, and Britain are represented in the maps used as illustrations; contours and elevations, direction, scale, sections and profiles, slopes, visibility problems, and grids are successively dealt with. Part ii. is concerned with the methods of making sketch-maps and field sketches. The instructions for both the making and interpretation of maps are clear and concise, and there is a useful appendix giving a descriptive list of the principal topographic maps of the world.

(2) Miss Newbiggin has produced a very readable and suggestive little volume. Following a general introduction indicating the difficulties which the uninitiated may encounter when confronted with the problem of eliciting desired information from an Ordnance map, and indicating the many and varied uses to which such a map may be put by those properly instructed in its mysteries, the author devotes a chapter to methods of studying the maps with and without extraneous aids, such as photographs. Curiously enough, no mention is made of the possible use of photographs taken from the air in connection with the study of Ordnance maps, though the fact that such photographs are not, as yet, generally available may account for the omission.

The main part of the book is made up of descriptions of selected sheets of the 1-in. survey of Britain, and these are well worked out and of much interest as showing the very varied deductions which may be made from the study of a detailed map.

Much is said of the geological structure of the country, but it is to be feared that, in the absence of geological training on the part of the student, and in too many cases on the part of the teacher also, any geological deductions made merely from a study of the configuration of the ground as depicted in the Ordnance maps will be of but little value, and, if relied upon, may give rise to erroneous impressions. Even in the case of Pleistocene geology the reviewer knows only too well that deductions with regard to details of glacial geology drawn from a study of contours have frequently to be abandoned when the matter is studied in the field; and though such deductions may be useful in the formation of tentative hypotheses by the investigator, they would seem to be somewhat dangerous tools to place in the hands of the novice.

(3) The methods advocated by Mr. Harker, though not new, are developed to an unusual

extent, and many applications of great interest are elaborated. He shows that, by the reduction of both the slope of the ground and the dip of the strata to "gradients," it is possible to gain much information with regard to the thickness of beds or formations and the general structure of an area depicted upon a map without the use of the protractor.

The surface gradient is determined in the usual way by measuring the distances between contour lines, and that of the stratum under consideration by determining the strike by joining points of equal altitude on the outcrop, and then drawing parallel strike lines through points where the outcrop crosses successive contour lines. These strike lines will be separated by the same vertical interval as the contour lines, and the stratum-gradient obtained by measuring the distance between contiguous strike lines.

The methods are illustrated by a number of interesting and varied examples on a scale of 6 in. to a mile, and for maps on this scale with numerous contour lines they are readily applicable; but in the case of smaller scales, such as the 1-in. maps most generally in use in this country, much difficulty would attend their use, while in the absence of contour lines they are, of course, inapplicable.

The diagrams are good and clear, but in some of these, and also in parts of the letterpress, lucidity has been to some extent sacrificed to the exigencies of space. Thus in paragraph 23 and the accompanying Fig. 18, in which the reader is for the first time introduced to an "unconformable sequence," the unconformity is complicated by "overlap."

As an aid to teachers or in the hands of senior students or engineers, the methods advocated should prove highly instructive, but the reviewer feels that they do not form an adequate substitute for those more generally in use, and would not be readily grasped by the average junior student.

Our Bookshelf.

Zoology: An Elementary Text-book. By Sir A. E. Shipley and Prof. E. W. MacBride. Fourth edition. (Cambridge Zoological Series.) Pp. xx+752. (Cambridge: At the University Press, 1920.) 20s. net.

FIVE years have passed since the third edition of this now well-known text-book appeared, and the authors have taken advantage of the opportunity offered by the call for a new edition to place at their readers' disposal some facts and inferences due to certain recent researches. Thus, in the account of *Amœba*, Jennings's view that the

creature's movements are due to contractility of the ectoplasm is followed (in one instance, on p. 17, where this matter is discussed, "endoplasm" seems to have been printed by mistake). Turning to the chapters on Vertebrata, it will be found that Ridewood's researches on the development of vertebræ have been utilised; these, as is pointed out in the preface, "have narrowed the gap between the so-called arco-centra and chorda-centra."

It is somewhat surprising to find that the paired serial excretory tubes of the Peripatids are still described as cœlomiducts, in spite of Miss Glen's recent demonstration (carried out under Prof. MacBride's auspices) that they are true nephridia. This discovery renders the retention of the group in a "class Antennata," which includes also Millipedes, Centipedes, and Insects, the more unnatural.

As one turns over again the pages of this volume the clearness of the descriptions and the excellence of most of the 360 illustrations afford renewed pleasure. In a future edition some of the representations of insects might be replaced with advantage; no entomologist would recognise the figure that does duty for a tsetse-fly.

G. H. C.

Marine Engineering. (A Text-Book.) By Engineer-Capt. A. E. Tompkins. Fifth edition, entirely revised. Pp. xi+888. (London: Macmillan and Co., Ltd., 1921.) 36s. net.

THE fourth edition of this work was published in 1914, a few weeks before the outbreak of the war, and was reviewed in our columns in September of that year. Owing to the great advancement in marine engineering which has since taken place, a large part of the book has been rewritten, and the remainder thoroughly revised. We are specially glad to notice that room has been found for a fuller consideration of mercantile practice, since this will have the effect of bringing the merits of the volume before a greatly enlarged class of readers. The section on turbines now covers three chapters, and includes an adequate discussion of geared turbines and auxiliaries. The latest systems of oil-firing are included; and the section on internal-combustion engines has been enlarged, and embraces both submarine and mercantile engines.

The labour of revising a comprehensive treatise such as the volume before us must have been very great, especially when one remembers that the author was on war service supervising repairs both at home and in Italy; the experience he gained during those years is embodied in the volume, and adds greatly to its value. The book is primarily intended for sea-going engineers, and therefore contains nothing in the way of mathematical fireworks. Sufficient of the theory is included to enable the reader to understand clearly the principles underlying the working of the machinery which the marine engineer is called upon to handle. The book contains a very large

number of admirable drawings, and these, together with the clear descriptions, render the volume of value to all connected with marine engineering. There is also a large collection of examination questions at the end of the volume; numerical answers are appended to these. The impression given by the volume, however, is that it is not a cram book for examinations, but a carefully thought out scheme which will add greatly to the knowledge of the engineer.

An Introduction to Technical Electricity. By S. G. Starling. Pp. xii+181. (London: Macmillan and Co., Ltd., 1921.) 3s. 6d.

THIS little work is one of a series designed for use in continuation classes and central schools to form the first stage in specialisation in the direction of electro-technics, and necessarily treats the subject in an elementary way intermediate between the scientific and the practical. With the exception of a brief mention of the transformer, only continuous currents are dealt with, and only the very simplest mathematics are required. The conception of the electric current is very suitably introduced by simple experiments with dry cells, and commendable features of the method by which the subject is developed include the leading up to the permanent magnet through the electro-magnet, and making the student familiar with the effects of a current before he is bothered about details as to its production. On the whole, however, we should have liked to see a little more continuity of idea in the treatment. Practical applications are kept well in view all through, and, in spite of a few minor inaccuracies of engineering detail, form adequate illustrations of the principles. Lamps and lighting, motors and dynamos, and the telephone are briefly explained, and, as might be expected, electrostatics do not come within the purview of the treatment.

Set of Cards for Teaching Chemical Formulae and Equations. Devised by Mrs. M. Partington. (London: Baird and Tatlock, Ltd., n.d.) 1s. 4d.

THIS is a set of cardboard pieces printed with the symbols of elements and common radicles, and graduated in size according to predominant valency; positive radicles are blue, negative are pink. The formulæ are made up by placing the appropriate elements or radicles side by side. It is at once evident that ferrous phosphate is $\text{Fe}_3(\text{PO}_4)_2$, and ferric phosphate FePO_4 , while such combinations as CaCl or NaCl_2 appear wrong at once. The idea, so far as it goes, is ingenious, and a great deal of facility in writing formulæ may be gained by an exercise more like play than work; moreover, the method cannot foster the misconception of rigid bonds. It is suggested that the pieces can be used to make constitutional formulæ—sulphuryl chloride and sulphuric acid are given as examples. It is evident, however, that before pupils get to the stage of considering the relation of these compounds, the device should have served its purpose.

Letters to the Editor.

[The Editor does not hold himself responsible for opinions expressed by his correspondents. Neither can he undertake to return, or to correspond with the writers of, rejected manuscripts intended for this or any other part of NATURE. No notice is taken of anonymous communications.]

A Comparison of British and German Volumetric Glassware.

THE manufacture of volumetric glassware was practically non-existent in this country prior to the war. During and since the war it has been developed on an extensive scale. Unfortunately, many users of volumetric apparatus believe that the accuracy of British apparatus is inferior to that of German origin. From our experience at the National Physical Laboratory we are in a position to know that apparatus of British manufacture which has passed our tests is at least as good as any similar standard apparatus of German origin. It appeared to be a matter of some interest, however, to ascertain the degree of accuracy of ordinary grade volumetric apparatus. Consequently in November last samples of glassware were obtained from seven different London firms.

Ordinary commercial-grade apparatus was asked for and the purchases were made by a third party, the firms being quite unaware that the apparatus was ultimately destined to be tested at the National Physical Laboratory. The results obtained in the tests on this apparatus are given below. The results marked * relate to apparatus bearing the trade-mark of one or other of the British manufacturers who regularly submit apparatus to the National Physical Laboratory for test. The results marked † refer to two flasks which also bore the trade-mark of a British firm. The remaining results for the November purchase relate to apparatus which had no trade-mark. This was probably mainly British, but some of it possibly of German origin.

In March last purchases were made in a similar manner, but it was stipulated that the apparatus must be of German manufacture. Of about half a dozen firms visited only two would undertake to supply apparatus of German origin. The results for the apparatus obtained from these two firms are given below, along with the results for the apparatus purchased previously:

50 c.c. Pipettes. N.P.L. limits:—Class A, ± 0.035 c.c. Class B, ± 0.06 c.c. Delivery time, 20–40 sec.

Nov. purchase, mainly British	Capacity error, c.c.	0.00	* +0.02	+0.03	+0.03	-0.03	* -0.05	+0.07	-0.07	+0.09	+0.12	+0.13	+0.15
	Delivery time, secs.	13	34	24	22	14	52	43	14	27	16	26	15
March purchase, German	Capacity error, c.c.	+0.03	-0.07	-0.08	-0.08	-0.20	-0.23	-0.23	-0.23	-0.27	-0.37		
	Delivery time, secs.	18	11	18	12	5	5	5	7	6	11		

25 c.c. Pipettes. N.P.L. limits:—Class A, ± 0.025 c.c. Class B, ± 0.045 c.c. Delivery time, 20–40 sec.

Nov. purchase, mainly British	Capacity error, c.c.	-0.01	+0.01	-0.01	+0.02	* +0.04	* +0.05	* -0.05	-0.07	-0.11	-0.17
	Delivery time, secs.	11	9	8	8	21	36	15	25	14	7
March purchase, German	Capacity error, c.c.	-0.01	+0.01	-0.02	-0.04	-0.04	-0.05	-0.13	-0.16	-0.44	
	Delivery time, secs.	10	13	11	8	10	6	7	5	4	

10 c.c. Pipettes. N.P.L. limits:—Class A, ± 0.015 c.c. Class B, ± 0.03 c.c. Delivery time, 15–30 sec.

Nov. purchase, mainly British	Capacity error, c.c.	* +0.005	* -0.010	* +0.025	* -0.030	* +0.065	-0.070	-0.115	-0.160	-0.175
	Delivery time, secs.	24	5	7	19	14	2	3	5	5
March purchase, German	Capacity error, c.c.	+0.015	-0.020	-0.020	-0.020	-0.025	-0.045	-0.055	-0.060	+0.070
	Delivery time, secs.	3	6	4	6	5	4	4	4	6

250 c.c. Flasks. N.P.L. limits:—Class A, ± 0.08 c.c. Class B, ± 0.15 c.c.

Capacity error, c.c.	Nov. purchase, mainly British	* 0.00	* +0.01	+0.03	* -0.04	* -0.05	* +0.05	+0.12	* -0.12	* +0.15	+0.20	-0.58	† -0.61
	March purchase, German	+0.08	+0.08	+0.10	+0.10	+0.10	+0.12						

50 c.c. Burettes (with tap). N.P.L. limits:—Maximum error allowed at any point, and also maximum difference allowed between the errors at any two points:—Class A, ± 0.04 c.c. Class B, ± 0.07 c.c. The delivery times specified depend on the length occupied by the graduations. For lengths between 50 cm. and 55 cm. the times are:—Class A, 110–220 sec.; Class B, 75–220 sec.

November purchase, mainly British.							March purchase, German.						
Capacity errors, c.c.					Difference between smallest and largest error, c.c.	Delivery time, secs.	Capacity errors, c.c.					Difference between largest and smallest errors, c.c.	Delivery time, secs.
10 c.c.	20 c.c.	30 c.c.	40 c.c.	50 c.c.			10 c.c.	20 c.c.	30 c.c.	40 c.c.	50 c.c.		
* -0.01	0.00	-0.02	0.00	0.00	0.02	51	-0.01	-0.07	-0.12	-0.13	-0.12	0.12	14
* -0.05	-0.05	-0.09	-0.10	-0.05	0.05	69	-0.05	-0.09	-0.07	-0.13	-0.20	0.15	78
+0.07	+0.09	+0.08	+0.14	+0.10	0.07	52							
-0.04	-0.01	-0.03	-0.11	-0.13	0.12	24	-0.02	-0.06	-0.10	-0.14	-0.18	0.16	24
-0.04	-0.12	-0.14	-0.14	-0.17	0.13	39	-0.02	-0.10	-0.10	-0.11	-0.20	0.18	43
-0.08	-0.10	-0.14	-0.25	-0.27	0.19	21							
+0.13	-0.09	-0.16	-0.14	-0.10	0.29	58							

The results marked *, i.e. those which relate to apparatus bearing well-known British trade-marks, are very satisfactory. Of the twenty pieces of apparatus thus marked only five have capacity errors in excess of the Class B limits, and of these four have errors but slightly in excess of the Class B limits, the only really unsatisfactory piece of apparatus being the 10 c.c. pipette in error by +0.065 c.c.

The results for the German apparatus clearly show that such apparatus cannot be accepted on trust, as many users appear to imagine. For example, the 50 c.c. German pipettes include a number which have excessive errors and delivery times so short as to render them likely to give inconsistent results. The ordinary grade German apparatus has no claim to superior accuracy as compared with ordinary grade British apparatus.

The results obtained indicate that where accuracy is of importance apparatus should be tested before use, and that in cases where untested apparatus is to be used the safest procedure is to obtain apparatus bearing the trade-mark of British firms which make a feature of supplying apparatus marked by the National Physical Laboratory. Their experience in the manufacture of such apparatus is clearly reflected in the increased accuracy of their ordinary output as compared with apparatus not bearing their trade-marks.

J. E. PETAVEL,
Director.

The National Physical Laboratory, April 16.

Young's Interference Experiment.

IN connection with Dr. Houston's letter on this subject in NATURE of April 28, I may direct attention to a note by my father "On a Simple Interference Arrangement" (British Association Report, pp. 703-4, 1893; Collected Works, vol. iv., p. 76). The arrangement described is a tube with a single slit at one end and a double slit at the other. The double slit is ruled on silvered glass, and is much closer than Dr. Houston describes—about $1/10$ mm., as nearly as I can estimate without pulling the apparatus to pieces. The slit at the other end is about 0.35 mm., and the length of the tube about 31 cm. The apparatus as originally described was intended to be used with the double slit placed close to the eye and the tube directed to a source of light such as a gas flame or the sky. Interference bands are then seen.

About two years before my father's death I remember asking him whether he had ever seen Young's

experiment tried. He replied in the negative, and suggested trying it. It was during a vacation, and I had leisure to do so. In looking round for the necessary appliances it occurred to me that the "simple interference arrangement" was just what was wanted. I placed it in a hole in the shutter of a dark room, with a heliostat outside, so that the single slit was backed by the reflected image of the sun. No lenses were used. The interference bands were then admirably seen on a card held, so far as I remember, 2 ft. or 3 ft. away from the double slit. My father remarked that he did not remember to have seen interference bands projected so well before with any arrangement.

It will be noticed that this use of the apparatus is not materially different in principle from the original subjective use. To pass from the one arrangement to the other we have only to substitute the card screen for the retina and to increase the focal length of the lens of the eye without limit, at the same time removing the screen to a great distance.

RAYLEIGH.

Terling Place, Witham, Essex, April 29.

An Addition to the British Fauna (*Rhynchodemus Scharffi*).

ONE of my students, Mr. G. D. Morison, has brought me a very interesting Planarian worm which he found this morning under rotten wood in a coal-shed in a garden at Chiswick. This is the fourth specimen which he has found in the same place, where they were associated with slugs, upon which they may have been feeding. The other three specimens were found a week ago. A living specimen was measured up to 6 cm. in length when crawling. In this condition the worm is very slender; when contracted it is naturally a good deal thicker and exhibits a transverse wrinkling. The colour in life is usually bright yellow, without pattern, but with a dusky anterior tip bearing the two small eyes close to the extremity. Mr. Morison tells me, however, that one specimen was salmon-pink.

The specimen submitted to me (alive) agrees very closely with von Graff's description and figures of his *Rhynchodemus Scharffi*, and I have no hesitation in identifying it with that species, which was first discovered in 1894 in a Dublin garden, and has not, so far as I am aware, been recorded since. Von Graff at first supposed that the species had been introduced from the tropics, but afterwards adopted Dr. Scharff's view that it is indigenous to Ireland. It is hard to

say which of the two views is supported by the discovery of the same species in London. Mr. Morison assures me that no plants have been introduced into his garden for at least three years. Probably the worm will be found in other parts of London, and it would be worth while to search carefully for it at Kew.

It will be remembered that another land Planarian, *Placocephalus (Bipalium) kewense*, was first found at Kew and is admittedly exotic, having since been found in many parts of the world, especially in the neighbourhood of botanic gardens, being distributed, doubtless, with plants. There is, however, one undoubtedly indigenous British land Planarian, *Rhynchodemus terrestris*, which differs from *R. Scharffi* in its grey colour and much smaller size. This worm is rarely met with unless carefully searched for, and it is quite possible that *R. Scharffi* also will yet be found in situations less open to suspicion than Dublin and London gardens. I hope that the publication of this letter may lead to such a discovery.

ARTHUR DENDY.

Zoological Department, University of London
(King's College), April 28.

Method of Cutting Sections of Cotton Hairs.

No satisfactory method of cutting sections of cotton hairs and similar material appears to have been published; the technique recommended by Balls ("Development and Properties of Raw Cotton," p. 176) is open to the objection that the hairs pull away from the wax at the cutting surface, thus losing the rigidity which is essential for good sections, and attempts made to remedy this by coating the hairs with a paraffin-wax different from that of the main embedding mass did not produce any marked increase in adhesion; while embedding in celloidin or cellulose acetate gave very unsatisfactory results by reason of the contraction and distortion of the hairs.

The method finally evolved was modified from that of Breckner (*Z. f. Wiss. Mikr.*, vol. xxv., p. 29, 1909), and is dependent on the use of a coating of celloidin to procure greater adhesion to the wax embedding mass. The cotton, fixed in a small wire frame for greater convenience, is "wetted out" with absolute alcohol and placed in a dilute syrupy solution of celloidin in alcohol-ether, which is allowed to evaporate to half or a third of its volume. The material is then taken out, squeezed between the fingers to remove excess of fluid, and placed in a chloroform solution of paraffin-wax for two hours, after which the cotton is cut from the frame, transferred to paraffin, and quickly embedded. Sections should be cut without delay, as the material appreciably toughens within twenty-four hours, but blocks can be stored in water for an indefinite time if a trace of antiseptic be added.

Cutting should preferably be done on a sliding microtome, but 5μ sections have been made without difficulty on a Leitz "Minot," with the knife oblique. A useful way of dealing with the sections when cut is to dissolve away the wax and celloidin in alcohol-ether and centrifuge. If the sections are thin enough a very large proportion will be the right way up when spread upon the slide.

Since this letter was written a description of a method for embedding cotton yarns and fabrics has been published in the *Journal of the Textile Institute* (April, 1921) by Willows and Alexander. Opportunity has not so far arisen for comparative tests of the two techniques.

H. J. DENHAM.

Botanical Laboratory, British Cotton Industry
Research Association, Shirley Institute,
Didsbury, April 20.

NO. 2688, VOL. 107]

An Unknown Organism in Flint.

A PIT dug in my garden here exposed about 12 ft. of the usual Thames Valley gravels and sands, at which depth (approximately) what local excavators call "shingle" was reached. This is composed chiefly of flint-stones mixed with sand, and lacks the binding properties of the gravel above. The rule is to stop digging for gravel when the "shingle" appears.

Pending a detailed description which will be given elsewhere, I may say that the gravels consist of various types of flint and different kinds of sandstones, together with quartzites, vein quartz, Lydian stone, chert with spicules, fragments of sarsen, etc., some of these being of sufficient interest to warrant the cutting of micro-sections. During the last few years some hundreds of these stones have been washed and examined by the platyscopic lens and microscope for surface features.

On one of the flint fragments I discovered a minute fossil organism resembling some form of insect, the like of which, so far as I can ascertain, has not been seen in flint before. There is a head with curious projections on either side, club-shaped antennæ which



FIG. 1.—Photomicrograph of an apparent organism in flint. Magnification, about 30 diameters.

are segmented, a thorax, and an abdomen, but no legs are visible.

The chitinous parts appear to be silicified, and show up well when moistened under a low power, but there are reasons why it is a very difficult object to photograph satisfactorily in the ordinary way. The one I enclose was kindly taken for me by Mr. A. Cornell with a super-microscope, the magnification being about 30 diameters (Fig. 1).

It is difficult to understand how an organism of such delicate structure could have been preserved in flint unless its entombment occurred while the flint was in a colloid condition. If any reader of *NATURE* can say what the organism is, I shall feel grateful.

C. CARUS-WILSON.

Strawberry Hill, Middlesex

Ocean Tides.

WHILE not considering myself qualified to question the gain to scientific knowledge on the theoretical side which might accrue from the investigation of ocean tides, such as Prof. Proudman suggested in his article in *NATURE* of April 7, p. 176, I yet venture the opinion

that for practical, utilitarian purposes co-ordinated study of the tidal phenomena at coastal observatories would be of greater value. The official predictions, based on extended local observations, attain such a remarkable degree of accuracy that the error is, in what we may term by courtesy normal weather, negligible. The trouble is that it is the unexpected, in the form of wind and barometrical change at critical times, that happens, and we have no formulæ at hand with which to apply corrections to predictions.

The question is: If, by study and observation, it should prove possible to discover such formulæ, could we communicate the results to those concerned on incoming ships and in harbour in time to be of service? So far as the effect of barometer gradients is concerned the answer will probably be "Yes, with wireless telegraphy at our command." But the wind factor is a different matter, its influence being dependent upon the change in direction and velocity *relative* to the time of high water within the area of influence.

While barometric pressure will be effective to the same extent at any point of the water surface of the globe, I think it may safely be asserted that the influence of the wind on the primary ocean tides will be negligible as compared with its effect on coastal tides, enormously as they are increased by comparison, and converted into currents by land resistance and by the opposing head of outflowing rivers, often enhanced by rainfall—another factor to be considered.

The lack of encouragement of scientific investigation in this particular department of science is most striking.

A. C. TENNANT.

I AM indebted to the Editor for permission to comment on Mr. Tennant's letter. It does not call into question any of the statements of my article, for I did not deny the great importance at the present time of a study of the tidal phenomena at coastal observatories. As a matter of fact, practically all the resources of this institute are at present devoted to this kind of study.

As regards the prediction of coastal tides, I may say, by way of example, that for Liverpool the discrepancies between observation and official prediction of high water possess an oscillation which reaches a foot in range. The prediction-error of any high water differs, as a rule, much more from that of the next high water than it does from that of the next but one. Further, when the complete tide is predicted from the results of all the analyses that have been made, there is a discrepancy with observation which possesses semi-diurnal and quarter-diurnal oscillations often exceeding a foot in range. The periodicity of these discrepancies indicates an astronomical origin, but as they are of a very complicated nature and are superposed on the irregular weather-effects, it is often impossible at present to say exactly how much of any discrepancy is due to departure from "normal weather." Herein lies one of the difficulties of studying the weather-effects.

J. PROUDMAN.

Tidal Institute, Liverpool.

The Physical Continuity of "Space."

THE turn which the letter of Dr. Jeffreys (*NATURE*, April 28) has given to the "'space' or 'æther'?" controversy may easily obscure the real point at issue. The clear import of my letters of April 7 and 21, and, I think also, of Prof. Eddington's forceful appreciation of the questions involved (April 14), is that the physical universe—at bottom a universe of energy—must in some form or other be continuously extensive,

and cannot be discrete. The metaphysical necessity is that something physical must *constitute* interstellar "space." The contention is not primarily one of defending the electro-magnetic æther, or any other specific æther, but of providing for extension throughout the universe. If those who doubt or deny the existence of a connecting medium in any sense hitherto understood, can show that light, electricity, gravitation, or any other manifestation of energy themselves constitute the regions of interstellar, or interplanetary, "space" in such a way that extension is always preserved, then I, for one, am perfectly satisfied. But let them not be responsible for language, or omissions of language, that inevitably lead to the implication of "emptiness" in a universe of transferable energy. It is when the outstanding question of paramount interest from the points of view of both physics and metaphysics, namely, "Of what does interstellar 'space' consist?" is ignored that the situation becomes intolerable.

Dr. Jeffreys will agree that if relativity has indicated anything clearly it is that no rigid line of demarcation can be drawn between the provinces of physics and metaphysics. As Prof. Eddington indicated very clearly in his letter of April 14, in the last resort we are driven back on a theory of extension; and it is surely incumbent upon those who say that the mechanics of the universe can be explained without a physical æther to show how the conception of "empty space" as an entity in Nature, which not only amounts to a contradiction in terms, but is also entirely discountenanced by the theory of relativity itself, can be avoided.

It should be observed that I assume the ultimate entity in the universe to be energy—that physical power which, in effecting changes on a background of extension, introduces the idea of motion, and hence of velocity and time. And since inertia is now known to be a property of energy, the ground is actually prepared for those who shout "Away with the æther!" to save an awkward situation by representing the whole of this universe of energy in a theory of extension.

L. C. W. BONACINA.

May 1.

Logs and Antilogs.

ON p. 7 of *NATURE* of March 3 a recommendation is mentioned that when taking out the number corresponding to a logarithm a table of antilogs should be used. Assuming the usual seven-figure work, the opposite course should be followed, because the computer can then write down five figures at once and add the remaining two by means of the difference table; no addition or crossing out is required. Thus for the logarithm 0.1234567 the log table gives 1.3287 for 1234269, and 298 in the 327 difference table gives 91, so we write 1328791. *Vice versa*, having 1.328791, what is the logarithm? The anti-table gives 12345 at once, whilst the difference 20 gives 67, so that we write 1234567. No figure requires alteration and the work is done with a minimum of mental strain.

As one who does a great deal of computation, let me state that my order of preference for usual work is Cotsworth's multiplication table (which is better than Crelle's), then the Triumphant or Brunsviga calculating machine, then Shortrede's table, which in one volume gives both logs and antilogs; but special tables can also be usefully employed. Thus Bottomley for all four-figure work is still the best; for multiplying two figures by four, Peters's table; and for two figures by three, Zimmermann's.

Amongst the indispensable tables should be included Zech's addition and subtraction log table, which is easy to use and accurate. For eight-figure work the best, if not the only, tables are Bauschinger's and Peters's.

R. T. A. I.

Johannesburg, April 4.

The Colour of Primrose Flowers.

NATURE of April 1, 1920, p. 139, published an interesting article on the colouring matters of plants. From this article it would appear that the normal pale yellow colour of the primrose is due to a yellow sap pigment, a derivative of flavone. Primroses, however, are found with a range in colour from deep red to almost white. Can any of your readers say to what this variation from the normal is due, and whether the colours are anthocyanins?

Much attention has recently been directed in the local Press to this variation in colour, and many attempts made to account for it. It is common in parts of Pembrokeshire, but is usually confined to a particular bank or field in the district.

It is said to occur only in the Coal Measures, and is probably due to the presence of iron in the soil or to insect action causing a cross with polyanthus. It is even stated that to plant a normal primrose upside down causes a red coloration.

A possible theory may be the cross from polyanthus, but it is generally agreed that but one insect affects primroses, called sometimes a "primrose sprite," resembling a bumble-bee, but with a long, characteristic proboscis. The late Lord Avebury in "British Flowering Plants" suggests a moth.

These variations are, however, found remote from cultivation, and I have not been able to ascertain a single instance of a red primrose in a cultivated garden unless planted there from a hedge-bank, when it attains an even deeper red, and often develops the umbel of the polyanthus.

R. O. LATHAM.

Pembrokeshire, April 12.

In reply to Major Latham's inquiry, I may say that in the red primroses which I have examined the colour is undoubtedly due to an anthocyan pigment. Pale yellow or white primroses contain no anthocyan. Flavonols rarely give rise to much colour, and do so only when present as salts (phenolates) of metals. Even in primroses there is often a very small amount of a yellow plastid pigment present which produces proportionately far greater colour effect than the flavonol derivatives that exist in the sap. The conversion of the yellow sap pigments (flavonols) to anthocyanins is a process of reduction. Exactly what causes such a change to take place in plant-life is not yet fully determined, but the work of Prof. Keeble and of Miss Wheldale has done much towards elucidating this matter. When, as I boy, I tried the method of planting primroses upside down to get red or variegated varieties (the country folk in the district believed that this method was effective), it was never a success. In general, it would appear that new colour varieties in flowers are most frequently produced as a result of crossing. Seeds of red or white varieties of primrose are offered by some seedsmen.

THE WRITER OF THE ARTICLE.

The Resonance Theory of Hearing.

In the absence of a reply to Dr. Hartridge (NATURE, April 14, p. 204) from a more authoritative quarter, I venture to suggest that his expression "a con-

NO. 2688, VOL. 107]

tinuous musical note" is not appropriate to the phenomenon discussed. By changing the time-interval between successive siren-puffs from τ to $\frac{3}{2}\tau$, the experimenter interrupts the periodicity of the vibrations producing the fundamental tone of his note, and the consequent discontinuity in the note is perceived by his ear as something indistinguishable from a beat (which, physically, it is not). According to the "dead beat" view, this effect in the sensorium is due to the last vibration of the interrupted series, because there is no resonator in the cochlea which by continuing to vibrate would make the temporary interruption imperceptible. If the interruption-effect were lacking when the resumed vibrations are not of precisely opposite phase, there would be something in Dr. Hartridge's argument.

Though at present reluctant to contribute further to what Prof. McKendrick has called an interminable discussion, I hope that the *lioretgraphe* which Mr. Daniel Jones is shortly to install in the phonetics laboratory in this college will bring a termination within view.

W. PERRETT.

University College, Gower Street,
London, W.C.1, April 28.

Biological Terminology.

I DO not wish to be drawn into the whirlwind of controversy raised by Sir Archdall Reid; only from a respectful distance would I protest against his *obiter dictum* that "systematic zoology and botany are purely descriptive" as opposed to "interpretative science." Every specific name is of itself an interpretation; "*Equus asinus*" is a statement that the creature is closely akin to "*Equus caballus*." The classification of any group, and still more the classification of a whole kingdom, contains a long chain of interpretations. Modern systematic work—with which Sir Archdall Reid must surely be ill acquainted—deals at every step with "problems of heredity, evolution, development, and the like." There may still be a few people who confine their energies to pure description of the objects in front of them; but why call them systematic zoologists or botanists?

F. A. BATHER.

Experimental Geometry.

DR. JEFFREYS (NATURE, April 28, p. 267) claims that "experimental geometry" is a contradiction in terms. I protest vehemently. "Geometry" means the measurement of the earth. How can you measure the earth without experiment? It is "logical geometry" that is the contradiction in terms; it is that expression which has introduced all this confusion between logic and experiment; and it is the mathematicians, not the experimenters, who have stolen the word and perverted it from its proper meaning.

NORMAN R. CAMPBELL.

19 Holland Park, W.11.

Italian Meteorites.

AS reference was made in NATURE of March 31 (p. 149) to records of Italian aerolites, it may be noted that there were fourteen falls of stones or earth in central Italy recorded in forty years from 208-168 B.C. It appears that the earth was then passing through a region of aerolites. The references in Livy are under the years A.U.C. 545, 548, 550, 558, 559, 561, 564, 567, 575, 579, 580, 583, 584, and 585.

W. M. F. PETRIE.

5 Cannon Place, N.W.3.

The Centenary of Napoleon.

By ENG.-COMDR. EDGAR C. SMITH, O.B.E., R.N.

THE death of Napoleon occurred one hundred years ago to-day, and the celebration of his centenary now taking place in France will doubtless include some recognition of the encouragement and patronage given by Napoleon to scientific discovery and mechanical invention. Many rulers have availed themselves of the services of mathematicians at their courts, and not a few learned societies owe their existence to the support of kings and princes. An Academy of Sciences at St. Petersburg was the dream of Peter the Great; the golden era of the Prussian Academy was the reign of Frederick the Great. Napoleon, as keen in his appreciation of the value of science as either Peter or Frederick, had not, like them, to seek abroad for men of talent. More than fortunate in this respect, his accession to power coincided with the rise of such institutions as the Ecole Polytechnique, the Ecole Normale, and the Institut de France, and he found among his contemporaries astronomers, physicists, chemists, and naturalists of the highest rank. Distinguished at school for his mathematical ability, he became a member of the Institute, attended altogether thirty-eight of its sittings, rearranged the various classes, and designed the uniform of its members. It was he who housed the Institute in the Palais des Quatre Nations. During the Egyptian campaign he was wont to sign his proclamations "Member of the Institute, General-in-Chief of the Army of the East."

Among the favourite associates of Napoleon at this time were the savants Monge and Berthollet. It was Monge who carried the Treaty of Campo Formio back to France, and he and Berthollet were among the spoilers detailed to rob the Italian museums and galleries. During the winter of 1797-98 Napoleon attended Berthollet's lectures on chemistry, and it was probably Berthollet's suggestion that a body of savants should accompany the Egyptian expedition. When the fleet left Toulon in May, 1798, besides his generals and secretaries, Napoleon had in his suite two astronomers, four geometers, a geologist, a chemist, three naturalists, and six civil engineers. On the voyage, tired of discussions on religion, government, and strategy, he would raise such questions as whether the planets were inhabited; how old was the earth; would the earth be destroyed by fire or water?

Upon arriving in Egypt Napoleon at once set his corps of savants to work. Undaunted by the destruction of the French fleet by Nelson on August 1, 1798, three weeks later, at Cairo, he inaugurated, with considerable ceremony, the short-lived Institute of Egypt. Monge was president, Fourier, the mathematician, secretary, and Napoleon vice-president. The members were employed on geodetic operations, astronomical work, the study of the Nile, the improvement of crops, and the manufacture of munitions. When the victories of Desaix threw open the middle reaches of the

Nile, the artists and engineers of the Western world gazed for the first time upon the wonders of Memphis. Many of the portable relics transferred first to Cairo and then to Alexandria now rest in the British Museum. Our possession of the Rosetta stone dates from about this time. The story of the geologist Dolomieu rightly belongs to the Egyptian campaign. Having suffered the hardships of war, he sailed for home, only to be shipwrecked, and then imprisoned by the King of Naples. Bearing his confinement with philosophic resignation, he continued to write his memoirs on the margins of books. Sir Joseph Banks was foremost among those who tried to secure his release, but it was Napoleon's insertion of a special clause in the treaty after Marengo that gained Dolomieu his liberty.

During the Consulate and Empire Napoleon gave many proofs of his interest in the progress of science, but no discovery raised his enthusiasm higher than did Volta's. The invention of the pile had been made known by Volta's letters to Banks. No sooner did Napoleon hear of it than he called the famous physicist to Paris, attended a special sitting of the Institute, and caused a gold medal to be struck bearing the inscription "A Volta, séance du 11. Frimaire, An ix." He afterwards made Volta a senator and a count, gave him a sum of money, and presented him with a sword of honour. The sword and a picture of Volta explaining his battery to Napoleon were among the relics saved from the disastrous fire at the Volta Centenary Exhibition at Como in 1899. The First Consul further showed his interest by founding a prize of 3000 francs "for the best experiment which shall be made in the course of each year on the galvanic fluid." The acceptance of this prize by Davy in 1808 for his discovery of sodium and potassium roused a good deal of feeling in this country, some folk going so far as to consider Davy almost a traitor. Much the same experience had befallen Banks, when, with Sir W. Herschel, Cavendish, Maskelyne, and Priestley, he had been elected one of the first foreign associates of the Institute.

Another scientific investigator who gained the ear of Napoleon was Chladni, the founder of the science of acoustics. Chladni, who had spent some years travelling and lecturing, arrived in Paris in 1808. The Emperor, struck with the importance of his discoveries, called for a report from his French savants, and afterwards gave 6000 francs for the translation of Chladni's treatise. Whether it was in the domain of astronomy, of chemistry, or of physiology, Napoleon seldom failed to show his respect for work of more than usual merit. His interest in the anatomical models of Fontana, in the mathematical work of Mascheroni, and in the discoveries of Spallanzani, and his encouragement of researches on indigo and beetroot, are a few instances which

illustrate this point. To them might be added his admiration for Jenner. It was Napoleon who placed a memorial in one of the wards of the Hôtel-Dieu to the memory of Dessault and Bichat.

Industrial progress and efficiency no less than scientific discovery appealed to Napoleon. Jacquard's loom of 1801 at first brought little but opposition and trouble to the inventor, the Industrial Council of Lyons even passing a formal condemnation of the loom. His ingenuity being remarked by Carnot and then by Napoleon, Jacquard was for a time employed in the Conservatoire des Arts et Métiers, and by a decree dated at Berlin, October 27, 1806, Napoleon gave him a pension of 6000 francs and a premium of 50 francs for each loom erected. In 1810 the Emperor offered a reward of a million francs to the inventor who should first bring into successful operation a method of spinning flax by machinery. The problem was solved by the distinguished mechanic and practical chemist Philippe de Girard, to whom France was indebted for successful work in various directions. Girard, however, died in 1845 without receiving the reward, though his descendants were recompensed.

The great public works initiated by Napoleon were as remarkable as his educational schemes. For the improvement of harbours and rivers, and for the construction of bridges, canals, and roads, he found in the Corps des Ponts et Chaussées, established in 1747, a body of technically trained public servants such as no other country in the world then possessed. The canals connected with the Rhine and Rhône, the Saône, the Seine, the Ourcq, and the Oise; the works at Dunkirk, Havre, Dieppe, Honfleur, and Brest; and the breakwater at Cherbourg, were all carried out by this famous corps, the records of which are enriched with the names of Perronet, Girard, Gauthey, Navier, and Prony. At Malmaison one day Napoleon said to Chaptal: "I intend to make Paris the most beautiful capital in the world. . . . What are your plans for giving water to Paris?" Chaptal gave the alternatives—artesian wells or bringing the water from the River Ourcq. "I adopt the latter plan; go home and order five hundred men to set to work to-morrow at La Villette to dig the canal." "Such," says Dr. Holland Rose, "was the inception of a great public work which cost more than half a million sterling."

The many men of science upon whom Napoleon

bestowed honours were scarcely more numerous than those he employed in positions of trust. The story of Laplace as Minister of the Interior is well known. Given the post at his own request, six weeks later he was removed because he carried into the art of government the principles of the infinitesimal calculus. Sixteen years before this Laplace had been young Bonaparte's examiner at his entrance into the army. Guyton de Morveau, Cuvier, Fourcroy, Chaptal, and Lacépède were among those who held public offices. Lacépède was for some time President of the Senate. With Laplace he was not unlike the Vicar of Bray, and found no difficulty in agreeing with any Government—revolutionary, republican, monarchical, or imperial. It may be it was of him Napoleon was thinking when one day he bitterly remarked: "Men deserve the contempt with which they inspire me. I have only to put some gold lace on the coat of my virtuous republicans and they immediately become just what I wish them."

Of a different stamp were Cuvier and Chaptal. Cuvier, whose reputation as a naturalist and organising ability as secretary to the Institute could not fail to attract Napoleon's attention, was appointed one of the six inspectors to establish lycées in the principal towns. He afterwards did valuable work in the reorganisation of some of the European universities. Among all the public men Napoleon drew from the world of science, however, none stood higher in general esteem than Chaptal. Released from prison during the Revolution to superintend the manufacture of gunpowder, the rise of Napoleon opened for him a career of great public usefulness. Succeeding Lucien Bonaparte as Minister of the Interior, he founded trade schools, encouraged arts and manufactures, and assisted the Chambers of Commerce. Though his loyalty to Napoleon led to his being deprived of his peerage at the Restoration, he continued to devote his vast knowledge and great talents to the service of France, showing always that consistency, moderation, and desire for the common good for which he had been conspicuous under the régime of Napoleon.

"The true conquests, the only conquests which cost no regrets, are those achieved over ignorance," Napoleon once said. Such are the conquests of science, and no results of Napoleon's life's work are more enduring or beneficent than those due to his encouragement of scientific education and scientific discovery and to his promotion of great public works.

The Annular Eclipse of April 8.

By MAJOR W. J. S. LOCKYER.

THE best positions to observe the annular eclipse of the sun on April 8 were to the extreme north-west of Scotland, and it was the intention of Lt.-Col. F. K. McClean and myself to take up a station somewhere in that part. Owing to the miners' stoppage Col. McClean was

unable to take the journey, but in London I succeeded in finding two volunteers in Mr. Patrick Alexander and Mr. Allan Young, and we started off for Durness (Sutherland), near the entrance to Loch Eriboll, on the evening of April 5. Reaching Lairg the following afternoon,

we heard that the inn at Durness had been burnt down several years previously, so we proceeded by motor-car along the beautiful side of Loch Shin, and arrived at a place called Rhiconich, at the southernmost end of Loch Inchar. Finding that the hills around were not sufficiently high to obstruct the view of the annular eclipse, we decided to stay at the excellent hotel there for the event.

We took with us two instruments—one a whole-plate camera fitted with a telephoto lens, and the



FIG. 1.—Our instruments in the ground adjoining the Rhiconich Hotel. Photograph taken during the first partial phase.

other a small Thorpe grating slit spectroscope fitted up for taking photographs of the spectra of the limbs where they grazed each other. The spectroscopic part consisted of a box to act as a collimator tube, fitted with a 1-in. slit at one end, and a Dallmeyer rapid rectilinear lens at the other. The camera part was also a box arranged to take plate-holders 5 in. by 4 in. at one end, and a Dallmeyer rapid rectilinear lens fitted with a Thorpe grating in front of it. The latter box was placed obliquely with regard to the collimator box, and so adjusted that both the first- and second-order spectra fell on the photographic plate. This spectroscopic arrangement was fitted on a long, stiff plank, made in two sections for the sake of portability, and at the other end were fitted two guides to which was screwed the small framework for carrying a $3\frac{3}{4}$ -in. objective.

Arrangements were made for propping up this plank in the direction of the sun so that the solar image fell on the slit of the collimator. A screw adjustment was adapted for raising the plank as the sun increased its altitude. The whole of this

NO. 2688, VOL. 107]

outfit can be seen in Fig. 1, as it was in position on the ground outside the Rhiconich Hotel during the first phases of the eclipse. The whole-plate camera can also be seen a little further away.

I had to work the instrument completely by myself; but if I had had some skilled assistance I should have obtained more spectra of the chromosphere. The difficulty was to get the right portions of the crescent exactly on the slit, and then to draw the dark slide and make the exposure, the sun moving all the time across the slit.

The only photograph of the chromosphere is that shown in Fig. 2. This is an enlargement from the first order of one of the spectra, and shows amongst others the bright hydrogen and calcium lines. Each plate exposed gave four spectra—two in each order and two at each limb (upper and lower) of the sun.

Fig. 3 shows one of the numerous photographs taken with the whole-plate camera by Mr. Allan Young. It was exposed a little before the time of mid-annularity. The eclipse took place under nearly perfect conditions, but there must have been some very high cirrus haze, because during the first partial phases a halo became visible round the sun. This became brighter as the eclipse progressed, and showed the spectrum

colours distinctly. At two points of this halo, about east and west, mock suns were seen, and these extended right and left and formed practically two spectra lying horizontally, the colours being very distinct. These phenomena were observed by all those who gathered round our camp.

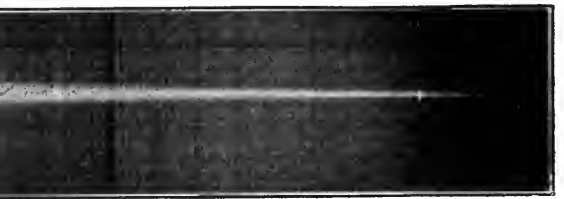

FIG. 2.—The spectrum of the chromosphere, showing, amongst other bright lines, the lines of hydrogen and calcium.

With regard to the visibility of the planets and

stars, though I showed everyone a map of the positions of possible visible objects, no one re-

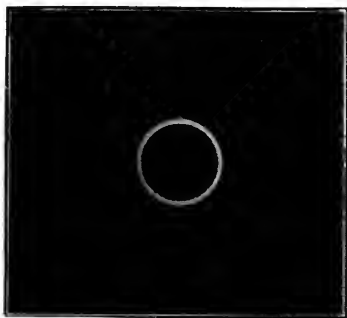

FIG 3—The eclipse just before the mid-phase of annularity.

corded the appearance of any. At Sidmouth I have been able to see Venus easily in the day-

time by looking along a telescope which was pointing to its position in the sky, but I could not pick it up without such help. During the eclipse I looked specially for it, but failed to see it; this may have been due to the haze referred to above. While we had no thermometer to record the temperature, the chilliness was so pronounced that everyone noticed it; further, there was no wind during the first phases, but before annularity was reached there was a distinct breeze blowing, which died away before the later phases ended.

It may be added in conclusion that this annular eclipse was not nearly so striking as that which I observed from the outskirts of Paris in April, 1912, when the moon at the greatest phase of annularity almost, but not completely, covered the sun, making the bright ring appear like a circle of irregularly placed pearls.

The Royal Academy.

SCIENCE and engineering have become closely allied, and it is therefore of interest to note the prominence given in this year's Academy to engineering subjects; in many cases, not merely engineering features as an incident in a landscape or in a pictorial setting, but the work of the engineer shown for its own sake. Thus amongst unexpected subjects we find the interior of a garage with parts of a dissected motor-car in the foreground (262), and a bridge under construction (84). Of the same type is 654, showing railway sidings and factory chimneys with, it is true, cathedral towers in the background scarcely discernible through the smoke. The scientific basis of engineering is not far from the surface in "The Ages Meet" (156), where Mr. Stanhope Forbes shows the welding together of tramway rails by the oxy-acetylene process. The setting of the picture is the Embankment at the foot of Cleopatra's Needle. It was a happy idea of the artist to bring into juxtaposition the two human achievements—the modern welding of the steel rails in the tramway track, and the great stone column of antiquity. The task of raising this to a vertical position with the primitive devices available in those days must have been a feat in comparison with which our modern building operations, with their electric cranes and other labour-saving devices, appear but child's-play. As industrial engineering is given such prominence in this year's exhibition, it will be but one further step forward, one is tempted to think, for the laboratories of scientific workers and their cherished apparatus to be accepted as fit subjects for the work of future exhibitors at Burlington House.

This day has not yet come, and the scientific critic has for the present to confine his attention to the many aspects of Nature which are set forth from year to year in such countless profusion. The proportion of landscape scenes and Nature-studies which are really true to life seems ever to

remain a small one, and leads to speculation as to whether the cause lies in a lack of desire or a lack of power on the part of artists to give expression to the truth. There is, and probably always will be, a school which frankly cares not for the accurate representation of Nature; but there are other artists who seem to aim at reality without achieving their object, and the failure is more marked in some directions than in others. Thus the post-impressionist dog and the post-impressionist cloud may be equally obviously unreal; but in the other school the artist who sets out to paint a dog is apparently more likely to succeed than the artist who takes clouds for his theme. Such is the conclusion reached from an inspection of the exhibits at the Academy. Miss Hordern's miniature of a terrier (Bailey, 741) is excellent; so is the more ambitious painting by Edmond Brock (259); but "Rolling Clouds" (616) as an attempt at a cloud study is a failure, both in the colouring and in the form of the clouds. J. Farquharson, who is always at home in snow scenes, gives in 93 a delightful picture with snow on the ground and slanting sunshine among the pines which leaves open only one point for criticism. The moon, though apparently full, is above the horizon at the same time as the sun. The eye is not very sensitive to determining the fullness of the moon, and perhaps this would be the author's explanation, though it seems unnecessary so carefully to direct attention to the point by means of the title, "The Moon is up and yet it is not Night."

If Julius Olsson could refrain from such a free use of brilliant colours in strong contrast with one another his seascapes would be immensely improved. Several examples of these glaring colours are shown this year. There is one exception, "Silver Glitter" (458), where the artist has used more restraint with a marked improvement in effect. Mr. Mark Fisher, in his

two small works, shows something of the same defect, the skies containing a mosaic of colours; but, viewed at a distance, these blend, and the effect becomes much improved, particularly in the evening sky of 440. "The Ever Blue Pool" (276) is well named. The reflections of yellow sand dunes and of the curious red scrub growing upon them alike appear in its waters to be blue. Sand dunes are shown in several pictures, in most cases without much success, but a notable exception is found in "The Bay of Aberdovey" (309, Leader). In "Third Year Pollards" (269) Mr. Bertram Priestman has missed an opportunity of indicating the really remarkably rapid growth which occurs in the first year after a pollard willow has been cut. The trees in the picture show no great

growth for three years, and have a somewhat hard and unnatural look.

It is not to be expected that men of science will be numerously represented among the portraits in the Academy when there is so wide a choice open among civic authorities, well-known soldiers, and other men high in public esteem. Scientific visitors may this year take pleasure in noting that two fellows of the Royal Society are included amongst the portraits—that veteran man of science and professor of engineering, Dr. Unwin (242), and Sir Napier Shaw (348). Meteorologists may feel proud that their science is represented by the president of the International Meteorological Committee, than whom assuredly no better representative could be found. J. S. D.

Obituary.

MR. BERTRAM BLOUNT.

ON April 9 chemistry suffered a loss in the death of Mr. Bertram Blount at the comparatively early age of fifty-four. Never robust, his health had been poor for the past few years; he appeared to be exhausted by his successful struggle in 1915 to bring cotton within the list of contraband goods; for, wonderful as it may seem, it was no light task to convince the Government of the necessity for the step, even with such weighty aid as that of Sir William Ramsay. But of nervous energy Blount had a remarkable store; his staying-power was the admiration of those who knew him as an early cyclist, and later as a pioneer automobilist.

After a few years at King's College School, Blount entered the chemical laboratory of the college, where the foundation of his skill as an analyst was laid by the then professor, C. L. Bloxam. At the age of nineteen he accepted service as an assistant to W. H. Stanger, a consulting engineer to the Crown Agents for the Colonies. His talent did not allow him to remain a subordinate for long; Stanger's practice soon developed to include that of consulting chemist, with Blount as partner. On Stanger's death a few years later Blount continued practice on his own account,

and rapidly became a prosperous consultant, the chemistry of cement being his chief subject. His quickness in grasping the meaning of a problem and his undaunted perseverance in attacking it fitted him to be a researcher. His clients' interests, however, left him little time for investigation, so that his contributions to purely scientific literature are limited to a few papers on cement and on minor analytical problems; recently, in conjunction with J. H. Sequeira, he investigated the origin of the colour of Blue John.

Blount was an excellent writer and talker, his style being clear and incisive in both cases. His more permanent writings are "Chemistry for Engineers and Manufacturers," in conjunction with A. G. Bloxam; a "Practical Electrochemistry"; and a recent monograph on "Cement," in conjunction with W. H. Woodcock and H. J. Gillett. He also contributed the articles on cement in the "Encyclopædia Britannica" and in Thorpe's "Dictionary of Applied Chemistry."

WE regret to record the death, on April 21, at seventy-nine years of age, of DR. E. J. MILLS, F.R.S., emeritus professor of technical chemistry in the Royal Technical College, Glasgow.

Notes.

THE observatory founded in 1913 by Sir Norman Lockyer and Lt.-Col. F. K. McClean on Salcombe Hill, above Sidmouth, is henceforth to be called "The Norman Lockyer Observatory." It will thus form a memorial to the scientific pioneer who was described by Dr. Deslandres, past-president of the Paris Academy of Sciences, in our columns as "one of the greatest astronomers of all time." It is proposed to render the memorial more complete by placing in the observatory a portrait of Sir Norman Lockyer, in the shape of a medallion, to be executed by Sir Hamo Thornycroft, R.A. As there are, no doubt, many persons who will value the opportunity of joining in this tribute, the council of the Observatory Corporation has

decided not to restrict to a few friends participation in defraying the cost of the medallion, but to invite contributions of any amount from all who may wish to express appreciation of Sir Norman's astronomical work. Names of donors will be recorded in a suitable manner in the observatory. Contributions towards the cost of the medallion should be sent to the hon. secretary of the Observatory Corporation, Capt. W. N. McClean, 1 Onslow Gardens, London, S.W.7.

THE Institute of Chemistry has just issued by order of the council a memorandum prepared by the Special Purposes Committee on Fine Chemicals, Laboratory

Glass and Porcelain. With regard to the production of chemical reagents the council states that a great advance has been made during the war and since by our manufacturers, and this has already enabled professional chemists to obtain practically the whole of the reagent chemicals necessary for their work. Many instances have proved that British manufacturers are capable of producing chemicals in a state of purity fully comparable with that of pre-war supplies from abroad, and the council emphasises the importance of encouraging home production. It is not suggested that chemists should be hampered for lack of chemicals if they cannot be obtained in this country in sufficient quantity and of the right degree of purity, but the council urges that users of chemicals should make themselves acquainted with what is available as the result of the very substantial progress made by British manufacturers, and consider the ultimate effect of failing now to aid in building up a stable chemical industry in this country. In respect of glass apparatus, members of the council are aware that many complaints are made with respect to the quality and quantity of laboratory glass sold as of British origin, "but, so far as they have been able to obtain evidence at present, the complaints regarding glass of recent manufacture marked with the names of known makers have been few in number." The council repeats and emphasises the appeal recently issued by the institute to users, urging them to purchase only laboratory glassware which bears the manufacturer's distinctive marks, and it adds that "if *bona-fide* British manufacturers who are prepared to guarantee their productions by their own marks do not receive proper encouragement, the opportunity of establishing firmly the British scientific glassware industry will be lost, and this at a time when through enterprise and research success in respect of manufacture and technique has been attained."

THE *Times* announces that Sir Ernest Cassel has devoted the munificent sum of 225,000*l.* to the object of founding and endowing a hospital or sanatorium for the treatment of functional nervous disorders, and has purchased a fine mansion and park at Penshurst, Kent, for the purpose. The King and Queen have consented to become patrons of the new institution.

A NUMBER of distinguished civil, mining, metallurgical, mechanical, and electrical engineers of the United States will arrive in England near the end of next month, and will hold a joint meeting with British engineers in July. The American engineers will present Sir Robert Hadfield on June 29 with the John Fritz medal, which was awarded to him recently in recognition of his invention of manganese steel. Previous recipients of the medal have been Lord Kelvin, Mr. Edison, and Dr. Graham Bell.

A DISCUSSION on "The Structure of the Atmosphere up to Twenty Kilometres" will take place in the rooms of the Royal Astronomical Society, Burlington House, London, on Friday, May 6, at 5 p.m. The chair will be taken by Dr. G. C. Simpson. Sir Napier Shaw will open the discussion, which will be con-

tinued by Col. E. Gold, Mr. W. H. Dines, and Mr. F. J. W. Whipple.

THE President of the Board of Trade, by arrangement with the Lord President of the Council, has appointed Mr. J. E. Sears, jun., to be Deputy Warden of the Standards in succession to Major P. A. MacMahon, who has retired under the age-limit. Mr. Sears is superintendent of the metrology department at the National Physical Laboratory, and will continue to hold this post in addition to that at the Standards Department of the Board of Trade.

THE award of a Moseley studentship for research in molecular physics or some allied branch of science will shortly be made by the council of the Royal Society. The studentship is of the value of 300*l.* a year and tenable in the first instance for one year only. It may, however, be renewed for a further year if the student's work be considered satisfactory. Applications must be made to the Secretaries of the Royal Society, Burlington House, W.1, before June 1.

APPLICATIONS for two Mackinnon research studentships, each of the annual value of 150*l.*, are invited by the Royal Society. One of the studentships is for research in physical science and the other for research in biological science. The appointments are for one year, but are renewable for a further like period. In exceptional circumstances they may be extended to a third year. Full particulars and forms of application are obtainable from the Assistant Secretary of the Royal Society. The latest date for the receipt of applications is June 1.

THE Council of the Institution of Civil Engineers has made the following awards for papers read and discussed during the session 1920-21:—A Telford gold medal and a Telford premium to Mr. George Ellson (London); Telford gold medals to Sir Murdoch MacDonald (Cairo) and Dr. T. E. Stanton (Teddington); a George Stephenson gold medal to Mr. R. G. C. Batson (Teddington); a Watt gold medal to Mr. S. A. Main (Sheffield); and Telford premiums to Mr. Algernon Peake (Sydney, N.S.W.), Mr. L. H. Larmuth (London), Mr. H. E. Hurst (Cairo), Prof. T. B. Abell (Liverpool), and Mr. Percy Allan (Sydney, N.S.W.). The council further records its appreciation of the paper contributed (jointly with Mr. Main) by Sir Robert A. Hadfield, a member of the council.

IT is announced that the annual meeting of the British Medical Association will be held at Newcastle-upon-Tyne on July 15-23, under the presidency of Prof. David Drummond. On the occasion of the president's address on July 19 the gold medal of the association will be presented to Sir Dawson Williams, editor of the *British Medical Journal* since 1898, in recognition of his distinguished services to the association and the medical profession. In connection with the annual meeting in 1922 to be held at Glasgow, Sir William Macewen, Regius professor of surgery in the University of Glasgow, is announced as president-elect. The council of the association has recommended that the annual meeting in 1923 be held at Portsmouth.

FROM a recent copy of the *North China Herald* we learn with pleasure of the award by the French Government of the Cross of the Legion of Honour to Father Froc, S.J., who for more than a quarter of a century has been connected with the meteorological work at Siccawei Observatory. It was at the Jesuit observatory in Manila that Father Faura in 1879 for the first time predicted the existence, duration, and course of a typhoon in the Far East, and the work at both Manila and Siccawei has been of the greatest importance to those who sail the China seas. Siccawei, which stands about four miles from the international settlement of Shanghai, derives its name from a distinguished Chinese who was converted to the Christian faith by Matthew Ricci three hundred years ago, and whose grave lies close to the observatory. Besides the observatory the Jesuit Mission has here a fine cathedral, a college, an orphanage, a convent, and a natural history museum. The work of Father Froc and of his colleagues, Fathers Chevalier and Gauthier, has the support of the community at Shanghai, and the observatory at Siccawei and those at José and Liu-ka-pong connected with it are an object-lesson to the Chinese Government.

THE Danish explorer Mr. Knud Rasmussen is planning to leave Copenhagen on May 25 in his motor schooner *Sea King* for the Canadian Arctic Archipelago in order to continue his researches in Eskimo ethnography and migrations. Mr. Rasmussen recently laid his plans before the Royal Geographical Society of Denmark. According to the *Times*, he proposes to sail for the station of Thule, in north-western Greenland, where several Eskimo and a number of dogs will be embarked. From there he will go to Hudson Bay and establish his base at Lyon Inlet, in Melville Peninsula. During autumn and winter the tribes around Fury and Hecla Straits will be visited. In the spring of 1922 the expedition will go south to Chesterfield Inlet, where arrangements have been made with the Hudson Bay Co. to form a food depôt. The winter of 1922-23 will be spent among the Kinipetu tribes in the Barren Lands, and other tribes along Maud Sea and Dease Strait. The *Sea King* will take the collections back to Denmark in 1923, while Mr. Rasmussen with a sledge party hopes to reach Thule, travelling *via* Baffin Land, Lancaster Sound, Jones Sound, Ellesmere Sound, and Smith Sound. This journey is expected to throw light on the ancient Eskimo migrations from Bering Strait *via* Coronation Gulf and Baffin Land to Greenland. Mr. Rasmussen's companions will be Messrs. P. Freuchen, Mathiessen, and Birket-Smith.

THE Research Defence Society has issued a pamphlet entitled "The Fight against Disease" (Macmillan and Co., 6d.). The pamphlet gives a summary of important current researches on the prevention of human diseases, such as those of Nathan Raw and Calmette on immunisation against tuberculosis, an abstract of Bassett-Smith's lecture on Malta fever at the Middlesex Hospital and quotations from Sir Charters Symond's Hunterian oration on the import-

ance and value of experiments upon animals. The advantages gained by animals from experiments on animals are also emphasised, notably in the case of glanders. Prof. Hobday points out that in 1901 some 2370 horses were destroyed for glanders in Great Britain, whereas during 1920 only 22 animals were destroyed, and this after the sale and distribution of 150,000 Army horses and mules. This result is due to the use of mallein, a sure test for the presence of the disease. The extraordinary mistakes and mis-statements of anti-vivisection publications are also referred to and exposed.

THE Report of the Director-General of Public Health, New South Wales, for the year ending December 31, 1919, contains a useful summary of the influenza epidemic which raged in the State during that year. In Sydney itself it is estimated that 290,000 persons were attacked, or 36 per cent. of the population, and from January-September 6244 deaths due to influenza were recorded in the State. As in this country, males of working age had the highest death-rates, and the disease was frequently accompanied with hæmorrhages. The precautionary measures taken included restrictions upon travelling, the provision of hospital accommodation and of medical and nursing assistance in the homes of the sick, notification, isolation of patients and contacts, restriction of public assemblies and closure of schools, and the wearing of masks in certain circumstances. These measures, however, did not appear to limit the spread of infection. Inoculation was also applied to a limited extent, and the death-rate among the inoculated seemed to be decidedly reduced. Extensive bacteriological and pathological investigations were carried out by Dr. Cleland, who thinks that the balance of evidence is in favour of the disease being caused by a filter-passing organism, although no definite experimental evidence in favour of this view was obtained.

THE Natural History Society of Rugby School has recently issued its annual report for 1920, which we note is the fifty-fourth issue of this record. In all, nine general lectures were given during the year on a variety of subjects; brief abstracts of each are printed, and if we are to judge by the attendances recorded, that by Dr. Fournier d'Albe on the optophone was by far the most popular. The report also contains a list of birds of Rugby by Mr. J. F. Madden, compiled chiefly from the society's reports of the last six years; one hundred birds are mentioned, and remarks are added indicating where and how often each has been seen. The botanical section has contributed a list of some three hundred plants which have been found locally, and their dates of flowering are given. The entomological and the ornithological sections also supply lists which will be useful to students of local natural history, while the contribution of the latter is illustrated by some good reproductions from photographs of birds' nests and young sparrowhawks. Other groups, such as the geological, meteorological, photographic, and agricultural sections, have also provided brief reports of their activi-

ties, making altogether an attractive record of a year's endeavour in the field of natural history. A new feature upon which the society is to be congratulated is the opening of a laboratory in which members can carry out a certain amount of independent work.

MRS. MABEL C. WRIGHT describes a new conchostracan genus under the name *Limnesteria* from the Coal Measures of Kilkenny, which have been fertile in interesting fossil forms, ranging from limuloids to amphibia (Proc. Roy. Irish Acad., vol. xxxv., sect. B, p. 187, 1920). The specimens, including antennæ and limbs, are beautifully preserved in pyrite in Carboniferous shale, and were received by the Geological Survey of Ireland from a depth of 830 ft. in the cores of a recent boring. The author concisely reviews the eight known living genera of Conchostraca, and shows how *Limnesteria*, on the analogy of the highly fertile *Limnadia*, illustrates the geographic and climatic conditions of the epoch in the Leinster coalfield.

ENTOMOLOGICAL Bulletin No. 872 of the U.S. Department of Agriculture deals with "Insect Control in Flour Mills." Mr. E. A. Back, the author of the publication, confines his attention to the Mediterranean flour-moth, which is by far the most serious pest. He divides control measures into three classes: Preventive, including attention to cleanliness; natural control by means of parasites; and artificial control. A large proportion of insect infestation in flour-mills is directly due to lack of cleanliness, and much may be achieved by thorough cleaning once every five weeks throughout the summer months. The utilisation of parasites cannot be depended upon in any part of the United States. Artificial control has been advocated along various lines, and there have finally emerged two measures that have now proved their value, viz. fumigation by hydrocyanic acid gas and control by heat. The former method is disagreeable and dangerous, and elaborate precautions have to be taken. There are also certain beetle pests which are more resistant to the effects of the gas, and the most satisfactory method for controlling all classes of mill-infesting insects is the application of a temperature of 118° to 125° F. To carry out this process effectually the installation of radiators or radiation surfaces is necessary. It has been estimated that this can be fitted up sufficiently economically in an average-sized mill to pay in five years for the cost of its introduction; the heat does not affect the baking qualities of the flour.

THE United States Geological Survey has published a preliminary summary of the mineral resources of the United States in 1919. The value of such statistics of production, etc., at an early date is very obvious, although it is to be hoped that in future years their compilation may be completed in less than nine months. The importance of the present set of statistics lies in the fact that they include 1913, the last pre-war year; 1918, the year of the maximum intensity of production for war purposes; and 1919, the first year of the return towards more normal industrial conditions.

NO. 2688, VOL. 107]

Thus, to take the most important of all, namely, coal, it is shown that the production in 1913 was 569,960,219 (short) tons; in 1918, 678,211,904 tons; and in 1919, about 544,263,000 tons. The position is similar in most other important minerals, the output in 1919 being considerably less than the intensive figures reached in 1918, but in most cases not far behind those of 1913. The importance of having such statistics as these available at an early date, even though they may not be absolutely accurate and may need some little later revision, cannot be too strongly emphasised.

THE weather was so persistently mild and dry during the past winter that a comparison with previous winters may be of interest. The Greenwich mean temperature for each of the six months October, 1920-March, 1921 was above the average. The mean for the whole period was 45.0° F., the excess for the six months amounting to 2.6°. The greatest excess was 7° for January, while for March the excess was 4°. There have been two milder winters since 1841, that of 1898-99 having a mean of 45.4°, while for 1913-14 the mean was 45.2°. For each of the winters 1911-12 and 1876-77 the mean was 45.0° F., in absolute agreement with the past winter. Frost occurred in the shade on thirty nights during the past six winter months, the greatest number of frosty nights, ten in number, having occurred in November. There have been eight winters since 1841 with fewer frosts, the least number being nineteen recorded in 1883-84. Rainfall was below the average in each month except perhaps December, which, however, was dry compared with the Greenwich average for a hundred years. The total fall for the winter was 6.87 in., which is about 5 in. less than the normal. There have been only three drier winters since 1841; the driest was 1879-80 with 5.54 in. of rainfall, followed by 1858-59 with 6.65 in. and by 1897-98 with 6.85 in.

THE equation $UV = -f^2$, where U and V denote respectively the distance of object and image from the focal planes of a thin lens, is not so well known as the equation $1/v - 1/u = 1/f$, which gives the distances from the lens itself. We have received a booklet from Prof. Mohd. A. R. Khan, Nizam College, Hyderabad, in which the former equation is graphed and applied in detail to different elementary cases with the view of encouraging its use by students of elementary optics.

WE have received from Messrs. R. and J. Beck, 68 Cornhill, E.C.3, a catalogue of microscopes and microscopical apparatus. The standard London microscope, Model 1., has been designed to fulfil the specification prepared by the British Science Guild for a standard microscope, and is supplied in four types. Stand No. 3211, which is suitable for ordinary bacteriological work, includes condenser, three eyepieces, $\frac{3}{8}$ in., $\frac{1}{2}$ in., and $\frac{1}{2}$ in. o.i. objectives, dark-ground illuminator and stop for the oil-immersion objective, and a set of Sloan objective changers, and is listed at 33l. 11s. (December, 1920). A detachable form of mechanical stage costs an additional 6l. A

new electric lamp for the microscope has also been designed for use with a "Pointolite," a half-watt, or a metal filament lamp. Another piece of apparatus at a moderate price is the Beck photomicrographic camera.

IN *Science* of March 25 Dr. I. Langmuir attempts to modify the "cubical" model of the atom, in which the outer electrons are supposed to be practically at rest, so as to obtain the well-known results in connection with spectra which were achieved by the entirely different atomic model due to Bohr. It is shown that on the assumption of a repulsive force $F_q = 1/mr^3(nh/2\pi)^2$ between the positive nucleus and an electron, in addition to the Coulomb attractive force $F_c = Ze^2/r^2$, the equations for the radius of the electronic orbit, the total energy in any stationary state, and the frequency of revolution of the electron in the Bohr atom are obtained. The symbols denote: m = mass of nucleus, Ze = charge on nucleus, r = distance between electron and nucleus, h = Planck's constant, and n is an integer denoting the quantum state of the electron. The assumption of the particular law of force for F_q is, however, entirely arbitrary, and was chosen to give the results obtained.

At a meeting of the Institution of Civil Engineers on April 19 a paper on "The Measurement of the Discharge of the Nile through the Sluices of the Assuan Dam" was jointly presented by Sir Murdoch MacDonald and Mr. H. E. Hurst. The paper describes a series of observations taken to determine accurately the discharge by means of the volumes of water passed into a masonry tank having a capacity of 22,000 cubic metres, which was constructed for the purpose of forming a water-cushion to protect the rock surface on the down-stream side of the dam. The results of the measurements, which are believed to be correct within 1 per cent., showed that (a) for a given opening the coefficient of discharge increases as the head increases until, in the neighbourhood of 10 metres head, it becomes constant; (b) for the small openings, 1.5 and 2.0 metres, there is not much difference between the coefficients for the same head, and the coefficients for both openings attain practically the same maximum value; and (c) for the small heads there is a progressive decrease of coefficient as the size of the opening increases. For heads greater than 3 metres this effect is reversed, and the coefficient increases with increase of sluice-opening. Experiments were also made to determine the coefficients of discharge of other types of sluices of the dam which differ in dimensions and in the levels of their sills. The results of these experiments are stated and discussed. Some observations are added on the accuracy of Gurley current-meters.

THE lighting of ships at sea, which was the subject of discussion at the last meeting of the Illuminating Engineering Society, offers a number of interesting problems. The society was fortunate in receiving the co-operation of representatives of the Admiralty and of the Mercantile Marine Service Association, some of whom gave interesting accounts of their difficulties when oil-lanterns were the only illuminants available.

One gathers from the discussion that in many cases the degree of light provided is much less than that usual on land, and this must affect the safety and efficiency of work in the hold of the ship. Among special problems mentioned the lighting of the chart-house and compass-dials deserves attention. Naturally concealed lighting is recommended in this case, one approved method being the lighting of charts mounted between sheets of glass by diffused light transmitted from below. Another interesting question raised in the discussion was the amount of light desirable on the deck of a ship. Shipmasters were inclined to view with disfavour the use of lights on deck, on the ground that, in contrast with the dense surrounding darkness, they would dazzle the eyes and interfere with operations on deck in sailing-ships, as well as affect the "look-out." It may be presumed, however, that this depends much on the nature of the lighting, and that these objections would be less if the actual sources could be effectually screened from view: To a landsman the idea of working constantly on a violently moving ship in complete darkness seems inevitably accompanied by risk and inconvenience such as moderate diffused lighting might diminish.

WE have received a copy of the first of a new series of catalogues issued by the Science Museum at South Kensington. It is intended that each catalogue shall treat of a single group of the collections and contain illustrations of a few important objects; by these means the price can be kept within reasonable limits, and the visitor need purchase no more than he actually requires. Eventually the new series will cover the whole of the collections in the museum and take the place of the existing catalogues. The present part (1s.) deals with machine-tools and metal-working and wood-working machines; descriptive and historical notes are included. The compilers of the catalogue clearly have in view the meeting of the requirements of the visitor or purchaser who is interested in one particular class of exhibits, and such will find that the arrangement of the catalogue is good and that the notes appended to each exhibit have been admirably written. The value of the illustrations given may be questioned; these comprise twenty-two photographic representations of selected machines. If the purchaser is also a visitor he will certainly not require these illustrations, having the actual model or machine before him. If he is not a visitor photographs will help him in a minor degree only, and we should like to suggest that a few line-drawings showing the mechanism or the principle of the mechanism would constitute a very valuable addition to the catalogue. The idea of section catalogues is a sound one, and we hope that the authorities will develop it in such a manner as to meet the need which all students have experienced in visiting the Science Museum, viz. to provide a record to which reference may be made at any future time, confident that the method of working and arrangement of any of the exhibits will be understood.

MESSRS. A. GALENKAMP AND CO., LTD., of Surr Street, Finsbury Square, E.C.2, have issued a list (No. 71) of students' balances and weights of British

manufacture. The prices seem very moderate, and the construction and sensibility of the instruments are such as will make them suitable for teaching purposes in schools.

BEGINNING with the number to be published on July 15 next, the *Psychic Research Quarterly* will be incorporated in a new quarterly review entitled *Psyche*, which will deal with applied and general psychology in relation to education, psycho-analysis, industry, religion, social and personal relationships, psychological research, etc. A special feature of the periodical will be the literary section. The publishers will be Messrs. Kegan Paul and Co., Ltd.

THE first number of a new publication, *State Technology*, has been received. The journal is to be the official organ of the Institution of Professional Civil Servants, which was founded in 1918. A novel feature of the first issue is the inclusion of short abstracts of the proceedings of technical institutions and a paper on a technical subject. The journal will thus assist in

providing a means of communication between the technical, scientific, and professional workers in the service of the State, and may also serve to acquaint men of science generally with some of the activities of our numerous Departments of State.

MESSRS. BOWES AND BOWES, 1 Trinity Street, Cambridge, have just issued a handy classified catalogue (No. 404) of second-hand books, journals, and monographs dealing with many departments of science. The scope of the catalogue will be seen from the following sections into which it is divided:—Journals, Transactions, and Proceedings of Learned Societies; Travels, Expeditions, etc.; Biographies of Scientific Men; General Science, including Evolution, Microscopy, etc.; Biology; Botany; Zoology; Geology, including Mineralogy; Anthropology, Ethnology, etc.; Chemistry and Physics; and Portraits of Scientific Men. Upwards of 900 works are listed, and the prices asked are very moderate. The catalogue is obtainable upon application.

Our Astronomical Column.

REID'S COMET.—This comet has been readily visible with the naked eye provided its position was known. In the telescope it has been most conspicuous with a large coma, a stump of a tail, and a nucleus which, as Mr. G. Merton expresses it, is planetary rather than stellar in character. It will be nearest to the pole (distance $4\frac{1}{2}^\circ$) on May 9. The following is a continuation of the ephemeris from M. Ebell's latest elements. A little sweeping may be necessary to locate the comet (this remark applies also to the comet Pons-Winnecke, which was readily visible with 6-in. aperture on April 28, and was glimpsed by Dr. W. H. Steavenson with 2-in.):

Ephemeris of Reid's Comet for Greenwich Midnight.

	May	R.A.			N. Decl.	Log r	Log Δ
		h.	m.	s.			
	12	6	21	6	$81^\circ 36'$	0.0044	9.9128
	14	7	3	17	$77^\circ 59'$		
	16	7	23	48	$74^\circ 35'$	0.0066	9.9636
	18	7	35	47	$71^\circ 29'$		
	20	7	43	37	$68^\circ 42'$	0.0108	0.0129
	22	7	49	10	$66^\circ 11'$		
	24	7	53	18	$63^\circ 55'$	0.0167	0.0590
	28	7	59	9	$60^\circ 1'$	0.0243	0.1011
	June 1	8	3	9	$56^\circ 45'$	0.0333	0.1396
	5	8	6	7	$54^\circ 0'$	0.0434	0.1745

PHOTOGRAPHIC CATALOGUE OF THE GLOBULAR CLUSTER MESSIER 15.—This bright globular cluster is situated near the western edge of Pegasus. Two exposures on it were made with the Bonn astrographic equatorial (aperture 280 mm.) on 1916 November 16 and 1917 September 24 (exposures 150m. and 90m. respectively) by Prof. Küstner. The positions and proper motions of eight reference stars (re-observed at Bonn by Mönichmeyer) are discussed in *Veröff. der Univ. Sternwarte zu Bonn*, No. 15, and a catalogue is deduced giving magnitudes and rectangular co-ordinates of 1137 stars in the cluster. Their magnitudes (excluding one star, mag. 8.07, probably superimposed on the cluster) range from 13 to $16\frac{1}{2}$, their X co-ordinates from $-541''$ to $+495''$, and their Y co-ordinates from $-531''$ to $+509''$. A similar research in a few decades will render it possible to pick out the stars optically projected on the cluster. No.

appreciable change in the positions of the cluster stars can be expected until centuries have elapsed.

Photographs with a time-interval of forty-four years are now available for the clusters h and χ Persei. Measurements of these plates were discussed in a paper by the Rev. H. E. Macklin, S.J., presented to the March meeting of the Royal Astronomical Society. He concluded that the few stars showing displacement in the interval were optically projected on the clusters, and further showed that fifteen of them appeared to belong to the moving cluster in Perseus.

A PHOTO-ELECTRIC STUDY OF ALGOL.—Prof. Joel Stebbins, who in 1909 detected the secondary minimum of Algol with his selenium photometer, has recently (*Astrophysical Journal*, March, 1921) published a still more refined research which he has made with the photo-electric cell. He has incidentally detected that δ Persei is variable to the extent of 0.04 magnitude, and in his later work he used l and π Persei as his sole comparison stars, Algol's light being reduced by a neutral shade-glass. On the whole, the new research confirms the old very closely, but there is evidence that the components are ellipsoidal, with a flattening of about 1 in 50. The secondary star appears two-thirds as bright with the new cell as with the selenium one; it is inferred that it is yellower than the primary, perhaps of spectral type G_6 . Endeavours have been made to determine the light of the third component, with period of 1.9 years, revealed by the spectroscope, but this has not yet been done with certainty. The greater brightness of the side of the secondary turned towards the primary is confirmed, though the range is diminished. Taking the light of the whole system as unity, that of the two faces of the secondary is 0.075 and 0.045 respectively. The values found before were 0.102 and 0.058. The area of the bright body obscured at principal minimum is now given as 0.700, and the cosine of the inclination of the orbits as 0.142. It is satisfactory to note that the greater precision of the new results is accompanied by a reduction in the time of observation. "The new curve represents half the effort of the old one."

The Inauguration of the Institute of Physics.

THE inaugural meeting of the new Institute of Physics was held on Wednesday, April 27, in the rooms of the Institution of Civil Engineers. The creation of a new institute was first suggested about four years ago, and in the interim the scheme has been most carefully deliberated over and developed, and it received the sanction of the Board of Trade in November of last year. The object of the institute is specially to look after the professional interests of physicists, to set up and require from its members a high standard of professional conduct, and in other ways to forward the development of physics. It is thus intended to play the same part for physics that the Institute of Chemistry and various engineering bodies do for the cognate subjects. Its founders look forward to the foundation of a central building in which the various societies that participate with it can be housed and their libraries assembled so as to become more accessible than at present. It is not likely that this part of the scheme can come to fruition at any early date; the possibility may, however, rapidly develop now that the public has been called in to inaugurate the institute.

The chair at the meeting was taken by the president, Sir Richard Glazebrook, who in opening it outlined the aims of the promoters. He then called upon Sir J. J. Thomson to address the assembly. Sir Joseph, speaking on behalf of those interested in physics, pointed out that the institute had become necessary on account of the increased number of men and women who now earn their livelihood in one capacity or another in connection with physics. This necessity is evidenced by the fact that in the first year of its existence it has secured 300 members out of the 800 or 1000 persons that are available even when school-teachers are counted. This support is sufficient to justify the recognition of physics as an independent profession. The institute is intended to act as a bond of union. Chemistry (a branch of physics) has long been recognised professionally. The need for a similar recognition of physics has become urgent owing to the establishment of numerous research institutions, especially in connection with industry.

Sir Joseph Thomson indicated that the connection of physics with its applications was accidental, although there have been great developments on the material side. His recollection went back to fifty years ago; the laboratories in existence then were few and sparsely populated. The Cavendish Laboratory had been decided upon, but had not been started. The estimated cost of it was only 6300*l.*, though this estimate was, in fact, exceeded. It was then a reckless and a dangerous thing to make physics the business of one's life, and, in consequence, this course was confined to enthusiasts whose delight in research more than compensated for the deficiencies in their salaries. There were probably fewer than a hundred physicists in all, but the list included such names as Kelvin, Stokes, Maxwell, Crookes, and Osborne Reynolds. Yet work in a laboratory in those days had some advantages. There were fewer students, even though there was less apparatus; now there are twelve induction coils and twenty students wanting them. In these circumstances the director of a laboratory has to exercise the functions of a league of nations in the maintenance of peace. At that time also committees were sporadic rather than chronic, as at present.

The rapid growth of laboratories connected with

various industries and with schools and new universities has created a demand for men which exceeds the supply. In Sir Joseph Thomson's opinion, physics now offers to any competent man a livelihood, though there is small hope of its providing him with a fortune.

There is an increased belief in the use of physics in industry. Sir Joseph Thomson suggested that though it is undoubtedly a good thing to have a physicist in the laboratory, there is a need also for one in the works itself where articles are manufactured in large quantities. This need he illustrated by the case of an article in general use for which the English design is better than the German, and the article itself is superior when it is made in the old-fashioned way by skilled workmen; but when it is manufactured by automatic processes on a large scale (*i.e.* by mass production) the article is very inferior to the German.

Sir Joseph Thomson considers that the scarcity of physicists is likely to continue, for the supply is not adequate to the demand. The number of first- and second-class honours men in 1916 were fewer than five hundred when engineers, chemists, and the higher type of medical men are all included in the estimate. The needs of schools had to be supplied out of this number. It is difficult to see how the insufficiency of eligible men is to be rectified. Each man must undergo at least one year's training in research in order to develop his character, to increase his independence of thought, and to develop his resource, critical power, and enthusiasm—to raise him, in fact, from intellectual adolescence to intellectual manhood. But this means another year at college, involving additional expense that must be faced. This expense is met in part by fellowships and post-graduate studentships, which, however, are insufficient. But lately a Committee of the Department of Scientific and Industrial Research has awarded grants to students in training. Thirty-seven such grants have been awarded by the Committee.

Research is also expensive for the university; the present increase in cost is horrible. Research is as much a part of the work of the university as education. Much more money is now available than formerly, and we should be grateful to a Government for what it does in this direction.

Sir Joseph Thomson directed attention to the vast increase in the amount of work that is now done. The number of papers that were abstracted in the *Beiblätter* in 1873 was 400 for the whole world; in 1913 this was increased to 2700. It may be a question whether pioneer work has increased in the same proportion as routine work, but still it has certainly been accelerated to a very great extent. In examining discoveries the physicist requires, not that truth shall be beauty, but that it shall be in accordance with the laws of Nature. To judge this, a period of suspense is needed; this period is shortened when the number of laboratories and workers is large. It results that even pioneer work has been helped by the appliances which are now available.

In conclusion, Sir Joseph Thomson emphasised that, together with all the developments taking place in response to the stimulus of industry, he saw no disposition to undervalue research undertaken without any thought of industrial applications. Scholarships had been given by the Committee already mentioned for the most abstract researches in pure mathematics. The intellectual harvest is even a higher reward than

increased comfort and convenience. He congratulated the Institute of Physics in being formed to aid intellectual development.

Mr. A. J. Balfour, who as Lord President of the Council is concerned with the Department of Scientific and Industrial Research, was then called upon to extend a welcome to the institute. He expressed his deep gratification at being present. He represented the outside public who ought to have a deep interest in what was being done in the development of pure science and in industry. He was profoundly surprised that there was not hitherto an Institute of Physics. Physics is one of the most fundamental of all the sciences. That lacuna is now filled, and he rejoiced that it had begun under such favourable auspices. Reference had been made to the Department of Scientific and Industrial Research. The public knew little about its work—the public very seldom does know about the things which most deeply concern it. He confessed that when he saw great industrial disputes going on about the distribution of the results of industry he could not help thinking, "Why do not you devote half the energy and half the amount of money involved to increasing the power of man over Nature, which would increase the share and increase the total result to be divided among the members of the community, instead of devoting your energies to saying how the relatively insignificant amount we now produce is to be divided among the producers?" Mr. Balfour's memory went back to his Cambridge days and to the great Cambridge physicists who all in their several ways had made advances in physics which have changed our conception of the structure of the universe and increased our power of turning it to practical account. Mr. Balfour did not believe that mere expenditure of money, the mere growth of laboratories, or the mere multiplicity of students was going to produce a larger crop of men of genius. Genius comes of itself; no system of education yet discovered has been able to turn it out. The spirit bloweth where it listeth, and no organisation will increase the number of men at the very summit of the profession. He did not for a moment wish it to be thought that this remark settled the whole question. A large amount of work which does not in itself bring to maturity a great discovery is required if great discoveries are to be made, and this work can be increased by organisa-

tion and by the expenditure of money. The work that the Advisory Council has done in providing opportunities for research deserved all the praise which Sir J. J. Thomson had given to it. Unfortunately, the present impoverished state of the country has compelled a reluctant Treasury to cut down the sum at their disposal. No money gives, not only a greater spiritual return, but also a greater pecuniary return than the money devoted to research. It is impossible to carry on without more assistance than an impoverished State can afford or wealthy men seem inclined to contribute. Apparently these men do not realise what they might do.

Mr. Balfour said he was often surprised that the imagination of our great magnates was not stimulated by the idea that they could add to the wealth of the whole world by encouraging industrial research. There was nothing narrow about the results of an increase in physical knowledge. What is discovered in Cambridge or Paris or Japan is a gift to mankind. When he reflected, as he thought political economists were slow to reflect, on the prodigious changes which are made by discovery in the lot of mankind he was surprised at the lack of the spirit of liberality, at the imperfect realisation of the actual facts of the case, and at the fatal desire to see an immediate return. Discovery, however, lurks undeveloped for a generation; but the life of nations is a long life, and anything that adds to a knowledge of the physical world must, either sooner or later, in our own time or in that of our remote descendants, do something material for the life of mankind. The hope he had for the world was that by the growth of science and invention, instead of discomfort, comfort and leisure would be given to the community—at least, if the people learn how to use their leisure. That was the idea based upon the work of men who were engaged, as those present were engaged, in probing the secrets of Nature. If, as he believed, the institute they were inaugurating was going to assist in that great work, they might regard the day of this meeting as a red-letter day in the history of British science.

Votes of thanks were proposed by Sir W. H. Bragg, Sir Robert Hadfield, and Prof. C. H. Lees.

All information concerning the institute can be obtained from the Secretaries, 10 Essex Street, Strand, W.C.2.

The British Science Guild.

SCIENTIFIC DEVELOPMENT AND WORLD-WELFARE.

GR^{EAT} success attended the annual dinner of the British Science Guild, which was held at the Hotel Cecil on Tuesday, May 3, Lord Montagu of Beaulieu, president of the Guild, being in the chair. There was eloquent acknowledgment of the great part science has played in the country's progress, and keen insistence on the imperative need of its wider application to the stupendous problems of the future. The president, unfortunately, was suffering from the effects of a severe attack of laryngitis, and, although this affected the wonted vigour of his utterance, it is scarcely necessary to add that it did not lessen the value of his weighty observations.

After the loyal toasts had been duly honoured, the president, in proposing "Science and the Empire," said he thought it was quite clear that in whatever direction we looked, science, moderation, and balance of mind were wanted all over the world to-day more

than ever before. We had appeals to reason unheeded by great masses of people, we had attempts in other directions to set scientific laws and economic laws at defiance; and when there was an organisation like the British Science Guild, which could, at any rate, attempt to sum up the balance one side and the other, it seemed to him they would do less than their duty if they did not attempt to bring their case and their teachings before the public. Their thoughts were naturally centred on the great struggle that was going on in reference to one of the vital necessities of life—coal. They could not help realising that all these struggles meant an immense waste of power and wealth to the nation. Of course, if we used coal as we should, as every scientific man in that room knew, we should never burn it, for instance, in that most cheerful thing, the open grate. We knew that the smuts which covered our clothes and our buildings in

London were the result of waste in coal-burning. On many grounds they would like to see the time come when all the bituminous coal of the country was passed through a process of coking, and we used the liquid fuel on one side for all kinds of transport and other purposes, and burnt only smokeless fuel in our grates. They would welcome anything that would improve the lot of the miner underground and help him to raise a greater quantity of coal at less exertion to himself and make his occupation more healthy. As economists they knew that unless we could in the future raise coal at a reasonable price the coal of great countries like America would beat us in the markets of the world. Lord Montagu, quoting the example of Joseph in Egypt in preparing for the lean years, suggested that the Government should store certain articles like coal and certain kinds of food which the community might be deprived of during the progress of industrial disputes. That idea might be misinterpreted by some as an attack on the power of the trade unions, but it was nothing of the kind. We did not wish any portion of the community to starve or suffer hardship; moreover, the community must defend itself when attacked. He thought we must gradually look forward to a time when we must not be dependent upon one kind of fuel only. We must cultivate so far as we could the use of alternatives to coal.

Lord Montagu went on to insist that the need of science in every department of the country was greater to-day than it had ever been. He hoped that some of our leading statesmen would not think of science only as a means of destroying our fellow-men because during the war, no doubt, science, especially towards the end of the conflict, was called upon to invent new means of dealing out death to our adversaries, and the whole ingenuity of large numbers of men of science was concentrated on what, after all, was the horrible business of destroying each other. He was sure Field-Marshal Sir William Robertson would agree with him that they should try to develop all these great energies of science to the benefit of the human race. What they really desired to do was to lead a campaign against ignorance, and he could not help thinking of one of the members of their council, a most energetic and valuable member, Mr. J. J. Robinson, who had done wonderfully good work already in establishing provincial centres and in endeavouring to cultivate the scientific spirit in our great provincial towns. He would like to see that side of their work greatly increased.

Field-Marshal Sir William Robertson, replying to the toast, spoke of the great work of men of science in the war, particularly referring to the development, with astonishing success and rapidity, of submarine warfare, both offensive and defensive, and of sound-ranging and signalling. There was also the tank, which was produced in the face of considerable obstacles—some people said obstructions. We had very little glass for making optical instruments, but during the war men of science came forward and produced sufficient quantities of this glass well up to pre-war standard. The credit due to science was all the greater, because in the pre-war preparations science had been too frequently disregarded, with the result that everything had to be done almost from the very beginning. It was to be hoped that the lessons of the war would not be forgotten by the fighting Services, for we might be sure that science would play an even greater part in the next war than it had in the recent war, more especially when we thought of the air

and under the water. In view of the present position of affairs we must not altogether forget about preparations for war. He suggested that what we required was that every State Department and every public service should have with it, and in it, the best scientific advice and assistance that could be furnished. Men who aspired to exercise Ministerial control over the destinies of the country, or in other ways to wield large administrative powers, should attach much greater importance to the value of science as an educative force than they had done in the past. If they neglected to do this they could not hope efficiently to discharge their duties in peace, or usefully assist in guiding their country through the terrible ordeal of war.

Col. Sir Konald Ross proposed "Science and Literature," and the toast was acknowledged by Dean Inge.

Lord Rayleigh submitted the toast of "The British Science Guild," and made a graceful allusion to the distinguished man to whom the origin of the Guild was primarily due—Sir Norman Lockyer. Sir Norman combined, he thought, in a peculiar sense, the qualities necessary for those who would push and advance the scientific cause in this country. It was no use merely to hold scientific views; they had metaphorically to take people by the throat and shake them before they would realise the national importance of scientific principles in progressive practice.

Lord Biedisloe, in acknowledging the toast, said a question those of them who were not yet sufficiently familiar with the Guild might well ask was: "What is the British Science Guild?" The answer had been suggested to him by a very interesting book which had lately been published, Westaway's "Science and Theology," in which he found the following statement:—"The training in scientific method has brought into being a thinking fraternity whose bond of loyalty is respect for the truth." Now, surely, if there was one body more than another in this country that would answer to that description it was the British Science Guild. He thought there was a great poet who said in substance:—"He is a free man whom the truth makes free, and all are slaves besides." Well, we boasted that our country was the land of the free. He thought it was extremely doubtful whether, at any rate under existing conditions, this was an apt description, but if we were not yet conscious of that extent of freedom which ultra-democracy should bring to us, surely we could best remedy the defect by applying science to all the activities of our human life in the future to a much greater extent than we had done in the past. Perhaps the most important work upon which the Guild was at the moment employed was to endeavour to arrange a conference between representatives of science on one hand, and representatives of organised Labour on the other. They felt there was an opening now for an *entente cordiale* between the great enlightened leaders of Labour and the chief exponents of science with the object of rendering the task of Labour lighter, more effective, more comfortable and happy, and in the long run to obtain a very much larger output from the industries of the country. They had every reason to know that the leaders of Labour were quite in sympathy with their endeavours to bring the conference about. Referring to agriculture, his Lordship said that at the present time—largely as a result of the alarming experiences of the war—there was a livelier interest on the part of the organised farmers of this country in scientific methods than ever there had been during the last generation.

Early Chronology of Sumer and Egypt.

ON Wednesday, April 27, Prof. S. Langdon delivered a lecture on behalf of the Egypt Exploration Society at the Royal Society's rooms at Burlington House on "The Early Chronology of Sumer and Egypt and the Similarities of their Culture." The chair was taken by Lord Carnarvon, who has just returned from Egypt and gave a few interesting details of recent excavation work carried out there.

Prof. Langdon said that the ancient people commonly known as the Egyptians were not the first civilised people on the banks of the Nile, but they were preceded by an Asiatic people who were probably Sumerians or Elamites. These two Asiatic peoples are now known to have belonged to the same race, and they founded the first organised societies known to history on the shores of the Persian Gulf and in Elam in the Stone age. The Sumerians, the most talented branch of a widely spread race, spoke a highly organised agglutinating speech. They are found in prehistoric levels from the head of the Persian Gulf northwards along the banks of the Euphrates and the Tigris as far as Assur, north of the Lower Zab, and in Russian Turkestan. Recently discovered dynastic tablets establish the date of the earliest kingdoms of Mesopotamia as early as 5000 B.C. At that time the Semites had already invaded the Mesopotamian Valley and established themselves in the region of Bagdad. The history of ancient Babylonia consists of two rival kingdoms, Sumer in the south, the principal capital of which was Erech, and Kish in the north, the principal capital of which from 5000-2900 B.C. was at Kish.

The earliest Sumerian culture is strikingly similar to that of prehistoric Egypt; it must be assumed that a branch of this people occupied Upper Egypt in the region of Abydos and Hieraconpolis as early as 5000 B.C. The Sumerian linear pictographic writing is clearly revealed in the Egyptian pottery markings which preceded the Egyptian hieroglyphs. This writing is known to have been well developed in Sumer or ancient Chaldea before 3800 B.C., and the prehistoric Egyptian linear style cannot be much later. The Sumerians and Elamites appear to have reached Egypt by sea routes, trading and adventuring along the coasts of southern Arabia until they reached Punt, Ethiopia, and finally the Nile Valley in the

region of Coptos. All their prehistoric remains have been found in Upper Egypt, principally at Abydos and Naghada. They brought with them into Egypt the cylinder seal, the mace head, and a style of decoration in stone which is characteristic of Sumerian art.

The characteristic features of this remarkable people were a long head of large brain capacity, a thin, high nose which joined the cranium without depression, a slightly receding forehead, and eyes the axes of which are not horizontal, but slant slightly outward. The position of the axis of the eye is precisely the reverse of the Mongolian type. It is possible to discern in their prehistoric tomb paintings in Egypt the same physical characteristics. They disappeared in Egypt some time before the first Egyptian dynasty founded by Menes, and were superseded by an African people who amalgamated with Semitic races from Asia. This new race invented their own system of writing, which developed into the classical hieroglyph. The older Sumerian linear style appears to have been used in Egypt without intelligence even by the Sumerian-Egyptians themselves. It was probably never understood in Egypt, and the signs survived only as occult marks on pottery after the older Asiatic peoples had disappeared.

The religion of the Egyptians is obviously related to the Sumerian, and there is no Semitic influence in the fundamental religious concepts of the ancient religions of Babylonia and Egypt. The names of the gods in both pantheons do not reveal a single Semitic name. It is probable that the great cults of Tammuz and Osiris are the creations of two branches of the same people, that of Osiris being inherited by the Egyptians from the older Asiatic people.

Prof. Langdon attempted to fix the beginning of the first Egyptian dynasty by comparing the methods of year-dating of the famous Semitic Emperor Narâm-sin (2795-39 B.C.) with those of Egypt. He argued that Narâm-sin borrowed his system of year-dating from Egypt, and showed that this could have taken place only after Den, fifth king of the first dynasty. He also argued from archæology to make Narâm-sin a contemporary of the last two kings of the second Egyptian dynasty. He arrived by these two methods at a date *circa* 3200 B.C. for Menes.

Imperial Forestry Education.

THE Report of the Interdepartmental Committee on Imperial Forestry Education appointed to prepare a scheme for giving effect to the resolutions of the British Empire Forestry Conference of 1920 with regard to a central institution for training forest officers has just been issued (Cmd. 1166, H.M. Stationery Office, 2d.). Keeping in view the decision of the conference that the future higher training in forestry should take place at a single central institution, the Committee recognises that the main object to be aimed at in the training of forest officers is to turn out men fully equipped with theoretical and practical knowledge, with minds broadened by education, and with capacity, strengthened by practical experience in forest work, to direct men and operations. It considers that it would be a retrograde course to interfere with the work already done by universities in establishing and maintaining courses of training in forestry, and seeks rather to co-ordinate all these courses, to bring them up to a common level, and to utilise them as a preliminary to a higher course of training at one centre.

Under this scheme the course of study at a university would extend over three years, leading to a degree in forestry; at this stage men would be selected as probationers for one or other of the forest services, and admitted to the central institution for a period of higher training extending over one year in the case of ordinary forest officers, or longer in the case of those who propose to specialise. In order to widen the field for recruitment and to obtain men with a high scientific training, it is considered desirable that a certain number of probationers should be selected with honours degrees in science; these men should then, after a forestry course covering the second and third years at a university school, spend a final year at the central institution. In the case of men required as specialists honours graduates in science should be selected, given such a course in general forestry as may be considered necessary, and then sent for two years to the central institution.

The Committee directs attention to the great value of maintaining close relations between the central training institution and research work; research into

questions affecting forest production as well as entomology, mycology, soil science, and the like should form part of the work of the central institution.

It is proposed that the central institution should be located at Oxford, incorporated with the University, and governed by a board appointed one half by the Departments or Governments concerned and the other half by the University. The director (who should be the professor of forestry) and the staff should be appointed by the University with the approval of the board. The Departments concerned should jointly guarantee to the board an annual sum sufficient to pay the costs of the institution, and should defray any deficit in the annual working in proportion to the number of students trained for the services of each Department. It is estimated that the annual cost of the permanent staff should not at the commencement exceed 4000*l.* per annum. No estimate of the capital cost of the proposed scheme can be made until detailed plans of such buildings as the University are prepared to provide have been obtained and discussed, but pending the erection of permanent buildings it has been ascertained that arrangements can be made with the University for temporary accommodation.

Among other proposals is one that officers of every forest service should at one period of their career return to the institution for a special course.

University and Educational Intelligence.

CAMBRIDGE.—Dr. J. H. D. Scott and Mr. W. W. Harvey, of Christ's College, have been elected to John Lucas Walker studentships in pathology.

Mr. T. C. Wyatt has been elected to a fellowship at Christ's College.

The directors of Messrs. Barclays Bank, Ltd., have given 1000*l.* towards the cost of the new engineering laboratory.

Details of the latest proposals as to women students at Cambridge have now been published. The memorial (which has been signed by nearly two hundred residents, including Sir Clifford Allbutt, Prof. Eddington, Dr. Fenton, Dr. E. H. Griffiths, Prof. Inglis, Sir William Pope, Dr. Rivers, Prof. Seward, Sir Joseph Thomson, and Dr. Whetham) asks that women shall be matriculated as members of women's colleges; shall be eligible for all degrees with all privileges except membership of the Senate and of the Electoral Roll; also that they shall be eligible for scholarships, prizes and studentships, professorships, readerships, lectureships, and examinerships of the University and for membership of boards and syndicates. Women would be present on the council of the Senate as assessors without vote. There would be provision against mixed colleges and against an increase of resident women *in statu pupillari* beyond 500. The council proposes to have this scheme and the alternative scheme, which merely offers the women titular degrees, voted on during the present term. The new scheme is the result of a conference between some of the supporters and some of the opponents of the old Report A, and is backed by the signatures of 115 supporters of Report A and of 50 opponents of this report.

LONDON.—The first of a course of eight advanced lectures in physiology was given in the physiological laboratory, St. Bartholomew's Hospital, West Smithfield, E.C.1, on Tuesday, by Prof. W. D. Halliburton upon the subject of Cerebro-spinal Fluid. The remaining lectures will be as follows:—May 10, Prof.

M. S. Pembrey, The Secretion of Milk; May 17, Mr. J. Barcroft, Alpinism; May 24, Prof. W. M. Bayliss, The Reaction of the Blood; May 31, Prof. J. B. Leathes, Tyrosine; June 7, Prof. E. H. Starling, The Heart in Exercise; June 14, Dr. H. H. Dale, Anaphylaxis; and June 21, Dr. Leonard Hill, The Capillary Circulation.

Another course of eight lectures on "Reception of Sensory Stimuli" will be given by Prof. H. E. Roaf in the physiology theatre, London Hospital Medical College, Turner Street, Mile End, E.1, at 4.30 p.m., on Thursdays, May 12, 19, and 26 and June 2, 9, 16, 23, and 30. The lectures in each course are addressed to advanced students of the University and to others interested in the subject. Admission is free, without ticket.

THE Zionist Organisation is prepared to send a lecturer on the Jewish national movement free of all charge to any organisation or society. The lecture can be illustrated by lantern-slides dealing with Palestinian life and scenery. Persons interested should write to the Lecture-Secretary, Zionist Organisation, 77 Great Russell Street, London, W.C.1.

A PROVISIONAL programme has been issued of the summer meeting of the Institution of Electrical Engineers to be held at the Scottish centre (Glasgow) on June 7-10. On the first day of the meeting Mr. R. B. Mitchell will describe the Dalmarnock generating station, which will be followed by a visit to this power station. On the second day Prof. M. Maclean will give a paper entitled "The Hydro-electric Resources of the Scottish Highlands." The last day of the meeting will be spent at Oban, and a visit will be paid to the hydro-electric installation of the British Aluminium Co.

ACTING in co-operation with the Royal Academy of Sciences in Holland, the Anglo-Batavian Society is attempting to foster a fuller understanding between scientific men in Holland and England by arranging for addresses to be given by Dutch lecturers in London and by English men of science in the four universities of the Netherlands. In March last the lectures in Holland were inaugurated at Leyden by Dr. Thomas Lewis, of University College Hospital, who gave an account of his recent work on the heart. On April 14 and 16 Prof. Elliot Smith delivered addresses at Groningen and Utrecht respectively on "Vision and Evolution." In 1912 Prof. Elliot Smith directed attention (*NATURE*, September 26, 1912) to the far-reaching results in the evolution of the Primates of the substitution of vision for smell as the guiding sense in man's arboreal ancestors. In the Montgomery lecture in Dublin last autumn he developed this theme further by demonstrating the profound influence exerted upon the evolution of the brain by the acquisition of stereoscopic vision. In the lectures given in Holland attention was concentrated on the changes which are brought about in the cerebral cortex of an animal which for the first time acquired powers of true observation and the means of appreciating form, space, and time. The possession of acute vision in conjunction with extreme mobility and co-ordination of the eyes and such delicate tactile instruments as the hands, which under the guidance of vision explore the surrounding world and learn by experiment, gave the animal the curiosity and the incentive to embark upon the voyage of discovery which eventually led to the emergence of man's intelligence and æsthetic appreciation, and as a result the attainment of his distinctive knowledge and powers of discrimination.

Calendar of Scientific Pioneers.

May 5, 1859. Peter Gustav Lejeune Dirichlet died.—The successor of Gauss at Göttingen, Dirichlet did original work on the theory of numbers and Fourier's theorem, and wrote on the discoveries of Gauss and Jacobi.

May 5, 1892. August Wilhelm von Hofmann died.—A great leader in the chemical world, Hofmann in 1845, at the age of twenty-seven, through Liebig, became head of the Royal College of Chemistry, London, where many prominent chemists were trained. His work related to many problems in organic chemistry, and especially to the coal-tar industry. Returning to Germany in 1864, the following year he succeeded Mitscherlich in the University of Berlin.

May 6, 1859. Friedrich Heinrich Alexander, Baron von Humboldt died.—Possessing a passion for travel and science, Humboldt during 1799–1804 made a memorable journey with Bonpland in South America. His great scientific work, "Cosmos," was published during 1845–58.

May 6, 1904. Alexander William Williamson died.—Williamson in 1855 succeeded Graham in the chair of chemistry in University College, London. For his work on etherification he was awarded one of the Royal medals of the Royal Society.

May 8, 1794. Antoine Laurent Lavoisier died.—The founder of modern chemistry and one of the most distinguished victims of the French Revolution, Lavoisier perished beneath the guillotine at the age of fifty. In prison he refused poison, saying, "I set no more value on life than you do; and why seek death before its time? It will have no shame for us. Our true judges are neither the tribunal that will condemn us nor the populace that will insult us. We are stricken down by the plague that is ravaging France." One hundred and six years after his death Paris, as the result of an international subscription, erected the monument to Lavoisier which stands behind the Madeleine Church, close to where he once lived.

May 8, 1892. James Thomson died.—The elder brother of Lord Kelvin, Thomson was a distinguished physicist and engineer, and in 1873 succeeded Rankine in the chair of engineering at Glasgow.

May 9, 1850. Joseph Louis Gay-Lussac died.—A professor of chemistry at the Ecole Polytechnique, Gay-Lussac was known principally for his researches into the chemical and physical properties of gases and vapours. In 1815 he isolated cyanogen.

May 10, 1566. Leonhard Fuchs died.—Fuchs is regarded as one of the founders of German botany. His name is perpetuated by the word "fuchsia," first applied to the plant in 1703 by Plumier.

May 10, 1829. Thomas Young died.—A pioneer in physiological optics, the advocate of the undulatory theory, the first to use the term "energy" for the product of mass into the square of velocity, and the introducer of "Young's modulus," Young has been referred to as the most clear-thinking and far-seeing natural philosopher of his age.

May 10, 1910. Stanislao Cannizzaro died.—The greatest of Italian chemists, Cannizzaro held posts at Pisa, Alessandria, Genoa, and Palermo, took part in the liberation of Sicily, and from 1871 was professor of chemistry at Rome. His greatest work was the extension and application of the hypothesis of Avogadro.

May 12, 1781. Sir John Frederick William Herschel died.—By his work in physics and astronomy and by his writings Herschel exerted a great influence on his fellows. His fame was largely enhanced by his astronomical work at the Cape of Good Hope during 1834–38.

E. C. S.

Societies and Academies.

LONDON.

Royal Society, April 21.—Prof. C. S. Sherrington, president, in the chair.—Prof. J. Joly: A quantum theory of colour vision. In accordance with the physiological law of nerve impulses, known as the "all-or-none" law, the cone is connected with the optic nerve through a plurality of nerve-fibres, the rod being connected through one fibre only. This is supported by histological evidence. The fundamental colour-sensations may be taken as corresponding to frequencies in the ratio 2:3:4, and this is the ratio of the energies of the corresponding quanta and of the kinetic energies of the electrons liberated. It is supposed that this is also the ratio of the numbers of fibres activated in the cone. In the case of the rod, quanta can activate but one fibre; hence its achromatic functions. In the case of the cone the activation of two, three, or four fibres evokes the fundamental sensations. White sensation arises when all nine fibres are activated. Colour-sensation curves, colour blindness, and the energy relations of colour sensation and luminous sensation are discussed.—Prof. A. V. Hill: The energy involved in the electric change in muscle and nerve. An expression is given for the heating effect in a muscle or nerve of the currents produced by the electric response accompanying the propagated impulse. In a muscle the heat produced is not more than one-hundred-thousandth part of the energy liberated in a twitch; in a nerve it is of the order of size of 3.5×10^{-10} calorie. It is concluded from the smallness of these quantities that no appreciable provision of energy is required in the propagation of the electric response, and that the physico-chemical change producing the response is the only factor involved in the propagated nervous impulse.—H. M. Kyle: Asymmetry, metamorphosis, and origin of flat-fishes. The flat-fishes owe their change of form in the beginning to an inherent asymmetry of the abdominal organs, the coil of the gut; other organs develop asymmetrically according to the balance, and persistent flexures convey the asymmetry to the skull. Many normal teleosts form a coil and display the same initial disturbances, but their balance is less defective and the skull escapes deformity in various ways. The metamorphosis of flat-fishes takes place during the pelagic stages; the fish swims and lies on one side because that side becomes the heavier. After the demersal habitat has been attained, changes in fundamental structure are improbable, so essential differences indicate separate origins. The flat-fishes have appeared in phylogeny—that is, the skull became affected by the asymmetry of the body when the coil of the gut was forming and when the caudal region came to occupy more than half the total length. Confirmation of this view is found in the affinity of each group to separate types of normal teleosts ranging from the Macrurids to the Percoids.—T. L. Prankerd: Studies in the cytology of the statolith apparatus in plants, viewed in relation to their habit and biological requirements. (1) The reaction to external stimuli of some liverworts. The degree of geotropic irritability corresponds in general with the biological requirements of the plant. The statolith apparatus is usually absent in vegetative thalli where position is of no importance, while it is most strikingly developed in the strongly geotropic gametophores and sporogonia. (2) The movements executed by fern-fronds in response to internal and external stimuli. In fifteen species representative of the Filicales geotropic irritability was always present, though both latent and reaction times are greater than the corresponding periods for Angiosperms, implying physiological

evolution. A cylinder of statocyte tissue is always developed in the ground tissue of the young rachis, which disappears at about the time of unfolding of the leaflets, when response to gravity also ceases. In *Asplenium bulbiferum* a curve showing the amount of statocyte tissue present corresponds more closely with the curve of geotropism. Growth continues some time after the simultaneous loss of the statolith apparatus and the power of gravitational response.

April 28.—Prof. C. S. Sherrington, president, in the chair.—Prof. H. Lamb and R. V. Southwell: The vibrations of a spinning disc. This investigation was suggested by the occasional failure of the blades of steam turbines, apparently resulting from flexural vibrations of the turbine disc. Expressions have been obtained for the gravest natural frequencies of vibration (1) by exact methods, on the assumption that the disc is so thin or rotates so fast that the restoring effects of centrifugal force are predominant and the effects of flexural rigidity negligible; (2) from Kirchhoff's theory for flat circular plates, in cases for which the opposite assumption can be made; and (3) by Rayleigh's approximate method, employing an assumed curve of deflection, for cases in which both centrifugal and flexural effects require to be taken into account. Employing method (3), the gravest natural frequency of vibration must be over-estimated. It is shown that a corresponding lower limit can be obtained by considering each restoring system separately.—Dr. W. Rosenhain: The hardness of solid solutions. It is suggested that crystals of a solid solution of metal B in metal A are built up on a single space-lattice system similar to that of crystals of pure A, but that certain atoms of A are replaced by atoms of B. As the atoms of B are necessarily dissimilar from atoms of A, this involves a certain amount of distortion of the space-lattice, the amount of which will depend upon the degree of dissimilarity between the two kinds of atoms. The mechanical properties of the crystals will be affected by the distortion, surfaces which were plane gliding surfaces in the crystals of pure A being no longer perfectly plane in the solid solution crystals, and consequently offering an increased resistance to slip within the crystal. The greater the distortion produced by the introduction of an atom of B, the greater will be the hardening effect of the introduction of B into A in the form of solid solution. As a first approximation, the hardening effect of one metal upon another in solid solution is inversely proportional to the solubility of that metal in the first. This is shown to be in accordance with fact in regard to the alloys of many metals.—W. Hartree and Prof. A. V. Hill: A method of analysing galvanometer records. The motion of a galvanometer connected to a thermopile in contact with a body producing or absorbing heat is governed by linear differential equations with constant coefficients. From the relation between galvanometer deflection and time the relation between heat-production and time can be determined. It is necessary to construct a "control-curve," i.e. the relation between galvanometer deflection and time for an instantaneous liberation of heat in the body on the thermopile. The observed curve is reconstructed in terms of the control curve, and, employing a numerical method described, a fair analysis of the course of the production or absorption of heat can be made.—F. H. Newman: A new form of Wehnelt interrupter. The new interrupter consists of a platinum wire immersed in a saturated solution of ammonium phosphate. The whole is contained in an aluminium vessel, which acts as the cathode. The current density at the anode is one-quarter of the value in the old form of Wehnelt interrupter con-

sequently there is less heating of the electrolyte and less disintegration of the platinum wire. The interrupter can be used with alternating currents, which it rectifies. The secondary discharge, obtained from the new type of interrupter, is very disruptive, and has a large peak value. There is no self-induction in the circuit when used with alternating currents. The primary current wave-form has been investigated with direct and alternating currents.—T. L. Ibbotson: Some experiments on thermal diffusion. The method depends on the use of the katharometer as an instrument for accurate gas analysis. A temperature gradient was applied to a number of mixtures of hydrogen and carbon dioxide by passing them through a cylindrical glass tube down the middle of which was a platinum helix heated by an electric current. A steady flow of the gas mixture was maintained, and the gases were drawn off from the hot and cold regions of the tube, afterwards passing through a differential katharometer for analysis. There was a general tendency for the hydrogen to diffuse towards the hotter region and the carbon dioxide towards the cooler region, confirming the results of Chapman and Dootson. Curves are drawn showing that the amount of separation is proportional to $\log T_1/T_2$, where T_1 and T_2 are the absolute temperatures of the hot and cold regions. The maximum separation for a given temperature gradient is obtained in mixtures containing from 50-60 per cent. by volume of hydrogen. The results give strong support to the theory worked out by Chapman in his kinetic theory of gases. The amount of separation is less than would be expected if gas molecules behaved like rigid elastic spheres.—B. N. Chakravarty: The diffraction of light incident at nearly the critical angle on the boundary between two media.

Association of Economic Biologists, April 22.—Sir David Prain in the chair.—W. A. Millard: Green-plant matter as a "decoy" for *Actinomyces scabies* in the soil. The work of Gillespie, Hurst, and Martin was criticised and the obligate relation of potato-scab to a certain range of hydrogen-ion values disproved. Experiments carried out during several years at Leeds were described and interpreted in terms of the author's "decoy" theory.—E. H. Richards: The action of bacteria and protozoa in conserving the nitrogen in sewage. A brief account was given of the activated-sludge process by which intense aerobic treatment increases the nitrogen content from 2 per cent. to from 5 to 7½ per cent., the whole of this being derived from the urea in the initial sewage. Estimating the weight of dry matter in protozoa and bacteria at 25 per cent., the author's experiments at the Rothamsted Experimental Station showed that the nitrogen contained in these organisms gave 8 per cent., a remarkably close approximation to the increased nitrogen after activating sewage. Rothamsted experiments were described which illustrated the valuable manurial properties of activated sludge.—G. P. Wiltshire: The methods of infection of the apple canker fungus. The parasite enters apple-trees through wounds caused by various natural and artificial agents, but the primary channel of invasion is through small cracks in the leaf-scars. The course of such infection was described in relation to the relative susceptibilities of different varieties of apple. The discovery of leaf-scar infection modifies ideas as to the treatment of apple canker, and possible control measures were considered.

PARIS.
Academy of Sciences, April 11.—M. Georges Lemoine in the chair.—P. Appell: The periodic movement of a fluid.—B. Baillaud: Observations of the solar

eclipse of April 7, 1921, at the Paris Observatory.—**H. Douvillé**: The explanation of the appearance of certain new forms of Lamellibranchs.—**A. de Gramont**: The utility in physical astronomy of the consideration of sensibility of lines of the spectrum.—**M. de Sparre**: The maximum yield of turbines.—**M. Emile Borel** was elected a member of the section of geometry in succession to the late Georges Humbert.—**P. Humbert**: The polynomials of Hermite-Didon and the Laplace functions in hyperspace.—**A. Denjoy**: The characters of certain integrable functions and the corresponding operations.—**C. Nordmann**: The apparent diameter of α Orion. The apparent diameter of this star has been recently determined by Michelson, making use of an interference method the principle of which is due to Fizeau. Michelson's figure 0.046" is compared with the figure (0.059") obtained by the author's indirect method based on photometry.—**E. Esclangon**: Observations of the eclipse of the sun of April 8 made at the Strasbourg Observatory.—**A. Lebeuf**: The eclipse of the sun of April 7, 1921. *Résumé* of observations carried out at the Besançon Observatory.—**M. Moreux**: Observation of the eclipse of the sun of April 8, 1921. The phenomenon of the black drop was seen during this eclipse.—**M. Michkovitch**: Observations of the Reid comet (1921a) made at the Observatory of Marseilles with the Eichens 26-cm. equatorial. Positions are given for April 4, 5, and 6.—**J. Mascart**: The eclipse of the sun of April 7, 1921, at the Observatory of Lyons.—**P. Stroobant**: The flattening of the spheroid of Saturn. From the displacements of the line of nodes of the satellites an average figure of 0.1027 or 1/9.74 is found for the flattening. This value is probably more accurate than data based on direct determinations.—**A. Dauvillier**: The structure of the L series.—**G. Reboul** and **R. Luce**: The influence of the geometrical form of solid bodies on the chemical actions which they undergo. Further experimental confirmation of the conclusions arrived at in an earlier confirmation; the velocity of reaction is always greatest at the points where the radius of curvature is smallest.—**A. A. Guntz**: An automatic apparatus for recording the variations of a gaseous mass with time. The manometer measuring the volume changes in the gas has a fine nichrome wire stretched throughout its length; this forms an arm of a Wheatstone bridge, and thus the volume changes converted into resistances are recorded photographically. The whole of the gas is kept at constant disgregation by balancing against a compensation tube kept at a constant temperature. This balance is maintained automatically by a separate electrical arrangement.—**C. Matignon** and **Mlle. G. Marchal**: The use of enamelled bombs in calorimetry. Some of the enamels now in use for lining calorimetric bombs are attacked by dilute acids, and the amount dissolved is sufficient to interfere with the accuracy of the nitric acid correction, and also with the use of the bomb in analytical determinations (sulphur, phosphorus, etc.). The effect is most marked with new enamel.—**G. Dupont**: Contribution to the study of the acid constituents of the resinous exudation from the pine. The dextro- and lævo-pimaric acids. By the usual methods of extraction the lævo-acid is converted into its optical isomeride. The technique necessary for the isolation of either acid in a pure state is described.—**J. Rouch**: Observations of the electrical field of the atmosphere during the eclipse of the sun of April 8, 1921. The electrical field underwent a marked diminution; there was a lag of about an hour from the middle of the eclipse.—**A. Briquet**: The Low Country of Picardy north of the Somme, the line of the ancient bank.—**S. Stefanescu**: The asymmetry and the technical

longitudinal sections of the crown of the molars of mastodons and elephants.—**A. Dehorne**: Heterotypy in the somatic mitosis of *Corethra plumicornis*.—**P. Wintrebert**: The aneural irritability of the ectoderm revealed by the ciliary displacement of the embryo in *Rana temporaria*.—**W. Kopaczewski**: Surface tension and antianaphylaxy. A criticism of the views and experiments of M. A. Lumière on the importance of surface tension in connection with anaphylactic shock.—**M. Kayser**: Researches on the azobacter.

Books Received.

Aspects of Plant Life, with Special Reference to the British Flora. By Robert L. Praeger. (Nature Lover's Series.) Pp. 208. (London: S.P.C.K.; New York: The Macmillan Co.) 6s. net.

The Yearbook of the Universities of the Empire, 1921. Edited by W. H. Dawson. Pp. xiv+571. (London: G. Bell and Sons, Ltd.) 15s. net.

Le Destin des Etoiles: Etudes d'Astronomie physique. By Svante Arrhenius. Traduction française by T. Seyrig. (Nouvelle Collection scientifique.) Pp. v+224. (Paris: F. Alcan.) 8 francs net.

Thermodynamics and Chemistry. By Prof. F. H. MacDougall. Pp. v+391. (New York: J. Wiley and Sons, Inc.; London: Chapman and Hall, Ltd.) 30s. net.

The Practice of Silviculture. By Prof. Ralph C. Hawley. Pp. xi+352. (New York: J. Wiley and Sons, Inc.; London: Chapman and Hall, Ltd.) 22s. net.

The Formation of Colloids. By Prof. Th. Svedberg. (Monographs on the Physics and Chemistry of Colloids.) Pp. 127. (London: J. and A. Churchill.) 7s. 6d. net.

Man and his Past. By O. G. S. Crawford. Pp. xv+227. (London: Oxford University Press.) 10s. 6d. net.

Critical Microscopy: How to Get the Best out of the Microscope. By Dr. Alfred C. Coles. Pp. viii+100+iii plates. (London: J. and A. Churchill.) 7s. 6d. net.

Drugs in Commerce: Their Source, Preparation for the Market, and Description. By John Humphrey. (Common Commodities and Industries.) Pp. xi+116. (London: Sir I. Pitman and Sons, Ltd.) 3s. net.

Stella Maitland; or, Love and the Stars. By Hester P. Hawkins. Pp. viii+249. (London: Simpkin, Marshall and Co., Ltd.) 6s. net.

Faune de France. By Prof. R. Koehler. No. 1: Echinodermes. Pp. 210. (Paris: P. Lechavelier.)

Post-Graduate Teaching in the University of Calcutta, 1919-20. Pp. 112. (Calcutta: University Press.)

Diary of Societies.

THURSDAY, MAY 5.

IRON AND STEEL INSTITUTE (Annual Meeting) (at Institution of Civil Engineers), at 10 and 2.30.—**H. Brearley**: The Welding of Steel in relation to the Occurrence of Pipe Blow Holes and Segregates in Ingots.—**Dr. J. E. Stead**: Solid Solution of Oxygen in Iron.—**H. T. Ringrose**: Scientific Control of Combustion.—**J. E. Fletcher**: Open-hearth and Other Slags—their Composition and Graphic Methods for determining their Constitution.—**S. H. Fowles**: Notes on the Cleaning of Blast-furnace Gas.

ROYAL INSTITUTION OF GREAT BRITAIN, at 3.—**Dr. C. S. Myers**: Psychological Studies: (1) The Localisation of Sound.

INSTITUTE OF PATHOLOGISTS AND RESEARCHERS (St. Mary's Hospital, Paddington), at 4.30.—**Prof. L. Hill**: Capillary Blood Pressure and Oedema.

ROYAL SOCIETY, at 4.30.—**Dr. H. Head**: Release of Function in the Nervous System. (Croonian Lecture).

LINNEAN SOCIETY, at 5.—**Prof. J. Stanley Gardiner**: Reports on Collections from the Indian Ocean for Issue in the Society's Forthcoming Transactions, vol. xviii.—**E. R. Speyer**: Insects

in relation to Reproduction in Coniferous Trees.—Prof. W. J. Dakin: The Collections from the Houtman Abrolhos Islands in 1913.

ROYAL INSTITUTE OF BRITISH ARCHITECTS, at 5.—F. C. Eden: Architecture and Travel.

CHILD-STUDY SOCIETY (at Royal Sanitary Institute), at 6.—Miss F. E. Webb and Others: Individual Training in the School.

INSTITUTION OF ELECTRICAL ENGINEERS (at Institution of Civil Engineers), at 6.—Discussion on Tariffs (continued).

CHEMICAL SOCIETY, at 8.—G. A. R. Kon: The Formation and Stability of *spiro*-Compounds. Part IV. The Formation of Ketones Derived from Open-chain and Cyclic Glutaric Acids by the Thermal Decomposition of their Calcium Salts.—G. W. Monier-Williams: The Hydrolysis of Cotton Cellulose.—J. L. Baker and H. F. E. Hulton: Amylases of the Cereal Grains: Rye.

ROYAL SOCIETY OF MEDICINE (Obstetrics and Gynaecology Section), at 8.—Annual General Meeting.—H. Curtis: Angioma of the Vagina Spontaneously Evacuated.—Dr. A. E. Giles and Others: The Causes and Treatment of Sterility.

FRIDAY, MAY 6.

IRON AND STEEL INSTITUTE (Annual Meeting) (at Institution of Civil Engineers), at 10 and 2.30.—S. N. Braysbaw: The Prevention of Hardening Cracks, and the Effect of Controlling the Recalescence of a Tungsten Tool Steel.—Dr. J. Newton Friend: The Protection of Iron with Paint against Atmospheric Corrosion.—K. Honda, T. Matsushita, and S. Idei: The Cause of Quenching Cracks.—W. E. Hughes: Slip-lines and Twinning in Electrodeposited Iron.—A. Westgren: Röntgen Spectrographic Investigations of Iron and Steel.—J. H. Whiteley: Cuprio Etching Effects produced by Phosphorus and Oxygen in Iron.

ROYAL SOCIETY OF MEDICINE (Laryngology Section), at 4.45.—Annual General Meeting.

ROYAL ASTRONOMICAL SOCIETY (Geophysical Discussion), at 5.—Sir Napier Shaw, Col. E. Gold, W. H. Dines, and F. J. W. Whipple: The Structure of the Atmosphere up to 20 kilometres. Chairman: Dr. G. C. Simpson.

INSTITUTE OF TRANSPORT (Graduates and Students' Section) (at Royal Society of Arts), at 5.—D. J. Owen: Docks and Harbours: General Structural Lay-out, Systems of Control, Operation, and Charges.

JUNIOR INSTITUTION OF ENGINEERS, at 8.—D. W. Wood: Fire-Resistance of Aggregates for Reinforced Concrete.

ROYAL INSTITUTION OF GREAT BRITAIN, at 9.—Sir Robert Robertson: War Developments of Explosives.

SATURDAY, MAY 7.

ROYAL INSTITUTION OF GREAT BRITAIN, at 3.—Prof. E. C. C. Baly: Chemical Reaction.

MONDAY, MAY 9.

ROYAL INSTITUTION OF GREAT BRITAIN, at 5.—General Meeting.

ROYAL GEOGRAPHICAL SOCIETY (at Lowther Lodge), at 5.—Col. Sir Sidney Burrard: The Origin of Mountain Ranges.

INSTITUTION OF ELECTRICAL ENGINEERS (Informal Meeting) (at "Chartered" Institute of Patent Agents), at 7.

INSTITUTION OF MECHANICAL ENGINEERS (Graduates' Meeting), at 7.—W. H. Sawyer: The Engineering Aspect of Modern Iron-foundry Practice.

FARADAY SOCIETY (at Chemical Society), at 8.—E. K. Rideal and U. R. Evans: The Problem of the Fuel Cell.—L. F. Knapp: The Solubility of Small Particles and the Stability of Colloids.—Prof. F. G. Donnan: Note on a Formula Expressing the Variation of Surface Tension with Temperature.—Studies in Capillarity: Continuation of Discussion held at Manchester on the following papers:—A. Ferguson: Part I. Some General Considerations and a Discussion of the Methods of Measuring Interfacial Tensions.—A. Ferguson and P. E. Dowson: Part II. A Modification of the Capillary Tube Method for the Measurement of Surface Tensions.

SURVEYORS' INSTITUTION, at 8.—T. A. O'Donahue: The Valuation of Mineral Properties, with Special Reference to Post-War Conditions.

TUESDAY, MAY 10.

ROYAL INSTITUTION OF GREAT BRITAIN, at 3.—Prof. A. Keith: Darwin's Theory of Man's Origin in the Light of Present-Day Evidence.

INSTITUTION OF PETROLEUM TECHNOLOGISTS (at Royal Society of Arts), at 5.30.—Prof. P. Carmody: Trinidad as a Key to the Origin of Petroleum.

ZOOLOGICAL SOCIETY OF LONDON, at 5.30.—R. I. Pocock: The Auditory Bulla and other Cranial Characters in the Mustelidae (Martens, Badgers, etc.).—G. S. Thapar: The Venous System of the Lizard, *Varanus bengalensis*, Daud.—Dr. C. W. Andrews: The Skull of *Dinotherium giganteum* in the British Museum.

ROYAL PHOTOGRAPHIC SOCIETY, at 7.—L. P. Clero: The Theory of the Screen in Half-Tone Work.—K. C. D. Hickman: Suggestions for a New Printing Process.—Prof. The Svedberg: Behaviour of the Silver Bromide Particles in Dry Plates towards Light, α and β Rays.

QUERRET MICROSCOPICAL CLUB, at 7.30.

WEDNESDAY, MAY 11.

NEWCOMEN SOCIETY (at Iron and Steel Institute), at 5.—Rhys Jenkins: Rise and Fall of the Sussex Iron Industry (conclusion).

ROYAL SOCIETY OF ARTS, at 6.—A. E. Hayes: Phonoscript: A New Method in the Phonetic Teaching of English Pronunciation.

ROYAL MICROSCOPICAL SOCIETY (Metallurgical Section), at 7.30.—G. Patchin: The Application of Microscopy to the Metal Industry.

INSTITUTION OF AUTOMOBILE ENGINEERS (at Institution of Mechanical Engineers), at 8.

THURSDAY, MAY 12.

ROYAL INSTITUTION OF GREAT BRITAIN, at 3.—Dr. C. S. Myers: Psychological Studies: (2) The Appreciation of Music.

INSTITUTE OF PATHOLOGIST AND RESEARCH (St. Mary's Hospital, Paddington), at 4.30.—Sir James Mackenzie: The Opportunities of the General Practitioner are Essential for the Investigation of Disease and for the Progress of Medicine.

ROYAL SOCIETY, at 4.30.—*Probable Papers*.—G. W. Walker: The Problem of Finite Focal Depth revealed by Seismometers.—E. A. Griffiths: A Liquid Oxygen Vaporiser.—Dorothy M. Palmer and W. G. Palmer: Some Experiments on the Catalytic Reduction of Ethylene to Ethane.—W. G. Palmer: The Catalytic Activity of Copper. Part II.—Prof. J. F. Jenkin and D. N. Shorthose: The Total Heat of Liquid Carbonic Acid.—Dr. A. O. Rankine: The Viscosity and Molecular Dimensions of Gaseous Cyanogen.

LONDON MATHEMATICAL SOCIETY (at Royal Astronomical Society), at 5.

FRIDAY, MAY 13.

ROYAL ASTRONOMICAL SOCIETY, at 5.

PHYSICAL SOCIETY OF LONDON (at Imperial College of Science and Technology), at 5.—L. Hartshorn and E. S. Keeping: Notes on Vacuum Tubes used as Detectors of Electrical Oscillations.—B. W. Clack: The Coefficient of Diffusion of Certain Saturated Solutions.—Dr. G. D. West: Experiments on Thermal Transpiration Currents.

ROYAL SOCIETY OF MEDICINE (Clinical Section), at 5.30.—Annual General Meeting.

ROYAL INSTITUTION OF GREAT BRITAIN, at 9.—Dr. W. Bateson: The Determination of Sex.

SATURDAY, MAY 14.

ROYAL INSTITUTION OF GREAT BRITAIN, at 3.—Prof. E. C. C. Baly: Chemical Reaction.

CONTENTS.

	PAGE
Physics a Profession	289
Polar Exploration. By Dr. Hugh Robert Mill	291
Marine Deposits. By Prof. J. W. Gregory, F.R.S.	292
Study of Plants in the Field	293
An Historical Catalogue of Science	294
Maps and Map-reading	294
Our Bookshelf	295
Letters to the Editor:—	
A Comparison of British and German Volumetric Glassware.—Sir J. E. Petavel, F.R.S.	297
Young's Interference Experiment.—Right Hon. Lord Rayleigh, F.R.S.	298
An Addition to the British Fauna (<i>Rhynchodemus Scharffi</i>).—Prof. Arthur Dendy, F.R.S.	298
Method of Cutting Sections of Cotton Hairs.—H. J. Denham	299
An Unknown Organism in Flint. (<i>Illustrated</i>).—C. Carus-Wilsou	299
Ocean Tides.—A. C. Tennant; Prof. J. Proudman	299
The Physical Continuity of "Space."—L. C. W. Bonacina	300
Logs and Antilogs.—R. T. A. I.	300
The Colour of Primrose Flowers.—Major R. O. Latham; The Writer of the Article	301
The Resonance Theory of Hearing.—Dr. W. Perrett	301
Biological Terminology.—Dr. F. A. Bather, F.R.S.	301
Experimental Geometry.—Dr. Norman R. Campbell	301
Italian Meteorites.—Prof. W. M. F. Petrie, F.R.S.	301
The Centenary of Napoleon. By Erg.-Comdr. Edgar C. Smith, O.B.E., R.N.	302
The Annular Eclipse of April 8 (<i>Illustrated</i>). By Major W. J. S. Lockyer	303
The Royal Academy. By J. S. D.	305
Obituary:—	
Mr. Bertram Blount	306
Notes	306
Our Astronomical Column:—	
Reid's Comet	311
Photographic Catalogue of the Globular Cluster Messier 15	311
A Photo-electric Study of Algal	311
The Inauguration of the Institute of Physics	312
The British Science Guild	313
Early Chronology of Sumer and Egypt	315
Imperial Forestry Education	315
University and Educational Intelligence	316
Calendar of Scientific Pioneers	317
Societies and Academies	317
Books Received	319
Diary of Societies	319



THURSDAY, MAY 12, 1921.

Editorial and Publishing Offices:

MACMILLAN & CO., LTD.,

ST. MARTIN'S STREET, LONDON, W.C.2.

Advertisements and business letters should be
addressed to the Publishers.

Editorial communications to the Editor.

Telegraphic Address: PHUSIS, LONDON.

Telephone Number: GERRARD 8830.

The Potash Position.

THE situation of Great Britain as regards a due supply of potash is again attracting attention, and the present moment may be looked upon as opportune for briefly reviewing its leading features. Potash is one of the essential requirements of a country like our own; it is used in many ways, mainly in various branches of chemical industry, in glass manufacture, and in agriculture, its application in the last-named being by far the most important. Thus it has been estimated that in 1913 the world's consumption of potash (calculated as K_2O) was about 1,000,000 tons for agricultural purposes, as against 135,000 tons for all other purposes. Before the war this consumption was supplied entirely by Germany, chiefly from the mines situated in Germany proper—namely, Stassfurt, Brunswick, Hanover, etc.—and to a much smaller extent from the mines in Alsace, then subject to Germany. All these mines were in German hands, controlled by the Potash Syndicate, which deliberately limited the Alsatian output to 5 per cent. of the total, in order to protect the very large capital that had been invested in the North German potash mines. In 1913 the consumption of potash fertilisers (in tons of K_2O) was as follows:—

Germany	536,102
United States	231,689
Holland	43,478
France	33,115
Austria-Hungary	25,073
Russia	24,260
Great Britain	23,410
Other countries	62,955

980,082

In that year German land received just about eight times as much potash per acre as did land in this country; it is true that our needs are less in this respect than are those of Germany, first, because our land is on the average much heavier than that cultivated in Germany, thus needing less potash, whilst it appears also to be richer naturally in potash; and, secondly, because some of the crops, such as potatoes, grown in Germany on a far larger scale than here, require more potash. In spite of this, however, there seems little doubt that this country could use with great advantage very much larger quantities of potassic manurial agents than it has done in the past.

Given the raw materials, the preparation of the various finished products is relatively a simple operation so far as chemical manufacture is concerned, so that the question whence we are to obtain the necessary supplies of potash can be answered only by a study of the natural sources available. Before the war these came, as has been seen, wholly from the vast deposits of potassium-bearing salts under German control. Since the recovery by France of the lost provinces of Alsace-Lorraine, our Ally has now resumed possession of the Alsatian potash deposits. These deposits are far more important than their restricted production under the German *régime* would have implied. They underlie an area of some 200 square kilometres, lie relatively flat at a depth of some 600 metres, are up to 4 metres in thickness, and are estimated to contain about 1500 million tons of crude potash salts. In their mode of occurrence, therefore, they present very great advantages over the steep-lying, contorted North German deposits, which lie beneath heavily watered strata, and can be won only by means of difficult and costly methods of shaft-sinking. Above all, the Alsatian deposits are immensely superior in chemical composition to their North German competitors; they are much richer in potash, for whereas the German crude salt averages about 10 or 12 per cent. of K_2O , the French deposits contain a proportion that is variously stated as between 18 and 25 per cent. of K_2O ; moreover,

the former contain a large proportion of magnesian chloride, whilst the latter are practically free from this objectionable impurity.

In addition to the Alsatian and German deposits, a number of other deposits are known. There are deposits in Galicia, which have been worked in a small way for some years, as also at Erythrea, in Italy, and the existence of a number of others that have not yet been worked has been recorded. It appears that the recently discovered deposits in Catalonia, Spain, are likely to prove quite important. In several parts of the world lakes rich in potash salts have been worked—e.g. in Tunis, in Chile, and in the United States. Those in the last-named country occur in Central Nebraska, and produced salts carrying 40,000 tons of K_2O in 1918, the producing capacity being estimated at 50,000 tons, or about one-half of the total producing capacity of the entire United States.

In this country the only practically available source of supply is the flue-dust from blast-furnaces. It has long been known that this dust contains potash, but the amount was small, and, worse still, very variable, depending largely upon the working of the blast-furnace. As the result of a number of experiments initiated by Mr. K. M. Chance, of the British Potash Co., Ltd., it was discovered that by adding a small proportion of salt to the blast-furnace charge, practically all the potash present could be volatilised as chloride and recovered in the flue-dust. Messrs. Rossiter and Dingley investigated for the above company the percentages of potash in a large number of iron-ores, and published their results in November, 1919, in the *Journal of the Society of Chemical Industry*. The ores richest in potash are the bedded ironstones of Secondary age, such as those of Northamptonshire, Cleveland, Lincolnshire and Oxfordshire, which showed respectively 0.42 per cent., 0.36 per cent., 0.36 per cent. and 0.30 per cent. of potash. When salt is added to the charge of a blast-furnace smelting these ores, flue-dusts are obtained that contain about 30 or 35 per cent. of K_2O as chloride or other water-soluble salts. Such dust is, therefore, considerably richer in potash than the ordinary manurial salts hitherto supplied from Germany, and it seems probable that it could be applied direct to the land with very beneficial results, though not much work has as yet been done in this direction.

The experiment of adding salt to the blast-furnace charge has as yet been tried in only a few works, and the bulk of the dust thus produced

appears to have been worked up for potash salts at the works of the British Potash Co., Ltd., at Oldbury. In the paper already referred to, it is calculated that if the salt process were adopted in every blast-furnace in Britain, potash equivalent to 50,000 tons of K_2O could be recovered annually. This figure is about double that of the British consumption of potash for agricultural purposes before the war, but falls far short of the amount that we really require in this country, whilst it need scarcely be said that nothing even remotely approaching it has as yet been produced, nor does there appear to be the slightest prospect of reaching it for many years to come.

In the meantime, British agriculture needs potash and needs it most urgently. Agriculture is the most vital of our industries, and when the process of destroying our coal-mining industry, and with it our manufacturing industries generally, now apparently in full swing, has been consummated, it will be the only means by which the inhabitants of these islands can continue to exist. It would appear, therefore, that the best policy in our national interests is to help our French Allies to develop as speedily as possible the potash resources of their recovered province, and to obtain from them the supplies of potash which our lands, neglected in this respect during the war, so sorely need. Of course, the potash-bearing blast-furnace flue-dust would continue to be worked up, as it is at present, for the manufacture of high-grade salts of potash, and no doubt it would be able to supply a certain proportion of the British consumption of such salts, and to this extent decrease our imports.

Human Palæontology.

Les Hommes Fossiles: Eléments de Paléontologie Humaine. By Prof. Marcellin Boule. Pp. xi+491. (Paris: Masson et Cie, 1921.) 40 francs net.

ON opening the covers of this magisterial work by Prof. Marcellin Boule, one has the feeling of having entered a court of justice where a severe judge has conveyed to counsel and to witnesses that his cases are to be tried according to the strict law of evidence, and that he will stand no nonsense. All the cases on which is based our conception of the antiquity and origin of man come up for review; judgments are duly given in such clear, unmistakable terms that they carry with them an air of finality. For example, there is the case for eoliths—whether they have been fashioned by the hand of man or by Nature;

the judge listens to what Sir E. Ray, Lankester and Mr. T. Reid Moir have to say for the worked flints from the Pliocene deposits of East Anglia. A decided verdict is given against them, because, so the judge asserts, it is impossible to tell Nature's handiwork from that of man! For the learned judge that ancient stone culture known to experts as Chellean, which many archæologists regard as marking a high point in man's skill as a worker in flint, is the earliest that can be attributed to human hands. He admits that there must be preceding and more primitive stone cultures, but Prestwich and Harrison, and also M. Rutot who has espoused the cause of eoliths "by the publication of an avalanche of pamphlets," were, and are, gravely in error.

Then the famous Piltdown case comes up; our eminent geologist, Dr. Smith Woodward, finds himself very severely handled by our equally eminent geological judge. Our British colleague is censured, in the first place, for giving the name *Eoanthropus*—"dawn man"—to the being discovered by Mr. Charles Dawson at Piltdown; this name, in the judge's opinion, should have been reserved for the early pygmy humanoid form which he expects may turn up any day. Here our learned judge leans on the case of the horse's evolution as a precedent, but it would be well for the reader to remember that the evolutionary histories of men and horses are not on "all-fours," or even on "all-twos." In the second place, Dr. Smith Woodward is censured for creating a new genus of mankind by fitting the lower jaw of an extinct chimpanzee to a human skull. Therein our judge follows the lead of Prof. Waterston and of Dr. Gerrit Miller. The latter has even given a name to the owner of the Piltdown mandible—*Pan vetus*. Prof. Boule does not like the American way of naming chimpanzees, and so has rechristened the supposed real owner of the mandible, *Troglodytes Dawsoni*! Nor are these all the points in the Piltdown verdict; Dr. Smith Woodward, it seems, in spite of his ultra-caution, is also in error as to the date at which this chimpanzee-man was, or chimpanzee and man were, alive on our Sussex weald. Dr. Smith Woodward, erring on the side of safety, placed them just before, or at the dawn of, the Chellean culture period; the verdict now delivered is that Dawson's man and Dawson's chimpanzee are later—towards the close of the immense span of time covered by the Chellean period. England had a different configuration then, but all are agreed that at the close of the Chellean, or early in the Acheulean, period our climate was much what it now is. Under such climatic conditions one can understand how Dr. Smith Wood-

ward's *Eoanthropus* eked out a livelihood; but how a chimpanzee succeeded in this feat neither Prof. Boule nor Dr. Gerrit Miller has given us any enlightenment.

An equally erratic judgment is passed on the fossil remains discovered by Dubois in Java. *Pithecanthropus* is declared to be a giant gibbon moving towards the human stem. Verdicts such as these need not be taken so seriously as they are delivered. Even expert geologists, anatomists, and archæologists will have some sense of the humorous situation we have reached in human palæontology. For the benefit of those who keep an anti-Darwinian eye on what is passing in our anthropological courts, it may be well to explain that Prof. Boule is a convinced believer in the truth of evolution, is certain that man has descended from a simian form, and is confident that we shall find his ancestry in Miocene or earlier deposits. He admits, too, that modern man is more closely related to anthropoid apes than these are to Old World monkeys. The dispute turns on the particular route by which man has travelled to his present estate. The only evidence which will serve as guide has to be gleaned by a long and arduous study of the anatomy of Primates, and, with all due deference to our eminent French colleague and to Dr. Gerrit Miller, it is the opinion of the reviewer that neither the one nor the other has shown competence in this respect.

It is true that Prof. Boule denounces as utterly untrustworthy the Cuvierian axiom—namely, that any animal form may be reconstructed from a single bone; and yet when he comes to the mandible found at Piltdown—a bone showing exactly the same degree of fossilisation as an adjacent skull, of a size to fit the skull, with a texture and structure of bone in keeping with the skull, but with certain features in the mandible itself and in the teeth which are to be seen in the lower jaws of chimpanzees, and also other features which are not—he promptly forgets all about the falsity of Cuvier's axiom, and creates a new species of chimpanzee to get rid of the difficulties with which the Piltdown discovery has confronted him. He forgets, too, that on an adjoining page, when giving his verdict on the Heidelberg mandible, he states that, had he found the jaw without the teeth, he would have assigned it to an ape, but that, had he come across the teeth without the jaw, he would have supposed them to be human. If only the frontal bone of Neanderthal man were known, it would undoubtedly be assigned to a gorilla with a big brain, because it is provided with a great gorilla-like supraorbital

ridge. The time has come which Darwin foresaw must come. He anticipated that, as our discoveries approach the point of human departure from a simian stock, doubts must arise as to whether we are dealing with ape-like men or man-like anthropoids, so great must be their mixture of simian and human features. This is the point we have reached in *Pithecanthropus* and in *Eoanthropus*, and Prof. Boule has bungled the diagnosis in each case.

Much as we regret to differ from our distinguished French colleague, we own to an open liking for his frank verdicts and to a fellow-sympathy for some of his human failings. He passes the most severe censure on those who venture to reckon the length of geological periods in years, but presently we find that he himself is a fellow-sinner, and gives 125,000 years as a round figure for his Pleistocene period—which begins with the extinction of *Elephas meridionalis*—and that about 10,000 years have elapsed since the Ice age ended. Then, again, he will have nothing to do with genealogical trees of man's descent; but anon we find him guessing just as hard as any of us. He admits that the tree that can be most easily "defended" is one which brings man's phylum off from the root-stock of the anthropoid apes; but all the same he is inclined to go rather deeper for a beginning—to the stock from which anthropoids and Old World monkeys arose—the Darwinian point of departure. Then, again, he expresses the utmost surprise that such a distinguished man of science as Prof. H. Fairfield Osborn should countenance the reconstruction of fossil forms of man. On an adjoining page we find quite a daring reconstruction of the face of Neanderthal man, with all the facial muscles dissected out in the most workmanlike manner. In short, we tender the author of this work our sincere homage; we commend it as a very clear and complete compendium of the evidence relating to man's antiquity and origin—with the proviso that the reader must use his own judgment as to the true bearing which the facts here presented have on the problem of man's evolution.

ARTHUR KEITH.

British Scientific Instruments.

Dictionary of British Scientific Instruments.

Issued by the British Optical Instrument Manufacturers' Association. Pp. xii + 335. (London: Constable and Co., Ltd., 1921.) 21s.

THE British Optical Instrument Manufacturers' Association, which is one of the industrial associations working in connection with the Department of Scientific

and Industrial Research, has just issued this very useful dictionary. The main part of the work consists of a list of British instruments arranged alphabetically, with a brief description of each and an indication as to the firm or firms which supply it. Illustrations of a large number of the more important instruments are also included. Some of these are shown in position at the National Physical Laboratory. The utility of the book is obvious; it serves as a dictionary to the inquirer who wishes to know something about an instrument which he hears mentioned in conversation or reads of in a book; it is also a trade handbook, giving the would-be purchaser at a glance information as to where an instrument he desires to acquire can be obtained. This, however, is not all; the volume illustrates in a remarkable way the activities of the trade, the range of instruments of British manufacture, and the debt men of science owe to the instrument maker. The work has been well carried out, the list is very complete, and cross-references are numerous; the definitions or explanations are clear and concise. Thus:—

"*Galvanometer*.—An instrument for measuring electric currents usually by the deflexion of a magnetic needle in the magnetic field created by an electric current, or by the deflexion of a moving coil, carrying the current, in the field of a fixed magnet. There are thus two main types: the moving magnet and the moving coil galvanometer."

Or again:—

"*Hydrometer*.—An instrument for determining the specific gravity of liquids. Attributed to Archimedes, but not much used until it was re-invented by Robert Boyle. It usually takes the form of a narrow sealed instrument of cylindrical section, and consists of three parts—the counterpoise at the bottom; the bulb containing air; and the stem with the scale at the top. Made of glass or gilt brass. In the latter case the hydrometer is usually provided with weights which are slipped over the stem and alter the buoyancy of the instrument so as to adapt it to liquids of various specific gravities."

Useful illustrations of various patterns of galvanometer are given; it is a mistake, however, to spell Sir Wm. Thomson's name with a "p," and the astatic mirror galvanometer figured is one of his.

But there is more in the book than this dictionary. Meteorology, navigation, and astronomy have long been subjects of investigation, and many of the instruments described have been devised in order to facilitate the study of the weather and the stars, or to assist the navigator on the trackless waters. Hence there have been included very

interesting accounts of Greenwich Observatory and the long list of distinguished astronomers to whom British instrument makers owe a large debt; of the Royal Meteorological Society, which for seventy years has fostered the study of meteorology and called forth much skill on the part of the instrument trade; and of the manufacture of optical glass in Great Britain.

This last chapter contains a somewhat sad story. The method of making optical glass was discovered by Guinaud, a Swiss joiner, who lived towards the end of the eighteenth century. It was carried on, but without much success, by Guinaud himself with Fraunhofer at Munich, and by one of his sons working with Bontemps at Choisy-le-Roi, near Paris. In 1848 Bontemps came to England and joined Messrs. Chance at Birmingham, and for some years the Smethwick firm produced most of the optical glass required by opticians throughout the world. Some forty years ago Schott and Abbe joined forces, and, carrying to success experiments commenced in 1834 by Harcourt and Stokes, were able to offer glasses with properties needed by the optician. The German Government realised what optical glass meant in time of war, and did its utmost to help the investigators. Then, as now, no support was given by the British Government to the British firm, just as in 1855, when Sir David Brewster did his best to persuade the Government to buy the pair of 20-in. lenses Messrs. Chance had made, "and construct with them the greatest achromatic telescope ever contemplated by the most sanguine astronomer," but could arouse no interest, and until the war the Jena glasses practically held the field.

The position is somewhat different now. Messrs. Chance and Messrs. Wood, of Derby, make successfully a number of the Jena glasses, and as a consequence of the work carried out in the Research Department three glasses have been manufactured with optical constants rather more extreme than any hitherto available. Still, even now the lesson of the last seven years has not been fully learned, and, in spite of all the promises, a trade vital to the defence of the country seems likely to perish before the Government takes the steps necessary for its support.

"Great Britain is proud," as the authors of the dictionary claim, "of her predominating share in creating the science underlying the manufacture of optical instruments. . . . It is only necessary," they continue, "to mention such names as Newton, Young, Brewster, Herschel, Airy, Dollond, Lister, Maxwell, and Rayleigh to realise to what

a great extent this country has been responsible for the instrument making of the world." The work under review should help, to no small degree, in the realisation of this truth, and the British Optical Instrument Manufacturers' Association is to be congratulated on having brought such a publication to a successful issue.

Text-books of Organic Chemistry.

- (1) *Treatise on General and Industrial Organic Chemistry*. By Prof. Ettore Molinari. Translated from the third (enlarged and revised) Italian edition by T. H. Pope. Part i. Pp. xv + 456. (London: J. and A. Churchill, 1921.) 30s. net.
- (2) *A Text-book of Organic Chemistry*. By Prof. A. F. Holleman. Edited by Dr. A. Jamieson Walker, assisted by Dr. O. E. Mott, with the co-operation of the author. Fifth English edition, completely revised. Pp. xviii + 642. (New York: John Wiley and Sons, Inc.; London: Chapman and Hall, Ltd., 1920.) 18s. 6d. net.

THE two books under review are in a sense complementary, the one being mainly technical and the other theoretical. The author of the first says:—

"Holleman's treatise is confined to a theoretical and systematic exposition of the many organic compounds, the industrial side of the question and the application of these compounds being almost entirely neglected. It is hence difficult for the student to ascertain which of the thousands of substances described are really of practical importance."

It would be interesting to have Prof. Holleman's opinion of Molinari's treatise. Everything depends upon the point of view of the author and upon the class of student for whom he writes. Both books have their good points, and both are deservedly popular. We should, however, be unwilling to put either treatise into the hands of the beginner, who requires something more elementary, more general in scope, and less specialised in treatment. Having obtained a knowledge of fundamental principles, he could then take up Holleman and supplement it with Molinari. No more satisfactory combination could be made; for neither book is complete in itself.

(1) With all its wealth of detail and illustrations of technical operations, it must be admitted that in Molinari's treatise the philosophical method is conspicuous by its absence. This is partly due to

the arrangement, whereby the principles of structure and the various theories connected with the subject are condensed together in the introductory section, together with the essential facts upon which they are based.

Here is an example taken from p. 16:—

“Kekulé, and independently of him Couper [spelt ‘Cooper’], brought to light another most important property of carbon, resulting from its four equivalent valencies. They showed that carbon atoms possess also the property of combining directly one with another.”

No one reading this paragraph without previous knowledge would imagine that a theoretical conception was being put forward to explain certain facts, for none of the facts are forthcoming.

It is difficult enough in ordinary circumstances to impress upon the student the importance of separating his facts and his theories, but where theories and facts are jumbled together in this fashion the task is made well-nigh impossible.

Although the treatise does not profess to take into account industrial progress in the different branches of chemistry or statistical data beyond the year 1913, it is obvious that a large amount of additional information has been introduced—*e.g.* on p. 236 there is an interesting account of “Chemistry and the War,” in which a description is given of the various “poison gases” and their preparation. Moreover, the increase in bulk in vol. ii. (Organic Chemistry) has made it necessary to divide it into two parts.

(2) The number of editions through which Prof. Holleman’s text-book has passed and the variety of languages into which it has been translated afford sufficient evidence of its continued popularity. As previously stated, it is essentially theoretical in character, with passing and rather superficial references to the physical side of the subject. We think the student would be well advised to study this branch of the subject in a special treatise on physical chemistry, where it is treated in a more comprehensive and general fashion. It is impossible for him to obtain adequate information on the physical properties of organic compounds from such scanty descriptions as are given here.

In conclusion, may we suggest that the obsolete glass funnel and cone figured on p. 30 should be replaced by a modern porcelain funnel, and that an alternative and simpler form of melting-point apparatus should be added to the one illustrated on p. 31, which we believe was rarely, if ever, used by its inventor?

J. B. C.

Forestry in the United States.

- (1) *The United States Forest Policy.* By Prof. J. Ise. Pp. 395. (New Haven: Yale University Press; London: Humphrey Milford; Oxford University Press, 1920.) 21s. net.
- (2) *Forest Management.* By Prof. A. B. Recknagel and Prof. J. Bentley, jun. Pp. xiii+269+iii plates. (New York: John Wiley and Sons, Inc.; London: Chapman and Hall, Ltd., 1919.) 13s. 6d. net.
- (3) *Forest Products: Their Manufacture and Use.* By Prof. N. C. Brown. Pp. xix+471. (New York: John Wiley and Sons, Inc.; London: Chapman and Hall, Ltd., 1919.) 21s. net.

(1) **T**HE wise use and the conservation of the wealth of timber still existing in the United States are promoted by a presentation of the history, by a trained economist, of the effects of legislation and Government administration on the ownership and management of American forests from Colonial days to the present time. The author calls it “a story of reckless and wasteful destruction of magnificent forests, and of flagrant and notorious thefts of public lands.” The picture, however, is not so dark as this, though the account of the frauds perpetrated under cover of the Free Timber and the Stone and Timber Acts of 1878, and of even later legislation, is very startling.

The idea of forest conservation is not modern. In 1681 William Penn issued an ordinance which enjoined the preservation of one acre in six of the forests of Pennsylvania, while strict laws against forest fires were passed by many of the Colonies. These early measures proved ineffectual. Real progress began with the Act of 1891, which empowered the President to set aside forest reserves out of the public domain still retained by the Federal Government. This has been the means of creating the National Forests, which now aggregate 176,000,000 acres, under the control of a highly trained Forest Service. This splendid work of conservation has been done in the teeth of tremendous opposition, and even now in some quarters there is continual criticism of the policy and operations of the Forest Service. It is, however, generally admitted that a careful classification of all public lands is necessary, and that only those which are fit for agricultural purposes should be alienated. This principle will preserve the National Forests. Prof. Ise’s treatise is an animated history of the struggle for the conservation of the forests of the United States, and deserves careful perusal by statesmen and economists in our own Dominions and Colonies.

(2) We doubt whether this book is sufficiently elementary to be of service to the private owners and managers of goods for whose use it was intended. A working-plan document, the headings of which take up ten printed pages, will scarcely appeal to the ordinary forester. The book is not a whit simpler than the well-known manual of Schlich, vol. iii., which for many years has been the recognised text-book on forest management in British and Indian forestry schools.

It may, however, supplement that authority to some extent, for it throws light on forestry terms and usages in America—for example, the advanced student will find in it interesting matter concerning subjects like "log-rules" and "stumpage-values." The chapter on "timber-cruising" will be useful to foresters who intend to practise abroad in wild regions where rough-and-ready methods of estimating the value of timber in virgin forests are the only practicable means. The book concludes with an appendix of useful tables.

(3) This volume treats of the main industries which are dependent for their raw materials on the miscellaneous products of the forest, and we welcome it as the first American text-book on this subject. The author spent ten years of investigation and travel in the United States on its preparation, and has incorporated with his own observations much information from scattered reports and papers. A separate chapter is devoted to each industry, ample details being given of raw materials, processes of manufacture, equipment and machinery, costs, utilisation of waste products, etc., interspersed with specifications, tables, and statistics, and concluding with a select bibliography.

The industries described are important, and include wood-pulp and paper, tanning materials, veneers, cooperage, turpentine, wood-distillation, charcoal, boxes, railway sleepers, poles and posts, mining timber, firewood, shingles, maple sugar, dyewoods, excelsior, rubber, and cork.

Prof. Brown's treatise is appropriately illustrated, and replete with accurate information. It will prove useful to foresters and manufacturers generally, and it should be perused by all interested in the economic working of our own woodlands, for it suggests methods by which thinnings, underwood, and waste timber might be utilised.

Our Bookshelf.

The Journal of the Institute of Metals. Vol. xxiv. No. 2, 1920. Edited by G. Shaw Scott. Pp. xiv + 547 + xi plates. (London: The Institute of Metals, 1920.) 31s. 6d. net.

THE latest volume of this journal contains an unusually large number of important papers. The

NO. 2689, VOL. 107]

May lecture by Dr. Benedicks deals with recent work in thermo-electricity, and gives details of the author's discovery of a thermo-electric effect in circuits composed of a homogeneous metal. These results have been published elsewhere, but they are now brought together in a concise and convenient form. The study of crystal growth in metals which have been subjected to cold work, by Prof. Carpenter and Miss Elam, contains many interesting observations. The authors were fortunate enough to find an alloy which preserves a complete record of successive stages of crystal growth on a prepared surface, and this has enabled them to trace, with remarkable clearness, the course of events throughout a variety of conditions. The difficult system of alloys of aluminium and magnesium has been investigated by metallographic methods by Mr. Hanson and Miss Gayler, the results being recorded in the form of an equilibrium diagram presenting several unusual features. A note by Mr. Dickenson, on intercrystalline brittleness produced by the action of fusible metals on brass under stress, contains facts which bear on the nature of brittleness in general, while another note reviews the evidence for the allotropy of zinc. Several papers deal with practical brass foundry questions, and another describes the experience on war vessels with regard to the corrosion of condenser tubes, on which a committee of the institute and other bodies continues to conduct elaborate investigations. The volume contains, as usual, a very large number of abstracts of papers published elsewhere, and mention should be made of the excellence of the numerous plates of photomicrographs.

C. H. D.

The Bahama Flora. By Prof. N. L. Britton and Dr. C. F. Millspaugh. Pp. viii + 695. (New York: The Authors, New York Botanical Garden; London: Dulau and Co., Ltd., 1920.) 37s. 6d. net.

THE first thing which strikes one on opening this flora is the excellent paper, such as one seldom sees on this side of the Atlantic. Prof. Britton's name is a guarantee of the excellence of the work regarded as a flora; and though some who are accustomed to the older floras will probably find comparisons increased in difficulty by the number of splittings of genera that have been made, no one who has worked with tropical plants in the living condition will be likely to question the necessity of this splitting in a great number of cases. This is the first complete and modern flora of the Bahamas, and many people, not realising that the group is a trifle larger than Jamaica, and much larger than all the remaining British West Indian islands, may be surprised to learn that they contain 995 species of flowering plants.

Prof. Britton states that there is no geological evidence that there was ever land connection to the Bahamas, but the evidence of the flora itself points to such a probability. Inasmuch as the flora contains 133 endemic species out of 995, or 13 per cent., the connection must be far back, as

is further indicated by the large proportion of the genera that are also found in Asia—*e.g.* 47 per cent. of the genera of Leguminosæ occur in Ceylon, 42 per cent. of Gramineæ, 30 per cent. of Rubiaceæ. The only endemic genus, on the other hand, is Neobracea, in Apocynaceæ. Taking the families that show genera confined to northern or to tropical America as being the oldest in those regions, one finds them well represented in the Bahamas. Of twenty-nine that have at least twenty genera in each confined to the regions mentioned, all are represented in the Bahamas but Ericaceæ, Gesneraceæ, and Saxifragaceæ. Moreover, they are represented by genera in roughly proportional numbers, the largest ten by 189 genera, the next ten by 85, the next by 42, and so on. Proportional representation like this is hard to conceive if there was never any land connection.

The Gyroscopic Compass: A Non-Mathematical Treatment. By T. W. Chalmers. (The Engineer Series.) Pp. x+167. (London: Constable and Co., Ltd., 1920.) 11s. net.

THE writer of this review read and admired many of the chapters composing this book as they appeared in the *Engineer* during the opening months of last year. The treatment is entirely non-mathematical in the ordinary sense of the term, and the author is to be congratulated on having produced a book which will appeal to all who are interested in gyroscopic action. Moreover, it will be of use to engineers and navigating officers who are responsible for the care of working instruments.

The book begins with an account of elementary gyroscopic phenomena, and this is followed by a clear explanation of the fundamental action of the compass, which, of course, depends on the rotation of the earth, and in no way on the earth's magnetism. The methods of damping out vibrations employed in the various types of instrument in use—the latitude error, north steaming error, the ballistic error, the quadrantal error and its elimination—receive excellent treatment in subsequent chapters. The explanations of the fundamental dynamics involved are clear and sound.

Having explained fully the principles of a gyroscopic compass, the author describes in detail the Anschütz, Sperry, and Brown compasses. The last chapter of the book contains an account of the Anschütz 1912 compass. This sequence is not correct, for in two respects that instrument is a pioneer one.

We have no hesitation in recommending this book. J. G. G.

The Child Welfare Movement. By Dr. Janet E. Lane-Claypon. Pp. xi+341. (London: G. Bell and Sons, Ltd., 1920.) 7s. net.

WITH a birth-rate nearly as low as it has ever been, and an infantile mortality which is capable of reduction by 30 or 40 per mille, the subject of the preservation of child life has

assumed great importance. Dr. Lane-Claypon's book is, therefore, most opportune, and she has compiled a summary of the child-welfare movement which for completeness it would be difficult to equal. All aspects seem to have been dealt with, and little has been omitted. This very completeness, however, entails the inclusion of a mass of detail which tends to make the book dull reading.

The author rightly emphasises the importance of the breast-feeding of infants, and discusses in an adequate manner artificial substitutes. We are inclined to think that she deprecates unduly the value of milk as a food for older children. While it is true that up to a point other and cheaper foods may take its place, the valuable vitamine content of milk renders it a food second to none, particularly in these days when the cheaper vegetable margarines, which contain no fat-soluble A, have to take the place of butter. Moreover, the milch cow gives a much higher return for the energy-value of her food than does the beef steer.

We also think that Dr. Lane-Claypon unduly minimises the incidence and effects of venereal diseases on child life, and we have failed to find any reference to the effects of employment and factory life on the expectant mother.

Appendices occupy nearly 100 pages, and include specimens of leaflets, recording cards, and summaries of various Acts, Orders, circulars, and schemes connected with child welfare.

Tuberculosis and Public Health. By Dr. H. H. Thomson. Pp. xi+104. (London: Longmans, Green, and Co., 1920.) 5s. net.

THIS little book gives a concise summary of the problem of tuberculosis in relation to public health. While written primarily for the medical profession, the text for the most part is non-technical, and it should prove of value to non-medical readers who are interested in, or may have to deal with, tuberculosis. The matter is up-to-date; for instance, Brownlee's researches on the different types of pulmonary tuberculosis existing in the British Isles are referred to.

The author rightly points out the difference in infectivity of the open and closed classes of cases, an appreciation of which simplifies the measures to be taken to prevent the spread of infection. The schemes of treatment and of the care and control of patients outlined are very much to the point, and constitute an adequate summary on these important subjects. In dealing with diagnosis, a number of useful hints are given on the examination of the chest, the tuberculin reaction, and other aids.

When discussing the tubercle bacillus the author suggests that it may have a cycle of existence outside the body, and lays stress on the possible spread of tuberculosis among cattle by the fouling of pasture, etc., with the infected excreta of tuberculous beasts. R. T. H.

Letters to the Editor.

[The Editor does not hold himself responsible for opinions expressed by his correspondents. Neither can he undertake to return, or to correspond with the writers of, rejected manuscripts intended for this or any other part of NATURE. No notice is taken of anonymous communications.]

Earthworms Drowned in Puddles.

I HAVE long been familiar with the frequent occurrence of dead earthworms in surface "puddles" alongside gravel walks or roads, as described by Mr. Friend in NATURE of April 7, p. 172. I have supposed that they were "drowned" owing to the amount of free oxygen in the stagnant puddles being insufficient for their respiration. So far as I recollect, earthworms are not drowned (or, at any rate, not quickly) if they get into cool, clear, running water—which, presumably, contains a larger amount of dissolved free oxygen than does the rain-water accumulated about dead leaves and deoxidising or "reducing" mud. (See on this matter Darwin's "Vegetable Mould and Earthworms," pp. 13-16.) I confess that I do not know the facts as to the percentages of free oxygen and of oxygen-seizing matter in natural fresh-waters, or, indeed, in sea-water, in various circumstances; nor do I know the percentage of free oxygen necessary in water in order that it may—even for the brief period of an hour or two—support the life of an earthworm. I should be glad to know if these quantities have been determined. It is a common practice to kill earthworms for dissection by drowning them, but I think the water used is warmed. Many years ago I employed "normal saline solution" in the dissecting trough.

The respiration of the earthworm is carried out through the fine capillaries in the skin, which exposes a moist surface like that of a "lung" to the atmosphere. It is abnormal for it to be out of contact with atmospheric oxygen, even in the deepest burrows made by the worm. The abundant hæmoglobin in the blood of the earthworm must be kept charged with oxygen by its rapid passage through the extremely delicate capillaries of the skin, separated only from the atmosphere (as is the blood in the capillaries of a lung) by a moist membrane of extreme tenuity. How far this lung-like surface of the earthworm's body can suddenly take on the function of aquatic respiration is a question which some naturalist with a laboratory to work in should determine.

There are one or two striking facts in this connection which deserve consideration. First, there are numerous aquatic "water-breathing" Oligochaeta closely allied to the earthworm, but they are not capable of aerial respiration as an alternative. Some of them inhabit black, foul mud at the bottom of ponds, but, as a rule, they inhabit well-aerated waters. The commonest of them all, *Tubifex rivulorum*, is extremely sensitive to the lowering of the percentage of dissolved oxygen in the water in which it lives. A handful of some thousands of these worms, if placed (with a little river-mud) in a basin standing on a "sink" under a tap giving a small stream into the basin which overflows into the sink, will group themselves in a definite order, their heads downwards and their tails free and undulating in a constant rhythm, the blood-vessels in the tails thus carrying on active respiratory gas-exchange. They will flourish thus, grow, and reproduce (by eggs) for months! But if the flow of fresh, oxygen-holding water from the tap is shut off the rhythmic movement ceases, the worms separate and exhibit spiral contortions. They die in

the course of a few hours if the flow of water be not renewed, but when it is they at once recover and regroup themselves. I suppose (but have no further evidence) that they are as sensitive to the arrest of their normal aquatic respiration by loss of oxygen-carrying water as the earthworm is to the arrest of its normal aerial respiration by submersion.

On the other hand, it seems that one, at any rate, among our fresh-water worms is fairly tolerant of both the alternative conditions.

The "medicinal leech" (not to mention other leeches, such as *Trocheta viridis* and the numerous land-leeches) can live for many days out of water in "moist" surroundings, and also flourishes in submergence. The integument in the leech and the subjacent structures are firmer, and yet more elastic, than in the earthworm; and (as I showed nearly forty years ago) the branches of a very fine network of capillaries containing hæmoglobinous oxygen-seeking blood are actually distributed *between* the individual units of the single layer of cells which forms the epidermis. This brings them even closer to the atmospheric oxygen than in the earthworm. It seems that the leech shows the possibility of the same surface acting for either aquatic or aerial respiration. The exchange of the one respiratory medium for the other, without change in the respiratory organ, is exhibited by certain pulmonate Gasteropods allied to *Limnæus*, which in the Lake of Geneva inhabit deep water and take water into the lung-cavity. Conversely, the gill-chamber of some Gasteropods (*Cyclostoma*) becomes converted into a lung, as is also the case in various fishes liable to conditions of drought.

The presence, and also the absence, of hæmoglobin in the blood and in certain tissues of animals have an important relation to the special adjustment of various invertebrate animals to peculiar difficulties and requirements in regard to the supply of oxygen needful for respiration. I cannot in this letter even state the case adequately. For many years, by use of the microspectroscope, I have accumulated facts as to the distribution of hæmoglobin, but what is now especially needed is experiment and quantitative measurement to determine what is the significance of the presence of hæmoglobin in each case. To cite only a few cases, we ought to ascertain:—

(1) What *exactly* is the function of the hæmoglobin dissolved in the striped muscular tissue of vertebrates?

(2) What is its value in the muscular tissue of the lingual apparatus of all Gasteropods and Cephalopods, though otherwise absent from those animals?

(3) What is the explanation of the single exception to the rule as to glossophorous molluscs just stated, namely, the exceptional presence of abundant hæmoglobin dissolved in the rich red blood of the flat-coiled pond-snail (*Planorbis*), although it is absent from the blood of the common pond-snail (*Limnæus*) and of all other Gasteropods and Cephalopods? Again, what is the special value of hæmoglobin in the blood (in the form of red blood-corpuscles) of *Ceratisolen legumen*, whilst it is entirely absent from the common razor-fish (*Solenensis*) and from every tissue in practically all other Lamellibranchs excepting *Arca* and *Pectunculus*, which have (as has *Ceratisolen*) red hæmoglobinous blood-corpuscles like those of a frog?

(4) What is the physiological significance of the fact that all Hexapod insects of all kinds are totally devoid of hæmoglobin in any of their tissues, excepting the so-called "blood-worm" or larva of the Dipterous midge, *Chironomus*, in which the blood-fluid (not corpuscles) is richly coloured by it?

(5) Similarly, why of all the great tribe of Crustacea are the archaic *Apus* (which has blood as red as

that of a vertebrate) and a few water-fleas the only members possessing even a trace of hæmoglobin, excepting one marine fish-parasite (*Lernanthropus*)?

(6) The only common feature in the "conditions of life" or environment of these exceptional cases of the presence of hæmoglobin is that some of them, viz. the *Planorbis* snail, the larval *Chironomus*, and the crustacean *Apus*, live in stagnant fresh-water, even in black mud, where free oxygen is scarce owing to the decomposition of vegetable debris. But in what special way and to what extent is the hæmoglobin valuable to its possessors, seeing that other closely related species are associated with them and are devoid of hæmoglobin?

(7) One more case must be noted, namely, the very common presence of hæmoglobin in the blood-fluid of the *Chaetopod* worms, both marine and fresh-water, whilst, nevertheless, it is absent from many. In some of these worms "red blood-corpuses" replace the entire vascular system and its red fluid; they float in the coelomic fluid. In one case, that of the large and beautiful marine worm, *Aphrodite* (the "seamouse"), whilst hæmoglobin is absent from the blood, it is present in such quantity in the nervous tissue of the great nerve-cord as to give it a ruby-red colour. It also gives a pale pink colour to the great muscular pharynx. In what way does the sluggish *Aphrodite* benefit by having its nerve-cord saturated with the oxygen-seizing hæmoglobin? Similarly, some few of the remarkable *Nemertine* worms have hæmoglobin in the corpuses which float in the fluid of certain vessels, and others have it only in the tissue of the nerve-cord and brain.

To conclude, we might, it seems to me, arrive at some better understanding of the general physiology of respiration in animals were the cases I have cited more accurately (I mean *quantitatively*) investigated; and were the striking facts also held in view, that no Protozoon, no Sponge, and no Coral or Polyp is known to develop "hæmoglobin," whilst in only one starfish and one *Holothurian* (recent additions to the list may have escaped my attention) has hæmoglobin been recorded, and that in the form of "red blood-corpuses."

E. RAY LANKESTER.

44 Oakley Street, Chelsea, S.W.3, May 3.

A "New" Type of Tool of Mousterian Age.

THE object of this letter is to describe briefly a hitherto unrecognised type of implement of Mousterian age and to ask readers of *NATURE* for any information they can give me as to its geographical distribution.

Considerable collections of flint—or, more correctly, chert—implements of Palæolithic types were made by myself in 1914, and by Mr. G. W. Murray, of the Survey of Egypt, in the following years. My own specimens are from the western desert, Mr. Murray's from sites discovered by himself in the eastern desert. Both series show a number of tortoise cores of Mousterian age—the age determined not only by type, but also the discovery by myself of a typical core in a hard cemented gravel recognised by Dr. Hume as of Pleistocene age—which have been worked up to produce a type of tool which, so far as I can discover, has not been recognised previously. Before describing this form of implement I must point out that typically domed tortoise cores are not common in Egypt; most cores are flatter, presumably because the nodules from which they were made were oval rather than spherical, and are so trimmed as to have, roughly, the shape of a half of a somewhat

flattened pear, the notch indicating the point at which the core is struck being situated at the broad end of the pear.

Regarding the face of the core from which a Levallois flake has been struck as the upper surface, the "new" tool consists in the production at the narrow end of this surface of an upturned point or beak. In its simplest form this is produced by the meeting at the narrow end of the core of the two planes (or facets) bounding the flake-bed left by the removal of the Levallois flake, and of a facet constituting a third plane, joining these at an angle, produced by striking off a flake from near the point

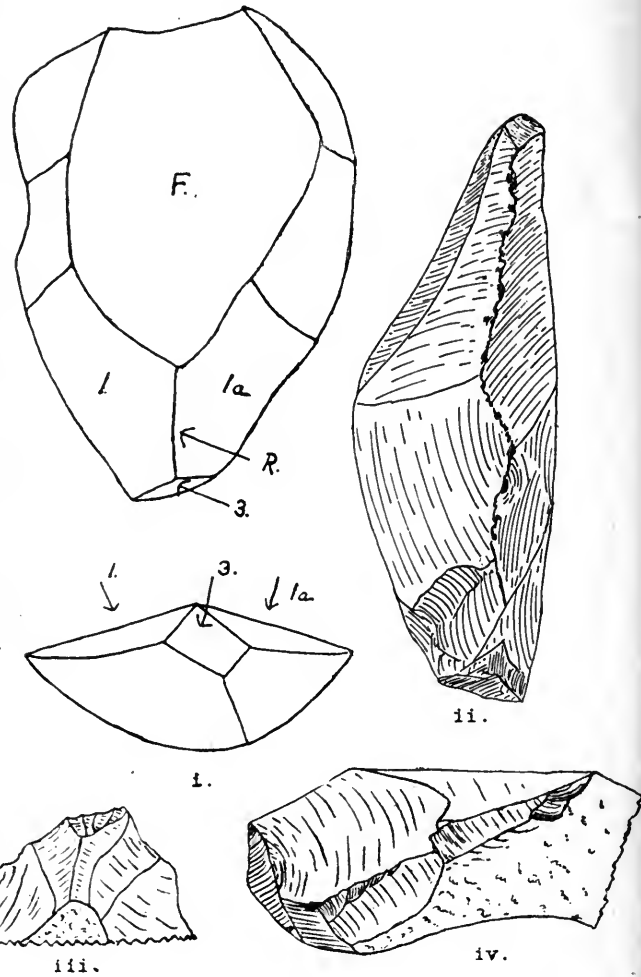

FIG. 1.

of the lower (convex) surface of the core. The diagram (Fig. 1, i.) will make this description clearer; it will be seen that the lower part of the scar-bed of the Levallois flake (F) is bounded by two narrow facets (1 and 1a) the intersection of which gives rise to a crest or ridge (R). This crest and its two bounding facets are terminated abruptly by the facet (3) produced by a blow struck on the convex surface of the stone.

Fig. 1, ii., is a somewhat diagrammatic rendering of the side view of an implement of the type described, and shows the heavy triangular point not unlike the beak of a chelonian, which is characteristic of the

tool. It is for this reason, and not because these points are commonly worked on a tortoise core, that I propose for them the name of "tortoise point." But although the point is triangular in section in typical specimens, it seems that the blow on the convex surface of the core was not always successful, and in these cases matters were improved by a good deal of secondary working, so that points like those shown in Fig. 1, iii., are not uncommon. Further, although the great majority of tortoise points were worked on tortoise cores, the "point" was at times produced independently; thus Fig. 1, iv., reproduces the front part of a roughly bilobed pebble upon which a particularly good tortoise point has been worked.

The form of these tortoise points indicates that they were used as a heavy drawing tool, *i.e.* used with a drawing or dragging motion while the hand exerted considerable pressure. Additional evidence for this view is offered by a certain number of specimens in which the distal portion of the crest, *i.e.* that nearest the point, shows minute abrasions. The only method of holding the implement allowing this that I have been able to discover is to grip the base of the stone between the bent fingers and the ball of the thumb, the convex surface of the tool being towards the palm. The point is then brought in contact with the surface it is desired to cut or grave, the implement being but slightly inclined and drawn steadily away from the body. The suggestion may be made that these tools were used for cutting hides; such a point would furrow or cut a stiff, sun-dried hide, such as those used by the Veddás, just as it does a piece of stout millboard.

This form of implement has not, so far as I can discover, been recognised in Europe hitherto; it is certainly uncommon, for the Abbé Breuil tells me that he does not know of any example. Its existence is, however, suggested by the reproduction by Commont ("Les Hommes Contemporains du Renne dans la Vallée de la Somme," 1914, Fig. 59) of two "instruments moustériens" from the St. Acheul loess, of which one at least seems to represent the "new" implement.

C. G. SELIGMAN.

Foot Baldon, Oxford.

Molecular Structure and Energy.

THE difficulties with the Lewis-Langmuir theory expressed by Prof. Partington in NATURE of April 7 have been felt by the writer, and doubtless by others. They may, perhaps, be met in part by the following considerations:—

(1) In the case of molecules such as carbon dioxide and nitrous oxide the central octet is postulated as tetrahedral, with pairs of electrons at each apex, rather than as cubic. Such an arrangement would diminish rigidity in the axis passing through the three atomic nuclei and permit a measure of rotational energy about this axis. Again, it must be recalled that at higher temperatures the ratio of the specific heats for even diatomic gases falls below 1.4, and that this can well be accounted for by the increasing importance of energy of intramolecular vibration—that is, to-and-fro oscillation of the component atoms. In the case of triatomic gases such as carbon dioxide, the specific heat is much more affected by rise of temperature than in diatomic gases, frequencies of vibration in this case corresponding doubtless to the three well-marked spectral bands of carbon dioxide in the infra-red. For this reason alone the value of γ for carbon dioxide might well be expected to turn out, even at ordinary temperatures, lower than that anticipated for a gas with molecules exhibiting only two degrees of rotational freedom, provided that

vibrational energy in this case is not negligible at ordinary temperatures in comparison with translational and rotational energies. The halogen gases consist of pairs of atoms sharing, according to the Lewis-Langmuir theory, only one pair of electrons, which acts as though it were located at a point. It is worth pointing out that this less rigid connection permits the ratio of the specific heats for these gases to fall well below 1.4 even at ordinary temperatures, in consonance with the above suggestion.

(2) In the case of nitrogen the specific heat data offer no difficulty if, as may be inferred from the models of Langmuir and of Sir J. J. Thomson, the positive nuclei in their ovoid electronic envelope are sufficiently far apart to allow an appreciable moment of inertia in two directions of rotation.

As the writer has already hinted elsewhere, however, an acetylenic type of union of the two octets concerned may indeed prove more satisfactory in explaining other facts, such as those of molecular dimensions as estimated by Perrin or Rankine or such as will be brought forward in a forthcoming publication from this laboratory by R. N. Pease.

ALAN W. C. MENZIES.

Princeton University, U.S.A., April 19.

British Laboratory and Scientific Glassware.

THE inclusion of scientific glassware in the proposed Key Industries Bill seems to have aroused a sense of apprehension in some quarters, partly on the ground that if Continental products are prohibited users may not be able to procure satisfactory apparatus, and partly because it is feared that, if given comparative security in the home market, manufacturers may lose their incentive to improve the quality of their goods and increase prices unduly.

The lack of confidence in British chemical glassware expressed in certain quarters is probably due to unfortunate experience with some of the earliest productions of the industry, when the experience of the blowers was practically negligible and the demand for the goods so urgent that nothing usable was allowed to be sorted out.

Increased experience, both on the part of the actual glass-blowers in the manipulation of the glass and on that of the technical staffs in the methods of obtaining desired results, has achieved great improvement in the quality of the products, and the better classes of British laboratory glassware compare favourably with any other.

As regards the quality of the glass itself, very thorough tests have been made by a trustworthy and impartial authority (see Journal of the Society of Glass Technology, 1917, vol. i., p. 153), and in the conclusions arrived at appears the statement: "Taking all the tests into consideration, the six best glasses are B, C, D, E, F, and G, and this list includes all the British glasses in the market. . . . *Jena glass, A, comes seventh on the list.*" Samples of post-war Jena laboratory ware with the well-known "Schott" stamp are inferior in all but appearance to the pre-war goods.

Further scientific investigation into the problem of annealing laboratory glassware and the adaptation by manufacturers of the information so obtained have led to great improvement in the direction of reduced liability to cracking in use due to temperature differences. This was formerly a frequent cause of complaint, but methods of annealing now in use are so efficient that British laboratory glassware will fulfil any reasonable requirements.

The average standard of British graduated apparatus is distinctly higher as regards accuracy of

graduation than similar pre-war German articles. The British firms manufacturing scientific glassware are controlled by trained men of science who have had long practical experience in the use of the articles produced and appreciate fully the essential features of particular pieces of apparatus.

Manufacturers are desirous of meeting the requirements of consumers so far as possible, and if users of chemical apparatus would acquaint manufacturers directly with their special requirements and difficulties or offer practical suggestions for improvement, further advances might soon be made.

The advances that have already been made can be maintained and extended only if some measure of security is afforded to manufacturers. Up to date the industry has been largely in the experimental stage, and manufacturing costs have consequently been high. Manufacturers are faced with competition by imported glassware which is frequently sold under cost price in order to regain the British market. This, together with the present rates of exchange, deprives them of any incentive to put down fresh plant or to design new furnaces specially adapted to the manufacture of scientific glassware, which would render the products at the same time cheaper and of better quality.

The British manufacturer should have an opportunity in reasonable security to develop under normal conditions the industry he established with such success in the stress and strain of the war period. Should there ever be another war it is certain that the extension of "chemical warfare" would be on a scale far greater than anything experienced in the late war, and the position of this country would indeed be hopeless if it were dependent on imports for supplies of essential scientific and laboratory glassware. There would not again be an opportunity given for the industry to be re-created in time to be efficient.

J. H. DAVIDSON.

(Messrs. Wood Bros. Glass Co., Ltd.)

Barnsley, April 13.

Protozoa and the Evolution of the Gregarious Instinct.

In the *résumé* given in NATURE of April 14, p. 222, of the proceedings of the Academy of Sciences of Paris on March 21, mention was made of the observation by Mme. Anna Drzewina and G. Bohn that certain aquatic animals (*Convoluta* and the larvæ of *Rana fusca*) become grouped together and appear to emit a protective substance as a defence against toxins introduced into the water. That the congregating of protozoa in such circumstances had a protective value of this nature was suggested by me in a note to *Country-Side* (August, 1913, vol. v., No. 8, p. 541), where I pointed out that the combined effort of a number of organisms massed together would no doubt produce a greater antitoxic effect than could a single isolated organism surrounded on all sides by water containing toxin.

The grouping of protozoa can easily be observed if a slide be prepared of living infusoria such as are found during warm weather in flower-vases and examined under the microscope, when it will be found on applying a little vinegar to the edge of the cover-slip that these organisms become arranged in clumps or clusters, each individual being in a state of vigorous vibration. As is well known, a similar phenomenon occurs with bacteria under somewhat the same conditions, and is made use of as a diagnostic test by pathologists. Agglutination in such circumstances is usually regarded as a purely physical occurrence due to surface tension.

NO. 2689, VOL. 107]

It appears probable that the crowding together of protozoa as a protection against toxins represents the dawn of a gregarious instinct. Many modern psychologists are in agreement that evolution of body and evolution of mind are parallel; that is certainly the case with the nervous system and the mind of the higher vertebrates. We should, therefore, expect to find in the simplest animals the beginnings of mind; and purposive behaviour—the characteristic of mental activity as distinct from purely psychochemical reaction—has already been shown to occur in certain protozoa by Jennings and others (Jennings, "Behaviour of the Lower Organisms," Columbia University Biological Series, 1906). Animals the behaviour of which is purely upon the instinctive plane, e.g. instincts, are provided with innate dispositions tending to their own self-preservation and to the preservation of their race. On the part of protozoa, protection against toxins in the water is a necessary precaution that has to be taken to safeguard the individual, and therefore grouping together to produce antitoxins may have been an early mode of purposive behaviour in the first living organisms, when toxins in the water in which they lived must have been one of the chief dangers besetting them in the absence of larger enemies. Probably, then, we have in this crowding together of protozoa the dawn of the gregarious instinct—the beginnings of that instinct seen in so many different groups of the animal series and terminating in its most highly evolved and complex form as a fundamental element in the formation of human society.

REGINALD JAMES LUDFORD.

Zoological Laboratory, University College,

London, April 21.

The Nature of Vowel Sounds.

PROF. SCRIPTURE'S arguments on this subject which appeared in NATURE for January 13 and 20 last seem to me to be open to criticism. It is true, no doubt, that a strongly damped resonator may be excited by periodic impulses even when its free period is not an exact submultiple of the period of the impulses. But it does not appear justifiable to argue from this that the vibration so excited is inharmonic to the fundamental period. As an illustration of the error in the argument, we may consider the somewhat analogous case of the vibrations of the resonator of a violin. The bridge, belly, and enclosed air of this instrument form a resonating system having a series of free modes of vibration, which, especially those of higher pitch, are strongly damped by reason of the communication of energy to the external atmosphere and otherwise. These free periods are, in general, inharmonic to the fundamental period of the string. It is easily shown from the known mode of action of the bow that the force exerted by the vibrating string on the bridge changes impulsively from a positive to a negative value once in each period. If Prof. Scripture's argument were valid, we should be entitled to argue that the response of the bridge and belly to these discontinuous changes of force should be inharmonic to the fundamental period of the string. Actually, however, we know that this is not the case. The overtones which fall near the free periods of the resonator are, no doubt, strongly reinforced, but the motion of every part of the violin continues to be in strictly harmonic relation to the period of the forces impressed by the bow.

So far as I can see, there is no very vital difference between the dynamical principles involved in this and

the foregoing case, except that the body of the violin has four or five well-marked free periods instead of only one or two, as in the case of the resonator concerned in the production of the human voice. The special character of the vowel sounds really arises from the last-mentioned circumstance, as a result of which most of the energy is concentrated in a small group of partials. It seems to me that there is no justification for supposing that there are any "inharmonics" present in the voice tones.

C. V. RAMAN.

210 Bowbazar Street, Calcutta, March 29.

IN reply to Prof. Raman's interesting letter, I may say that the response of a strongly damped resonator to a series of sharp impulses may be harmonic or inharmonic to the period of the impulses; the essential fact is that they are independent. If we knew nothing more of the vowels than that the exciting voice tone consists of a series of sharp puffs and that the vocal resonators are strongly damped, we could say nothing of their relations except that they might be anything. The analyses of the vowel curves show, in fact, that the cavity tones may hold any relations to the voice tone, both harmonic and inharmonic.

With the violin the case is different. The string does not produce sharp puffs, but continuous vibrations of alternating phases. During each phase the action on a resonator is constant. The vibration aroused in the resonator has no pause in which to die away. The resonance vibrations are thus forced, and not free, vibrations. They must be harmonic to the fundamental. This is clearly shown in the plot reproduced from Prof. Miller's book in NATURE for March 3 last. The fundamental is strong and the overtones are all harmonic. This is in contrast to Prof. Miller's plot for a vowel. The fundamental is apparently absent; the overtones form a queer group of discordant tones that can represent only an inharmonic in that region.

E. W. SCRIPTURE.

Literature for Jerusalem University.

AT the third annual conference of the Inter-University Jewish Federation held at Oriol College, Oxford, on August 3, 1920, it was unanimously resolved, in response to a request of the Zionist Organisation, to render every possible assistance to all efforts on behalf of the Hebrew University at Jerusalem. The most urgent need at the present juncture is an immediate and abundant supply of books for the Jerusalem University library. We can conceive no cause more precious and commendable than the full development and firm consolidation of the intellectual and spiritual resources of the Jewish national home. To this end books are the first requisite. In a scarcity of books the mind of a people is denied free expansion and healthy growth. To Jews, with their love of learning, the lack of books is most distressing. In Palestine, unfortunately, there is a real book famine, and even with help from all over the world it will need a great effort to build up the present University library of about 40,000 volumes into an up-to-date library worthy of the Jewish University.

For various reasons, including the difficulty of obtaining sufficient funds to establish a complete university from the start, it is proposed to institute research departments as the first foundations of the University. These will include institutions for

chemical, microbiological, and medical research to deal with the resources of Palestine and its special difficulties. Books on physics and mathematics, sets of scientific journals, and pamphlets of permanent value are especially required; good text-books of established repute will also be useful. Readers of NATURE have it in their power to render great assistance in supplying these scientific books and pamphlets.

Considering that this is an important step towards a spiritual revival of Palestine, and that our credit as an enlightened people is at stake, we appeal to readers of NATURE to send all the books that they can spare as a freewill offering to those who will treasure them in Palestine. A single book will be welcome, but it is hoped that donors will send as many as they can. Gifts of books may be sent either direct to the University Library, Jerusalem, or to Miss N. Mandler, 75 Great Russell Street, W.C.1, who will, if necessary, arrange for the collection of the books. An artistically designed book-plate, the generous work of Mrs. L. Pilichowski, will permanently record the names of the donors.

S. ALEXANDER,

Chairman.

ISRAEL M. SIEFF,

Treasurer.

D. B. STANHILL,

Hon. Secretary.

Jerusalem University Library Committee,

75 Great Russell Street, W.C.1, April 29.

Waste Oil from Ships.

IN the *Landmark* for May Sir Arthur Shipley has a very timely and important article on "The Danger to Fish and Bird Life from Oil-driven Ships." I could add my testimony in support of his argument, but wish now to raise the question whether, as he states, "nothing can prevent the oil getting into the bilge." When I was recently at Funchal, Madeira, I visited H.M.S. *Dunedin*, of the Light Cruiser Squadron, and was shown the oil-burning engines and many other wonderful things. I raised the question of the injury caused by the oil, and was assured that there was no loss of oil in the *Dunedin*, and that leakage, when it occurred, was due to faulty construction. If this is true, the remedy is obvious; it is intolerable that so much damage should result from preventable causes, and the public is entitled to protection. In any event, all those interested in the matter should urge the engineers to attack the problem at once, and show us what to do to abate the nuisance.

T. D. A. COCKERELL.

4 College Road, Isleworth, Middlesex.

Organism in Flint.

IS not the organism photographed under the care of Mr. C. Carus-Wilson (NATURE, May 5, p. 209) far more probably a radiolarian than an insect? The apparent segmentation of the "antennæ" may be due to secondary deposits of silica, and the partition may be caused by the nearness of the plane of section to the inward bulge on the meeting-line of the two chambers of the test. Without an examination of the slide, any suggestion may be rash; but we know little of the Mesozoic types of Cyrtida, and this organism may represent a previously undescribed member of that group. References to descriptions of Cretaceous radiolaria are given by W. Hill and A. J. Jukes-Browne in the Quarterly Journal of the Geological Society, vol. li., p. 600, 1895.

GRENVILLE A. J. COLE.

Isotopes and Atomic Weights.¹

By DR. F. W. ASTON.

POSSIBLY the most important generalisation in the whole history of chemistry is the atomic theory put forward by John Dalton in 1803, and it is a striking tribute to the shrewd intuition of that observer that of his five postulates only one seems to be in the least degree faulty, and more than a century of active and unremitting investigation has been necessary to detect the flaw in that.

The postulate in question states that "atoms of the same element are similar to one another and equal in weight." Of course, if we take this as a definition of the word "element," it becomes a truism; but, on the other hand, what Dalton meant by an element and what we understand by the word to-day is a substance such as hydrogen, oxygen, chlorine, or lead, which has unique chemical properties, and cannot be resolved into more elementary constituents by any known chemical process. For many of the well-known elements Dalton's postulate still appears to be strictly true, but for others, probably the majority, it needs some modification.

The general state of opinion at the end of last century may be gathered from the following quotations from Sir William Ramsay's address to the British Association at Toronto in 1897:

There have been almost innumerable attempts to reduce the differences between atomic weights to regularity by contriving some formula which will express the numbers which represent the atomic weights with all their irregularities. Needless to say, such attempts have in no case been successful. Apparent success is always attained at the expense of accuracy, and the numbers reproduced are not those accepted as the true atomic weights. Such attempts, in my opinion, are futile. Still, the human mind does not rest contented in merely chronicling such an irregularity; it strives to understand why such an irregularity should exist. . . . The idea . . . has been advanced by Prof. Schützenberger, and later by Mr. Crookes, that what we term the atomic weight of an element is a mean; that when we say the atomic weight of oxygen is 16, we merely state that the average atomic weight is 16; and it is not inconceivable that a certain number of molecules have a weight somewhat higher than 32, while a certain number have a lower weight.

That such conjectures were then regarded as wildly speculative shows how strong was the faith in Dalton's postulate, which is all the more remarkable when we consider that at that time not one single direct experimental proof of it had been offered. Such proof, obviously, can be obtained only by some method which measures the masses of atoms individually, and at that time none had been developed.

The first direct evidence that the atoms of an element were, at least approximately, equal in mass appears to be that obtained by Sir J. J. Thomson in 1910 by his well-known method of analysis of

positive rays. The fact that sharply defined parabolic streaks were obtained at all proves that the ratio of the masses of the separate particles causing them to the charges of electricity they carry is constant. The latter was known to be a definite unit, or a simple multiple of it, so that if the masses of the individual atoms varied amongst each other in an arbitrary manner, an indistinct blur would result instead of a clear-cut parabola.

Before going on to consider the evidence of positive rays in greater detail, it will be as well to re-state briefly the evidence upon which the theory of isotopes was founded. The first indication that it might be possible to obtain substances having identical chemical properties, but different atomic weights, was afforded by the brilliant researches on the radio-active elements made by Sir E. Rutherford and his colleagues. Investigations on the transformations of the different radio-active families showed that certain products, such as lead, could be formed in several ways. Each of the leads so formed was found to have chemical properties identical in every respect with those of ordinary lead, but their method of production precluded any possibility of them all having the same atomic weight. Such bodies, although having different atomic weights, must occupy the same position in the periodic table of the elements, and on this account have been called "isotopes" by Prof. Soddy.

Moseley's epoch-making discovery has shown us that chemical properties depend, not upon atomic weight, but upon something much more fundamental, namely, *atomic number*. The atomic number of an element is the number of units of positive electricity on the nucleus of its atoms; the nuclear charge of hydrogen is 1, of helium 2, of lithium 3, and so on. We see, therefore, that isotopes are elements having the same atomic number, but different atomic weights.

The theory of isotopes was triumphantly vindicated during the war by the researches of Soddy, Richards, Hönigschmid, and others on the atomic weights of lead found in various radio-active minerals. Quantities were obtainable which were ample for the most accurate determinations by chemical methods, and the atomic weights were found to differ from each other and from ordinary lead by quantities altogether outside possible experimental error. Long before this convincing proof was forthcoming, the theory of isotopes was discussed with the greatest interest in connection with atomic weights in general. If isotopes occurred among the heavy elements, why should they not be possible among the lighter non-radio-active ones, in which case elements with fractional atomic weights might clearly be mixtures, the constituents having atomic weights equal to whole numbers? This explanation was a very attractive one, for the

¹ Discourse delivered at the Royal Institution on Friday, February 11.

curious jumble of whole numbers and fractions in the atomic weights when referred to oxygen as 16 has always been a serious stumbling-block in the way of any simple theory of atom-building. The accurately determined atomic weight of chlorine, 35.46, has certainly nothing to recommend it. It is reminiscent of the number of square yards in a square rod, pole, or perch; but the idea of Nature working on the same lines as the British weights and measures is eminently unattractive.

The first support of the isotope theory among non-radio-active elements was given by the anomalous behaviour of the inactive gas neon when analysed by Sir J. J. Thomson's method of positive rays. It is of interest to note that the announcement was made in this room by Sir J. J. Thomson himself, and that the first sample of gas to show the effect was supplied by Sir James Dewar. This peculiarity was that whereas all elements previously examined gave single, or apparently single, parabolas, that given by neon was definitely double. The brighter curve corresponded roughly to an atomic weight of 20, the fainter companion to one of 22, the atomic weight of neon being 20.20. In consequence of reasoning adduced from the characteristics of the line 22, the discoverer was of the opinion that it could not be attributed to any compound, and that therefore it represented a hitherto unknown elementary constituent of neon. This agreed very well with the idea of isotopes which had just been promulgated, so that it was of great importance to investigate the point as fully as possible.

The first line of attack was an attempt at separation by repeated fractionation over charcoal cooled with liquid air, but, even after many thousands of operations, the result was entirely negative. It is some satisfaction to know that this result was inevitable, as Prof. Lindemann has recently shown on thermodynamical grounds. Fractional diffusion through pipeclay was more effective, and gave a positive result. An apparent difference of density of 0.7 per cent. between the lightest and heaviest fractions was obtained after an exceedingly laborious set of operations. When the war interrupted the research, it might be said that several independent lines of reasoning pointed to the idea that neon was a mixture of isotopes, but that none of them could be said to carry the conviction necessary in such an important development.

When the work was recommenced, attention was again turned towards positive rays, for it was clear that if an analysis could be made with such accuracy that it could be demonstrated with certainty that neither of the two atomic weights so determined agreed with the accepted chemical figure, the matter could be regarded as settled. This could not be done with the parabolas already obtained, but the accuracy of measurement was raised to the required degree by means of the arrangement illustrated in Fig. 1. Positive rays are sorted out into a thin ribbon by means of the

two parallel slits $S_1 S_2$, and are then spread into an electric spectrum by means of the charged plates $P_1 P_2$. A portion of this spectrum deflected through an angle θ is selected by the diaphragm D and passed between the circular poles of a powerful electromagnet O the field of which is such as to bend the rays back again through an angle ϕ more than twice as great as θ . The result of this is that rays having a constant mass (or, more correctly, constant m/e) will converge to a focus F, and if a photographic plate is placed at GF, as indicated, a spectrum dependent on mass alone will be obtained. On account of its analogy to optical apparatus, the instrument has been called a positive-ray spectrograph, and the spectrum produced a mass-spectrum.

Fig. 2 shows a number of typical mass-spectra obtained by this means. The numbers above the lines indicate the masses they correspond to on the scale $O=16$. It will be noticed that the displacement to the right with increasing mass is

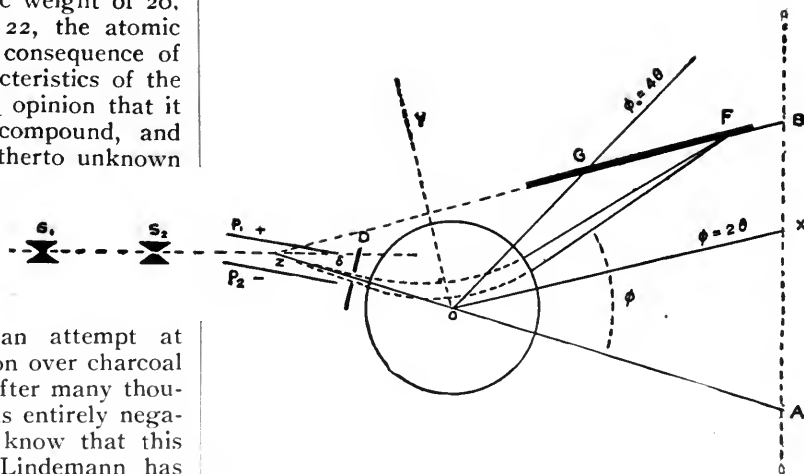

FIG. 1.—Diagram of positive-ray spectrograph.

roughly linear. The measurements of mass made are not absolute, but relative to lines which correspond to known masses. Such lines, due to hydrogen, carbon, oxygen, and their compounds, are generally present as impurities, or purposely added, for pure gases are not suitable for the smooth working of the discharge tube. The two principal groups of these reference lines are the C_1 group due to $C(12)$, $CH(13)$, $CH_2(14)$, $CH_3(15)$, CH_4 or $O(16)$, and the C_2 group (24 to 30) containing the very strong line C_2H_4 or $CO(28)$. These groups will be seen in several of the spectra reproduced, and they give, with the CO_2 line (44), a very good scale of reference.

It must be remembered that the ratio of mass to charge is the real quantity measured by the position of the lines. Many of the particles are capable of carrying more than one charge. A particle carrying two charges will appear as having half its real mass, one carrying three charges as if its mass were one-third, and so on. Lines due to these are called lines of the second

and third order. Lines of high order are particularly valuable in extending our scale of reference.

When neon was introduced into the apparatus four new lines made their appearance at 10, 11, 20, and 22. The first pair are second-order lines, and are fainter than the other two. All four are well placed for direct comparison with the standard lines, and a series of consistent measurements showed that to within about one part in a thousand the atomic weights of the isotopes composing neon are 20.00 and 22.00 respectively. Ten per cent. of the latter would bring the mean atomic weight to the accepted value of 20.20, and the relative intensity of the lines agrees well with this proportion. The isotopic constitution of neon seems, therefore, settled beyond all doubt.

These rays are formed by a normal, positively charged ray picking up two electrons. On the negative spectrum of chlorine only two lines, 35 and 37, can be seen, so that the lines at 36 and 38 cannot be due to isotopes of the element. These results, taken with many others which cannot be stated here in detail, show that chlorine is a complex element, and that its principal isotopes are of atomic weight 35 and 37. There may be, in addition, a small proportion of a third of weight 39, but this is doubtful. Spectra II., III., and IV. show the results with chlorine taken with different magnetic field strengths.

The objection has been raised on many occasions that if chlorine consists of isotopes, how is it that its atomic weight has been determined so

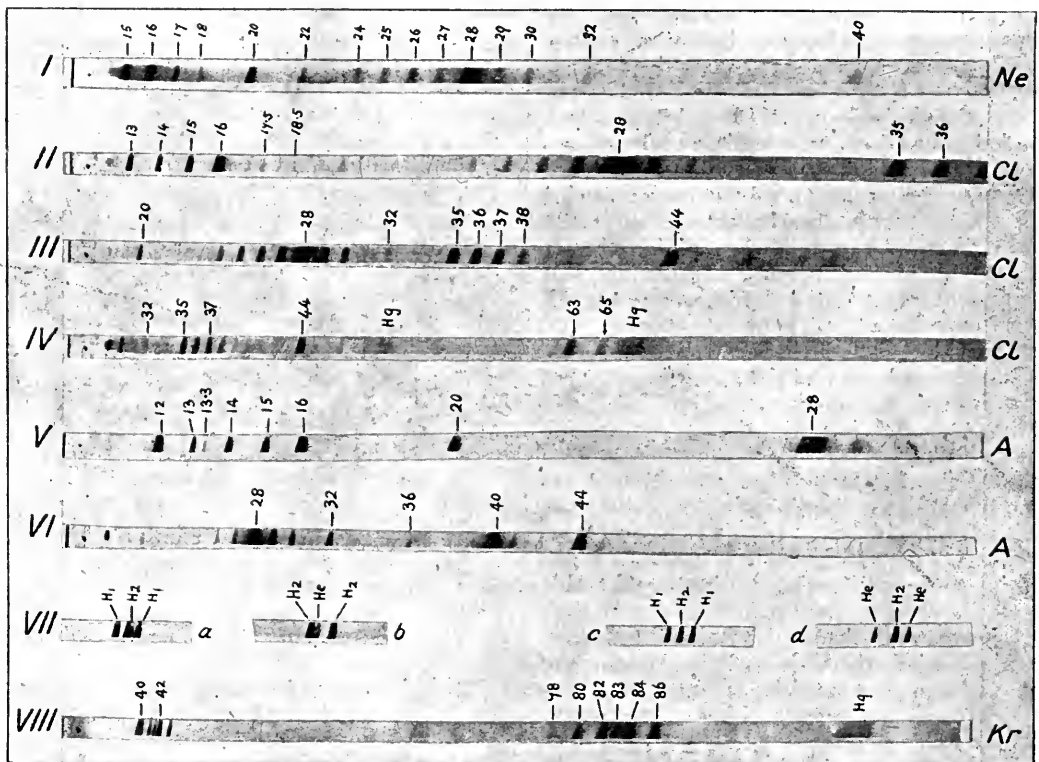

FIG. 2.—Typical mass-spectra.

The element chlorine was naturally the next to be analysed, and the explanation of its fractional atomic weight was obvious from the first plate taken. Its mass-spectrum is characterised by four strong first-order lines at 35, 36, 37, 38, with fainter ones at 39, 40. There is no sign whatever of any line at 35.46. The simplest explanation of the group is to suppose the lines 35 and 37 are due to the isotopic chlorines, and lines 36 and 38 to their corresponding hydrochloric acids. The elementary nature of lines 35 and 37 is also indicated by the second-order lines at 17.5, 18.5, and also, when phosgene was used, by the appearance of lines at 63, 65, due to COCl^{37} and COCl^{35} .

Quite recently it has been found possible to obtain the spectrum of negatively charged rays.

accurately and so consistently by different chemists? The obvious explanation of this appears to be that all the accurate determinations have been done with chlorine derived originally from the same source—the sea—which has been perfectly mixed for æons. If samples of the element are obtained from some other original source, it is quite possible that other values of atomic weight will be determined, exactly as in the case of lead.

The mass-spectrum of argon shows an exceedingly bright line at 40, with second-order line at 20, and third-order line at 13.3. The last is particularly well placed between known reference lines, and its measurement showed that the triply charged atom causing it had a mass 40.00 very

exactly. Now the accepted atomic weight of argon is less than 40, so the presence of a lighter isotope was suggested. This was found at 36, and has now been fully substantiated; its presence to the extent of about 3 per cent. is sufficient to account for the mean atomic weight obtained by density determinations.

The elements hydrogen and helium presented peculiar difficulties, as their lines were too far removed from the reference lines for direct comparison. By means of a special "bracketing" method, moderately accurate values were obtained. Helium appears to be exactly 4 on the oxygen scale, but hydrogen is definitely greater than unity. The value obtained agrees very well with that already arrived at by chemical methods—namely, 1.008. At the same time, measurements of the 3 line, first observed by Sir J. J. Thomson, were made which came out at 3.024, satisfactorily proving it to be due to triatomic hydrogen.

Krypton and xenon gave surprisingly complex results, the former consisting of six isotopes 78, 80, 82, 83, 84, 86. The weights of these could be determined with great accuracy by means of the excellent second- and third-order lines they gave. The first experiments with xenon led to the observation of five isotopes, the provisional values of which were given as one unit too low. Owing to the kindness of Prof. Travers and Dr. Masson, I have recently been enabled to repeat the analysis with gas much richer in xenon. With this the second-order lines could be observed and measured. The five principal isotopes of xenon are 129, 131, 132, 134, 136; there is apparently a faint sixth component at 128, and a doubtful seventh at 130.

Experiments with boron fluoride indicated that boron has at least two isotopes, 10 and 11, and that fluorine is a simple element of atomic weight 19.

Silicon is another unmistakably complex element having two isotopes, 28 and 29, with a possible additional one, 30.

Bromine was of great interest. As it has an atomic weight almost exactly 80, it might reasonably be expected to be simple and an isobare of one of the kryptons; actually it consists of equal parts of 79 and 81.

Sulphur, phosphorus, and arsenic are all apparently simple elements. Mercury is certainly complex, though its closer components cannot be resolved with the present apparatus. Its very characteristic groups are seen as high as the fifth order, and appear on nearly all the spectra taken. The group consists of a continuous succession of lines forming a band 197 to 200, a strong line at 202, and a weak one at 204. Recently at Copenhagen Brönsted and Hevesy have succeeded in partially separating the isotopes of mercury by a fractional distillation at extremely low pressure. They give as their figures for the densities compared with normal mercury as unity:—

Condensed mercury 0.999980
Residual mercury 1.000031

NO. 2689, VOL. 107]

The probable error claimed is less than one part in a million.

Selenium, tellurium, antimony, and tin have all been used in the discharge tube, with no results of any value. This is unfortunate, for the atomic weight of selenium, 79.2, suggests that one of its isotopes must be an isobare of bromine or krypton; also the relation between tellurium and iodine is of great interest.

Iodine, fortunately, gave a very definite result. It is a simple element of atomic weight 127. This is rather surprising, for all the theoretical papers on the isotopic constitution of elements have predicted a complex iodine. Prophecy in physics becomes a difficult trade when experimental results produce these surprises, and apparently the only really trustworthy prediction is that there are plenty more in store for us.

The following is a list of elements and isotopes determined to date:—

Table of Elements and Isotopes.

Element	Atomic number	Atomic weight	Minimum number of isotopes	Masses of isotopes in order of their intensity
H	1	1.008	1	1.008
He	2	3.99	1	4
B	5	10.90	2	11, 10
C	6	12.00	1	12
N	7	14.01	1	14
O	8	16.00	1	16
F	9	19.00	1	19
Ne	10	20.20	2	20, 22, (21)
Si	14	28.30	2	28, 29, (30)
P	15	31.04	1	31
S	16	32.06	1	32
Cl	17	35.46	2	35, 37, (39)
A	18	39.88	2	40, 36
As	33	74.96	1	75
Br	35	79.92	2	79, 81
Kr	36	82.92	6	84, 86, 82, 83, 80, 78
I	53	126.92	1	127
X	54	130.32	5, (7)	129, 132, 131, 134, 136, (128, 130?)
Hg	80	200.60	(6)	(197-200), 202, 204 (Numbers in brackets are provisional only.)

By far the most important result of these measurements is that, with the exception of hydrogen, the weights of the atoms of all the elements measured, and, therefore, almost certainly of all elements, are whole numbers to the accuracy of experiment—namely, about one part in a thousand. Of course, the error expressed in fractions of a unit increases with the weight measured, but with the lighter elements the divergence from the whole-number rule is extremely small.

This enables the most sweeping simplifications to be made in our ideas of mass. The original hypothesis of Prout, put forward in 1815, that all atoms were themselves built of atoms of protyle, a hypothetical element which he tried to identify with hydrogen, is now re-established, with the modification that the primordial atoms are of two kinds—atoms of positive and negative electricity.

Although the latter unit has long been known

to us as an "electron," its mate, which appears to be the real unit of mass, has only recently been given the name of "proton."

The Rutherford atom, whether we take Bohr's or Langmuir's development of it, consists essentially of a positively charged central nucleus around which are set planetary electrons at distances which are great compared with the dimensions of the nucleus itself. As has been stated, the chemical properties of an element depend solely on its atomic number, which is the charge on its nucleus expressed in terms of the unit charge e . A neutral atom of an element of atomic number N has a nucleus consisting of $K+N$ protons and K electrons, and around this nucleus are set N electrons. The weight of an electron on the scale we are using is 0.0005, so that it may be neglected. The weight of this atom will, therefore, be $K+N$, so that if no restrictions are placed on the value of K any number of isotopes is possible.

The first restriction is that, excepting in the case of hydrogen, K can never be less than N , for the atomic weight of an element is always found to be equal to, or greater than, twice its atomic number. The upper values of K also seem to be limited, for, so far, no two isotopes of the same element have been found differing by more than 10 per cent. of its mean atomic weight; the greatest numerical difference is eight units in the case of krypton. The actual occurrence of isotopes does not seem to follow any law at present obvious, though their number is probably limited by some condition of stability.

Protons and electrons may therefore be regarded as the bricks out of which atoms have been constructed. An atom of atomic weight m is turned into one of atomic weight $m+1$ by the addition of a proton *plus* an electron. If both enter the nucleus, the new element will be an isotope of the old one, for the nuclear charge has not been

altered. On the other hand, if the proton alone enters the nucleus, and the electron remains outside, an element of next higher atomic number will be formed. If both these new configurations are possible, they will represent elements of the same atomic weight, but with different chemical properties. Such elements are called "isobares," and are actually known among the radio-active elements.

The case of the element hydrogen is unique, for its atom appears to consist of a single proton as nucleus with one planetary electron. It is the only atom in which the nucleus is not composed of a number of protons and electrons packed exceedingly close together. Theory indicates that when such close packing takes place the effective mass will be reduced, so that when four protons are packed together with two electrons to form the helium nucleus this will have a weight rather less than four times that of the hydrogen nucleus, which is actually the case.

It is not to be supposed that the whole-number rule is of exact mathematical accuracy, for the unit of the oxygen scale is a "packed" proton + an electron, and its value will certainly alter slightly with the degree of packing. On this account it is of the greatest importance to push the accuracy of methods of atomic weighing as far as possible, for variations from the whole-number rule, if they could be determined with precision, would give us some hope of laying bare that innermost of secrets, the actual configuration of the charges in the nucleus.

The results I have described lie on the borderline of physics and chemistry, and although as a chemist I view with some dismay the possibility of eighteen different mercuric chlorides, as a physicist it is a great relief to find that Nature employs, at least approximately, standard bricks in her operations of element-building.

Natural Camouflage.¹

THE fine volume under notice is a new edition of the beautifully illustrated work which, originally appearing in 1909, first brought in a connected form before the public the many classical principles of concealing-coloration established by the genius of the American artist-naturalist Abbott H. Thayer. Important discoveries such as these, especially when the enthusiasm of their originator could recognise well-nigh no limits to their application, were bound to bring sharp differences of opinion. In America we have seen the rise of two rival camps, one, headed by the late Theodore Roosevelt, opposing the whole of Thayer's conclusions, the other accepting the whole and even interpreting the

advertisement of Warning Colours and their simulation in Mimicry as examples of the working, in one form or another, of concealing-coloration.

In England, where, as the result of the writings of Wallace and Bates, and still earlier of Erasmus Darwin, the subject as a whole is older, an intermediate position has been taken. Here, naturalists recognise to the full the enduring value and fundamental importance of Thayer's discoveries, although believing that they do not offer a complete interpretation of animal colouring as a whole; and, in the beautiful frontispiece of the book, representing a peacock in the woods with its blue neck against the sky and posed so as to illustrate the conclusion that its pattern is "a marvellous combination of 'obliterative' designs, in forest-colors and patterns," in this and the flamingoes, and spoonbills with "the skies they picture" (plates viii-x), English naturalists

¹ "Concealing-Coloration in the Animal Kingdom. An Exposition of the Laws of Disguise through Colour and Pattern: Being a Summary of Abbott H. Thayer's Disclosures." By Gerald H. Thayer. With an Introductory Essay by A. H. Thayer. New Edition with a New Preface. Illustrated by Abbott H. Thayer and Others, and with Photographs. Pp. xix+260+xvi plates. (New York: The Macmillan Co.; London: Macmillan and Co., Ltd., 1918.) 25s. net.

believe that they witness the attempt to carry a theory too far, and a tendency to be blinded, by the dazzling brilliancy of one set of interpretations, to the value and importance, and even the existence, of others.

The author's conclusion that all pattern is obliterative does not conflict with the theory of

such forms are easily seen and avoided by enemies which respect their special modes of defence, it is clearly an advantage to be as far as possible concealed from those which do not respect them" (Trans. Ent. Soc., 1903, p. 573).

The author's interpretation of the black-and-white pattern of the skunk will be sufficiently clear when Figs. 2 and 3 are compared, Fig. 2 being the "mouse's or cricket's view" with the sky let down, as it were, into the pattern, and leaving a black shape unrecognisable as an animal, while Fig. 3 shows the "sky 'background' cut off by dark, making his white conspicuous." To this interpretation it may be objected that it is very doubtful how far a nocturnal animal like the skunk requires to be hidden from its prey, but there is no doubt that it is advantageous for it to be concealed from enemies which mean to attack, and these, so far as I know, are only predaceous birds which would see it from above against the ground. From these the obliterative effect at a great distance of the

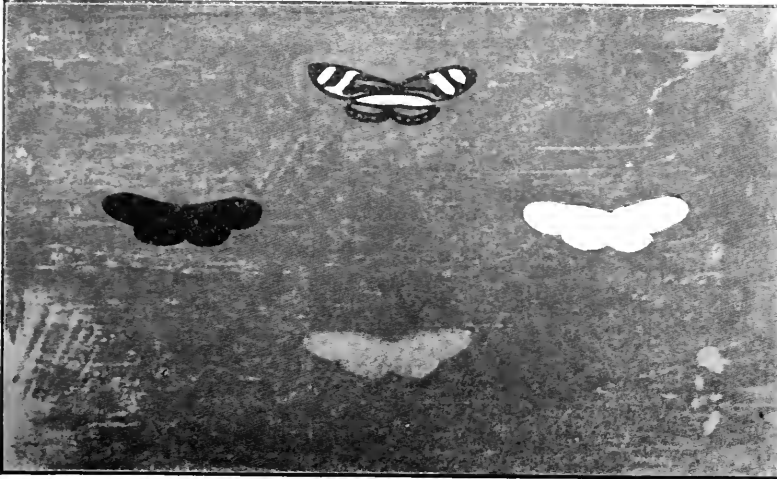

FIG. 1.—At a distance of seven or eight yards in bright light or at a shorter distance with less illumination, the brightly patterned butterfly disappears before the three butterflies of monochrome tint. From "Concealing-Coloration in the Animal Kingdom."

Warning Colours if we bear in mind that obliteration is dependent on distance. This is well shown in Fig. 1, where, as the author states, at the right distance or in a sufficiently reduced light, the brightly patterned butterfly disappears before the three monochrome ones, even the dimmest. We see here the effacing effect of "contrasted juxtaposed color-notes," and are led to understand the inconspicuousness of the zebra as described long ago by Sir Francis Galton, and to conclude that it is this rather than "background-matching," as maintained on pp. 135-36, which is the bionomic meaning of its remarkable pattern. But, returning to the butterfly diagrams, it is obvious that anywhere near the striking distance of an enemy the contrasted colour scheme is far more conspicuous than the other three, and this is all that the theory of Warning

Colours requires. That it should be obliterated at a greater distance is all to the good, for, as the present writer has maintained, "all animals with warning colours have enemies, all are liable to special attacks, in times of exceptional hunger, by enemies which would at other times neglect them. . . . Provided



FIG. 2.—Mouse's or cricket's view of the common skunk; photographed outdoors from a stuffed skin. From "Concealing-Coloration in the Animal Kingdom."

Colours requires. That it should be obliterated at a greater distance is all to the good, for, as the present writer has maintained, "all animals with warning colours have enemies, all are liable to special attacks, in times of exceptional hunger, by enemies which would at other times neglect them. . . . Provided

remembered in association with their display and the special protection of which it is an advertisement.

Although I am unable to agree with these and some other conclusions of the authors, and have been obliged to devote so much of the available space to criticism, I should wish again to em-

phasise the far-reaching importance of the principles which they have clearly explained and beautifully illustrated. It is to be hoped that the volume will be widely and carefully read. Considering the scale and style of the work, with its



FIG. 3.—Common skunk as in Fig. 2, but with sky "background" cut off by dark, making his white conspicuous; photographed outdoors from a stuffed skin. From "Concealing-Coloration in the Animal Kingdom."

sixteen coloured plates and 140 black-and-white figures, the price is very moderate.

The appearance of this new edition is, as is explained by Gerald H. Thayer in his preface, related to the great part which its principles have

played in the war. That they should have been collectively named "camouflage" is a curious instance of word-history. "Camouflage" is not to be found in Murray's Oxford Dictionary, but "camouflet" is there, with this meaning: "a mine containing a small charge of powder, placed in a wall of earth between the galleries of besieged and besieger, so as, in exploding, to bury, suffocate, or cut off the retreat of the miner on the opposite side; a 'stifler.'" "*Camouflet or stifler*" is quoted from the "Penny Cyclopædia" of 1836. Then, when smoke came to be employed above ground it kept the same name; and, as its chief use was to act as a concealing screen or curtain, "camouflage" became, in the Great War, transferred from the cause to the effect, and extended to concealment, however attained.

G. H. Thayer states that it has recently come to light that, in Germany, the original edition was "searched through with most diligent care for information which could be put to military or naval use." Here in England its principles were applied long before the war, for many years ago the great guns in our coast forts were painted white beneath to neutralise their shadows, and coloured above with an obliterative pattern. But while all this was done for the guns our men were sent to the war with a cap that seemed specially designed, by its reversal of principles explained in this volume, to render the head conspicuous to an enemy. E. B. P.

Obituary.

PROF. W. R. BROOKS.

PROF. W. R. BROOKS was one of the most successful of all modern comet-hunters. He nearly equalled the wonderful success of Pons, who found twenty-eight comets in the first twenty-five years of last century. Prof. Brooks's total was twenty-seven comets, but in regard to several of these he was anticipated.

Prof. Brooks was born at Maidstone, Kent, on June 11, 1844, and with his parents migrated to the United States in 1857. He was educated in various public and private schools in England and America. He was awarded the Hon. A.M. degree by Hobart College in 1891, and the Sc.D. by Hamilton College in 1898. He was director of Redhouse Observatory, Phelps, New York, from 1872 to 1888, and was appointed to the Smith Observatory in the latter year; finally he became in 1900 professional astronomer at Hobart College Observatory.

As a discoverer of comets Prof. Brooks was rivalled only by Prof. E. E. Barnard during the years from 1881 to 1911. Some of the comets detected by him during his unwearied sweeps of the heavens were of considerable importance. Thus he was the first to find, in 1883, Pons's periodical comet of 1812, and in 1886 he picked up the expected comet of Olbers, last seen in 1815; he also discovered comets of short periods belonging to the Jovian family in 1886 and 1889. The

latter broke up into several fragments and proved quite a notable object.

Like Messier, Pons, Tempel, Barnard, Perrine, and others, Prof. Brooks displayed special ability in this field of observation, and though he engaged in other departments of practical astronomy, it was in exploring the sky for comets that he met with his greatest successes. His results afford another instance of the fact that natural ability combined with enthusiasm, opportunity, and well-directed effort usually bring ample reward.

Prof. Brooks received ten gold prizes from Mr. Warner, and nine comet medals from the Astronomical Society of the Pacific; he also received the Lalande medal from the Paris Academy of Sciences, and a number of other special distinctions. He was elected a fellow of the Royal Astronomical Society on January 13, 1888. His discoveries ranged over the thirty years from 1881 to 1911, but it was during the first twenty years of this period that his principal work was done.

There was nothing in his early life or associations to lead Prof. Brooks to the pursuit of astronomy except his inclination. His initial success in making a reflecting telescope and in finding new comets enabled him to relinquish his daily avocation and to devote the greater part of his life to the study of the heavens. He died on May 3 in his seventy-seventh year.

W. F. DENNING.

THE death occurred in January this year, at seventy-five years of age, of DR. JULES HARMAND, who was well known for his extensive explorations in French Indo-China. In 1873 Dr. Harmand took part in the investigations of the ruins of Angkor, in Cambodia. His explorations in subsequent years embraced the basin of the Tonle Sap and the lake of that name, as well as the country between there and Bassac, on the Mekong. In 1877 Dr. Harmand explored the Boloueu plateau in Laos, and succeeded in crossing the mountainous country to Hué, in Annam. These explorations shed much light on the interior of Indo-China, and gained for Dr. Harmand in 1878 the gold medal of the Paris Geographical Society.

Later he entered the diplomatic service and was for many years French ambassador at Tokio. Dr. Harmand was the author of "Domination et Colonisation," published in 1910, and he prepared a French edition of Sir John Strachey's "India" in 1892.

WE learn with regret from *Science* of April 22 that the death occurred on April 14 of DR. HENRY PLATT CUSHING, who was for twenty-six years professor of geology in Western Reserve University, Cleveland, Ohio, and for about the same time geologist in the Adirondack region for the Geological Survey of New York.

Notes.

"CULTURED" pearls, recently introduced by a Japanese firm, appear to have caused some alarm in the gem trade. It has long been known that pearls are the result of local irritation in the pearl-oyster or pearl-mussel, caused by the introduction of some foreign matter—usually the larva of a parasitic organism which spends another part of its life-cycle in an animal that feeds on the mollusc. The mollusc retaliates by coating the unbidden guest with a smooth layer of nacre (identical with the mother-of-pearl layer of its shell, and consisting mainly of the orthorhombic crystalline modification of calcium carbonate corresponding with the mineral aragonite); and the resulting pearl is the elegant tomb of the objectionable parasite. The Chinese have for centuries produced this result artificially by inserting objects between the shell and mantle of the fresh-water mussel, and figures of Buddha on the inner surface of such shells are common. The difficulty hitherto has been to cause the formation of a spherical secretion unattached to the shell of the mollusc. This now appears to have been achieved by Mr. Mikimoto as a result of experiments extending over forty years. It is said that fragments of mother-of-pearl are inserted in the tissues of the molluscs, which are then returned to the sea for a period of several years. Another obvious method would be to infect the oyster-bed with the appropriate parasite. But, whether the foreign matter is introduced accidentally or intentionally, the result produced by the oyster must be the same. The qualification "artificial" would here apply rather to the pretence that the products are essentially different. Attempts on the part of the trade to discredit what is apparently an interesting scientific discovery are clearly made only with the view of keeping up inflated prices. The same selfish fight was made some years ago against the artificially formed rubies and sapphires (miscalled "synthetic," "reconstructed," and even "imitation"), which can be produced much more economically than the naturally formed stones. Strawberries raised in pots under glass are sold without question as strawberries—but wisely at a higher price. Pearls are high in price because of their rarity, but if they were plentiful and the more brightly

coloured mother-of-pearl were rare the cry would be very different.

THE Kelvin gold medal for engineering was founded in 1914, principally by British and American engineers, to commemorate the achievements of Lord Kelvin in those branches of science which apply specially to engineering. The award is made by a committee of the presidents of the representative British engineering institutions, and recommendations are received and considered from similar bodies in all parts of the world. The first recipient was Dr. William Cawthorne Unwin, and the presentation was made by Mr. A. J. Balfour in the hall of the Institution of Civil Engineers on Wednesday, May 4. In the course of his address Mr. Balfour said that Lord Kelvin combined in a manner which had scarcely been equalled before, except perhaps by Archimedes, the power of theorising on the darkest and most obscure secrets of Nature, and at the same time of carrying out efficiently and practically some engineering feat. It was therefore fitting that we should remember Kelvin as one of the leaders in the movement which compelled all modern engineers worthy of the name to be not only men of practice, but also of theory. Dr. Unwin's name was honoured wherever engineering was studied in English-speaking lands, and he had imprinted his own seal upon the whole course of study which young engineers had now to pursue. In his reply Dr. Unwin congratulated the young engineers of to-day upon their advantages in the possession of well-organised colleges and on the recognition by all universities, even Oxford and Cambridge, of a faculty of engineering.

WE are very glad that a reasonable agreement has been arrived at between supporters and opponents of the Plumage (Prohibition) Bill, with the result that the Bill passed through Standing Committee D of the House of Commons on May 10. It has often been suggested that an advisory committee should be set up to prepare a schedule of birds the plumage of which might be imported, but this has been objected to by promoters of prohibitive measures. The agreement now arrived at includes the following terms:—

(1) The Act to come into operation nine, instead of six, months after the passing thereof. (2) Within four months after the passing of the Act the Board of Trade shall appoint a joint Advisory Committee consisting of an independent chairman, two expert ornithologists, three representatives of the feather trade, and four other independent members. The function of this Committee will be to advise the Board of Trade as to additions to and removals from the existing schedule (ostrich and eider-duck) of birds the plumage of which may be imported. By the adoption of these clauses the Bill will in all probability be placed on the Statute Book during the present session of Parliament.

AN announcement in the *Times* of May 9 states that Sir Hercules Read, Keeper of the Department of British and Medieval Antiquities and Ethnography of the British Museum, will retire in July next on completion of forty years' service. Sir Hercules Read joined the museum staff in 1880 under Sir Wollaston Franks, with whom he had worked for six years previously, and whom he succeeded in 1896. Under him the department has developed greatly, particularly in connection with prehistoric and medieval antiquities. By his influence among wealthy connoisseurs, of whom he numbered a great many among his friends, he was able to secure for his department and the nation a large number of valuable specimens of artistic or scientific importance which otherwise might have been lost to us. Mr. J. Pierpont Morgan was largely guided by him in his generous gifts to public collections, and it was at his instigation that the famous Greenwell collection of Bronze-age antiquities was secured and presented by Mr. Morgan to the museum. Sir Hercules Read's connection with the British Museum will not be severed by his retirement. As president of the Society of Antiquaries he will continue to act as a Trustee *ex officio*.

IN presiding at a dinner given by the council of the Iron and Steel Institute to the president, Dr. J. E. Stead, last week, Sir Robert Hadfield spoke at some length on the industrial crisis in this country. He took the view that the present Labour disturbance was unreasonable, since it had been admitted by some of the miners' leaders that its object was political. He stated that no one wished to see reductions in the income of the wage-earners less than he did, but that the existing fictitious state of affairs, both financial and industrial, made it impossible for us to get on a sound footing until some re-adjustment, in which all were concerned, took place. Sir Robert Hadfield went on to urge the need for a greatly increased output per worker, stating that it was only in this way that industry could be restored to an economic basis. In the latter part of his speech he dealt with technical problems, alluding particularly to corrosion, affirming that his study of this question, in so far as it related to iron and steel, had convinced him that the annual wastage was from 1.5 to 2 per cent.

At a general meeting of the members of the Royal Institution held on May 9 Sir J. J. Thomson was

elected honorary professor of natural philosophy and Sir Ernest Rutherford professor of natural philosophy.

At the meeting of the Royal Society held on May 5 the following were elected foreign members:—Prof. Albert Calmette, Dr. Henri Deslandres, Prof. Albert Einstein, Prof. Albin Haller, Prof. E. B. Wilson, and Prof. P. Zeeman.

At the annual meeting of the British International Association of Journalists, held on April 22, Mr. Leon Gaster, the hon. secretary of the Illuminating Engineering Society and editor of the *Illuminating Engineer*, was unanimously elected the honorary general secretary of this association.

By invitation of the chairman of the Lawes Agricultural Trust Committee, Lord Bledisloe, and the director, Dr. E. J. Russell, the House of Commons Agricultural Committee and certain members of the House of Lords will visit the Rothamsted Experimental Station, Harpenden, to-morrow, May 13, to inspect the experimental farm and the laboratories.

THE last ordinary scientific meeting of the Chemical Society this session will be held at the Institution of Mechanical Engineers, Storey's Gate, on June 16 at 8 p.m., when Prof. Benjamin Moore will deliver a lecture entitled "The Natural Photo-synthetic Processes on Land and in Sea and Air, and their Relation to the Origin and Preservation of Life upon the Earth."

THE Empire Cotton-Growing Committee and the British Cotton Industry Research Association propose to award in July next about twelve studentships, each of the annual value of 200l., for the additional training of university graduates in scientific research bearing on plant genetics and physiology, entomology, physics, etc., or in special subjects relating to administration and inspection in tropical agriculture. Forms of application and further particulars of the studentships are to be obtained from the secretary of the Joint Standing Committee, c/o the Shirley Institute, Didsbury, Manchester, not later than July 18.

THE officers and council of the Manchester Literary and Philosophical Society for the new session 1921-22 were elected on April 26 as follows:—*President*: Mr. T. A. Coward. *Vice-Presidents*: Mr. R. L. Taylor, Mr. William Thomson, Sir Henry A. Miers, and Mr. W. Henry Todd. *Hon. Secretaries*: Dr. H. F. Coward and Prof. T. H. Pear. *Hon. Treasurer*: Mr. R. H. Clayton. *Hon. Librarians*: Mr. C. L. Barnes and Dr. Wilfrid Robinson. *Hon. Curator*: Prof. W. W. Haldane Gee. *Council*: Prof. Arthur Lapworth, Mr. C. E. Stromeyer, Dr. W. M. Tattersall, Mr. Leonard E. Vlies, Mr. F. W. Atack, Prof. F. E. Weiss, Mr. Francis Jones, Miss Laura Start, and Prof. Sydney Chapman. The Chemical Section on May 6 elected the following officers:—*Chairman*: Mr. Leonard E. Vlies. *Vice-Chairman*: Mr. J. H. Lester. *Hon. Secretary*: Mr. David Cardwell.

THE London summer meeting of the Institution of Mechanical Engineers, which will be held on June 30 and July 1, will be devoted to subjects connected with the better utilisation of fuels. A novel feature of the meeting will be an exhibition of appliances connected with boiler-room economy and with the efficient use of steam- and internal-combustion engines. The exhibits will include feed-water heaters, combustion recorders, super-heaters, liquid fuel and powdered fuel burners, steam- and gas-engine indicators, etc. The institution desires that all who have exhibits to offer will communicate with the secretary at Storey's Gate, St. James's Park, S.W.1, as soon as possible. Apparatus and models are preferred, but drawings will be accepted and suitably displayed.

ARRANGEMENTS have been made by the Institution of Civil Engineers to continue this year the series of conferences which were interrupted by the rebuilding of the institution premises and the war. A conference will be held on Wednesday, Thursday, and Friday, June 29 and 30 and July 1, the mornings being given to discussions upon selected topics, and the afternoons to visits to engineering works. For the purpose of the meetings the conference will be divided into seven sections: (i) Railways, Roads, Bridges, and Tunnels; (ii) Harbours, Docks, Rivers, and Canals; (iii) Machinery; (iv) Mining and Metallurgical Processes; (v) Shipbuilding; (vi) Waterworks, Sewerage, and Gasworks; (vii) Electricity Works and Power Transmission. The twenty-seventh James Forrest lecture will be delivered by Sir George T. Beilby on the afternoon or evening of Tuesday, June 28.

"THE Physiology of Pain" is the subject of a paper in *Medical Science: Abstracts and Reviews* for April (vol. iv., No. 1). The reviewer concludes: "It is, at any rate, tempting to regard sensibility to pain as the survival in us of the primordial mode of sensation. Its urgency and tendency to evoke immediate motor response is the reproduction of the normal experience of the lower invertebrates. From it the discriminative forms of sensibility have been differentiated by the progressive increase of insulation. If we view pain as an exaggerated response by a physiologically irritated nerve, it is possible to get some conception why pain is the commonest of symptoms and why it is so apt to become inveterate. Pain is, as it were, physiologically only just not present in us all, and what appears to be a very slight disturbance pathologically may prove an effective and incurable excitant of it."

DR. L. O. HOWARD'S annual report of the Entomologist to the U.S. Department of Agriculture for the year ending June 30, 1920, is a record of a vast series of researches carried out for the benefit of the State. The European corn-borer is causing anxiety on account of the increasing area of country that is suffering from its ravages. With an appropriation of 400,000 dollars an energetic campaign is being conducted, and particular attention is being devoted to the natural enemies of the pest. A trained observer has been established in the south of France to study

its native parasites, and Dr. Howard personally visited with the same object regions of Belgium, France, and Italy in which the corn-borer occurs. In connection with insecticides for orchard spraying, much experimental work has been accomplished with contact insecticides in an effort to find something to replace nicotine or tobacco extract. Special attention has been devoted to organic contact sprays, and a compound has been discovered of the pyridine series which offers hopes of success. As in previous years, work on the Gipsy and Brown Tail moths occupies a prominent place. During the spring of 1919 favourable climatic conditions for hatching out the eggs resulted in an unusual spread of the former insect in the caterpillar stage, and an increase in area of 4569 square miles is now stated to be infested. On the other hand, the area affected by the Brown Tail moth has been materially reduced, and 10,677 square miles have been released from the quarantine.

MR. H. G. MAY has published (Proc. U.S. Nat. Mus., vol. lviii., pp. 577-88, 5 plates, 1920) useful notes on the nematode genus *Nematodirus*, which occurs in the small intestine of sheep, goats, cattle, deer, camels, and certain rodents. In addition to abundant material collected in the United States, the author has received material from France and Switzerland, and has been able to study some eight hundred male specimens for their spicules. He finds in this collection four species which have not previously been described. He gives a key to, and short descriptions of, the nine species of the genus, and figures the more important systematic characters, especially the bursæ and spicules of the males.

At a meeting of the Biological Society of Washington (Journal of the Washington Academy of Sciences, vol. x., No. 20, p. 580, December, 1920) Mr. T. E. Snyder directed attention to the extensive and serious injury caused to the lead sheathing of aerial telephone cables in California by the beetle *Scobicia declivis*, which normally breeds in recently felled wood piled for later use as fuel. In summer the beetle attacks the cable where it lies in contact with the metal suspension ring, which affords it leverage for boring. The hole allows moisture to penetrate the insulation, and numerous widely separated short-circuits are produced when rain falls in the autumn. A high percentage of "wire trouble" is caused by this beetle. No remedy has yet been found; chemical repellents, various types of suspension rings, and hard tin and antimony alloys have proved ineffective.

In the Report for 1919 of the Botanical Society and Exchange Club of the British Isles the secretary, Dr. G. C. Druce, provides a supplement entitled "The Extinct and Dubious Plants of Britain." Notwithstanding the great changes which have occurred in Britain during the period since 1597, only about half a dozen native species of flowering plants have ceased to exist, mainly as the result of drainage operations. The most notable are a Vetch (*Vicia laevigata*), which formerly occurred near the shore at Weymouth and Portland, but does not seem to have been found for nearly a hundred years, and two species of Senecio,

formerly plentiful in the Fens, but destroyed by drainage operations. During the same period our flora has been augmented by a number of emigrants from other countries which have become more or less completely established. The dubious plants of Britain—that is to say, plants which have been reported as British—make a very long list. Some are mere casuals, many have been wrongly identified, and some, it is to be feared, were wilful impositions. The probability is that the majority were really erroneous, but Dr. Druce suggests that the publication of these records in an easily consultable form may, by directing attention to them, lead to one or two being re-discovered.

MR. N. H. DARTON (U.S. Geol. Surv., Bull. 701, 1920) has brought together "all available published data bearing on the rate of increase of underground temperature with increasing depth in the United States," including numerous original observations by the author and his colleagues. Some of the very deep wells drilled for oil give average rises of temperature of 1° F. for every 70 ft., the rise being near the surface, and in the deepest levels being about 1° F. for every 60 ft. The following records are of special interest:—McDonald, Pa. (6975 ft.), bottom temperature 144.9° F.; the Lake Well, West Virginia (7500 ft.), at bottom 168.6° F.; and the Goff Well in the same State (7386 ft.), temperature at 7310 ft. 158.3° F. The misleading nature of generalised calculations from depths of less than a mile is clearly shown by the fact that the Goff Well gives from 100 ft. to 7310 ft. a rise of 1° F. for every 70.2 ft., and from 4000 ft. to 7250 ft. of 1° F. for every 56.3 ft. The author reminds us that the workings in the Comstock Lode, Nevada, showed 170° F. at 3100 ft., the average increase in the district being 1° F. for 33 ft. The rate here decreases at similar horizons away from the lode, and local volcanic material is inferred.

THE Bureau of Standards at Washington has issued as Scientific Paper No. 406 a valuable review by Dr. Coblenz of the present position of our knowledge of the laws of radiation of a perfectly black body, and the values of the constants which enter into the numerical expression of those laws. He finds that a considerable proportion of the discrepancies between the results of determinations by different observers is due to the neglect of the absorption of the radiation on its passage from the furnace to the measuring instrument, and to its partial reflection at the receiving surface. On making suitable corrections for these losses he finds that the results are brought into close agreement. He gives as the best value of the coefficient of Stefan's law of total radiation 5.72×10^{-5} ergs per sq. cm. per second per fourth power of the absolute temperature. For the constant C of Planck's radiation formula he gives 14,320 micron degrees, and for the product of the wave-length for maximum radiation into the absolute temperature 2885 micron degrees. The mean value of Planck's constant h by radiation and other methods he gives as 6.55×10^{-27} erg-seconds.

IN the April number of the Journal of the Franklin Institute, Messrs. Loyd A. Jones and C. E. Fawkes give the results of their investigations into the action of photographic reducers on the images produced on

development printing papers. The course of the change is traced in each case by measuring the density of the image after subjecting it to the reagent employed for various times. It is possible to reduce so that the contrast is either unchanged, diminished, or increased. The chief point of novelty demonstrated is the action of ammonium persulphate, which in the presence of a little sodium chloride gives a nearly proportional decrease of density. But if the persulphate is dissolved alone in distilled water there is a certain critical point on the density curve, on the thinner side of which there is very little change, while there is very vigorous action on the denser side. Even in so short a time as three minutes, that part of the curve that lies above the point is reversed in its curvature, and parts of it become less dense than the critical point itself. The authors give the formulæ of the solutions that they used.

IN his presidential address delivered recently to the Institution of Mining and Metallurgy Mr. F. W. Harbord dealt with the chief metallurgical developments which have taken place in this country since 1914. According to him, the only new industries which were established as the result of war requirements were the manufacture of tungsten powder and of ferro-alloys generally. In regard to these products the country is now able not merely to supply its own requirements, but also to compete in the chief markets of the world. The output of carbon steel was increased by more than 2,000,000 tons in 1917 as compared with 1913. More than one-half of this increase was due to "basic" steel. In the years 1916-18 arrangements were made for the erection of 22 blast furnaces and 166 open-hearth steel furnaces with a producing capacity of more than 3,000,000 tons per annum. No branch of metallurgy received a greater stimulus and made greater progress than the art of making and heat-treating special steels, especially those containing nickel, chromium, and vanadium. For many years before the war the zinc industry was in a languishing condition. Here again the productive capacity of the country has been much increased by the erection of new plant and by extensions and improvements to existing plants. The present position of this industry is quite abnormal, but when the relation between cost of production and market price becomes normal Mr. Harbord is of opinion that this country will have two very strong points in its favour, owing to the Government control of Broken Hill ore supplies and the better equipment of the extraction works.

AT the eleventh annual May lecture of the Institute of Metals on May 4 Prof. T. Turner took as his subject "The Casting of Metals," which dates back to early antiquity. The quality of the older material cannot be equalled to-day, although output has been enormously increased and the percentage of "wasters" reduced. Aluminium presents special difficulty on account of its high coefficient of expansion; this leads to fracture during cooling unless proper precautions are taken. Gases in non-ferrous metals are not so important as in steel, and any metal or alloy which does not develop gas by reaction or does not unduly

segregate can be cast in a satisfactory manner provided that a suitable temperature is employed, that the mould is properly designed and made, and that the metal is skimmed and poured in the right manner. Pure metals or single substances, as a general rule, possess the same density whether slowly or quickly cooled. Those alloys in which there is an interval between the liquidus and solidus solidify over a temperature range, and often expand when slowly cooled, as, for instance, when cast in sand. Extensometer tests by Prof. Turner have shown the nature and extent of such expansions in a number of typical alloys. These results agree with the density determinations, but the extensometer has the advantage of showing the sequence and amount of each volume-change. In practice one of the chief causes of failure is pouring at too high or too low a temperature. Other causes include such troubles as imperfect or badly fixed cores, faults in moulding, cracks, mis-runs or run-outs, and breakage in handling. In foundry work generally the losses from all causes reach about 10 per cent. of the output. Prof. Turner took the view that casting is fundamentally an art, and the part of the man of science will be to introduce new ideas and processes rather than to improve on present technique.

THE Oxford University Press is to publish under the title of "From a Modern University: Some Aims and Aspirations of Science" a volume of occasional addresses by Prof. A. Smithells.

A LENGTHY catalogue (No. 88) of botanical and horticultural works which are for sale by Messrs. Dulau and Co., Ltd., 34 Margaret Street, W.1, has just reached us. It gives particulars of no fewer than 3017 publications, including the library of the late M. Edouard André, of Paris. Many early printed and rare herbals are listed, and practically the whole range of botany and horticulture is represented. The catalogue should be seen by all who wish to augment their libraries in these branches of science.

MESSRS. G. BELL AND SONS are shortly adding a new volume to the advanced section of their mathematical series, namely, "A First Course in Statistics," by D. Caradog Jones. The fundamental importance of the right use of statistics is becoming increasingly evident on all sides of life, social and commercial, political and economic. It is hoped that a study of this book will enable the reader to discriminate between the masses of valuable and worthless figures published, and to use what is of value intelligently.

Our Astronomical Column.

ECLIPSE OF RHEA BY TITAN.—The computing section of the British Astronomical Association, recently formed under the directorship of Mr. L. J. Comrie, undertook an extensive examination of the phenomena of Saturn's ring and satellites about the time when their planes are turned edgewise. In the course of this work the prediction was made that the very rare phenomenon of the eclipse of Rhea by the shadow of Titan would take place on April 8. A number of members of the association, including the president, Major Hepburn, observed the phenomenon, and found a satisfactory accord with the prediction. Rhea faded rapidly at 10h. 22m., and became invisible for 50 minutes; the estimated time of mid-eclipse was 10h. 47.3m. G.M.T.; the corresponding predicted time was 10h. 38m., and predicted duration 44 minutes. Since the relative motion of the satellites was slow the error in their positions is small.

about August 10 of the present year, but so unfavourably placed that it is to be feared that it will escape detection.

Comet Pons-Winnecke has been deviating from the predicted path with unexpected rapidity, and M. Ebell has deduced the following revised orbit from observations on April 12, 16, and 26:—

$$\begin{array}{l|l} T = 1921 \text{ June } 13^{\circ}08 & i = 18^{\circ} 15'0'' \\ \omega = 171^{\circ} 43'7'' & \log q = 0^{\circ}0152 \\ \Omega = 96^{\circ} 38'9'' & \log a = 0^{\circ}4526 \end{array}$$

The value of $\log a$ is almost certainly much below the truth, but the elements will probably represent the motion for the next few weeks. The ephemeris printed in this column needs to be corrected by $-13m.$, $-1^{\circ} 11'$ on May 14, and $-25m.$, $-1^{\circ} 12'$ on May 20. It will be noticed that the perihelion point is now placed well outside the earth's orbit, which makes the occurrence of a meteor shower somewhat doubtful.

It would be well if the national ephemerides could publish predictions of interesting phenomena of this character, as there is a danger of their escaping notice if left to unofficial agencies. There is probably no other observation of the kind on record in the Saturnian system; even in the Jovian system, where mutual eclipses occur more often, very few have been recorded, obviously because they have never been systematically predicted.

Ephemeris for Greenwich Midnight.

		R.A.	Decl.	Log r	Log Δ		
	h.	m.	s.				
May	14	18	5	51	47 36 N.	0.0396	9.3772
	16	18	22	0	47 44	0.0355	9.3520
	18	18	39	51	47 38	0.0315	9.3260
	20	18	59	42	47 20	0.0277	9.2997
	22	19	21	5	46 40	0.0241	9.2724
	24	19	45	20	45 34	0.0207	9.2459
	26	20	10	39	44 1	0.0177	9.2193
	28	20	37	37	41 48	0.0149	9.1948
	30	21	5	2	38 56	0.0123	9.1725
	June	1	21	32	26	35 22	0.0101
3		21	59	16	31 4	0.0082	9.1404
5		22	24	46	26 17	0.0066	9.1333
7		22	48	23	21 8	0.0053	9.1324
9		23	9	58	15 50	0.0044	9.1391
11		23	30	28	10 41	0.0037	9.1517
13		23	48	27	5 45	0.0035	9.1695
15		0	4	26	1 17 N.	0.0036	9.1914
17		0	18	52	2 45 S.	0.0040	9.2158

COMETS.—*L'Astronomie* for April contains a discussion by Mr. G. Neujmin of the orbit of the comet (1916a) discovered by him in 1916. He finds:—

$$\begin{array}{l} T = 1916 \text{ March } 11^{\circ}3239 \text{ G.M.T.} \\ \omega = 193^{\circ} 47' 33'' \\ \Omega = 327^{\circ} 33' 0'' \\ i = 10^{\circ} 37' 12'' \\ \phi = 34^{\circ} 26' 33'' \\ \mu = 655.364'' \\ \text{Period } 5.414 \text{ years.} \end{array} \left. \vphantom{\begin{array}{l} T \\ \omega \\ \Omega \\ i \\ \phi \\ \mu \\ \text{Period} \end{array}} \right\} 1916^{\circ}$$

The observations used extended from February 27 to June 5. The comet should be in perihelion again

The Stone-axe Factory of Graig-lwyd, Penmaenmawr.

At a meeting of the Royal Anthropological Institute held on April 19 Mr. S. Hazzledine Warren presented a report on the results of excavations at Graig-lwyd carried out in June, 1920, under a representative committee appointed by the Royal Anthropological Institute. The expenses of the excavation were met by grants from the National Museum of Wales, the Cambrian Archæological Association, and other public and private contributors.

The Neolithic workings follow the chilled margin of the Penmaenmawr intrusive rock for a considerable distance, but the excavation was mainly concentrated upon one important chipping "floor" associated with the site of a large hearth.

The workers made their stone axes either directly from the natural blocks of scree or indirectly by first striking off large flakes. These large primary flakes often weigh from 7 lb. to 14 lb., or even more, and their production in such a tough and intractable material is evidence of remarkable skill. "Core implements" and "flake implements" were made indifferently, according to convenience in working the stone. The stages of manufacture from the natural block to the finished axe may be grouped as (1) preliminary, (2) intermediate, and (3) advanced. The most characteristic forms arrested in the middle stage may be described as "intermediate ovals"; these might well be mistaken for Late Chelles and St. Acheul implements, while many of the smaller specimens in the preliminary stage resemble the earlier Chelles group. Pseudo-Mousterian flakes with faceted platforms, recalling the Levallois technique, were produced in large quantities as a waste product from the flaking of the axes. More than four hundred "ends of celts" (as they are usually called) were found, and thirty-two complete axes have been refitted from these halves broken during manufacture. The industry is essentially similar to that of Grime's Graves and Cissbury.

Four broken polished axes were recovered from the main "floor," and three of these had been re-chipped after breakage into makeshift blades. One stone plaque engraved with a series of triangles was also discovered.

In opening a discussion on the report Sir William Boyd Dawkins said that a debt of gratitude was due to Mr. Warren for having brought these facts, the result of much hard work, before the institute. The subject was of the greatest interest and importance to British archæology at the present time. The finds

at Graig-lwyd must be grouped with those from Cissbury and Grime's Graves. As a result of a careful comparison with the long series of finds from Cissbury in the Manchester Museum, he had come to the conclusion that every peculiarity in the Graig-lwyd specimens could be paralleled from Cissbury, the one difference being that the Graig-lwyd implements were made of igneous rock, while the Cissbury finds were flint. The Graig-lwyd specimens were consequently larger owing to the difference in material. The shape and the rude character of a specimen did not prove that it was not of Neolithic age. He himself had found at Trenton, New Jersey, side by side with typical Indian stone implements, specimens which in form belong to the Moustier and other European Palæolithic types. The lesson to be learned from this find was that age cannot be estimated from form. As regards the positive evidence for date of these *ateliers*, it was beyond question. At Cissbury Neolithic pottery and the remains of domestic animals had been found. The evidence from Grime's Graves was clear. There the flint from which implements were manufactured was taken from pits and galleries, and was therefore later in date than these, but the workings show that the greater number of these galleries had been excavated with polished stone axes, and therefore the implements of Chellean, Moustier, and other types found on this site were Neolithic. The conclusion to which this evidence pointed was supported by the types in Mr. Warren's find. The examples of specimens broken in course of manufacture in Neolithic times, of which the parts now reassembled by Mr. Warren exhibited differences in patination, were also a proof that patination was no criterion of age. The discovery of this factory had an interesting bearing upon the question of prehistoric trade and communication. Owing to the existence of a felsitic stone implement factory in the Lake District, he had hitherto derived the felsite axes found in the Midlands from this source, but in future the felsite at Graig-lwyd would have to be taken into account.

The implements from the Graig-lwyd excavations, which will be reproduced in illustration of the report when it is printed *in extenso*, were exhibited at the Royal Anthropological Institute on April 20-22. A larger and more representative collection is to be exhibited at the rooms of the Society of Antiquaries, Burlington House, on May 23-25.

Descriptive Botany.

UNDER the title "The Leguminous Plants of Hawaii" (issued by the Experiment Station of the Hawaiian Sugar Planters' Association), Mr. J. F. Rock gives a systematic account of the native, introduced, and naturalised trees, shrubs, vines, and herbs belonging to the family Leguminosæ. Detailed descriptions are given of all the native and established species, with notes on distribution and economic uses; keys to the genera and species are also included. In all, 200 species belonging to 71 genera are described, and there are 93 excellent full-page photographic reproductions of the more important species. The percentage of indigenous species in this family is very small, and of these only six are trees, one is a shrub,

and the remainder are, with few exceptions, usually shore-plants or grow near the shore, and are distributed over most of the Pacific Islands. This poor representation of one of the largest families of flowering plants contrasts remarkably with its rich representation in tropical Asia, and is a strong argument against the existence of any previous land connection with the Asiatic continent. The writer regards the Leguminosæ as a strong factor in proving the assumption that the Hawaiian islands are purely oceanic in character; he proposes to discuss thoroughly the origin of the flora in a work on the phytogeography of the islands which he has in preparation.

In "Icones Plantarum Formosanarum," vol. ix.

(Bureau of Forestry, Government of Formosa), Bunzo Hayata continues his descriptive account of the flora of this island. The volume contains studies of genera of a large number of families of flowering plants, and includes descriptions of 139 new species; the arrangement follows the system of Benthām and Hooker's "Genera Plantarum." The descriptions (in Latin) are full and clear, and the volume is remarkably well illustrated with text-figures and plates. Two new genera are established, one, *Dolichovigna*, a climbing bean near *Phaseolus* and *Vigna*; the other, *Pseudosmilax*, a member of the family *Liliaceæ*, and intermediate between *Smilax* and *Heterosmilax*. Nine genera are also recorded as new to the flora of the island, which so far as is at present known includes 3608 species of flowering plants representing 1185 genera and 169 families.

In the *Journal of Ecology* (vol. viii., No. 1) Miss L. S. Gibbs gives an account of the phytogeography and flora of the mountain-summit plateaux of Tasmania based on her own observations and collections. The vegetation of the island may be divided into three principal plant formations: (1) The austral-montane flora of the mountain-summit plateaux, which represent the remains of the huge lava plateau of which the island formerly consisted. The major and most interesting portion of the endemic flora is entirely limited to these summit plateaux; one of the peculiar features is the almost complete absence of herbaceous plants. (2) The mixed forest of the west coast, not very rich in species and characterised more by denseness of growth than by height. There is a marked

endemic element in this flora which probably originated on the higher lands. (3) *Eucalyptus* formation, occupying the greater part of the island, consisting mainly of secondary open forest, and purely Australian in type. A description is given of the various portions of isolated tableland which form the mountains of the island and at no point exceed 5000 ft., and the writer describes the chief plant-associations, enumerating the plants which she collected in each. On the most exposed and highest levels a mosaic of small moss-like plants is developed, with inconspicuous flowers, forming a hard, even surface. This is succeeded by a mountain shrubbery, the dominant association of the more exposed portions of the plateau summits. Lower come forest-associations in succession, namely, dwarf mountain forest, low mountain forest, and *Eucalyptus* scrub. In conclusion, the author refers to the marked relation between the mountain flora of North-West New Guinea, the subject of a former paper, and the so-called "Antarctic flora" of the southern hemisphere. Recent work on meteorological conditions provides an explanation of this relation, namely, in the persistent north-west wind of high altitude over the mountains of New Guinea and across the Australian continent. Seeds transported by this agency would be precipitated in southern latitudes, where they remain within the radius of the persistent westerly winds and gales of the Antarctic seas.

A systematic enumeration is given of the species collected on the mountain-summit plateaux and in the mixed forest from September, 1914, to March, 1915.

Origin of Petroleum and Cause of Gas Pressure.¹

THE important volume referred to below is bountifully illustrated with photographs, sections, and maps, and gives a comprehensive account of some 150 square miles in the midst of the Californian oilfields, a territory which provides nearly half the oil which the State produces, and includes its greatest oilfield. Here, too, is the famous "Lakeview Gusher," which yielded 8,000,000 barrels of oil in eighteen months. The area has been discussed previously both by State and Federal geologists, notably some ten years ago by R. Arnold, H. Johnson, and R. Anderson in *Bulletins* 406 and 471, but since that time there has been much further development, and many new facts are available.

The work contains a wealth of information which is rendered easily accessible by its systematic arrangement and clear table of contents. The book commences with a brief "Summary of Results," which is followed by an informative bibliography. "Stratigraphy," which occupies 34 pages, is dealt with under the headings of the various formations. Then follow "Structure" (pp. 54-63) and "Petroleum" (pp. 63-87), whilst a detailed description of the "Productive Field" occupies the latter half of the book. In the pocket at the back of the volume is a geologic map of the region and large-scale topographic and structure maps of the oilfield, together with many sections across the productive area.

The main scientific inferences differ little from those set forth in the earlier bulletins. It is made clear that the petroleum was generated within the Tertiary deposits, which are at least 18,000 ft. in thickness, ranging from Eocene to Pliocene. **Regard-**

ing the origin of the oil, the author's explanation is that previously formulated by Arnold and Anderson; but he does not ascribe the source of the carbon wholly to the diatoms and foraminifera. "The petroleum has originated in the diatomaceous shale formations, chiefly from the alternation of organic matter contained in diatoms and foraminifers, but probably in part also from the alteration of terrestrial vegetal debris." Later "the oil has collected in part in sandy beds that are intercalated with the [diatomaceous] shale, but chiefly in the porous beds of younger formations that rest unconformably upon the shale."

With reference to migration and accumulation, the author affirms that much of the oil in the pools "has migrated from the beds beneath the San Joaquin Valley to the foothills and collected in the small anticlines that extend from the hills out into the valley." The reservoirs of oil are now chiefly in the later Tertiary "[Miocene or Pliocene] sandy beds that rest unconformably upon the diatomaceous shale."

Some interesting matters are discussed in connection with the gas pressure and concerning chemical reactions on the petroleum within the oilsands. The pressure in these fields is not proportionate to depth, and usually is considerably in excess of the theoretical "hydrostatic pressure." The author holds that the oil, whilst within the reservoirs, has been affected by chemical reactions with minerals. In particular, oxidation by sulphate-laden waters has produced a marginal ring of heavy tar around the pool where its bottom rests upon the under-water. This tar seals the oil pool within a definite space, and any further quantities of gas generated from the oil can be accommodated only by increase of pressure. Such conditions probably account for the great gushers of this region.

T. O. B.

¹ United States Geological Survey, Professional Paper No. 116: "The Sunset Midway Oil Field of California." Part I., "Geology and Oil Resources." By R. W. Pack. Pp. 179.

The University of London.

PRESENTATION DAY.

PRESENTATION DAY of the University of London, which was held at the Albert Hall on May 5, was memorable in many ways, but in two especially: by the admission of the Prince of Wales as an honorary graduate and by the large number of successful graduates who were presented to the Vice-Chancellor for their degrees. The honorary degrees of the University are very jealously guarded; until now the names of Kelvin and Lister have been the only additions to those of the King and Queen. The Prince was admitted to the degrees of Master of Commerce and Doctor of Science. The Chancellor, Lord Rosebery, who was prevented by illness from attending, sent a message in which he made a felicitous reference to the "incomparable Prince," who, he said, had merited a travelling fellowship for the services he had performed in the cause of the Empire. The long procession of graduates in their brilliant robes was an impressive sight, and brought home to the vast audience the magnitude and variety of the work of the University.

The Principal Officer of the University (Sir Cooper Perry) read his report for the year 1920-21, which was written in his accustomed distinguished style. The preamble to the effect that if the "normal year" is still in the distant future, the University is struggling through this "difficult period of strain and stress" with unimpaired strength and a quickened insight into the needs of the community, is fully corroborated by some remarkable statistics, particularly the increase in matriculations from 6638 in 1913-14 to 15,539 in 1920-21. The number of candidates for degrees, 1746 (1036 internal and 710 external), is slightly below the pre-war total, but it is noteworthy that the internal candidates considerably exceed the external, though in 1913-14 the two categories were about equal. The number of internal students is now 7870, and candidates for the new Ph.D. degree already amount to 179. Except for the benefaction of the Government—if such it can be called—of the site of 11½ acres in Bloomsbury for new headquarters, upon the question of accepting which the Senate deliberated, as the Principal plaintively remarked, from May to October last year, the University, apart from its colleges, has not benefited greatly during the year from public or private generosity; but the super-benefaction of the Rockefeller Foundation to University College and Hospital for medical education, amounting to 1,250,000. sterling, beats all previous records in this country. The obituary of the year is short, but includes some outstanding names—Dr. Ronald Burrows, Lord Moulton, Lord Cozens-Hardy, Sir John Macdonell, and Sir Felix Semon.

It was originally proposed that, as last year, a graduation dinner should be held at the Guildhall, but in view of the existing situation this was abandoned and a daylight conversation substituted. The function was very successful. An interesting presentation was made to the Prince by Sir Israel Gollancz on behalf of graduates of the University. This took the form of a beautiful fifteenth-century MS. containing the signature of the Black Prince and a variant of the historic motto "Ich dien" which throws considerable light on its origin. The Prince returned thanks in a happy and characteristic speech, and afterwards received all the newly made graduates and other members of the assembly.

The advanced public lectures in scientific and other subjects arranged under the auspices of the University

are extremely interesting to students and workers in the various branches of knowledge with which they deal. They are given for the most part by distinguished men of science and scholars who are not teachers of the University, and are open to the public without fee. Mr. J. H. Jeans, secretary of the Royal Society, is attracting crowded audiences to King's College, where he is delivering a course on cosmogony and stellar evolution. Prof. Cohen, of Utrecht, is announced to give two lectures (in English) at University College on the metastability of matter; Sir Napier Shaw is delivering an historical course on meteorological theory at the Meteorological Office, and Prof. H. E. Armstrong two lectures on enzymes in relation to plant growth at King's College.

There has been recently an exchange of lectures in medical subjects between London and the Dutch universities, which has been a conspicuous success and may well prove to be the beginning of a complete scheme of exchanges. Under the scheme Dr. Hamburger, the distinguished professor of physiology at Groningen, will lecture at the Royal Society of Medicine on permeability in physiology and pathology on June 8. Dr. Kappers, the director of the Central Institute for Brain Research at Amsterdam, is also giving a course of four lectures on the interpretation of the structure of the brain. All these lectures will be delivered in English.

University and Educational Intelligence.

CAMBRIDGE.—A memorial has been presented to the council of the Senate for a syndicate to be appointed to consider possible alterations in the Mathematical and Natural Sciences Triposes with the object of facilitating the acquisition by candidates in one subject of a knowledge of the other.

It is proposed to appoint Prof. H. Lamb, now in residence in Cambridge, to an honorary University lectureship to be called the Rayleigh lectureship in mathematics.

The Humphry Owen Jones lectureship in physical chemistry is to be revived.

Mr. L. A. Pars has been elected to a fellowship at Jesus College.

LONDON.—The following advanced lectures in physiology and medicine are announced:—A course of eight lectures on "Metabolism of Cholesterol and the Sterols," by Mr. J. A. Gardner, at the London (R.F.H.) School of Medicine for Women, at 5 p.m. on Tuesdays, May 17, 24, 31, June 7, 14, 21, 28, and July 5, 1921. A course of eight lectures on "Experimental Studies in Vegetable Physiology and Vegetable Electricity," by Dr. A. D. Waller and Mr. J. C. Waller, in the Physiological Laboratory of the University, South Kensington, S.W.7, at 5.15 p.m. on Wednesdays, May 18, 25, June 1, 8, 15, 22, 29, and July 6. A course of four lectures on "The Interpretation of the Structure of the Brain," by Dr. C. U. Ariens Kappers (director of the Central Institute for Brain Research, Amsterdam), in the Department of Anatomy, University College, at 5 p.m. on May 13, 17, 19, and 20. These courses are addressed to advanced students of the University and to others interested in the subject. Admission is free, without ticket.

The semi-general election of members of the Senate for the period 1921-25 has resulted in the appointment of the following representatives of science:—By Convocation: G. D. Dunkerley, Sir Philip Magnus, Bart., M.P., and Dr. R. M. Walmsley. Faculty of Science: Prof. A. Dendy and Prof. A. N.

Whitehead. Faculty of Engineering: Prof. H. C. H. Carpenter. Faculty of Economics: Prof. Graham Wallas.

Until recently the degrees of Master of Science and Master of Arts were granted to both internal and external students of the University on a thesis embodying the results of research, but, if thought necessary, an examinational test might also be imposed. Last year, however, the Senate resolved that on the external side these degrees should be given in and after 1923, not for research, but on the results of an examination. This was felt in many quarters to be a retrograde step, and at the meeting of Convocation held on May 3 Mr. Plymen moved and Major Church seconded the following resolution:—"That in view of the importance of research in the national interests and its value in post-graduate training, it is a matter of deep regret that external students of the University should not be permitted to take the Master's degree by means of research." After an animated discussion the resolution was passed, *nemine contradicente*, in an unusually large house, only three of those present refraining from voting in its favour.

MANCHESTER.—The University Court has agreed to the conferment of the following honorary degrees:—

Litt.D.—C. H. Haskins, Gurney professor of history and political science, and Dean of the Graduate School, Harvard University; S. Reinach, Membre de l'Institut de France, Conservateur du Musée de Saint Germain, professeur à l'École du Louvre; J. T. Sheppard, fellow and tutor, King's College, Cambridge. *D.Sc.*—R. Kidston, author of numerous investigations in palæobotany; C. S. Sherrington, professor of physiology, Oxford, and president of the Royal Society.

The following degrees were conferred on May 7:—

Litt.D.—Sir Sydney J. Chapman, formerly Stanley Jevons professor of political economy in the University; Dr. C. H. Herford, professor of English literature in the University; Dr. T. W. Rhys Davids, formerly professor of comparative religion in the University; Dr. G. Elliot Smith, formerly professor of anatomy in the University. *D.Sc.*—Dr. Horace Lamb, formerly Beyer professor of mathematics in the University; Sir Ernest Rutherford, formerly professor of physics in the University. Dr. Horace Lamb, Dr. T. W. Rhys Davids, and Sir William Thorburn have been appointed professors emeriti.

THE University of Glasgow is to confer the honorary degree of LL.D. upon Mr. Laurence Binyon, of the British Museum, Sir Dugald Clerk, and Principal J. C. Irvine, of St. Andrews.

PROF. A. D. ROSS, professor of mathematics and physics in the University of Western Australia, Perth, has been elected a member of the governing body of the University. He formerly held office as Vice-Chancellor, but resigned from that post some little time ago.

The Universities Institute and Institute of Lecturers are issuing a periodical, the *Platform Review*, the first number of which has reached us. The objects of the institute are to foster popular lecturing of an educational nature and to organise courses of such lectures. The first issue of its publication is a special lecturers' number, in which brief paragraphs appear giving accounts of the types of lectures which may be expected from a number of men who will be lecturing during the coming winter. All communications should be addressed to the Editor, 35 Cambridge Road, Seaforth, Liverpool.

NO. 2689, VOL. 107]

Calendar of Scientific Pioneers.

May 12, 1684. Edmé Mariotte died.—An independent discoverer of Boyle's or Mariotte's law, Mariotte was prior of St. Martin-sous-Beaune. He was one of the earliest members of the Paris Academy of Sciences, and wrote on percussion, heat, colour, and hydraulics.

May 12, 1884. Charles Adolphe Wurtz died.—President of the Paris Academy of Sciences and holding the chair of organic chemistry in the Sorbonne, Wurtz wrote more than a hundred memoirs, and during 1869-78 published a great dictionary of pure and applied chemistry.

May 12, 1910. Sir William Huggins died.—The son of a London linendraper, Huggins after a few years in business retired and built an observatory at Tulse Hill, where he carried out pioneering work in astronomical spectroscopy and photography. He received the Rumford and Copley medals, and in 1900 became president of the Royal Society. Lady Huggins, who was his devoted assistant, died on March 24, 1915.

May 13, 1832. Léopold Chrétien Frédéric Dagobert, Baron Cuvier died.—Foremost among comparative anatomists, Cuvier was born in 1769. In 1795 he became a professor in the Jardin des Plantes, and in 1803 permanent secretary to the Paris Academy of Sciences. His most famous work, "Le Règne Animal distribué d'après son Organisation," appeared in 1817.

May 13, 1878. Joseph Henry died.—An indefatigable experimentalist, Henry made some of the earliest discoveries in electro-magnetism and electrical induction. He was professor of natural philosophy at Princeton from 1832 to 1846, and then became secretary to the Smithsonian Institution, which under his direction became one of the most important scientific institutions in the world.

May 13, 1891. Alexandre Edmond Becquerel died.—Professor of physics in the Conservatoire des Arts et Métiers and in the Musée d'Histoire Naturelle, Becquerel collaborated with his father in much of his work, and made independent researches on phosphorescence and on the electrical and magnetic properties of substances.

May 14, 1734. Georg Ernst Stahl died.—After holding the chair of medicine in the University of Halle, Stahl became physician to the King of Prussia. To explain the phenomena of combustion and calcination he formulated the theory of phlogiston.

May 14, 1893. Ernst Eduard Kummer died.—Born in 1810, Kummer was professor of mathematics in the University of Berlin. His writings referred mainly to branches of pure mathematics such as the theory of numbers.

May 14, 1899. Lars Fredrik Nilson died.—While professor of analytical chemistry at Upsala Nilson studied the rare earths, and in 1879 isolated scandium, an element identical with Mendeléeff's hypothetical element ekaboron.

May 16, 1830. Jean Baptiste Joseph Fourier died.—One of the savants who accompanied Bonaparte to Egypt in 1798, Fourier for some years was Prefect of the Department of the Isère. He succeeded Delambre as secretary of the Paris Academy of Sciences. His fame rests chiefly on his "Théorie Analytique de la Chaleur," containing the well-known Fourier's series so constantly used in modern analysis.

May 17, 1765. Alexis Claude Clairaut died.—A writer of mathematical papers at twelve and a member of the Paris Academy of Sciences at eighteen years of age, Clairaut has been called by Comte the principal constructor of celestial mechanics.

E. C. S.

Societies and Academies.

LONDON.

Royal Society, May 5.—Prof. C. S. Sherrington, president, in the chair.—Dr. H. Head: Release of function in the nervous system (Croonian lecture). Hughlings Jackson's law that destructive lesions do not cause positive effects, but induce a negative condition, which permits positive symptoms to appear. Control of higher over lower centres. Structural lesions may remove this dominance and so reveal the activity of subordinate centres; this is "disintegration" of function. Should the stimulus become abnormally intense or central resistance be weakened, forms of reaction may break through which are normally suppressed; this is "escape from control."

Physical Society, March 22.—Prof. W. Eccles, vice-president, in the chair.—W. N. Bond: The effect of viscosity on orifice flows. Determinations were made of the coefficient of discharge through an orifice 0.1469 cm. in diameter of solutions of glycerine and water, varying in kinematic viscosity from 0.01 to 7. The results are plotted in a manner which combines both purely viscous and purely turbulent flows in one graph. The effect of slight viscosity is to increase the coefficient of discharge.—Dr. A. Griffiths and Constance H. Griffiths: Viscosity of water and low rates of shear. The determination of the coefficient of viscosity of water by a method in which water is forced along glass capillary tubes of 1.5 to 2.0 mm. bore at rates of flow varying from 1 litre in two years to 1 litre in twenty-four years. The liquid fills a closed tubular circuit which for purposes of description may be said to be rectangular in shape, two of the tubes being horizontal and two vertical. The circulation is caused by a difference of density obtained by having a weak solution of uranine in one vertical tube and pure water in the other. Values for the coefficient of viscosity are given. There is no experimental evidence that at the extremely low rates of shear the viscosity of air-free water in glass capillary tubes differs from its value at normal rates of shear.—B. S. Smith and G. F. Partridge: A method of measuring frequencies. A heterodyne method of measuring frequency by comparison with a calibrated valve oscillator. Calibration is performed by means of two valve oscillators capable of giving frequencies of 1000/sec. upwards. The frequency of the oscillations is raised alternately to give a beat note the pitch of which is determined by comparison with a fork. Intermediate frequencies are found by interpolation on the calibration curve. For the measurement of acoustic frequencies the sounds are converted into alternating currents by a suitable transmitter.

Geological Society, April 20.—Mr. R. D. Oldham, president, in the chair.—J. A. Douglas: Geological sections through the Andes of Peru and Bolivia. III.: From Callao to the River Perene. The zone of Mesozoic rocks extends to the Pacific coast, which is here formed of shallow-water deposits of Lower Cretaceous age. The granodioritic batholite which forms the core of the Andes is encountered in the neighbourhood of Lima, and again near the summit of the range. The western flanks of the Cordillera are characterised by a great development of Cretaceous porphyritic agglomerate; while the normal calcareous facies is the dominant feature of the high-level regions. The intensity of the Tertiary folding has obscured the effects of the post-Jurassic uplift previously shown to occur in the south, and it is only on palaeontological evidence that a break in the sequence of Mesozoic deposits can be determined. The rocks of Palaeozoic aspect which form the eastern

flanks of the Cordillera are mostly unfossiliferous, and have largely been converted into phyllites and mica-schists, penetrated by granite. On the Rio Perene a bigger mass of red granite is found, which is essentially a rock of "alkaline" character. It is suggested that its origin is antecedent to the uplift of the mountain ranges.—Prof. O. T. Jones: The Valentinian series. The history of the nomenclature from the time of Murchison onwards was traced and the relation of the Tarannon to the Llandovery and the Birkhill-Gala rocks discussed in detail. In view of the occurrence of two distinct facies (graptolitic and shelly) of the Valentinian rocks, two separate classifications are in use. The succession of graptolites is made the basis of one of these, the series being divided into a Lower or Birkhill stage and an Upper or Gala stage, each of which is further divided into sub-stages and zones. The mixed facies of Girvan allows certain shelly horizons to be brought into relation with the graptolitic scale. The fauna of various districts where the shelly facies prevails is compared with the Girvan succession and a general correlation-table of the Valentinian rocks proposed, the rocks of the shelly facies being divided into two stages—Lower and Upper Llandovery. The base-line of the Valentinian series was discussed, and in most districts evidence is found of an abrupt lithological change at a certain horizon, which in some cases amounts to a palaeontological break. The phenomena at that horizon suggest arrested sedimentation, if not also actual erosion.

PARIS.

Academy of Sciences, April 18.—M. Georges Lemoine in the chair.—J. Boussinesq: The flattening along the polar axis, by surface tension, of a liquid drop, of revolution and without weight, possessing a given angular velocity ω of rotation round this axis.—E. Bourquelot and M. Bridel: The application of the biochemical method of research on glucose to the study of the products of fermentation hydrolysis of inulin. By the hydrolysis of inulin by the inulase from *Aspergillus niger* reducing products are obtained which possess the rotary power of *d*-fructose, and do not combine with methyl alcohol under the influence of emulsin. It is concluded that the hydrolytic fermentation of inulin gives no glucose.—L. Cuénot: Regeneration of claws in the place of antennæ removed by cutting in a Phasmid.—B. Gambier: Non-unicursal algebraic curves with constant torsion.—L. Montangerand: Observation of the eclipse of the sun on April 7, made at Toulouse Observatory.—A. Véronnet: The constitution and formation of the spiral nebulae. A mathematical investigation of the conditions under which a double star formed of two components of large, homogeneous, and approximately equal masses may lead to the formation of a spiral nebula.—H. Chipart: The homologues of a permanent uniformly magnetised magnet. The law of the ellipsoid.—L. and E. Bloch: The spark spectra of gold and platinum in the extreme ultra-violet. Tables of wave-lengths of the lines of the spark spectra of these two metals are given between the limits 1843 and 1402.—A. Portevin: The use of very slow cooling for the micrographical study of alloys and the structure of the tungsten steels. The advantages of the very slow cooling are that the structure of the alloys appears on a larger scale, permitting projection on the screen with relatively low magnification, and sometimes new, unsuspected equilibrium structures are shown. The case of tungsten steels is considered in detail, and two photomicrographs of these alloys are reproduced.—M. François: A microscopic arrangement for the examination of opaque crystals.—G. Dubreuil: The principle of a new method of graphical

stereoscopic reconstruction of magnified microscopic objects.—A. **Duboin**: The constitution of smalt. Details for the preparation of this colouring matter are given, the analysis of which leads to the formula $K_2O, CoO, 3SiO_2$, as representing its composition.—G. **Claude**: The manufacture of hydrogen for the synthesis of ammonia. With a view to the utilisation of hydrogen from water-gas, experiments on the solubilities of hydrogen and carbon monoxide in various solvents at high pressures (up to 1600 atmospheres) and at varying temperatures were carried out. A diagram is shown giving the results of the solubility experiments for hydrogen and carbon monoxide at $20^\circ C.$ and $-40^\circ C.$ in ether. It is concluded that by using ether the commercial separation of these two gases under pressures of about 100 atmospheres and temperatures of the order of $-50^\circ C.$ would easily give hydrogen containing less than 0.2 per cent. of carbon monoxide.—M. **Vèzes**: The composition of French turpentine. The proportions of pinene and nopinene are determined by a polarimetric method.—L. **Palfray**: The cresyl cyanocampholates and their reduction product.—R. **Cornubert**: The oxidation with permanganate of α -methylallylcyclohexanone in alkaline solution.—E. **André**: The determination of the acetyl figure of fatty materials. A simplification of the Lewkowitsch method.—L. **Cayeux**: The existence of numerous halcyon spicules in the Jurassic iron minerals of France.—P. **Russo**: The geological situation of the volcanoes of Oudjda, eastern Morocco.—M. de Montessus de **Ballore**: The longitudinal depression of Chile.—L. **Blaringhem**: The variations and fertility of the hybrid *Primula variabilis* compared with those of its parents, *P. vulgaris* and *P. officinalis*.—P. **Dangeard, jun.**: The evolution of the aleurone grains in ordinary vacuoles and the formation of tannins.—L. **Destouches**: The prolongation of life in *Galleria mellonella*. At the most favourable temperature, $37^\circ C.$, the total evolution of the caterpillars of *Galleria* from the egg to the butterfly is about fourteen days. This period can be progressively lengthened by lowering the temperature. By submitting the caterpillars for periods of twenty-four hours alternately to temperatures of $1^\circ C.$ and $37^\circ C.$ the life can be prolonged to thirty-five days, and at the same time the production of eggs is more than doubled.—L. **MacAuliffe** and A. **Marie**: An anatomo-physiological study of a Japanese method of abdominal massage.—A. **Peyron**: The mode of development and the varieties of tumours of the ovotestis.—J. **Legendre**: The biology of the Madagascan perch.

ROME.

Reale Accademia nazionale dei Lincei, February 20.—Original papers by fellows:—G. **Castelnuovo**: Abelian functions, ii.: The geometry of Abelian varieties.—C. **De Stefani**: Ligurian siliceous sponges, iv.: Eocene, lower strata, valley of the Iso and Cairo (Italy).—A. **Issel**: First steps in the systematic arrangement of geological marks. The author proposes to divide them into nine classes, namely, cosmic marks (meteorites), atmospheric marks, hydrospheric marks, hydro-mineral marks, volcanic marks, tectonic marks, plutonic marks, glacial marks, and physiological marks.—Papers communicated through fellows:—L. **Tonelli**: Two propositions of Lindeberg and Levi in the calculus of variations, ii.—O. **Lazzarino**: Variations in kinetic energy of a semi-rigid rotating system.—M. **Pascal**: Superficial circulation, ii. Vectorial expressions and general theorems analogous to ordinary circulation theories.—C. **Perrier**: The true nature of Rosasite. This mineral, discovered in a mine at Rosas, in Sardinia, in the form of crystals, is mainly compounded of copper

oxide, copper carbonate, and zinc carbonate.—E. **Bora**: Contributions to the natural history of Anopheles and their extermination (in connection with Prof. B. Grassi's anti-malaria campaign at Fiumicino, near Rome), iii. The author gives statistics regarding the hours of the day and night at which the mosquitoes enter buildings and commence their attacks. It appears that they rarely attack until some time after their entry. In a second part of the note the author gives evidence in support of the view that fishes and ducks are inefficacious in attacking and keeping down the larvæ.—A. **Lo Surdo**: Binaural localisation of pure sounds. In order to test the theory according to which perception of the direction of a source of sound is due to the difference of phases of the waves as they reach the two ears, the author has constructed an experimental apparatus in which a source of sound is connected with the ears by two tubes, one of which at least can be varied so as to be made longer or shorter than the other at will. If the difference of path is less than half a wave-length, the sound appears to come from a source in the direction of the shorter path; if the difference is exactly equal to a wave-length, the source appears to be in front, and, as should be expected from theory, the apparent direction of the source now varies when one path is increased or decreased in just the same way as it would vary if we started with the two paths equal.—The Secretary (Prof. Castelnuovo) announced that ten candidates submitted works in competition for the prize for physical and chemical sciences offered by the Minister of Public Instruction, and one candidate for the Carpi prize.

Books Received.

The Man who Did the Right Thing: A Romance of East Africa. By Sir Harry Johnston. Pp. vii+444. (London: Chatto and Windus.) 8s. 6d. net.

The Elements of Illuminating Engineering. By A. P. Trotter. (Technical Primers.) Pp. xi+103. (London: Sir I. Pitman and Sons, Ltd.) 2s. 6d. net.

Cours de Physique générale. By Prof. H. Ollivier. Tome premier. Deuxième édition. Pp. 749+iii planche. (Paris: J. Hermann.) 45 francs net.

The New Philosophy of Modern Science. By Dr. W. W. Strong. Pp. viii+194. (York, Pa.: Kyle Printing Co.)

Hiroshige. By Yone Nogouchi. Pp. ix+38+xix plates. (New York: Orientalia; London: Elkin Mathews.) 25s. net.

The Electrical Transmission of Photographs. By Marcus J. Martin. Pp. xi+136. (London: Sir I. Pitman and Sons, Ltd.) 6s. net.

The Extra Pharmacopœia of Martindale and Westcott. Revised by Dr. W. Harrison Martindale and W. Wynn Westcott. Seventeenth edition. Vol. ii. Pp. xxxii+688. (London: H. K. Lewis and Co., Ltd.) 17s. 6d. net.

Laboratories: Their Planning and Fittings. By Alan E. Munby. Pp. xix+220. (London: G. Bell and Sons, Ltd.) 25s. net.

A New British Flora: British Wild Flowers in their Natural Haunts. Described by A. R. Horwood. Vol. v. Pp. xi+234+1-lxiv plates. Vol. vi. Pp. xix+232. (London: Gresham Publishing Co., Ltd.) 12s. 6d. net each vol.

Storia della Geometria descrittiva dalle Origini sino ai Giorni Nostri. By Prof. Gino Loria. (Manuali Hoepli.) Pp. xxiv+584. (Milano: U. Hoepli.) 25 lire.

Famous Chemists: The Men and their Work. By

Sir William A. Tilden. Pp. xvi+296. (London: G. Routledge and Sons, Ltd.; New York: E. P. Dutton and Co.) 12s. 6d. net.

A Handbook of Laboratory Glass-Blowing. By Bernard D. Bolas. Pp. vii+106. (London: G. Routledge and Sons, Ltd.; New York: E. P. Dutton and Co.) 3s. 6d. net.

The West Riding of Yorkshire. By Bernard Hobson. Pp. xii+188. (Cambridge: At the University Press.) 4s. 6d. net.

Mededeelingen van de Landbouwhoogeschool en van de Daaraan verbonden Instituten. Deel xix., Bijdrage tot de Kennis der Zuidelijke Zwerfsteenen in Nederland en Omgwing. By C. H. Oostingh. Pp. iv+165+iv plates. (Wageningen: H. Veenman.)

Diary of Societies.

THURSDAY, MAY 12.

- ROYAL INSTITUTION OF GREAT BRITAIN, at 3.—Dr. C. S. Myers: Psychological Studies; (2) The Appreciation of Music.
- HARVEIAN SOCIETY OF LONDON (at Paddington Infirmary), at 4.30.—Clinical Meeting.
- INSTITUTE OF PATHOLOGY AND RESEARCH (St. Mary's Hospital, Paddington), at 4.30.—Sir James Mackenzie: The Opportunities of the General Practitioner are Essential for the Investigation of Disease and for the Progress of Medicine.
- ROYAL SOCIETY, at 4.30.—G. W. Walker: The Problem of Finite Focal Depth revealed by Seismometers.—E. A. Griffiths: A Liquid Oxygen Vaporiser.—Dorothy M. Palmer and W. G. Palmer: Some Experiments on the Catalytic Reduction of Ethylene to Ethane.—W. G. Palmer: The Catalytic Activity of Copper. Part II.—Prof. J. F. Jenkin and D. N. Shorthose: The Total Heat of Liquid Carbonic Acid.—Dr. A. O. Rankine: The Viscosity and Molecular Dimensions of Gaseous Cyanogen.
- LONDON MATHEMATICAL SOCIETY (at Royal Astronomical Society), at 5.—H. W. Turnbull: Invariants of Three Quadrics.—G. H. Hardy and J. E. Littlewood: (1) Some Problems of Diophantine Approximation; (2) The Lattice Points of a Right-angled Triangle (Second Paper).
- CHILD-STUDY SOCIETY (at 90 Buckingham Palace Road), at 6.—Discussion on Individual Training.—Miss F. E. Webb: Individual Training in the School.—Miss Sabina Salt: Preparation in the Training College for Individual and Group Work in the School.—Miss C. M. A. Coombs: Vertical Classification in an Infants' School.
- SOCIOLOGICAL SOCIETY AND REGIONAL ASSOCIATION (at 65 Belgrave Road), at 8.15.—Prof. P. Geddes: Co-operation in Social Studies.
- ROYAL SOCIETY OF MEDICINE (Neurology Section) (Annual General Meeting), at 8.30.—Prof. Marinisco: Encephalitis Lethargica.

FRIDAY, MAY 13.

- ROYAL ASTRONOMICAL SOCIETY, at 5.—A. N. Brown: Observations of ν Cassiopeiae (Ch. 8324) in 1916-21.—A. A. Rambaut: Observations of the Solar Eclipse of 1921, April 4, at the Radcliffe Observatory, Oxford.—W. H. Van Den Bos: The Orbit of ζ 554=80 Tauri.—Rev. A. L. Cortie and Rev. J. Rowland: The Partial Eclipse of the Sun, 1921, April 7.—C. Martin and H. C. Plummer: Magnitude Curves of Three Short-period Variable Stars, RR Leonis, Y Aurigae, and UU Cassiopeiae.—Royal Observatory, Greenwich: Observations of the Solar Eclipse of 1921, April 7.—Royal Observatory, Greenwich: Observations of Comets, 1921, a, b (Reid and Pons-Winnecke).—L. J. Comrie: Eclipse of Rhea by the Shadow of Titan.—Dr. T. Roys: Lantern Slides illustrating Recent Work at the Kodaikánal Observatory.—Prof. W. H. Pickering: Observations of the Moon at the Harvard College Observatory, Jamaica.
- PHYSICAL SOCIETY OF LONDON (at Imperial College of Science and Technology), at 5.—L. Hartshorn and E. S. Keeping: Notes on Vacuum Tubes used as Detectors of Electrical Oscillations.—B. W. Clark: The Coefficient of Diffusion of Certain Saturated Solutions.—Dr. G. D. West: Experiments on Thermal Transpiration Currents.
- INSTITUTE OF TRANSPORT (at Royal Society of Arts), at 5.
- ROYAL SOCIETY OF MEDICINE (Clinical Section), at 5.30.—Annual General Meeting.
- JUNIOR INSTITUTION OF ENGINEERS, at 8.—H. G. Brown: Scientific Developments in Gas Measuring Instruments.
- ROYAL SOCIETY OF MEDICINE (Ophthalmology Section), at 8.30.—Dr. D. L. Davies: Lachrymal Obstruction, Results of Anastomotic Method of Treatment (Toti).—E. Clarke: Lessons from Forty Years of Refraction Work.—Miss J. C. Mann: Aphakia in a Human Embryo of Five or Six Weeks.
- ROYAL INSTITUTION OF GREAT BRITAIN, at 9.—Dr. W. Bateson: The Determination of Sex.
- SATURDAY, MAY 14.
- ROYAL INSTITUTION OF GREAT BRITAIN, at 3.—Prof. E. C. C. Baly: Chemical Reaction.
- TUESDAY, MAY 17.
- ROYAL INSTITUTION OF GREAT BRITAIN, at 3.—E. Clodd: Occultism: Its Origin and Development.

WEDNESDAY, MAY 18.

- ROYAL HORTICULTURAL SOCIETY, at 3.
- ROYAL METEOROLOGICAL SOCIETY, at 5.—J. E. Clark and H. B. Adams: Report on the Phenological Observations for 1920.—Dr. E. J. Salisbury: Phenology and Habitat, with Special Reference to the Phenology of Woodlands.
- ROYAL SOCIETY OF MEDICINE (History of Medicine Section) (Annual General Meeting), at 5.—Dr. C. G. Cumston: A Brief Historical Summary of the Treatment of Trachoma, with Special Reference to the Arabian School and the Writings of Ali Ibn-el-Aissa.
- ROYAL SOCIETY OF MEDICINE (Surgery Section) (Annual General Meeting), at 5.30.
- ROYAL MICROSCOPICAL SOCIETY, at 8.
- THURSDAY, MAY 19.
- ROYAL INSTITUTION OF GREAT BRITAIN, at 3.—E. Law: The Architecture and Art of Hampton Court Palace: In Tudor Times.
- INSTITUTE OF PATHOLOGY AND RESEARCH (at St. Mary's Hospital, Paddington), at 4.30.—Dr. H. H. Dale: Anaphylaxis and Immunity.
- ROYAL SOCIETY OF MEDICINE (Dermatology Section) (Annual General Meeting), at 5.
- INSTITUTION OF MINING AND METALLURGY (at Geological Society), at 5.30.—E. H. Clifford: Scheme for Working the City Deep Mine at a Depth of 7000 ft.—The following Papers will be submitted for Discussion:—F. P. Caddy: Stope Measuring at the Passagem Mine of the Gold Mines of Ouro Preto, Ltd.—J. A. P. Gibb: Notes on Some Useful Alignment Charts.
- CHEMICAL SOCIETY (Informal Meeting), at 8.
- RÖNTGEN SOCIETY (in Physics Lecture Theatre, University College), at 8.15.

FRIDAY, MAY 20.

- ROYAL SOCIETY OF MEDICINE (Otolaryngology Section) (Annual General Meeting), at 5.—F. J. Cleminson: Sinusitis in Children.
- ROYAL SOCIETY OF MEDICINE (Electro-Therapeutics Section) (Annual General Meeting), at 8.30.—Discussion: The Stomach.
- ROYAL INSTITUTION OF GREAT BRITAIN, at 9.—Prof. E. H. Starling: The Law of the Heart.

SATURDAY, MAY 21.

- ROYAL INSTITUTION OF GREAT BRITAIN, at 3.—F. Legge: Gnosticism and the Science of Religions.

CONTENTS.

	PAGE
The Potash Position	321
Human Palæontology. By Prof. Arthur Keith, F.R.S.	322
British Scientific Instruments	324
Text-books of Organic Chemistry. By J. B. C.	325
Forestry in the United States	326
Our Bookshelf	327
Letters to the Editor:—	
Earthworms Drowned in Puddles.—Sir E. Ray Lankester, K.C.B., F.R.S.	329
A "New" Type of Tool of Moustesian Age. (Illustrated)—Prof. C. G. Seligman, F.R.S.	330
Molecular Structure and Energy.—Prof. Alan W. C. Menzies	331
British Laboratory and Scientific Glassware.—J. H. Davidson	331
Protozoa and the Evolution of the Gregarious Instinct.—Reginald James Ludford	332
The Nature of Vowel Sounds.—Prof. C. V. Raman; Prof. E. W. Scripture	332
Literature for Jerusalem University.—Prof. S. Alexander, Israel M. Sieff, D. B. Stanhill	333
Waste Oil from Ships.—Prof. T. D. A. Cockerell	333
Organism in Flint.—Prof. Grenville A. J. Cole, F.R.S.	333
Isotopes and Atomic Weights. (Illustrated.) By Dr. F. W. Aston	334
Natural Camouflage. (Illustrated.) By E. B. P.	338
Obituary:—	
Prof. W. R. Brooks. By W. F. Denning	340
Notes	341
Our Astronomical Column:—	
Eclipse of Rhea by Titan	345
Comets	345
The Stone-axe Factory of Graig-lwyd, Penmaenmawr	346
Descriptive Botany	346
Origin of Petroleum and Cause of Gas Pressure. By T. O. B.	347
The University of London	348
University and Educational Intelligence	348
Calendar of Scientific Pioneers	349
Societies and Academies	350
Books Received	351
Diary of Societies	352



THURSDAY, MAY 19, 1921.

Editorial and Publishing Offices:

MACMILLAN & CO., LTD.,

ST. MARTIN'S STREET, LONDON, W.C.2.

Advertisements and business letters should be
addressed to the Publishers.

Editorial communications to the Editor.

Telegraphic Address: PHUSIS, LONDON.

Telephone Number: GERRARD 8830.

The Treatment of Tuberculosis by Public Authorities.

THE Tuberculosis Bill introduced by the Ministry of Health having passed through the House of Commons without material amendment, it may be assumed that it will become law. It is an important enactment in its actual provisions, and interesting because it constitutes an attempt to retrace the erroneous steps taken when the National Insurance Bill became law in the year 1911.

Under the National Insurance Act the sanatorium benefit was perhaps the most popular provision, with the possible exception of the maternity benefit. The sanatorium benefit was boomed in the discussions on the Bill until the idea became fixed in the minds of the general population that a first-class hotel in favoured rural surroundings was to be available for every insured consumptive with a reasonable prospect of the cure of his disease. The limitations and the extent of utility of sanatoria in the treatment of tuberculosis were even then well recognised by physicians; but the ideas of Insurance Committees were of a different order, and the pressure brought to bear on these committees by insured persons was so great that many thousands of patients, suitable only for attention in hospitals, were treated in sanatoria, while accommodation for earlier curable cases was deficient in amount. The sanatorium benefit provided also dispensary and domiciliary treatment for insured persons, and in the latter respect en-

croached on the treatment given by the panel doctors. There was the further difficulty that in counties and county boroughs, the public health committees of which had made provision for the institutional treatment of the entire population, insured persons were in a position but little better than that of the non-insured, except in respect of treatment at home.

The fundamental mistakes in the making of these provisions were such as were almost inevitable when amateur medical and lay opinion took the place of skilled advisers having administrative experience in the treatment and prevention of tuberculosis and in general public health work, of which the prevention of tuberculosis forms an essential part. The best that can be said for the actual provisions of the Insurance Act is that it hurried on the general provision of anti-tuberculosis measures, and that especially the associated large grant for the erection of tuberculosis institutions helped to this end. It is necessary to add that had enactments similar to those now embodied in the Tuberculosis Bill been substituted for the extravagant and inefficiently redundant services provided under the Insurance Act, the efforts of public health authorities would have been much more efficient, the friction of duplicated work would have been avoided, and the present position in regard to the treatment and prevention of tuberculosis would be much more satisfactory than it is.

It must not be assumed that the present measure represents all that is necessary for a rapidly successful, because complete, crusade against tuberculosis. It removes from the Insurance Committees responsibilities which they should never have possessed; it agrees to regard as "adequate" those arrangements by the councils of counties and county boroughs for the treatment of tuberculosis which have already received Governmental approval (many of these arrangements are imperfect and incomplete); it makes it obligatory on the councils of counties and county boroughs which have not already made "adequate" arrangements to do so at once, on pain of action at their expense by the Ministry of Health if they default; and it gives power for the provision of after-care and for setting up joint committees when necessary.

All familiar with the actual state of tuberculosis administration in this country know how partially and imperfectly our present knowledge for the treatment of this disease is being utilised.

The war is doubtless responsible for this in part; the divided responsibility of poor law, public health, and insurance authorities has seriously contributed to the same result; and until poor-law hospitals become available generally for non-pauper advanced and acute consumptives there will still persist on a large scale failure to utilise to the utmost already existing arrangements for the hospitalisation of those consumptives whose continued residence in small dwellings, where good nursing and good hygiene alike are impracticable, is a chief reason why our national death-rate from tuberculosis is not declining so rapidly as it can be made to do.

It is unfortunate that in the campaign for the better housing which is so badly required no importance has been attached—apparently from lack of penetration or knowledge—to the fact that, so far as the problem of tuberculosis is concerned, a great, and the most urgent, contribution to the housing problem consists in securing attractive hospital beds for those advanced and acute cases of tuberculosis which are now treated at home under unsatisfactory conditions.

Health and Work.

The Health of the Industrial Worker. By Prof. E. L. Collis and Dr. Major Greenwood. Containing a chapter on Reclamation of the Disabled, by Dr. A. J. Collis. With an Introduction by Sir George Newman. Pp. xix+450. (London: J. and A. Churchill, 1921.) 30s. net.

MANY books have been written on the diseases of occupations, but this is the first adequate modern treatise upon the hygiene of industry in general. A more ideal combination of authors for the purpose it would be difficult to find. Prof. Collis, professor of preventive medicine in the Welsh National School of Medicine, was formerly one of H.M. Inspectors of Factories; during the war he served as Director of Welfare and Health in the Ministry of Munitions and was an active member of the Health of Munition Workers Committee. Dr. Greenwood, who is reader in medical statistics in the University of London, was in charge of the Medical Research Branch of the Ministry of Munitions during the war. By his refinements and judicious application of statistical methods he has done more than anyone else in this country to discourage the issue of statistically worthless medical and physiological data. Both authors are members of the Industrial Fatigue Research

Board, and they have made full use in their book of the valuable reports published by the Board.

As they point out, the keynote of the nineteenth century was the discovery of the industrial value of the inanimate machine; while the keynote of the twentieth century will prove to be the discovery of the industrial value of the living, intelligent worker. They indicate the relation of the early epidemics of plague and typhus to want and overcrowding, and the effects of the now restricted employment of children in improving physique and reducing birth-rate. They describe the medieval measures in this country to prevent the worker from changing his trade and from leaving his district; they show the far greater protection now afforded by the law to women than to men workers; and they point out the opposition which each legislative advance has had to meet before it was finally countenanced.

The very thoughtful chapter on the utilisation of statistical methods in industrial preventive medicine deals with the fallacies of comparing average ages at death, the methods of standardisation, and proportionate mortality in vital statistics. A well-founded plea is advanced for the instruction of medical students in the elements of statistics.

Chap. vi. contains a fascinating epidemiological inquiry into phthisis, especially valuable for its keenly critical and temperate character. The greater decline of phthisis among women than among men in the past fifty years is attributed to the more potent influence of factory conditions on the latter, so that they react more readily than the women to the home influences of overcrowding and of poor (? vitamin-poor) diet. Stress is laid on the importance of viewing industrial phthisis from the industrial aspect, sanatorium treatment being useless unless combined with suitable and remunerative occupation for the skilled convalescent craftsman and with organised methods to nurse the patient back to his proper industrial sphere.

The next chapter discusses the increasing death-rate from cancer. The authors regard the remarkable increase between 1900 and 1913 as being too great to be attributable to improved methods of diagnosis. Evidence is adduced that the prevalence of cancer is connected with industrial conditions, and that, *ceteris paribus*, its frequency is greater in cities and among males.

The striking statistical regularity of accidents is demonstrated in chap. viii., comparable to that of the frequency curves of disease. The maximal reduction in accident-rate, obtainable by the better safeguarding of machinery, is estimated

at only 10 per cent. The workers' conservatism in wearing loose clothes, in displaying loose hair, and in objecting to the use of goggles, and their diverse mental constitution which renders certain of them especially liable to accidents, afford illustrations of the importance of a psychological study of accident determination. "The psychical factor," we are rightly told, "is one of the most important in accident causation."

Chap. ix. deals with the industrial employment of women. From it we learn how man invaded woman's primitive concern in industry when hunting and fighting began to wane. No evidence is forthcoming that woman's present work in factories is more arduous than it was in times preceding the Industrial Revolution.

In the course of the remaining eight chapters useful illustrations are given of canteen menus, washing and drinking appliances, seats, and overalls; and a final chapter on reclaiming the disabled, by the Medical Superintendent of the Ministry of Pensions Hospital at Leicester, brings this original and invaluable work to its conclusion.

Invaluable it cannot fail to prove to him who desires a lucid, critical, and temperate summary of our knowledge in any one of the many fields above referred to, or who seeks a list of references to guide his further reading. Only one defect may perhaps be suspected, namely, that the authors have not kept fully abreast of recent advances in the physiology of the neuro-muscular system and in our psychological outlook on the worker. Thus, in discussing the physiology of muscular contraction, they ignore the recent work of Lucas, Adrian, and others, as a result of which physiologists are now chary of supposing that the strength of an impulse along a given nerve-fibre is variable, or that the staircase (*treppe*) phenomenon is due to practice. The authors' invariable use of the term "end-organ" when they mean "end-plate" may also indicate some lack of freshness in dealing with the same problem. Their informing chapter on alcohol reveals an inability to distinguish between the physiological and the psychological, or else a desire to ignore the latter. "First," they say, "we have to notice some simple physiological or rather psycho-physiological results." But when we come to these results we discover them to be neither simple nor physiological, but to be the outcome of a study of the effects of alcohol on the psychological processes (the physiological bases of which are quite unknown to us) of learning Latin hexameters, and of using the typewriter and the adding machine. The authors, apparently for similar reasons, give us no account of the perhaps more valuable and more purely psychological investigations on the

subject by Prof. McDougall and Miss May Smith, published last year by the Medical Research Council. They even apologise for discussing the psycho-neuroses, whereas apology is due for their brief treatment of so important an industrial subject. They refer only to the work of Breuer (misspelt Bruer) and Freud (published in 1895!), and they are concerned merely with such hysterical manifestations as disturbances of locomotion and speech, neglecting the far commoner and more important anxieties, fears, and mild obsessions which so strikingly affect industrial efficiency.

The truth must be faced that no one writer and no one "certifying surgeon" can combine in himself a knowledge of canteen management, dentistry, eye and limb injuries, pulmonary and other diseases, vital statistics, and industrial psychology. Hitherto the recognition and the prevention of mental disturbance have been ignored as completely in industry as they have been in crime. The prevalence of the psycho-neuroses among workers has not been evident because it has never been looked for, and because until recently no adequate treatment was available for it.

In other respects this book reaches an exceptionally high standard. The defects to which we have directed attention are only slight blemishes, if the wide scope of the work be taken into consideration. They should be easily remediable in the subsequent editions which its assured popularity is certain to evoke.

CHARLES S. MYERS.

British Stratigraphy.

Handbuch der Regionalen Geologie. Herausgegeben von Prof. G. Steinmann und Prof. O. Wilckens. 20 Heft, iii. Band, 1 Abteilung. *The British Isles: The Channel Islands.* By thirteen contributors. Local editor, Dr. J. W. Evans. Pp. 354. (Heidelberg: Carl Winters Universitätsbuchhandlung, 1917.) 15s.

THIS book is remarkable both in contents and in origin. An excellent survey of the whole range of British stratigraphy by a group of highly qualified British authorities, it was published in Germany by German publishers in the very thick of the war (1917). It is part of an ambitious scheme, planned in Germany before the war, to embrace the geology of the whole earth in a series of separate "handbooks" by specialists writing in one of the three languages, German, French, or English. The separate parts were to be combined into volumes, of which the prospective size may be gauged when we take note that the substantial volume before us is part i. of vol. iii.; with France, Spain (already

published), and Portugal as the other parts. Of the fifty-eight parts projected, twenty-one were shown as published when the present volume appeared; but these treat mostly of the smaller European countries and of regions beyond Europe, while the parts to be devoted to Germany, Austria, Hungary, etc., not to speak of those relating to France, Italy, Belgium, Switzerland, etc., were still lacking. This suggests that the German plans, in this as in other matters, have been found easier than the German performance.

For what we have received, however, let us be thankful. In the present part we have a most useful and authoritative summary of our geological knowledge of the homelands. The local editor, Dr. J. W. Evans, has skilfully selected his team, who have dealt individually with the formations on which they have specialised, and possess the fullest and latest information. There is, of course, some unevenness of treatment, but the general scheme is coherent throughout. The classification, subdivision, and local variation of each system in turn are broadly described without much local detail, and illustrated by sketch-maps and sections (mostly reproduced from previous publications, but here conveniently assembled) and by full correlation-tables. The names of the authors of the chapters are sufficient guarantee for the quality of the work. Prof. W. W. Watts deals with the pre-Cambrian, Cambrian, and Ordovician rocks of England; Prof. J. W. Gregory with the pre-Cambrian of Scotland, as well as with the morphology; Dr. A. Harker with the igneous rocks, in a series of short articles under the formational headings; Dr. A. Morley Davies with the morphology of England and Wales, and with the Jurassic and Cretaceous rocks of Britain, except portions of the Scottish Jurassics which are described by Prof. P. G. H. Boswell along with the Scottish Trias; Prof. O. T. Jones with the Silurian; Dr. J. W. Evans with the Devonian; Prof. P. F. Kendall with the Carboniferous, Permian, and Quaternary deposits; Mr. L. Richardson with the Trias and Rhætic; Mr. H. J. Osborne White with the Upper Cretaceous and Tertiary; Prof. G. A. J. Cole with the whole of the Irish formations and with Irish morphology; and Mr. J. Parkinson with the Channel Islands. Room is also found for a short chapter on British earthquakes by Dr. C. Davison.

It is inevitable that there will be many individual points in an embracing work of this kind on which one reader or another will feel inclined to challenge the authority; one might take exception, for example, to the inclusion of the Albian in the Lower Cretaceous, after the unfamiliar German practice, and to the unwarranted implica-

tion here and there that German usage is equivalent to "Continental usage." But we have no space for criticism of detail, which would, indeed, in most cases resolve itself merely into the statement of difference of opinion upon minor points. We commend the book to the attention of every advanced student of British geology.

G. W. L.

Chemical Research in the Elementary Laboratory.

The Experimental Basis of Chemistry: Suggestions for a Series of Experiments Illustrative of the Fundamental Principles of Chemistry. By Ida Freund. Edited by A. Hutchinson and M. Beatrice Thomas. Pp. xvi + 408. (Cambridge: At the University Press, 1920.) 30s. net.

MISS FREUND'S "Study of Chemical Composition" has established for itself a position in chemical literature which has many of the elements of permanence, mainly because of the abiding charm and freshness of the contact which it gives with the great pioneers of chemical discovery. To repeat this successful adventure in a laboratory manual of practical chemistry would appear to be a much more formidable task; but the ten chapters on "The Experimental Basis of Chemistry" which have been prepared for the Press by Mr. Hutchinson and Miss Thomas demonstrate the value, even in an elementary laboratory, of an intimate knowledge of and love for chemical literature.

The earlier portions of the book are of a missionary character. The gospel preached is that knowledge comes only by labour, and that the hasty and inexact work of a beginner is too insecure a foundation on which to base the laws of chemistry. The latter must be derived from the painstaking and exact work of the great masters of the science. In particular a protest is made against those aspects of the "heuristic" method of teaching in which the student is expected to discover in class laws and facts which would demand months and years of work if the discovery were only genuine. Even to prove the correctness of these laws and facts is usually beyond the ability of the worker, and all that is really possible is to work out (in the words of the sub-title) "a series of experiments illustrative of the fundamental principles of chemistry."

The experiments selected for this purpose include a considerable number which are new in form or method; but a more important feature of the book is the discussion of the limits of error as revealed by a comparison of the results of indi-

vidual workers with one another and with the results attained in the most exact researches. This leads up to a consideration of the conclusions that can be drawn from the work, or of the additional experiments that must be made before any conclusions can be drawn.

It is to be feared that those teachers who most need the stimulus and the criticisms of this book will be the last to read it; but many younger teachers, who have already tasted of the tree of knowledge, will find in the book fresh inspiration for the study of chemical discovery, and guidance as to its application in the daily routine of the school.

T. M. L.

Cocoa and Chocolate.

Cocoa and Chocolate: Their History from Plantation to Consumer, by Arthur W. Knapp. Pp. xii+210. (London: Chapman and Hall, Ltd., 1920.) 12s. 6d. net.

MR. A. B. WALKLEY has recently explained in his inimitable fashion how the whole future of the drama and dramatic art in England depends on the withdrawal of the rule that chocolates must not be sold in theatres after 8 p.m. A commodity which has such a profound, if indirect, influence on an important phase of English culture merits serious treatment, and it was clearly time that the history of cocoa and chocolate should be written, and written in a popular fashion.

When, about 1735, Linnæus coined for the cacao tree the picturesque name of *Theobroma cacao*, the English chocolate-making industry had been in existence about seven years. It made slow progress in its early days, and 100 years after its inception the imports of cacao beans amounted to only 450 tons per annum. Since then, and especially in the last ten years, the rise has been remarkable, the imports of the raw material for home consumption in 1919 being over 64,000 tons. In addition, there are considerable imports of foreign-made cocoa and chocolate. The chocolate-maker has, therefore, no reason to complain of the descent of chocolate from its lofty estate as a food of the "gods" to the more humble condition of the flapper's confection.

Mr. Knapp is connected with an enterprise which not only makes everything that can be made from cacao beans, but also owns plantations of cacao trees. He has had, therefore, unique opportunities of making himself acquainted with every branch of the industry, and he has clearly not only utilised these opportunities to the full, but also has thought to some purpose about the

numerous unsolved problems connected with cacao-planting and the preparation of the beans for the market. There must be few planters whose ideas on the shading of cacao trees, the fermentation of the beans and the characteristics of a good cacao will not be clarified by a perusal of Mr. Knapp's pages.

Though chocolate is regarded by the ordinary person as a luxury, it has always had a band of devotees, who regard it as an important food-stuff. Mr. Knapp is one of these enthusiasts, and he provides the inevitable table, comparing the "fuel value" of chocolate with those of some ordinary foods. He omits, however, all reference to price per calorie, which would bring out the interesting fact that even plain chocolate is an expensive food, and that when consumed in the form of those super-confections which, if one may judge from the contents of chocolate-shop windows, constitute the bulk of the chocolate consumed to-day, it is a very expensive food—in fact, as the plain man believes, a luxury. The author of so interesting a book as this may, however, be forgiven a trifling obsession of this kind. It is a book which should be in the hands of all officials of tropical agricultural departments (for whose experimental work Mr. Knapp expresses much admiration) and of all cacao planters, and it is so simply and clearly written that it might even be read by the chocolate consumer if there were in this country any adequate machinery for making the existence of interesting technical literature known to the general public. The illustrations are numerous, good and well selected.

T. A. H.

Our Bookshelf.

An Introduction to Combinatory Analysis. By Major P. A. MacMahon. Pp. viii+71. (Cambridge: At the University Press, 1920.) 7s. 6d. net.

In this little book Major P. A. MacMahon has given a short introduction to his two volumes on combinatory analysis which were published in 1915-16. The theories of combination, permutation, arrangement, order, and distribution which are dealt with in those volumes present technical difficulties; it is, therefore, a great advantage that such an introduction should exist, for the gradual development of the subject by easy stages will prove interesting to the reader and whet his appetite for the larger tomes which await him.

In the first chapter the elementary theory of symmetric functions is introduced, and on it the theory of distributions is afterwards based. The author treats in turn the simplest problems of the distribution of objects into boxes, one object

only being placed in each box, then the various complicated problems which result when the restrictions are removed, and finally the general problem of distributing s different sets of similar objects of which there exist p_1 of one kind, p_2 of a second kind . . . and p_s of another kind, into boxes of which there are m_1 of one kind, m_2 of a second kind . . . and m_t of another kind, the whole number of the boxes being any number not greater than the whole number of the objects.

It is a great achievement to expound a difficult subject in a simple manner, and for that reason alone Major MacMahon is to be congratulated. For some reason which is not at present clear, the theory of the combination of different sets of similar possibilities (which can conveniently be represented as the distributions of balls in boxes) is of the utmost importance in many different branches of science. For example, it is clear that this theory must enter into such a question as the formation of a muddy liquid from molecules which occur in groups of one, two . . . n . The theory will also be relevant in a serious consideration of error in relation to causal laws. The subject is, therefore, of great importance in applied as well as in pure mathematics, and might very well prove another example of the extraordinary way in which abstract mathematics leads the way in applied science.

DOROTHY WRINCH.

Il Regime delle Acque nel Diritto Pubblico e Privato Italiano. By Avv. Antonino Vitale. Pp. x+480. (Milano: Ulrico Hoepli, 1921.) 25 lire.

THE rapidly increasing development of the water-power resources of Italy since the commencement of the war, and the probability of still further extensions in its use in the future, have led many writers in Italy to attempt a clear exposition of the legal aspect of the question, which is an extremely wide one, covering, as it does, the interests of the State, communities, and individuals. The author of the present work, Advocate Vitale, who is attached to the Ministry of Public Works, brings to his study a special competence. After a reasoned consideration of the question whether there exist private waters in contradistinction to public waters, or whether there is a private title to certain waterfalls as compared with the public title, he deals at length with the legal aspects of private title. The question of administrative control is treated in three large sections, the first of these bearing on the harnessing of water-power and the protective measures involved; the second on the actual utilisation and control of falls, rivers, and streams; and the last on contentious points of law and administration. In this survey all possible applications of water-power, including hydro-electric stations, irrigation plants, river diversions for water supply, transport, etc., have received consideration. The volume contains copious references to existing legislation on the subject and to the works of other authors. The main

interest of the book is naturally to Italians, although, of course, existing and subsequent enactments would affect corporations and syndicates anywhere which might anticipate obtaining concessions for the development of water-power in Italy.

E. S. H.

A Text-book of Physics. By Dr. W. Watson. Seventh edition. Revised by Herbert Moss. Pp. xxvi+976. (London: Longmans, Green, and Co., 1920.) 21s. net.

THE new edition of this well-known text-book is substantially a reprint of that of 1919. The additions made include the spherometer, Young's extensometer, the McLeod gauge for measuring low pressures, and the travelling microscope. The discussion of Young's modulus, Poisson's ratio, and rigidity has also been considerably amplified, while descriptions of the pyrheliometer, the Callendar continuous-flow method of mixtures, and the Beckman and clinical thermometers now find a place. Further additions include a proof of Gauss's theorem with illustrations, likewise illustrations of the applications of Kirchhoff's laws, and in electron theory a concise account of "canal" or positive rays. The explanation of diffraction through a slit has been extended, and "resolving power" is also treated.

The values of physical constants have been revised, and under "Terrestrial Magnetism" the majority of the maps and diagrams replaced by recent plottings. It is interesting to note therefrom that the east line of zero declination, or agonic line (1917), now consists of a nodal curve with intersecting branches, in place of the former simple curve and Siberian oval, as in 1907.

In its present form Watson's "Physics" is the most comprehensive single-volume text-book of physics in the English language. It contains little that may now be adversely criticised, and the compilers have improved the index by increasing it to nearly twelve pages.

A. W. BAIN.

La Colloïdothérapie: Résultats Cliniques. By Dr. J. Laumonier. (Collection Médicale.) Pp. ii+283. (Paris: Félix Alcan, 1920.) 5.50 francs.

THIS book, as its title suggests, has been written by one who has no doubts as to the answer to a question which gives pause to many—namely, whether any special therapeutic value can be assigned to preparations of metal and other substances in the colloïdal state which can be attributed to their state.

The theoretical section is commendably brief, the main body of the work being devoted to a systematic account of the method of preparation, uses, and physiological action of colloïdal solutions of silver, gold, platinum, arsenic, etc.

The author's reading is limited, and his references are confined practically solely to the work of his compatriots; but the work of the French school affords ample material for the object in view—namely, the production of a book of reference for the practitioner.

Letters to the Editor.

[The Editor does not hold himself responsible for opinions expressed by his correspondents. Neither can he undertake to return, or to correspond with the writers of, rejected manuscripts intended for this or any other part of NATURE. No notice is taken of anonymous communications.]

The Magnetic Storm of May 13-17.

A TIME of unusually severe and protracted magnetic disturbance began on May 13, at about 13h. 10m. G.M.T., with an S.C. ("sudden commencement"). This was clearly oscillatory in D (declination), movements to west, east, and again west following in rapid succession, their extreme range being about 15'. Within about a minute of the S.C., H (horizontal force) was enhanced about 120γ. The appearance of the trace suggests a very rapid preliminary fall, but this is not clear. Immediately after the large rise a fall began in H, but the element remained above its normal value for about five hours. The disturbance following the S.C. was only moderate until nearly 20h. on May 13, when considerably larger movements appeared in H. Disturbance continued throughout May 14, but there was a comparative lull between 8h. and 16h. Subsequent, however, to 16h. disturbance became very active, and the night of May 14-15 was much more disturbed than the previous night.

The most disturbed period, on the whole, was from 0h. to 8h. on May 15. During this time the D trace was off the sheet three times, but only for a few minutes at a time, in the easterly direction, and twice on the margin or off the sheet in the westerly direction. The range actually shown was 2° 12'. In the course of an hour—4h. 25m. to 5h. 25m. on May 15—movements occurred of at least 108' E., 107' W., 94' E., and 92' W. Few, if any, of the larger D movements were absolutely unidirectional. The variations in the light intensity along the curve showed that superposed on the larger movements were incessant short-period oscillations. The H trace was similarly oscillatory, but it was beyond the limits of registration in the direction of H, diminishing from about 3h. to 7½h. on May 15; so the range shown, 650γ, was doubtless much exceeded.

In vertical force the disturbance was considerable on the night of May 13 between 21h. 45m. and midnight, but on the night of May 14-15 it was enormously greater. Assuming the scale-value to be unchanged since its last determination, the range reached 1500γ. Between 3h. 53m. and 4h. 10m. on May 15 there was a rise of 1400γ. A little later, in the course of twelve minutes, there were a fall and a rise each exceeding 950γ. These and other large movements had shorter period oscillations superposed on them. The abnormally disturbed state of vertical force lasted from 22h. on May 14 to 8h. on May 15. During most of this time the value was much depressed.

Disturbance continued over the whole of May 15 and 16 and until the early hours of May 17. There was a very highly disturbed time on May 16 between 2h. and 10h. The H trace was off the sheet for fully 1½ hours between 8h. and 10h. C. CHREE.

Kew Observatory, Richmond, Surrey,
May 17.

NO. 2690, VOL. 107]

The Reparation Act and the Cost of German Publications.

MAY I direct attention, through the columns of NATURE, to the serious position of scientific institutions in this country in respect to the operation of the German Reparation (Recovery) Act, 1921? Under this Act, of the cost of goods imported from Germany, half is taken by the Government towards the German reparation indemnity. Of course, most objects of commerce imported from Germany can be made in this country, and perhaps the Act is partly designed to assist home industries. There are, however, certain chemicals which are not at present made with sufficient purity, but this can be corrected.

The serious point is that there are German publications which in no circumstances can be conceived as likely to be published in this country. The advance of science necessitates the study of these publications as soon as possible after issue. Booksellers and publishers in Germany with whom I have communicated have informed me that they cannot afford to sell them at less than the published price. To pay the published price I have to send my cheque for actually twice the published price, viz. to pay 100 per cent. extra.

I am now informed by the Board of Trade that a committee "have given consideration to the question of the exemption of German books and periodicals, but they have not felt themselves able to make any special recommendation regarding German publications." The matter seems to me to be serious, and one which might be profitably considered by the scientific world and the societies representing it in this country.

J. STANLEY GARDINER.

Zoological Department, Cambridge,
May 12.

Auroral Display.

A DISPLAY of the aurora borealis was observed from Pontyfridd Common between 9.40 and 9.55 G.M.T. on Friday evening, May 13, the sky being quite clear of clouds.

The chief appearance was a single band of light, varying from 5° to 15° in breadth, and reaching from a little below Regulus, which appeared almost central in it, near the zenith, and thence to the horizon about east by north, where the view was limited by a hill-top with an altitude of about 15°. The band varied both in width and in intensity, the middle third of its length fading away and the ends alone remaining; then the middle grew bright again, the ends disappearing; then the full length reappeared and the whole faded away evenly. The band showed no colour and no flicker, only fairly rapid changes of intensity; its edges were undefined and its axis the most brilliant part. It was many times more brilliant than the Milky Way, and might be compared with the region of the sky round the moon as seen when the latter is hidden by holding up the hand. At the beginning there was a parallel band of similar appearance a few degrees to the south of the eastern third of the main band, and at one time when the ends were disconnected they no longer appeared to be in the same straight line. A. E. L. HUDSON.

The Colours of Primroses.

MAJOR LATHAM'S letter (NATURE, May 5, p. 301) on the coloration of primroses has attracted me, for I have been studying the genus for several years. For

use in my work I have accumulated a considerable collection of wild varieties of *Primula acaulis*, some of which have been kept merely for observation, whilst others have been used for experimental work in genetics, in the course of which facts having some bearing on the colour problem have emerged.

As was inevitable, I obtained the red-flowered form of the primrose very early, and soon noted its occurrence in restricted areas. In Northumberland and Durham I know it from only two wild stations, one on the coal measures of North Durham, and the other in a ravine on the slopes of Kilhope Law, at the head of West Allendale, in Northumberland. The latter is far above the levels of gardens, and nearly 800 ft. above the range of the cowslip, so that the possibility of hybridity is excluded. Nevertheless, all the plants bear red flowers.

With the view of testing how the red colour was inherited, several plants were transferred in spring, 1915, from an elevation of above 1500 ft. to our garden only 30 ft. above sea-level. Although these plants produced red flowers in their first season, just as their relatives did in their mountain home, I made no crosses that year, intending to let the plants establish themselves. To my amazement, however, in 1916, when they flowered, their colour was exactly that of the normal primrose, and as long as I kept the plants—until 1918—only normally coloured flowers appeared. On the other hand, plants brought from Kilhope Law to the Vicarage garden at Ninebanks (elevation just above 1000 ft.) showed no change whatever in flower colour.

From the above it is clear that the altitudes at which the plants grow have something to do with the problem, and that the actual agency may be the average temperature is indicated by the failure of some rose-coloured varieties of *Primula sinensis* to develop their proper colour unless a certain temperature is attained.

Further evidence, indicating that the same influence is at work, appears in the form of two other primroses in my possession brought from a height of 1200 ft. in Upper Teesdale. These bear yellow flowers much deeper in hue than usual, and, in addition, clothed with a dense vestiture of white hairs. As the cowslip ascends in Teesdale to the limestone of Harwood Dale (at 1600 ft.) hybridity is not excluded here, but against this is the fact that although I have examined hundreds of primrose-cowslip hybrids I have never encountered a plant in the least like these.

The insect to which Major Latham refers as the "primrose sprite" is no doubt *Bombylius major*, a fly often to be seen poised, with proboscis extended, over primroses in April. Aiding it in the work of pollination, but carrying on their operations in a more or less illicit fashion, are the thrips, *Taeniothrips primulae*, and larvæ of the Geometrid moth, *Larentia didymata*.

J. W. HESLOP HARRISON.

Armstrong College,
Newcastle-upon-Tyne, May 7.

Earthworms Drowned in Puddles.

THE explanation suggested by Sir E. Ray Lankester (*NATURE*, May 12, p. 329) of the occurrence of dead earthworms in surface "puddles" described by Mr. Friend had occurred to me, viz. that they were drowned. As to the survival of such worms in cool, clear, running water for some time, it is well known

to most "bottom" fishermen that worms will survive for a considerable time on a hook in such water, and it is conceivable that their ultimate death is due to a too free exchange between the body-fluid and the surrounding water at the wounds made by the hook rather than to inability to breathe.

I walk warily in dealing with zoological matters, but I may suggest that with the breathing apparatus described the "moist surface" must, when underground, frequently or usually be in contact with other moist surfaces, so that the worm is, in effect, partly immersed in water. The great advantage of breathing through the agency of a moist film, as the worm does when above ground and as mammals do, is that the exchanges between air and blood can take place very rapidly owing to the steep gradient of oxygen tension in the film. An animal normally living in water has to expend a great deal of energy in pumping water through its respiratory system in order to get enough oxygen to support life. Fish when in water very far from saturated with oxygen or saturated at a relatively high temperature are unable to get the water through their gills at a sufficient speed; in the latter case the temperature coefficient of vital activity is against them, as they live faster at higher temperatures.

The oxygen dissolved in water is very small in amount. At 15° C. it is about 7 c.c. per litre, or one part by weight in 100,000. The oxidisable matter in moderately contaminated water will consume about 0.2 to 0.4 part of oxygen in five days at 18° F. (Adeney's test). The consumption of oxygen would naturally be relatively rapid in the early stages. Rain-water is approximately saturated with oxygen, but the considerable mass of oxidisable matters in dead and rotting leaves might easily take up the dissolved oxygen much more rapidly than re-absorption could take place in a stagnant pool of appreciable depth. If so, the worms which might manage to keep going for a time in well-aerated water, although with difficulty, would die in water which did not continually provide a surface layer fully saturated with oxygen in contact with their skin.

I hope to be able to make some quantitative investigation of the matter.

J. H. COSTE.

Teddington, May 13.

The Physical Continuity of "Space."

IN the "space-æther" discussion clarity is lost by a failure to distinguish between "container" and "content." The relativist does not assert that there is no content. He is concerned with the geometry of the container; if this geometry assists the metaphysician or philosopher to a better understanding of the content, he is satisfied. If the container is called the world-frame (a term free from the ambiguity of æther), the relativist maintains that its geometry is four-dimensional and hyperbolic (semi-Euclidean) in character so long as the content is free from the influence of energy. This may be a condition of absolute rest or it may not. When the content is disturbed and energy manifested, the world-frame geometry is altered, and the world-frame may then be better described as the world-fabric.

Einstein relates the intensity of disturbance to the change in the geometry of the fabric with respect to that of the frame. He does not concern himself with the content of the frame, but only with that content of the fabric which manifests itself as free or bound energy. He leaves it to the metaphysician to deduce

that the content of the frame is the content of the fabric in absolute rest, or to make any other deduction he logically can. He does not pretend to explain what energy is or what it may become if reduced to absolute rest. He does not assert that there is no absolute rest, but that it escapes his and all experience.

JOHN G. MCHARDY,
Comdr. R.N. (Retired).

16 Ebury Street, S.W.1, May 6.

The Production of Metallic Zinc.

IN the issue of NATURE for April 28 I observe under "Notes" (p. 279) a reference to the small volume on zinc recently issued by the Imperial Mineral Resources Bureau. In this reference it is pointed out that the figures relative to the production of metallic zinc in the United Kingdom for 1913 do not harmonise with the figures of production and imports of zinc-ore. Naturally so, for there are other factors involved in the production of metallic zinc in any given year. The output of metallic zinc is not necessarily derived entirely from the ores produced at home or imported in that particular year; the part played by "secondary" production—that is, metal obtained from hard zinc—is of importance in this connection.

As regards the use of the expression "long ton," to which the writer of the note objects, preferring the words "statute ton," it has been made abundantly clear in the prefaces to the Bureau's publications that "the weights are expressed in long tons—that is to say, the British statute ton of 2240 lb." The ton of 2240 lb., though the "statute" ton in the United Kingdom, is not necessarily the "statute" ton in other countries. The expression "long ton" has not only the advantage of conciseness, but it is also well understood throughout the mining and metallurgical world.

R. A. S. REDMAYNE,
Chairman of the Imperial Mineral
Resources Bureau.

2 Queen Anne's Gate Buildings,
Westminster, London, S.W.1.
May 4.

SIR RICHARD REDMAYNE puts forward two explanations to account for the discrepancy in the statistics published by the Imperial Mineral Resources Bureau. The first of these, namely, that stocks of ore may be carried over from year to year, is, in view of the relatively small differences from year to year, inadequate to account for the great discrepancy noted. The second is, in fact, the true explanation. Secondary zinc accounts for about one-half of the so-called zinc output of the country, and thus seriously affects the statistics.

THE WRITER OF THE NOTE.

The Theory of Vision.

PROF. JOLY's papers on vision are very interesting. He adopts the visual purple as the visual substance, but there is no evidence that the rods are percipient elements. The view that they are percipient elements is based on errors, as, for instance, that certain animals—the tortoise is the most quoted—possess only cones; that the periphery of the retina is colour-blind; and that the Purkinje phenomenon is not found with the fovea. The tortoise has the rods and cones as definitely marked and distinct from each other as in man. Has any reader seen a retina in which there

are only rods or only cones in any animal? The periphery of the retina is not colour-blind. Red of sufficient luminosity can be seen to the extreme periphery. The Purkinje phenomenon is found with the fovea, and is a photochemical phenomenon. It is very improbable that the rods are percipient elements. An elaborate nervous mechanism is required to regulate the sensitiveness of the photochemical film, and this appears to be the function of the rods.

The stimulus in vision is undoubtedly liquid, as shown by the movement of positive after-images.

The decomposition of the visual purple stimulates the ends of the cones. The ends of the cones consist of a series of discs varying in diameter.

F. W. EDRIDGE-GREEN.

May 7.

A New British Land Planarian.

MR. MORISON's discovery of the interesting planarian worm (*Rhynchodemus Scharffi*) in a garden at Chiswick, as described in Prof. Dendy's letter in NATURE of May 5 (p. 298), shows that this species has a wider range than was at first anticipated. As Prof. Dendy states, it was first discovered in a Dublin garden in 1894, but since that date it has turned up in the Royal Botanic Gardens at Glasnevin, Dublin. I thought it had probably been introduced into both localities, but that nevertheless it was indigenous to Ireland.

It seemed to me most likely to have been brought from the country with a load of turf. This view was confirmed when, in April, 1901, I found several specimens of this planarian worm in the open country under a fallen tree-trunk near Ballymote, Co. Sligo (see *Irish Naturalist*, vol. x., 1901, p. 133).

R. F. SCHARFF.

National Museum, Dublin, May 12.

Cutting Sections of Cotton Hairs.

IN our laboratory we have now, for some months, utilised Mr. H. J. Denham's plan for celloidin-paraffin embedding of the cotton hairs, on the lines of Kultschitzky's and other processes (Worden: "The Nitro-cellulose Industry," p. 805), described in NATURE of May 5, p. 299, which Mr. Denham kindly communicated to us when he first suggested it, and we have found it most satisfactory. We immerse the hairs in dilute celloidin, which is then boiled down to a syrup (Gilson's process); the hairs are next transferred to paraffin-chloroform, and thence to 60° C. paraffin (Ide's process); this makes a very rapid technique, cut sections being available within two hours. We have also tried the method of Willows and Alexander, but find it cytologically inferior to this celloidin-paraffin technique, which gives us excellent sections at 2.5 μ setting on a Leitz sliding microtome, with accidental sections even thinner.

W. LAWRENCE BALLS.

H. A. HANCOCK.

Experimental Department,
The Fine Cotton Spinners' and
Doubblers' Association, Ltd.,
Manchester, May 13.

British Scientific Instruments.

IN the review of the "Dictionary of British Scientific Instruments" published in NATURE of May 12, p. 324, it is stated that the British Optical Instrument Manu-

facturers' Association, which has issued the dictionary, "is one of the industrial associations working in connection with the Department of Scientific and Industrial Research." Will you permit me to correct a slight misunderstanding here? The British Optical Instrument Manufacturers' Association is a trade association, and is independent of the Department of Scientific and Industrial Research. The industrial research association formed under the scheme of the Privy Council for the promotion of scientific and industrial research is the British Scientific Instrument Research Association. Most of the leading British manufacturers of scientific instruments are members of both associations, but the credit of publishing the dictionary referred to is due wholly to the British Optical Instrument Manufacturers' Association.

J. W. WILLIAMSON,
Secretary, British Scientific Instrument
Research Association.

26 Russell Square, W.C.1, May 13.

Picture-hanging Wire.

I SHOULD be glad to know the best kind of wire and the best form in which to use it for hanging pictures, etc., on walls.

Some ten years or so ago I was advised to use twisted brass wire of five strands, which was then immensely strong with a breaking strain of probably more than 100 lb., but it has become so rotten as to break under a weight of a pound or two. This wire has been in use in a very dry room with electric light only. My own experience has proved that plain copper wire in one strand has lasted three times as long as the twisted brass wire, though bearing far heavier weights. Before the war a "wire" consisting of a steel core with some other wire braided over it was recommended, but it is soon affected by rust, and appears to be much stronger than it really is.

R. B. MARSTON.

Surrey Lodge, 160 Denmark Hill, S.E.5.
May 12.

The Occurrence of *Bombus* in the Indian Plains.

As it is generally agreed among naturalists that the genus *Bombus*—the "bumble-bees" of Europe—is in India entirely confined to the hills, and never descends below 3000 ft., I write to record its occurrence in the plains.

Nearly three years ago, when my entomological knowledge was yet in a rudimentary state, I remember occasionally seeing a bee, which I considered a species of *Bombus*, at Sukna, situated at the base of the hills of the eastern Himalayas. The few friends to whom I mentioned the incident generally politely turned the conversation aside, but the actual capture a few days ago in Calcutta of two specimens of *Bombus tunicatus* seems to indicate that my first observation was probably correct, and that "bumble-bees" do (very rarely, of course) occur in the Indian plains in the cold season.

CEDRIC DOVER.

Indian Museum, Calcutta, December 28.

Symbols in Vector Analysis.

In books on mathematics and physics where vector analysis is used it is customary to use clarendon or thick-letter type to distinguish vector from scalar quantities. This practice has, among others, the disadvantages that it reduces the number of symbols

available for other purposes, and is impossible to reproduce in manuscript.

It is justified only by the fact that it prevents confusion between the two types of quantities and the consequent application of algebraic operations to vector quantities and *vice versa*.

Another means of reaching the same results without the above disadvantages would be to replace the symbols +, -, and = by new symbols in vector analysis. This would be of itself sufficient to differentiate vector from algebraic symbols, and would be more logical, as the symbols stand for quite different ideas in the two systems of analysis.

R. H. NISBET.

Kut, March 26.

Young's Interference Experiment.

I HAVE read with considerable interest Dr. Houstoun's letter on Young's experiment in NATURE of April 28, p. 268, and I beg to state that we have been using the spectrometer for some time in the University College of Science, Calcutta. For making the double slit, a rectangular slit, about 2 cm. x 2 mm., is cut in a piece of cardboard. Two Gillette razor-blades are placed on two sides of this slit by small pieces of wax. At the centre a fine cocoon fibre, or preferably a spider thread, forms a double slit. By mounting the cardboard on the prism-table the fringes are easily seen, and as the rotation of the table alters the width of the slit the change in the nature of the fringes can be easily examined.

P. N. GHOSH.

97 Finborough Road, S.W.10,

May 9.

The Origin of "Churning at 62°" on Dairy Thermometers.

MR. HEDGER WALLACE'S question (NATURE, April 28, p. 268), "Why do makers of dairy thermometers mark their thermometers 62° F. as churning temperature?" interests us as thermometer-makers who are frequently asked to supply floating dairy thermometers to a particular pattern. In many cases the customer decides the pattern, and we are prepared to satisfy our customers' requirements. We make and sell a large number of dairy thermometers not marked at any particular temperature for churning, and we advise this pattern, as we are told by dairy experts that any temperature between 45° and 62° F. may be required, according to conditions. It appears that no definite temperature can be fixed; therefore, to mark 56° F. as a fixed point for churning would be equally in error.

A. C. COSSOR AND SON.

Accoson Works, Vale Road, London, N.4,

May 9.

Organism in Flint.

IN reference to Prof. Cole's suggestion (NATURE, May 12, p. 333), the possibility of the organism being a radiolarian was considered long ago and rejected. The consensus of opinion is now in favour of its being a beetle. Under higher powers the clavate and merismatic antennæ are very conspicuous. There is no micro-slide of the fossil; the photographs are taken direct from the flint-surface. Special photographs of the organism's separate parts are now being prepared under more favourable conditions, and will be available shortly.

C. CARUS-WILSON.

May 13.

Direction-finding Wireless and Marine Navigation.

By J. J. BENNETT.

THE use of wireless telegraphy for direction-finding purposes, which came into vogue in the Navy during the war, seems likely to remain as a permanent auxiliary to sea navigation. France, the United States, and Canada have each adopted the system, and it is understood that Germany is maintaining some of the stations which she erected for war purposes, although definite information on the subject is lacking. So far as Great Britain is concerned, the Admiralty has established direction-finding wireless stations at the Lizard and at Carnsore Point; and it is also continuing for the present the stations at Berwick and Flamborough. Although a nominal fee of only five shillings is charged for giving a vessel a bearing by wireless, our merchant service does not appear so ready to take advantage of this assistance as it was anticipated it would be. This attitude of indifference is probably due to the value of the system not being understood sufficiently. Nevertheless, direction-finding wireless has proved of great help to the seaman on many occasions, and, beyond all doubt, will grow in favour as the mercantile marine becomes more familiar with its working.

The principal use of the system is to enable the bearing of a vessel in open waters, or when approaching pilotage waters, to be determined from one or more fixed points by intersection. All bearings thus obtained are the Great Circle bearings at the place of observation, which may be on shore or aboard ship, according to the method employed. If proper care be exercised, the average of error will be very small—less than one degree. Experience has shown that day readings over water are always trustworthy, and, unless high land is close to the vessel, day readings over land are approximately accurate. Night readings over water are approximately correct at short ranges of about one hundred miles; but night readings over land and over long distances are liable to error. Sunrise and sunset times should both be avoided, as bearings then obtained by wireless cannot be relied upon for accuracy.

There are at least three methods of using directional wireless to give ships their bearings and position. One requires no special apparatus in the ship, the others do. In the case of the first-mentioned, any vessel fitted with wireless telegraphy can call up a shore station and ask for a bearing. The station signals back that it is ready to give the bearing; then the vessel makes her call sign continuously for a short period, during which time the shore station ascertains the bearing by means of its direction-finder, or radiogoniometer, and then transmits to the vessel her true bearing with the time at which it was observed. Responsibility for accuracy rests, in this instance, upon the station. If the vessel requires simultaneous bearings from two stations in order to obtain her position, she calls up the

controlling station of the shore group and states her need. Both stations then determine simultaneously by their direction-finders the respective bearings of the vessel; the controlling station collects both bearings, and either transmits them to the vessel, with the time at which they were determined, or, if equipped with the necessary instruments for the purpose, the station fixes the position of the vessel as obtained from the bearings and sends the information to the vessel. The main disadvantage of this method is that only one ship at a time is able to call up a station. If more than one tried to do so, "jamming" might result. Further, the distance over which bearings can be obtained is limited to one well within the maximum range of the ship's installation. If the bearing only is transmitted,

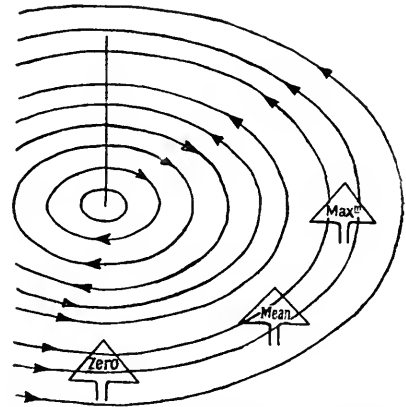

FIG. 1.—Field of magnetic lines of force through a loop aerial. This aerial may be regarded as inductive to the field of magnetic force of the advancing waves in certain positions, but as non-inductive in certain other positions. In the figure, for the sake of simplicity in drawing, it is assumed that the loop is being moved round the transmitting station so that its plane is pointing at the station at the right hand or maximum current position, and is facing the transmitter at the lower or zero current position.

the ship must be furnished with special charts or special tables of correction, as the bearings obtained are the Great Circle bearings at the shore station.

As to the station itself, it must have a direction-finding plant, as well as an ordinary wireless transmitting installation. The plant consists of wireless direction-finder set, tuning apparatus, receiving and amplifying set with accumulator batteries, dry batteries, etc., and a small power plant for charging purposes. Where two or more stations are grouped together for co-ordinate direction-finding work, the controlling one may be equipped with wireless transmitting apparatus, the others with direction-finding apparatus only, and be connected with the master station by telegraph or land telephone. Any ordinary shore transmitting station is suitable for undertaking communication with ships requiring bearings, so

that, as an alternative, two or more direction-finding stations of a group covering a certain area may be equipped with receiving gear only, and an ordinary separate transmitting and receiving station may undertake the controlling duty. A station may be self-contained. In such case the aerials for the direction-finding receiver and for the transmitter must be spaced a short distance apart, whilst the receiving and the transmitting apparatus must be housed in separate buildings, the whole of the receiving being done on the direction-finding receiving apparatus, and the transmitting apparatus being operated electrically from the direction-finding room.

A ship equipped with directional wireless apparatus can obtain bearings from any known ordinary wireless telegraphy shore station; but it is preferable that certain of these stations should be detailed to transmit, simultaneously or suc-

cessively, signals on given wave-lengths at definite times during each hour. This is known as the Beacon Station method. Only vessels fitted with direction-finding apparatus are able to use it. The apparatus comprises a twin direction-finding aerial system consisting of either suspended fixed wires or large rigid frames, together with wireless direction-finder, tuning apparatus, and receiving and amplifying gear, with batteries and charging plant. A cabinet for the apparatus and operator, and telephone or buzzer communication with the ship's steering position, are also necessary. Such an installation costs about 300l., apart from the expense of fitting it. Any number of ships can obtain bearings, or fix their position, at the same time from the same station by this method, and are able to do that over much longer ranges than is the case with the method first described. As,

however, ships using their own direction-finding sets are responsible for the accuracy of the bearings obtained by them, their staffs require some technical skill in the work, and it is necessary that the instruments should be calibrated and checked occasionally.

In the third method a rotating directional wireless beam having a fixed angular velocity is transmitted by a specially fitted fixed transmitting station. The rotating beam has a sharply defined zero direction which passes through North and South at given times. Knowing the angular velocity of the beam, and by observing the time interval between the given times at which the zero passes through North and South and the time at which the zero signals are received in the ship, the bearing of the station can be determined.

In order to ensure that the watches in the transmitting station and the receiving ship are synchronised, the station transmits a timing signal before commencing the rotating beam. To use this method, a ship must carry on her bridge a special watch, the face of which is marked in degrees; the scale corresponding to the angular velocity of the rotating beam. If this watch is started at the moment indicated by the timing signal, the bearing in degrees of the ship from the station can be noted from the watch at the moment when zero signals are received, and this bearing can be checked with subsequent zeros. During the war Germany had three stations working by this method, but Great Britain has none.

Aboard ship the simplest form of direction-finding apparatus is a single-loop aerial rotated round its vertical axis through a hori-

zontal scale. To increase the current through the loop, it is usual to tune the loop with a condenser to the wave-lengths required to be received, and instead of a single loop a frame fitted with a multi-turn loop may be used. In the Bellini-Tosi system, in place of a rotating loop aerial two fixed loop aerials are employed, these being connected to an instrument known as the radiogoniometer, or direction-finder transformer. Inside the latter is a small revolving coil attached to a pointer moving over a scale by which the direction of the signals can be determined. Since, however, the receptive powers of a comparatively small loop aerial, such as can be employed in direction-finding aboard ship, are very much inferior to those of the ordinary type of ship or shore station earthed aerial, a signal-amplifying apparatus employing several vacuum valves is an essential feature of the direction-finding receiver.

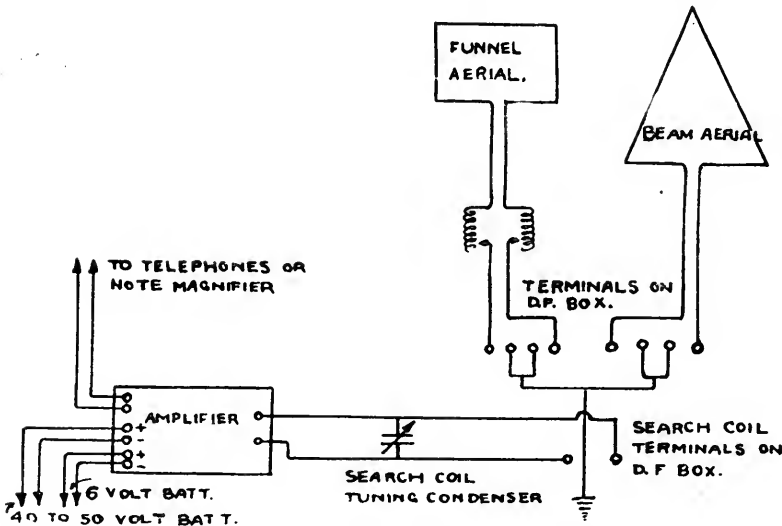

FIG. 2.—Simple circuit for aperiodic aerial and spark reception aboard ship. The beam aerial is rigged in the thwartship line so that it receives no induced signals from the ship. The funnel, or fore-and-aft, aerial receives signals direct plus induced signals from the ship. If the two aerials are adjusted to an equal sensitivity, they will always produce a resultant field in the direction-finding transformer in the same line as the incoming wireless wave, and the bearings obtained will be correct.

zontal scale. To increase the current through the loop, it is usual to tune the loop with a condenser to the wave-lengths required to be received, and instead of a single loop a frame fitted with a multi-turn loop may be used. In the Bellini-Tosi system, in place of a rotating loop aerial two fixed loop aerials are employed, these being connected to an instrument known as the radiogoniometer, or direction-finder transformer. Inside the latter is a small revolving coil attached to a pointer moving over a scale by which the direction of the signals can be determined. Since, however, the receptive powers of a comparatively small loop aerial, such as can be employed in direction-finding aboard ship, are very much inferior to those of the ordinary type of ship or shore station earthed aerial, a signal-amplifying apparatus employing several vacuum valves is an essential feature of the direction-finding receiver.

Cloud Forms.¹

By CAPT. C. J. P. CAVE.

MOST writers on clouds put forward their own system of classification, much to the confusion of the subject; Mr. G. A. Clarke is

cumulus, some giving details of structure, and some whole skyscapes of these the most beautiful of all the forms of clouds. Very

noticeable is the plate of cirro-stratus, "a thin whitish sheet of clouds," and therefore very difficult to depict satisfactorily. Mr. Clarke has carefully studied lenticular clouds and gives many examples, while in the text will be found a discussion of these extremely interesting and hitherto rather neglected forms of cloud; an example, perhaps the most striking photograph in the book, shows such a cloud with its front edge lit up by the setting sun, while part of its under surface, also in sunshine, is broken up by a double set of ripple marks (Fig. 1). There is no doubt that the cloud sheets have been rendered by Mr. Clarke better than has been done in any previous publication; but some of the photographs of cumulus leave something to be desired, chiefly owing to the use of a lens of too narrow an angle



FIG. 1.—Lenticular cirro-cumulus at sunset. From "Clouds."

therefore to be congratulated on adhering to the international classification in his recently published book. He says that even to divide the recognised types into sub-types makes the classification unwieldy, and is open to the objection that, "particularly in the case of the cirrus . . . one sub-type may be transformed into another and then perhaps return to its original form all within the space of a few minutes." He even suggests that any change should rather be in the direction of further simplification. In chap. ii. the international classification is given in full, so that for English readers Mr. Clarke's book may well supersede the Cloud Atlas, for the former contains all the essentials to be found in the text of the latter, and the illustrations cannot for a moment be compared. Where the atlas gives a few illustrations, some very indifferent, of each type, Mr. Clarke gives numerous examples that for variety, wealth of detail, and excellence of production easily surpass previous pictures.

for the size of the clouds; pictures of cumulus gain in effect if the main cloud does not fill up the whole of the picture. The most remarkable

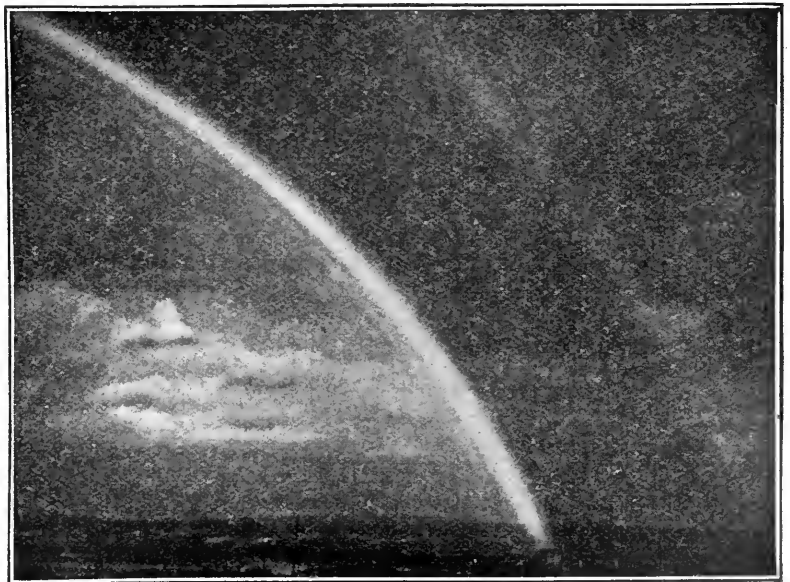

FIG. 2.—Rainbow on screen of rain falling in middle distance. From "Clouds."

plate in the whole book from a photographer's point of view is that which shows a rainbow on the shower from the base of a cumulo-nimbus cloud (Fig. 2); to show a rainbow, three super-

¹ "Clouds." By G. A. Clarke. Pp. xvi+136+40 plates. (London: Constable and Co., Ltd., 1920.) 21s. net.

numery bows, a secondary bow, and the lighter space inside the primary bow requires a photographic technique of a high order. It is with regret that we miss a chapter on cloud photography from the hand of such a master. Everyone has a slightly different technique, but Mr. Clarke unfortunately gives no hint of his own methods. The series of plates ends with some fine photographs taken by Capt. C. K. M. Douglas from an aeroplane.

There are also several coloured plates and drawings; the frontispiece is a delightful coloured sketch of a beam of a searchlight revealing two layers of fine condensation before striking the main cloud sheet; it vividly recalls a phenomenon which must have been noticed by many meteorologists during the war. Another very beautiful plate shows a halo, sun pillar, mock sun ring,

and two arcs of contact. The four sketches showing stages in the history of a line squall cloud are interesting as diagrams, but as pictures they make the clouds look too solid.

If more notice has been taken of the plates than of the text, it is because they form the most striking part of the book; but the text contains much interesting matter. Cloud forms are described, and use is made of recent researches into upper-air temperatures in explaining cloud phenomena. There are chapters on cloud distribution, and the association of cloud forms with weather types. Mr. Clarke has produced a standard book on cloud forms, not only for the meteorologist, but also for the general reader, who will surely find it an incentive to a further study of the weather. Author and publishers are to be congratulated on the excellence of the work.

Unveiling the Senussi Shrines.

By ARTHUR SILVA WHITE.

THE story of Mrs. Rosita Forbes's journey to the oasis of Kufra, situated in the heart of the Libyan Desert, constitutes the "something new out of Africa" of which few vestiges remain to be revealed. The three instalments recently published by the *Times*, under the title of "Secrets of the Sahara," contained the latest, and in some respects the only, information from a locality in the Libyan Desert unexplored since the visit of Gerhard Rohlfs in 1879.

Rohlfs made two attempts to reach Kufra. On the first he was turned back (although travelling under the protection of a *firman ali* of the Sultan of Turkey) from Aujila and Jalo because the Mojabra (slave traders) refused to give him a guide without Senussi's consent; and on the second attempt, when he succeeded in reaching Kufra, he was made captive and barely escaped with his life. Where Gerhard Rohlfs failed, and found no European successor for forty years, Mrs. Forbes has succeeded; but, it is to be noted, the reason for this remarkable achievement is to some extent explained by the total change of circumstances. In the interval between the two adventures, the Great War has resulted in the military conquests of France and Britain in that region of Africa and in the overthrow of the Senussi domination. Moreover, Mrs. Forbes had the supreme advantage of entering Libya at the psychological moment of complete accord (the ratification of a treaty) between Italy and the Grand Master of the Senussi Confraternity, whose personal support she obtained, and of travelling, not as a European, but as a Moslem in the interests of Islam—that is to say, practically as a Moslem convert or Senussi propagandist, since the Senussi commonly employ women in that capacity. That Mrs. Forbes could have kept up

this disguise through all the vicissitudes of travel and the dangers encountered is in itself one of the stories out of Africa which deserve to be remembered.

Mrs. Forbes, accompanied by Ahmed Bey Hassanein, an Egyptian (son of Sheikh Mahamed Hassanein el Bulaki, a professor at El Azhar University), started from Benghazi, the maritime terminus of the ancient trans-Saharan caravan route, and rode eighty miles south to Jedabia, where the desert journey began. Here she was hospitably received by Sidi Rida (brother of Sidi Idriss, the Sheikh es-Senussi or Grand Master), who made himself responsible for her caravan. But the usual delays, leading to divided counsels among the Senussi brethren (Khuan), necessitated a midnight flight in Bedwin disguise without a guide. After wandering round Jedabia for three hours, the fugitives found themselves only one mile away in the open desert when day dawned. Riding south for two days, accompanied by two trusted Senussi, they were joined by two black soldiers unprovided with rations. The party, numbering six, were saved from starvation by meeting with a Mojabra caravan, and together they travelled by short stages to the oasis of Aujila. Here they were caught up by the caravan prepared by Sidi Rida, who sent also a letter of introduction to the Kaimakam at Jalo, near by, the gate of the Libyan Desert.

The caravan, now fully organised, comprised eighteen camels, nine black servants, two slave-girls, a guide (Abdulla el Zawia), three Bedwin, Ahmed Bey Hassanein, and Sitt Khadija—"a Moslem of half English, half Egyptian blood"—otherwise Mrs. Rosita Forbes. For so large a party eighteen camels were far from adequate, especially as these were in bad condition, for a

journey in the Libyan Desert. Consequently, from the very outset privations overtook the party.

The first stretch across the desert, from Bir Battifal to the oasis of Taiserbo (which was passed unheeded), with no wells on the route, was accomplished with ever-increasing difficulties, owing apparently to the failure of the guide to pick up his landmarks and the consequent delays. It took nine days to reach El Harrash, where water was found, and two days more to reach Buzeima. Here, after the fatigues and sufferings of the march, a halt of three nights was called to rest the caravan. Four days onwards, passing through a region of sand-dunes, they came to Hawari, on the outskirts of Kufra oasis. Taj, the objective of their pilgrimage, lay more than twelve miles further south.

Intrigues and plots had to be faced and overcome before the guests of the Sheikh es-Senussi were allowed to continue their journey; and no wonder! Indeed, there must be a sharper cleavage than ever before between the more rigid Senussi of the banished Grand Master, Sayed Ahmed, who was answerable for the war against Egypt and the Nosrani (Christians), and the post-war adherents of the ruling Sheikh, Idriss, who, according to the doctrine of their Order, must be regarded as a renegade Senussi. In the precincts of the sacred city, Taj, our suspect travellers were on dangerous ground.

The Kaimakam of Taj, Sidi Saleh el Baskeri, after due inspection of their credentials, received the travellers well, and lodged Mrs. Forbes in the house of Sidi Idriss. In the home of the Sheikh es-Senussi this courageous young English-woman "lived the life," as she says, "of a veiled Arab woman of Taj for nine days, and visited the holy *Kubba* of Sidi el Mahdi," the son and successor of the founder of the confraternity. Of course, she was under suspicion, and fifteen tribal Sheikhs offered objection to her wandering abroad, since such a privilege is unknown to Arab women and the women of Taj. Nevertheless, a flying visit under the official auspices of the Kaimakam (presumably the Turkish Resident) was made to the west, a ride of seventeen hours, providing some interesting sight-seeing of which we may hope to hear later.

When the time came for her departure from Taj, Mrs. Forbes decided "to attempt to open up a new route to the north, hoping to facilitate future trade with Egypt." The route she selected and afterwards followed appears, however, to have been one of the direct routes (Kufra to Jarabub, Kufra to Siwa, and Kufra to Khargeh) reported to have been opened up by the Senussi, after their settlement at Jalo and Jof. These routes, as also that from Siwa to Farafra oasis, were at one time kept open for the use of all followers of the Prophet, so that even single travellers might use them and find refuge at the end of each day's march—at least, that was the boast of the Senussi, who undoubtedly did make

settlements for so-called slaves, and built cisterns along some new routes in the Sahara. Apparently, then, the direct route between Kufra and Jarabub, selected by Mrs. Forbes, fell into disuse (if used only by the Senussi family) in consequence of the absence of Sheikh el Senussi at the seat of war. That is my conjecture.

The homeward journey, starting from Hawari, was begun on January 25, 1921. Previously, Mrs. Forbes had sent back the soldier slaves and others to Jalo and Jedabia, and her new caravan for this hazardous journey to Jarabub comprised only nine camels. Besides herself and Ahmed Bey Hassanein, the party consisted of Yusuf, a Zawia student named Amar, and the guide Suleiman, an oldish man with defective eyesight. Zakar, a well that had not been used for four years, and, therefore, had to be cleared, was reached in four days; and from that spot onwards no well or cistern was available during the twelve days' march through the arid desert to the outlying parts of Jarabub. They carried twelve skins of water, dates for the camels, fuel, but no tents. Marching for thirteen hours daily, averaging thirty miles a day—presumably at night, to make such good progress—they endured great hardship on a simple and scanty diet. Sand-dunes both at the beginning and at the end of their journey were encountered. On the eleventh day from Zakar they entered broken country beyond the dunes, and stumbled upon Bir Salama (?Tarfaja), on the Jalo-Jarabub caravan route. Thence to Jarabub was but a day's march.

At Jarabub—the Mecca of the Senussi—which never before had been entered by a European, Mrs. Forbes was lodged inside the Zawia in a house belonging to the Khuan (brethren), and she was even permitted to kiss the tomb of the sainted founder and to visit the University quarter.

On February 13 the journey was resumed, and, with four camels and a guide, Mrs. Forbes came joyfully to Siwa under the escort of a Camel Corps patrol sent out to meet her. Thence, after a cordial reception from the officers at Siwa, she motored (new style) across the desert for 430 miles to Alexandria.

This bare recital of Mrs. Forbes's remarkable journey raises in the mind of one who knows something of the country and of the Senussi confraternity profound admiration for the woman who accomplished it; and further details of her experiences will be eagerly awaited. The information she brings from Kufra and Jarabub, in particular, will appeal to geographers, who will not be too critical as to her revision of the map unless other instruments than a magnetic compass were used by her. In addition, any information about the Senussi sect will prove of the highest interest, in view of the fundamental changes in their doctrine and policy superinduced by their defeat in the field under Turko-German leadership.

Obituary.

PROF. H. W. G. VON WALDEYER.

THE years of the war were disastrous to German anatomy, the deaths of men like Gaupp and Brodmann, Bütschli and Edinger, to mention only four, leaving gaps which have not been filled. But on January 23 of this year the Nestor of German anatomy, Geheimrath Heinrich Wilhelm Gottfried von Waldeyer-Hartz, died in the eighty-fifth year of his age, a month after Austria had lost one of her leading anatomists, Prof. Holl, of Gratz. Waldeyer was a man of genial and commanding personality, who, from the time he became professor of anatomy in Berlin in 1883, had been the recognised leader of German anatomists and biologists, and their spokesman at home and abroad. Even in his old age he was tireless in his attendance at congresses and scientific meetings, and undertook long journeys to all parts of Europe and poured forth fluent orations in sonorous and easy periods. But, apart from his gifts as an orator and congressman, Waldeyer had an exceptionally wide knowledge of anatomy, histology, embryology, pathological anatomy, and anthropology, in each of which he was regarded as an expert who could speak from a personal acquaintance with the facts.

Born on October 1, 1836, Waldeyer did not proceed to his doctorate until 1861, when he submitted to the Faculty in Berlin a dissertation "De claviculæ articulis et functione"; for when he entered the University of Göttingen he devoted himself to pure science, and then, from 1856 to 1858, to physiology and pathological anatomy. But during those years he came under the influence of the great Göttingen anatomist Henle, who was responsible for giving Waldeyer an aim in life and the inspiration to follow it. The next three years he spent as assistant to the anatomist Budge; then as an assistant for two years in the physiological institute at Königsberg, and for another year in a similar position under R. Heidenhain at Breslau, where in 1865 he was made extraordinary professor of pathological anatomy, and two years later an ordinary professor of the same subject. He held this position until 1872, and so great was the reputation he established as a pathologist that fifteen years after he had given up pathological for normal anatomy he was called to the bedside of the Emperor Frederick at San Remo as an impartial witness to settle the dispute which had arisen between the surgeons, British and German, as to the nature of the laryngeal growth from which the penultimate Kaiser was suffering. During the long tenure of his chair of pathology Waldeyer did not neglect his chief interest, normal anatomy and embryology; for during this period he wrote his famous work "Ueber Eierstock und Ei," illustrations from which have ever since been in every textbook of anatomy, histology, and embryology.

In 1872 Waldeyer for the first time was given charge of a department of anatomy: it was a position of quite exceptional difficulty and delicacy in the new school which the Prussians built up in Strassburg after wresting it from the French. Here Waldeyer displayed his remarkable abilities as a tactful administrator and peace-maker. So successful was he in this formidable task that in 1883, when the Prussian Government had another difficult problem to solve, to find a successor to the senile Reichert in Berlin, Waldeyer was appointed, although Koelliker, Gegenbaur, and His were senior to him and had a greater prestige as anatomists. Waldeyer had a very difficult task to reduce to order the chaos bequeathed to him by Reichert; but he set to work to build up a great institute, not merely of gross anatomy, but also of histology and embryology. Five years later he was able to secure the establishment of a second professorship of anatomy, to which O. Hertwig was appointed, to relieve Waldeyer of part of the work in histology and the whole of embryology. Waldeyer relinquished his position only about three years ago. In Berlin he came to be regarded as the father of German anthropology after the death of Virchow. He succeeded Max Schultze as editor of the *Archiv für mikroskopische Anatomie*; after His's death he became editor of the anatomical part of the *Archiv für Anatomie und Physiologie*, and after Virchow's death editor of the *Jahresbericht für die gesamte Medizin*. He also succeeded Du Bois-Reymond as the secretary of the Berlin Academy of Sciences, and was made a member of the Prussian Herrenhaus.

In spite of this overwhelming programme of disturbing engagements, and his ubiquitous presence and active participation in congresses at home and abroad, Waldeyer continued his work of original investigation, and published an unbroken stream of memoirs ranging over the whole of anatomy, histology, embryology, and anthropology. Almost every domain of anatomy that he invaded, whether it was the structure of fibrous tissue or bone, the development of teeth, the morphology of the reproductive organs, the comparative anatomy of hair, or the interpretation of the central nervous system, he reduced to order, and left some clarifying conception, and as a rule some new term, to clear away difficulties of interpretation. His work is so voluminous and many-sided that it is impossible to review it concisely. But his well-known efforts to clear up confusion on the subject of karyokinesis, and his attempt in 1891 to dissipate the chaos of interpretation of nervous structure by inventing the term *neurone* (Greek *νεῦρον*—German *Neurōn*—*anglice* *neurone*), are typical of Waldeyer's *métier*. If he was not a brilliant genius, he was a man of calm judgment and exceptionally clear insight. It was these qualities that made him so great a power in the modern

history of anatomy and the author of so many clarifying expressions of what other people were trying in vain to set forth.

As a lucid exponent and as a teacher he was pre-eminent. Many young anatomists have had occa-

sion to appreciate his fairness and his weighty help in defending themselves from attacks even from his own countrymen. With his death there passes away perhaps the most influential anatomist of modern times.

G. ELLIOT SMITH.

Notes.

THE large group of sun-spots which became visible a few days ago has been accompanied by disturbances of the magnetic and electrical conditions of the earth, manifested by magnetic storms, interruptions of the telephone and telegraph services over the greater part of the world, and brilliant auroral displays. Large sun-spots often appear without producing any such terrestrial effects, and magnetic storms sometimes occur in the absence of sun-spots, so that the relationship between the two phenomena is obviously exceptionable. There is evidence that solar prominences are more closely related to the production of magnetic disturbances on the earth than are sun-spots, which are only visible effects of solar disturbances the exact nature of which remains to be discovered.

THAT wireless telephony is fast emerging from the experimental stage into that of practical utility is evidenced by the interesting demonstrations, in which the *Times* participated last week, between stations equipped by the Marconi Co. at Southwold, in Suffolk, and Zaandvoort, in Holland. There is no technical reason why these stations should not be linked up with the ordinary telephone systems of Great Britain and Holland, so that it would be possible to communicate freely between any point in either country to any point in the other. It is interesting to note that the stations work on the short wave-length of 100 metres, which makes them free from interference from the 600-metre wave commonly used for marine communication and from the higher wave-lengths of the long-distance stations, as well as less likely to be influenced by stray disturbances than if a longer wave-length were employed. Other methods of protection against interference are being experimented with, and also of securing a greater degree of directive effect instead of broadcast emission, which, when such stations multiply, should contribute very materially to freedom from mutual interference. It is not generally known that wireless telephony is already employed by the Stock Exchange in Amsterdam for communicating prices to points all over Holland, and that these messages can be picked up in this country without difficulty. Dr. J. A. Fleming, the pioneer in the applications of the thermionic tube, upon which so much of the advance in wireless telephony is due, points out, in an interview in the *Times*, the great possibilities as well as the great achievements of wireless telephony, and emphasises its advantages over line-working in that no distortion of the wave is produced; as, in the case of wireless, all the harmonics are attenuated in the same proportion as the fundamental, because they are all propagated at the same rate.

NO. 2690, VOL. 107]

THE annual visitation of the Royal Observatory, Greenwich, will be held on Saturday, June 4. The observatory will be open at 3.30 for inspection by invited guests.

PROF. JOHN MERLE COULTER, of Chicago, Dr. Samuel Garman, Prof. Giovanni Battista Grassi, of Rome, Prof. Louis Alexandre Mangin, of Paris, and Prof. Jean Massart, of Brussels, have been elected foreign members of the Linnean Society of London.

At the anniversary dinner of the Royal Geographical Society, to be held at the Connaught Rooms at 7.30 p.m. on Tuesday, May 31, the guests will include the French Ambassador, General Bourgeois, Earl Beatty, Earl Buxton, Viscount Chelmsford, the High Commissioner for Canada, and Bishop Gore.

IN connection with the Royal Microscopical Society a Paper Industries Section is in course of formation. It will deal with researches relating to timber, wood-pulp, paper, etc. All interested in the subject and willing to assist are invited to communicate with Mr. J. Strachan, 74 Blenheim Place, Queen's Cross, Aberdeen.

THE CROWN PRINCE OF JAPAN, accompanied by Prince Kan-in and a large party, which included Admiral Ogouri and seven senior naval officers, visited Greenwich Observatory on Monday, May 16. The party was received by the Astronomer Royal, Sir Frank Dyson, and the two chief assistants, Mr. H. Spencer Jones and Mr. J. Jackson, and examined with interest the chief instruments in the observatory.

At the meeting of the Franklin Institute, Pennsylvania, held on May 18, the Franklin medal and certificate of honorary membership were presented to M. Jusserand, French Ambassador to the United States, for Prof. Charles Fabry, of the University of Paris, for his studies in the field of light radiation. The Franklin medal and certificate of honorary membership were also presented to Mr. Frank J. Sprague, New York City.

THE Wild Birds Advisory Committees appointed for England and Scotland by the Home Secretary and the Secretary for Scotland to advise regarding the protection of wild birds held their first meetings on May 12, and a joint meeting on May 13, when general questions of wild bird protection in Britain were discussed. The chairmen of the committees are Viscount Grey of Fallodon, K.G., and Mr. H. S. Gladstone, and the secretary of the Scottish committee is Dr. James Ritchie, Keeper of the Natural History Department, Royal Scottish Museum, Edinburgh.

THE prolonged pause in the seismic activity of the well-known Comrie centre seems to be coming to an end. Towards the close of a similar, but briefer, pause from 1801 to 1839 slight shocks gradually became more frequent, until they culminated in the strong earthquake of October 23, 1839. There was no pronounced movement between the summer of 1898 and that of last year. On July 21, 1920, a shock of intensity 3 (Rossi-Forel scale) occurred, followed by one of intensity 4 on September 14. On April 30 last a still stronger earthquake, the most distinct known to the present inhabitants, was felt at 10.35 a.m. (Greenwich mean time). The shock was strong enough to throw down crockery from shelves, and was accompanied by the usual sound, like the firing of guns.

MR. G. SHEPPARD, of Edmonton, Alberta, informs us that in view of the coming importance of the MacKenzie River Basin of the North-West Territory of Canada by reason of the oil strike made there in 1919, the Imperial Oil, Ltd., has purchased two monoplanes, which are to be used for general reconnaissance and topographical work in these unknown regions. An aerodrome has been established at Peace River Crossing, about 300 miles north of Edmonton, and from this base the planes will operate as far as Fort Norman and the Great Slave Lake areas. The journey takes, normally, three to four weeks under favourable conditions, but it can be made easily in three days by air. The aeroplanes are to be equipped with suitable cameras, by which it will be possible to photograph all water-courses and similar features of the landscape. These photographs will be of value to surveyors and others for checking up the country without using ordinary topographical methods.

At the annual general meeting of the Institution of Civil Engineers held on April 26, the result of the ballot for the election of officers for the year 1921-22 was declared as follows:—*President*: Mr. W. B. Worthington. *Vice-Presidents*: Dr. W. H. Maw, Mr. C. L. Morgan, Mr. B. Mott, and Sir William H. Ellis. *Other Members of Council*: Dr. C. C. Carpenter, Mr. G. M. Clark, Dr. P. C. Cowan, Col. R. E. B. Crompton, Mr. M. Deacon, Sir Archibald Denny, Bart., Mr. W. W. Grierson, Sir Robert A. Hadfield, Bart., Mr. K. P. Hawksley, Sir Brodie H. Henderson, Mr. E. P. Hill, Mr. G. W. Humphreys, Mr. S. Hunter, Mr. H. G. Kelley, Mr. C. R. S. Kirkpatrick, Mr. F. W. MacLean, Mr. H. H. G. Mitchell, Sir Henry J. Oram, Mr. F. Palmer, Mr. G. Richards, Capt. H. Riall Sankey, Sir John F. C. Snell, Mr. W. A. P. Tait, Mr. E. F. C. Trench, Prof. W. H. Warren, and Sir Alfred F. Yarrow, Bart.

THE members of the Gilbert White Fellowship have resolved to commemorate the bicentenary of the birth of the renowned naturalist whose name their organisation bears by erecting a permanent memorial at Selborne, and by undertaking a regional survey of the parish rendered famous by his great work, "The Natural History of Selborne." The memorial is to take the form of an outdoor bench or seat in stone and timber. The results of the regional survey

it is hoped to publish as the work proceeds, so as to make them immediately available to all interested. Many admirers of Gilbert White outside the circle of the fellowship are likely to be glad of the opportunity of taking part in this tribute to his memory. Such contributions as those interested may feel disposed to make should be sent to Messrs. Grindlay and Co., bankers, 54 Parliament Street, London, S.W.1, to be credited to the account of the Gilbert White Memorial Fund, or to the honorary secretary, Winifred M. Dunton, 18 Crockerton Road, Wandsworth Common, London, S.W.17.

AN important step has been taken in America for the presentation of science and scientific facts to the lay public by the formation of a Science Service (*Science*, April 8). The charter is a wide one, authorising the organisation to publish books and magazines, to conduct conferences and lectures, and to produce cinematograph films; the function will be that of liaison officer between scientific circles and the general public. The governing board will consist of ten men of science and five journalists, and any profits which may accrue will be devoted to the development of new methods of popular education in science. The present board of trustees consists of three representatives from the National Academy of Science, three from the American Association for the Advancement of Science, three from the National Research Council, three from the Scripps Estate, which is financing the undertaking, and three professional journalists, under the presidency of Dr. W. E. Ritter, director of the Scripps Institution for Biological Research of the University of California. Dr. Edwin E. Slosson, who for some twelve years was professor of chemistry in the University of Wyoming, and for the past seventeen years has been literary editor of the *Independent* of New York, has been chosen as editor. At present the Science Service will not publish any periodical of its own; it is considered that better results will be obtained by directing attention to the various journals of popular science already in existence, and by supplying newsagencies with authentic, popular articles. The headquarters of the institution have been established provisionally in the building of the National Research Council, 1701, Massachusetts Avenue, Washington, D.C.

DR. T. W. FULTON, scientific superintendent of the Fishery Board for Scotland, has just retired after a service of thirty-four years. The Scottish Scientific Department owed its institution to the recommendation of the Dalhousie Trawling Commission, and in 1888, when Dr. Fulton was appointed, had been in existence for only a few years. In England the scientific study of the sea in connection with fisheries was taken up by the Plymouth Laboratory, and later by certain of the Sea Fisheries Committees, two of which, those of Lancashire and Northumberland, have much good work to their credit. The fisheries are a very intricate, many-sided subject, and Dr. Fulton has laboured to solve many problems which have cropped up in the Scottish administration. The attempt has been made to render the statistics as

accurate and informative as possible in an industry which does not lend itself readily to minutely made records. In order to locate the regions in which the fishes were captured by means of the trawl, Dr. Fulton devised the scheme subdividing the North Sea into equally sized divisions numbered consecutively. This arrangement was adopted and found to be of great service. Dr. Fulton has served during the past twenty years as one of the experts on the International Committee for the Exploration of the North Sea, a body which has published many important reports dealing with fisheries biology. In 1911 a Departmental Committee of which he was a member inquired into the Scottish fishing industry; the wide extent and thoroughness of its labours are indicated by the large report which it issued. Dr. Fulton's publications deal with the development, distribution, and migrations of fishes; they are numerous and of great interest and value.

In an account of the leeches of the Chilka Lake (in the province of Bihar and Orissa) Mr. W. A. Harding records (Memoirs Indian Museum, vol. v., 1920) the occurrence of a colour variety of *Glossosiphonia heteroclita*, a species well known to occur in fresh-water in North America and throughout the greater part of Europe, but now recorded from India for the first time. Mr. Harding has received examples collected in many other parts of India, and the species is evidently widely distributed there. A new species of *Piscicola*, from fish, and one of *Placobdella*, from mud-furtles of the genus *Emyda*, are also described.

As a result of the late war and the consequent dearth of foodstuffs in certain parts of Central Europe, increased interest is being aroused in the wider utilisation of wild plants—more especially fungi—as food for human consumption. An association has been formed in recent years, having its headquarters in Heilbronn a. N., styled the "Pflanz- und Kräuterzentrale," amongst the main objects of which are the fostering of the study of fungi and the dissemination of information, particularly as regards the nutritious qualities of the various edible kinds and the properties of those that are noxious or specifically poisonous, amongst the lay public. In furtherance of its aims a congress of mycologists is being arranged under the auspices of the association to be held in Nürnberg during the coming autumn. The association issues a monthly periodical, *Der Pflanz- und Kräuterfreunde*, now in its fourth year of publication. The articles in this periodical are naturally more or less of a popular nature, but descriptions of new fungi are also included. One of the recent issues contains a description, with a coloured plate, of a new poisonous species of agaric, *Inocybe lateraria*. In the list of supporters of the association are to be found such well-known names as Günther-Beck v. Managetta, Bresadola, Falck, and Lindau.

THE National Institute of Agricultural Botany has recently published the report of its Potato Synonym Committee for the year 1920. The necessity for reducing to order the chaos existing in the nomenclature of potato varieties has become more urgent than ever

in recent years, owing to the fact that some varieties are immune to the dreaded wart disease, while others are susceptible. Two hundred and forty-two varieties are dealt with in the report, and they are classified in forty-two groups. Immunity or susceptibility to wart disease is generally indicated. In a large number of cases the varieties, although possessing different names, were found to be indistinguishable in morphological and certain physiological characters (such as time of maturity, immunity or otherwise to wart disease) from well-known types such as "Up-to-Date," "Abundance," etc., so that in practice one and the same variety may possess many names. It is proposed to publish an annual handbook of potato synonyms, the practical value of which will be considerable. Nevertheless, it is to be hoped that the institute will not rest content with a mere indexing of names. What is really required is a detailed and scientific monograph of the leading types of potato varieties at present in cultivation, with adequate illustrations and descriptions of their differentiating characteristics. The preparation of such a monograph would entail a considerable amount of additional effort; but a better opportunity for embarking on such a project is scarcely likely to occur than that now presented by the work of the National Institute at its Ormskirk Trial Grounds, while it would be difficult to find men more thoroughly equipped for the enterprise than those who form the Synonym Committee.

THE annual report of the Marlborough College Natural History Society for the year ending Christmas, 1920, has just been received. It forms an interesting record of the work carried out by this active and vigorous association. No fewer than fourteen papers were read to the astronomical section dealing with such diverse subjects as the moon, stellar photometry, tides, and relativity. The botanical, ornithological, and entomological sections also receive notice in the report. Their activities were confined mostly to recording the appearance of plants, birds, and insects in the neighbourhood, and the results provide useful contributions to the knowledge of the local natural history. The report concludes with a summary of the meteorological observations made at the college during the year; maximum, mean, and minimum barometric and thermometric readings for the several months are given, together with remarks on observations of wind, rainfall, and sunshine for similar periods. We are glad to see that this useful society is, according to the annual balance-sheet, in a sound position and proposes to carry on and, if possible, extend its labours to other branches of natural history.

THE Queensland Museum recently obtained from post-Tertiary sand on the Darling Downs a marsupial cranium apparently of the species *Nototherium dunense*, founded by De Vis in 1887 on some mandibles and cranial fragments. The new skull is described and figured in the Memoirs of the museum (vol. vii., part 2) by the director, Mr. H. A. Longman, who feels impelled to establish for the species a new genus, *Euryzygoma*. The character that suggests the name is the enormous relative width given to the skull by

the extension, from the lower outer angle of each cheek-bone or zygomatic arch, of a large side-process buttressed by a horizontal platform beneath the orbit. Mr. Longman considers that these processes were for the support of large cheek-pouches, as in the pocket gophers of North America. However that may be, such extensions are characteristic of the *Nototheres*, and an exaggeration of the character, with the correlated modifications, would scarcely warrant the generic separation of this species from *Nototherium*

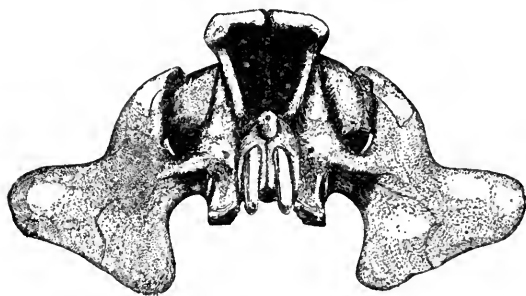

Front view of the cranium of *Euryzygoma*, slightly restored.
Actual width 680 mm.

Mitchelli and *N. tasmanicum*. Mr. Longman, however, states that the upper premolar tooth, on which some stress has been laid by classifiers of marsupials, is oval in the normal *Nototherium*, but subtriangular in *Euryzygoma*. From the half-tone reproduction of a greatly reduced photograph it is impossible to check the alleged differences. In all other technical respects Mr. Longman's presentation of his results calls for praise. He is also to be congratulated on an interesting discussion of the most remarkable Diprotodont yet discovered.

ALASKA magnetic tables and magnetic charts for 1920 have been published by the U.S. Coast and Geodetic Survey as Special Publication No. 63, prepared by Daniel L. Hazard, Assistant-Chief, Division of Terrestrial Magnetism. Charts are given for the several magnetic elements, declination, inclination or dip, and horizontal force or intensity. The area covered by the discussion includes not only Alaska, but also its boundary waters, parts of the North Pacific, the Bering Sea, and the Arctic. Declination and dip are given on the charts to each 1° and the horizontal force for intervals of 0.01 C.G.S. unit. Results are for observations since 1870, and the data now published are said to be sufficiently numerous to show areas of local disturbance, some of which are remarkable. Lines of equal annual change of declination are shown on the isogonic chart, but they are stated to be only rough approximations to the truth. East declination is decreasing in Alaska except in the south-eastern portion, where the change is negligible. It is not considered advisable at present to attempt to draw lines of equal annual change of dip or of horizontal force. The tabular matter shows that the dip appears to be decreasing in the greater part of Alaska at the rate of 1' or 2' a year, and that the annual change of horizontal intensity is decreasing in the southern part of the territory and increasing in the northern, but the rate of change is small.

WE have received from Dr. J. Newton Friend a copy of his paper entitled "Iron in Antiquity," reprinted from the Transactions of the Worcestershire Naturalists' Club. Dr. Friend recalls the statement of Cæsar that the Britons were accustomed to use bars of iron in place of coins as currency. Several hundreds of these, which have escaped, more or less, the ravages of time, have been found and placed in different museums, notably the British Museum and the local museum at Worcester. They resemble swords and consist of a flat and slightly tapering blade with blunt vertical edges. Owing to corrosion all the bars have suffered some loss in weight, but many of them have been only slightly oxidised, and a rough estimate of their original weight can be made. The weights are found to approximate 309 grams, or some multiple or sub-multiple of this amount. In all, six different denominations have been found. In spite of their resemblance to swords, Dr. Friend advances good reasons for considering that these are the currency bars referred to by Cæsar, the use of which, indeed, dates back to the early Greeks, and survives to-day in some parts of Africa. His paper also deals at some length in an interesting way with early British water-clocks.

THE Dewey decimal system of classifying books in a reference library is being adopted in America, and modifications of it are widely used. The radio laboratory of the Bureau of Standards has extended this method and applied it to the classification of books and pamphlets in its library. In the Dewey classification "radio" would be represented by 621.384. The number 600 denotes the class (useful arts), the number 20 denotes the division (engineering), and the number 1 denotes the section (mechanical). Similarly, 0.300 stands for "electrical," 0.080 for "communication," and 0.004 for "radio." As the library is a collection of matter dealing with radio, the number 621.384 is denoted by R, and a further number of three figures is added. For instance, R211 stands for "resonance methods of measuring wavelengths." R200 contains information on "radio measurements and standardisation," R10 denotes "theory," and R1 "statistics." An essential part of the method is the alphabetical index. We look up, for instance, "resonance methods" and find R211. This gives us the number of the shelf in the library on which the required books or pamphlets will be found, the shelves all being classified in numerical order. The books on the adjacent shelves also treating of cognate subjects can sometimes be usefully consulted at the same time. The classification is good and the alphabetical index very complete. We missed, however, the word "thermionic."

MESSRS. C. BAKER, of 24 High Holborn, W.C.1, have issued a new edition (No. 72) of their catalogue of second-hand scientific instruments. As is customary in these lists, the items are grouped in sections according to the subjects with which they are related. Twelve such sections appear in the list before us, five of which deal with apparatus which may be classed as physical. Section I., dealing with microscopes and their accessories, includes particulars of

a number of microscopes both large and small, and a long list of object-glasses, eye-pieces, condensers, etc. The astronomical section (No. III.) describes numerous telescopes of different types and a very varied collection of eye-pieces. Section VII. is devoted to what may be termed academic physical apparatus, and Section X. to photographic apparatus. The book list (Section XI.) includes a number of books and journals, among which we notice vols. xxviii.-civ. of NATURE.

MESSRS. G. BELL AND SONS will publish next month "Motya: A Phœnician Colony in Sicily," by Joseph I. S. Whitaker (of Malfitano, Palermo). Motya was one of the latest sites occupied by the Phœnician colonisers of Sicily. Though its exact position was long a matter of doubt, it is now identified by archaeologists with the small island of San Pantaleo at the north-west extremity of Sicily. Recent excavation undertaken by its owner, Mr. Whitaker, has confirmed this conclusion, and the forthcoming volume contains a detailed account of his discoveries.

IN a paper entitled "Studies on Phototropism in Solution," part i. (Journ. Amer. Chem. Soc., vol. xliii., 1921), Prof. B. K. Singh indicates some interesting cases of phototropism in solution which he is investigating, and points out that his preliminary results do not fall into line with Senier and Shephard's

explanation that phototropic transformations are due to extramolecular rearrangements.

UNDER the title *Dactylography* a bimonthly magazine is to appear on July 1. It will deal chiefly with the evidence for criminal and other identifications by means of finger-prints; but attention will also be given to a study of the detective aspects of footprints, tattoo marks, deformities, and related matters. The magazine will be conducted by Mr. Henry Faulds, Regent House, Hanley, Stoke-on-Trent.

MR. F. EDWARDS, 83 High Street, Marylebone, W.1, has issued at an opportune moment an interesting catalogue (No. 413) of nearly four hundred entries of books, manuscripts, letters, documents; and engravings relating to Napoleon and his times. Many choice works are offered for sale. The list can be obtained free of charge.

MR. P. BRUCE WHITE directs attention to a misinterpretation indicated by a sentence in the article on researches on bee disease in the issue of NATURE for April 28, p. 284. Instead of "The tracheæ become darkened and ultimately black by the increasing deposition of chitin," it should read: "... by the increasing amount of faecal matter deposited by the mites."

Our Astronomical Column.

COMETS.—A new comet 1921c was discovered by M. Dubiago, Petersburg, on April 29. The following orbit has been received by telegram:—

$$\begin{aligned} T &= 1921 \text{ May } 7^{\text{h}} 6^{\text{m}} 11^{\text{s}} \text{ G.M.T.} \\ \omega &= 104^{\circ} 45' \\ \Omega &= 66^{\circ} 4' \\ i &= 21^{\circ} 42' \\ \log q &= 0.02731 \end{aligned}$$

Ephemeris for Greenwich Midnight.

	R.A.	N. Decl.	Log r	Log Δ
	h. m. s.	° ' "		
May 20	8 56 45	39 46	—	—
24	9 21 6	37 33	0.0419	9.9661
28	9 44 44	34 58	0.0492	9.9620

Herr Reinmuth, of Königstuhl, obtained a twelve-minute exposure plate of Reid's comet on April 30. It shows a faint tail 40' long in P.A. 266°, slightly curved at its extremity towards smaller P.A. There is also a group of short streamers with centre in P.A. 225°.

Corrections to the ephemeris of Pons-Winnecke:—May 22, $-3\frac{1}{2}$ m., $-1^{\circ} 0'$; May 26, -45 m., $-5'$; May 30, -59 m., $+1^{\circ} 43'$. It is a curious coincidence that the three comets now visible are all circumpolar, and their perihelion distances are nearly equal, all being slightly in excess of unity.

Mr. Denning writes that on April 10 Winnecke's comet was an easy object in a 6½-in. refractor, power about 20. The comet was estimated to be about 9th magnitude, and some 5 or 6 minutes of arc in diameter, though it was difficult to define exactly the outer faint limits of the nebulosity. As the comet is brightening, it should become rather conspicuous even in small telescopes after the present moon has left the evening sky, on about May 25. On that date the comet will be 17 millions of miles from the earth, and its position in the heavens will be two degrees south of δ Cygni.

It is travelling rather swiftly to the south-east, and on May 30 will be eight degrees south-south-east of α Cygni. It will then probably be about 7th magnitude, but many comets vary in their light in an inexplicable manner.

THE ECLIPSING VARIABLE U CEPHEI.—The study of eclipsing variables, from which a large amount of information on the sizes, densities, and brightness of the components may be gained, played a large part in the development of the theory of giant and dwarf stars. It is therefore not surprising that Mr. R. S. Dugan, one of the assistants of Prof. H. N. Russell at Princeton, has produced a monograph on U Cephei. The eclipse of the primary star (which is of type A₀) is total, so that we get the spectrum of the secondary isolated. Miss Cannon has recently determined its type as K₀. Since this is the larger star, but the less luminous, both would appear to be in the giant stage.

The light-comparisons were made visually, and in the course of them reason was found to suspect the variability of B.D. 81.27° and 81.30°. The secondary minimum, being an annular eclipse, gives information as to the degree of darkening at the limb. In the final elements the limb-light is taken as one-third of that at the centre. The orbit is sensibly circular; taking its radius as unity, the radii of the stars are 0.20 and 0.32, and the inclination of orbit plane 86.4°. The densities are (somewhat conjecturally) given as 0.214 and 0.022 of that of the sun. From asymmetry in the light-curve it is concluded that the bright star rotates more rapidly than the period of revolution, producing a tidal lag of 24°. A further result of tidal friction is traced in the lengthening of the period of variation by 9 seconds in 60 years; this is indicated with considerable probability by some early observations of magnitude by Schwerd and Carrington. The system thus furnishes an interesting illustration of tidal evolution.

Æther Waves and Electrons.¹

By SIR WILLIAM BRAGG, K.B.E., F.R.S.

NEWTON put forward a corpuscular theory of light, and Huyghens believed that it was essentially a wave motion. Each gave wrong reasons for his belief. Newton argued that it ought to be possible to see round a corner, since the passage of waves round a corner was a common effect. Huyghens declined the corpuscular theory on the grounds that corpuscles could not go fast enough, and that if two people looked into each other's eyes the corpuscles must hit each other and prevent mutual vision. But the wave theory carried all before it, and, developed by Young, Fresnel, and other workers, proved to be capable of explaining optical phenomena in perfect fashion.

With the advent of X-rays and radio-activity the process of radiation as a whole is seen to depend in part on the movement of electrons. In the X-ray bulb, to take an example, a stream of electrons, which is truly a corpuscular radiation, strikes a block of metal in the centre of the tube. Energy of radiation is carried outwards through the walls of the tube in the form of X-rays; that is to say, of wave motions in the æther. When they strike matter, such as the film of a photographic plate, the wave radiation disappears and is replaced by moving electrons which produce all the well-known effects ascribed to X-rays. It is probable that this mutual plane of waves and electrons is carried throughout the whole realm of radiation, and the ultimate explanation of all optical problems must involve the recognition of corpuscular

¹ Summary of the Robert Boyle lecture delivered at Oxford on May 12.

radiations, at times replacing and being replaced by the waves. Thus once more the corpuscular theory appears again as a working hypothesis.

But in its relation to the wave theory there is one extraordinary and, at present, insoluble problem. It is not known how the energy of the electron in the X-ray bulb is transferred by a wave motion to an electron in the photographic plate or in any other substance on which the X-rays fall. It is as if one dropped a plank into the sea from a height of 100 ft. and found that the spreading ripple was able, after travelling 1000 miles and becoming infinitesimal in comparison with its original amount, to act upon a wooden ship in such a way that a plank of that ship flew out of its place to a height of 100 ft. How does the energy get from one place to the other?

Very lately considerable new information has come to hand regarding the way in which atoms play a part in this extraordinary transference of energy. In many ways the transference of energy suggests the return to Newton's corpuscular theory. But the wave theory is too firmly established to be displaced from the ground that it occupies. We are obliged to use each theory as occasion demands and to wait for further knowledge as to how it may be possible that both should be true at the same time. Toleration of opinions is a recognised virtue. The curiosity of the present situation is that opposite opinions have to be held and used by the same individual in the faith that some day their combined truth may be made plain.

The Natives of the Gilbert Islands.

AT a meeting of the Royal Anthropological Institute on April 21, Dr. W. H. R. Rivers, president, in the chair, Mr. Arthur Grimble read a paper entitled "From Birth to Death in the Gilbert Islands." The paper, which was of considerable importance, as it dealt with a people about which we possess little information, described in detail the ceremonies used at marriage, birth, and death by the Gilbertese-speaking communities.

The rules relating to consanguinity among the Gilbertese are genealogical in character, and evidently allied to the Polynesian systems as typified by the Samoan; but the concubitant relations which exist between a man and his wife's sisters are of a type generally found in Melanesian communities. An extremely interesting relationship is that of *Tinaba*, under which a woman owes both filial and sexual duties to the brothers of her husband's father and a man to his wife's mother's sister. Incest is regarded with horror, and the hatred of the sun for incestuous couples is much stressed in native myth.

There were several forms of marriage ceremony in vogue. On certain islands marriage by capture was practised. Rather more common was the fishing fiction, in which the suitors seated in a loft let down lines into the room underneath, where the girl made a pretence of being caught by one of them. This act was succeeded by the anointing of the couple with coco-nut oil, and the union was complete. The most usual form of ceremony, however, was that known as *te iein*, of which the essential motive was to test the virginity of the bride. After birth mother and child

remained for three days in the place of confinement, while the infant's soul was encouraged into its body by merrymaking, in which fire played an important part.

A boy's training was conducted with the view of excluding all sexual interests. The cutting of his hair from time to time was performed with rigid ceremonial, until the climax was reached in the initiation ceremonies (which were chiefly trials by fire) undergone when his pectoral and axillary hair was well in evidence. After submitting to these ordeals he was isolated until he passed certain tests of strength and endurance. He would then be allowed to marry.

A girl on reaching the age of puberty was isolated in a darkened room for the purpose of bleaching her skin and thus rendering her like the fair-skinned ancestral gods of the race. On release from the bleaching-house she was ready for marriage.

Great precautions were taken at death to drive away the soul. The body was usually buried on the fourth day, sometimes on the tenth; occasionally it was sun-dried and kept for a number of years. The skull was often kept. In the lagoon islands the body lay on its back, fully extended, with toes pointing up; on Banaba the knees were flexed outwards in a frog-like position.

The paper closed with a summary of the beliefs concerning the destination of the departed spirit and of the possible inferences which may be drawn therefrom. The names of the various bournes of the dead have an extraordinary resemblance to certain place-names in Indonesia.

Parliamentary Visit to the Rothamsted Experimental Station.

ON May 13 the Minister of Agriculture (Sir Arthur Griffith-Boscawen) and the Agricultural Committee of the House of Commons, together with members of the House of Lords interested in agriculture, visited the Rothamsted Experimental Station at the invitation of the chairman, the Right Hon. Lord Bledisloe, and the director, Dr. E. J. Russell.

Fortunately the weather was fine, and the plots were inspected under favourable conditions. The fields visited included those in which the classical experiments on the growth of wheat, barley, and meadow-grass are conducted, and the salient features were demonstrated by members of the staff. Other experiments were shown to ascertain the comparative fertiliser effects of ammonium chloride and ammonium sulphate on cereals and potatoes, the effects of potassium and magnesium salts on potatoes, the most suitable time of application of nitrogenous fertilisers to cereals, and the relationship between the quantity of fertiliser used and the crop obtained, the last being particularly interesting inasmuch as the effectiveness of small and moderate dressings increases more rapidly than the dressing, while with larger quantities the effectiveness falls off. The experiments on electro-culture were demonstrated, as also was the recent work on the production of farmyard manure without the intervention of animals.

The whole of the laboratory work was seen, ranging over the chemical, physical, statistical, and biological sciences, the last including bacteriology, botany,

entomology, mycology, and protozoology. Many interesting specimens were shown, and there were other exhibits to illustrate the work going on in the study of the soil, the growing plant, and plant diseases.

In his speech after lunch Lord Bledisloe welcomed the guests and expressed the hope that this first visit would be followed by many others of those members of both Houses of Parliament interested in agriculture. He directed attention to the report shortly to be issued, in which the work is discussed in full detail and its bearing on agricultural practice indicated. Dr. Russell outlined the more important investigations now proceeding, and emphasised the necessity for the development of a sound agricultural science which could be of use to the teacher, the expert adviser, and the progressive farmer.

The Minister of Agriculture expressed his recognition of the great importance of the work being done at Rothamsted and other research institutions, and emphasised the fact that in such work lies one of the best hopes for agriculture. Legislative enactments are of course essential, but they cannot provide the material for progress and development that is furnished by sound scientific investigation. Although the necessity for economy in every branch of public activity was insistent, he would, so far as it lay in his power, see to it that agricultural research should not be called upon to suffer in the name of a false economy.

Habits of the Hedgehog.

THE Memoirs and Proceedings of the Manchester Literary and Philosophical Society for 1918-19 contain a paper by Mr. Miller Christy on "The Ancient Legend as to the Hedgehog Carrying Fruits upon its Spines." In the introduction to his paper Mr. Christy pointed out that the legend is very old, and that it is important to remember that since the hedgehog is almost wholly a nocturnal animal it is difficult to verify statements regarding its habits by actual observation. The earliest recorded statement that hedgehogs carry fruit on their spines was made by Pliny the Elder; Claudius Aelianus, who wrote about A.D. 250, relates a similar tale. No further evidence is recorded until the twelfth century, while during the Middle Ages a number of writers and poets of many countries related stories of hedgehogs carrying various fruits in this way. Mr. Christy takes the view that most of these people copied blindly the statements of their predecessors. Of the more modern naturalists Buffon discredited the legend, though other naturalists of his time stated definitely that they had witnessed the transportation of fruit by these means. Among present-day writers on natural history little credence is given to the tale, though two cases are reported in which the evidence in support is regarded as trustworthy. We reprint below the substance of the summary of the evidence and the conclusions based thereon with which Mr. Christy concluded his paper.

The hedgehog-and-apples legend is at least two thousand years old—more if it originated with Aristotle, as has been stated; also it is prevalent throughout practically the whole of Europe. There must have been (one would think) some substratum of actual observed fact, renewed from time to time, to keep any legend of the kind alive so long and to

cause it to become so widespread. Nevertheless, it cannot be denied that most modern writers on mammals, if they refer at all to the old legend, either dismiss it as too absurd to be worth a moment's consideration or at least show themselves decidedly sceptical.

But is the story really so incredible, after all? Are we not apt, in these highly scientific days, to become too contemptuously sceptical in regard to all ancient legends of the kind, and to forget that, however absurdly improbable they may appear at first sight, not a few of them have been shown to have some genuine basis in fact—often slight, but sufficient to substantiate and justify them? In all such cases a cautious scepticism should be, of course, maintained up to a certain point; but it is well to remember a dictum to which the late Prof. Huxley gave utterance many years ago: "I have always felt a horror of limiting the possibilities of things."

But before accepting the old legend unreservedly, there is one point which requires first to be considered: Does the hedgehog ever eat fruit? As to this crucial question many contradictory opinions have been expressed. The truth seems to be that the creature undoubtedly affects, in the main, an animal diet, consisting chiefly of small reptiles, worms, snails, slugs, insects, beetles, birds' eggs, and the like. In confinement it will readily eat meat, either cooked or uncooked, bread and milk, and many such substances as are usually given to cats and dogs. Its partiality for eggs has gained for it a very bad name among gamekeepers, poultry-keepers, and such people. In all probability, however, the robberies of eggs from the nests of game-birds and poultry which are usually ascribed to it will readily eat meat, either cooked or uncooked, bread and milk, and many such substances as are usually given to cats and dogs. Its partiality for eggs has gained for it a very bad name among gamekeepers, poultry-keepers, and such people. In all probability, however, the robberies of eggs from the nests of game-birds and poultry which are usually ascribed to it

On the other hand, there is equally little doubt that on occasion the hedgehog will readily subsist on a vegetable diet. Knapp says ("Journal of a Naturalist," third edition, 1830, p. 130): "In the autumn crabs, haws, and the common fruits of the hedge constitute its diet." Macgillivray asserts ("British Quadrupeds," 1838, p. 119) that it "eats fruits, especially apples that have fallen from the trees."

Yet another cognate point which has to be considered is: Does the hedgehog lay up a store of food for the winter? Obviously, of animal food *he could not*. Of vegetable food, however, *he might*, and some writers have stated explicitly that he does. Yet others of at least equal authority have stated that he does not; and the author agrees with them. He has seen many nests of hedgehogs dug out of rabbit-holes when ferreting in winter, but none has ever been accompanied by a store of winter food. It is on this account, no doubt, that the animal's hibernation is by no means complete, and that he sometimes leaves his winter nest and comes abroad even on cold days. Probably the fruit of various kinds which hedgehogs have been seen carrying on their spines has been intended by them rather for immediate consumption than as winter sustenance.

Several friends and correspondents of the author—some excellent naturalists among them—have advanced the argument that, as they have kept many tame hedgehogs and have never observed them even attempting to transport fruit on their spines, the habit cannot be one they practise in a state of nature. This argument seems to be entirely unsound. The habits of animals in nature and in confinement are often different; and in this particular case it may be urged that a hedgehog in confinement, being (in a way) at home, would scarcely be likely to feel a need to carry food home.

From the foregoing it becomes clear that there are, beyond doubt, not a few cases, both ancient and

modern, in which a hedgehog has been *actually seen* carrying objects impaled upon the spines upon its back—in most cases various kinds of fruit; in one case eggs of the pheasant. Unfortunately, none of these observations (though made by persons whose *bona fides* is in little doubt) can be regarded as wholly conclusive, all being to some extent second-hand or made by persons of little education. Nevertheless, taking them in the mass and viewing them in conjunction with the very ancient and extremely persistent legend relating to the matter, it seems impossible longer to doubt that, *at times at any rate*, the animal really does transport fruit in the way asserted.

There is yet another legend pertaining to the hedgehog (and almost as ancient and widespread as the fruit-carrying legend), namely, that it sucks the milk of cows grazing in the fields. This statement, in the crude form in which it is usually made and understood, is a manifest impossibility. In the first place, no hedgehog by stretching up would be able to reach the teats of any cow of ordinary stature; and, even if it could do so, the fact remains that the hedgehog's mouth is far too small to allow it to suck milk effectively from the teats of any such cow.

Nevertheless, the legend in question is probably true in a way, and a perfectly natural explanation as to its origin can be given. We know well, from the evidence of hedgehogs kept in confinement, that the animal is exceedingly fond of milk; and there can be no possible doubt that, in a state of nature, it would take every opportunity to secure milk. Obviously, it could do this only when a cow was lying down. In such a case, as is well known, milk often runs from the teats of a milch cow; and there can be little or no doubt that the milk-sucking legend has originated in the fact of a hedgehog having been seen sucking drops of milk from the teats of a recumbent cow or from the ground immediately after she has risen.

The "Flight" of Flying-fish.

A PROPOS of the recent correspondence concerning the "flight" of flying-fish, Prof. W. Galloway has sent us a copy of a paper ("The Flying-fish," Trans. Cardiff Nat. Soc., vol. xxiii., 1891) in which he discussed the whole subject thirty years ago. His own observations, made from the bows of a ship, are in agreement with those of Prof. Wood-Jones and of Mr. J. S. Huxley: the impetus is given by the tail, the pectoral fins are used as planes, and new impetus can be gained by immersing and vibrating the lower lobe of the tail. Prof. Galloway adds further interesting particulars. Changes of direction made in air are usually slight, the fish describing arcs of very large radius; if a sudden change is required, the fish drop into the water, to emerge almost instantly headed in the new direction. The ordinary velocity of flight is from 25 to 35 miles per hour. When the wind is very strong (25 to 30 miles per hour) the fish are unable to rise with it, falling back into the water almost immediately. When, therefore, they are startled by a ship travelling with a strong wind, they rise *against* the wind, and then, having gained sufficient velocity, tilt right or left to describe a semicircle with radius of 40 or 50 ft. and sail down-wind for very long distances (200-300 ft. or more); if desirous of flying again they do not attempt to drop their tail into the water, but submerge totally, leap out once more against the wind, and once more turn. Prof. Gal-

loway also summarises the previous literature. One point deserves mention. Möbius (*Zeit. wiss. Zool.*, vol. xxx., 1878, Suppl., p. 343) agrees with various observers that marked vibration of the pectoral fins may and does occur (Prof. Galloway states that it usually does so immediately on emergence). This, Möbius states, is solely passive, due to the air resistance when the "wings" happen to be held parallel to the plane of flight; similar effects can be produced artificially on a bird's wing or a piece of stiff paper. We are thus, it seems, warranted in regarding the following points as proven:—

- (1) The pectoral fins of the true flying-fish act as lifting and, to some extent, as turning planes in air.
- (2) Rapid turns are made under water.
- (3) The impetus to flight is not given by the pectoral fins, nor is it the result of a single leap into the air after the fashion of a salmon. A rush is made which takes the fish clear of the water, but at a very small angle with the surface, and by means of motion of the elongated lower lobe of the tail additional motive power is provided during the traverse of several yards.
- (4) When velocity slackens it can be re-acquired repeatedly by immersing and vibrating the lower lobe of the tail.
- (5) Vibration of the pectoral fins does occur, but is probably a passive effect.
- (6) In a strong wind flying-fish can rise only against the wind.

The Royal Society Conversazione.

THE first conversazione this year of the Royal Society was held at Burlington House on May 11, and was attended by a large number of fellows and guests, who were received by the president, Prof. C. Sherrington, and the officers of the society. Many exhibits of objects and apparatus of scientific interest were shown, and we have grouped together those on related subjects in the subjoined summaries of some of them from the descriptive catalogue.

Prof. K. Onnes, Sir R. A. Hadfield, and Dr. H. R. Woltjer: Apparatus and specimens used in research on the influence of low temperatures on the magnetic properties of alloys of iron with nickel and manganese. A series of iron-manganese and iron-nickel alloys was exposed to the temperatures of liquid air, liquid hydrogen, and liquid helium respectively and the specific magnetism tested after return to atmospheric temperatures. Tests were also made during immersion in liquid hydrogen (-253° C.). The alloys with the higher percentages of manganese cannot be made magnetic even by immersion in liquid helium (-269° C.). The existence of one magnetic and one non-magnetic manganese-iron compound is shown to be probable.

Messrs. Evershed and Vignoles, Ltd.: Needham's pulsator system of speed measurement and control. This system provides a sensitive electrical means of measuring speed, and may be employed as a speed telegraph of a novel and extremely trustworthy character. In addition to signalling from one or a number of control positions, measurements may be effected simultaneously and independently at a number of positions, so that the system is one of great flexibility. It also indicates the direction of rotation. The system is extremely suitable for use on ships, in power stations, and in other places where the measurement or indication of speed is desired at a distance from the moving machinery.

The Hon. Sir Charles Parsons and Mr. Stanley S. Cook: An attempt to reach high instantaneous pressure by the collapse of a hollow sphere of lead under external pressure suddenly applied by an explosive. The sphere is made up of two hemispheres placed together with tissue-paper between and soldered around the periphery of the joint. In the cavity is placed the substance to be compressed. If its final diameter in nuclear form is $1/2000$ that of the initial hollow, and the pressure of the explosive 20 tons per square inch, the nuclear pressure produced is 1,000,000 tons. The explosive is fired in six places simultaneously.

Cambridge and Paul Instrument Co., Ltd.: Apparatus similar to Mr. C. T. R. Wilson's original cloud expansion apparatus, but improved by Mr. T. Shimizu so that α -, β -, and X-rays may be continually demonstrated.

Mr. E. A. Griffiths: Liquid oxygen vaporiser. The liquid oxygen is contained in a metal vacuum vessel. The emission of gas is governed by bringing a flexible portion of the outer wall into contact with the inner, the degree of contact determining the rate of transmission of heat across. The bottom of the outer vessel is a corrugated plate of silver to the centre of which is soldered a copper block shaped to fit the contour of the inner vessel. The displacement of the diaphragm is controlled by a screw. Any desired rate of gas evolution can be obtained up to 10 litres per minute, and the delivery remains constant with any particular setting for several hours.

Mr. J. St. Vincent Pletts: The Davis-Pletts slide rule. In this slide rule the log-log scale and its

reciprocal scale are related to the log scale in such a way that the numbers on the latter are the common logarithms of the numbers opposite them on the former. This enables full advantage to be taken of the properties of characteristics and mantissas for the purpose of indefinitely extending the non-recurring log-log scales. Further, scales for all the ordinary exponential, circular, and hyperbolic functions are arranged to read on the same log scale, so that any product or ratio of such functions can be obtained. Thus all such compound functions as $e^x \sin a$ and $\log a \cosh x$ can be obtained with a single setting of the slide and cursor, while every combination of the various functions is obtainable with two or more settings.

The National Physical Laboratory: (1) Radio-telegraphic direction-finding apparatus (Mr. R. L. Smith-Rose). This apparatus is of the type developed by Capt. Robinson, of the Royal Air Force. Instead of finding two positions of a receiving coil for which the signals have equal intensity, two coils at right angles are connected in series and rotated together until the signal strength is unaltered by reversing the connections of one of them. This gives the direction from which the signal is coming, and, therefore, the apparent bearing of the transmitting station. Differences between the apparent and the true bearing are found to occur, especially at night; these differences raise many interesting questions in connection with the transmission of electro-magnetic waves in radio-telegraphy. (2) Resistance alloy "omal" for electrical standards (Dr. W. Rosenhain, Mr. S. W. Melsom, and Mr. S. L. Archbutt). The material is of the type usually known as "manganin," and is an alloy of copper, manganese, and nickel. Prior to the war the product was supplied almost exclusively by Germany, and great difficulty was experienced by makers of scientific and ordinary measuring instruments in obtaining material suitable for their purpose from any other sources. The question was investigated at the laboratory, and as a result alloys were made and watched through the various processes that meet the requirements as regards temperature coefficient, constancy, resistivity, and secular change. The material is made in two types, one having a resistivity of 45 microm-cm. and the other of \approx microm-cm. Samples of the product are shown in various stages of manufacture in the form of cast ingots, rod, strip, and wire, together with micrographs and curves of temperature coefficient. (3) Relay for breaking moderately large electric currents (Dr. Guy Barr). The difficulties due to sparking at the contact of ordinary relays are avoided by causing the make-and-break to occur between mercury electrodes in an atmosphere of hydrogen. An iron core floating in mercury carries at its upper end a silica cup, also full of mercury. Connections are made to the mercury outside and inside the cup. A solenoid pulls the core and cup down and thus makes the contact; the current is broken by the core floating up so that the surface of the mercury is cut by the silica. The spark is sufficiently quenched to allow currents up to 20 amperes at 100 volts to be broken easily. The mercury remains clean. (4) Standard optical pyrometer (Dr. Kave and Dr. Griffiths). This instrument has been designed with the view of facilitating the accurate measurement of high temperatures by the "disappearing filament" method. An image of the hot object is superimposed on the filament of the pyrometer lamp and the brightness matched by varying the current through the lamp. Monochromatic

red light is obtained by means of a filter-glass in the eyepiece. To enable the observer to check the permanency of the calibration of the pyrometer, two lamps are fitted which can be interchanged exactly in the field by a simple transverse motion. Each lamp is provided with fine adjustment in three mutually perpendicular planes. The use of the pyrometer for measuring the "black body" temperature of lamp filaments was demonstrated.

Dr. E. E. Fournier d'Albe: Latest form of the optophone. The optophone is an instrument which enables totally blind people to read ordinary printed books and newspapers. It is based upon the reflection of beams of rapidly intermittent light from the type on to a selenium preparation, which produces sounds in a telephone varying according to the shapes of the letters. The instrument shown was kindly lent by the National Institute for the Blind, London, where it is in daily use.

Dr. Leonard Hill: Recording kata-thermometer. This instrument gives a continuous record of the cooling power of the environment exerted on the surface of the bulb of the kata-thermometer, which is automatically kept at skin-temperature. Introduced into the bulb of the "kata," which is filled with alcohol, is a coil of wire with a large temperature coefficient of resistance. This coil forms one arm of a Wheatstone bridge, which is balanced when the coil is at a temperature of 36.5° C. An automatic device is used by which the current sent through the coil varies according to atmospheric conditions, so that the coil is kept at 36.5° C. The ammeter placed in series with the coil indicates the variations of current, and so the cooling power.

Sir J. J. Dobbie and Dr. J. J. Fox: Photographs of absorption spectra of alkaloids. The absorption spectra of the alkaloids are characteristic of the substance, and within certain limits may be used to distinguish the class of alkaloid. The bands obtained are the bands due to the unreduced part of the molecule of the alkaloid. Thus the bands of quinine, cocaine, and morphine are practically identical in position with those of 6-methoxyquinoline, benzoic acid, and catechol respectively. Emetine, cephaeline, corydaline, laudanosine, and certain other alkaloids all give absorption spectra showing that they contain the unreduced catechol grouping. The photographs exhibited show that minute quantities of the alkaloid are sufficient to obtain the characteristic spectrum. Thus 0.3 milligram of strychnine suffices to detect and characterise this substance.

Mr. J. E. Barnard: The microscopic appearance of animal tissues in ultra-violet light. Certain animal tissues show marked differentiation of structure when illuminated by means of ultra-violet light. The image obtained is a fluorescent one, and the resulting colours or tints depend on differences of chemical constitution. Such images are often dissimilar from those resulting from staining reactions. The light-filter used is glass transparent to ultra-violet radiations, approximately 300-400 $\mu\mu$ wave-length, made by Messrs. Chance Brothers. This is combined with a quartz cell filled with a 20 per cent. solution of copper sulphate. The optical illuminating system is of quartz and the sub-stage quartz condenser of the "dark-ground" type. Apart from the biological interest of the method, the image so formed is of considerable value for testing the optical qualities of microscopic objectives, as the object so illuminated is a perfectly self-luminous one.

The Protozoological Laboratory, Rothamsted Experimental Station, Harpenden: The protozoan fauna of the soil. The Rothamsted experiments have demonstrated the presence in soil of an active

protozoan fauna, and investigations are now in hand to ascertain the mode of life of the organisms and their effect on other soil inhabitants, especially bacteria. For this purpose daily counts are made of bacteria and of protozoa in a natural field soil, discriminating between active and encysted protozoa and between various kinds of amœbæ and of flagellates. Typical forms were shown, including an interesting binucleate amœba. The daily counts were set out on curves which show a remarkable periodicity in the case of the flagellate *Oicomonas termo*, Martin, and an inverse relationship between the numbers of active amœbæ and of bacteria.

Prof. Walter Garstang: Some remarkable Gastropod larvæ (*Echinospira*). *Echinospira diaphana* was discovered at Messina and described in 1853 by Krohn, who showed it to be the pelagic larva of Lamellaria. It has two shells, one inside the other. The outer is cast aside at metamorphosis. A complete series of a related species from Plymouth was exhibited, where the metamorphosis for the first time has been observed. Diagrams of related species illustrated the larval evolution of the group and its remarkable parallelism to the development and evolution of Ammonites.

The Hon. H. Onslow: *Abraxas grossulariata* (the magpie or currant moth) and its varieties, showing mode of inheritance. There are many varieties of the magpie moth, which are inherited according to the well-known laws first formulated by Mendel. The black pattern of the type-form usually shows dominance over the other varieties. The patterns of the pale variety, *lacticolor*, and of the melanic variety, *varleyata*, are combined to produce a new form, *exquisita*. As is well known, the *lacticolor* pattern is linked to the female sex, and in the same way the radiated variety, *actinota*, is linked to the male sex.

Dr. John Rennie: Preparations showing various aspects of acarine disease in hive-bees. The specimens exhibited were (1) the mite, *Tarsonemus Woodi*, Rennie, which is the causal organism in acarine disease in the honey-bee; (2) infested tracheæ of bees, showing *T. Woodi* in all stages of development; and (3) tracheæ showing pathological development of chitin in the areas of infestation. (4) Other mites found in association with hive-bees, including one other species of *Tarsonemus*. The disease, apparently restricted to the British Isles, first appeared in 1902. Affected bees usually lose their power of flight.

The Zoological Department, King's College (University of London): Reconstruction models and drawings made by Dr. F. J. Wyeth, illustrating the development of the auditory apparatus and adjacent structures in the New Zealand Tuatara (*Sphenodon*). The models were made of wax plates 1 mm. in thickness, each plate representing an enlarged microscopic section, the different systems of organs being distinctively coloured. The drawings were for the most part made from the models to illustrate Dr. Wyeth's memoir on the development of the auditory apparatus, etc., in *Sphenodon*, communicated to the Royal Society by Prof. A. Dendy.

Department of Zoology, British Museum (Natural History): Life-history of the common eel (Mr. C. Tate Regan). The researches of Dr. J. Schmidt have shown that the common eel or fresh-water eel (*Anguilla vulgaris*) of Europe breeds in the Atlantic south-east of Bermuda. A series of larvæ, 9-60 mm. long, from the middle and western North Atlantic was exhibited; these growing larvæ have long and slender pointed teeth. The metamorphosis into the elver, or young eel, was shown by a photograph. Models illustrated the changes in the adult eel when it migrates to the ocean and becomes mature.

Zoological Laboratory, Imperial College of Science, South Kensington, S.W.: (1) Embryonic calcareous structures of the lantern of the sea-urchin, *Echinus miliaris* (Mr. Devanesen). The calcareous parts of the lantern, with the exception of the teeth, arise as tri-radiate spicules. While the jaws, the epiphyses, and the compasses each make their first appearance as a pair of spicules, the rotulæ alone arise from single spicules. Each tooth is made up of two adjacent vertical rows of rectangular lamellæ which afterwards fuse together. (2) The spermatogenesis of the louse, *Pediculus corporis* (Mr. H. G. Cannon). The somatic chromosome number in both sexes is twelve, but spermatogonial mitotic figures show only six, and there is evidence that these are double. There is only one spermatocyte division, which is extremely unequal, leading to the separation of a minute polar-body-like cell which degenerates. It is this division which was exhibited.

Royal Botanic Gardens, Kew: Abnormal development of lime-tree branches due to the presence of mistletoe (*Viscum album*, Linn.). Large and small swellings often occur on the branches of lime-trees infested with mistletoe, and there can be little doubt that they are due to the presence of the parasite, although on the larger swellings mistletoe is weak and sometimes difficult to find, while on small swellings, or where very little abnormal increase in girth is noticeable, mistletoe may be very vigorous. From the presence and character of the dead haustoria in the older parts of the large swellings it is apparent that healthy mistletoe was present at an earlier date. Canker, however, occurred, whereby the mistletoe became insecure and was eventually torn away by the wind. Vigorous new aerial branches did not appear, but buds and haustoria in the bark continued to grow, and the affected part of the lime branch developed at an abnormal rate, the consequent thickening of the bark probably inhibiting any strong aerial growth of the parasite.

Dr. W. Bateson: Variegated prothallia of a fern. The variegated fern, *Adiantum cuneatum* var. *variegata*, produces prothallia of which many are green and some variegated. From these arise ferns which may be green, variegated, or white. Apparently segregation here occurs in haploid tissue.

Mr. Franklin Kidd: Application of cold-storage and gas-storage to English apples. The Food Investigation Board has been investigating the possibilities of the cold-storage method and of a new method known as "gas-storage" in application to the English apple-crop. Improved methods of apple storage are required in order to bring the home-grown apple into successful competition with imported apples throughout the winter season. In cold-storage the apples are kept just above freezing point. The method is costly. In "gas-storage" the apples are held in a gas mixture created and maintained by their own respiratory activity, no machinery being required. This method is cheaper.

Dr. W. Lawrence Balls: Portable cotton-sorting mechanism. The "sorter" mechanism is designed to analyse a collection of such fibres as cotton-hairs by distributing them on a collecting surface in the order of their individual lengths, thus enabling the frequency distribution of length to be plotted. The instrument shown was re-designed from the original automatic form in order to provide a portable pattern convenient for the use of cotton-growers and agricultural experiment stations abroad.

Dr. A. Smith Woodward: Fossil fishes from the Old Red Sandstone of Shetland. This is part of a collection lately made by Mr. T. M. Finlay, of the University of Edinburgh, and is important as includ-

ing well-preserved specimens of a Palæoniscid fish related to the Carboniferous *Rhadinichthys*. Scales of a similar Palæoniscid are already known from Upper Devonian formations in North America and Antarctica.

Dr. F. A. Bather: Some questionable fossils. (1) Tubular quartzite of Cambrian age from Sweden and of Lower Devonian age from the Eifel. Are the structures produced by worms or by ascending air-bubbles? (2) Echinoderm remains of Permian age from Timor. Are they spines of sea-urchins or bases of crinoids? (3) Horned Trilobites of Middle Devonian age from the Eifel. What, if any, was the use of the horns?

Mr. J. Reid Moir: A series of ochreous flint implements, cores, and flakes of Early Chellean (Palæolithic age) from the base of the Cromer Forest Bed deposits. The specimens exhibited were collected from a limited area of foreshore exposed at low water at Cromer, Norfolk. The series included implements of Early Chellean forms, such as have been found hitherto in river-terrace gravels, together with rostro-carinates, choppers, scrapers, points, cores, and a large number of flakes. If the specimens are assigned correctly to the base of the Cromer Forest Bed, then the earliest Palæolithic cultures are referable in East Anglia to the Upper Pliocene deposits.

Mr. George H. Gabb: The original portrait of Galileo by D. Tintoretto, in oil, painted about 1605-7, when Galileo was from forty-one to forty-three years of age. This portrait is of great historic interest as probably the earliest original existing portrait of Galileo, a somewhat earlier one by Santè di Tito having been lost. At the time D. Tintoretto painted the portrait Galileo was master of mathematics at Padua, which is indicated by the inscription on it, "Gallileus Gallileus Mathus." This was some years before he began the great astronomical discoveries by means of the telescope which consolidated the theory of the Copernican system and immortalised his name. A small engraving by Schiavoni was made of this portrait about 1812.

University and Educational Intelligence.

CAMBRIDGE.—The Adams prize has been awarded to Dr. W. M. Hicks, St. John's College.

It is proposed to form an advisory committee on geodesy and geodynamics to make provision for study and research in geodesy, including arc measurements, primary triangulation, precise levelling, and gravity determinations; also for geodynamics and tidal phenomena. It is hoped to take the first active step towards the foundation of a school of geodesy and geodynamics which would eventually meet the practical needs of the surveys of the Empire. The advisory committee would be largely nominated by outside bodies, and both the Hydrographer of the Navy and the Director-General of the Ordnance Survey would be represented on it. Further steps in organisation await the appointment of a prælector in geodesy by Trinity College.

LONDON.—The following new appointments have been made at University College:—Mr. T. A. Brown, senior lecturer in pure mathematics for the session 1921-22, and Dr. Percy Stocks, medical officer in connection with the department of applied statistics and eugenics (this appointment has been instituted by means of a grant made by the London County Council).

Sir William Tilden will deliver three public lectures at University College on "The History of Chemistry in the Nineteenth Century" on Fridays, May 27 and

June 3 and 10, at 5 p.m. The chair at the first lecture will be taken by Prof. J. Norman Collie.

MANCHESTER.—The council has instituted a new chair in the Faculty of Commerce, and appointed Mr. G. W. Daniels as professor of commerce and administration as from September 29 next. Dr. Albert Ramsbottom has been appointed professor of clinical medicine. The following appointments have also been made by the council:—Senior lecturer in economics, Mr. T. S. Ashton; lecturer in histology, Miss Ruth Fairbairn; assistant lecturers in physics, Dr. J. C. M. Brentano and Mr. H. Lowery; and assistant lecturer in metallurgy, Mr. Hugh O'Neill.

PROF. EINSTEIN will deliver this year's Adamson lecture of the University of Manchester on some day during the first week in June. He will afterwards visit King's College, London, and other institutions which approached him after he had arranged to go to Manchester.

THE open competitive examination for assistant examiners in the Patent Office will begin on Tuesday, July 26, instead of on July 12 (as stated in the printed regulations), and will last until Saturday, July 30. Any candidate who has attained the age of twenty on July 26, and has not attained the age of twenty-five on July 12, will be regarded as eligible in respect of age to compete on this occasion.

WE learn from *Science* that at a recent meeting of some of Sir William Osler's students an Osler Memorial Association was formed for the purpose of founding an Osler memorial lectureship in the University of California, which will provide for an annual lecture on a scientific subject. The expense will be met by a yearly assessment of the members of the association. Dr. John M. T. Finney, Baltimore, has accepted an invitation to deliver the first lecture.

THE Salters' Institute of Industrial Chemistry (Salters' Hall, St. Swithin's Lane, E.C.4) invites applications for a limited number of fellowships, value 25*l.* per annum, from those who by October next will have completed three years' training in chemistry and seek an industrial career. Full particulars of training and war service (if any) of candidates should reach the director of the institute before June 18.

THE council of the British Medical Association is prepared to receive applications for an Ernest Hart memorial scholarship, of the value of 200*l.* per annum, for the study of some subject in the department of State medicine, and for three research scholarships, each of the value of 150*l.* per annum, for research relating to the causation, prevention, or treatment of disease. Each scholarship is tenable for one year, commencing on October 1, but a scholar may be re-elected for a period not exceeding two additional terms. A number of grants for assisting research will also be awarded, preference being given to members of the medical profession and to applicants who propose to investigate problems directly related to practical medicine. Applications for scholarships and grants, which must be made not later than June 25, should be accompanied by testimonials, including a recommendation containing a statement as to the probable value of the work to be undertaken, from the head of the laboratory, if any, in which the applicant proposes to work. Forms and further particulars can be obtained from the Medical Secretary of the British Medical Association, 429 Strand, W.C.2.

THE eighth annual report on the industrial fellowships of the Mellon Institute in the University of Pittsburgh directs attention once again to the scheme for

promoting industrial scientific research which was initiated by the late Prof. Robert Kennedy Duncan in the University of Kansas in 1907 and in the University of Pittsburgh in 1911. The principles upon which the scheme is based, which were described in a report by Mr. T. L. Humberstone published some years ago by the Board of Education, should by this time be well known in this country. Although not "commercial" in spirit, the Mellon Institute has been able to render a great national service by demonstrating to American manufacturers that industrial research is a paying proposition. The number of industrial fellowships in operation in the institute is now forty-eight, and the money contributed by industrial firms in the last ten years amounts to 1,534,273 dollars. A considerable number of fellowships have been established by groups of firms, and the report points out that some of the larger multiple fellowships are now so well established and so distinctive in their fields of inquiry that they are not uncommonly regarded as independent organisations. This development will, no doubt, require watching in future. Several experimental plants have been set up in connection with the institute. Recent subjects for investigation include magnesia products, fruit beverages, asbestos, and refractories. The Kennedy Duncan system of industrial fellowships has now been thoroughly tested and its fundamental principles remain unshaken; and it may well be asked why, with so much public money freely spent in this country on applied scientific research, this admirable method of establishing a link between the universities and industry has not been given a trial.

THE list of the summer courses in England and Wales prepared by the Special Inquiries Office of the Board of Education for the use of education authorities and teachers has just been issued. The information provided is in tabular form under the following headings:—Authority responsible for course; place; date; fee; subjects of instruction; address for further particulars; and remarks. In the eastern counties of England there will be a course on the origin and development of the physical geography of Europe, map construction, anthropogeography, historical, political, and economic geography at Cambridge, and another on the principles and practice of horticulture at Chelmsford. At the South-Eastern Agricultural College, Wye, lectures and demonstrations will be given illustrating the teaching of chemistry, botany, mycology, and entomology applied to everyday life. In the Midland Counties courses on teaching method as applied to geography will be given at Nottingham; and there will be lectures and conferences on the teaching of numerous subjects, including geography and science, at Oxford. In the south-western area courses in geography, chemistry, mathematics, physics, and psychology will be held at Exeter; while at Weston-super-Mare the subjects include experimental science, botany, rural science, and hygiene. At both places the courses will be designed to fit teachers for continuation-school work. In the northern counties lectures on oceanography and fisheries will be given at Barrow-in-Furness. At four places in Wales there will be courses in science subjects. At Amman Valley County Intermediate School there will be a course on mine surveying, and at Madryn Castle Farm School one on school gardening and rural science. At Cardiff courses will be given in pure and applied science, particularly in various branches of engineering, and at Bangor on the teaching of geography and regional survey work. The table of courses can be obtained from H.M. Stationery Office or from E. Ponsonby, Ltd., 116 Grafton Street, Dublin (4*d.* net).

Calendar of Scientific Pioneers.

May 19, 1786. Carl Wilhelm Scheele died.—Prominent as an experimental investigator and chemical discoverer, Scheele worked as an apothecary in various towns in Sweden, devoting his leisure to chemistry. Included among the many substances he discovered are chlorine, ammonia, oxygen, and several acids.

May 20, 1793. Charles Bonnet died.—A well-known naturalist of Geneva, Bonnet made researches on parthenogenesis, the respiration of insects, and the use of leaves. He also published works on psychology.

May 20, 1880. William Hallowes Miller died.—A fellow of St. John's College, Miller from 1832 to 1870 was professor of mineralogy at the University of Cambridge. He developed a system of crystallography adapted to mathematical calculation.

May 21, 1894. August Adolf Eduard Eberhard Kundt died.—A student under Magnus, Kundt in 1888 succeeded Helmholtz as professor of experimental physics and director of the Berlin Physical Institute. His most successful work related to sound, light, and magneto-optics.

May 22, 1666. Gaspar Schott died.—To Schott, Guericke, and Johann Sturm belongs the credit of reviving the study of the physical sciences in Germany after the Thirty Years' War. Schott was educated in Italy as a Jesuit, but afterwards taught at Wurzburg. His "Mechanica—hydraulica—pneumatica" (1657) contains the first description of the air pump.

May 22, 1868. Julius Plücker died.—A mathematician and physicist of Bonn, Plücker extended analytical geometry, and was known for his discovery of magneto-crystalline action, and for his researches on spectroscopy and the electric discharge in rarefied gases.

May 23, 1857. Auguste Louis Cauchy died.—Covering the whole field of mathematics and mathematical physics, the work of Cauchy is noteworthy for the rigorous methods he introduced. He was a professor at the Ecole Polytechnique.

May 23, 1894. George John Romanes died.—After early work on the nervous and motor systems of the Echinodermata Romanes turned his attention to such questions as mental evolution in animals. He was an intimate friend of Darwin, and did much to popularise his views.

May 23, 1895. Franz Ernst Neumann died.—Neumann was born in 1798, and from 1829 to 1876 was professor of mineralogy and physics in the University of Königsberg. He did important work on the dynamical theory of light and on the mathematical theory of electro-dynamics.

May 24, 1543. Nicolas Copernicus died.—Born at Thorn in 1473, Copernicus, or Koppelnik, was the fourth child of a merchant. After studying at Cracow, Bologna, Padua, and Ferrara, Nicolas, through his uncle the Bishop of Ermland, became a canon of Frauenburg Cathedral. Later on he was administrator of the diocese. Among his great contemporaries, Luther, Erasmus, Leonardo da Vinci, and Paracelsus, Copernicus is the representative of the reformers of astronomy. All his leisure was given to observation; his "De Revolutionibus" is the result. The first printed copy of this work was placed in the hands of Copernicus when he was dying. Dedicated to Pope Paul III., many years afterwards it was placed upon the Index.

May 24, 1837. Karl Ernst Adolf von Hoff died.—The friend of Werner and Goethe, Hoff is known to geologists for his "History of the Changes on the Surface of the Earth" (1822-41). E. C. S.

Societies and Academies.

LONDON.

Linnean Society, April 21.—Dr. A. Smith Woodward, president, in the chair.—Prof. R. Newstead: Some observations on the natural history of the Upper Shiri River, Nyasaland. The common types of the flora and fauna were discussed. The flora was dealt with under three sections:—(1) The river and its banks, (2) the open "dambo" or savannah, and (3) the forest. Dealing with the insects, special reference was made to a highly protective species of Mantis (*Taracodes perloides*) and the common tsetse-fly of the country (*Glossina morsitans*), the latter being the chief factor in the dissemination of sleeping sickness in man. Seventy-eight species of birds were collected; among these a new species of flycatcher (*Erithrocerus nyasae*); and large flocks of the rare lorikeet (*Agapornis lillianae*) were observed.

Faraday Society, May 9.—Prof. A. W. Porter, president, in the chair.—É. K. Rideal and U. R. Evans: The problem of the fuel-cell. Fuel-cells may be classified as:—(1) Direct fuel-cells burning solid fuel. These suffer from current polarisation due to the low velocity with which carbon enters into electrodic reactions. (2) Semi-direct fuel-cells burning gaseous fuel. These suffer usually from current polarisation due to the difficulty of keeping the electrode material saturated with gas. Mond and Langer overcame this, but in doing so used so much platinum that their cell became far too expensive for practical use. An attempt to use nickel instead of platinum as the substratum of a gas-electrode was unsuccessful. (3) Indirect cells of (a) oxidation-reduction type. These suffer from not only (i) current polarisation, dependent on the electrode area, but also (ii) time polarisation, dependent on the cell volume. This second kind of polarisation is economically most important, but has been overlooked by some workers. Some fresh cells of this type were tested, but proved unsuitable. (b) Metal anode type. Zinc appears unsuited, but preliminary experiment with different cells (both hot and cold) in which tin was the active element gave results which seemed promising.—L. F. Knapp: The solubility of small particles and the stability of colloids. A theoretical paper in which Ostwald's relation between the solubility and size of particles is modified for the case where the particles are electrically charged. An attempt is made to explain the connection between the stability of colloids and the charge carried by their particles.

EDINBURGH.

Royal Society, May 2.—Prof. F. O. Bower, president, in the chair.—Dr. Dawson Turner and Mr. D. M. R. Crombie: Behaviour of an electrified pith ball in an ionised atmosphere. This communication concerns a delicate method of demonstrating the ionised atmosphere surrounding flames and hot bodies by means of a pith ball suspended from the knob of a charged Leyden jar. The effectiveness of various sources of ionisation was demonstrated, and the directive influence of the charged Leyden jar shown. The conclusions arrived at were:—(1) A charged pith ball can serve as a very delicate indication of the electrical condition of its surroundings. (2) The ions are concentrated along the straight line joining the centre rod of the charged jar and the source of ionisation. (3) The ions tend to be carried upwards by convection currents. (4) The ionisation of the atmosphere does not depend upon the luminous or actinic intensity of the flame, but is associated with a radiation of longer wave-length. (5) The effect

upon the electrified pith ball appears to be independent of the nature of its charge.—Dr. R. Kidston and Prof. W. H. Lang: Old Red Sandstone plants, showing structures from the Rhynie Chert Bed, Aberdeenshire. Part iv.: Restorations of the vascular cryptogams, and discussion of their bearing on the general morphology of the Pteridophyta, and the origin of the organisation of land plants. Restorations of the four plants, *Rhynia Gwynne-Vaughani*, *R. major*, *Hornea Lignieri*, and *Asteroxylon Mackiei*, are given. A few additional features, supplementary to the descriptions in preceding papers of the series, are described. The hemispherical projections of *Rhynia Gwynne-Vaughani* are shown to have originated underneath stomata. A comparison is made between them and certain intumescences in existing plants. Areas of necrosis and marked wound-reactions of the tissues around them are described for both species of *Rhynia*. The apex of a stem of *R. major* is figured. The discussion summarises the authors' views on the bearings of the facts described in the Parts i.-iv. on problems in plant-morphology. Part v.: The Thallophyta occurring in the peat-bed; the succession of the plants throughout a vertical section of the bed, and the conditions of accumulation and preservation of the deposit. The Thallophyta found in the silicified peat are described. The most abundant are fungi represented by hyphæ of the mycelium, and vesicles or resting-spores borne on this. With the exception of one specimen, the hyphæ were non-septate, and the fungi are regarded as belonging to the Phycmycetes. A number of form-types are described; the species distinguished are *Palaeomyces Gordonii*, *P. Gordonii* var. *major*, *P. asteroxylis*, *P. Horneae*, *P. vestita*, *P. Simpsoni*, and *P. agglomerata*. The possibility of there being a symbiotic (mycorrhizal) relation between certain fungi and the vascular cryptogams is discussed; there is no conclusive evidence in favour of this. The majority of the fungi in the Rhynie peat were certainly living as saprophytes. Bacteria were doubtless present in abundance, but are difficult to distinguish in the granular matrix. A representative of the Schizophyta, a filamentous organism with the small protoplasts preserved, is named *Archaeothrix oscillatoriformis*, and compared with *Beggiatoa* and *Oscillatoria* among existing plants. Scattered remains of an alga, the vegetative structure of which presents a number of resemblances to existing Characeæ, are described under the name *Algites (Palaeonitella) cranii*. Two fragments belonging to an organism with the characteristic structure of Nematophyton are described as *N. Taiti*. The specimens show the structure of the peripheral region, which in specimens previously described has not been preserved. The succession of the plants throughout a section of the Chert Bed as exposed *in situ* is followed, and the conditions of formation of the Rhynie deposit are discussed. On grounds mainly of resemblances presented by *Asteroxylon* to *Tharsophyton (Lycopodites) Milleri*, the Rhynie Chert Bed is allocated to the Middle Old Red Sandstone age.

✻ PARIS.

Academy of Sciences, April 25.—M. Georges Lemoine in the chair.—C. Guichard: Triply indeterminate systems of right lines and their conjugates with respect to a linear complex.—L. Cuénot: The different modes of regeneration of the antennæ in *Carausius morosus*.—C. Nicolle and A. Cuénot: New acquisitions in the experimental study of trachoma. An account of results obtained in experiments on apes and rabbits.—J. Tarazona: Observation of the annular eclipse of the sun on April 7, 1921, at the astronomical

observatory of the University of Valencia (Spain). Comparison of the observed and calculated times of contact.—P. Fox: Measurements of stellar parallax at the Dearborn Observatory. The table giving the parallax of twenty-four stars is based on photographic observations with the 48-cm. equatorial.—A. Leduc: The principle of equivalence and reversibility.—H. Buisson and C. Fabry: The displacement of the solar lines under the action of the gravitational field. The differences observed between the lines of the solar spectrum and those of the arc in vacuum can be perfectly interpreted by the following hypotheses: the pressure in the reversing layer is small, and consequently the effect of the pressure can be neglected, and the Einstein effect is the only cause of the displacement of the lines of the solar spectrum.—Mme. P. Curie: The γ radiation and the evolution of heat from radium and mesothorium. The heat evolved is measured by an ice calorimeter with a capillary tube, one division of which corresponds to about 0.03 calorie. A method for the determination of the relative quantities of radium and mesothorium in a sealed tube can be based on the calorimetric measurements, and it may also be possible to determine the age of the specimen by observations with time-intervals of several months.—Mlle. Irène Curie: The atomic weight of chlorine in some minerals. Three minerals were examined, a Canadian sodalite, a Norwegian apatite containing chlorine, and a salt from Central Africa. The hydrochloric acid prepared from these minerals was converted into barium chloride, and comparative experiments were made on the silver chloride obtained from these and from ordinary pure barium chloride. With the sodalite and the apatite the differences observed were of the same order as the experimental error; in the case of the salt the atomic weight found was 35.60. This difference was proved not to be due to the presence of bromine or iodine, and further experiments with this material will be carried out.—M. Laporte: The measurement of the mobility of gaseous ions by the toothed-wheel method. The mobility of gaseous ions has been measured by a method based on that used by Fizeau for the determination of the velocity of light. Some preliminary results are given.—G. Contremoulin: The protection against X-rays of persons other than the operator and patient. The effects of modern X-ray tubes can be felt outside the operating-room, and in thickly populated districts may be a source of danger. Experiments are described bearing on the precautions required to prevent the rays penetrating beyond the operating-room.—A. Dauviller: The working of the Lilienfeld tube.—C. Matignon: The principles of some new methods applicable to the determination of molecular weights. The utilisation of chemical equilibria for the measurement of molecular weights.—L. Guillet: The tempering of brasses containing tin.—M. Pierrat: The solubility of various potassium salts in mixtures of water and alcohol. Alcoholic solutions of varying strength in alcohol of the salts examined (potassium bitartrate, perchlorate, chloroplatinate, fluosilicate, and cobalt-nitrite) were prepared by prolonged shaking of the salt with the mixture, the alcohol removed by evaporation in a current of dry air, the liquid made up to its original volume with water, and the concentration of the salt determined by the electrolytic conductivity method. Solubilities for each of the above salts are given for six different concentrations of alcohol.—P. Dumesnil: The acid ethyl diethylmalonate.—M. Randoïn: Contribution to the study of the globular silica representing the flint clay to the south of the Paris basin.—M. Delépine: The active racemic com-

pounds. The author regards a crystalline structure as racemic if it is composed of equal numbers of dextro-rotatory and lævorotatory molecules. The optical activity is only an accessory phenomenon depending on the nature of the molecules of each configuration, and is zero in the particular case of simple enantiomorphs.—**J. de Lapparent**: The episodic character of the layers of carboniferous limestone in the Boulonnais and the dolomitisation of certain of them.—**S. Stefanescu**: Some morphological characters of the crown of the molars of mastodons and elephants.—**R. Souèges**: The embryogeny of the labiates. The development of the embryo in *Mentha viridis*.—**A. Goris** and **C. Vischniac**: The alkaloids of valerian. The authors' results confirm those of Waliszewski and Chevalier. Valerian root contains two alkaloids, chatinine (soluble in ether) and valerine (insoluble in ether, but soluble in chloroform). The proportions found in the root are very small, and, as their physiological action is slight, these substances probably have no bearing on the therapeutic action of the valerian.—**J. Politis**: The mitochondrial origin of the anthocyanic pigments in fruits.—**E. Licent**: The structure and evolution of the nucleus in the meristem cells of some Euphorbiaceæ.—**R. de Litardière**: Remarks on the chromosomal processes in the diploidic nuclei of *Podophyllum peltatum*. The author's observations on the evolution of the somatic chromosomes of *P. peltatum*, given in detail, are not in accord with those of Overton.—**A. Desgrez** and **H. Bierry**: Food rations and vitamins.—**A. Lumière**: Surface tension and the anaphylactic shock. Reply to the criticisms of W. Kôpaczewski.—**A. Vandel**: The regeneration of the genital glands in Planaria.—**A. Labbé**: The adaptive modifications of *Dunaliella salina*.—**A. Magnan**: The variation in weight of the lowering and lifting muscles according to the extent of the wing-surface in birds.—**S.** and **A. Mayer**: The fundamental organic substance of amylopectin. The amylopectin was separated by electro dialysis from a starch solution. Its chemical and physical properties are compared with those of the amylose solution obtained in the process of preparation.—**E. Roux**: Some remarks on the action of light and heat radiations in heliotherapy.

Books Received.

Coke-Oven and By-Product Works Chemistry. By Thos. B. Smith. Pp. x+180+7 plates. (London: C. Griffin and Co., Ltd.) 21s.

The Clayworker's Hand-book. By Alfred B. Searle. Third edition, revised. Pp. viii+381. (London: C. Griffin and Co., Ltd.) 21s.

The Way of a Trout with a Fly, and Some Further Studies in Minor Tactics. By G. E. M. Skues. Pp. xvi+259. (London: A. and C. Black, Ltd.) 18s. net.

Tables of Refractive Indices. By R. Kanthack. Vol. ii.: Oils, Fats, and Waxes. Pp. 295. (London: Adam Hilger, Ltd.) 25s. net.

Atlas Météorologique de Paris. By Joseph Lévine. Pp. vi+83+ix plates. (Paris: Gauthier-Villars et Cie.) 20 francs.

Principles and Methods of Physical Anthropology. By Rai Bahadur S. C. Roy. (Patna University Readership Lectures, 1920.) Pp. xiii+181. (Patna: Government Printing Office.) 5 rupees.

The Psychology of Everyday Life. By Dr. James Drever. Pp. ix+164. (London: Methuen and Co., Ltd.) 6s. net.

Handbook of Instructions for Collectors. Fourth edition. Pp. 222. (London: British Museum (Natural History).) 5s.

A Handbook of the British Lichens. By Annie L. Smith. Pp. vii+158. (London: British Museum (Natural History).) 6s. 6d.

Calculus for Beginners: A Text Book for Schools and Evening Classes. By H. Sydney Jones. Pp. ix+300. (London: Macmillan and Co., Ltd.) 6s.

Cotton Spinning. By W. S. Taggart. Vol. ii. Sixth edition, with Appendix. Pp. xv+291. (London: Macmillan and Co., Ltd.) 8s. 6d. net.

Eminent Chemists of our Time. By Dr. Benjamin Harrow. Pp. xvi+248. (London: T. Fisher Unwin, Ltd.) 9s. net.

Some Birds of the Countryside: The Art of Nature. By H. J. Massingham. Pp. 208. (London: T. Fisher Unwin, Ltd.) 12s. 6d. net.

Smithsonian Institution: United States National Museum. Report on the Progress and Condition of the United States National Museum for the Year ending June 30, 1920. Pp. 210+3 plates. (Washington: Government Printing Office.)

Annual Report of the Director, United States Coast and Geodetic Survey, to the Secretary of Commerce for the Fiscal Year ended June 30, 1920. Pp. 173. (Washington: Government Printing Office.)

Fermat's Last Theorem: Proofs by Elementary Algebra. By M. Cashmore. Third edition. Pp. 67. (London: G. Bell and Sons, Ltd.) 2s. 6d. net.

Fisheries: England and Wales. Ministry of Agriculture and Fisheries: Fishery Investigations. Series iii., Hydrography. Vol. i., The English Channel. Part vi., Across the Mouth of the Channel. Pp. iii+32. (London: H.M. Stationery Office.) 5s. net.

Official Statistics: What they Contain and How to Use Them. By Prof. A. L. Bowley. (The World of To-Day.) Pp. 63. (London: Oxford University Press.) 2s. 6d.

The Moral and Social Significance of the Conception of Personality. By the late Arthur G. Heath. Pp. viii+159. (Oxford: Clarendon Press.) 7s. 6d. net.

Catalogue of the Fossil Bryozoa (Polyzoa) in the Department of Geology, British Museum (Natural History). The Cretaceous Bryozoa (Polyzoa). Vol. iii.: The Cribrimorphs. Part i. By Dr. W. D. Lang. Pp. 12+cx+269+viiii plates. (London: British Museum (Natural History).) 30s.

A Book about the Bee. By Herbert Mace. Pp. x+138. (London: Hutchinson and Co.) 4s. net.

A Monograph of the Pheasants. (In four volumes.) By William Beebe. Vol. ii. Pp. xv+269+plates. (London: H. F. and G. Witherby.) 12l. 10s. net.

Activism. By Henry L. Eno. Pp. viii+208. (Princeton: University Press; London: Oxford University Press.) 6s. 6d. net.

Introduction to General Chemistry: An Exposition of the Principles of Modern Chemistry. By Prof. H. Copaux. Translated by Dr. Henry Leffmann. Pp. x+195. (Philadelphia: P. Blakiston's Son and Co.) 2.00 dollars net.

Diary of Societies.

THURSDAY, MAY 19.

ROYAL INSTITUTION OF GREAT BRITAIN, at 3.—E. Law: The Architecture and Art of Hampton Court Palace: I. In Tudor Times. INSTITUTE OF PATHOLOGY AND RESEARCH (at St. Mary's Hospital, Paddington), at 4.30.—Dr. H. H. Dale: Anaphylaxis and Immunity.

ROYAL INSTITUTE OF BRITISH ARCHITECTS, at 5.—R. E. Fry: Architectural Heresies of a Painter.

ROYAL SOCIETY OF MEDICINE (Dermatology Section) (Annual General Meeting), at 5.

INSTITUTE OF MINING AND METALLURGY (at Geological Society), at 5.30.—E. H. Clifford: Scheme for Working the City Deep Mine at a Depth of 7000 ft.—The following Papers will be submitted for Discussion:—F. P. Caddy: Stope Measuring at the Passagem Mine of the Gold Mines of Ouro Preto, Ltd.—J. A. P. Gibb: Notes on Some Useful Alignment Charts.

CHEMICAL SOCIETY (Informal Meeting), at 8.

RÖNTGEN SOCIETY (in Physics Lecture Theatre, University College), at 8.15.—Prof. A. V. Hill: Electrical Instruments and Phenomena in Physiology (Fourth Silvanus Thompson Memorial Lecture).

FRIDAY, MAY 20.

ROYAL SOCIETY OF MEDICINE (Otology Section) (Annual General Meeting), at 5.—F. J. Clemenison: Sinusitis in Children.

JUNIOR INSTITUTION OF ENGINEERS, at 8.—A. Arnold: Liquid Fuels. ROYAL SOCIETY OF TROPICAL MEDICINE AND HYGIENE (at 11 Chandos Street, W.1), at 8.15.—Lt.-Col. H. Kirkpatrick: Trachoma.—C. H. Marshall: New Method of Treatment of Human Trypanosomiasis.—C. França: An Early Portuguese Contribution to Tropical Medicine.

ROYAL SOCIETY OF MEDICINE (Electro-Therapeutics Section) (Annual General Meeting), at 8.30.—Discussion: The Stomach.

ROYAL INSTITUTION OF GREAT BRITAIN, at 9.—Prof. E. H. Starling: The Law of the Heart.

SATURDAY, MAY 21.

ROYAL INSTITUTION OF GREAT BRITAIN, at 3.—F. Legge: Gnosticism and the Science of Religions. I.

MONDAY, MAY 23.

VICTORIA INSTITUTE (at the Central Hall, Westminster), at 4.30.—Rev. Dr. W. St. Clair Tisdall: The Date of Daniel.

INSTITUTION OF ELECTRICAL ENGINEERS (Informal Meeting) (at Chartered Institute of Patent Agents), at 7.

ROYAL INSTITUTE OF BRITISH ARCHITECTS, at 8.

ARISTOTELIAN SOCIETY (at University of London Club), at 8.—Very Rev. Dean Rashdall and Others: Discussion on Dr. Inge's "The Idea of Progress."

MEDICAL SOCIETY OF LONDON (at 11 Chandos Street, W.1), at 8.—General Meeting.

ROYAL SOCIETY OF MEDICINE (Odontology Section) (Annual Meeting), at 8.—J. H. Mummery and G. J. Harbrow: A Composite Odontome.—A. T. Pitts: The Prophylactic Extraction of the Third Molars.

ROYAL GEOGRAPHICAL SOCIETY (at Æolian Hall), at 8.30.—Mrs. Rosita Forbes: Across the Libyan Desert to Kufara.

MEDICAL SOCIETY OF LONDON (at 11 Chandos Street, W.1), at 9.—Lord Dawson of Penn: The Colon and Colitis (Annual Oration).

TUESDAY, MAY 24.

INSTITUTION OF GAS ENGINEERS (at Institution of Civil Engineers), at 10 a.m.

ROYAL HORTICULTURAL SOCIETY (at Chelsea), at 3.

ROYAL INSTITUTION OF GREAT BRITAIN, at 3.—E. Clodd: Occultism: Its Origin and Development.

LINNEAN SOCIETY, at 3.—Anniversary Meeting.

ROYAL STATISTICAL SOCIETY (at Surveyors' Institution), at 5.15.—G. Udny Yule: The Time-correlation Problem, with Especial Reference to the Variate-difference Method.

ROYAL SOCIETY OF MEDICINE (Medicine Section) (Annual General Meeting), at 5.30.—Dr. C. Riviere and Others: Discussion on Artificial Pneumothorax.

ZOOLOGICAL SOCIETY OF LONDON, at 5.30.—The Secretary: Report on the Additions to the Society's Menagerie during the month of April, 1921.—Dr. C. F. Sonntag: The Comparative Anatomy of the Tongues of the Mammalia. IV. Families 3 and 4. Cebidæ and Hapalidæ.—R. Broom: Some New Genera and Species of Anomodont Reptiles from the Karroo Beds of South Africa.—R. I. Pocock: The External Characters of some Species of Lutrine (Otters).—Dr. C. W. Andrews: Note on the Skull of *Dinotherium giganteum* in the British Museum.

ROYAL PHOTOGRAPHIC SOCIETY OF GREAT BRITAIN, at 7.—(Technical Meeting.) Scientific Aspects of Studio Lighting.—L. Gaster: The Selection and Use of Illuminants for the Studio.—J. C. Elvy: Illumination Problems in Kinematography.—J. W. P. Walsh and H. Buckley: Methods of Light Distribution.—I. G. Priest: A Possible Standard of White Light.

WEDNESDAY, MAY 25.

INSTITUTION OF GAS ENGINEERS (at Institution of Civil Engineers), at 10 a.m.

ROYAL HORTICULTURAL SOCIETY (at Chelsea), at 3.

ZOOLOGICAL SOCIETY OF LONDON, at 5.30.—G. W. Lamplugh: The Junction of Gault and Lower Greensand near Leighton Buzzard (Bedfordshire).

INSTITUTION OF ELECTRICAL ENGINEERS (Wireless Section) (at Institution of Mechanical Engineers), at 6.—C. F. Elwell and Others: Discussion on Long-Distance Wireless Transmission.

ROYAL MICROSCOPICAL SOCIETY (Leather Industries Section), at 7.30.—P. Hampshire: "Run" Pelts in Sweating Process of De-woolting.

ROYAL SOCIETY OF ARTS, at 8.—Dr. C. M. Wilson: The War and Industrial Peace: An Analysis of Industrial Unrest.

THURSDAY, MAY 26.

INSTITUTION OF GAS ENGINEERS (at Institution of Civil Engineers), at 10 a.m.

ROYAL HORTICULTURAL SOCIETY (at Chelsea), at 3.

ROYAL INSTITUTION OF GREAT BRITAIN, at 3.—E. Law: The Architecture and Art of Hampton Court Palace. II. In Stuart and Later Times.

ROYAL SOCIETY, at 4.30.—*Probable Papers*.—Sir Alfred Ewing: The Atomic Process in Ferro-magnetic Induction.—C. D. Ellis: The Magnetic Spectrum of the β -rays excited by the γ -rays.—S. Datta: The Spectra of the Alkaline Earth Fluorides and their Relation to Each Other.—Dr. W. L. Balls: A Simple Apparatus for Approximate Harmonic Analysis and for Periodicity Measurements.—Dr. G. R. Goldsborough: The Influence of Satellites upon the Form of Saturn's Ring.—Dr. H. Jeffreys: Certain Geological Effects of the Cooling of the Earth.—T. Kikuchi: The Moving Striations in a Neon Tube (title only).

INSTITUTE OF PATHOLOGY AND RESEARCH (at St. Mary's Hospital, Paddington), at 4.30.—Dr. J. A. Murray: Aims and Progress of the Experimental Study of Cancer.

INSTITUTION OF ELECTRICAL ENGINEERS (at Institution of Civil Engineers), at 6.

CONCRETE INSTITUTE (Annual General Meeting), at 7.30.

FRIDAY, MAY 27.

ROYAL SOCIETY OF ARTS (Indian and Colonial Sections), at 4.30.—Sir Charles H. Bedford: Industrial (including Power) Alcohol.

PHYSICAL SOCIETY OF LONDON (at University College), at 5.—The General Electric Co. (communicated by C. C. Paterson): A Method for the Micro-analysis of Gases by the Use of the Pirani Pressure Gauge.—H. Peeling: The Reflection of the K-ray Spectrum of Palladium from Fluorspar.—Sir W. H. Bragg: The Intensity of X-rays reflected by the Diamond.—Exhibits of Crystal Models, and of Photographs by the Duo de Broglie of Cathode Ray Spectra attendant on the production of X-rays.

INSTITUTION OF MECHANICAL ENGINEERS, at 6.—J. G. Graves: The World's Money System.

ROYAL INSTITUTION OF GREAT BRITAIN, at 9.—A. Mallock: Elasticity.

SATURDAY, MAY 28.

ROYAL INSTITUTION OF GREAT BRITAIN, at 3.—F. Legge: Gnosticism and the Science of Religions. II.

CONTENTS.

PAGE

The Treatment of Tuberculosis by Public Authorities	353
Health and Work. By Dr. Charles S. Myers, F.R.S.	354
British Stratigraphy. By G. W. L.	355
Chemical Research in the Elementary Laboratory. By T. M. L.	356
Cocoa and Chocolate. By T. A. H.	357
Our Bookshelf	357
Letters to the Editor:—	
The Magnetic Storm of May 13–17.—Dr. C. Chree, F.R.S.	359
The Reparation Act and the Cost of German Publications.—Prof J. Stanley Gardiner, F.R.S.	359
Auroral Display.—A. E. L. Hudson	359
The Colours of Primroses.—Dr. J. W. Heslop Harrison	359
Earthworms Drowned in Puddles.—J. H. Coste	360
The Physical Continuity of "Space."—Commdr. John G. McHardy	360
The Production of Metallic Zinc.—Sir R. A. S. Redmayne, K.C.B.; The Writer of the Note	361
The Theory of Vision.—Dr. F. W. Edridge-Green, C.B.E.	361
A New British Land Planarian.—Dr. R. F. Scharff	361
Cutting Sections of Cotton Hairs.—Dr. W. Lawrence Balls and H. A. Hancock	361
British Scientific Instruments.—J. W. Williamson	361
Picture-hanging Wire.—R. B. Marston	362
The Occurrence of <i>Bombus</i> in the Indian Plains.—Cedric Dover	362
Symbols in Vector Analysis.—R. H. Nisbet	362
Young's Interference Experiment.—Prof. P. N. Ghosh	362
The Origin of "Churning at 62°" on Dairy Thermometers.—A. C. Cossor and Son	362
Organism in Flint.—C. Carus-Wilson	362
Direction-finding Wireless and Marine Navigation. (Illustrated.) By J. J. Bennett	363
Cloud Forms. (Illustrated.) By Capt. C. J. P. Cave	365
Unveiling the Senussi Shrines. By Arthur Silva White	366
Obituary:—	
Prof. H. W. G. von Waldeyer. By Prof. G. Elliot Smith, F.R.S.	368
Notes	369
Our Astronomical Column:—	
Comets	373
The Eclipsing Variable U Cephei	373
Æther Waves and Electrons. By Sir William Bragg, K.B.E., F.R.S.	374
The Natives of the Gilbert Islands	374
Parliamentary Visit to the Rothamsted Experimental Station	375
Habits of the Hedgehog	375
The "Flight" of Flying-fish	376
The Royal Society Conversazione	377
University and Educational Intelligence	379
Calendar of Scientific Pioneers	381
Societies and Academies	381
Books Received	383
Diary of Societies	383



THURSDAY, MAY 26, 1921.

Editorial and Publishing Offices:

MACMILLAN & CO., LTD.,

ST. MARTIN'S STREET, LONDON, W.C.2.

Advertisements and business letters should be
addressed to the Publishers.

Editorial communications to the Editor.

Telegraphic Address: PHUSIS, LONDON.

Telephone Number: GERRARD 8830.

The Use of Oil Fuel.

THE prolonged coal stoppage has given an impetus to the use of oil fuel for industrial purposes. Conditions were favourable to such a development, and circumstances have helped to expedite it. One may reasonably assume that the coal industry will suffer some permanent loss as a consequence of this step, since fuel consumers, having gone to the expense of adapting their plants for oil burning, are not likely to revert wholly to coal again, especially as by doing so they would be surrendering the advantage of possessing an alternative which business counsels them to retain in view of the unhappy frequency of labour troubles in our coal-fields.

Another aspect of the matter which will influence commercial men is the economies which accrue from replacing coal with liquid fuel. In comparing the two, availability of supplies and prime cost are, obviously, the first factors to be taken into account. As market quotations now stand they do not tell against oil as they used to do. Fuel oil seems to be in good supply, and at the current price of about 6*l.* to 6*l.* 10*s.* per ton is practically as cheap as coal when everything is considered. As two tons of oil have approximately as high a calorific value as three tons of coal, the greater heating power of the former goes far towards equalising the difference in cost. Nor is this comparison in heating properties merely an estimated figure; it has been established by actual test. Oil fuel is, likewise, much cleaner to handle than coal, and the labour costs of operating it are far lower—roughly, about five times less. With it steam can

be raised more quickly, and the temperature of furnaces regulated with greater ease. By simply turning the tap of the atomising spray one man controls the fire in an oil-burning furnace, whereas the coal-fed furnace keeps several men employed in shovelling in fuel, levelling fires, and breaking up clinker. Oil does not require any ash-ejecting equipment, which means a saving in plant, nor is the inside of the furnace damaged by "slicers" and "prickers"—and that also effects a saving in working costs.

Oil had been growing in favour before the existing industrial crisis came along to give impetus to its adoption. The British Admiralty was amongst the earliest to investigate its possibilities and to employ it on a large scale. After a lengthy period of experimenting, a flotilla of oil-fired destroyers was added to our Navy in 1909. Since that date oil has been steadily replacing coal as the staple fuel of H.M. ships, until at the present time all our effective warships are oil burners. Most of those retained on the active list also use oil for such auxiliary purposes as cooking the food of the crew.

Prior to the introduction of liquid fuel into the service the Navy was an exceedingly good customer to South Wales. But it now makes only a negligible demand upon the product of the pits there, as will be seen from the fact that during the current financial year the Navy is spending about three times as much upon oil fuel as it is upon coal. For the Navy an oil-fuel flash-point of 175° F. has been adopted. In the mercantile marine the flash-point is 150° F.; and in the latter service there has been a considerable "turn over" from coal to oil fuel during the past couple of years. How serious a matter this may prove for the coal producer is shown by the fact that whereas a ship like the *Aquitania* used to take in 660 ten-ton truck-loads of coal each time she crossed the Atlantic, she now has accommodation for 7000 tons of oil instead. Upon the salt-water highways the future lies largely with the motor ship, which is making its appearance there in ever-growing numbers. Being Diesel-engined, craft of this type have no direct use for coal as a fuel, and every such vessel put into service means a lessening of the demand for the output of the collieries. Looking at the subject comprehensively, one can only arrive at the conclusion that the extending use of oil for fuel purposes constitutes an economic factor that is bound to have a considerable effect upon our coal-mining industry in the future.

The great problem in connection with oil fuel is that of supply. It has been estimated that the world has coal enough to last it for another five hundred years. Nobody can estimate how much oil we possess, for no one knows. So far as Great Britain is concerned, we now have to import most of our stocks of this fuel, and for the time being the supplies are equal to the demand. The shale oils obtained in various parts of the United Kingdom are nearly all suitable for fuel, but the yield is very limited. Hopes are entertained that the new field opened in the Fen district will eventually give large supplies, and it is reported that oil can be obtained there at a cost of 2d. per gallon, as compared with the 10d. per gallon for Scotch shale. Whether this hope will be fulfilled or not we must "wait and see." However, judging by prices quoted and reports from oil-producing centres abroad, supplies available appear to be sufficient for present requirements. How far they would be equal to meeting a greatly extended demand is quite another matter.

Education as a Science.

Education and World Citizenship: An Essay towards a Science of Education. By James Clerk Maxwell Garnett. Pp. x+515. (Cambridge: At the University Press, 1921.) 36s. net.

READERS of Mr. Garnett's papers in the *British Journal of Psychology* and elsewhere will open this stately volume expecting to find substantial fare, nor will they be disappointed. The book is full of vigorous reasoning and independent thought. It is written from a definite point of view, with a definite purpose, which is systematically followed, and it leads to clear-cut conclusions. Its aim is given in its title. It is an attempt to outline a provisional science of education. Mr. Garnett is impressed by the need for an accepted body of scientific principles which will make our educational thought and practice more coherent and efficient. He has therefore made an effort to supply the want, in the modest hope that his attempt may stimulate others to more successful endeavours. The result is one of the few recent discussions of educational theory which deserve to be taken seriously.

Unlike too many writers, Mr. Garnett knows what he means by a science of education. Science, he tells us, is "an organised body of connected facts graded according to their relative importance" (p. 196). Such a body of facts when complete constitutes the "endarchy of science," which

is the world of experience scientifically interpreted—"the neat, trim, tidy, exact world which is the goal of scientific thought." This ideal shapes his conception of the science of education, which is a portion of the complete endarchy of science. It also determines the lines upon which he considers education should be organised in practice. The facts upon which a science of education must be based he borrows from psychology, for psychology enables us to formulate "the laws of thought" from which scientific methods of education can be logically deduced. But the aim of education which must synthesise its methods is not given us by psychology. It depends upon the aim of human life. Unfortunately, the latter aim is still uncertain. We may, however, provisionally define it in the light of such agreement as exists, and thus develop a tentative science of education which will be a first approximation to the truth, and may serve as a provisional guide in practice.

Mr. Garnett's pages are so full of matter that points in his argument may easily be overlooked; but, unless we are mistaken, we have in his conception of educational science one of the sources of the dualism which is the great weakness of his book. Speaking roughly, we may say that education as a normative science must interpret facts in the light of values; but Mr. Garnett gets his facts and his values from different quarters, and as a result they will not mix. His facts remain facts and nothing more, and his values either belong to a world apart from facts, or are merely facts of a certain kind. Thus a man's will is the most valuable thing about him (p. 138); but will is unforeseeable, and possesses no quality that characterises its owner except its strength (p. 291). On the other hand, a fact gains value simply by the frequency of its recurrence (p. 217). This dualism is apparent throughout Mr. Garnett's argument. His endarchy of science is essentially a world of facts as such, and preferably of physical facts. Thus it is only unwillingly that he speaks of the mind and its processes. He prefers to speak of the "comparatively simple material aspects of the brain" (p. 8). His first "law of thought," for example, states that, apart from the intervention of the will, our thought activity at any moment is determined "by the neurones that are excited by the degree of their excitement" (p. 66), which is a rather bold statement. The elements of our mental life are "neurograms"—that is, "low resistance paths among the neurones of the brain or among those of other portions of the nervous system" (p. 42). Our purposes, which recent experiment has shown to play so important a part in our thinking, become

parts of our "neurography," compounded of the neurograms of, say, ourselves, some action, and some future time (p. 144 *et seq.*). This failure to do justice to the significance of purpose is evident in the elaborate discussion of the organisation of thought (chap. xi.).

The same tendency to explain values in terms of facts is seen in Mr. Garnett's use of the phrase "aesthetic satisfaction" to "denote the pleasant feeling that results when the instinct of curiosity achieves its end" (p. 253), and in his description of religious faith as "action on an hypothesis with a view to its verification" (p. 307). More important is the effect of his preoccupation with the tidy, exact world of scientific facts upon his conception of the aim of education. "Every citizen ought to develop a tidy and perfectly integrated mind—a single endarchy of neurograms—which should correspond, so far as the time and effort available for his education and his own 'educability' permit, to the endarchy of science" (p. 313). These individual endarchies will vary according to the citizen's special activities in the life of the community; but in all cases they should centre in a single wide interest system. Education must, therefore, aim at the development of an appropriate single wide interest in the mind of each boy and girl. Schools should be so organised as to offer unified courses of training for different classes of individuals, distinguished mainly by the types of callings for which they are prepared.

Mr. Garnett, however, has too keen an interest in ethics and religion to remain entirely content with the endarchy of science. Hence on ethical grounds he holds that human souls are really free, and can influence neural activity by the exercise of will (p. 97). What exactly is meant by the will and how it is related to the soul and to the body does not seem very clear. But it is the principal factor in developing a single wide interest (p. 268). Such interests, indeed, centre in conscious purposes, and we even find the alarming statement that "the possessor of a single wide interest will tend always to be conscious of his supreme and dominant purpose" (p. 244). In an important chapter (chap. vii.) it is argued that strength of will is measured by g , the index of general ability, and that g can be increased by training. Indeed, the cultivation of strong wills by the formal training of attention is one of the chief ends of education (p. 332 *et seq.*). Again, the world of science is brought into relation with religion, and more particularly with Christianity. "The Christian account of the universe . . . completes the discovered part of the endarchy of science with an hypothesis concerning the hitherto

undiscovered central essences, it does so . . . in a manner that enables the corresponding neurography to fulfil the conditions that have to be satisfied by the neurography of the typical citizen of a maximally efficient and progressive community" (p. 355).

This conception of the function of religion is suggestive in many ways, but it is another example of the loss which the deeper things of life must suffer in order to be fitted into the Procrustes bed of the neat and tidy endarchy of science; and, speaking generally, Mr. Garnett's effort to make room in his world of scientific facts for freedom and religion can scarcely be regarded as successful. His system of education is too cut-and-dried, too externally determined and bureaucratic to meet the deepest demands of human nature. It might give us industrious citizens, good officials, and scientific experts, but scarcely prophets, artists, and men of genius. For while a tidy and integrated mind is greatly to be desired, it is not, perhaps, the highest type of mind we know. As Dr. Rivers has recently reminded us, some degree of mental instability is probably a condition of great achievement in art and science, and gives strength to man's deep craving for religion.

It has been impossible in this review even to touch upon many of the important topics which Mr. Garnett discusses with marked ability and wide knowledge. We may mention, for example, his discussion of general ability, cleverness, and purposefulness. It is from no lack of admiration for his achievement that we have dwelt upon an apparent weakness in his argument. That weakness will, we fear, militate against the general acceptance of his special point of view. But he has done us no small service in giving us a book which treats the theory and practice of education in a thoroughly scientific spirit. It is this spirit which matters most, and the book will stimulate and encourage all who hold loose thinking and vague metaphor to be as pernicious in education as they are in any other field of thought.

Advances in the Study of the Yeasts.

The Yeasts. By Prof. A. Guilliermond. Translated and thoroughly revised in collaboration with the original author by Dr. F. W. Tanner. Pp. xix+424. (New York: John Wiley and Sons, Inc.; London: Chapman and Hall, Ltd., 1920.) 33s. net.

OUR knowledge of the yeasts has made great strides within the past twenty years, and for this we have mainly to thank the classical

researches of Emil Chr. Hansen. It is now realised not only that many industrial concerns depend for their success on a maintenance of conditions favourable to the multiplication of the yeast plant, but also that new fields of interest are unfolded to biologists and students of medical research. A book such as this is a timely addition to our literature, for hitherto we have had to be content with books on the subject of yeasts which had a purely industrial bias. In Prof. Guilliermond's book the whole subject is treated in a comprehensive fashion, and the reader will be able to follow the advances in the subject from different points of view.

Prof. Guilliermond's "Les Levures" appeared in 1912, but the present book is not a mere translation of the French edition; it is rather a collaboration of Dr. Tanner with the author to produce an English work in which it would be possible to incorporate the new material which has appeared since 1912. The idea is a happy one, but it has its disadvantages from the point of view of the reader. Thus, in the first chapter, in which the morphology and development of yeasts are discussed, Prof. Guilliermond is referred to in the third person, with the result that he becomes both counsel and judge in the estimation of the value of his own researches. There is little doubt as to the value of his contributions, but some of the points that have been raised are of a controversial nature, and not such that all biologists can accept without supporting evidence from independent investigators. Such, for example, are the heterogamic copulation of yeasts, and the attitude adopted in regard to the nuclear structures of these bodies. Many statements are of an *ex parte* nature, and raise doubts in the reader's mind as to whether he has heard both sides of the question. Incidentally, Mr. Wager is referred to by the name of "Wagner" throughout this section of the subject.

There is a very useful chapter on the nutrition and physiology of yeasts, which concludes with an unexpectedly scanty account of the theories which have been advanced to account for the alcoholic fermentation they induce. This is disappointing, for, after all, alcohol is responsible for having brought yeasts to the forefront, and the subject is honeycombed with tunnels of investigation.

On the question of phylogeny it is not possible to share the writer's optimism that matters are now "more settled." It is well established that particular growths of micro-organisms may be side-tracked into exceedingly minute structures which can in such a condition multiply indefinitely,

and apparently never emerge into any other forms. It is a common phenomenon in bacterial cultures, and the present reviewer can vouch for the appearance of the phenomenon among some of the higher bacteria. The probability that yeasts are side-tracked offshoots of modern fungi may not be great, but there is sufficient evidence to make this theory not untenable even if some recent work in this direction must be set aside on account of cultural impurities. The chapters on the practical methods that are adopted for the studying of yeasts are somewhat perfunctory. Undoubtedly the most valuable portion of the book is the short description which is given of all the yeasts known to science. The authors have done for yeasts what Migula in his "System der Bakterien" accomplished for bacteria. We are grateful to them for having accomplished this arduous work. Greater knowledge has resulted in slight changes in the classification, but in essentials no striking changes have been effected.

As a book of reference this publication will remain a standard for some time to come. A warning must, however, be given, due to our imperfect knowledge of the activities of micro-organisms. It must not be taken for granted that the discovery of a yeast in a particular medium necessarily credits or discredits it for changes that occur in that medium; nor does it follow that if a name is given to a supposedly new species that species has not been named before. We know that several species of bacteria have received each several names, and it is probable that we are suffering from the same malady in the investigation of the yeasts. This, however, is an irregularity which a general text-book cannot be expected to rectify. We can say in conclusion that this book ought to be in the hands of all those who are interested in yeasts either from the purely scientific or from the industrial point of view.

DAVID ELLIS.

Introduction to the Theory of Curves.

Plane Algebraic Curves. By Prof. Harold Hilton. Pp. xvi+388. (Oxford: At the Clarendon Press, 1920.) 28s. net.

DURING the present century there has been a very considerable increase in the number of students of the calculus, and this increase has been accompanied by a change in the character and content of the text-books. In the latter half of last century a considerable section of works on the calculus dealt with the theory of higher plane curves, and students with a liking for geometry were often led on to a fuller study of that theory, as expounded, for example, in Salmon's well-

known treatise. The tendency in more recent times, however, has been so strong in the direction of physics that less and less space is given in text-books of the calculus to the theory of curves, and the number of students of the theory has probably decreased. But investigation and research have, nevertheless, been continuous, and, now that Salmon's treatise is not readily accessible, even if it were abreast of modern developments, the need for a good introduction in English to the theory of curves has become clamant; such an introduction is to be found in Prof. Hilton's book.

A reader of the book is supposed to possess a knowledge of the more elementary portions of the calculus and of pure and analytical geometry, including the theory of cross-ratio, involution, projection, reciprocation, and inversion. Without a good knowledge of the subjects named the student's progress will not be rapid, and occasionally, as, for example, in the study of super-linear branches, some familiarity with the theory of the expansion of algebraic functions is almost a necessity. But any student who is in earnest will find in Prof. Hilton's exposition an excellent guide to the subject of which he treats. The first eight chapters discuss what may be roughly described as the leading principles—singular points, foci, determination of the branches at singular points, and Plücker's numbers. At an early stage a careful treatment of curve-tracing is given, fully illustrated by well-selected equations, while numerous examples, with hints for the more difficult cases, are provided for practice in this very necessary part of the student's training.

A compact but careful discussion of the quadratic transformation is given in chap. ix.; to a student new to the subject this discussion should be very illuminating. A good chapter on curves given by a parametric representation is followed by an interesting chapter on "Derived Curves," among which are included evolutes, inverse curves, pedal curves, orthoptic and isoptic loci, cissoids, conchoids, and parallel curves. This chapter is of special interest, as the geometry of the curves considered figures more prominently than in the chapters which discuss the algebraic developments that are necessarily associated with the subject. Later chapters treat chiefly of cubics and quartics, and probably it would be hard to find anywhere a better discussion; the chapters do not always make easy reading, but they are well worth the most careful study. Two excellent chapters on circuits and corresponding ranges and pencils bring the work to a close.

A valuable feature of the book is the very large

number of examples provided for practice; there can be no better training for the student than the careful study of these examples. Hints for their solution are given in many cases, but the chief advantage is that a student is really introduced to the methods of research, and put in a position from which he can undertake independent investigation.

The book is provided with a good index, but it might be considered, in view of a later edition, whether a special list might not be made of the more important curves, and a connected summary given of their leading geometrical properties. Such summaries as are to be found in the recent work of Brocard and Lemoyne on "Courbes Géométriques Remarquables" are very instructive.

Aeronautical Treatises.

- (1) *Aeronautics in Theory and Experiment*. By W. L. Cowley and Dr. H. Levy. Second edition. Pp. xii+331+plates. (London: Edward Arnold, 1920.) 25s. net.
- (2) *A Treatise on Airscrews*. By W. E. Park. (The Directly-Useful Technical Series.) Pp. xii+308. (London: Chapman and Hall, Ltd., 1920.) 21s. net.

(1) **T**HE second edition of Mr. Cowley and Dr. Levy's book is now issued, and the authors have seized the opportunity to modify some of the material. This has become possible by the release of official reports for publication. The new items are of an advanced nature, and the book now contains two sections, "Mathematical Theory of Fluid Motion" and "Critical Behaviour of Structures," which are unique in the literature of aeronautics. Both sections are written by the authors as pioneers, for Dr. Levy has a first-hand knowledge of the mathematics of fluid motion and is an original worker in the subject, whilst the "Critical Behaviour of Structures" is the result of joint study by the authors of the complex problems of structural theory.

Throughout the book there is much more theory than experiment, and for the latter the data are, as usual, taken mainly from the reports of the Advisory Committee for Aeronautics. The selection of items in reference to points under consideration is good, and the book can be recommended as sound. It is distinctly a student's book, and is not modelled on the needs of the designer like the great bulk of publications on the subject. In range it covers, sometimes in quite an elementary manner, both the aerodynamic and structural problems connected with the aero-

plane, and should make a good preliminary textbook for a degree in aeronautics.

(2) In his preface Mr. Park says that his aim has been to consider problems of airscrew design and construction from the point of view of the designer. In so doing he explains methods developed for the Lang Propeller Co., Ltd. A very considerable degree of success has been attained, and the book is not difficult to follow. The items of calculation are given in great detail, but are connected with the main outlines of airscrew theory so closely that the book may be used by later workers even when they are more up-to-date in their theories.

It is very noticeable that the two latest books dealing with the subject of airscrew design adopt the attitude that the oldest theory agrees better with practice than a new and presumably sounder one. Empiricism has to this extent rather retarded the development of the subject. The theory adopted in the early days of aeronautics ignored the influence of previous passages of the airscrew blade and its companions, and the effect was found in a disagreement between prediction and observation. An examination of the theory by Lanchester, De Bothezat, and others indicated a loss of efficiency and of torque which was great for the stationary airscrew or helicopter, and of less importance at the highest speeds of flight of an aeroplane. The most difficult part of design being the production of an airscrew which allows the engine to develop full power at a given speed, it was found that the introduction of an inflow factor indicated by a modified theory was advantageous. In the later periods of development the magnitude of the inflow factor required has been found to decrease to the point at which it may be ignored. It is highly probable that this is an incorrect view of the phenomena, and that it would be much more sound to attribute the change to an opposing change due to the compressibility of the air. The importance of this latter factor depends on the tip speed of the airscrew, a quantity which has been steadily increasing. No one has yet propounded a working theory which is based on the best established theoretical data.

The greater part of the treatise by Mr. Park is independent of the refinements mentioned above, and gives a good analysis of the possibilities of airscrew design. In commending the book to readers, one may suggest that it will cover the immediate needs both of a designer and of a scientific student of sufficient ability. A thesis of considerable value might be produced as a result of the data of the book and the critical faculties of the student.

Our Bookshelf.

Practical Biological Chemistry. By Prof. G. Bertrand and P. Thomas. Translated from the third edition by Hector A. Colwell. Pp. xxxii+348. (London: G. Bell and Sons, Ltd., 1920.) 10s. 6d. net.

THIS work will be found of great value by students and, perhaps more particularly, by teachers of biochemistry. The object of the authors has evidently been to provide a series of laboratory exercises illustrating the properties of the chief substances of biochemical interest, and at the same time affording examples of the methods used in the various branches of biochemical investigation. A large number of tests, interesting preparations and estimations are described in the first part (Statics), whilst in the second part (Dynamics) the subjects of enzymes, micro-biology, and fermentations are treated experimentally.

Although the whole range of biochemistry is dealt with, and the exercises are chosen quite impartially from the chemistry of animal and vegetable life, the treatment is nevertheless very unequal as regards both the selection of methods and the degree of detail given. For example, as all readers would desire, a very full account of the admirable Bertrand method for the estimation of sugars is given, and, similarly, Duclaux's ingenious distillation method for the estimation of volatile acids is fully described. On the other hand, although several pages are devoted to the amino-acids, and Sørensen's formaldehyde titration method is described, there is no mention of van Slyke's method for the estimation of amino-nitrogen, and, indeed, the name of van Slyke does not occur in the index. Again, the conception of hydrogen-ion concentration is mentioned, but no practical use of it is made in the book. It is on account of this arbitrary element in the treatment that we consider the book as likely to be of greater value for teachers than for students; but whoever uses it will find in it many interesting and unusual experiments, described in a clear and suggestive manner, without too great a load of detail. The translator has done his work well, and has added a few notes, including a detailed description of the use of the Maquenne block for the determination of melting points.

A. HARDEN.

Wireless Telegraphy: With Special Reference to the Quenched-Spark System. By B. Leggett. (The Directly-Useful Technical Series.) Pp. xv+485. (London: Chapman and Hall, Ltd., 1921.) 30s. net.

WE welcome this volume, which gives full practical details of the "Telefunken" or quenched-spark system of radiotelegraphy. (We use this word, for we think it will shortly receive international sanction.) Practically all the treatises on this subject published in English concern themselves mainly with the Marconi system, and dis-

cuss very briefly, if at all, the quenched-spark system. In 1906 Max Wien showed that it was possible to quench the oscillations in the primary circuit of the sending station after a few oscillations, leaving the bulk of the electromagnetic energy to be expended in, and radiated from, the antenna circuit alone. Hence the efficiency and the amount of energy radiated are practically doubled. The system is the standard one in Germany; and the author thinks that possibly national prejudice has prevented us from judging its merits fairly.

It is far too early yet to standardise in radiotelegraphy. The Marconi Co. has entered into an agreement with the Telefunken Co., and this will probably eliminate much healthy competition. The United States has adopted the Telefunken system for both land and ship stations, and Messrs. Siemens, of Woolwich, have fitted many stations of this type on both British merchant- and war-ships. We agree with the author in thinking that for marine work radiotelephony will be of limited use except in the unlikely event of all maritime nations agreeing to the simultaneous adoption of some form of Esperanto.

An interesting description is given of the station at Nauen, about 25 miles from Berlin, which is the most powerful radio station in the world. Its normal range is 9000 kilometres, and the messages are regularly received in Australia.

The Coco-nut. By Prof. E. B. Copeland. Second edition, revised. Pp. xvi+225. (London: Macmillan and Co., Ltd., 1921.) 20s. net.

THE first edition of this excellent handbook was reviewed in NATURE for February 25, 1915 (p. 695). In the new edition the subject-matter remains substantially the same, and the revision consists chiefly in recording the results of certain scientific work relating to the coco-nut industry carried out in the Philippines during the last six years. Reference is made to the investigations on copra and coco-nut oil by Messrs. Brill, Parker, and Yates in 1917, which dealt mainly with the conditions governing the production of a fine-quality copra of high oil-content. On the cultural side an account is given of the discovery, by Reinking in 1918, that the primary causative organism of bud-rot of the coco-nut palm in the Philippines is *Phytophthora Faberi*, Maub. It would have been useful to mention that a serious bud-rot of coco-nut palms in southern India (Malabar) was described by Shaw and Sundaraman in 1914 as due to *Pythium palmivorum*, Butl. References are also made to interesting work on the growth and behaviour of young and ripening coco-nuts, and to the use of the nuts of young trees as seed. In the foreword the author refers to the impetus given during the war to the export of coco-nut oil from coco-nut-growing countries in place of copra. In his opinion the remarkable advance in this direction made in the Philippines during recent years would have been

impossible but for the scientific and educational work on coco-nut cultivation organised by the Philippine Government.

The Early History of Surgery in Great Britain. By Dr. G. Parker. (Medical History Manuals.) Pp. ix+204. (London: A. and C. Black, Ltd., 1920.) 7s. 6d. net.

DR. PARKER has written a very delightful account of the rise and development of surgery in our country. He is fortunate in his judgment, his sense of proportion, and his style; he is neither dry nor gossipy. The great figures stand out; nothing could be better than his lightly touched portraits of John of Arderne, William Clowes, Richard Wiseman—all strong-willed, practical, shrewd, kindly, observant men. They were hindered at every turn by their lack of more science; but they were splendid craftsmen and good artists of the living fabric of the body. The stories of their deeds and their adventures, their sympathy, their insight, are fresh and vivid, especially in military surgery. Here and there a note of prophecy is in their work; thus we find Henri de Mondeville (1260-1320) making statements which were fulfilled in Lister's work.

Three great periods come into the book: (1) The twelfth century: the rise of universities and of hospitals; (2) the Renaissance; (3) the eighteenth century: the development of hospital schools and of clinical teaching. The book goes no further; we must read elsewhere of the new learning which came with Pasteur and Lister. It came when surgery was in a bad way. The development of surgery is not constant, and the first half of the nineteenth century was a period of arrest, relapse, almost of degeneracy. Happily, this fine art made a complete recovery. Let us hope that the other fine arts, which now are in an equally bad condition, will follow its example.

Fornander Collection of Hawaiian Antiquities and Folk-lore. By A. Fornander. With translations. Edited and illustrated with notes by T. G. Thrum. Third series. Part iii. (Memoirs of the Bernice Pauahi Bishop Museum. Vol. vi., No. 3.) Pp. iii+359-546. (Honolulu, H.I., 1920.)

THE publication of the present instalment of the great collection of materials made by Mr. Abraham Fornander, the author of "An Account of the Polynesian Race," will be of great interest to antiquaries and students of folk-lore. Many of the chants now edited in the original dialect, with an English translation and elaborate explanatory notes, the latter mainly based on the notes by Judge L. Andrews, are comparatively modern. Thus the great Wakea Creation chant is the work of the priest-diviner, Kaleikuahulu, who was born in 1725; but doubtless it is based upon ancient tradition. The notes throughout supply complete comments upon the philology, history, and folk-lore which the volume contains. Merely as a collection of materials for linguistic study, the volume, published in admirable style, must be of great value to the philologist.

Letters to the Editor.

[The Editor does not hold himself responsible for opinions expressed by his correspondents. Neither can he undertake to return, or to correspond with the writers of, rejected manuscripts intended for this or any other part of NATURE. No notice is taken of anonymous communications.]

The Aurora of May 13-15.

IN pursuance of the programme outlined in my letter to NATURE of March 31, p. 137, I have been photographing the spectrum of the night sky every night. On the night of May 13-14, and also of May 14-15, a strong auroral spectrum was obtained, showing the aurora line $\lambda 5578$, and also the negative bands of nitrogen, which were much stronger than the aurora line. Ten heads of these bands were shown on the photograph of May 14-15, though only six appear within the same spectral range in Vegard's investigation made on a special expedition to the Arctic.

That these nitrogen bands should be actually stronger than the aurora line is very remarkable. On ordinary nights it is generally possible to photograph the aurora line, while the nitrogen bands have never been photographed in the course of about 100 nights except on these two consecutive occasions.

It is of interest to note that the aurora apparently ceased before the magnetic storm was over, according to the data given by Dr. Chree in NATURE of May 19, p. 359. On the night of May 15-16 the aurora line was barely, if at all, visible on the plate, and below its average intensity on ordinary nights. Nothing could be seen of the nitrogen bands.

RAYLEIGH.

The Gravitational Field of an Electron.

IN the Proceedings of the Royal Society for February last (vol. xcix., A, p. 123) is an interesting paper by Dr. G. B. Jeffery, in which he applies an extension of Einstein's theory to ascertain something about the state of the æther close to an electron—though perhaps he might not express it in that way. He obtains independently, and then discusses, a result recently published by Nordström, namely, an extension of the now well-known γ of Schwarzschild's equation,

$$ds^2 = \gamma^{-1} dr^2 + \text{etc.} - \gamma c^2 dt^2,$$

by adding to it a mixed gravitational and electrical term, so that it becomes

$$\gamma = 1 - \frac{2Gm}{rc^2} + \frac{Ge^2}{Kr^2c^4};$$

wherein, while the old second term involves the gravitational potential, the new third term involves the square of the electrostatic potential.

I have introduced the dielectric constant of the æther into the denominator so as to keep dimensions right, and if we now choose to make use of the familiar "J. J. T." (1881) expression for the inertia of an electric charge, $m = 2\mu e^2/3a$ —which is reasonable, inasmuch as the gravitation constant is dominant over both the second and third terms—we may write the above value of γ thus:

$$\gamma = 1 - \frac{2Gm}{rc^2} \left(1 - \frac{3a}{4r} \right).$$

This expression attains a minimum value when $r = \frac{3}{4}a$; and it is unity both at infinity and at $r = \frac{3}{4}a$. This last probably means that the electric and mass terms just balance at the surface of an electron (for we may probably ignore the $\frac{3}{4}$ factor as unlikely

to be accurate so close to a charge), or else it means that the gravitational effect at an electron-boundary is reduced to one-quarter of its normal value. The formula does not apply in the interior of an electron, if an electron has any interior; though if it is a geometrical point, as Dr. Jeffery evidently thinks possible, then γ may rise to a very high value within what is commonly thought of as the boundary.

It is not to be thought that the new term is merely the natural consequence of electromagnetic mass, for it is opposed in sign; the electrical and the mass effects tend to neutralise each other; but nowhere do they succeed except at or near the boundary of an electron. For all distances large compared with the size of an electron γ has its customary Einstein value, so the third term has no astronomical significance whatever.

But a study of what happens to radiation when it impinges on, or penetrates between, the ultimate elements of matter—in fact, a study of the whole behaviour of a stream of radiation at its two ends, the source and the sink—is obviously of great importance. An immense amount of work has been done on the emission end of radiation, but less on the absorption end. By the two together we may ultimately hope to get some information as to the structure of an electron. It may be pardonable to mention some small papers of my own in this connection, in the *Philosophical Magazine* for April and probably for June and July this year, though the full working out is not attempted.

It must be emphasised that the e^2 , above, means the square of the unbalanced charge—it is $(\Sigma e)^2$ not $\Sigma(e^2)$ —and that all neutralised charges are provided for by the second term. The conclusion that unbalanced electric potential and neutralised or mass potential oppose each other in their warping effect on the æther appears rather suggestive. I confess I should have expected a third term which did not involve the gravitation constant; and perhaps there may be a reconsideration on this point, for the present manner of obtaining the expression is far from easy—in fact, is abstruse.

OLIVER LODGE.

The Magnetic Storm of May 13-17.

THE magnetic storm which began soon after 1 p.m. on May 13 presented several unusual features beyond that of almost unprecedented magnitude. As recorded on the Eskdalemuir magnetographs, it showed a "sudden commencement" at 13h. 13m. G.M.T. on May 13. The phenomenon known by this name usually takes the form of a sharp change in value of the horizontal components of terrestrial force, frequently including as its first part a temporary drop in value lasting for about a minute, but always exhibiting a rise in value immediately thereafter. In the vertical component the change, when appreciable, is very much slower and is in the direction of the zenith. In the case of the storm now described the change in the north component was too quick for the photographic paper to receive a visible impression of the light spot. On the west component a drop in value is shown at first, amounting to 29 γ (0.00029 C.G.S.) and extending over two minutes. There then followed a rise of 94 γ , occupying 2½ minutes. On the vertical component the "sudden commencement" assumed an unusual form. There is quite clear evidence of a preliminary increase in value of the vertically downward directed force amounting to 8 γ , followed immediately by a reverse change of 31 γ , the latter being much more rapid than is generally the case. These preliminary phases having passed, the main features of the disturbance were quickly developed. This is quite in accord with the results of

previous experience, which shows that, as a rule, when a "sudden commencement" occurs not far from noon of local time the principal maxima and minima of the storm occur within the next twelve or fifteen hours, but that if the "sudden commencement" occurs late in the day the full development of the disturbance is postponed until the *post-meridien* hours of the following day.

The changes in the horizontal components of force throughout the disturbance were on a very large scale, and took place with a rapidity so great that the photographic traces are in some parts too faint to read. But the most unusual feature of the storm was the remarkable series of changes in the value of the vertical component of force. In most magnetic storms the general course of events comprises (1) a gradual increase in V to a maximum (in some cases two successive maxima) reached about 18h. local time, (2) a gradual fall until midnight, (3) a rapid fall to a minimum which is reached about 1h., (4) a gradual recovery to nearly the undisturbed value, which recovery is completed by about 8h., and is sometimes accompanied by (5) a series of short-period pulsations. The whole sequence is frequently repeated on a modified scale later on in the second day. In the storms now described this course of events was followed so far as the first twenty-four hours are concerned. The first maximum on May 13 was reached at 20h. 37m., and was 152 γ above the undisturbed value at the time of the "sudden commencement." One or two falls in value succeeded until 21h. 24m., when a rapid fall of more than 350 γ in six minutes carried the light spot off the paper. The principal minimum which then occurred took place at an unusually early hour (see "British Meteorological and Magnetic Yearbook," 1915, part iv., p. 89, and plate vi.). According to the theory which would account for magnetic storm phenomena by assigning them to the earth's rotation in a beam of particles emanating from the sun, this sudden drop in the value of V might be supposed to take place at or soon after midnight of local time, but not so early as 9 p.m. The rate of change in V during the descent to the minimum referred to was large, but by no means the largest recorded at Eskdalemuir. For example, the storm of March 23, 1920, showed a case of V changing at the rate of 160 γ per minute. The gradual recovery which followed the minimum was accompanied, particularly between 6h. and 8h., by pulsations of about four minutes' period and of amplitude averaging about 4 γ . It is, perhaps, unsafe to generalise, but there is some evidence to show that such pulsations in vertical force do not occur in a magnetic storm unless the total range of disturbance in V exceeds a certain amount.

The second twenty-four hours of the storm showed even more remarkable developments than the first. After several maxima and minima had been passed the value of V began to fall about 23h. on May 14, and the light spot went off the paper at midnight. Between 1h. and 6h. on May 15 at least a dozen extensive and rapid changes in V took place, swinging the light spot alternately beyond the upper and below the lower edge of the paper. The most clearly marked of these occurred between 2h. 40m. and 2h. 44m. on May 15, and involved a change during that interval at the rate of 138 γ per minute. Repeated oscillations of this character and magnitude have not hitherto been recorded at Eskdalemuir. The course of the disturbance during May 16 was remarkable in that the fall in the value of V during the early hours of the morning continued until nearly 7h.

The storm had practically died down by noon on May 17, but soon after 22h. on that day another

"sudden commencement" was recorded, and the sheet which will be taken off the recording drums to-morrow morning will probably show a recurrence of disturbance.

A. CRICHTON MITCHELL.

Eskdalemuir Observatory, May 18.

Ocean Tides.

THE article in NATURE of March 10, p. 33, on oceanographic problems by "J. J." prompts one interested in tides to direct attention to the services which a new *Challenger* expedition might render to the general theory of ocean tides at relatively little cost either in time or in money.

There are numerous localities for which tidal information is either inadequate or wholly lacking. Sir George Darwin directed attention to some of these places by publishing in the *Geographical Journal* of November, 1909, a memorandum prepared by the late Dr. R. A. Harris, of the U.S. Coast and Geodetic Survey. The "dozen or so landing parties placed here and there over the world" suggested by "J. J." could undoubtedly use to advantage as their bases of operations some of these places for which tidal observations are needed. These suggested landing parties could therefore, in connection with their other observations, secure tidal data of great value.

It may not, perhaps, be amiss here to point out that such tidal observations would serve two important purposes. In the first place, they would increase our geographical knowledge of the regional distribution and local characteristics of the tides; and in the second, they would furnish further data of an accurate character to test the merits of the various tidal theories that attempt to interpret mathematically the terrestrial phenomena of the tides. Thus some of the places for which tidal information is desired are of critical importance to the so-called "stationary wave" theory of tides, which appears steadily to be gaining in favour.

The use of automatic or self-recording tide gauges would, of course, be most desirable. In this connection it is to be noted that such tide gauges may now be had in small and inexpensive types that require no elaborate installation and may be expeditiously set up. It cannot, however, be too strongly emphasised that valuable additions to our knowledge of the tides at out-of-the-way or infrequently visited places may be secured by recording hourly the height of the tide as registered on a naked tide-staff graduated to feet and tenths. The longer the series of observations, the better; but even a day or two will furnish considerable information.

The value of the tidal observations would be greatly enhanced if bench-marks of a permanent character were established and the relation of the zero of the tide-staff to these bench-marks determined. This would make possible correlation with any future tidal observations at the same places, and might even permit a quantitative determination of the local rate of elevation or subsidence of the land relative to the sea.

A fertile and almost virgin field is offered to the investigators of a new *Challenger* expedition in the study of the tides of the open sea, the importance of which is obvious. Several forms of automatic tide gauges adapted for offshore tidal observations appear to have given satisfactory service. Recently an offshore hydrographic party secured an excellent series of tidal observations by means of an improvised tide gauge consisting of a graduated tide-staff secured to a float and confined in a float-tube made up of sections of 2-in. pipe, the lowest section of which was cast into a block of cement. It also appears that satis-

factory results may be obtained by means of a sounding wire attached to a heavy block of concrete or box of stones (see *Science*, vol. xlii., 1904, p. 704).

Those members of the new *Challenger* expedition whom fortune may choose to be responsible for the tidal observations have it in their hands to make all tidal workers using their data everlastingly grateful. This gratitude they may secure by insisting that the tidal observations should be made in Greenwich mean civil time, reckoning the hours from 0 to 23. Apart from the many advantages for purposes of computation resulting from such procedure and the ease with which time comparisons of the tide at different places may be made, there is one outstanding advantage—it will remove all uncertainty as to the kind of time used. Many otherwise excellent tidal observations are of little use because there is no certainty as to the kind of time employed, whether mean local civil, mean local astronomical, local apparent or standard time for some unknown meridian. The use of Greenwich mean civil time should prove further desirable in view of the change to this kind of time soon to be made in the Nautical Almanac published by the British Admiralty.

H. A. MARMER.

U.S. Coast and Geodetic Survey, Washington, D.C., April 15.

The Physical Status of "Space."

To answer all Mr. Bonacina's points (*NATURE*, May 5, p. 300) is not possible in a single letter. I agree with him that no rigid boundary can be drawn between the provinces of the older physics and metaphysics. Concepts are freely introduced into both which are not known to experience, and are never used either in describing past experience or in inferring future experience. Some hypotheses are necessary in any science, but hypotheses that are never used are neither necessary nor useful. The elastic solid æther forms an excellent example of these. It is assumed that electric and magnetic forces satisfy certain differential equations, and this is the only assumption required for the theory of the propagation of electromagnetic waves. The æther theory, however, introduces the additional hypothesis that one of these forces is a displacement in an elastic solid the properties of which differ from those of any ordinary solid. This assumption is never used, has no basis in experience, and cannot be tested experimentally. Accordingly I say it should not be made, for the introduction of additional hypotheses decreases the probability of the theory. The other assumption, which is valuable and leads to much new knowledge, makes no mention of an æther. It appears to be the case that all so-called explanations of physical laws by means of the æther are really based on some mathematical assumption that makes no reference to an æther at all.

I cannot see Mr. Bonacina's difficulty about "empty space." I have advanced no theory involving any such entity, and think that space is as useless a concept in physics as æther. To construct a space with suitable properties may be an aim of physics, but it is certainly not the starting point. The existence of entities incapable of being objects of experience is a thorny problem even to metaphysicians, and I think that physicists would do well to postpone its consideration so far as possible until they have some idea of the basis in their knowledge of the propositions to which they attach high probabilities.

Dr. Campbell's point (May 5, p. 301) is dealt with in the article (*NATURE*, February 17) of which I was part author. Geometry is *not* the measurement of

the earth, and never was; it was pointed out in the article that that excellent idea in nomenclature was never carried out. Euclid's geometry was, from the nature of its constructions and postulates, quite inapplicable to earth measurement. If anyone doubts this, let him consider the definitions and axioms as they stand and see how many of them are verifiable in even a few cases on a scale such as occurs in surveying. Further, Euclid's treatment assumes that the postulates are true in all cases. To suggest that this can be known by experiment is ridiculous. It is at best an inference to which a high probability can be attached. I know of nobody but Einstein and his followers who has used the word "geometry" in any other than the mathematical sense. The measurement of the earth is always known as "geodesy," and has been for more than a century; and measurement in general is "mensuration," the most important and least discussed of all sciences. Constancy in terminology requires that these meanings should be retained. Dr. Campbell would scarcely claim that measurement in general should be called "geometry" in *his* sense.

HAROLD JEFFREYS.

The Reparation Act and Scientific Research.

PROF. GARDINER (*NATURE*, May 19, p. 359) is one of many British men of science who are helping to pay the German war indemnity. One does not obtain goods from Germany unless one is compelled; it is difficult to see how standard German books and new publications can be procured from home industries, and they are necessary to research. In other cases the goods might be expected to be made by British firms. For many months I have been trying to obtain Wollaston wire of a certain diameter from a well-known British firm. At first I was informed that it could not possibly be made. I had bought it before in Germany, so they tried to make it. Several samples were unsatisfactory, and finally I was told that the British firm did not wish to make any further attempts. I then ordered some of the German wire, which I was required to pay for in advance, for the reason stated by Prof. Gardiner. This was reasonable, as the price charged by the German firm, *plus* indemnity which I pay, is less than I have been paying for unsatisfactory wire in England. The wire was on the way for several weeks. Meanwhile work was delayed. The Customs officials know nothing of the reduction of the tax from 100 per cent. to 26 per cent., announced by Mr. Chamberlain. Another order for new books, given in February, was dispatched from Bonn on March 4, and arrived in London on April 12 and April 16. Notice from the Customs was received a month later. After two days spent at the Customs filling up forms, and five letters requesting delivery, I still await the latter.

The condition of the British man of science who elects to do research will soon become impossible. Perhaps that is really the idea behind all this. The extension of the "key industry" idea will finish us altogether.

J. R. PARTINGTON.

East London College, University of London,
May 20.

The Resonance Theory of Hearing.

I SHOULD like, in the first place, to take this opportunity of thanking Dr. Perrett for his reply in *NATURE* of May 5 (p. 301), but I feel difficulty in accepting the explanation he there advances on the displacement hypothesis, because it does not seem to me to fit in

with the following observations. When a short interruption is made in a musical note it is not a beat (*i.e.* a short silence) that is heard, but, on the contrary, a short noise which appears to add itself to the uninterrupted note. The way this short interruption is produced and an explanation of the noise that results according to the resonance theory of hearing will be found in the *British Journal of Psychology* (vol. xi., 1921, p. 277).

If, then, in order to change the phase of a note by π , the usual interval between successive impulses is altered from τ to $\tau \times \frac{3}{2}$, the beat (*i.e.* the silent interval) which the observer hears cannot be due to the mere interruption in the sequence of the waves, because experiment shows that such an interruption would be heard as a short noise. But, further, even if Dr. Perrett's explanation could be accepted for the case where the interval is increased from τ to $\tau \times \frac{3}{2}$, it clearly could not, I think, apply to the case where, in order to introduce a change of phase of π , τ is reduced to $\tau/2$; for on Dr. Perrett's reasoning no beat should be evident in this case, whereas experiment shows it to be present. H. HARTRIDGE.

King's College, Cambridge.

Hæmoglobin in Mollusca.

SIR RAY LANKESTER will find some interesting experiments on the usefulness of hæmoglobin to *Planorbis* and *Chironomus* larvæ in a paper by Leitch in the *Journal of Physiology* (vol. 1, 1916, p. 370), in which the author indicates that its respiratory value comes into play only when the oxygen pressure is quite low. This does not, of course, solve the problem as to why there should be various closely allied mollusca (*Limnæa*) living side by side with *Planorbis*, and with apparently equal success, which have no hæmoglobin beyond a trace in the muscles of their lingual apparatus. The possession of a considerable quantity of hæmoglobin seems to be a generic character, since it is present in all the species of *Planorbis*, which differ a good deal among themselves in their habits and in their capacity to live in clean and dirty water, and absent in all sorts of *Limnæa*. Sir Ray Lankester seems to have forgotten what he taught me in his elementary class twenty-six years ago: that hæmoglobin has come to have secondary (decorative) uses in man; but he will perhaps be as loath to admit an æsthetic sense in snails and their companions as he has been to accept the selective intelligence of Earland's foraminifera in building their tests. But the albino form of *Planorbis corneus* found by Mr. W. T. Webster near Barnet, in which the colour of the hæmoglobin is not obscured by black pigment, is certainly a gorgeous spectacle. A. E. BOYCOTT.

17 Loom Lane, Radlett, May 14.

Physiological Reactions in the Protozoa.

It would be deplorable if the letter by Mr. Ludford, and with the address of a zoological laboratory (*NATURE*, May 12, p. 332), should be thought by anyone to represent the attitude of zoologists in general or of protozoologists in particular towards physiological problems. It would be hard to find a more individualistic reaction than the "grouping" of Protozoa in direct response to a particular chemical or physical stimulus. Typical experiments are described in every physiological or protozoological

text-book, and it requires some imagination to see in such behaviour "the dawn of a gregarious instinct."

It is difficult to understand how any student of zoology or biology could have written the sentence beginning "On the part of Protozoa, protection against toxins in the water is a necessary *precaution that has to be taken to safeguard the individual*" (*italics mine*). Do the Protozoa really practise sanitary science, and are they no longer subject to natural selection?

J. S. DUNKERLY.

Zoology Department, The University,
Glasgow.

Picture-hanging Wire.

IN reference to Mr. Marston's letter upon the above subject (*NATURE*, May 19, p. 362), I have for many years past used and advocated the use of plain copper wire in preference to any other means of suspension. The only matter that calls for careful attention is avoidance of "kinks." With heavy pictures my practice is to have two entirely independent suspensions—screw-eyes, wire, and wall nail or hook—the duplicate being entirely screened by the picture, and either actually or so nearly sharing the weight that should the other suspension fail it could take the whole load at once without jar.

If I use a (nailed-on) wall-hook I put a stout nail immediately beneath to provide against failure of the brass hook, and I have found it a good plan when using a brass-headed nail to drive in a wire nail at a steep angle beneath it so that the head of the wire nail lodges beneath the brass head. The wire nail acts excellently as a strut. A. J. STUBBS.

Anode Rays of Beryllium.

THE method of anode-ray analysis which was used to determine the isotopes of lithium (*NATURE*, February 24, p. 827) has recently been applied to the case of beryllium. A well-marked parabola was found corresponding to a single charge and an atomic weight 9.0 ± 0.1 ($N_a = 23$). No second line was observed which could with certainty be attributed to beryllium, but the parabola at 9.0 was not so strong as that at 7.0 for lithium, and it is doubtful if one of a tenth the intensity could be observed. On one plate a scarcely perceptible indication of a line was found in the neighbourhood of 10, but as more recent photographs, in which the line at 9 was stronger, did not show it, it seems likely that it was not due to beryllium. No indication was found which would suggest that the atom of beryllium can lose two electrons under the conditions of these experiments.

G. P. THOMSON.

Cavendish Laboratory, Cambridge, May 23.

The Colours of Primroses.

MAY not Dr. Heslop Harrison's experiences of primulas (*NATURE*, May 19, p. 359) be due to the influence of cold and somewhat resemble what is seen in our so-called copper-beech in the spring and early summer? Few seem to be aware that during the summer its characteristic colour entirely disappears and it then has the ordinary green foliage. Other plants, too, *e.g.* some varieties of roses, show the same sensitiveness. G. ABBOTT.

May 24.

The Japanese Artificially Induced Pearl.

By DR. H. LYSTER JAMESON.

ON May 4 a London evening paper announced that quantities of artificially produced Japanese pearls, of perfectly spherical shape, but containing in their centres beads of mother-of-pearl, had found their way into the London market



FIG. 1.—Section through the centre of a natural pearl, $\times 64$. (Ordinary light.) Preparation and photo by M. A. Brammall.

FIG. 2.—Section through the centre of a Mikimoto pearl, $\times 64$. (Ordinary light.) Mr. A. Brammall.

and had deceived experienced pearl merchants in Hatton Garden, who had bought and resold them as naturally produced gems. Since that date many inaccurate, misleading, and contradictory announcements have appeared in the daily papers, leaving the public, both lay and scientific, in some confusion. The following statement of the position, so far as it can be judged from the scientific point of view, may therefore be useful.

For some years Mr. K. Mikimoto, the pioneer in the application of scientific knowledge to the pearl oyster on a commercial scale, has been producing in Japan, and selling under the name of "Mikimoto pearls," pearls of this description. There was no secret about this. Mr. Mikimoto not only sold them as artificially produced pearls, but also published in one of his catalogues (No. 33) a short description and diagram explaining his process.

Ever since 1898 Mr. Mikimoto (who began his work in collaboration with the late Prof. K. Mitsukuri in 1890) has been marketing half-pearls or "blisters," pearly excrescences formed by inserting a mother-of-pearl bead between the body of the oyster and the shell, and allowing the oyster to coat it over with nacre. This was, of course, merely a development of the very old operation by which the Chinese produce, in fresh-

water mussels, the well-known mother-of-pearl images of Buddha, and of Linnæus's classical experiments in the eighteenth century. These products were known as "culture pearls," and have long been familiar in this country, set in brooches, tie-pins, rings, etc. Their value, compared with real pearls of corresponding sizes, was, of course, quite small.

For many years Mr. Mikimoto experimented with a view to the production of a complete pearl, not attached to the shell, by a modification of this process, and obtained his first successful results about 1912, as announced by me at the Dundee meeting of the British Association in that year. From information supplied to me by Mr. K. Ikeda, one of Mr. Mikimoto's staff, in a letter from Tokyo dated May 30, 1914, it appears that the first considerable crop of these "round cultivated pearls" was harvested in the autumn of 1913. Their production is now an important part of the original Japanese industry.

Apart from the purely financial question as to the degree to which the advent of artificially induced pearls is likely to affect the price of natural pearls, two questions seem to have been agitating the public: Are these products "pearls"? and Can a test be devised by which, without destroying them, they can be distinguished from pearls of natural origin?

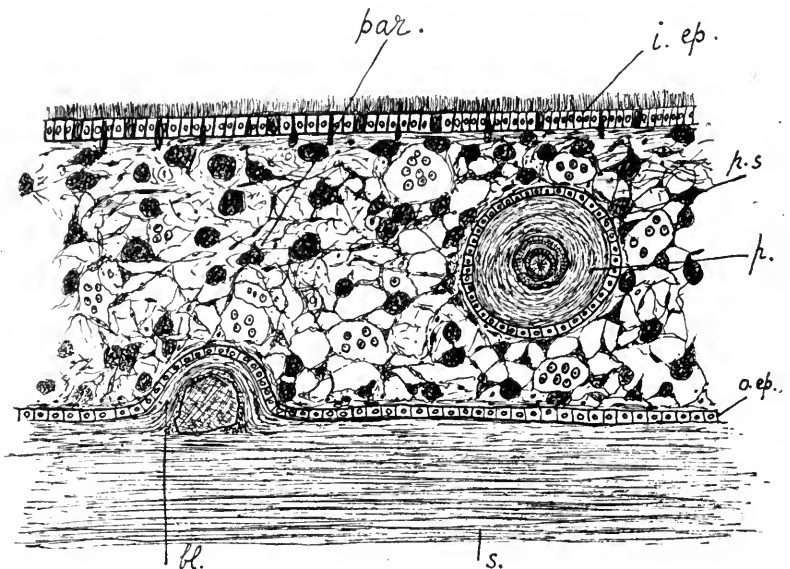

FIG. 3.—Diagram illustrating the difference between a pearl (*p.*) and a blister (*bl.*). *s.*, substance of shell; *a.ep.*, outer shell-secreting epidermis; *p.s.*, pearl-sac, formed of shell-secreting epidermis; *i.ep.*, inner ciliated epidermis of mantle cavity; *par.*, parenchymatous connective tissue of mantle.

Of course, when a slice is cut across a natural pearl and a Mikimoto pearl the distinction is obvious. A natural pearl, except in those (in my experience exceptional) cases where a nucleus of foreign origin and of sufficient size to be identified

(such as a grain of sand) is present, consists throughout of concentrically deposited layers, which differ in degree of transparency or opacity in different specimens (Fig. 1). The Mikimoto pearl, in its outer layers, has the same structure as the natural pearl, but has an artificially manufactured bead of mother-of-pearl, composed of flat parallel laminae of nacre, in its centre (Fig. 2). (These preparations and photos were made under the supervision of Mr. Brammall, to whose investigations reference is made below.)

The method by which Mr. Mikimoto produces these pearls has been patented by him in Japan and other countries, and an application for a British patent has already been filed, and is open for inspection at the Patent Office. The information here given was obtained from this specification, from a short description and figure published in one of Mr. Mikimoto's catalogues, and from facts supplied by Mr. Toranosuke Kato, his London representative. The process involves the most delicate and skilful manipulation, and it could be carried out, presumably, only by carefully selected and trained workers. The shell is removed from one pearl oyster, and a bead of nacre or other suitable nucleus is laid on the outer shell-secreting epidermis of the mantle. This epidermis, which is composed of a single layer of cells of microscopic size, is then dissected off the oyster, and made to envelop the nucleus as a sac, the neck of which is ligatured. This sac is then transplanted into a second oyster and embedded in its sub-epidermal tissues, the ligature is removed, certain astringents or other reagents are applied to the wound, and the second oyster, with its grafted pearl sac containing the mother-of-pearl bead, is returned to the sea, where it has to remain for several years before a coating of pearl of sufficient thickness is secreted around the introduced bead. (In his letter of May 30, 1914, Mr. Ikeda stated that it took seven years.)

Now Mr. Mikimoto's success is based on the fact, which follows from my work in 1902,¹ and was further demonstrated by Alverdes's remarkable experiments ten years later,² that it is not the presence of an irritating intrusive body that determines the formation of a pearl, but the presence in the sub-epidermal tissues of the oyster of a closed sac of the shell-secreting epidermis, the secreting surface of which is not continuous with the secreting surface of the epidermis which lays down the shell; and that unless this epidermal sac is introduced by transplantation (as in Alverdes's and Mikimoto's methods), or is induced by the specific stimulation of a particular kind of parasite (as in the pearls in *Mytilus* caused by the trematode *Gymnophallus*), or arises by some still

unknown cause or causes (as in the Ceylon pearl oyster), no irritating body introduced into the shell or tissues can be expected to become the nucleus of a pearl. In my 1912 paper³ I showed that the vast majority of pearls from the true pearl and mother-of-pearl oysters have no recognisable nuclei of foreign origin, the bodies so often taken for such, like the dark portion of the pearl shown in Fig. 1, and the centre of the pearl diagrammatically shown in Fig. 3, being composed of a kind of shell substance of pathological origin, identical with that with which the oyster repairs an injury to its shell.⁴ On the other hand, some of the natural pearls I have examined contained foreign bodies which (apart from the special case of the trematode which causes pearl sacs to form in *Mytilus*) ranged from diatoms and fragments of radiolarian shells and sponge spicules to quartz grains measuring, in one case, as much as 0.8 mm. in diameter. I propose to outline a theory attempting to account for the presence of these bodies in a later paper.

From the biological aspect there are two classes of pearly bodies. For the first of these, to distinguish them from true pearls, I adopted the name "blisters," familiar to pearl fishers, in 1902. Blisters (Fig. 3, *bl.*) are excrescences on the interior of the shell formed to close holes made by shell-boring animals, or to coat over intrusive objects such as grains of sand, small crabs, *Fier-asfer*, etc., and, in the case of the Buddha "pearls," Linnæus's "pearls," and the "half pearls" originally produced by Mr. Mikimoto, metal images or beads. Over such a blister the epidermis forms a little pocket, directly continuous with the shell-secreting epithelium. A pearl, on the other hand (Fig. 3, *p.*), is formed in a closed sac of shell-secreting epidermis, which is embedded in the tissues of the oyster, and the nacre-secreting surface of which is not continuous with that of the epidermis that lays down the shell itself. A blister is a more or less hemispherical body passing over on all sides into the shell substance; a pearl is a concentrically deposited body, the substance of which is nowhere continuous with that of the shell. A pearl may, in the course of time, be ejected into the space between mantle and shell, and become more or less buried in the shell, forming the core of a blister; but in that case it can be dissected out from the shell layers deposited over it.

The trade distinguishes different kinds of pearls according to shape and size (fine pearls, baroque pearls, seed pearls, etc.), just as biologists distinguish certain classes according to where they arise (parenchyma or mantle pearls, muscle pearls), or to the kind of shell material of

¹ Jameson, Proceedings of the Zoological Society, 1902, vol. i., pp. 140-66, and NATURE, January 22, 1902, p. 280.

² F. Alverdes, "Versuche über die künstliche Erzeugung von Mantelperlen bei Susswassermuscheln," *Zool. Anzeiger*, vol. xlii., No. 1, 1913, pp. 441-58.

³ Jameson, Proceedings of the Zoological Society, 1912, pp. 260-353.

⁴ It is astonishing how the "foreign nucleus" theory of pearl formation sticks, as witness the utterances of scientific men of standing which have been called forth by the recent announcement.

which they are composed (nacreous pearls, columnar pearls, hypostracum pearls, periostracum pearls, hinge pearls). All these classes, some valuable, some worthless, are, from the biological point of view, *pearls*. Biologically speaking, the Mikimoto pearl satisfies all the conditions which go to make up a pearl as defined above. It differs from a natural pearl only in that it contains a foreign nucleus larger than any foreign nucleus which I have so far encountered in a natural pearl, and in that this nucleus is a bead of mother-of-pearl such as does not occur in Nature. Both these points could easily be remedied. A smaller nucleus could be introduced; or the nucleus might be removed after grafting the sac in the oyster; or a small natural pearl of inferior quality, or a concentrically crystallised bead of carbonate of lime, could be used as a nucleus. A trade in the worthless pearls of *Mytilus* might even be revived for this purpose; according to Garner they were once exported from this country to China for the manufacture of "medicine." The somewhat greater transparency, on the average, of Mikimoto pearls, when compared with natural pearls, could be remedied by either of these processes.

With regard to the question of distinguishing the Mikimoto pearl without cutting it, much vague talk as to scientific investigations has appeared in the daily Press. Some of these investigations remind me of the little boy who, having learned that trains were propelled by steam, lighted a fire in his go-cart, put a kettle on it, and expected it to run by itself. Undoubtedly experienced pearl merchants, and, indeed, any zoologist who is familiar with the shells of the different species and geographical races of pearl and mother-of-pearl oysters, can usually distinguish pearls from the Japanese pearl oyster (*Margaritifera Martensii*) from the pearls of other species, just as they can distinguish Ceylon, Australian, Central American, etc., pearls from each other by slight differences in colour and lustre; but this test only reveals that the pearls come from the Japanese pearl oyster, and cannot be used to distinguish naturally and artificially produced Japanese pearls from each other; and it would be useless for distinguishing pearls produced by the Japanese process in other species of pearl oysters from pearls naturally produced by the same species.

This natural difference is greatly intensified when the pearls are examined in ultra-violet light, for which purpose an apparatus has been designed and is already on the market. I hope shortly to be able to examine some naturally produced Japanese pearls with this apparatus. I anticipate that they will agree with the artificially produced Japanese pearls, and not with natural pearls from other localities, as this test, like the rule-of-thumb test based on the general colour and lustre,

appears to depend on the minute differences in the structure of the nacre in different species and races of pearl oysters.

Immediately on the first announcement of the presence of these pearls in the market being made, I suggested to a Press representative who called upon me that polarised light was the most hopeful line along which to seek a test that would reveal the presence of the artificial nucleus, and this suggestion was published in one of the daily papers on May 5. Immediately afterwards I got into communication with Mr. A. Brammall, of the Imperial College of Science and Technology, South Kensington, who has since been engaged upon experiments which aim at determining whether polarised light can be applied to whole pearls in such a way as to furnish a test.

The behaviour of polarised light when passed through *sections* of the natural and the Mikimoto pearl respectively was a foregone conclusion from our knowledge of the structure of their centres. When examined with polarised light between crossed Nicols, the section of a natural pearl, of course, shows throughout the cross of extinction characteristic of concentrically crystallised bodies (except in those parts which are too opaque to transmit light). A section of a Mikimoto pearl, on the other hand, shows the four arms of the cross in the outer part, which is concentrically laid down; but the mother-of-pearl bead appears alternately dark and light as the slide is rotated, according as the part of the exterior to which its laminae are parallel is in a dark or a light sector. Mr. Brammall is not yet in a position to make a definite statement as to the practicability or otherwise of applying some modification of this process to the whole pearl. He will, of course, publish his results as soon as they are completed.

However, whether or not the pearls, produced by the Mikimoto process, which are now on the market, can be distinguished from naturally produced pearls, without destroying them, by virtue of their containing a large bead of mother-of-pearl, which behaves differently towards polarised light or towards some other variety of light, Mr. Mikimoto can easily remedy this in future by a modification of his process, such, for example, as one of those suggested above. That being so, and having in view the fact that, in the appropriate localities, "Oriental," Australian, Central American, and other varieties of pearls could be produced by the same process, it is probable that, as time goes on, more and more of the pearls coming into the market will have been produced, not by the old-fashioned methods of fishing for the "wild" pearl oyster, some of which methods have existed almost unchanged from time immemorial, but by such applications of scientific knowledge to cultivated pearl oysters as that in which Japan has given so conspicuous a lead.

The Recent Magnetic and Electrical Disturbances.

By DR. C. CHREE, F.R.S.

THE recent magnetic and electrical disturbances have been remarkable for both their intensity and their persistence. Magnetic disturbance went on without any considerable interlude from shortly after 13h. (G.M.T.) on May 13 to 4h. or 5h. of May 17. This was followed by notable disturbances on May 19 and following days. There was, however, a distinctly quieter interval between May 17 and 19. Thus the storm was really less persistent than one presenting very similar features which began late on November 11, 1882, and continued practically without a break for nine or ten days.

As regards aurora, much depends on the season of the year, the age of the moon, and the amount of cloud. In the North of Scotland, the principal auroral region of the United Kingdom, twilight lasts so long in May that the chance of aurora being visible is but small. During the recent magnetic storm, aurora, if not generally brilliant, has been seen in a number of places. At Cambridge, aurora was seen to rise as high as the zenith on the night of May 13, and in the early morning of May 15 aurora was observed with a bright red colour. Aurora was also reported from London and other stations in southern England, where it is a rare event even at the equinoxes. Large earth-currents have been observed in the Post Office telegraph system at stations in England, Scotland, and Ireland.

The magnetic disturbances recorded at all the magnetic observatories have been of a quite exceptional nature. They reached a climax on the night of May 14-15. Almost all large magnetic storms show shorter-period oscillations superposed on changes having a more or less persistent direction for a considerable time. But the extent to which short-period oscillations prevail varies much in different storms. Also in many cases, while the disturbance of the horizontal components is considerable, the vertical force (*V*) shows little disturbance, and rapid oscillations of any size in that element are very rare. During the recent

disturbances the persistence and size of the short-period oscillations were remarkable, and during the night of May 14-15 this characteristic was shared by *V* to a quite exceptional extent. The magnetic storm of November, 1882, already referred to, also showed this phenomenon, so that, though rare, it is not absolutely unique. The year 1882, it may be noted, like 1921, was not characterised as a whole by abnormal sun-spot development.

The storm has received unusual attention in the newspapers. The writer of a leading article on the subject in the *Times* of May 19 has referred to the difficulty of providing the large store of energy required, seeing no alternative to the acceptance of the estimate made many years ago by Lord Kelvin other than the giving up of the principle of the conservation of energy. As the storm considered by Lord Kelvin was very trifling compared with the recent one, the conservation of energy may appear in a hopeless case. It may thus comfort the general reader to know that a recent estimate by Prof. S. Chapman gives a result which is nearly one million-million-million times less than Lord Kelvin's. When Lord Kelvin made his estimate his position resembled that of an eighteenth-century engineer consulted as to the possibility of warming London by burning coal in the Midlands. The better the engineer of that epoch, the deeper the pessimism to be expected. But the modern engineer, familiar with high-tension electrical transmission, whatever he might think of the scheme as a financial proposition, would not consider its realisation fatal to the conservation of energy.

If, as some modern theorists have suggested, atmospheric electric potential at the earth's surface should show some response to magnetic disturbance, the morning of May 15 was the time when the phenomenon should have declared itself. Unfortunately, some rain fell that morning in London, and a decisive answer to the question must be sought elsewhere.

The Recent Large Sun-spot Group.

By H. W. NEWTON, The Royal Observatory, Greenwich.

THE large sun-spot which appeared on May 8 is remarkable in several respects. The sun-spot cycle reached its maximum in 1917, and the occurrence of a large group some four years later, though by no means unique, is a matter of interest apart from its association with an intense magnetic storm. The spot group has been photographed daily at Greenwich, and reproductions of some of the photographs are given. Fig. 1 shows the disc of the sun on May 13, on which day the magnetic storm commenced. Fig. 2 illustrates

the group in detail and the considerable changes taking place in a few days. The most interesting features of the group are (a) its position exactly on the sun's equator; (b) its abnormal development; (c) its position at the time of the magnetic storm.

(a) It is a well-established fact that the change in latitude of the sun-spots is cyclical in the same eleven-year period as their frequency. Soon after the commencement of a new cycle, spots appear mainly about latitude 25° north and south of

the sun's equator. As the cycle progresses they become most numerous in successively lower latitudes, while at the present phase of the cycle they

thirteen days it could have been seen with the telescope. Its area averaged $1/15000$ th part of the sun's surface, or about eight times the area of the earth, but it was only half as large as the group of spots of March, 1920.

(b) Sun-spots are nearly always to be found in continual change, especially for a few days following their formation, and it is evident from earlier photographs that this group developed after April 25, and was, therefore, of recent origin. It was first seen at the east limb of the sun on May 8 as a long, irregular spot, nearly 80,000 miles in length, with two principal nuclei; by May 13 these had become the centres of two spots 7° apart in longitude, while the mid-portion of the original spot had changed into a cluster of small ones. It is unusual for a large spot to split up in this manner. Pairs of spots often appear, but they have generally been evolved from two small nuclei. On the photograph of May 9 it will be noticed that the spot is surrounded by bright faculae. The amount is unusually small for so large a spot, but by the time the group had reached the west limb of the sun the area of faculae had extended considerably.

(c) The magnetic storm commenced suddenly at 13h. 10m. on May 13. At this time the leading spot was $11\frac{1}{2}^\circ$ east of the sun's central meridian and the following spot 19° . The greatest intensity of the disturbance was about 5h. on

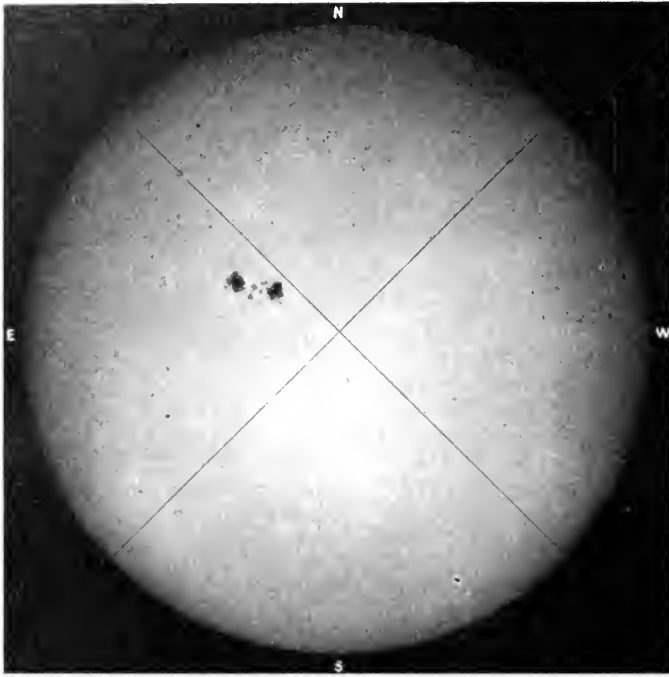

FIG. 1.—Photograph of the sun's disc on May 13d. 9h. G.M.T. Original scale $7\frac{1}{2}$ in. to sun's diameter. By kind permission of the Astronomer Royal.

are found most frequently in latitude 10° . Very large groups on the equator are rare, however, and the present one is the largest which has appeared in this position during the last half-century. Looking at Fig. 1, it is necessary to bear in mind that at the middle of May the north end of the sun's axis of rotation is about 21° west of the north point, and that the sun's equator passes $2\frac{1}{2}^\circ$ north of the centre of the disc. Spots are carried by the sun's rotation from the east to the west limb in about thirteen days. The centre of this group of spots was nearest the centre of the disc on May 14d. 16h., when it was within 3° . It was then most nearly in line with the earth, but the magnetic storm commenced twenty-seven hours earlier. The spot group was visible to the naked eye for eight out of the

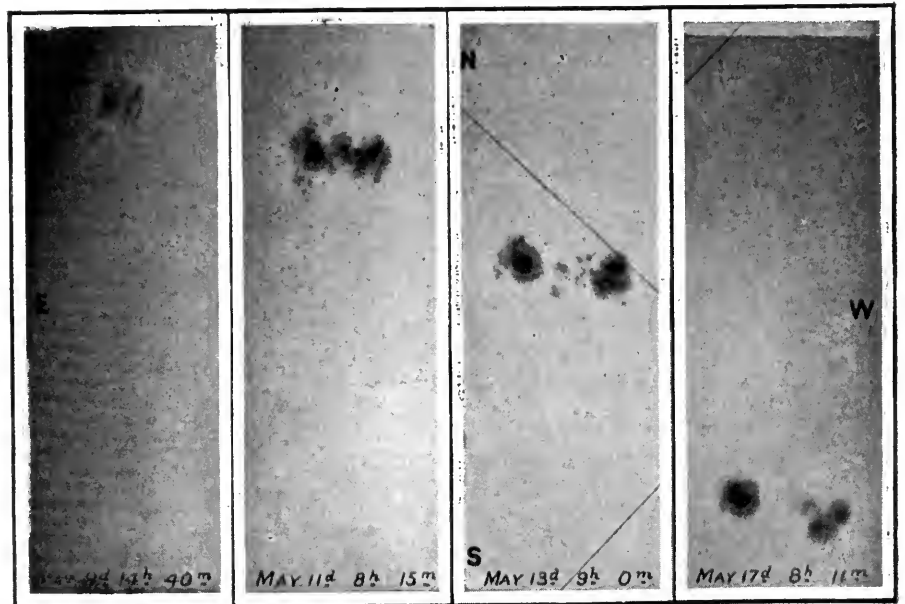

FIG. 2.—Original scale $7\frac{1}{2}$ in. to sun's diameter. Note the foreshortening of the spot near the sun's limb. By kind permission of the Astronomer Royal.

May 15, at which time the following spot was 3° past the central meridian, while a

secondary maximum followed at 8h. on May 16. It does not seem possible to associate the disturbance with one or other individual spot, but rather with the group as a whole. In this connection it is of interest to note that minor magnetic disturbances occurred on April 18 and March 21. Some years ago Mr. Maunder showed that magnetic storms tend to recur at intervals of about twenty-seven days, which corresponds to the time taken for the sun to make one rotation relative to the earth. If this sequence is continued we may expect a further disturbance on June 9, when the spot group, if still visible, will be in the same relative position on the sun's disc as on May 13, when the storm commenced.

The general relation between the diurnal variation of the earth's magnetic elements and the sun-spot cycle cannot be doubted. It is better termed the *solar* cycle, for it is well known that the solar prominences, the faculæ and flocculi, and the shape of the corona vary also with the sun-spots in the same eleven-year period. The causes,

however, of this terrestrial and solar relation are still obscure, and the magnetic storms in particular offer other difficulties on account of their anomalous occurrence, although on the whole they follow the sun-spot curve. The theory which in general seems best to fit the observed facts is that which assumes a directive stream of charged particles ejected from a restricted area of the sun, most probably in the region of a sun-spot. Opinions differ as to the exact nature of the stream and as to its action on meeting the earth. It is, of course, admitted that such a stream, though it may be a requirement, is not the sole factor in the production of a magnetic storm, the energy of which is to be traced to the earth's own magnetic system, and ultimately to the earth's rotation.

At Mount Wilson Observatory the magnetic polarities of sun-spots are now investigated daily. It will be interesting to see whether this group of spots is associated with exceptionally strong or otherwise abnormal magnetic fields.

Obituary.

DR. G. B. LONGSTAFF.

DR. G. B. LONGSTAFF died on May 7, after a long period of failing health, at his residence, Highlands, Putney Heath. Dr. Longstaff was born on February 2, 1849, and educated at Rugby and at New College, Oxford, where he obtained a scholarship and a first class in natural science. At a very early age his attention was attracted to the study of insects, mainly through the influence of his uncle by marriage, William Spence, of "Kirby and Spence's Introduction to Entomology"; and he was already recognised as one of the most energetic and successful of the younger lepidopterists of his time, when a regrettable accident in the second term of his residence at Oxford, which resulted in the loss of an eye, put an end to his activities in this direction for many years. His later career at St. Thomas's Hospital, where he was awarded the Mead medal, was highly distinguished, and in later life, besides taking an active part in philanthropic and municipal work, he represented Wandsworth on the London County Council for fourteen successive years.

Much attention also was devoted by Dr. Longstaff to the scientific aspect of statistics, and his well-known work on this subject ("Studies in Statistics") was published in 1891. His long-dormant interest in entomology was revived by a tour in India and Ceylon in the winter of 1903-4; and in later years flying visits were made by him to almost every accessible part of the world in company with his accomplished second wife (*née* Mary Jane Donald, well known as an authority on recent and fossil mollusca). The energy and acumen with which insects were collected and observed on these trips may be estimated by the

fact that Dr. Longstaff enriched the museum of his old university by at least 14,000 specimens, and the value of this generous contribution is greatly enhanced by the full and accurate data attached to every one of them.

The gratitude of all entomologists is also due to Dr. Longstaff for the finely illustrated and most pleasantly written narrative of these collecting trips which appeared in 1912 under the title of "Butterfly Hunting in Many Lands." The numerous and valuable observations on the biologies of the butterflies met with in the regions visited—their flight, resting habits, seasonal forms, mimicry, and sexual scents, to which last-named subject Dr. Longstaff devoted special attention—are embodied in the last chapter of this fine book, which is supplemented by an equally valuable series of papers on the same questions by the late Fritz Müller, here presented for the first time in English.

Dr. Longstaff was a highly appreciated member of many learned bodies, and had been vice-president of the Royal Statistical Society and of the Entomological Society of London; and the loss of his commanding presence and genial address at their meetings will long be regretted by his fellow-members, as well as by his numerous friends in private life.

WE notice with much regret the announcement in the *Times* of the death of DR. EDWARD B. ROSA on Tuesday, May 17, at the age of fifty-nine years. Dr. Rosa had been connected with the U.S. Bureau of Standards since 1901, and from 1910 onward he held the position of chief physicist at the bureau.

Notes.

At a special meeting of the Institution of Electrical Engineers, to be held on May 31, a proposal will be submitted to the members that the institution shall petition the Privy Council for a charter of incorporation. More than forty years ago, when the institution was a small and struggling society, it applied for a charter, but the application was successfully opposed by the Institution of Civil Engineers. Now that the importance of electrical engineering to the community is recognised, and the good work that the institution has done in developing electrical science and its applications is well known, there is no reason to anticipate that there will be any opposition to the grant of a charter. The only point where discussion is likely to arise is in connection with the clause which proposes to confer upon corporate members of the institution the right to use the designation "chartered electrical engineer." We take it that the object of this clause is to distinguish between an electrical engineer and a man who, having some slight technical qualification, calls himself one. We think the proposal unnecessary. The public recognises that the letters M.I.E.E. are a complete qualification.

TELEPHONIC communication has now been established between Cuba and the United States by three separate cables, each of which is more than a hundred miles in length and is submerged to a depth of 1000 fathoms. Owing to the large electrostatic capacity of submarine cables distinct speech through them would be impossible were not the circuit made inductive so as to secure the practically "distortionless circuit" first described by Oliver Heaviside. In the submarine portion of the London-Paris telephone circuit "lumped inductance" is added by inserting Pupin inductance coils at short intervals. In the Havana and Key West cables the copper core is surrounded by a continuous spiral of fine iron wire insulated by a sheathing of gutta-percha. The inductive loading is thus continuous, and so the necessary mathematical conditions can be more accurately fulfilled. Above the gutta-percha is wound a copper tape as a protection against the attacks of the teredo. Over this shield is wound a further copper tape, which forms the return half of the telephone circuit of each cable. The specifications for the cables were prepared by Sir William Slingo, formerly Engineer-in-Chief of the British Post Office, in conjunction with the Western Electric Co.

We learn from the publication, *Radium*, that Mme. Curie left France on May 7 on a visit to the United States, the main purport of her visit being to receive a gift of one gram of the element radium from the women of the United States. The gift was organised by Mrs. William Brown Meloney, the editor of the *Delineator*, and carried into effect by the Marie Curie Radium Fund Committee. From a report in the *Times* of May 21 it appears that this presentation was made to Mme. Curie at the White House, Washington, at the hands of President Harding. In an eloquent and felicitous address the

President referred to the benefits conferred upon humanity by discoveries in science. It is, as he said, given to relatively few to make great discoveries, and the recognition given to those who do so is often meagre enough. In a happy phrase he reminded his audience that "the great things achieved by great minds would never have been wrought without the inspiration to successful effort, and success in turn enables the outgiving of benefits to millions whose only contribution has been the power of their united appeal." We understand that Mme. Curie is to be the recipient of several honorary degrees on the occasion of her visit to America.

THE importance of regular meteorological reports from Greenland for the forecasting services of Western Europe, and, indeed, for that of Canada also, has been recognised for some years. The question of these reports was discussed at the meeting of the International Commission for Weather Telegraphy which was held in London in November last, and the Commission decided unanimously that "the establishment at the earliest possible date of a high-power radio-telegraphic station in Greenland is of the utmost importance to the meteorology of Western Europe, and, further, it is of such importance as to warrant the international provision of funds for maintaining it." It is probable that the provision of such a station by the Danish Government will be made at an early date. When this station has been provided it will be possible to make a definite use in weather forecasting in Europe of meteorological observations from Canada and the United States. Hitherto the gap between the European and American observations has been so great that meteorologists have been unable to justify the expense which would be involved in regular cable messages from America to England.

DR. E. J. RUSSELL, director of the Rothamsted Experimental Station, has been appointed a foreign corresponding member of the Reale Istituto Lombardo di Scienze e Lettere di Milano.

DR. F. L. GOLLA will deliver the Croonian lectures of the Royal College of Physicians on Tuesdays and Thursdays, June 9, 14, 16, and 21, at 5 o'clock, upon the subject of "The Objective Study of Neurosis."

NOTICE is given by the Institute of Physics that the first examination of candidates for the associateship of the institute will be held at the latter end of September next. Forms of application are obtainable from the Secretary, 10 Essex Street, W.C.2. Applications for entry must be received before June 15.

A PUBLIC meeting arranged by the National Union of Scientific Workers will be held in the Botanical Theatre, University College, Gower Street, on Monday next, May 30, when Prof. L. Bairstow will speak on the subject of "The Administration of Scientific Work." The chair will be taken at 8 p.m. by the Right Hon. Viscount Haldane.

THE Principal Trustees of the British Museum have appointed Dr. W. T. Calman to be deputy keeper in the department of zoology. Dr. Calman, who

graduated as a Doctor of Science at St. Andrews University, has been in charge of the Crustacea at the Natural History Museum since 1904, and is the author of "The Life of Crustacea" and of numerous articles on this group.

A MEETING on the subject of "Constructive Birth Control: Its Ideals and Helpfulness to the Individual and to the Race" will be held at Queen's Hall on Tuesday next, May 31. The chair will be taken at 8.30 by the Right Hon. G. H. Roberts, and among the speakers will be Dr. Jane L. Hawthorne, Dr. C. Killick Millard, the Right Hon. J. M. Robertson, Admiral Sir Percy Scott, and Dr. Marie Stopes.

THE Ottawa Field-Naturalists' Club has decided to open a subscription list for a permanent memorial to the late Prof. John Macoun, naturalist of the Geological Survey of Canada, who died at Sidney, British Columbia, on July 18, 1920. The wide field of work to which Prof. Macoun devoted his life is known to many naturalists. He specialised particularly in botany, and was the founder of the Canadian National Herbarium. Other sciences, however, especially zoology, were also greatly enriched by him. He will be remembered as the great pioneer in Canadian natural history. The memorial will take the form of a portrait to be hung in the Victoria Memorial Museum, which will be executed by Mr. Franklin Brownell, of Ottawa. The expenses in connection therewith will be about 700 dollars, and subscriptions, which should be forwarded to Mr. Arthur Gibson, Dominion Entomologist, Ottawa, are invited.

THE third meeting of the Council of Agriculture for England, constituted by the Ministry of Agriculture and Fisheries Act, 1919, will be held at the Middlesex Guildhall, Westminster, S.W., on Friday, May 27. The proceedings will begin at 11 a.m. and will be open to the public. The Earl of Selborne, K.G., will be in the chair. The purpose of the council is to provide an opportunity for the discussion of matters of public interest relating to agriculture and other rural industries by persons representing the various interests of the industry from all parts of the country. Several interesting resolutions will be considered, among which may be mentioned two to be moved by Sir Douglas Newton, dealing with the facilities of railway goods stations for the rapid transit of soft fruit and other perishable produce. The question is especially difficult at the present time, when railway services have to be curtailed.

IN connection with the presentation on June 29 of the John Fritz medal to Sir Robert Hadfield, which was announced in NATURE of May 5, it may be of interest to record the events which led to the institution of this medal. In 1902 a number of friends and associates of John Fritz, the American engineer who brought about great changes in the iron and steel industry in the United States, decided to celebrate his eightieth birthday by establishing a fund, the income from which should be used to strike annually a John Fritz medal for scientific and industrial achievement in any field of pure or applied science. A committee consisting of representatives of the American Societies

of Civil and Mechanical Engineers and the American Institutes of Mining and Electrical Engineers was appointed, and an impression of an appropriate design was presented to John Fritz at a great dinner given in the Waldorf Hotel, New York. After the die had been completed the committee continued in existence as the John Fritz Medal Fund Corporation. One member of each of the societies instrumental in founding the fund is now elected annually to serve on the committee for a period of four years; the members of the committee also act as a board of award. The medal, which is of gold, is awarded annually, without restriction on account of nationality or sex, and it is accompanied by a diploma reciting the origin of the medal and the specific achievement for which the award is made. The first award, in 1902,* was made to John Fritz, and the second, in 1905, to Lord Kelvin, "for work in cable telegraphy and other general scientific achievements." Since then an award has been made every year with the exception of 1913, and the list of recipients contains such well-known names as George Westinghouse, Dr. Alexander Bell, Thomas A. Edison, Sir William H. White, and Elihu Thomson.

THE second issue, that for April, of the *Antiquaries' Journal*, the journal of the Society of Antiquaries of London, is fully up to the level of the first number, and the publication marks a distinct advance in the popularisation of the science of archæology. Mr. A. Leslie Armstrong announces the discovery of engravings found at Grime's Graves, Norfolk, on flints associated with a series of flint implements of Le Moustier type, bone tools, and pottery, on a level immediately overlying glacial land. One is a naturalistic representation on flint-crust of a stag or perhaps an elk. The authorities at the Natural History Museum regard this animal as an elk, known in America as "moose." In the discussion which followed, the president suggested that the art of the engravings seemed to be of the same character as the French cave series, though he would not say the resemblance was conclusive. "In recent years discoveries at Grime's Graves, Northfleet, and elsewhere had reduced the sequence of prehistoric periods to a state of flux. If type, material, and coloration, singly or collectively, meant nothing at all, the whole structure of prehistoric study was undermined. In any case, the Grime's Graves industry did not seem to belong to the ordinary Neolithic period."

IN the April issue of *Man* Sir Ray Lankester describes, with illustrations, a remarkable flint implement found lying on the surface of a field within ten yards of the gravel-pit in which the jawbone of *Eoanthropus* was discovered in 1912. He proposes to call this specimen "the Piltdown batiform," and he expresses the hope that it may be placed with the other Piltdown flints in the Geological Department of the British Museum. He thus sums up the question:—"In my opinion the facts hitherto ascertained do not justify the identification of the period at which *Eoanthropus* lived with the period at which any of the flint implements discovered in the Piltdown gravel were fashioned, nor do we know enough

to make the assertion that implements of Mousterian or Acheulæan or Chellæan or pre-Chellæan workmanship were *not* manufactured or in use when *Eoanthropus* flourished. Assuredly we are not in a position to assume either that *Eoanthropus* manufactured flint implements, or, on the other hand, that he did not do so. To me it seems improbable that *Eoanthropus* had anything to do with flint implements at all, although more likely that he suffered from them rather than that he benefited by their use."

In an article on the conditions of cellular immortality (*Sci. Monthly*, vol. xii., No. 4, p. 321) Prof. Raymond Pearl discusses artificial parthenogenesis and tissue culture and the views regarding senescence to which they lead. The life of the unfertilised egg-cell can be prolonged only by fertilisation or by some other stimulus to development. The experiments of Leo Loeb, Harrison, Burrows, Carrel, and others in the culture not only of embryonic, but also of adult, tissues *in vitro* show that the phenomena of senescence do not originate in the cells themselves; for all the essential body-tissues, including heart-muscle, nerve-cells, spleen, connective tissue, and kidney-cells, have been shown to be capable of multiplication indefinitely by mitotic division outside the body. With improved methods Carrel has kept a strain of connective tissue from the chick's heart alive and growing for nine years. There is, therefore, a potential immortality not only of germ-cells, but also of tissue-cells, and senescence is a phenomenon of the differentiated body as a whole, due to the effects of the various types of cells upon each other.

In the Journal of the Quekett Microscopical Club (vol. xiv., November, 1920) Mr. G. T. Harris describes the Desmid flora of a small area in East Devon, and compares it with that of Dartmoor in order to elucidate the influence of geological beds on the species density of the Desmid flora. Dartmoor is a Palæozoic, semi-mountainous area of extensive peat deposits, great rainfall, and deep bogs; the other, a Triassic, lowland area, with no peat-bogs, moderate rainfall, and unimportant bogs. The numerical results from each area were surprisingly similar, indicating that the factors influencing the richness or poverty of Desmid floras must be sought elsewhere than in the geological beds upon which the habitats stand; and a recent investigation of the Desmid flora of a district on Eocene beds confirms this statement. The species density of the two districts is also practically the same. A systematic list of the species and varieties from the Triassic area, 429 in number, is given. This adds 122 forms to the Desmid flora of Devonshire, bringing it up to a total of about 500 species and varieties. From gatherings made during the winter it would appear that most species in a southern county like Devon pass the winter in the vegetative state.

THE Forestry Commission in a recent report states that up to April it had acquired for planting 97,160 acres of land, of which 36,682 acres are in England and Wales, 54,972 acres in Scotland, and 5,506 acres in Ireland. The area of 1,586 acres

planted under favourable conditions in 1919-20 continues to show satisfactory growth. During the 1920-21 season 6257 acres were planted at seventeen centres in England and Wales, nine centres in Scotland, and twelve centres in Ireland, while new nurseries have been established in various parts of the country. The Commission has published a report of the British Empire Forestry Conference held in London last July, which can be obtained through any bookseller or from H.M. Stationery Office (7s. 6d.). Leaflets on forest pests—No. 2, *Chermes Cooleyi*; No. 3, The Pine Shoot Beetle; and No. 4, *Hylastes ater*—can be obtained free on application to the Commission at 22 Grosvenor Gardens, London, S.W.1.

THE disposal of the débris from hydraulic mining and its influence on the lower courses of rivers have been urgent problems in California for the last half-century. A monograph on the subject by the late Dr. G. K. Gilbert is published by the United States Geological Survey entitled "Hydraulic Mining Débris in the Sierra Nevada" (Professional Paper 105). The material washed from the hillsides is carried by the creeks and rivers, and eventually finds lodgment in the lower reaches of the streams and during floods on the riparian lands, thus doing a considerable amount of harm to navigation and agriculture. For these reasons hydraulic mining has been severely restricted for many years. The bays of the San Francisco system have been sounded and mapped more than once, and comparisons made between early and recent maps show that the areas of the bays have been much reduced by the seaward growth of muddy shoals. Since the discovery of gold and the beginning of hydraulic mining more than 1,000,000,000 cubic yards of material have been deposited in the various bays. Dr. Gilbert made careful researches on the effect of this shoaling and diminution of area on the tidal currents and depths of water on the Golden Gate bar. The crest of the bar shows a retreat towards the land, but no reduction in depth since 1855, and the navigability of the bar has apparently not yet been affected.

In the Journal of the Franklin Institute for April Mr. A. H. Armstrong considers the economic aspects of railway electrification in the United States. He points out that at the present time we are facing the facts of an eight-hour working day with overtime costing 50 per cent. more, greatly increased wages, fuel prices at levels never before reached, and maintenance costs at almost prohibitive values. With no immediate prospect in sight of any material reduction in the price of labour, its output must be increased, and electric operation effects this both on the railway line and in the workshop. The electrification of railways is a very costly operation, but the saving in operating expenses enables a reasonable return to be obtained on the capital expended. The argument for electrification, however, rests on a broader foundation than this. The national prosperity of America is bound up with the future growth of its transport system, and this growth depends on the adoption of electrification. An incidental advantage of electrification is that it would save one-sixth of all the coal mined in the United States.

THE fourth annual general meeting of the Society of Glass Technology was held at University College, London, on April 20, when Dr. Morris W. Travers was elected president in succession to Mr. S. N. Jenkinson. The new president delivered an address on the importance of quantitative investigation in dealing with technical glass problems. The speaker directed attention to the fact that the late Lord Moulton, who was to have presided at the society's dinner that evening, had brought about a great improvement in the efficiency of explosives factories by applying quantitative investigation to the processes conducted in them. The energy balance-sheet of a factory was as important as its financial balance-sheet, and the efficiency of a furnace, for instance, should be accurately known so that a full account could be given of all heat which entered it. This principle was illustrated by application to several furnace problems. There was also a wide field for investigations bearing on the nature of glass, and recent work had shown that glass in the solid condition resembled the elastic gels rather than the liquids. A paper on automatic glass-feeding devices was communicated by Messrs. G. Dowse and E. Meigh, and the society's third annual dinner followed. During

the course of the evening the president referred to the proposed legislation affecting the industry, and maintained that the total prohibition of the importation of all chemical glassware except under licence was essential to that branch of the industry. Electric lamp bulbs should also have been included in the Bill. Assistance would be necessary if the manufacture of these articles were to be continued in this country.

MESSRS. G. E. STECHERT AND CO., 151 West 25th Street, New York (London: 2 Star Yard, Carey Street, W.C.2), have sent us a copy of their catalogue (New Series, xl.) of second-hand books relating to natural history. It contains some hundreds of titles, and is classified as follows:—General Natural Science; Agriculture, Forestry, Farming; Botany; Zoology; Ornithology; Ichthyology; Entomology; Gardening; and Supplement. The prices asked (in American dollars) appear to be very moderate.

AN interesting little catalogue (No. 414) of nearly four hundred works (books and engravings) on the topography of Kent and Sussex has just been issued by Mr. F. Edwards, 83 High Street, Marylebone, W.1. It will doubtless appeal to residents in the two counties named and to many others.

Our Astronomical Column.

COMETS.—It appears that Dubiago's comet was discovered by him at Kasan on April 24, and observed at Pulkovo a few days later. It has now been observed in England by Dr. Steavenson, whose observations enable the orbit to be improved. This has already been done approximately with the following result:—

T 1921 May 7.177 G.M.T., ω 100° 13', Ω 65° 58', i 22° 20', $\log q$ 0.0481.

Ephemeris for Greenwich Midnight.

		R.A.	N. Decl.	Log r	Log Δ
		h. m. s.	'		
May	28	9 38 57	35 52	0.0680	0.0172
June	1	10 0 27	33 18	0.0756	0.0179
	5	10 20 55	30 30	0.0840	0.0203
	9	10 40 22	27 32	0.0933	0.0250
	13	10 58 42	24 27	0.1032	0.0318
	17	11 16 3	21 20	0.1137	0.0406

Its total light is probably equal to a 9th magnitude star; it should be readily visible in an ordinary telescope in the absence of the moon.

The errors of the ephemeris of comet Pons-Winnecke have become so large that it is well to give the revised orbit lately received from Prof. Crawford and Miss Levy, with the ephemeris, for Greenwich midnight, deduced from it.

T 1921 June 12.95 G.M.T., ω 170° 34', Ω 97° 51', i 18° 50', $\log q$ 0.01703, e 0.6779, period (assumed) 5.8 years.

		R.A.	Decl.	Log r	Log Δ
		h. m. s.	'		
May	27	19 35 27	43 16 N.	0.0272	9.2698
	31	20 16 47	39 36	0.0230	9.2226
June	4	21 0 39	33 52	0.0108	9.1818
	8	21 44 21	26 4	0.0178	9.1537
	12	22 24 42	16 37	0.0170	9.1446
	16	23 0 20	6 50 N.	0.0175	9.1572
	20	23 31 5	2 14 S.	0.0192	9.1881
	24	23 56 42	9 55 S.	0.0221	9.2295

After this the comet will travel south rapidly; it should NO. 269I, VOL. 107]

be observable in the southern hemisphere until September.

THEORY OF JUPITER'S SATELLITES.—Prof. Sampson's tables of Jupiter's satellites have been in use in the national ephemerides for several years, but the theory on which they were based has only just appeared in print, being vol. lxiii. of *Memoirs of the Royal Astronomical Society*. The author commences with a review of the work of Laplace, Delambre, Damoiseau, and Souillart; he explains that the discordances that still exist between the tables and observation are due to the fact that in deducing the fundamental elements with the aid of the older theories it was assumed that only the leading terms of these would be involved. It was discovered (too late to alter the tables) that some secondary terms in the older theories were so seriously wrong that the tables are sensibly affected. One such error may affect the time of an eclipse of Satellite IV. by 140s.

The elements at the present day were derived chiefly from the Harvard photometric observations of eclipses. These permit of the deduction of an exceedingly accurate value of the equatorial semi-diameter of Jupiter; the mean of the Harvard and Durham discussions is 18.927".

The adopted value of Jupiter's mass is 1/1047.35, but it is noted that a discussion of recent measures and photographs in conjunction with the theory leads to the value 1/1047.0. It would, however, be rash to alter the accepted value, which rests largely on the perturbations of minor planets and the comet Pons-Winnecke.

One advantage of the delay in publishing the theory is that it has enabled a list to be given of the errata and omissions that have been detected. One such was found soon after the tables were printed, and a supplementary page was issued.

Mr. Innes directed attention to two omitted terms; one, due to the effect of the sun on Satellite IV., has a coefficient of 7.6". The other is a long-period term; period for III. 26½ years, coefficient about 6". The values for IV. are not very different.

An Early Chellean Palæolithic Workshop-site at Cromer.

AT a meeting of the Royal Anthropological Institute held in the rooms of the Royal Society, Burlington House, on May 3, Mr. Reid Moir exhibited a large collection of ochreous flint implements, cores, and flakes recovered upon a limited area of foreshore exposed at low water at Cromer, Norfolk. These specimens are remarkable not only for their brilliant and arresting ochreous coloration, but also because of the large and massive size of many of the artefacts. Many of them are evidently fashioned for comfortable prehension, but it is clear that the hands of the ancient Cromerian people must have been much larger than those of modern man. Several examples of Early Chellean implements, with coarse flaking upon the upper and lower surfaces, have been found at the Cromer site, associated with rostro-carinates, choppers, scrapers, points, partly finished specimens, cores, and flakes.

It is evident that an actual workshop-site of Early Chellean age is represented at Cromer, and from its position appears to be referable to the lowermost stratum of the Cromer Forest Bed series of deposits. The Cromer Forest Bed strata are generally regarded as of Upper Pliocene age, and it seems, therefore, that the earliest Chellean implements—such as are usually found in river-terrace gravels—must in East Anglia be regarded as of Pliocene date. It is of interest to note that the massive human fossil jawbone found at Heidelberg, in Germany, was supposed to be of about the same antiquity as the Cromer Forest Bed. The individual represented by this jawbone would appear to have been of almost gorilla-like size and strength, and it may be that the massive Cromer implements which have been found were made by people of the Heidelberg type.

An animated discussion followed the reading of the paper. Prof. Arthur Keith, past-president, who was in the chair, said that while it would be impertinent for him to attempt to criticise Mr. Reid Moir's communication, he considered it of outstanding importance in the study of the antiquity of man in this country. This site would appear to be the most ancient workshop-floor which had yet been discovered.

Sir William Boyd Dawkins said that no geological evidence had been brought forward for the relation of the flints on this site with the Forest Bed series; they were no more than a foreshore accumulation of flints which differed in no way from other flints found on the foreshore along the whole East and South Coast. Further, it was assumed that the Forest Bed fauna was Pliocene; but it had been shown more than forty years ago that the Forest Bed series included recent mammalia absent from the Pliocene deposits of France and Italy, and, therefore, they should be regarded as Early Pleistocene.

Sir E. Ray Lankester said that the use of the terms "Pliocene" and "Pleistocene" was purely arbitrary, and did not affect the facts. These specimens were quite unlike foreshore flints in their large size, their flaking, and their coloration. Mr. S. Hazzledine Warren denied that any evidence had been brought forward in support of the very definite assertion of date, and it was his opinion that if a boring were made at the base of the cliff, as had been suggested, nothing similar to the conditions on the foreshore would be found at the base of the Forest Bed series. Mr. Haward considered the site represented merely an outcrop of one of the zones of flints which are found sloping down to the sea in the neighbouring cliffs. Mr. Barnes said that the case was not made out. The number of implements was small, while a flake afforded little as a criterion of human manufacture. It was essential that a boring should be made at the base of the cliff. Mr. Reginald Smith, on the other hand, maintained that Mr. Reid Moir had made out a *prima-facie* case; it was only the question of provenance which gave rise to doubt. In referring to the disproportionate number of flakes on the site, he mentioned one of the floors investigated at Swanscombe, on which no implements, but only a large number of flakes, had been found.

The series of humanly fashioned flints collected by Mr. Reid Moir is to remain on exhibit for one month in the rooms of the Royal Society, Burlington House, where the specimens can be seen and examined by those interested.

Hydrology of the Western States of North America.¹

By DR. BRYSSON CUNNINGHAM.

THREE Water Supply Papers, prepared under the direction of the United States Geological Survey, contain features of interest respecting the natural conditions which prevail in the undeveloped territory between the 108th and 118th meridians of west longitude.

(1) A sequence of devastating floods which swept the counties of southern California in January, 1916, is described in Water Supply Paper No. 426, with records of the precipitation, run-off, and attendant phenomena. The rainfall was heaviest and its effects most disastrous in San Diego County, which for nearly a month after the storm was cut off from communication with the rest of the State. The mean precipitation for the period January 14-30, in different parts of the county, ranged from 20 in. to 30 in.

The normal annual rainfall at San Diego is in the neighbourhood of 10-15 in. As a result of the downpour the Lower Otay Dam, forming part of the reservoir system for the city of San Diego, was swept away and the Sweetwater Reservoir developed serious fractures. Twenty-two lives were lost in the flood from the former reservoir. A huge wall of water, variously described as from 6 ft. to 20 ft. in height, rushed down the valley, covering the distance from the dam-site to Palm City (about ten miles) in forty-eight minutes, and carrying everything before it. An impressive idea of the devastated area is obtained from the photographs which illustrate the report. There is also a large-scale map of the district.

(2) Upon the borders of the States of Utah, New Mexico, and Arizona lies an area of reservation, known as the Navajo Country, set aside for indigenous Indian tribes. It is a region of which very little hitherto has been known, and it remains more or less in a primitive condition. The area is considerable, about 25,725 square miles; it is the most exten-

¹(1) "Southern California Floods of January, 1916." By H. D. McGlashan and F. C. Ebert. Water Supply Paper No. 426. (2) "The Navajo Country." By Herbert E. Gregory. Water Supply Paper No. 380. (3) "Geology and Water Resources of Big Smoky, Clayton, and Alkali Spring Valleys, Nevada." By Oscar F. Meinzer. Water Supply Paper No. 423. (Washington: Government Printing Office 1917.)

sive tract of undeveloped reservation land within the United States. This area forms the subject of a geographical and hydrographical reconnaissance by Mr. Gregory, whose report is embodied in Water Supply Paper No. 380.

The exploration of a little-known region has considerable attractions for the adventurous, and Mr. Gregory in a personal introductory note confesses to its powerful appeal. The Navajo country, he points out, contains the remnants of an almost extinct race whose long occupation of the district is recorded in ruined dwellings and abandoned fields. It is true that roads have been established along selected routes, but by far the larger portion of the territory is accessible only by trails, and in the rougher areas no recognizable tracks are to be found.

The country contains many extremely interesting features, topographical, geological, and hydrographical. The 200 pages of the report are replete with valuable notes on the natural resources of the district, and indicate a careful and painstaking investigation. Topographically, the country forms part of the Colorado plateau, a region of flat-lying or slightly tilted rocks, cut by cañons and surmounted by mesas and buttes. "So numerous and so closely interlaced are the cañons in some portions of this singular region that they have displaced all but scattered remnants of the original plateau, leaving narrow walls, isolated ridges, and spires so slender that they seem to totter on their bases, shooting up to an enormous height from the vaults below."

The most inaccessible, least known, and roughest portion of the reservation is a region of bare red

sandstone rock forming a plateau, known as the Rainbow Plateau, intersected by innumerable cañons, some of which are bridged by natural arches. One of them is a symmetrical semi-circular curve with a span of 274 ft. It gives its name of "The Rainbow" to the plateau.

The Navajo Indian is given a fairly good character; he is vigorous, intelligent, and capable of hard work provided it be not too continuous. He is, however, independent towards those who engage his services, and liable to take himself off. "He will help himself to interesting trinkets and to food, but may be trusted with valuable things and with important missions."

The report is well illustrated by photographs and maps.

(3) Big Smoky Valley, the subject of Water Supply Paper No. 423, is a typical Nevada desert valley—a plain hemmed in by mountain ranges and underlain by porous rock-waste eroded therefrom. It once contained two large lakes, one 40 miles long and 9 miles in maximum width in the upper part of the valley, and the other about 22 miles long by $5\frac{1}{2}$ miles wide in the lower part. The depth of the former ranged to as much as 170 ft., and of the latter to 70 ft. The existence of these lakes is deduced from shore features which are still in existence. The climate is distinctly characteristic of an arid tract, the annual rainfall being generally about 6 in. or 7 in., or even less. The valley is but sparsely populated, and the settlers are principally engaged in mining or milling. The report contains maps, diagrams, and photographs.

The Plaice Fishery in the Belt Sea and Neighbouring Waters.¹

THE sea-fisheries of Great Britain, though perhaps of less importance to the prosperity of the country than the supply of coal, are nevertheless of vital interest in more ways than one. Consequently, anything bearing on the problems connected with them, especially as to their permanence, ought to awaken interest in all who have practically studied this intricate subject, as well as to arrest the attention of the legislators and the public. Few nations have done more in proportion to their populations than the Danes in unravelling various problems of the sea-fisheries, and were it only for the single case of the remarkable life-history of the eel as elucidated by Dr. Johs. Schmidt, their labours merit careful attention as well as commendation.

The Report of the Danish Biological Station for 1920, by the experienced expert Dr. Petersen, who is well known in fisheries researches and for transplanting so successfully the plaice into the Limfjord, discloses a new feature in the plaice-fishery of the Belt Sea and neighbouring waters. No fish in the North Sea, indeed, has given more solicitude to scientific investigators and the fishing industry than the plaice, which, after the twenty years' labours of the International Fisheries Council, was singled out as the only form requiring legislation. Dr. Petersen, the author of the Danish report, hitherto has held the belief that it was possible to produce impoverishment of certain areas by over-fishing, though at the Dundee meeting of the British Association in 1912, when "impoverishment" was challenged, he declined to give an opinion, nor did anyone present support it. Dr. Petersen, indeed, had in former years pointed out

the decline of a Danish plaice-fishery, but, as Dr. H. M. Kyle afterwards proved, that was a misapprehension. Now in this report of 1920 we have the remarkable admission that the intensive plaice-fishing, first by gill-nets and then by seines with otter-boards (which increased greatly from 1912 to 1919) worked from motor-boats in the Belt Sea and neighbourhood, has resulted, not in the impoverishment of the area, but in the more rapid growth of the plaice of to-day. The plaice now fished are younger, larger, and better fishes than formerly, though they are fewer on a given hectare, but the yearly yield is larger. Further, in the words of Dr. Petersen, "the plaice got formerly we did not care to eat . . . now we regard them as delicacies."

Dr. Petersen supports his views by the Fiskerei-Beretnings statistics for twenty years, which show that this intensive fishery has had the effect of increasing the weight of plaice from an average of 5 kg. per score to 10 kg. per score. The original dense old stock has been fished out, and a new, quick-growing race, fewer in number per hectare, has fortunately appeared. "It is like a lawn which is cut many times a year in lieu of once every second year; the latter method produces old, bad grass only, the former gives much more and better grass, but calls for much more work." Instead of 500 tons before 1900, the fishery of the area now produces 1000 tons; indeed, in 1912, 1913, and 1919 the yield was about 3000 tons, and valued at 3,000,000 kroner.

In 1900 the fishing in the Great Belt at 22 m. produced many undersized plaice amongst the larger forms of 40 cm., and there was a majority of males. In 1920 there were few undersized forms, and generally they were larger and heavier than before, the larger being similar to the larger in 1900, and

¹ "On the Stock of Plaice in Relation to the Intensive Fishing of the Present Times in the Belt Sea and other Waters." Report of the Danish Biological Station to the Danish Board of Agriculture, xxviii., 1920. By Dr. C. G. J. Petersen. (Copenhagen: G. E. C. Gad, 1921.)

the females were in the majority. The three- and four-year-olds were on an average larger than the old plaice of former times, the latter being slow-growing and consuming the available food without much increase in bulk. Thus the intensive fishing had improved the growth of the plaice in the area. Further, in the small waters of the Belt the young plaice have but a short distance to travel to reach places where rapid growth occurs, whereas in the Kattegat and the North Sea it is otherwise. In these deep basins of the Belt, moreover, gill-net fishing south of Faaborg has hindered over-population. The food of the plaice in the area consists largely of *Macoma baltica*, *Abra alba*, and the annelid *Nephtys*.

Dr. Petersen anticipates that similar results to the foregoing in larger areas might be attained by transplanting, and he would recommend prohibition against landing plaice in the spawning season. He places much weight on the supply of food for the plaice,

old and young, for he thinks this is variable and possibly deficient; but it has long been demonstrated that the supply of food on the bottom, in mid-water, and near the surface is everywhere both persistent and ample, and no effort of man can, as a rule, modify it beyond low water. The contrast between the sea and the fresh-waters in this respect is often misunderstood. Taking a broad view of Dr. Petersen's observations, and without placing undue weight on the effects of intensive fishing in the Belt Sea, they simply bear out the marvellous ways of Nature in the ocean, especially in connection with the food-fishes, the recuperative powers of which are independent of artificial interference. Some may clasp and nurse the phantom of "impoverishment" of this or that place (seldom located), but Nature, unheeding, quietly answers by her annual swarms of young and by the rich and perennial harvest of food-fishes which everywhere rewards industrial energy. W. C. M.

The Melbourne Meeting of the Australasian Association.

I.

IT was arranged that the fifteenth meeting of the Australasian Association for the Advancement of Science should be held at Hobart on January 5-11 last, when, on December 18, passenger communication with Tasmania was cut off by a strike, and eventually it was decided to hold the meeting at Melbourne. By this unavoidable decision a grave disappointment was inflicted on the Tasmanian executive, who had worked for months at the organisation of the meeting, and also on Australians who desired to combine a holiday with participation in the science congress. Further, it meant that a great strain was placed upon the Melbourne officials, who had to arrange local details at short notice after a particularly strenuous time during midsummer. Nevertheless the meeting was one of the most successful ever held, and members have especial reason to be grateful to the president of the association (Sir Baldwin Spencer) and to the local secretary (Dr. Georgina Sweet), who, at the head of a band of devoted assistants, worked early and late and thus secured the fine results obtained.

A feature of the meeting was the number and importance of the sectional and intersectional discussions, many of the papers being taken as read in order to afford an opportunity for the interchange of ideas on subjects which are of special importance to the Commonwealth.

During the transaction of business it was decided that the invitation of the New Zealand Institute to hold the next meeting in January, 1923, at Wellington, New Zealand, should be accepted. It was also resolved that meetings in New South Wales, Victoria, or Tasmania shall in future alternate generally with those in the more remote States.

The permanent honorary secretary, Mr. J. H. Maiden, asked to be relieved of the duties of his office as from December 31, 1921, and on the motion of the president a resolution was unanimously carried recording the council's deep appreciation of Mr. Maiden's valuable services to science and to the association during the past fourteen years.

The council made a formal offer of the presidency for the Wellington meeting to Mr. J. H. Maiden, who gratefully acknowledged the compliment, but asked to be excused acceptance of the honour. The name of Mr. G. H. Knibbs, Commonwealth Statistician, vice-president, was then submitted, and he was unanimously elected. Mr. Knibbs has rendered the

association invaluable service during a long period of years. Mr. E. C. Andrews, Government Geologist of New South Wales, was unanimously elected to the office of permanent honorary secretary as from January 1, 1922.

The council recorded its deep sense of the value of the experimental work in aeronautics of the late Laurence Hargrave, which has led to such remarkable results in the evolution of aviation, and proved of such immense importance during the recent war.

Mueller Memorial Medals.—It was decided to award two medals, as follows:—(1) Mr. R. T. Baker, curator of the Technological Museum, Sydney, in acknowledgment of his eminent services to botany, particularly in regard to Eucalyptus; and (2) Prof. C. Chilton, professor of biology, Christchurch, New Zealand, in acknowledgment of his eminent services to zoology, particularly in regard to the crustacea.

Australian National Research Council.—In 1919 Australia was invited to take part in the formation of an International Research Council. Two representatives of various branches of science were appointed to form a provisional committee, and it was decided to refer the matter of the constitution of the permanent body to the council of the association at the Hobart (Melbourne) meeting. A sub-committee of the latter was appointed to draw up a scheme, which was adopted by the council. It provides that a National Research Council for Australia shall be instituted, consisting of not more than one hundred members, representative of the following branches of science: (1) agriculture; (2) anthropology; (3) astronomy; (4) botany; (5) chemistry; (6) economics and statistics; (7) engineering; (8) geography; (9) geology; (10) mathematics; (11) mental science and education; (12) metallurgy; (13) meteorology; (14) pathology; (15) physics; (16) physiology; (17) veterinary science; (18) zoology. The present provisional council is to meet in Sydney in May of this year to co-opt additional members, and the council so constituted will meet as soon afterwards as is possible. It is empowered to appoint (a) such office-bearers as it may determine; (b) such standing and special committees as it may deem necessary for national or international purposes; and (c) a number of associate members chosen from among the scientific workers in Australia who are deemed likely to confer benefit by their researches. The council will submit a full report of its work and proceedings to the Australian Association for the Advancement of Science at

each meeting of the latter. Until other arrangements are made for the upkeep of the council each member thereof will contribute the sum of two guineas per annum, and each associate member one guinea.

Resolutions of the General Council.

Section A (*Astronomy, Mathematics, and Physics*).—“That as regards the following committees: Solar Physics, Seismology, Terrestrial Magnetism, Tidal Survey, Physical and Chemical Constants, and Longitude—since their methods of working involve international co-operation, these committees should be allowed to lapse, and that the responsibility for carrying on these researches be transferred to the Australian National Research Council.”

“That the sum of 50*l.* referred to in the report of the secretary of the Physical and Chemical Constants Committee be approved, and forwarded to Dr. Marie.”

Macquarie Island Committee (Sir T. W. Edgeworth David, secretary).—The report was adopted, and the names of Sir Baldwin Spencer, Sir Douglas Mawson, and Capt. J. K. Davis were added to it. The question of re-opening the wireless station at Macquarie Island established there originally by the Australasian Antarctic Expedition under Sir Douglas Mawson with the co-operation of the Commonwealth Meteorological Office has given rise to some difference of opinion, and the meteorologists now give precedence to the establishment of stations at Kerguelen or the Island of St. Paul. The question of re-establishing the wireless station on Macquarie Island must therefore be for the present postponed. The question of creating a zoological and botanical preserve at Macquarie Island is considered to be worthy of favourable consideration.

Committee for the Study of Earth Movements by Horizontal Pendulums (formerly the Committee for Determination of Gravity in Certain Critical Localities).—A preliminary account of the installation and working of the pendulums at Burrinjuck was read before the Royal Society of New South Wales (Journ. Roy. Soc. N.S.W., 1915). The observations have been systematically carried out by Mr. A. Goodwin since the pendulums were first established. Dr. L. A. Cotton, of the University of Sydney, furnished a report; the examination of the records since the preliminary account already referred to has served to explain in large measure the movement which was then regarded as being secular in character. It now appears that the movement is chiefly, if not wholly, seasonal in character and a function of the underground temperature. It is, of course, essential for this work, as well as for the main investigation, to have a detailed geological and topographical survey of the area. This work was taken up about two years ago, and, though far from completion, has yielded important information with regard to the lithographical characters and rock structures of the area under investigation. The general council voted the sum of 105*l.*, already expended in anticipation, together with 50*l.* for the future work of this committee.

The Samoan Observatory at Apia.—The observatory was founded by the Germans in 1902, and is described in the *New Zealand Journal of Science and Technology* (vol. iii., p. 157, 1920) by Dr. C. E. Adams and Prof. Marsden. It is considered most desirable that it should be maintained at pre-war efficiency, and that the cost of it be contributed to by Great Britain, New Zealand, and Australia. A resolution was passed urging upon the Federal and State Governments the importance of the work of the observatory in Samoa and the desirability of contributing 100*l.* per annum

as the Australian share of the cost of upkeep of this institution as an Imperial observatory.

Section C (*Geology and Mineralogy*).—It was decided to form a committee for the classification and correlation of the Carboniferous and Permian rocks of Australia in the place of a committee bearing the name “Permo-Carboniferous of Australia,” and another committee, under the title “For the Investigation of the Structural Features and Land Forms in Australasia,” to supersede the two committees on “Structural Features in Australasia” and “Physiographic Features of Australasia.” The Glacial Phenomena Committee was re-appointed, with Sir Edgeworth David as secretary. The report of the committee was adopted. It consisted chiefly of observations by Mr. Loftus Hills, Government Geologist of Tasmania, on Glacial cirques and moraines in Tasmania, together with “Glacial Notes from New Zealand” by Mr. R. Speight, and brief remarks concerning South Australia by Prof. W. Howchin.

The Kainozoic and Quaternary Climate of Australasia Committee was re-appointed, with Mr. R. Speight as secretary. The Alkaline Rocks of Australasia Committee was also re-appointed, with Prof. E. Skeats and Dr. H. C. Richards as secretaries, and the sum of 50*l.* was voted for expenses.

A report was submitted by Prof. E. Skeats, which embodies references to the work of Prof. H. C. Richards in south-eastern Queensland, and recorded by him in the Journ. Roy. Soc. Queensland (vols. xxvii. and xxx.). As regards Tasmania, Prof. Skeats has supplied a note on the age of the alkaline rocks of Port Cygnet, etc. (Proc. Roy. Soc. Vict., vol. xxix.). The same author wrote a note on the Tertiary alkaline rocks of Victoria for the British Association at its Melbourne meeting in 1914. Since then he has made a number of additional observations which are detailed.

A committee was appointed to collect information in regard to the occurrence of artesian water in Australia, with Mr. S. A. Ward, Government Geologist of South Australia, as secretary.

Section D (*Biology*).—It was decided that a resolution be sent to the Premier of South Australia emphasising the great national and scientific importance of the preservation of native fauna and flora, and congratulating the Government on the legislation recently passed constituting Flinder's Chase, on Kangaroo Island, a national reserve for fauna and flora. Immediate steps should be taken to give full effect to that legislation. The Government is further urged to give full consideration to the unique importance which attaches to the constitution of the whole of Kangaroo Island as a national fauna and flora reserve, as well as to the protection of the land, fresh-water, and sub-aquatic fauna and flora of all the islands in South Australian waters other than Kangaroo Island which are actively used for farming pursuits.

The Ecology Committee was re-appointed with some additional names (Dr. C. S. Sutton, secretary). It was further resolved that a committee be appointed to collect data and initiate a reasonably detailed ecological map of Australia marking out the distribution of the salt-bush and other type-flora.

It was further resolved, on the motion of Sir Baldwin Spencer, that in order to carry out immediately a co-ordinated investigation into the land and fresh-water fauna and the flora of Australia and Tasmania the societies and institutions in the various States be requested to co-operate in the work, and to take such steps as they may deem advisable for carrying out this work, especially in securing in each State the active assistance of

specialists in different branches of botany and zoology.

It was resolved to prepare a bibliography of the botany of those Pacific islands of special interest to Australia under the auspices of a committee consisting of the Government Botanists of Queensland, New South Wales, and Victoria, Mr. J. H. Maiden to be the convener. The sum of 50*l.* was voted in aid of the work.

A brief report was furnished by the Committee for the Biological and Hydrographical Study of the New Zealand Coast (Prof. C. Chilton, secretary). The war has hindered the examination of the collections and the publication of the results.

Section E (*Geography and History*).—It was resolved to urge on the Federal Government that, in the interests of historical and geographical research, it is desirable that steps be taken to continue the work of obtaining translations of all available journals of the early French navigators in Australian waters. It was also resolved to subsidise the work of the investigation of ocean currents, tides, and sand movements on the Australian coasts which has been undertaken, at his own expense, by Mr. G. H. Halligan, late Hydrographic and Supervising Engineer for New South Wales.

Section F (*Ethnology and Anthropology*).—It was resolved that the need for the formation of a Federal Museum for Australia and its territories, and the immediate necessity for securing specimens, historical and ethnological, while they are yet available, be urged on the Federal Government.

Also, that the Federal Government be pressed to endow a chair of anthropology, especially in view of its value in the government of subject races, and that attention be directed to the desirability of investigating and recording the ethnology of the northern part of Western Australia.

Section H (*Engineering and Architecture*).—The council welcomed the general recognition gradually being extended towards the movement for the better planning and development of cities and suburbs, and affirmed that great economic waste exists, and is increasing, consequent upon the ill-planning and absence of regulation for the proper development of cities and suburbs, which will lead to many and costly resumptions to make necessary improvements. The hope was also expressed that State Governments, following the lead of South Australia, may initiate suitable legislation on the subject, including provisions for ensuring full inquiry by means of civic surveys into the needs of existing urban areas.

Section I (*Sanitary Science and Hygiene*).—The Anthropometric Committee (Dr. Mary Booth, secretary) was re-appointed. On the joint recommendation of this Section and Section G (Social and Statistical Science), a committee was appointed to investigate and report on industrial fatigue in Australia.

In connection with Dr. Jean Greig's paper on the problem of the special child and the special school, it was resolved that, in view of the existence of feeble-minded persons and their economic cost to the community, it is desirable that the Government be asked to establish farm colonies and residential homes for the accommodation of these cases, and that in the case of New South Wales the proceeds of the Randwick Orphanage, specially reserved for the care of mentally deficient children, be forthwith applied for that purpose.

It was further resolved that medical inspection be extended so as to include all schools.

Section K (*Agriculture*).—It was decided that the Commonwealth Government be asked to provide funds for the encouragement of the cultivation of cotton in

such parts of the Commonwealth as are suitable climatically for its production.

In response to the request of the president of the Agricultural Section of the International Congress of Meteorology, it was decided to appoint a committee to report on the climatic control of wheat production in Australia.

Section L (*Veterinary Science*).—At a joint meeting of the Sections of Hygiene and Sanitary Science, Agriculture, and Veterinary Science Prof. J. Douglas Stewart, dean of the faculty of veterinary science at the University of Sydney, read a paper on "Animal Tuberculosis," the chief object of which was to revive interest in a resolution adopted at the fourteenth meeting of the association recommending the Governments of the States of Australia and of the Dominion of New Zealand to hold a conference of the chief medical and veterinary officers to discuss and report on uniform measures for the control of tuberculosis in cattle and pigs. Owing to the intervention of the war, the council of the association was unable to proceed with the matter.

Abstract of Presidential Address by Sir Baldwin Spencer.

The main part of the address dealt with some aspects of the cultural anthropology of Australian aboriginals, especially with their tribal and social organisation, as illustrating an early stage in the development of human society. In the remainder of the address the origin of the aboriginals and their relation to other races were discussed and a theory of the origin of their complex culture was suggested.

The question of the independent origin of similar inventions, beliefs, and customs was dealt with, and evidence from both the zoological and anthropological sides was brought forward to show the possibility of this. The remarkable homogeneity of all Australian tribes, even with regard to the details of their social organisation, gives no suggestion of outside influence. This homogeneity, existing side by side with the most remarkable differences in skull measurements, customs, beliefs, and arts revealing an extraordinary range of variability, presents a difficult problem quite insoluble on the theory of interactions of various immigrant peoples reaching Australia at different times.

The statement of Prof. Keith and others that the Australian race might have served as common ancestors for all modern races may be understood on the theory that it is the survivor of such a one that has been isolated for long ages in Australia, and has been practically uninfluenced by contact with other peoples. In conclusion, reference was made to the suggestion of Bateson that perhaps "the course of evolution may be regarded as an unpacking of an original complex which contained within itself the whole range of diversity which living things present," and it was suggested that in the characteristic marsupial fauna and in the aboriginals of Australia we have a remarkable example of such an unpacking. This has led, without any outside influence, to the development, on one hand, of mammalian forms along lines parallel with those pursued by higher forms so far as fundamental features are concerned, but controlled at the same time by some factor or combination of factors that has determined the retention of their marsupiality; on the other, it has led to the independent development of a race of human beings along lines parallel with those pursued by other early races of humanity from Mousterian to Aurignacian times, but again always controlled by some factor or combination of factors that has prevented them from developing into anything higher than men of the Stone age.

(To be continued.)

University and Educational Intelligence.

CAMBRIDGE.—Honorary degrees are to be conferred on the Prince of Wales, Marshal Foch, Admiral Sims, and Lord Plumer on May 31. The Crown Prince of Japan received an honorary degree on Wednesday, May 18.

The voting on the alternative schemes—(1) admitting women to membership of the University with limited rights or (2) granting them merely titular degrees—is to take place on June 16.

A lecturer is to be appointed in physics as applied to medical radiology.

The first Ph.D. degree has been approved, Mr. C. G. L. Wolf, of Christ's College, being the first successful candidate.

The examination in anatomy in the Natural Sciences Tripos is to be on a wide scale to cover the general morphology of vertebrates, a general knowledge of vertebrate (including human) embryology, and a special knowledge of the morphological side of human anatomy.

EDINBURGH.—The following lecturers have been appointed as readers in the Faculty of Science: Dr. H. S. Allen in physics, Dr. R. Campbell in petrology, and Dr. L. Dobbin in chemistry.

Dr. Beard, lecturer in comparative embryology, has resigned for reasons of health, and Dr. Balsillie, on being transferred to the Royal Scottish Museum, has resigned his lectureship in chemistry.

It has been resolved to re-institute the special tutorial course in German for students of science.

It was reported that the new Ordinance for Degrees in Pure Science (Ordinary and Honours) had been approved by his Majesty in Council, and had now come into force.

LONDON.—A lecture will be given at King's College on Thursday, June 9, at 5.15 p.m., by Prof. Einstein on "The Development and Present Position of the Theory of Relativity." The chair will be taken by Viscount Haldane. A charge of 2s. 6d. will be made for admission, and the proceeds will be given to the Imperial War Relief Fund. The lecture will be delivered in German. Tickets can be obtained on application to the lecture secretary at the college.

The following advanced lectures addressed to students of the University and to others interested in the subjects have been arranged. Admission is free, without ticket:—A course of four lectures on "Recent Developments in Legislation for the Prevention of Disease," by Dr. Charles Porter, at University College at 5.30 p.m. on May 30 and June 3, 6, and 10. A course of four lectures on "Some Actions of Foodstuffs in the Production and Treatment of Disease," by Prof. E. Mellanby, at the Royal College of Surgeons, Lincoln's Inn Fields, W.C.2, at 5 p.m. on June 6, 7, 13, and 14. A course of three lectures on "Recent Advances in Experimental Embryology," by Prof. E. W. McBride, at the Imperial College, Royal College of Science, Exhibition Road, S.W.7, at 5 p.m. on June 7, 8, and 9. A lecture on "Permeability in Physiology and Pathology," by Prof. H. J. Hamburger, at the rooms of the Royal Society of Medicine, 1 Wimpole Street, W.1, at 5 p.m. on June 8 (this lecture is the last of a series of six arranged under the scheme for the exchange of lecturers in medicine between England and Holland). A course of four lectures on "The Therapeutic Use of Digitalis," by Prof. F. R. Fraser, in the surgical lecture theatre, St. Bartholomew's Hospital Medical School, West Smithfield, E.C.1, at 5 p.m. on June 13, 15, 17, and 20.

MR. H. J. DAVIS has been appointed to a lectureship in mathematics in the Bradford Technical College. He is at present senior lecturer in mathematics in the University College, Southampton, and has specialised on the theory of statistics.

THE Secretary of State for India in Council has made the following appointments to the Indian Educational Service:—To be professor of physics in Presidency College, Madras, Dr. Shankar Rao Ullal Savori; to be professor of biology in the University of Rangoon, Dr. J. Brontë Gatenby.

PROF. E. G. COKER, professor of civil and mechanical engineering, University College, London, has accepted invitations from the Universities of Ghent and Louvain to lecture there next week on "Recent Researches in Photo-Elasticity," and also one from the Société Belge des Ingénieurs et des Industriels to lecture in Brussels on "The Applications of Photo-Elasticity to Engineering."

THE Anglo-Swedish Society (10 Staple Inn, W.C.1) has awarded two scholarships of 50*l.* each to be spent on travelling in Sweden: one to Miss Dorothy Cridland, to enable her to study the industrial economy of the country; the other to Mr. G. R. Carline, to aid his study of the open-air and folk museums of Sweden and their influence on national life. Similar scholarships will be awarded in the spring of each year.

THE Ramsay Memorial Trustees will at the end of June consider applications for two Ramsay Memorial fellowships for chemical research. One of the fellowships will be limited to candidates educated in Glasgow. The value of the fellowships will be 250*l.* per annum, to which may be added a grant for expenses not exceeding 50*l.* per annum. Full particulars as to the conditions of the award are obtainable from Dr. Walter W. Seton, secretary, Ramsay Memorial Fellowships Trust, University College, London, W.C.1.

THE Science Masters' Association, in response to an invitation to co-operate with the staff of the Rothamsted Experimental Station, Harpenden, has issued to its members, representing upwards of three hundred schools, a circular outlining the types of research work in which it is believed that school science and natural history clubs can best give the assistance solicited by the Rothamsted experts. The lines suggested are:—(1) The weed-flora of arable land, its relation to the type of soil, to the geological formation, to the system of manuring, to the crop rotation, and so on; (2) the physical properties (texture, pore-space, water-content, etc.) of the soil; and (3) the carbonate-content and the nitrogen-content of the soil. These have the merit of presenting a certain degree of finality that is within the reach of a boy in the course of one or two school terms. The weed-flora problems should appeal to the field club, while the other two should be attractive to boys whose bent is chemical and physical rather than biological. It is a step entirely in the right direction thus to link up the work of those still *in statu pupillari* with that of experts seriously engaged in research. The moment is very opportune for bringing home to the minds of boys that their amateur efforts in research may speedily be of real benefit to mankind and add to the sum of knowledge relating to the complex problems of plant-life. The work is of high educational value, and also of very practical utility; it deserves warm encouragement for both educational and utilitarian reasons. It is not beyond hope that industries other than agriculture may ere long enlist the services of schools in their several research problems.

Calendar of Scientific Pioneers.

May 27, 1914. Sir Joseph Wilson Swan died.—A partner in a firm of chemical manufacturers at Newcastle, Swan became famous by his invention of the carbon process in photography and by his pioneering work on the incandescent electric lamp. His first carbon filament lamp was shown at Newcastle in 1879. He received many honours, and in 1898-99 was president of the Institution of Electrical Engineers.

May 28, 1893. Charles Pritchard died.—Graduating as a Wrangler in 1830, Pritchard from 1834 to 1862 was headmaster of a successful grammar school at Clapham. In 1870, at the age of sixty-three, he became Savilian professor of astronomy at Oxford. He was a pioneer in the photographic measurement of stellar parallax, invented the wedge photometer, and in 1885 published his "Uranometria Nova Oxoniensis."

May 28, 1906. Rudolf Knietsch died.—A native of Silesia, Knietsch in 1884 became a director of the Badische Anilin- & Soda-Fabrik at Mannheim, where he played an important part in the manufacture of artificial indigo and in that of sulphuric acid by the contact process.

May 29, 1829. Sir Humphry Davy died.—Already famous for his discovery of nitrous oxide, in 1801 at the age of twenty-three, and at a salary of 100l. a year, Davy became the first professor of chemistry at the Royal Institution. His great discoveries of sodium and potassium were made there in 1807. In 1815 he invented his miners' safety-lamp. Knighted in 1818, he was president of the Royal Society from 1820 to 1827. His death occurred at Geneva.

May 29, 1896. Gabriel Auguste Daubr e died.—Trained in Paris as a mining engineer, Daubr e became professor of geology in the Mus e d'Histoire Naturelle and Director of the School of Mines. He carried out an important series of experimental researches in geology.

May 29, 1897. Julius von Sachs died.—Professor of botany at W rzburg from 1868, Sachs contributed to all branches of botany, and especially to plant physiology. His well-known text-book was published in 1865 and his "History of Botany" ten years later.

May 29, 1898. Sir Lyon Playfair, first Baron Playfair of St. Andrews, died.—Chemist to the Geological Survey and the School of Mines, Playfair from 1856 to 1869 was professor of chemistry at Edinburgh. He entered Parliament, held public office, and did much to further the study and application of science. He was knighted in 1883 and raised to the peerage in 1892.

May 31, 1867. Th ophile Jules Pelouze died.—Joint author with Fr emy of an important treatise on chemistry, Pelouze made researches in organic chemistry, lectured at the Coll ge de France and the Ecole Polytechnique, and became President of the Mint.

June 1, 1812. Richard Kirwan died.—Of independent means and possessing many accomplishments, Kirwan was the correspondent of many scientific men, and in 1799 became president of the Royal Irish Academy. His "Elements of Mineralogy" (1784) was the first systematic treatise on that subject in English, and his essay on Phlogiston (1787) was one of the last attempts to defend Stahl's theories. Kirwan acknowledged his conversion to Lavoisier's views four years later.

June 1, 1903. J. Peter Lesley died.—Born at Philadelphia and educated for the ministry, Lesley assisted in geological work and ultimately became professor of geology in the University of Pennsylvania, and from 1874 to 1893 directed the Geological Survey of that State.

E. C. S.

Societies and Academies.

LONDON.

Royal Society, May 12.—Prof. C. S. Sherrington, president, in the chair.—G. W. Walker: The problem of finite focal depth revealed by seismometers. Observations of the emergence angle of P waves at Pulkovo suggest that the depth of focus is of order one-fifth of the earth's radius. Important modifications are necessary in the interpretation of seismograms and in the attempt to determine how speed of propagation depends on depth. A test of the accuracy of the Pulkovo values can be made by a scrutiny of seismograms for distances >11,000 kilometres. Corresponding measures of the angle of emergence of S waves by means of three component seismometers are required.—E. A. Griffiths: A liquid oxygen vaporiser. The liquid oxygen is contained in a metal vacuum vessel. The emission of gas is governed by bringing a flexible portion of the outer wall into contact with the inner; the degree of contact determines the rate of transmission of heat. Any desired rate of gas evolution can be obtained up to 10 litres per minute, and the delivery remains constant.—Dorothy M. Palmer and W. G. Palmer: Some experiments on the catalytic reduction of ethylene to ethane. The hydrogenation of ethylene in the presence of nickel has been quantitatively examined. The mixture of ethylene and hydrogen was brought into contact with nickel in motion in an electrically heated tube. The rate of hydrogenation was measured by the rate at which a mixture of ethylene and hydrogen in equal proportions by volume had to be passed into the tube to maintain the gas therein at constant pressure. The effects of varying conditions were studied. The curves showing rate of reaction against time display "induction" periods during which no hydrogenation took place, varying in duration from a few seconds to many hours, according to the conditions of the experiment. Then the rate of reaction increases rapidly to a sharp maximum, and decreases less rapidly to a lower value, which decreases slowly. A theory is advanced to account for these effects.—W. G. Palmer: The catalytic activity of copper. Part ii. The activity of copper when prepared from oxide by reduction with carbon monoxide and methyl alcohol vapour is discussed. Constant-boiling mixtures of several alcohols with water were used as reactants. Water acts as a positive, and hydrogen as a negative, auxiliary catalyst when adsorbed on the copper. The activity-temperature curves for a catalyst prepared by carbon monoxide obey a simple exponential law. Between 270° and 280° C. the activity curves generally undergo a sudden change of direction corresponding to a great reduction of the temperature coefficient. This is attributed to the diminution in the thickness of the adsorbed alcohol layer to at most two molecular diameters. The activity of the catalyst does not increase continuously, as the temperature of its preparation from oxide is lowered.—Prof. C. F. Jenkin and D. N. Shorthose: The total heat of liquid carbonic acid. The total heat of carbonic acid between temperatures of +10° C. and +100° C. and between pressures of 900 lb. and 1800 lb. per square inch was measured. The values hitherto accepted, based on the assumption that the specific heat at constant volume does not change over this range, require slight correction.—Dr. A. O. Rankine: The viscosity and molecular dimensions of gaseous cyanogen. The viscosity of gaseous cyanogen has been measured at 15° C. and 100° C., the values obtained being, respectively, 0.086×10^{-4} and 1.264×10^{-4} C.G.S. units. Assuming Sutherland's law of temperature variation, the data have been used

to calculate Sutherland's constant ($C. = 280$) and the viscosity at 0°C. ($\eta = 0.935 \times 10^{-4}$ C.G.S. units). The mean collision area of the molecule of cyanogen deduced, -1.31×10^{-15} cm.², proves to be practically the same as that of a bromine molecule, 1.28×10^{-15} cm.² This is consistent with the evidence from crystal examination, for the molecular volumes of KBr and KCN are nearly equal. If X-ray crystal examination should prove that KCN and KBr are strictly isomorphous, the results here obtained are consistent with the Lewis-Langmuir view that the cyanogen molecule has a size and shape nearly the same as those of two nitrogen molecules linked together by sharing one pair of outer electrons.

Linnean Society, May 5.—Dr. A. Smith Woodward, president, in the chair.—Prof. A. Dendy: Hexactinellid sponges. The origin on certain elongated siliceous spicules of discs at regular intervals corresponds almost exactly with the nodal points of a vibrating body as determined by Prof. J. W. Nicholson.—Six papers dealing with various groups of insects collected by the Percy Sladen Trust Expedition:—C. G. Lamb: Diptera (iii.). A report chiefly on the Dolichopodidæ, a large family of small- or middle-sized flies, usually of beautiful metallic green or golden colours. The general affinities of the Seychelles forms are discussed. Most of them belong to a subfamily largely represented in the tropics, the Chrysosomatinae or Psilopinæ; some of these flies, with dazzlingly brilliant golden-green bodies, settle in bright sunlight on broad leaves; another group of smaller and much duller-coloured species is almost entirely confined to the damp, shady mountain forests. A new genus, characterised by the males having at the base of the abdomen a pair of remarkable hollow spherical bulbs, with a round opening at the top through which can be seen a rod rising from the bottom of the bulb, is described. The bases of the wings are also highly modified. The Asilidæ and the Syrphidæ are also discussed.—H. Gebien: The Tenebrionidæ. A large family, mostly of large- or middle-sized beetles. The known Tenebrionid fauna of the island is increased from twelve to forty-one species; of these twenty-one are probably endemic, and eleven belong to endemic genera. The endemic genera are isolated and specialised forms. The idea previously advanced by Kolbe, that certain of these peculiar forms indicate relationships between the fauna of the Seychelles and those of New Zealand and South America, is not upheld, for the endemic species which do not belong to endemic genera present Oriental affinities. There is a much less pronounced Madagascan element, while the African element is represented only by a single widespread form.—Mr. Schenkling: The Cleridæ. A strong affinity exists with the fauna of Madagascar, four out of the six Seychelles species being new and having strongly Madagascan affinities, while the two remaining species are cosmopolitan. One of the new Seychelles forms has a superficial resemblance to an Anthribid beetle from the same islands. Both belong to new genera, Cleranthribus and Anthriboclerus. There are no data to show relationship between them.—Dr. M. Bernhauer: The Staphylinid beetles. The known Staphylinid fauna of the Seychelles is increased from twenty-eight to eighty-one species. The report also includes one species from the Chagos Islands and two from Aldabra. The conclusions of earlier writers were that the affinities of the Seychelles Staphylinidæ were, on the whole, Oriental, but that a smaller Madagascan element and a very small African element were included. These conclusions are in the main upheld, but generalisations must be accepted with

reserve, for the smaller forms are still practically unknown in surrounding continents, and it is not known which species have reached the islands by natural means and which through human agency. A summary of observations on habits is given.—Dr. H. Scott: Clavicorn and other beetles. A great deal of fine work on the external anatomy was done in describing these forms. Numerous interesting points in the structure of tarsi, antennæ, mouth-parts, etc., and some remarkable secondary sexual characters, came to light. The geographical distribution is shown by a tabulated comparison of the numbers of representatives of these families in the Seychelles with the faunas of the Hawaiian and of the Atlantic islands. The Seychelles have a great number of families and genera, usually represented by a few clearly separable species. The Hawaiian islands have several families altogether wanting, while in other groups they possess great "endemic complexes."—Florence E. Jarvis: The Hydroids of the western Indian Ocean. An account of the collections obtained during the voyage of H.M.S. *Sealark* at varying depths to 130 fathoms and of some shallow coastal collections made by Mr. C. Crossland off East Africa. There are eleven Gymnoblastera and seventy-four Calyptoblastea. The number of new species is relatively small, the influence of depth and currents being emphasised as having a marked effect on the habit of colonies. All the larger families are represented, the group being practically cosmopolitan; there are no new genera, but the species comprise a number of new Plumularians.—Dr. C. I. van der Horst: Madreporaria, Agariciidæ. Twenty-nine species are recorded belonging to the genera Agaricia, Pavona, Podabacia, Leptoseris, Siderastrea, Coscinaræa, Psammocora, and Pachyseris. The type-specimens of previous authors have generally been consulted. Three species are described as new. The examination of the collection has resulted in many species, previously described as different, being shown to be connected by transitional forms.—E. R. Speyer: Insects in relation to the reproduction of coniferous trees. The destruction of the cones of *Pseudotsuga Douglasii*, Carr., *Pinus ponderosa*, Dougl., and *P. echinata*, Mill., by various insects was discussed.

Zoological Society, May 10.—Dr. A. Smith Woodward, vice-president, in the chair.—R. I. Pocock: The auditory bulla and other cranial characters in the Mustelidæ (martens, badgers, etc.).—G. S. Thapar: The venous system of the lizard, *Varanus bengalensis*, Daud.

Royal Meteorological Society, May 18.—Mr. R. H. Hooker, president, in the chair.—J. E. Clark and H. B. Adames: Report on the phenology of the British Isles, December, 1919, to November, 1920. The abnormal mildness and wetness up to mid-April ruined fruit-tree crops through too early blooming. Field crops suffered through drought in May and June and the cold sunlessness of July and August, with excessive wet in the former month. After June, in England, the accumulated temperature above 42° (that at which wheat will grow) fell more and more behind the mean until October, which, by its warmth, sunshine, and dryness, gave a wonderful seeding time in earlier districts and helped to save crops in the later. In 1920 the four spring flowers were, in England and Wales, $13\frac{1}{2}$ days early (February 27); 10 days (March 3) for the whole of the British Isles. The latter date for 1919 was March 15. The succeeding flowers became less and less early, until the two of July were just average. From 1921 on observers are asked to include the Devil's-bit scabious in order to

extend the records into August. The mean date of all is 8.2 days earlier, or the earliest in the thirty years except 1893 (14 days). The latest were 1891 (9½ days late) and 1917 (7½ days). Two charts show by isohels, isotherms, and isophenes the relation between lines of equal sunshine, equal temperature, and equal appearance of flowers. The correspondence is closest between the last two. Thus the average flowering date ranges from April 19, in the south-west, near the isotherm of 50°, to May 31 on the isophene lying between isotherms 45° and 44°, 7° further north, which represents a rate of change of 6 days for each degree. In continental districts, European and North American, the rate is nearer 4 days. Bird migrations and appearances of insects confirm the plant records. The former were 3½ days earlier than the mean of the seven years available.—Dr. E. J. Salisbury: Phenology and habitat, with special reference to woodlands. The observations of Klebs and Lakon have shown the importance of conditions of nutrition in determining periodic phenomena. Raun Kaier has, moreover, shown that earliness or lateness in foliar development is an hereditary character. Probably no less important is the influence of habitat. The flowering period of chalk-down plants is, on the whole, early, whilst that of aquatics is late, but the close relation between phenology and habitat is best illustrated by woodland plants. Here we find there is a definite sequence from below upwards. Taken as a whole, woodland species develop earlier than non-woodland, but this is especially true of the shade flora. The average date for the inception of foliar development of woodland herbs, which lose their leaves during the winter, is February 19. Many, however, retain all or part of their foliage throughout the "light-phase." The leafage of the shrubs begins about a month later (average date March 19), and that of the trees towards the end of April (average, April 21). This upward sequence and its early inception are clearly correlated with the diminished light (7 to 1 per cent. of that in the open) in the interior of the wood from the end of May to the beginning of November. Such facts emphasise the importance of choosing species for phenological observation belonging to similar habitats and possessing aerial and underground organs of a similar nature. Further leafage appears to be more susceptible to meteorological changes than the flowering period, which is the usual subject of meteorological observation.

PARIS.

Academy of Sciences, May 2.—M. Georges Lemoine in the chair.—J. Boussinesq: Rectification and completion of a note of April 18 on the flattening of a rotating liquid drop.—T. Bonnesen: An improvement of the isoperimetric inequality of the circle and the demonstration of an inequality of Minkowski.—M. Alayrac: The movement of the centre of gravity of a solid symmetrical with respect to a vertical plane displacing itself in a resisting medium.—H. Godard: Observations of Winnecke's comet (1921b) made at the Bordeaux Observatory with the 38-cm. equatorial. Apparent positions and positions of comparison stars given for April 26, 28, and 29. The comet was of the 12th magnitude.—J. Malassez: The use of the lamp with three electrodes for the measurement of ionisation currents.—F. Guéry: Some consequences of the Lorentz contraction from the point of view of cohesion, of gravitation, and of electromagnetism.—G. Contremoulin: The protection of third parties against X-rays. The range of the radiations emitted by a Coolidge tube is considerable, and the effects have been traced up to a distance of 80 metres.—C.

Raveau: Saturated solutions of two or more substances. The application of Le Chatelier's principle.—E. Darmois: The specific dispersion of hydrocarbons.—A. Damiens: Tellurium tetraiodide. An account of the preparation, purification, and physical and chemical properties of the iodide TeI_4 . It is a well-defined compound, and will serve as a raw material for the preparation of numerous derivatives of tellurium.—A. Mailhe: The catalytic hydrogenation of the phenylhydrazones. The phenylhydrazones of aldehydes carried over nickel at 180° C. by a current of hydrogen split up into aniline and nitriles; the reduction to fatty amine and aniline is secondary. Phenylhydrazones of ketones behave differently, the reduction with production of fatty amine being the main reaction.—P. Palacios: Observations on a note on the tectonic of the western Pyrenees. Remarks on a recent communication by P. Stuart-Menteth.—F. Kerforne: The age of the oldest strata of the Armorican massif.—P. Bonnet: Liassic volcanic eruptions and their relations with the distribution of the facies in the Caucasian geosynclinals.—M. Dort: The variations of the solar radiation during the eclipse of the sun of April 8, 1921, at Bagnères-de-Bigorre, observatory station on the Pic du Midi. Observations were made with an actinometer of the Violle type and reduced to 15-minute intervals between 8 and 10.15 a.m. The figures are compared with the mean of corresponding measurements made on April 7 and 11.—M. Molliard: The influence of sodium chloride on the development of *Sterigmatocystis nigra*. The addition of salt to the culture medium above a certain concentration reduces the velocity of the chemical reactions of the mould; it also indirectly causes sterility of the mycelium owing to the accumulation of nitric acid.—G. Astre: Contribution to the study of the distribution of the biological zones on the Mediterranean dunes of the Gulf of Lyons.—M. Manquat: The phototropism of *Leucoma phaeorrhoea*. The author's observations on the action of light on the young caterpillars of *L. phaeorrhoea* do not confirm the conclusions of Loeb.—E. Couvreur and X. Chahovitch: Microbial infections in the invertebrates. Criticisms of a recent paper by M. Paillot on the same subject.—F. Viès and I. Dragoiu: The osmotic pressure of arrest of cell division. The cells studied were those of the eggs of the sea-urchin, and these were grown in sea-water containing sugar in solution. With osmotic pressures between 25 atmospheres (sea-water) and 30 atmospheres the effects were negligible. Between 30 and 50 atmospheres the percentage of eggs achieving division fell rapidly to zero. Ten per cent. of the eggs had their division stopped at 33 atmospheres and 90 per cent. at 39 atmospheres.—M. Bridel: The action of emulsion on galactose in solution in propyl alcohol of different concentrations.—E. Kayser: The influence of uranium salts on nitrogen fixation. A study of the effect on addition of uranium salts on the growth of *Azobacter agile* in glucose and mannite culture media.—R. Anthony and C. Champy: The reptilian form of the spermatozoid of *Manis javanica* and its signification.—R. Hovasse: The parthenogenetic activation of the eggs of *Rana temporaria* in hypotonic and hypertonic media.—C. Lebailly: Bovine aphthous fever is not transmissible to man; human aphthous stomatitis is not transmissible to cattle.—M. Mirande: Lathyrism, or the intoxication produced by vetch-seeds. The seeds of *Lathyrus sativus* and *L. cicera* have been proved to be poisonous to horses. The ground-up seeds, moistened with water, undergo a spontaneous fermentation and sulphuretted hydrogen is evolved. The poisonous action of the seeds is most probably due to the evolution of this gas in the stomach.

Books Received.

Priestley in America, 1794-1804. By Edgar F. Smith. Pp. v+173. (Philadelphia: P. Blakiston's Son and Co.) 1.50 dollars net.

How to Teach Agriculture: A Book of Methods in this Subject. By Prof. Ashley V. Storm and Dr. Kary C. Davis. Pp. vii+434. (London: J. B. Lippincott Co.) 12s. 6d. net.

Geography: Physical, Economic, Regional. By James F. Chamberlain. (School Text Series.) Pp. xviii+309. (London: J. B. Lippincott Co.) 15s. net.

Practical Geometry for Builders and Architects. By J. E. Paynter. (Directly-Useful Technical Series.) Pp. xii+409. (London: Chapman and Hall, Ltd.) 15s. net.

The Elements of Direct Current Electrical Engineering. By H. F. Trewman and G. E. Condliffe. Pp. vii+219. (London: Sir I. Pitman and Sons, Ltd.) 7s. 6d. net.

Bibliographie des Séries Trigonométriques: avec un Appendice sur le Calcul des Variations. By Maurice Lecat. Pp. viii+168. (Louvain: M. Lecat.)

Engineering Electricity. By Prof. Ralph G. Hudson. Pp. viii+190. (New York: J. Wiley and Sons, Inc.; London: Chapman and Hall, Ltd.) 13s. 6d. net.

Logic. By W. E. Johnson. Part i. Pp. xl+255. (Cambridge: At the University Press.) 16s. net.

Abridged Callendar Steam Tables: Fahrenheit Units. By Prof. H. L. Callendar. Pp. 8. (London: E. Arnold.)

Abridged Callendar Steam Tables: Centigrade Units. By Prof. H. L. Callendar. Pp. viii. (London: E. Arnold.)

The Hilger Interferometer for Measuring the Aberration of Camera Lenses. Pp. 25. (London: Adam Hilger, Ltd.)

Rules of Golf, as approved by the Royal and Ancient Golf Club of St. Andrews, September 28, 1920. In force as from May 1, 1921. Pp. xiii+36. (London: Royal Insurance Co., Ltd.)

Impressions and Comments. By Havelock Ellis. Second Series, 1914-1920. Pp. 248. (London: Constable and Co., Ltd.) 12s.

The Age of Power: A First Book of Energy, its Sources, Transformations, and Uses. By J. Riley. Pp. viii+248. (London: Sidgwick and Jackson, Ltd.) 4s. net.

String Figures. By W. W. Rouse Ball. Second edition. Pp. 69. (Cambridge: At the University Press.) 2s. 6d. net.

The Chemists' Year Book, 1921. Edited by F. W. Atack. Vol. i. Pp. vi+422. Vol. ii. Pp. vii-viii+422-1142. (Manchester: Sherratt and Hughes.)

The Mneme. By Richard Semon. Pp. 304. (London: G. Allen and Unwin, Ltd.; New York: The Macmillan Co.) 18s. net.

A History of Psychology. By Prof. George S. Brett. (Library of Philosophy.) Vol. ii.: Mediaeval and Early Modern Period. Pp. 394. Vol. iii.: Modern Psychology. Pp. 322. (London: G. Allen and Unwin, Ltd.; New York: The Macmillan Co.) 16s. net each vol.

Insanity and Mental Deficiency in Relation to Legal Responsibility: A Study in Psychological Jurisprudence. By Dr. William G. H. Cook. Pp. xxiv+192. (London: G. Routledge and Sons, Ltd.; New York: E. P. Dutton and Co.) 10s. 6d. net.

Idromeccanica Piana. By Prof. Umberto Cisotti. Parte prima. Pp. xii+152. (Milano: Libreria Editrice Politecnica.) 24 lire.

The First Assembly: A Study of the Proceedings of the First Assembly of the League of Nations.

Edited by Oliver Brett. Pp. viii+277. (London: Macmillan and Co., Ltd.) 3s. 6d. net.

Simple Lessons on the Weather: For School Use and General Reading. By E. Stenhouse. Pp. viii+135+xii plates. (London: Methuen and Co., Ltd.) 4s.

The Physical Society of London. Proceedings. Vol. xxxiii., part iii. (London: Fleetway Press, Ltd.) 6s. net.

Der Bau der Erde. By Prof. Leopold Kober. Pp. iv+324+2 Tafeln. (Berlin: Gebrüder Borntraeger.) 80 marks.

The Diseases and Pests of the Rubber Tree. By T. Petch. Pp. x+278+vi plates. (London: Macmillan and Co., Ltd.) 20s. net.

The Elements of Vegetable Histology. By Prof. C. W. Ballard. Pp. xiv+246. (New York: J. Wiley and Sons, Inc.; London: Chapman and Hall, Ltd.) 18s. net.

A First Course in Statistics. By D. Caradog Jones. Pp. ix+286. (London: G. Bell and Sons, Ltd.) 15s. net.

The New Stone Age in Northern Europe. By Prof. John M. Tyler. Pp. xviii+310. (London: G. Bell and Sons, Ltd.) 15s. net.

Elementary Algebra. By C. V. Durell and R. M. Wright. (Cambridge Mathematical Series.) Part ii. (with Answers). Pp. xxiii+253-551+xlvii-lxxxv. (London: G. Bell and Sons, Ltd.) 5s. 6d. net.

Gynecology. By Dr. Brooke M. Anspach. Pp. xxvi+752. (London: J. B. Lippincott Co.) 42s. net.

A Sketch-Map Geography: A Text-Book of World and Regional Geography for the Middle and Upper School. By E. G. R. Taylor. Pp. viii+147. (London: Methuen and Co., Ltd.) 5s.

Le Règlement d'Avaries du Grand Abordage. By René E. Bossière. Pp. 36. (Paris: Rousseau et Cie.)

Diary of Societies.

THURSDAY, MAY 26.

INSTITUTION OF GAS ENGINEERS (at Institution of Civil Engineers), at 10 a.m.

ROYAL HORTICULTURAL SOCIETY (at Chelsea), at 3.

ROYAL INSTITUTION OF GREAT BRITAIN, at 3.—E. Law: The Architecture and Art of Hampton Court Palace. II. In Stuart and Later Times.

ROYAL SOCIETY, at 4.30.—Sir Alfred Ewing: The Atomic Process in Ferro-magnetic Induction.—C. D. Ellis: The Magnetic Spectrum of the β -rays excited by the γ -rays.—S. Datta: The Spectra of the Alkaline Earth Fluorides and their Relation to Each Other.—Dr. W. L. Balls: A Simple Apparatus for Approximate Harmonic Analysis and for Periodicity Measurements.—Dr. G. R. Goldsborough: The Influence of Satellites upon the Form of Saturn's Ring.—Dr. H. Jeffreys: Certain Geological Effects of the Cooling of the Earth.—T. Kikuchi: The Moving Striations in a Neon Tube (title only).

INSTITUTE OF PATHOLOGY AND RESEARCH (at St. Mary's Hospital, Paddington), at 4.30.—Dr. J. A. Murray: Aims and Progress of the Experimental Study of Cancer.

INSTITUTION OF ELECTRICAL ENGINEERS (at Savoy Place), at 6.—A. Johnsen and K. Rabhek: A Physical Phenomenon and its Application to Telegraphy, Telephony, etc.

CONCRETE INSTITUTE (Annual General Meeting), at 7.30.—L. S. White: Land Subsidence and its Effects on Concrete and other Structures.

ROYAL SOCIETY OF MEDICINE (Urology Section) (Annual General Meeting), at 8.30.—V. Z. Cope: Genito-urinary Symptoms in Acute Appendicitis.

FRIDAY, MAY 27.

ROYAL SOCIETY OF ARTS (Indian and Colonial Sections), at 4.30.—Sir Charles H. Bedford: Industrial (including Power) Alcohol.

PHYSICAL SOCIETY OF LONDON (at University College), at 5.—The General Electric Co. (communicated by C. C. Paterson): A Method for the Micro-analysis of Gases by the Use of the Pirani Pressure Gauge.—H. Pealing: The Reflection of the K-ray Spectrum of Palladium from Fluorspar.—Sir W. H. Bragg: The Intensity of X-ray Reflection by Diamond.—Exhibits of Crystal Models, and of Photographs by the Duc de Broglie of β -ray Spectra produced by X-rays.

ROYAL BOTANIC SOCIETY OF LONDON, at 5.15.—E. Law: Shakespeare's Garden, as it was, is now, and is to be.

ROYAL SOCIETY OF MEDICINE (Study of Disease in Children Section)

(Annual General Meeting), at 5.30.—Dr. H. Thursfield: The Diagnosis of a Case of Renal Calculus in a Child.
INSTITUTION OF MECHANICAL ENGINEERS, at 6.—J. G. Graves: The World's Money System.
JUNIOR INSTITUTION OF ENGINEERS, at 8.—S. A. Stigant: Notes on Electrical Transformer Breakdowns.
ROYAL SOCIETY OF MEDICINE (Epidemiology and State Medicine Section) (Annual General Meeting), at 8.30.—Dr. R. J. Reece: Some Observations on the Occurrence of Cow-pox and Human Cases in Connection Therewith.—Dr. F. R. Blaxall: Some Notes on the Preparation of Vaccine Lymph at the Government Lymph Laboratory.
ROYAL INSTITUTION OF GREAT BRITAIN, at 9.—A. Mallock: Elasticity.

SATURDAY, MAY 28.

ROYAL INSTITUTION OF GREAT BRITAIN, at 3.—F. Legge: Gnosticism and the Science of Religions. II.

MONDAY, MAY 30.

SURVEYORS' INSTITUTION (Annual Meeting), at 5.
ROYAL GEOGRAPHICAL SOCIETY (at Æolian Hall) (Anniversary Meeting), at 5.30.
ROYAL SOCIETY OF ARTS, at 8.—Sir Kenneth Weldon Goadby: Immunity and Industrial Disease.
NATIONAL UNION OF SCIENTIFIC WORKERS (in Botanical Theatre, University College), at 8.—Chairman: Viscount Haldane.—Prof. L. Baird: The Administration of Scientific Work (followed by a Discussion).

TUESDAY, MAY 31.

ROYAL INSTITUTION OF GREAT BRITAIN, at 3.—Sir James Frazer: Roman Life: Time of Pliny the Younger.

FRIDAY SOCIETY (at Chemical Society), 4.30-6.30 and 8-10.30.—Discussion on Physico-chemical Problems Relating to the Soil.—Dr. E. J. Russell: A General Survey of the Subject.—B. A. Keen: The System Soil—Soil Moisture.—Prof. D. R. Hoagland: The Soil Solution in Relation to the Plant.—Dr. C. A. Shull: Activity and Imbibition in Relation to Soil Moisture.—H. J. Page: The Part Played by Organic Matter in the Soil System.—Prof. Sven Oden: The Application of Physico-chemical Methods to the Study of Humus.—Dr. E. J. Salisbury: The Vertical Distribution of Soil Acidity in Natural Soils and its Relation to the Organic Constituents.—E. A. Fisher: The Phenomena of Absorption in Soils: a Critical Discussion of the Hypotheses Put Forward.—E. M. Crowther: Soil Acidity in its Physico-chemical Aspects.—C. G. T. Morison: Pan Formation.—Prof. Sven Oden: The Clays as Disperse Systems.—N. M. Comber: The Mechanism of Flocculation in Soils.—Dr. J. W. Mellor: Plasticity of Clay.—G. W. Robinson: The Physical Properties of the Soil in Relation to Survey Work.
INSTITUTION OF ELECTRICAL ENGINEERS (at Savoy Place), 5.—Annual General Meeting, 5.45.—Special General Meeting, at 6.30.—Ordinary Meeting. Dr. F. B. Jewett: Research Work in the United States.

ROYAL SOCIETY OF MEDICINE, at 5.—General Meeting of Fellows.
ROYAL PHOTOGRAPHIC SOCIETY OF GREAT BRITAIN, at 7.—Dr. C. T. Holland: The Snow and Ice Scenery of Switzerland.
ROYAL ANTHROPOLOGICAL INSTITUTE, at 8.15.
ILLUMINATING ENGINEERING SOCIETY (Annual Meeting) (at Royal Society of Arts), at 8.15.—J. S. Dow: The Use of Artificial Light as an Aid to Various Games and Sports.

WEDNESDAY, JUNE 1.

ROYAL SOCIETY OF MEDICINE (Surgery Section), at 5.30.—C. A. Parnett: The Treatment of the Imperfectly Descended Testicle.—Dr. A. Goodman Levy: Cardiac Massage.
SOCIETY OF PUBLIC ANALYSTS AND OTHER ANALYTICAL CHEMISTS (at Chemical Society), at 8.—F. F. Beach, T. E. Needs, and E. Russell: The Composition of Egg Powder.—N. Evers: The Colorimetric Method of Determining Hydrogen-ion Concentration: Some Uses in the Analytical Laboratory.—F. R. Dodd: The Estimation of Woody Fibre in Cattle Foods.
ENTOMOLOGICAL SOCIETY OF LONDON, at 8.

THURSDAY, JUNE 2.

ROYAL SOCIETY OF MEDICINE (Laryngology Section) (Summer Meeting), 2.30 to 6.
ROYAL INSTITUTION OF GREAT BRITAIN, at 3.—Sir Alexander C. Mackenzie: Beethoven.
INSTITUTE OF PATHOLOGY AND RESEARCH (at St. Mary's Hospital), at 4.30.—Prof. G. Dreyer: A New Departure in the Serum Diagnosis of Syphilis.
ROYAL SOCIETY, at 4.30.—Dr. T. M. Lowry and Dr. C. P. Austin: Optical Rotatory Dispersion (The Bakerian Lecture).

LINNEAN SOCIETY, at 5.—Prof. Garstang and Others: Discussion on Biogenetic Law (Recapitulation).

CHEMICAL SOCIETY, at 8.—H. King: Derivatives of Sulphur in Commercial Salvarsan. Part I.—S. Glasstone: Physical Chemistry of the Oxides of Lead. Part I. The Solubility of Lead Monoxide.—M. O. Forster and W. B. Saville: Studies in the Camphane Series. Part XXXIX. *p*-Aminophenylamino-camphor (*Camphoryl-p*-phenylenediamine).—K. Stratton and J. R. Partington: Latent Heats of Fusion. Part I. Benzophenone, Phenol, and Sulphur.—G. T. Morgan and H. D. K. Drew: Researches on Residual Affinity and Co-ordination. Part V. Gallium Acetylacetonate and its Analogues.—J. C. Thomlinson: Analysis of Cresol Disinfectants.—G. T. Morgan and D. Webster: Diazo-derivatives of 4-amino-phenyl-4'-methylbenz-2'-7'-thiazole (Dehydrothio-*p*-toluidine)—A. K. Macbeth and D. D. Pratt: The Labile Nature of the Halogen Atoms in Substituted Nitromethanes.—K. G. Naik: The Formation and Properties of Dithioketones (R₂C:S:S) and Dithioethers (R₂S:S). Part II.—K. G. Naik: The Formation and Properties of Dithioketones (R₂C:S:S) and Dithioethers (R₂S:S). Part III. Interaction of Sulphur Monochloride with Organic Compounds containing the grouping —CO—CH₂—CO—CH₂—CO—.

K. G. Naik: The Formation and Properties of Dithioketones (R₂C:S:S) and Dithioethers (R₂S:S). Part IV. Interaction of Sulphur Monochloride with Organic Compounds containing —CO—CH₂—CO— grouping, forming the Part of a Closed Ring.—K. G. Naik: The Formation and Properties of Dithioketones (R₂C:S:S) and Dithioethers (R₂S:S). Part V. Nitration of Dithioketones and Dithioethers.—K. G. Naik: Interaction of Sulphur Monochloride with Organic Acid Amides.—S. J. Lewis and F. M. Wood: A New Adjustable Thermostat for all Temperatures between 0° and 100°.—H. Burton and J. Kenner: The Influence of Nitro-groups on the Reactivity of Substituents in the Benzene Nucleus. Part III. The Partial Reduction of the Dinitrotoluenes by Stannous Chloride and Hydrochloric Acid.—J. Kenner and E. Witham: The Influence of Nitro-groups on the Reactivity of Substituents in the Benzene Nucleus. Part IV. The Condensation of Ethyl 3- and 5-nitro-*o*-Chlorobenzoates with Hydrazines.

FRIDAY, JUNE 3.

ROYAL SOCIETY OF MEDICINE (Laryngology Section) (Summer Meeting), 10 to 1.

ASSOCIATION OF ECONOMIC BIOLOGISTS (in Botanical Lecture Theatre, Imperial College of Science), at 2.30.—F. L. Engledow: Methods of Increasing Yield in Crop Plants.—C. B. Saunders: Some Problems of Seed Testing.—W. Brown: The Physiology of Infection.

ROYAL PHOTOGRAPHIC SOCIETY OF GREAT BRITAIN, at 8.—M. Adams: Eyes in Portraiture.

ROYAL INSTITUTION OF GREAT BRITAIN, at 9.—Dr. L. Huxley: Chronicles of the Cornhill.

SATURDAY, JUNE 4.

ROYAL INSTITUTION OF GREAT BRITAIN, at 3.—Dr. R. S. Rait: Scotland and France.

CONTENTS.

	PAGE
The Use of Oil Fuel	385
Education as a Science	386
Advances in the Study of the Yeasts. By Dr. David Ellis	387
Introduction to the Theory of Curves	388
Aeronautical Treatises	389
Our Bookshelf	390
Letters to the Editor:—	
The Aurora of May 13-15.—Right Hon. Lord Rayleigh, F.R.S.	392
The Gravitational Field of an Electron.—Sir Oliver Lodge, F.R.S.	392
The Magnetic Storm of May 13-17.—Dr. A. Crichton Mitchell	392
Ocean Tides.—H. A. Marmor	393
The Physical Status of "Space."—Dr. Harold Jeffreys	394
The Reparation Act and Scientific Research.—Prof. J. R. Partington	394
The Resonance Theory of Hearing.—Dr. H. Hart-ridge	394
Hæmoglobin in Mollusca.—Prof. A. E. Boycott, F.R.S.	395
Physiological Reactions in the Protozoa.—J. S. Dunkerly	395
Picture-hanging Wire.—A. J. Stubbs	395
Anode Rays of Beryllium.—G. P. Thomson	395
The Colours of Primroses.—Dr. G. Abbott	395
The Japanese Artificially Induced Pearl. (Illustrated.) By Dr. H. Lyster Jameson	396
The Recent Magnetic and Electrical Disturbances. By Dr. C. Chree, F.R.S.	399
The Recent Large Sun-spot Group. (Illustrated.) By H. W. Newton	399
Obituary:—	
Dr. G. B. Longstaff	401
Notes	402
Our Astronomical Column:—	
Comets	405
Theory of Jupiter's Satellites	405
An Early Chellean Palæolithic Workshop-site at Cromer	406
Hydrology of the Western States of North America. By Dr. Brysson Cunningham	406
The Plaice Fishery in the Belt Sea and Neighbouring Waters. By W. C. M.	407
The Melbourne Meeting of the Australasian Association. I.	408
University and Educational Intelligence	411
Calendar of Scientific Pioneers	412
Societies and Academies	412
Books Received	415
Diary of Societies	415



THURSDAY, JUNE 2, 1921.

Editorial and Publishing Offices:

MACMILLAN & CO., LTD.,

ST. MARTIN'S STREET, LONDON, W.C.2.

Advertisements and business letters should be
addressed to the Publishers.

Editorial communications to the Editor.

Telegraphic Address: PHUSIS, LONDON.

Telephone Number: GERRARD 8830.

The Metric System and World Trade.

A SHORT time ago (March 29) Dr. C. E. Guillaume contributed to the Paris Academy of Sciences a paper on the obligatory adoption of the metric system in Japan. The recent Japanese law making the metric system compulsory after a fixed period will no doubt have considerable effect towards rendering the system familiar in trade in the Far East, where its use is already facultative in some countries. Before arriving at this decision the Japanese Government dispatched a Commission of Inquiry to the principal trading centres of the world, so that the present law represents the outcome of prolonged and mature judgment, and as such supplies very satisfactory evidence in support of the international claims of the metric system. The values of the old units of Japan have for many years been defined in terms of the metre and the kilogram, and, owing to this fact and to the issue of regulations on the subject, the trading community has gradually become accustomed to metric weights and measures. Dr. Guillaume expects that in a few years the only weights and measures permissible in eastern Asia will be those of the metric system. The enormous strides made by this system in the Far East cannot be without effect in the United States, where in the past one of the principal arguments against it was that British weights and measures were tacitly recognised in China, Japan, and Siam. It appears probable, therefore, that before long advocates of

the metric system will be able to turn this line of reasoning against their opponents.

By its recent decision Japan has once more shown its readiness to change its customs in order to adapt itself to changing needs. Its statesmen have recognised that the metric system is the only system of service for international trade, and have, therefore, decided that their country shall not be handicapped by traditional use and human inertia from adopting new standards of measurement. We have no patience with any other policy. Whether a principle is sound or not may be discussed, and whether its adoption is expedient or not may also be a matter of opinion; but to suggest that a particular policy should not be followed merely because there are many difficulties in the way is to manifest a state of mind which we fail to understand. The first thing to decide in individual or national life is whether an action is right; and once having arrived at an affirmative conclusion, difficulties are nothing but obstacles to be surmounted boldly or swept aside ruthlessly from the path of progress.

This we conceive to be the true scientific spirit, and by the use of it Japan has won the high position which she now occupies among the nations of the world. We must confess, however, that in the matter of the adoption of the metric system there are few signs that like action will readily be taken in our own country. It is perhaps not surprising that Lord Balfour of Burleigh's Committee on Commercial and Industrial Policy after the War should have reported that it was not desirable to make a compulsory change in our system of weights and measures; but we expected something different from a committee appointed by the Conjoint Board of Scientific Societies. The report of this committee was dealt with in our issue of October 7 last, p. 169, and the only satisfactory thing about it from our point of view is that the Conjoint Board declined to adopt the report, which was, therefore, published on the authority of the committee alone.

In justice to the committee it must be said that the inquiry with which it was entrusted was solely that of the compulsory adoption or otherwise of the metric system in the United Kingdom, and not the advantages or disadvantages of the system in comparison with the British system of weights and measures, or its scientific aspects in general. Some of these subjects were, however, discussed—not altogether impartially—by the committee in its report; and the conclusion

reached was "that the British system of units of weights and measures be retained in general use in the United Kingdom." Interesting suggestions were made as to the decimalisation of our system and the abolition of several unnecessary units; but even if this were accomplished the result would still be that British manufacturers would have to continue to employ two systems—one for home trade, the other for trade with the increasing number of countries overseas in which the metric system is commonly used.

Neither Lord Balfour's Committee nor that of the Conjoint Board gave adequate attention to the value of official encouragement as a *via media* between legal permission and legal compulsion. The Act of 1897 made the use of the metric system permissive, and official adoption of the system now would pave the way to legal compulsion at a later date.

The many reports of our Consuls and representatives abroad have shown in the most convincing way that the practice of those British manufacturers who use only British weights and measures in their catalogues and price lists intended for other countries has a prejudicial effect on the extension of our foreign trade, particularly in countries where the metric system is used exclusively. In the textile trades British measures are no doubt widely recognised; but there is not the slightest reason for hope that their usage can be made international by common consent. The only possible international system is the metric system, and as a nation we cannot afford permanently to remain outside it. When the metric carat was legalised for use in trade in 1914, its adoption by dealers in diamonds and precious stones was practically complete in a few weeks, though they were previously opposed to the change. The weights and measures now given in the British Pharmacopœia are all in the metric system, and Imperial standards are entirely omitted. The dual system formerly used was found to be a constant source of trouble, and in 1914 it was abandoned in favour of the metric system alone. In mining statistics the metric ton is now a common standard, and in many engineering and ordnance machines and structures metric measures are now used almost as frequently as British. It cannot be said that our system of weights and measures is extending to other nations in the same way. Nothing that we could do would make the system international, so that what we have to do is to

choose between a system which has custom alone to commend it, and must be limited in its use and one which extends over the whole world and becomes more important industrially and commercially every year.

The adoption of the metric system by the United States and the United Kingdom is, indeed, inevitable, and adherence to the Imperial system is an obstacle to world commerce. We shall have to abandon the system sooner or later, and it would not be so difficult to adjust ourselves to the new standards now as it is to adapt ourselves to other conditions of reconstruction brought about by the war. The Colonies have frequently expressed their desire to adopt the system whenever the United Kingdom does so; all our European Allies, and practically half the population of the world, use it, and we cannot avoid doing so eventually. The only two important countries now outside the system are the United States and the United Kingdom, and when either of these enters it the other must follow.

During the war we, and the United States also, were forced to use metric measures in order to secure effective co-ordination between us and our Allies in military maps, range finding, firing data, and ordnance generally, and in the uniform standardisation of motors, aeroplane parts, and other machines and accessories. The result is that millions of men are now familiar with metric units, and would experience little difficulty in adjusting themselves to the change which the introduction of the metric system would involve. Every pupil in every secondary school in this country is made acquainted with the system, and in scientific work its use is universal. "The present chaos of English weights and measures," reported Sir J. J. Thomson's Committee on the position of natural science in the educational system of Great Britain, "causes waste of time and confusion of thought, and these are strong educational reasons for the adoption of the metric system."

The truth is that we have not a uniform system of weights and measures, but a medley of units and standards which differ in different industries and often vary in a single industry. In agriculture a bushel of wheat is defined in official statistics as having a weight of 62 lb.; by the Corn Returns Act it weighs 60 lb., and by the Grain Prices Order 63 lb. Bushels of barley and oats show like variations in weight both officially and according to frequent practice. To secure

uniformity in the weights and measures used in the sale of corn and other crops, the Corn Sales Bill is now being considered by a Committee of the House of Commons; but as the standard proposed is one of 112 lb., while the whole of the futures market is based on the decimal system, the Bill can be nothing more than a makeshift measure. In the textile industries, from which comes the chief opposition to the use of metric measures, the standards of measurement vary greatly in different centres, and there is no common relationship between them. British and American measures with the same denomination, such as the pound, yard, gallon, and bushel, also differ in quantity in the two countries. The advantages of a uniform system—a common language—from the point of view of world service are obvious, and the jealous attitude of conservative corporations towards it represents, not the spirit of progress, but rather that of obscurantism.

The fact that local and trade usage sanctions such a variety of weights and measures as that now existing in this country and in the United States is in itself sufficient to justify a movement towards reasonable uniformity. There is an official British system of weights and measures, but when trade transactions are concerned its standards are often varied to suit industrial convenience or local custom. A proposal that the British standards should be made compulsory in all transactions, and that no departures from them should be recognised, would evoke quite as much opposition as is now offered by certain industries to the introduction of the metric system. No one supposes that by making the metric system compulsory after a period of years the people as a whole would think in terms of metric units. Local denominations of fractions and multiples of such units are commonly used in all countries where the metric system has been adopted, but they do not interfere in the slightest degree with the larger transactions of trade and commerce.

If the Government adopted the metric system as the sole legal system in all its Departments, and announced that after a particular date all specifications for its work would have to be expressed in terms of that system, a great step would be taken towards its general use. This course and the publication of all official trade statistics in metric terms would lead to similar action by municipalities, railways, and other corporations, and promote the voluntary adoption of metric standards by the trading community generally.

Lamarckism Unashamed.

Initiative in Evolution. By Dr. W. Kidd. Pp. x+262. (London: H. F. and G. Witherby, 1920.) 15s. net.

FOR more than twenty years Dr. Walter Kidd has interested himself in the arrangement of the mammalian hair, and pondered over its significance, especially in relation to theories of evolution. He has shown that definite patterns due to the diverse lie of the hair are of common occurrence, that they are subject to change, and that they are hypothetically interpretable on Neo-Lamarckian lines. Whether one agrees with his interpretations or not, one must thank him for a very enjoyable book, written with whimsical humour and with a delightful urbanity in controversy. One admires also the candour with which Dr. Kidd states and seeks to dispose of some serious criticisms brought against his position as expressed in previous books.

A study of the lie of the hair on a cow shows great definiteness; thus it slopes first backwards and then forwards on the neck; behind a whorl over the shoulders it slopes backwards again; along the middle line of the upper part of the tail there is a streak of hairs at right angles.

"Arrangements of its hair so audacious as these need explanation, and it is found in the mode of life of the cow. So large a part of its daily life is spent in the business of grazing with her muzzle close to the ground, during which the neck of the animal is constantly stretched downwards from the back at the level of the shoulders, that the skin, which is very loose in this and most other portions of its body, is dragged upon to allow of the extreme flexion of its neck. This traction is for all this time acting against the normal or backward slope of the hairs, and has given rise to this victory of a new force through a thousand generations. It is equally clear that a mechanical explanation of the line of erect hairs on the first nine or twelve inches of the tail is forthcoming, for one has only to watch a cow standing on a hot day, undergoing her torment of flies, to see it writ large. . . . It is hardly necessary to point out how the underlying muscles would drag upon the skin of the tail over them and gradually reverse more or less the 'lie' of the hairs."

Similar interpretations, often very ingenious, abound in the pages of Dr. Kidd's book. There is an unusual pattern of hairs on man's back; it is to be correlated with his ancestors' habit of sitting with their backs against the side of the cave, or sleeping with their heads raised on some sort of pillow. From between the eyes of a cat the hair on the broad snout slopes downwards, but on a dog's snout it slopes upwards; this is put down to the fact that the dog rubs his head on the

sward from the front of the snout upwards, while the cat dresses her snout downwards with her paw. We should think this was a *hysteron proteron*—the cart before the horse. The dog has on his chest a reversed area of hair—spreading out on each side. "When lying with his head supported on his paws the lower part of his chest is closely applied to the upper or flexor surface of the fore legs, and the long-continued pressure of the latter against the downward or normal streams of hair on the chest leads to its slope being reversed." The downward slope of the shaggy hairs of the two-toed sloth, that spends so much of its time upside down below the branches, is to be attributed to the action of gravity upon the long hairs. We wonder that the author does not allude to the downward pull which the coating of green Algæ on the hairs must involve!

The factors recognised by Dr. Kidd in the formation of hair-patterns are four: friction, pressure, gravity, and underlying muscular traction. His thesis is that changes in the conditions of life—*e.g.* in modes of locomotion and in attitudes of rest—have directly brought about modifications in the lie of the hair, and that these modifications have been cumulatively entailed on the race.

"Initiative in animal evolution comes by stimulation, excitation, and response in new conditions, and is followed by repetition of these phenomena until they result in structural modifications, transmitted and directed by selection and the laws of genetics—a series of events which agree with Neo-Lamarckian principles."

Now it is familiarly easy for Lamarckians to interpret structural peculiarities as the outcome of transmitted exogenous modifications (the direct somatic results of peculiarities in function, habit, nutrition, and environment), and Dr. Kidd is much too thoughtful an investigator to be content with mere interpretation. He brings forward evidence to show that the lie of the hair can be modified in the individual; he also brings forward some evidence to show that parental modifications may reappear in the offspring. Speaking frankly, we do not think the evidence is strong, but it is progress to have any evidence at all.

As regards individual modifications of the hair-pattern, reference is made to the way in which the peculiar functioning of the muscles in the vicinity of the human eyebrow alters its shape and character.

"It is shown by numerous examples in the human eyebrow that the muscles underneath the hairs which are embedded in the true skin for a tangible depth, do play havoc with the normal arrangement of hair, as the conflict proceeds, the resultant 'pull' being actually engraved, signed

and sealed by physiological wrinkles of the forehead and face."

It may be so, but one must tread warily. There are individual idiosyncrasies in the eyebrows hinted at very early in life, long before the time of wrinkling, which become emphasised when the eyebrow hairs grow longer, as they so often do in later life. First catch your modification.

A little more cogent, it seems to us, is the chapter on the modifications in the hair-patterns of horses, modifications which can be traced to peculiarities of harness. Yet here again there is need for scepticism. One has to be sure that the peculiarities observed are not constitutional variations, quite independent of harness; and here one must go back in Dr. Kidd's book to the excellent treatment of the whorls, featherings, and crests that frequently occur on the horse's neck, most of which cannot, without great difficulty, be regarded as modifications. Moreover, one has to remember that in a hard-worked horse there may be a coercive reversal of the moist hair, which never gets a chance to right itself, and is not, therefore, a true modification which persists after the inducing factors have ceased to operate. As to the ten foals showing a reversed area or pattern on the under surface of their necks similar to that which their mothers showed, we wish to be sure that the maternal reversal was due to the collar. But of the value of collecting cases like this, even if they do not convince sceptics, there can be no doubt, and Dr. Kidd will be thanked by all biologists.

Dr. Kidd supports his case with facts relating to the formation of new bursæ under the stress of mechanical forces and to Pavlov's experimental production of new reflexes in the life of the individual, but he stakes his argument on the lie of the hair. His general position is that initiatives or new departures in evolution are direct answers to peculiarities in nurture (activity, rest, food, and environment), and that these answers are transmissible in a representative way which becomes cumulative, unless, indeed, selection intervenes. He coins the word "plasto-diëthësis," combining the metaphors of mould and sieve; the organism is moulded in some new way by peculiarities in function and environment, and the moulded organisms are sifted. "So the banners between Lamarck and Darwin are published, not for the first time of asking, and who shall say that there is cause or just impediment why these two should not be joined in holy matrimony?"

We suspect that the lie of the hair is fixedly determined by the slope of the hair follicle beneath the surface of the skin, and that this slope, though

adjustable temporarily by contraction of the smooth muscles associated with the follicle, is determined by old-established skin conditions—*e.g.* of muscularity, blood supply, and innervation. We should compare the general lie of the hair to the pterylosis in birds, and also, in kind, to the way in which the hairs of different mammalian types occur in distinctive or specific little groups, the members often differing in size. It may be that the vertically upstanding hair of the mole represents a primitive mammalian condition without any lie at all. Whether this be so or not, the lie of the hair is variable, as the study of the horse's neck suffices to show. These variations, comparable to variations in other skin-features—*e.g.* papillary ridges—may be the somatic expression of germinal variations, and it may also be that they are correlated with larger variations of a more obviously utilitarian character. We need not think of them as "anyhow" changes, but rather as more or less consistent with a harmonious viable constitution previously established. In any case, they are the cards put into the hands of the full-grown mammal—cards which he has to play, the result being the sifting out and survival of the "lies" most conformable with the creature's habits. But we cannot prove our Neo-Darwinian theory any more than Dr. Kidd has proved his Neo-Lamarckian one. Some may say not so much.

J. A. T.

Dyes and Dyeing.

Application of Dyestuffs to Textiles, Paper, Leather, and other Materials. By Dr. J. Merritt Matthews. Pp. xvi+768. (New York: John Wiley and Sons, Inc.; London: Chapman and Hall, Ltd., 1920.) 57s. 6d. net.

THE author introduces his subject with "Craft Dyeing," followed by a short history of dyeing. In discussing tie-dyeing (knot-dyeing), batik and stencil work—some of the earliest methods of producing coloured patterns on fabrics—he makes the rather interesting suggestion that craft dyeing should be encouraged, as the field for it in America is a broad one, because in it "we have the possibility of reaching into realms of colour art that is not present in ordinary trade dyeing." As in the author's former work, "The Laboratory Manual of Dyeing and Textile Chemistry," each chapter is followed by instructions for carrying out experiments relating to the processes described. These should be of considerable assistance to students in technical colleges.

Chap. ii. deals with the scouring of textile

fibres. In this an illustration is given of what purports to be an "Open Kier for Treating Cloth with Caustic (H. W. Butterworth and Sons Co.)," which, however, is not a kier, but the preparing and batching arrangement employed in impregnating the fabric prior to boiling in the open-width Jackson kier. The kier proper has been omitted. On pp. 136-37 the author describes the preparation of sodium hypochlorite by passing chlorine gas into caustic soda or soda ash. Bleachers in this country will be interested to hear that "this method of bleaching has come into very extensive use in the United States."

Under "Representative Acid Dyes" (chap. viii.), a "Nomenclature of Dyestuffs" is given. We agree with the author that as regards dyestuffs his task in bringing the information up to date must have been one of considerable difficulty. He is to be congratulated upon this part of the work, and we think he has acted wisely in that he "has deemed it advisable to retain the names and the dyestuffs that were well known before the war, and which could be easily and intelligently recognised in the industry all over the world." The alphabetical list of trade names of the various groups of dyestuffs, in which the class to which each belongs and the manufacturer are given, and the list of the principal dyestuff manufacturers, will be found very useful indeed. A very complete list of all the principal dyestuffs, arranged according to shade, is also given.

In the following chapters the stripping of colours, the testing of the fastness of dyes, and the application of the various artificial and natural dyestuffs are discussed. This is followed by a brief description of the mineral colours, and in the next chapter (which should have been numbered xxiii.) by "Dyeing of Fabrics containing Mixed Fibres." In this some very useful tables showing the affinity of a number of dyestuffs for different fibres are given. The dyeing of other fibres, including linen, jute, and artificial silk, is referred to very briefly. Cellulose acetate silk is not mentioned.

The theory of dyeing is outlined in chap. xxv. It is to be regretted that in this chapter only three references to the literature are given. The name of one of the investigators mentioned should read "Vignon."

The author has compiled an extensive bibliography. The value of this would have been considerably enhanced if references to it had been given in the text. This is an unfortunate omission which it is hoped the author will rectify in a new edition of the work.

The volume contains 303 illustrations of machinery in use in the various operations, but few of these, comparatively speaking, are of American origin. Some of the illustrations which are given in diagrammatical sections are of value to the student, whilst many, which are simply pictures, convey little or no information as regards working details. In a few cases only are the machines fully described in the text.

Forty-one pages are devoted to the dyeing of about twenty-five different materials, including leather, paper, furs, feathers, foodstuffs, etc. In this the author has made an attempt to cover a very wide field indeed, but, as stated in the preface, he has been able to give only "a brief survey of these interesting fields." Some of the information given should, nevertheless, be of value to workers.

In a short review such as this it is unfortunately impossible to discuss the contents of the volume more fully. The book certainly deserves the attention of those interested in the dyeing of textiles and other materials. The amount of information which it contains is very considerable, and it is, therefore, safe to assume that at least some parts of its contents will appeal to every reader.

J. HUEBNER.

Time and Space.

The Absolute Relations of Time and Space. By Dr. A. A. Robb. Pp. ix+80. (Cambridge: At the University Press, 1921.) 5s. net.

IN 1914 Dr. Robb published a work entitled "A Theory of Time and Space." Bearing in mind the circumstances of that year, it is not surprising to find that the book did not attract a notice commensurate either with the intrinsic importance of the subject or with the novelty of the views propounded in it. The short work bearing the above title is introductory to the larger work, and contains a concise statement of the main results embodied in it. The treatment is very different from that of Einstein. In Einstein's theory the emphasis is laid exclusively on the idea of the "relativity" of experience. Dr. Robb, on the other hand, postulates as the basis of his theory an *absolute* relation—namely, the relation of "before and after." Not only does this relation serve as a physical basis; it is also the foundation on which he builds a goodly structure—his purely geometrical theory of time, of which the theory of space forms a part.

In the first section, devoted to preliminary considerations, the author shows by simple illustrations the difficulty of giving precise meanings to

apparently simple concepts such as the equality of lengths, and makes clear the close interdependence of time and spatial measurement. The keystone of his work is to be found in his treatment of the problem of identifying the same instant of time at two distinct points of space. In Einstein's theory each observer carries his own local time, and events which are simultaneous to one observer are not necessarily so when compared by the local time of another. Rightly dissatisfied with this view, the author adopts the bold point of view contained in the statement that there is no identity of instants at different places at all. In his own words, "the present instant, properly speaking, does not extend beyond here." It follows, then, that the complete specification of an instant of time requires the use of four co-ordinates (x, y, z, t).

The author then develops, by means of a system of twenty-one postulates, his four-dimensional geometry of time, and this development is characterised not only by a high degree of originality—particularly evinced in his novel and striking concept of conical order—but also by much skill and insight. Elements of time forming a system characterised by conical order, the spatial aspect, explicitly introduced in postulate v., becomes a direct consequence of this order. Analytically, after co-ordinates have been introduced, the theory leads to Einstein's restricted relativity. The work is a most valuable and original contribution to a very abstruse and difficult subject. More satisfactorily grounded than Einstein's theory, its far-reaching results merit the closest study, not only from the physicist, but also from the geometer. To the latter, indeed, it makes a strong appeal, since, as the author points out, the simple asymmetric relation of "before and after" appears to have important advantages over the concept of "linearly between" which has hitherto been mainly used as a basis for systems of geometry.

J. F. T.

Our Bookshelf.

L'Alimentation et L'Élevage Rationnels du Bétail. (Opinions du Prof. A. Mallèvre.) By J. E. Lucas. Pp. 466+49 (Paris: Librairie Lefrançois, 1920.) 18 francs.

THE lives of most men of science are divided between teaching and research; he is indeed fortunate who can harmonise the duties. The late Prof. Alfred Mallèvre, whose premature death in 1916 deprived France of a brilliant teacher and keen investigator, seems often to have regretted that his professorial duties left but little leisure for research, and it is sad to read, in the eloquent notice of his career by M. Georges Wery pre-

fixed to the volume before us, that the Agronomic Institute at Joinville-le-Pont obtained suitable laboratory accommodation only when Mallèvre was nearing the end. His devotion to duty did, however, reap the reward of enthusiastic pupils who have introduced scientific methods into fields which they might not otherwise have reached; M. Wery specially refers to the fruitful collaboration between Mallèvre and M. J. E. Lucas, whose notes of his professor's lectures have been published. The book is indeed a clearly and practically written treatise on the physiology of animal nutrition suitable for any intelligent student in a school of agriculture.

The first eight chapters deal with the general principles of the subject, and cover ground fairly familiar to the student of general animal physiology. Mallèvre was a definite adherent of the isodynamic school, and subjected Chauveau's experiments to searching criticism.

Chaps. ix. and x. are of particular interest to the farmer, and Mallèvre's tables, based upon Kellner's methods, should be of great use.

In the chapters which follow, the effects of exercise, environment, and heredity upon farm animals are considered, and the work concludes with a short, but clear, account of methods available for the protection of stock against infectious diseases.

Had the author himself lived to publish a textbook, he would probably have devoted rather more space to recent work upon accessory food substances, and perhaps have made more use of American work on calorimetry. The chapter on heredity also needs some revision. These are, however, minor points; taken as a whole, the book is well adapted to the purpose for which it was designed.

Rapid Methods for the Chemical Analysis of Special Steels, Steel-making Alloys, their Ores and Graphites. By C. M. Johnson. Third edition, revised and enlarged. Pp. xi+552. (New York: John Wiley and Sons, Inc.; London: Chapman and Hall, Ltd., 1920.) 36s. net.

THE number of elements employed in the manufacture of alloy steels appears to be ever increasing, and to it there have been added, during the last few years, cobalt, uranium, zirconium, and cerium. Accordingly, a new edition of the above work, embodying the latest American practice in the analysis of such steels and of the alloys used in their production, is very welcome.

Amongst other features which the one hundred pages of new matter contain are: A new and original method for the determination of sulphur; the partial separation of iron from such elements as vanadium, uranium, zirconium, and aluminium by a process which dispenses with the "ether separation"; important modifications of older processes; illustrated descriptions of new forms of laboratory appliances; and a chapter on micro-graphic analysis.

Repetition of unnecessary details and more than a few obvious mistakes betray a somewhat hasty preparation, and, moreover, the arrangement of the whole subject-matter leaves much to be desired, though the last defect is remedied to some extent by a good index and numerous cross-references. Steelworks' chemists, at any rate, will doubtless overlook deficiencies of this nature in a book which emanates from such a trustworthy, experienced, and original worker as its author.

Stones and Quarries. By J. Allen Howe. (Pitman's Common Commodities and Industries.) Pp. x+137. (London: Sir Isaac Pitman and Sons, Ltd., n.d.) 3s. net.

MR. HOWE is specially qualified among geologists by his economic studies at the Jermyn Street museum for writing a book on stones and quarries that will interest the general reader. Such readers constitute the bulk of intelligent persons, who prefer to understand what they meet with on their travels and are not content with mere wonder at the wealth of the earth and the ingenuity shown in its exploitation. Mr. Howe begins by showing the æsthetic feeling for cut stones among the Egyptians 7000 years ago, and the gradual development of carved and polished work by race after race, down to the cathedral builders of western Europe. "Porphyry," by the by, was practically unknown to the Egyptians, and one would scarcely gather, from the associations ascribed to it on p. 3, that the Taj Mahal was a work of the seventeenth century. Two felspar formulæ on p. 10 have escaped proof-correction, but these are only trifling criticisms. The numerous views of quarries in active operation, and the description of the machines used, open up a new and healthy field before the professional petrologist. The use of columnar basalt for road-sets in Italy and for the retaining walls of canals in Holland might be added to Mr. Howe's instances of the applications of rock-structure to human needs. G. A. J. C.

The Chemistry of Synthetic Drugs. By Dr. Percy May. Third edition, revised. Pp. xv+248. (London: Longmans, Green, and Co., 1921.) 12s. 6d. net.

VERY few changes have been made in this work since the first edition, reviewed in NATURE for September 21, 1911, was published. The third edition, which is now issued, follows closely on the heels of the second, and, indeed, the publication of information gained during the war in the chemistry of poisons, irritants, etc., appears to constitute the greater part of the alterations which have been made. The poisonous nature of most poly-nitro-compounds has been completely established, and new facts relating to other toxic substances, such as phosgene and mustard gas, which were used by the belligerents are recorded. The volume will no doubt be found extremely useful by those engaged in the manufacture of synthetic drugs.

Letters to the Editor.

[The Editor does not hold himself responsible for opinions expressed by his correspondents. Neither can he undertake to return, or to correspond with the writers of, rejected manuscripts intended for this or any other part of NATURE. No notice is taken of anonymous communications.]

Earth-worms, Mud-worms, and Water-worms.

I GATHER from various correspondents that the word "earth-worm" requires some elucidation if we are to avoid misconception. I venture to submit the following statement. The Chætopoda, or bristle-footed worms—often called the "Annelids"—form one of the three large branches of the phylum Appendiculata. The Arthropoda (= Gnathopoda) and the Rotifera are its two other branches. The Chætopoda are divisible into the class "Polychæta" (all marine) and the class "Oligochæta"—containing very few marine forms, and inhabiting either the slime and mud of fresh-water pools and streams, or the loose, damp "humus" or "earth" of the land-surface.

I think that the opinion expressed by Mr. Coste (in his valuable letter in NATURE of May 19, p. 360), to the effect that "the moist surface" of worms inhabiting the soil "must, when underground, frequently or usually be in contact with other moist surfaces, so that the worm is, in effect, partly immersed in water," involves a mistake as to the condition of the earth thus inhabited and the size of the burrow made by the worm. The earth inhabited by earth-worms is *not* slime or mud, and does not fit closely to the worm's body as would a semi-liquid mud or soft clay. It is, on the contrary, a loose aggregation—the solid particles of which are largely separated by atmospheric air—and the worm's body does not fit tightly to the walls of its burrow, although a mucous exudation from the worm's surface is often deposited on those walls. An earth-worm in movement is continually changing its dimensions—elongating and becoming narrow, shortening and becoming wider. Hence there is no "immersion" of the worm's body in liquid or semi-liquid material. On the contrary, air has continual access to the worm's surface through the porous soil; and the change in its diameter and its movements must cause the movement of the air in the space between the worm's body and the wall of its burrow. It seems to be necessary to bear in mind the distinctive physical features of the earth or surface soil in which the earth-worms make their burrows—as contrasted with either the water or the mud—practically a liquid—in which other Oligochæta pass their lives.

The Oligochæta are divided into four orders, namely, the Naidiformia, the Sænuridiformia, the Lumbriciformia, and the Hirudiniformia (or leeches). The first of these is a very distinct group inhabiting fresh-waters (only two British species are marine). They are much smaller in size than the others, and are characterised by young forms which reproduce abundantly by bud-fission, and are succeeded by a distinct adult sexual form. The Sænuridiformia and the Lumbriciformia are closely allied—the former being as a rule smaller, more elongate, and more agile in movement than the latter, and less familiar to the inexperienced observer. They inhabit fresh-waters (a few only are marine) and the mud or slime of fresh-water pools of brackish estuaries and of sluggish streams, whilst the Lumbriciformia are large worms with opaque, thick body-wall, which forcibly burrow in loose, air-holding earth, and have,

as a rule, a close resemblance to our common earth-worm in shape, colour, and habits. The larger Sænuridiformia, such as *Lumbriculus* and *Phreocorytes*, have the brown-red colouring of earth-worms, and, although differing in shape and movement from Lumbriciformia, are liable to be mistaken for young earth-worms when appearing, as they sometimes do in great number, in the reservoirs and mains of water-supplying companies.

The Lumbriciformia comprise a great number of genera distinguished by peculiarities of their reproductive apparatus, their renal organs (nephridia), and the gizzards and other parts of the digestive canal. They have as a rule a specially rich supply of blood-vessels to the integument which serves as a respiratory organ. This special blood supply is not present in the Sænuridiformia, which have, however, well-developed, deeper-lying vascular trunks holding hæmoglobinous fluid.

The word "earth-worm" is often applied to the whole group of Lumbriciformia, which are contrasted as "Terricola" with the Sænuridiformia, for which the term "Limicola," or "mud-dwellers," is used. There are good reasons, however, for limiting the word "earth-worm" to the common English earth-worm, *Lumbricus terrestris*, and the few closely allied species of Lumbricus. Those reasons come to our notice when we are considering the possible drowning of the common earth-worm and the respiratory conditions connected with that mishap. They are, first, that a whole family of Sænuridiform worms is known—the Enchytræidæ—which are *not* water-dwellers or mud-dwellers (Limicola), but live in humus and amongst dead leaves, and are, in fact, just as much "Terricola" as are the commoner Lumbriciformia. And, secondly, there are at least two genera classed with the Lumbriciformia which live, *not* in the earth, but in open water. One of these is the *Criodrilus lacuum* (occasionally found in England, but common in Central Europe), which has the appearance, size, and inner structure of the Lumbriciformia—and, indeed, is a close ally of Lumbricus; and the other is the *Alma nilotica* or *Digitibranchus niloticus*, which not only lives entirely in the water, but is also provided with a series of filamentous, naked branchiæ containing a blood-red vascular fluid. I am not able to state whether *Criodrilus* has or has not a tegumentary blood supply. It has not, I think, been studied from this point of view. There is no full account (so far as I can ascertain) of the structure of *Alma nilotica*, nor have illustrations of its anatomy been published, though systematists have given brief accounts of this and allied species.

I think, then, that it is clear that we must not extend the implications of the word "earth-worm" when discussing details of structure and physiological adaptation beyond the particular species which has been the actual subject of study. In writing here of the drowning of earth-worms I have intended my statements to apply only to the common British earth-worms called *Lumbricus terrestris*. Probably they are true of many other Lumbriciformia, but that is only a supposition which must be tested and must not be held as fact until proved by further examination to be so.

E. RAY LANKESTER.

P.S.—I find that Vejdowski has described a rich network of capillary blood-vessels in the integument of *Criodrilus* (a Lumbriciform), and that in *Limnodrilus Hoffmeisteri* (a Sænuridiform) he has found capillaries in small groups of four, ending blindly in the epidermic cell-layer. Such capillaries in the integument are, he says, absent, as a rule, from all Oligochæta except the Lumbriciformia.

E. R. L.

Biological Terminology.

I THINK Dr. Bather (*NATURE*, May 5, p. 301) and I may be using our words with unlike meanings, but he raises an important point. To use my own meanings: we describe when we say what a thing is like; we interpret when we account for it. Both these processes imply classification (*i.e.* identification); both are necessary in science; one is not superior or inferior to the other; but they are different. In description we classify facts and objects according to co-existences and resemblances. Thus, when we term a man a mammalian vertebrate we say, in effect, that in him *mammæ* and *vertebræ* co-exist, and that therein he resembles other animals. Is not all systematic zoology and botany founded on this kind of classification, a beautiful example of which may be found in the address of any letter sent by post—addressed to a man with a certain name, in a certain house, in a certain street, and so on? On the other hand, when we interpret we explain, we link cause with effect, we formulate suppositions, hypotheses, theories, we trace the connection between antecedents and consequents, we try to understand. Thus we class together such unlike things as the fall of apples, the rise of tides, the swing of the pendulum, and the motions of the planets by saying that they furnish instances of gravitation; we account for teeth and mental faculties by attributing their evolution to natural selection; we identify the blacksmith's muscles, mathematical and golfing skill, and acquired immunity against disease as results of functional activity. From the nature of the case there is little or nothing of this sort of thing in systematic zoology and botany.

Description and interpretation are the warp and the woof of science. The former must always precede the latter, for we cannot account for things until we know what they are like. Some sciences (*e.g.* mathematics and physics) are based on few facts. Thus all the facts on which geometry is founded consist of its axioms and some of its definitions. Necessarily, therefore, this science quickly passed in its evolution from description to interpretation, and its students in their mental development quickly tread the same path. Their main training is in interpretation. They have little knowledge of facts, but great skill in a particular department of thought. Other sciences (*e.g.* zoology and botany) deal with an enormous number of facts; ages must pass before they are at all adequately described, and every student must spend years in acquiring them. His main training, therefore, must necessarily be in description. He acquires a vast knowledge of facts, and, therefore, since he knows what to look for, becomes a trained observer. A mathematician may be an excellent observer, but this skill does not necessarily flow from his specific training. Indeed, it is remarkable within what narrow limits his skill may avail him—just as training in a game (*e.g.* golf) may develop the student's skill only in that particular game. Similarly, though any zoologist or botanist may be a skilful interpreter, skill of this kind does not necessarily flow from his specific studies. This is all that I meant by the statement to which Dr. Bather takes exception.

Man is the educable animal, but he is also the forgetting animal. The things he particularly tends to forget are facts. The things he tends to retain are mental habits, among which are dexterities in thinking and doing. These dexterities, learned slowly and with toil, are even more slowly lost—as in the case of the mathematician and the cricketer. As a school-boy I received some training in mathematics; to-day the mathematical books in my library are nearly use-

less to me. Some part of them is at my fingers' ends; the rest I cannot understand. As a medical student I had to cram for examinations what seemed an enormous number of facts about botany and zoology. Almost all that is lost, but I can recapture any of them by reference to my books. Evidently it is sometimes better to teach good mental habits than to impart mere knowledge. No attempt was made to account for the facts of natural history to me (to train me in interpretation), but, fortunately for my future pleasure and interest in life, I had antecedently read Darwin. I doubt whether any of my contemporaries were as lucky. I do not know whether teaching has improved since my day; but this I do know, that while the facts of interpretative biology are abundant, its hypotheses innumerable (more than two hundred explanations of sex alone have been formulated), and its controversies unending, it has, unlike physics, for instance, next to no established truth. I know also that its terminology is so loose that it is often used with no meanings or with contradictory meanings, that its hostile sects ignore one another's evidence, and that all sects unite in ignoring evidence derived from other sciences. There is, in fact, no general use of crucial testing, which is the only means by which people of divided opinions can reach a common platform and hypotheses be examined in the light of all the evidence. I know besides that it is harder to interest biologists in the big question of biology, or in any questions not purely sectarian, than it is to interest anyone else.

This question of crucial testing is important. Probably it lies at the root of most of the troubles of interpretative biology. Given crucial testing, not only would all the relevant facts be brought into court and hypotheses be proved and, if correct, established, but also the necessity for a correct terminology would become clear. Dr. Bather will perhaps forgive me if I become tedious in stating elementary, but neglected, truth.

Proof of a descriptive statement is furnished by the facts on which that statement is founded. Thus, to establish the truth that man is a mammalian vertebrate it is only necessary to indicate the breasts and the backbone. On the other hand, an hypothesis can be proved only by fresh, unlike, crucial facts—facts of such a nature that every alternative supposition is shown to be inconceivable as true. "When the hypothesis of itself, and without adjustment for the purpose, gives us the rule and reason of a class of facts not contemplated in its construction, we have a criterion of its reality which has never yet been produced in favour of falsehood." For example, if I lost coins and supposed that Mary the servant had stolen them, I should be only guessing. But if, in addition, I planted marked coins and found them in her possession, I should have proved my case with a high degree of probability. Outside biology all interpretative science is founded on adequate crucial testing—which implies an acceptance of the maxim that all relevant and verifiable facts, no matter how collected (by direct observation, experimentally, statistically, and so on), are equal before science. Thus, in effect, Newton and his successors said to themselves: "If the theory of gravitation is true, stones must fall at certain rates of acceleration, tides must follow the moon, pendulums must swing in certain times, planets must trace certain orbits, worlds must assume certain shapes," and so on, until not only was the supposition established (by disproving alternatives), but also a universe of diversified facts has been brought within its range. Hence its importance. If to-day I said to physicists, "Your terminology is loose and your scientific methods four hundred years behind the times," what would happen? I think they would

take me between finger and thumb and eat me like a shrimp.

At least one great biologist, Darwin, tried to test his supposition with Newtonian candour and thoroughness. So far as I am able to judge, disbelief in natural selection is now felt only by people who decline to submit their opposing suppositions to a similar course of rigorous testing. But, to judge from literature, as a general rule, biologists seem to think that, as in description, the facts (or similar facts) on which an hypothesis is founded sufficiently prove the truth of it. Hence, in the lack of crucial testing, the chaos of opinions. Hence the rival doctrines and schools. Hence the unending controversies. Hence the absence of truth accepted by everyone. Hence the particular value set by this sect or that on evidence collected in this way or that, and the neglect of all other evidence. Hence, its inaccuracies undetected, the perpetuation of a loose terminology. Hence, for example, the two hundred explanations of sex. All these explanations must have been guesses; or, if one was fully tested and established, biologists have not recognised it. Biology is happy in the possession of vast and diversified arrays of facts suitable for crucial testing. Biologists are unhappy in that they do not use them. Their scientific methods are four hundred years behind those of physicists, and I suppose four thousand years behind those of mathematicians. I think all biologists must agree to this, if not as regards themselves, yet as regards the prejudiced adherents of rival sects. Crucial testing is the very soul of interpretative science. It is that which guides and controls the scientific imagination. But, as religious enthusiasts, politicians, and some men of science demonstrate, if you have not been trained to use it and submit to it, it is often nothing to you.

May I, by way of example, give one instance of what appears to me wasted opportunity? I choose a subject which does not seem to have gathered sectarian odium. It is not especially easy as biological problems go. I imagine every other problem now in dispute could be solved as simply if crucial testing were employed and its results accepted. Judging from embryos, some biologists have concluded that the individual in his development recapitulates the evolution of his race. On the same, or similar, evidence other biologists have reached a contrary conclusion. Both opinions are mere guesses, and, used in this way, the facts afford no opportunities for crucial testing. But consider them from another aspect. Consider the evolution of a structure—for example, an antler—in a line of individuals A, B, . . . Y, Z.

The first rudiments of the structure appear in A. The structure increases by progressive variations in B, C, . . . L, M. But B cannot produce his own variation without recapitulating that of A. C cannot achieve his development without recapitulating first A and then B. M cannot develop without reproducing in turn every ancestor up to A. To this point the development must necessarily have been an accurate recapitulation of the life-history of the race. But now N varies retrogressively—that is to say, he omits some part of the development, and therefore of the evolution. If N reverts to K, L and M disappear from future editions of the life-history, which thus becomes inaccurate. O resumes the progression. P interpolates a variation (e.g. the beginning of a tine) at the stage reached by F, introducing another inaccuracy. So the evolution continues until in Z the development, recapitulating not only some of the original history, but also many additions and subtractions, presents only a vague, inaccurate, foreshortened outline of the evolution—most vague, as

a rule, in its earlier parts, which have been most often repeated, and, therefore, subjected to most alteration.

There is a history in all men's lives
Figuring the nature of the times deceased.

This history is not told in words, but in graphic signs, in mimicry; and like a written history, copied by a thousand hands and altered to suit the times, it has become inaccurate.

To put the thing in other words: if the son copies with alterations the development of the parent, if the parent copied the grandparent, and so on up to the remotest ancestor—the unicellular represented by the germ—how is it conceivable that development can be other than a recapitulation, however inaccurate, of evolution? But inconceivability is not sure proof. It may result from the incapacity of the thinker. Turn, therefore, to crucial testing, for which facts are now available. If it be true that development is inaccurate and incomplete recapitulation, embryos should present the appearances, however vague, of ancient ancestral types. This is exactly what we find. Consider a butterfly. It begins life in the egg, where, quiescent and sheltered, it develops in an environment very unlike that in which the ancestral prototypes struggled for existence. At this stage, therefore, recapitulation should be much altered, vague, rapid, foreshortened, a mere scaffolding. The caterpillar must fight actively for existence in an environment which probably resembles closely that of its prototypes. Probably, therefore, the animal itself closely resembles its prototypes. It increases in bulk, but otherwise changes little. Quiescent and sheltered, a chrysalis, on the other hand, alters rapidly and enormously except in bulk. In the butterfly development has ceased. In man, sheltered and quiet in the uterus, there undergoing vast changes, but afterwards altering little save in bulk, development pursues the same lines. So also in every other type of multicellular being. Consider how sheltered is the development and how rapid the recapitulation in the seeds of plants, and how small, relatively, are the subsequent alterations, except in bulk.

If anyone can now think of development as other than recapitulation, he is capable of an intellectual feat beyond my powers. If I am right, I have furnished evidence that it is possible to solve even the more difficult biological problems by paying attention to the ordinary rules of scientific procedure. If I am wrong, biologists should, like the physicists, be able to eat me like a shrimp.

Here is a significant thing. No man of science, not a biologist, who knows the facts and has read what I have written will ever again be able to conceive of development as other than recapitulation; and often, when he thinks of a seed, an egg, an embryo, or a chrysalis, he will wonder what æons are being traversed within these amazing time machines—the "resting stages" of the biologists. But no biologist will be interested or will alter his antecedent opinions a hair's-breadth. He will merely be shocked at the impudence of one who is neither a botanist nor a zoologist. G. ARCHDALL REID.

9 Victoria Road, Southsea.

The Great Sun-spot Group and Magnetic Disturbances, May 8-21.

ON May 8 there appeared on the sun's eastern limb an equatorial sun-spot in a region which has been without disturbance for some considerable time. It was an active spot which had separated by May 12 into two large spots. The maximum area of the group was 16.5, in units 1/5000 of the sun's visible disc, and this was attained on May 14. The leader spot of the group was a composite spot containing two umbræ.

Its mean heliographic co-ordinates on that date were latitude $+1.4^\circ$, longitude 6.4° . The following spot was a large single spot, and its co-ordinates were latitude 0.2° , longitude 358.8° . The whole group extended over 12° in longitude and about 6° in latitude, so that a considerable area of the sun's surface was disturbed.

The mean heliographic latitude of the earth during the passage of the group across the sun was -2.8° . Therefore, not only was there a large active sun-spot on the sun, and with the penumbral character which frequently marks spots associated with magnetic disturbance, but also the earth was very favourably situated with regard to it. Under such conditions a great magnetic storm is inevitable.

With regard to the registration of the movements of the needles during the series of magnetic disturbances, we were greatly handicapped by the non-arrival of our usual supplies of sensitive photographic paper. Even so, on the less sensitive paper we were obliged to use the records were very remarkable. As early as May 11 the D (declination) magnet was affected by some small rapid oscillations from 6h. 12m. to 8h. 12m. The next day, May 12, between 8h. and 10h., D was still more disturbed, while at 8h. 12m. H (horizontal force) showed a marked and rapid fall of 146γ .

A greater activity of disturbance began on May 13 with a "sudden commencement" at 13h. 12m. In D there was a rapid movement to east and west of extreme range 15° , and on V (vertical force) an increase, decrease, and rapid recovery, range 26γ , in about two minutes. This phase is somewhat unusual on V. Between 21h. 24m. and 21h. 36m. a rapid oscillation of D occurred, east, west, and east, range $28'$. At the same time V fell rapidly and suddenly 333γ , recovered for a few moments with a slight rise at 21h. 36m., and then fell so that the spot of light was off the recording drum. At 22h. 12m. it rose again rapidly 250γ . Just before midnight there were further active movements of D and of V.

The second and more intense phase of the storm commenced on May 14 16h. On D a series of oscillations occurred of increasing speed and amplitude until 22h. 22m., when there was a sharp eastward movement of $46'$. At the same minute there commenced a very rapid decrease of force in V of at least 461γ , the spot of light passing off the paper on May 15 0h. 24m., the magnet adhering to the arrests. It did not begin to give a record again until May 15 9h. 12m., when it had risen to its position before the rapid fall.

Meanwhile D was becoming more violently agitated until on May 15 0h. 45m. the spot of light passed off the drum in an eastward direction. This marked the commencement of the third, or most intense, phase of the storm, which lasted for about eight hours. The movements of D were so rapid that the paper used was not sensitive enough to register all their details. At 5h. 24m. the spot of light had reached the limits of record in the westward direction, so that the extreme range of D during the storm was greater than $2^\circ 9'$. It was not until 7h. 30m. that the movements had decreased in intensity sufficiently to be clearly legible on the curves. The spot of light was then east, and it rose west with a series of rapid oscillatory movements between 8h. and 11h., when it attained a normal position. The mean range of these oscillations was $20'$.

With regard to H, the trace after May 14 22h. 25m. and during the maximum phase is completely lost owing to the inferior sensitiveness of the paper. The record is resumed on May 15 7h. 30m. This agrees with D in giving the greater and greatest intensities of the storm as occurring between May 14 22h. 25m. and May 15 7h. 30m.

On May 16 D continued to be disturbed, particularly between 0h. and 11h., with a range of $47'$, the more rapid oscillations taking place between 4h. and 10h. This is a repetition as to time of the storm of the preceding day, though on a reduced scale. On H the activity was even greater than on D, the range being 329γ . On V the spot of light fell gradually, until on May 16 6h. 50m. it had passed off the paper. It came on again after about 12 minutes, and the magnet gradually resumed a normal position. The range was 410γ . The character of its trace was a long wave with superposed oscillations. During the storm the variations in V were extremely and unusually active.

Magnetically, May 17 was comparatively, though not actually, a quiet day, and May 18 was even quieter. Greater activity was resumed on May 19 20h., when the sun-spot, much reduced in disc-area, was approaching the western limb of the sun. Between 23h. and 23h. 46m. there was a well-marked peak-like movement on D, with a range of $58'$. H was not so much disturbed as D. But on May 20 23h. 5m. to May 21 0h. 5m. there was a movement on H of a similar peaked character to that of D on the preceding day. The range was 212γ . V, too, was again active, range 173γ , between May 19 21h. and May 20 3h. 30m. On May 20 14h. 30m. there was resumed activity on the magnets, with rapid oscillations on D and H and an increase of force in both H and V. The series of disturbances, constituting a storm of unusual duration, had not completely subsided until May 21 20h. A. L. CORTIE.

Stonyhurst College Observatory, May 27.

The Reparation Act and Scientific Research.

PROF. PARTINGTON'S letter (NATURE, May 26, p. 394) interested me, because some months ago I pointed out in NATURE how harmful any restriction of the importation of scientific apparatus would be to some scientific laboratories, and how unreasonable the claims of the English instrument-makers appeared to me. However, no one else wrote in support of what I said and several makers wrote against it (though carefully refraining from answering my criticisms), and I almost began to think that my experience might be unusually unfortunate and that other workers were not affected, especially as NATURE in certain leading articles supported the protection of "key industries." The Gilbertian "Reparation" Act is of later date, but instances of its working are supplied in the letters of Prof. Gardiner and Prof. Partington.

Now there is not the slightest hope that the weak influence of scientific workers will affect the plans of practical politicians and Civil Service officials, especially after the recent action of the Post Office when opposed by much more powerful interests. Nevertheless, I am surprised that none of the scientific societies has taken the action of ascertaining the feeling of its members on this question. They could then either repudiate the statements of the grumblers, of whom Prof. Partington may be reckoned one, or publish some manifesto which could be placed on record as a protest against the policy of protecting scientific apparatus at the expense of science.

It is reported that the president of the Society of Glass Technology, speaking on the restriction of importation of glassware, considered that "electric lamp bulbs should also have been included in the Bill," and I agree, as that might have attracted more public attention to the effects of the Bill.

J. S. DUNKERLY.

Zoological Laboratory, The University,
Glasgow.

The Cosmology of Dante.

By DR. J. L. E. DREYER.

THE study of the cosmological ideas set forth in Dante's great poem is of considerable interest, not only because it helps us to understand many parts of the poem which otherwise might appear obscure, but also because Dante is a faithful interpreter of the opinions about the construction of the universe which were prevalent in his day. In this respect he is unique among poets. In the present article we shall trace the origin and gradual development of the system of the world adopted by Dante, without entering on minute interpretations of particular passages.

The principal feature of this system is the arrangement of the universe in a series of concentric spheres with the earth in the centre (Fig. 1).

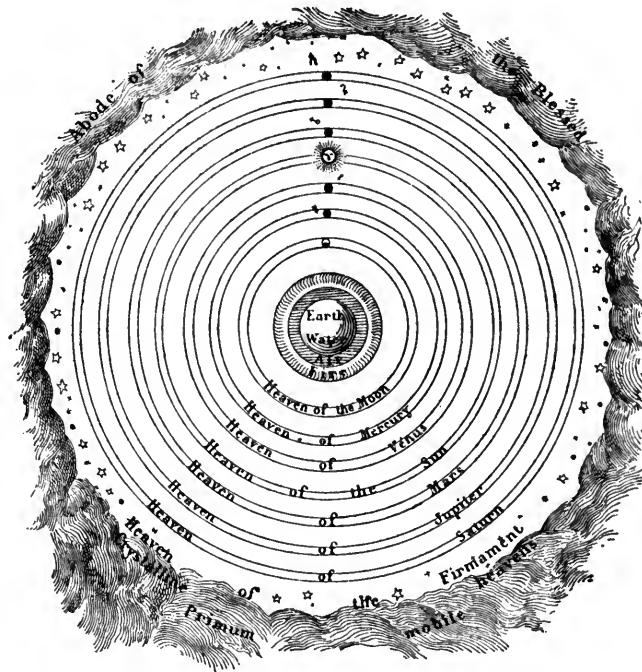

FIG. 1.—Dante's cosmical system.

This is a very old idea, originating in the most striking of all celestial phenomena, the rotation of the heavens in twenty-four hours from east to west. Eudoxus (about 370 B.C.) was the first to design a complete system of concentric spheres, arranged so as to account for this rotation of the heavens as well as for the principal irregularities in the motions of sun, moon, and planets in the opposite direction. Though Eudoxus was a great mathematician, his system of spheres could account only partially for the observed phenomena, probably because it was founded on an utterly insufficient number of observations of these phenomena. The system was much improved by Kalippus, and, what was of more importance, it was accepted by Aristotle. To him the spheres were not merely mathematical conceptions, but physically existing

bodies, kept in motion by the soul of each. Notwithstanding his great authority, however, this system was rejected by the astronomers of Alexandria, chiefly because it suffered from an incurable defect, that of assuming every planet to be always at the same distance from the earth. That this is not the case is clearly shown by the variable brightness of the planets, most strikingly seen in the case of Venus and Mars.

The increased number of apparent irregularities in the planetary motions revealed by steadily pursued observations led to the development of a system of the world which finally became known as the Ptolemaic system, because the last touches were put to it by Claudius Ptolemy in the second century A.D. It assumed a planet to move on a circle, the epicycle, the centre of which moved on a larger circle, the eccentric, near the centre of which the earth was situated. Additional refinements were added to account for observed minor irregularities. But all this, though very satisfactory to mathematicians, was not to the taste of many people, who could not accept all these circles as realities, but demanded some sort of a system of spheres, not necessarily concentric. To satisfy this demand it was suggested that we might for the epicycle substitute a small sphere, to the surface of which a planet was attached, while the sphere fitted in and moved between the surfaces of two concentric spheres, near the common centre of which the earth was placed. Ptolemy, who wrote a valuable text-book on astronomy (the "Syntaxis," generally known by the Arabic name "Almagest"), wrote also, for the weaker brethren, another, called "The Second Book of Phenomena," in which a complicated system of spheres is described. But this was never a success, and the Greek original is lost, so that the book was quite unknown to modern European readers until 1907, when a German translation from an Arabic version was at last published.

Among the Arabs we find an attempt to adopt material spheres in the cosmical system of the "Brethren of Purity," a semi-religious society which arose at Basra near the end of the tenth century. They taught that there are nine spheres of different thicknesses, fitting inside each other "like the skins of an onion." The ninth sphere is the prime mover, and turns in twenty-four hours. The eighth sphere is that to which the fixed stars are attached; it revolves in a very slightly longer period, lagging behind to the amount of one degree in a hundred years. This is supposed to account for the precession of the equinoxes. Saturn (the seventh sphere) lags more, and the motion becomes slower as we descend through the spheres, until we reach the first or slowest sphere, that of the moon, which takes

about fifty minutes more than twenty-four hours to make a complete revolution. In other words, all celestial motions take place in the same direction, from east to west. This is a very old idea, several times alluded to by Plato; but the denial of the independent eastward movement of the planets could not commend itself to any Greek astronomer who realised that the planets moved in orbits considerably inclined to the direction of the daily rotation. This was also the case among the Arabs, and no prominent advocate of a system of spheres appeared among them until the rise of the Aristotelian philosophy in Spain in the twelfth century revived the belief in spheres. Al Betrugi (Alpetragius) wrote a book on the subject, in which he also let all the motions be from east to west. But though he made some attempt to account for the most conspicuous irregularities of the planetary motions, his system is not to be compared with the Ptolemaic system as regards completeness, and it could be accepted only by people who were content merely with the rough outline of a system.

Early in the thirteenth century Arabian books on philosophy and science began to be known north of the Pyrenees, and along with them came the writings of Aristotle, translated long before from Greek into Arabic, and now from Arabic into Latin. As Aristotle, who very soon was accepted as an infallible guide, had adopted a system of spheres, one outside the other, it was very difficult for his Christian admirers to do anything else. During the whole of the thirteenth century there was a running fight between the adherents of Aristotle (or Alpetragius) and those who realised that no system of concentric spheres could ever account for the observed phenomena so completely as the Ptolemaic system of epicycles and eccentrics did. By the year 1300 the fight was in France fairly well decided in favour of the followers of Ptolemy. But in Italy the study of science had scarcely made any progress; Ptolemy's great work (though translated into Latin as early as 1175 by Gherardo of Cremona) was quite unknown, and only an extremely elementary text-book by Al Fargani was used in the universities.

should be persuaded of the truth of the doctrine of concentric spheres. Besides, this readily lent itself to poetic treatment, which a complicated set of circles could never do. There is no trace, either in the "Commedia" or in the philosophical treatise the "Convivio," of his having known the "Syntaxis" of Ptolemy. The chief source of his astronomical knowledge is the little text-book of Al Fargani, which he frequently quotes, and from which he occasionally borrows whole passages. In the "Convivio" he repeatedly makes use of the writings of the great scholastic, Albertus

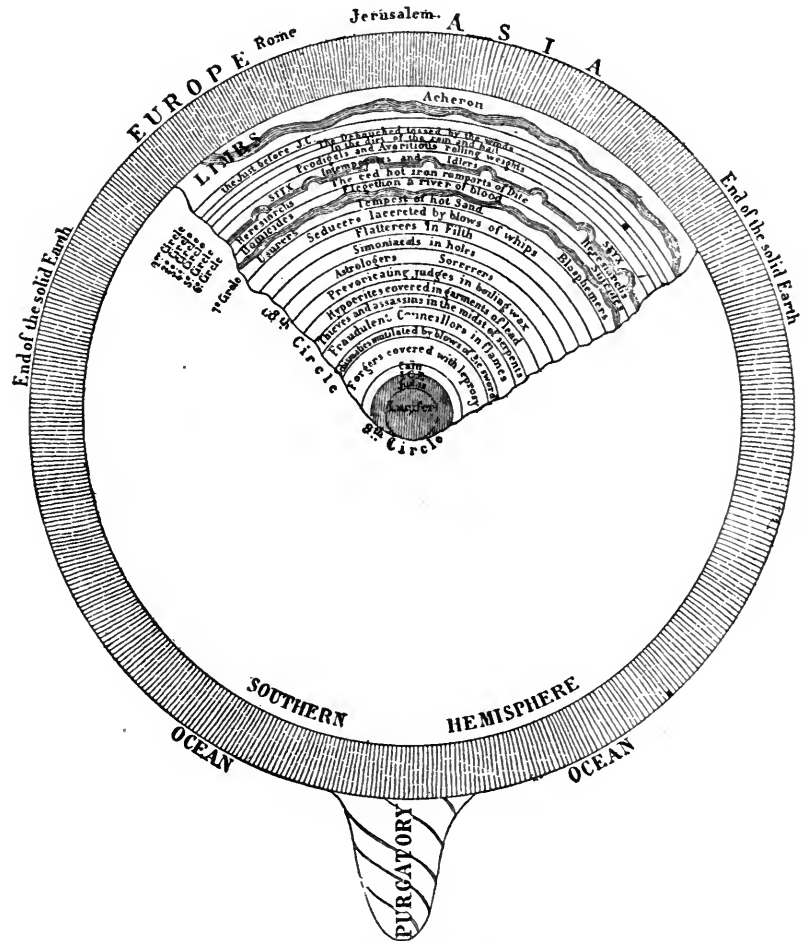

FIG. 2.—Dante's infernal regions.

Magnus. In contrast with several Italian writers on astronomy even long after his time, who often displayed great ignorance, Dante shows himself well acquainted with the general phenomena of the heavens. Thus he describes correctly the apparent motions of the stars as seen from the poles of the earth or from the equator; he often indicates the time of year by mentioning the zodiacal sign occupied by the sun; he even gives a fairly closely correct value of the length of the year.

In the centre of the universe is the earth, which is a sphere. These two facts were not disputed

by anybody. Hell is a conical opening reaching to the centre of the earth, where the devil dwells at the apex of the cone (Fig. 2). Among theologians this was generally accepted as the proper place for him. Even three hundred years later, when the motion or non-motion of the earth was the burning question of the day, the idea appeared very shocking to many that a body having the devil in the middle could be supposed to travel among the heavenly bodies, which were moved by angels. Purgatory is a large conical hill, rising out of the vast ocean at a point diametrically opposite to Jerusalem, the navel of the dry land. The heavenly spheres, ten in number, surround the earth, and they are repeatedly alluded to as being solid. In each of the first seven spheres spirits, though they have not their permanent abode there, appear to Dante in order to illustrate the gradually increasing glory which they have been found worthy to enjoy, and to indicate their former earthly characters, which had been chiefly influenced by one of the seven planets. The shadow of the earth reaches as far as the third sphere, and the spirits seen in the spheres of the moon, Mercury, and Venus have the lowest degree of bliss in the Empyrean.

The tenth sphere, the Empyrean, is the dwelling of the Deity. It is motionless, because all motion implies change and a desire for something better. The ninth, or crystalline, sphere is the prime mover, endowed with circular motion which expresses its praise of the Creator, and by its almost incomprehensible speed it shows the desire of each part of it to be joined to the Empyrean. The eighth sphere is that of the fixed stars; it has a very slow eastward motion of its own of one degree in a hundred years (precession), and transmits the daily rotation received from the ninth sphere to all the lower spheres. Dante seems, however, to have been somewhat uncertain about the source of rotation: in one place in the "Convivio" (ii., 15) he attributes both rotation and precession to the eighth sphere, though he immediately afterwards returns to his usual theory; and in another place ("Convivio," ii., 6). when speaking of Venus, he says that "whether the daily movement comes from some intelligence or from the onrush of the prime mover, God knows, for it appears to me presumptuous to decide." But these passages seem only to indicate some momentary hesitation between the conflicting statements of his sources. In the same way he is doubtful about the nature of the Milky Way, whether it is composed of stars or of vapour. He is particularly disturbed by the dif-

ference between the "new" translation of Aristotle (by Thomas Aquinas, from Greek) and the "old" one (by Michael Scot, from Arabic), but he inclines to the statement of the latter, that it is a multitude of stars.

The nine revolving spheres are moved by the three triads of angelic intelligences, the Seraphim as the highest in rank directing the ninth sphere, while the angels govern the lowest sphere, that of the moon. The planets were supposed to move in the plane of the ecliptic. There is no mention of the motion being eccentric, though Dante must have seen the account of the eccentric circles given in Al Fargani's book. But these were inconvenient things to believers in a system of spheres, and were better ignored. On the other hand, there are several allusions to epicycles; thus it is said in a paragraph in the "Convivio" (ii., 4) about Venus that on the circle of its sphere there is a small sphere which astronomers call an epicycle, "and though we say that there are ten spheres, this number does not comprise them all."

The last and lowest of the ten spheres is that of the moon. While the motion of Saturn is the swiftest, because this is most divine motion, that of the moon is the slowest ("Paradiso," iii., 51). The revolutions of all the nine spheres are therefore from east to west as supposed by some of the early Greek philosophers and by all the Arabian believers in spheres. As to the nature of the moon, and particularly of the surface-markings, Dante, in the "Convivio" (ii., 14), adopts a theory, due to Averroes, according to which the spots are caused by the rarity of some parts of the moon's body which do not reflect the sun's rays well. But in the "Paradiso" (ii. and xxii.) this is objected to, and the spots, which Dante, looking from above, sees only on the side of the moon nearest the earth, are said to be due to the light differing in various places under the influence of different angelic guides.

From the highest heavens to the lowest depths of the earth we find in Dante a faithful guide to the scientific ideas as well as to many popular prejudices of his time. Though the theory of spheres was during his lifetime defeated in France, an Italian may well be pardoned for not recognising this, particularly when we remember that even 200 years later two separate attempts were made in Italy to set up scientific theories of concentric spheres. To the student of the history of science it is a never-failing source of pleasure to find medieval cosmology so beautifully illuminated in the writings of the great Florentine poet.

The Natural History of Cultivated Plants.¹

CLASSICAL plant-names like *Μηδική πόνια* or *spina Arabica*, designed to indicate origin, do not always fulfil their object. Pliny's specific

reference to *milium intra hos decem annos ex India in Italiam invecum* has not obviated debate as to the home and the identity of his plant. Many notices of ancient crops connote only local cultivation.

Renaissance naturalists connected their culti-

¹ "Sino-iranica. Chinese Contributions to the History of Civilization in Ancient Iran, with special reference to the History of Cultivated Plants and Products." By Berthold Laufer. (Field Museum of Natural History Publication 201; Anthropological Series, vol. xv., No. 3.) Pp. iv+445. (Chicago, 1919.)

vated plants with those mentioned by classical authors. In medieval "mysteries" a "maple" replaced *συκόμερος*. This tendency outlived the finding of America. When the Peruvian "papas" reached Artois from Rome, Clusius asked if here were *ἀράχιδνα*. Nor did scholars always agree. When the "sunflower" was first described in 1568 it was compared by Dodoens with the "coronary" Bello, and by Cortuso with the "aromatic" *Laserpitium*.

The habit weakened as knowledge increased. But the history of cultivated plants was left to scholarship until R. Brown, in 1818, made it a branch of botanical geography. His "comparative view" of the esculent species reported by C. Smith and Lockhart during an expedition to the Zaïre dealt with the Guinea coast as scholars had treated the lands of the Mediterranean littoral. Necessity guided this action; Congo crops lie outside "letters." Alphonse de Candolle, whom Laufer calls "the father of the science of historical botany," explained in 1855 that the chapter on cultivated plants in his "Géographie botanique raisonnée" was partly inspired by Brown. In the "Origine des plantes cultivées" of 1883 the path Brown had opened up was again followed.

The results secured in 1855 by a botanist with historical instincts induced Hehn to ascertain in 1870 what scholarship guided by natural history tastes can accomplish. The limitations of "letters" were tacitly admitted in 1894, when Schrader, in his revision of Hehn's "Kulturpflanzen und Haustiere in ihrem Uebergang aus Asien," sought aid from an eminent botanist. Thiselton-Dyer has shown, when elucidating complex subjects like *ἄμπελος τῆς Ἰδης*, that the successful student of cultivated plants should be both an accomplished botanist and a polished scholar. Collaboration occasionally yields mosaic results; regarding Engler's notes on the "vine," Laufer remarks that "it is not botany but historical research that is able to solve the problems connected with the history of our cultivated plants."

Hehn's "Kulturpflanzen" discusses the migration of Asiatic crops to Greece and Italy. Laufer's "Sino-iranica" presents Chinese evidence regarding ancient Iranian rural economy. The two purposes induce differences in outlook and treatment. The method of Laufer deviates from that of Schrader and Engler much as that of Brown departs from the methods of Gesner and Clusius.

Laufer employs history so effectively as almost to condone the acerbity of his criticism of others. He teaches us that sinologues enjoy advantages denied to classical scholars, since Chinese notices of useful plants lend themselves to historical treatment more readily than Hebrew, Greek, or Latin allusions. The Chinese, Laufer concedes, have shown thought and common sense when trying likely exotic crops. Their long series of encyclopædias, sometimes in several editions, afford approximate dates for many plant-introductions. The culture and influence of China increased

gradually. If, like Rome, China suffered many invasions, she rarely succumbed to foes so destructive as the Vandal or so malignant as the Turk. Her civilisation remained little affected; the introduction of new plants never induced in China economic revolutions comparable with that experienced in Britain through the arrival of our staple root-crops.

Problems connected with the history of Chinese cultivated plants present familiar difficulties. Chinese records of introductions from Iran began two thousand years ago. The emperor Wu (140-87 B.C.) instructed General Chang-kien to fetch from Ferghana horses of the famed Iranian breed. Finding that these steeds thrive on "lucerne" (*Medicago sativa*), Chang-kien carried home seed of this crop. As the plant had been established in Greece four hundred years earlier, we have some assurance regarding the home of *Μηδική πύρα*. With *μηλέα Περσική* and *μηλον Ἀρμενιακόν* matters are different; "peach" and "apricock" are Chinese plants, and the Iranian gift of "alfalfa" was but a payment on account. Later history affords instances equally instructive. The "Langka mirich" (= Ceylon pepper) of Hindu husbandry is the American "chillie" (*Cap-sicum frutescens*); to English denizens in India the American *Physalis peruviana* is the "Cape gooseberry."

With "medick" Chang-kien carried back the "grape-vine" (*Vitis vinifera*). Although Han travellers noticed Iranian addiction to wine-drinking, the art of wine-making was not acquired until the later T'ang period. It was received from the Turks, who in Han days lived in Mongolia, where the vine does not grow; when they invaded Turkestan the Turks learned the use of grapes and wine from their Iranian serfs.

Between the arrival of grape-growing (120 B.C.) and that of wine-making (640 A.D.) China obtained many western crops. Later Chinese naturalists, thinking backwards, state that, along with "alfalfa" and the "vine," Chang-kien brought from Iran chives, coriander, cucumber, sesame, and other vegetables. Some appear to credit to him the presence in China of any plant the name of which includes the attribute "hu." Historical research shows that while "hu" usually implies western origin, it affords no absolute criterion; even when a "hu" plant is really from the west, it need not be from Iran. The English misconception that our "potato" originated in Virginia and was introduced by Raleigh shows that the "process of retrospective thought" is not peculiar to China. Western misapprehension may exceed Oriental; our "potato" (*Solanum tuberosum*) is not the "patata" (*Ipomoea Batatas*).

The period 200-400 A.D. saw the establishment of trade relations with Po-se in Nan Hai. In A.D. 461 an embassy from Po-se in Iran reached Wei. After this event products of the southern Po-se were sometimes thought to be western ones, while Persian plants were occasionally regarded as Malayan. Europe has had the same experience. The navigators who first made American

landfalls believed they had reached India; those who stayed at home sometimes mistook West Indian for East Indian products. The "gallopavo" (*Meleagris gallopavo*) came to Europe in 1541. Its French popular names—"dindon" and "dinde"—leave open the question of origin; the English popular name "turkey-cock" indicates a belief that the bird came from the East. The French do not, however, claim greater perspicacity because of this; when "maize" (*Zea Mays*) first appeared they termed this cereal "blé de Turquie"; we, with fortuitous caution, used the non-committal name "Indian corn."

One undoubtedly western introduction attributed to Chang-kien is "hwan lan" (*Carthamus tinctorius*). The biography of the general and the annals of the Han contain nothing to this effect, and this introduction cannot antedate Tsin times (200-400 A.D.). This plant, which was unknown to classical writers, is the Arabic "kurtum"; its dried flowers, the Arabic "usfūr," came to medieval Europe under the Italian trade-names "asfiore" and "saffiore," our "safflower." The Chinese confused this product with "yü-kin," our "saffron," the dried stigmas of *Crocus sativus*; the two were colloquially termed "hun hwa" (=red flower). One of the uses of the dried flowers of "hwan lan" provided the plant with the alternative name "yen-chi," and thus led to its confusion with an indigenous "yen-chi" (*Basella rubra*), tinctorial in all its parts. Matters were further complicated by the existence of Mt. Yenchi and by the homophony of the Chinese name "yen-chi" (=cosmetic) with the Hiun-nu word "yen-chi" (=royal consort). It is scarcely surprising that Chinese disquisitions on "yen-chi" are more remarkable for their graceful style than for their historical accuracy.

The natural history of European economic products supplies problems equally complicated. The Greeks gave σκορπίουρον, the inflorescence of which is circinal, the alternative name ἡλιοτρόπιον because it flowers at the summer solstice. They distinguished two sorts of ἡλιοτρόπιον—τὸ μέγα, found in dry situations, and τὸ μικρόν, confined to damp places. No Greek text asserts that the blossoms of σκορπίουρον open only in bright sunshine or follow the sun from morn until eve. In spite of this some Latin authors regard Heliotropium as one of the "helioscopia," while others include it among the "solsequia." The Aramaic equivalent of ἡλιοτρόπιον is either "somar yauma" (=day turning) or "smar yauma" (=day-turned), so that in Syria the plant identified with

that of the Greeks was one which the Romans, at least, would have included among their "solsequia." Arab naturalists identified "somar yauma" with the "tharanchul" of Andalusia. This Spanish "tornesol" (*Chrozophora tinctoria*) was in 1554 identified by Amatus Lusitanus with ἡλιοτρόπιον τὸ μέγα; in 1557 Clusius decided that it was ἡλιοτρόπιον τὸ μικρόν.

While our earliest records of *Chrozophora tinctoria* thus happen to be Iberian, Languedoc is the only region in which the economic product of the plant was ever systematically exploited. The Spanish name "tornesol" may therefore be, as we know the French name "tournesol" certainly is, only a local variant of the Provençal word "tornesola." Tournefort tells us that what we now know as *Chrozophora tinctoria* is the plant *ex qua paratur Tournesol gallorum* (=litmus) as contrasted with "Tournesol lusitanorum" (=cochineal). Pomet informs us that of the three distinct kinds of "French tournesol" known to commerce in the seventeenth century, only that termed "tournesol en drapeau" was prepared from this plant. The French term "tournesol," like the Chinese term "yen-chi," is therefore primarily the name of a commercial article colloquially transferred to the plant which yields it. The identification of "tornesol" with ἡλιοτρόπιον, propounded by two distinguished scholar-naturalists, teaches us that scholarship may prove as imperfect an instrument in solving problems connected with the history of cultivated plants and products as Laufer has found botany to be. Though both names are capable of conveying the same meaning, historical research shows that here "tournesol" involves a poetic comparison of the colour-change of an alterable dye with the hues of dawn and sunset, while ἡλιοτρόπιον supplies a prosaic intimation as to the season of the year at which a particular plant blossoms.

The difficulties which beset the conscientious study of European cultivated plants justify the remark made by T. Johnson in 1633 that "those that vulgarly impose names upon plants have little either judgment or knowledge of them." If the task of the historian of Chinese plants and products be less troublesome, this should lend support to the conclusion of Laufer in 1919 that "the Chinese were thinking, sensible and broad-minded people." However this may be, economic botanists of all nationalities will join to the penitence they feel for those shortcomings on their part which Laufer so unsparringly condemns a lively gratitude for the fund of information supplied by him in "Sino-iranica."

Obituary.

PROF. E. J. MILLS, F.R.S.

DR. EDMUND JAMES MILLS, formerly professor of technical chemistry in the West of Scotland Technical College, Glasgow, who died on April 21, was born in London on December 8, 1840. He received his early education at the

Grammar School, Cheltenham, and later at the Royal School of Mines, London. The chemical instruction for students at the School of Mines was in those days given at the Royal College of Chemistry in Oxford Street, and there Mills worked during the later 'fifties, having as a fellow

student Herbert McLeod, afterwards professor of chemistry at the Coopers Hill College, with whom he formed a life-long friendship. At that time the only institution granting degrees in pure science was London University, and Mills utilised his education at the School of Mines with the intention of proceeding to such a degree at a later period. He obtained his Bachelor of Science degree in 1863 and the Doctorate in 1865, his name appearing in the list of graduates at a date intermediate between those of Prof. Crum Brown in 1862 and Sir Wm. Tilden in 1871. In 1861 he went as an assistant to Dr. John Stenhouse, having Tilden as one of his colleagues in that laboratory.

In 1862 Mills was appointed one of the demonstrators of chemistry in Glasgow University under Prof. Thomas Anderson, his chief duty being the conduct of tutorial classes in connection with the medical curriculum. This particular duty was by no means congenial to Mills, and his own perfect knowledge of his subject made him somewhat impatient with the backwardness of the majority of first-year medical students; with advanced students, however, and in the laboratory, he was a good teacher.

Anderson was then working on the products from the destructive distillation of coal and shale, and when not engaged in teaching duties Mills assisted him in that work. This brought him in contact with several people in Glasgow, notably John Young and others, who were interested in the oil industry, which at that time was attracting considerable attention in the Lanarkshire and Lothian districts. The friendships made in these early days may have had some influence in inducing Mills to return to Glasgow, as he did at a later date, but in 1865 he resigned his position as demonstrator at the university and returned to London.

In 1870 Mr. John Young founded the "Young Laboratory" in Anderson's College, Glasgow, a laboratory intended by him to be associated essentially with technical chemistry. The first superintendent of this laboratory was W. H. Perkin, sen. (1870-71), followed by G. Bischof (1871-75); they were succeeded by Mills in 1876.

About 1886 the "Young Laboratory" together with Anderson's College was incorporated in the Glasgow and West of Scotland Technical College, and became the "Young Chair of Technical Chemistry." This appointment Mills held until his resignation in 1891.

Papers recording Mills's original work are published in the proceedings of the Royal Societies of London and Edinburgh, the *Philosophical Magazine*, and the journals of the Chemical Society and the Society of Chemical Industry in London. They are numerous and of a varied nature. His first paper, given to the Royal Society in 1860, was on bromo- and chloro-phenyl, but his early work dealt more with questions on the general principles of chemistry and inorganic chemistry, such as isomerism, electric attraction, chemical mass, and chemical equivalents. In the

Journal of the Chemical Society he published papers on aniline derivatives and nitrotoluene, potable waters, chemical repulsion, and melting points. From 1879-82 he published in four parts "Researches on Chemical Equivalents," "Investigations on the Action of Oxides on Salts," and in conjunction with Mr. Louis Campbell about 1879 "Researches on Dyeing." At a later period, on the foundation of the Society of Chemical Industry, he gave to that society papers on the quantitative estimation of oils and fats, viscosity determinations, and the oxidation of aniline. In the Proceedings of the Royal Society of Edinburgh he published researches on thermochemistry.

In the four small works which he published Mills did not confine himself to purely scientific subjects; in addition to two books, "Fuel and its Applications," in conjunction with E. J. Rowan, and "Destructive Distillation," he wrote a volume of poems, "My only Child," published in 1895, and "The Secret of Petrarch" in 1904.

After retiring from the professorship at the Glasgow and West of Scotland Technical College Mills returned to London, where he occupied himself with various pursuits, among them photography, which he had practised with considerable skill from early days. A certain deafness which overcame him during later years tended to increase a reserve of manner which Mills always possessed, but he continued until a short time ago to attend the meetings of the various societies to which he belonged, and was to be found regularly once a week at the Athenæum Club, where he met his more particular friends. He had a good knowledge not only of scientific, but also of general literature, and held some distinct views on religious questions; these, however, he never discussed.

Mills was elected a fellow of the Royal Society of London in 1874. He became a fellow of the Chemical Society in 1862, serving several times on the council, and as a vice-president from 1912 to 1915. He was an original member of the Society of Chemical Industry, and for a period president of the Glasgow and West of Scotland section of that society. He received the honorary degree of LL.D. from the University of Glasgow.

J. M. T.

DR. GEORGE FREDERICK WRIGHT, who died recently at the age of eighty-three years from heart failure following influenza, was, from 1881 to 1907, a professor in the Oberlin Theological Seminary, Ohio, and had been since 1884 the editor of a well-known theological publication, "Bibliotheca Sacra." His most important work, however, was done as a geologist, and his "Ice Age in North America," first published in 1889, remains a standard work on the subject. He wrote also on "The Glacial Boundary in Ohio, Indiana, and Kentucky," "Man and the Glacial Period," and "Greenland Ice-fields." At the invitation of the late Tsar of Russia Dr. Wright visited Siberia for

a geological study, the fruits of which appeared in 1902 in a two-volume work entitled "Asiatic Russia." The relations of science and religion were also discussed by him in several of his publications.

WE regret to announce the death, on May 28, at sixty-four years of age, of MR. R. E. DENNETT, author of "At the Back of the Black Man's Mind," "Nigerian Studies," "West African Categories," and other works.

Notes.

OWING to the postponement of the sailing of the *Celtic*, on which he had booked his passage from America, Prof. Einstein is unable to lecture at King's College, London, until Monday, June 13, at 5.15 p.m. All the tickets which have been issued for June 9 will be available for that date.

SEVERAL changes have recently been made in the scientific staff of the Australian Museum, Sydney. Dr. C. Anderson, who has been mineralogist since 1901, succeeds the late Mr. R. Etheridge, jun., as director. Mr. A. Musgrave fills the vacancy caused by the death of Mr. W. J. Rainbow, entomologist, and Messrs. J. R. Kinghorn and E. le G. Troughton, second-class assistants, have been promoted to be first-class assistants in charge of reptiles, birds and amphibians, and mammals and skeletons respectively.

MR. W. L. G. JOERG, of the scientific staff of the American Geographical Society of New York, and editor of its Research Series, left on May 21 on a six months' leave of absence for a trip to Europe on behalf of the society to study the present status and tendencies of geography in Europe and to establish closer relations with kindred workers and institutions. During his trip Mr. Joerg expects to visit most of the universities where modern scientific geography is represented. Communications to him may be addressed c/o Messrs. Brown, Shipley and Co., 123 Pall Mall, London, S.W.1.

AT the anniversary meeting of the Linnean Society of London on May 24 the Linnean gold medal of the society, the highest award in its gift, was presented to Dr. Dukinfield H. Scott, and all who know the value and extent of his services to recent and fossil botany during the last forty years will agree that the award is thoroughly deserved, and some may be disposed to wonder why it was not bestowed earlier. The medal was instituted in 1888 on the occasion of the centenary of the foundation of the society, and is given in alternate years to a botanist and a zoologist who at the time of the award is not on the council. Dr. Scott's services as councillor, secretary, and president of the society have been almost continuous, so that the opportunities of making the gift have been very few until the present year.

THE Mount Everest Expedition started from Darjeeling in two parties on May 18 and 19. The staff of the expedition consists of Col. Howard Bury, the leader, Mr. H. Raeburn, Dr. Kellas, Mr. G. L. Mallory, and Mr. G. H. Bullock, Alpine climbers; Mr. A. F. Wollaston, surgeon and naturalist; Dr. A. M. Heron, geologist; and Major H. T. Morshead and Capt. O. Wheeler, survey officers. Col. Bury's first dispatch to the *Times* contains particulars of the

organisation and start. Major Morshead, with two assistants and fifty coolies, left Darjeeling in advance, going by the Teesta Valley to correct some of the Sikkim maps. He was to rejoin the main expedition on June 1 at Khamba Dzong. The principal transport of the expedition consists of 100 Chinese and Tibetan mules, with drivers drawn from hill tribes and accustomed to long marches. Forty Sherpa coolies, mostly from villages south or south-east of Everest, accompany the expedition. Several of them have been with Dr. Kellas on high climbs and are trained in ice-work. Mr. Wollaston is taking two Lepcha collectors and skimmers to assist in biological work. The expedition has a complete photographic equipment, and every camera can be used for telephotographic work. Arrangements have been made for developing the plates and films on the spot. Col. Bury records with gratitude the help afforded by the Government of India, the Indian railways, and the Governor of Bengal (Lord Ronaldshay).

THE secretary of the Institution of Electrical Engineers informs us that, in view of the continuance of the coal strike, the Scottish Committee has reluctantly decided to cancel the proposed summer meeting of the institution.

THE autumn meeting of the Iron and Steel Institute will be held, by invitation of the Comité des Forges de France, in Paris, on Monday and Tuesday, September 5 and 6. At the conclusion of the meeting in Paris alternative visits have been arranged to works in Lorraine and in Normandy, and a party of the members has been invited to visit the Creusot works of MM. Schneider and Co.

TWO notices of memorials to distinguished men of science appear in the *Revue scientifique* of May 14. The first refers to the monument erected to the memory of Wurtz the chemist at Strasbourg, which will be dedicated on July 5 next. The other notice deals with the centenary of Ampère's discoveries in electricity. Electrical engineers in France are taking steps to restore the tomb of the celebrated physicist in the cemetery of Montmartre.

THE annual meeting of the British Science Guild will be held at the Goldsmiths' Hall on Wednesday, June 8, at 3 p.m. Lord Montagu of Beaulieu, president of the Guild, will present the annual report, and there will be addresses by the Very Rev. William R. Inge (Dean of St. Paul's) on "The Road to Ruin and the Way Out" and by Sir Richard A. S. Redmayne (chairman of the Imperial Mineral Resources Bureau) on "The Importance of Research in Promoting the Development of the Mineral Industries." Tickets may be obtained from the Secretary, British Science Guild, 6 John Street, Adelphi, W.C.2.

At the annual meeting of the Royal Society of Victoria, held on March 10 last, the following officers were elected:—*President*: Prof. Ewart. *Vice-Presidents*: Mr. F. Wisewould and Prof. Laby. *Hon. Treasurer*: Mr. W. A. Hartnell. *Hon. Librarian*: Mr. A. S. Kenyon. *Hon. Secretary*: Mr. J. A. Kershaw. *Members of Council*: Prof. Osborne, Dr. Summers, Dr. Baldwin, Mr. Dunn, Mr. Richardson, and Mr. Picken. In the annual report it was announced that the scheme for giving short popular lectures on subjects of general interest would be continued. At the ordinary meeting which followed Sir Baldwin Spencer contributed a paper entitled "Blood and Shade Divisions of Australian Tribes."

It is announced that Mr. Bridgeman, Secretary for Mines, has appointed an Advisory Committee for the Metalliferous Mining Industry, of which Sir Cecil Lindsay Budd is chairman. In addition to representatives of owners and of workers in mines and quarries, the following have also been appointed:—Mr. T. Falcon, Dr. F. H. Hatch, and Mr. F. Merricks, mining engineers; Mr. F. W. Harbord, metallurgist; Mr. T. C. F. Hall, Prof. H. Louis, and Dr. J. M. Maclaren, economic geologists; Mr. J. J. Burton, representing the iron and steel industry; and Sir Kenneth W. Goadby, representing medical science. Mr. F. C. Starling, of the Mines Department, will act as secretary to the Committee.

THE London University College Hospital Ladies' Association was founded twenty years ago "to provide clothes for use in the wards, and also for necessitous patients on their convalescence or discharge from the hospital," and "to take up any other work in connection with the hospital which from time to time may commend itself to a general meeting of the association." It has been remarkably successful. There are now some eight hundred members; besides the central London body, there are ten local branches. The latest development is the establishment of the infant welfare department. Like all other London hospitals, University College Hospital is in financial difficulties. In order to help, the Ladies' Association has arranged to hold a sale on Wednesday, June 8, from 11.30 a.m. to 7 p.m. at Someries House, Regent's Park. Her Highness Princess Helena Victoria has graciously consented to open the sale. The things offered for sale will be of a varied nature, including fruit and other farm and garden produce. There will also be some special features, such as an antique stall and a second-hand book stall which may interest our readers.

ON April 2 last, the Governor-General of New Zealand, Lord Jellicoe, formally opened the Cawthron Institute in Nelson, South Island. The institution was founded under the terms of the will of the late Thomas Cawthron (NATURE, January 1, 1920, p. 442) to provide a place for teaching and carrying out scientific research relating to the industries of Nelson and of the Dominion. Lord Jellicoe paid eloquent tribute to the great public generosity of the late Mr. Cawthron, and then spoke of the importance of scientific research. For an agricultural community to achieve success the agriculturists must co-operate with

men of science. The work undertaken in the new institute will deal largely with problems of agriculture, fruit-growing, etc., and should therefore exert great influence on the prosperity of the whole of the Dominion. The Bishop of Nelson, who is chairman of the trustees, also addressed the gathering, and made particular mention of the library of scientific books belonging to the institute, which it was hoped, when completed, would be the best in Australasia. Prof. Easterfield, director of the Cawthron Institute, gave a brief outline of the many lines of research now occupying the attention of the staff; soil surveys, experiments with fertilisers and cover-crops, fire-blight, the deterioration of trout, fruit pests, and the utilisation of flax-waste were among the problems mentioned.

THE *Geographical Review*, issued by the American Geographical Society of New York "upon the adoption of a programme of intensive research," has in the present year ceased to become a monthly periodical; in future it will be issued as a quarterly. We welcome this change of form, as it gives an opportunity for more detailed papers on the subjects to which this valuable publication is devoted. In its new form it contains several important articles, one of the more interesting being an elaborate essay on "The Evolution and Distribution of Race, Culture, and Language" by Dr. Griffith Taylor, of the University of Sydney. This article raises questions which it is impossible to criticise in detail. The author proposes to show that "many current opinions with regard to the mixing of nations are not supported by ethnology." On the problem of the half-caste he is disposed to think that "in many cases the ethnic deterioration is too slight to be important, and that racial antipathy rather than racial degeneration is largely to blame for the troubles of the Eurasians. As regards the Alpine, Mongolian, and most Amerind and Polynesian peoples, the future seems to me to be most promising. It is our diseases and our vices, especially the use of alcohol, which constitute the so-called 'overpowering effect of the white civilisation' upon the uncivilised nations."

A PARAGRAPH in NATURE of July 1, 1920, p. 558, referred to a report of the Smithsonian Institution in which Mr. C. M. Hoy made some comments on the extermination of Australian native fauna. We quoted some of Mr. Hoy's remarks, concluding with the words:—"There are very few game laws in Australia, and no one gives any attention to the ones that are in order." The Minister of Industry, South Australia, afterwards wrote through his secretary objecting to Mr. Hoy's statement, and his letter was published in NATURE of November 18, 1920, p. 377. Mr. Hoy in a communication dated from Sydney, New South Wales, on March 12, claims that his original statement was correct, and adds:—"Everywhere I went in South Australia I found flagrant disregard of the Animals and Birds (Protection) Act, not only in the 'out-back areas,' but within a few miles of Adelaide itself." As Mr. Hoy's notes were originally published by the Smithsonian Institution, and we merely quoted from them, his letter was submitted to the institution, the acting secretary of which

now informs us under date May 7 that "while Mr. Hoy is collecting specimens in Australia for the Smithsonian Institution, he is in no sense an officer of the institution." A letter has therefore been sent by the institution to the Minister of Industry, South Australia, expressing regret that anything written by Mr. Hoy should have led to misunderstanding, and gratefully acknowledging "the kind assistance given Mr. Hoy both by the authorities and private citizens in the various parts of Australia which he has visited."

SIR HERCULES READ in his presidential address to the Society of Antiquaries (*Antiq. Journal*, vol. i., pp. 167-82, July, 1921) avails himself of his approaching freedom to deliver some home-truths. "The contents of a museum take precedence of the building that contains them." Disregard of this principle and of the views of the museum officers by two distinguished architects has made the Victoria and Albert Museum and the northern annex to the British Museum "deplorable and costly mistakes." (Sir Hercules says this would not occur in the case of a laboratory. Well, there is such a building recently erected to the plans of one of these architects in which the best light is given to passages and the windows of the work-rooms are obscured by useless balustrades and overhanging arches.) The Government has allotted to London University a site that will soon be required by the expanding British Museum. Congestion may be in part relieved by removing objects from exhibition into store; but this is only to postpone the inevitable removal of either the museum collections or the national library to another site. Lastly, the recent trouble with Scotland over a battered gravestone leads Sir Hercules to condemn the stringent embargo which several countries have laid on the export of all—even their most trivial—antiquities. At any rate, we shall all agree that for the British Isles, if not for the British Empire, the British Museum should be the centre where a complete representation of all products of Nature and art can be seen. We need, instead of competition, intelligent co-operation between the various museums.

THE mode in which the narrow-mouthed lamprey (*Geotria stenostoma*, Ogilby) ascends waterfalls is described by Mr. D. A. Herbert in the *Journal of the Royal Society of Western Australia* (vol. vi., part i., 1920). The animal can obtain hold only on a wet surface, and the cutting off of the water by a hand placed above the fish causes it at once to drop back into the pool. Two excellent photographs are given of the toilsome climb.

IN a second important paper on the structure of the Andes (*Quart. Journ. Geol. Soc.*, vol. lxxvi., p. 1, 1920) Mr. J. A. Douglas points out that the Alpine type of overfolding cannot be traced in the Andean Cordilleras, and that the chain is due to vertical uplift between two ancient resistant masses which from time to time have compressed a series of transgressive deposits between them. The author continues the fine series of photographic plates that characterised his previous paper published in 1914.

DR. C. D. WALCOTT, secretary of the Smithsonian Institution, has informed the Rev. T. R. R. Stebbing that since the appearance of Raymond's memoir on the trilobite he has reviewed his own trilobite sections, and also cut a number of additional sections, one of which, fortunately, cuts across the exopodite so as to show its structure and the relations of the fringe of filaments to the spiral arm. Other sections indicate that the ventral limb was formed of a coxopodite, endopodite, and exopodite, and, in addition, a short, flat epipodite with numerous long, strong filaments. Dr. Walcott has also succeeded in securing photographs of the epipodites of *Neolenus*, which illustrate the difference between them and the exopodite.

AN interesting paper by Mr. Leslie Scott on "Agricultural Co-operation" appeared in the April issue of the *Fortnightly Review*. In the author's opinion, the farming community—especially the class of small farmers—exerts a considerable stabilising influence in the nation, and it is therefore highly desirable that this class should be maintained. Farmers have to face foreign competition, and they have to stimulate home demand; the best way to do these two things is to cut down wherever possible the expenses incurred in distribution and in the purchase of feeding-stuffs, etc. "Factory" farms reduce production costs, but they also eliminate the small farmer, for the factory farm consists of 10,000-20,000 acres farmed by a manager appointed by some company. Agricultural co-operation seems to be the only method by which economic production can be attained and the small farmer preserved at the same time. A great deal is done by such co-operation in Denmark, and there are a few agricultural societies doing good work in this country, but there is a great need for union among these different societies. They are now being joined up in the Agricultural Wholesale Society, and as soon as the farmers put implicit trust in their own societies and the societies place equal trust in the central body, then the wholesale society—provided that it is adequately capitalised—will be able to make practically its own terms in the markets both of this country and of the world.

THE Douglas fir, *Pseudotsuga Douglasii*, the most valuable conifer in western North America, is now planted extensively by foresters in this country, as it produces a large volume of timber in a short period of years. Until recently this tree enjoyed practical immunity from both insect attack and fungus disease, but this happy state no longer exists, and it is necessary now to sound a warning that unless preventive measures are taken, great disaster may befall plantations of this species. Such has happened in the case of the white pine, *Pinus strobus*, an American tree that can no longer be commercially planted in Europe on account of its liability to succumb to the deadly fungus *Peridermium strobi*. The Douglas fir is becoming infested in the South of England with a woolly aphis, *Chermes Cooleyi*, which was first noticed in 1914 in the New Forest. Its spread since then has been alarmingly rapid, and isolated attacks were noticed last summer in Peeblesshire. It is distressing to hear also of a fungus which has been

doing considerable damage of late years to young plantations of Douglas fir in many parts of Scotland. This either kills the leading shoot a few inches below the tip or causes the death of the whole tree by attacking the outer tissues completely round the stem at a little distance above ground-level. In both cases there is a sudden decrease in diameter in passing from the healthy to the diseased portion of the stem, accompanied by much exudation of resin. This fungus is described as a new species, *Phomopsis pseudotsugae*, by Dr. Malcolm Wilson in the Transactions of the Royal Scottish Arboricultural Society (vol. xxxiv., part ii., pp. 145-49, plates iv.-v.) published in November last. Early recognition of the disease and burning of affected trees are the measures recommended for stamping out this pest, which has been known to kill half the trees in a young plantation.

A LENGTHY paper on "The Perishing of Paper in Indian Libraries" forms part vii., vol. iii., of the Journal of the Indian Institute of Science. The investigation was undertaken at the Institute of Science on behalf of the Government of India by Mr. J. J. Sudborough and Miss M. M. Mehta. "Perishing" is defined as a brittleness which is so marked that folding the paper once or twice will cause it to break along the fold, and it is observed in many of the books in record offices and libraries. The conclusions which the investigators have arrived at as the result of an examination of numerous libraries in India do not differ greatly from the report of the Committee on the Deterioration of Paper in Europe published in the Journal of the Royal Society of Arts for 1898 (No. 46), or from the report of a similar committee in America which appeared as Report No. 89, Pub. 1909, U.S. Department of Agriculture. Chemical perishing, as distinct from the destruction caused by micro-organisms, was investigated, and the conclusion arrived at is that the former type of perishing, which is by far the commoner, is due to hydrolysis of the cellulose molecules of the paper and their later decomposition into simple substances rather than to a process of oxidation. The type of paper found to be most resistant in India is a rag-paper the fibres of which have not been weakened in the process of manufacture. Treatment which has been found to damage the fibre is prolonged digestion with alkali, over-bleaching, non-removal of the last trace of bleach by antichlor, and imperfect washing that leaves traces of acid in the paper, while rosin and filling material should not exceed a small fixed percentage. It is recommended that all books and documents of permanent value should be removed to libraries in hill stations with temperate climates or placed in special buildings in which complete air control can be maintained.

SEVERAL distinctive features are embodied in a new model radiosopic couch by Messrs. Newton and Wright, Ltd. The tube-box, which is fitted with a holder to take a gas tube or Coolidge tube, is covered by sheet-lead and mounted upon steel rails, free movement being ensured by ball bearings. The diaphragm is of the rectangular type, and is operated by levers attached to a control arm; this latter projects hori-

zontally from the tube-box, and is supported by one of two metal uprights which hold the protective apron in position. A further feature of interest is that these uprights allow the tube-carriage to be shifted longitudinally by the operator's knees, which should at times be found a great convenience. Protective devices figure conspicuously in this new model.

REMARKABLE developments have taken place in the use of water-power in many parts of the world during recent years, with which English engineers who have not time to consult foreign publications are unfamiliar, and in which English manufacturers have taken but little interest. The possibilities of development in this country and in other parts of the Empire of the sources of water-power are awakening an interest in the subject, and the proposed issue by Messrs. Henry Frowde, and Hodder and Stoughton, under the editorship of Prof. S. M. Dixon, of a quarterly *Journal of Hydraulics*, at an annual subscription of 31s. 6d., each number of which will be self-contained and will make available in a convenient form details of the most recent developments of hydraulic engineering, should prove of interest and value to many engineers. A sufficient number of guaranteed subscribers is required before the first issue.

DR. ARNE WESTGREN has carried out some Röntgen spectrographic investigations of iron and steel in the University of Lund, Sweden, and presented his results at the May meeting of the Iron and Steel Institute. He has verified Hull's result that iron at ordinary temperatures (α iron) has a cube-centred cubic lattice structure, the edge of the unit cube being 2.87 Å. He finds that between 800° and 830° C.—that is, within the so-called β -iron range—the atoms are oriented in exactly the same way as in α iron, the edge of the unit cube being 2.92 Å. If allotropy is accepted as being the same as polymorphy for solid crystalline bodies, this means that β iron cannot be considered as a separate modification. On the other hand, both in pure iron and in austenite at 1000° C.—that is, in the γ range—the crystals have face-centred cubic lattices, the edge of the unit cube being 3.61 Å. Consequently, this is characteristic of γ iron, and a fundamental crystallographic difference exists between α and γ iron. In martensite, the constituent of hardened carbon tool-steel, Dr. Westgren has found that the iron is in the α form. This is also the case in high-speed tool-steel hardened at 1275° C. The investigations are being continued, and will be extended to include complex phases in steel and other alloys. Spectrograms of cementite show that its crystal structure is related to that of γ iron, a fact which explains the mutual solubility of these phases.

LISTS Nos. 182 and 183 of the Cambridge and Paul Instrument Co., Ltd., give particulars respectively of the Cambridge microtomes and the Cambridge recording clinical thermometers. The firm now manufactures three types of microtomes. The universal microtome, on a circular cast-iron base of 250 mm. diameter, is constructed on similar principles to the Cambridge "rocker," but has a wider range of application; it cuts sections of 0.001 to 0.035 mm. in thickness from objects up to about 18 by 20 mm. in dia-

meter embedded in paraffin or celloidin. Since the object moves in a horizontal plane along the arc of a circle, it has the advantage that the sections are flat. The rocking microtome is similar in general construction to the instruments manufactured in previous years, but with improvements in details; it will cut sections 0.002 to 0.024 mm. in thickness from paraffin-embedded objects up to about 12 by 20 mm. in diameter. The freezing microtome has been specially designed for use in operation work. The thermometers, which give continuous automatic temperature records extending over a considerable period, are of the electrical resistance type, and consist essentially of a bulb containing a coil of platinum wire joined by connecting wires to a recorder. The record consists of a series of dots on the chart-paper, impressed every minute or half-minute as is desired.

Two correspondents have forwarded further suggestions for picture-hanging wire in reply to the letter under that title published in NATURE of May 19 last. The first relates to the use of single-strand enamelled phosphor-bronze wire of No. 18 B.W.G. This has

been found satisfactory for pictures of moderate weight. The other method, similar to that described in NATURE of May 26, p. 395, is to use ordinary copper bell wire 0.055 in. to 0.02 in. in diameter. Pictures varying in weight from 1 lb. to 50 lb., using two wires for the heavier pictures, have been hung successfully with it. The need for straightening the wire carefully is emphasised in both letters, and the advisability of avoiding sharp bends at the edges of hooks is mentioned.

MESSRS. W. HEFFER AND SONS, LTD., Cambridge, have in the press a work, to be published in three parts, entitled "Dates and Date Cultivation in the 'Iraq,'" by V. H. W. Dowson, of the Agricultural Directorate of Mesopotamia. The three sections comprising the work will deal respectively with the cultivation of Basra date palms and the marketing of the fruit; statistics and details of the experiments from which the average yield of date gardens per acre is adduced; and the varieties of date palms found at Basra. Part iii., which will be illustrated, is promised for the coming autumn.

Our Astronomical Column.

PONS-WINNECKE'S COMET.—Mr. W. F. Denning writes:—"On May 28 this comet was conspicuously visible in a field-glass. The comet is at present situated in the Milky Way amongst the stars of Cygnus, and is moving to the south-east at the rate of about $3\frac{1}{2}^{\circ}$ per day. It is increasing in apparent brightness, and may possibly come within naked-eye vision at the middle of June. The latest observations prove that the comet is farther from the earth than was expected, and that at perihelion it will be about 2,000,000 miles outside the terrestrial orbit. Perturbations by Jupiter in 1918 have altered the cometary path and lengthened the period of revolution. There may be a meteor shower on the nights from June 27 to 30, but the conditions are such that the display may not be a very brilliant one. Observations should be carefully made at the period mentioned, and it is fortunate that the evening sky will be free from moonlight."

SPECULATIONS ON THE FORMATION OF SPIRAL NEBULÆ.—M. Alex. Véronnet contributes an article on this subject to the *Comptes rendus* of the Paris Academy of Sciences for April 18. He examines the effect that would result from the impact of the two components of a binary system. He shows that the energy produced by friction at their surfaces is the most important factor, and that a mass equal to that of Jupiter might produce by impact with the sun a temporary increase of light amounting to twelve magnitudes. Radiation-pressure would then expel the heated particles with high speeds, and the revolutionary movement of the stars would give a spiral formation to the scattered particles. The author seeks thus to explain the phenomena both of novæ and of spiral nebulae. He concludes that the latter would undergo a rapid evolutionary transformation (in the course of a few centuries). It would seem, however, that the larger spiral nebulae are on too grand a scale to be the product of the impact of a mere pair of stars. The hypothesis is, however, worth considering in relation to such nebulae as that which was revealed round Nova Persei by the light of the outburst, and Hubble's variable nebula in Monoceros.

M. Véronnet quotes the results obtained by Mr. Van Maanen, from photographs taken at intervals of several years, on the movements going on in certain nebulae. These showed an outward tendency, agreeing with M. Véronnet's conclusions.

The nebula round Nova Persei had evidently been present, though unseen, before the outburst, and the suggestion had already been made that it might be the product of a former impact of the same two bodies that caused the outburst of 1901.

THE COMPANION OF α HERCULIS.—In the course of a paper on "Seven Spectroscopic Binaries" (*Astro-physical Journal*, April) Mr. R. F. Sanford announces that the fainter star of this well-known pair is a spectroscopic binary with a period of 51.6 days, only one spectrum being visible. He further announces that the radial velocity of the centre of gravity is -37.2 km./sec., whereas that of the principal star of the visual pair is -32.2 km./sec. Mr. Sanford concludes from this that the visual pair is only an optical one, the components not being physically connected. The following considerations, however, appear to show that this conclusion is unwarranted:—

The chance of two unconnected stars of magnitudes 3.5 and 5.5 being within $5''$ of each other and having the same proper motion of $3''$ per century in the same direction is so small as to be absolutely negligible. Moreover, the assumption of physical connection does not involve an unreasonable value of the masses. The spectroscopic parallax of component B is $0.018''$ and the angular separation $4.7''$, or 260 astronomical units (if unforeshortened); a joint mass equal to that of the sun would give a relative velocity in a circular orbit of 1.84 km./sec. The actual relative velocity is 5.0 in the line of sight and 1.6 at right angles, the position angle having altered by 6° in eighty years. The combined velocity is 5.25, giving a joint mass of $(5.25/1.84)^2$, or 8.14 times that of the sun. We know of many greater stellar masses; for example, in a paper by Herr P. Hügeler in *Astr. Nach.*, No. 5098, the masses of the components of α Herculis are calculated to be 7.43 and 2.84 in terms of the sun.

Administration of Scientific Work.

LORD HALDANE presided at a meeting of the National Union of Scientific Workers held at University College, London, on May 30, at which Prof. L. Bairstow gave an address on "The Administration of Scientific Work."

Lord Haldane said that the occasion was most interesting to him, as he was presiding over a meeting of what bore a resemblance to a trade union. We were apt to forget that an organisation must have another purpose than merely the promotion of the interest of the individuals who belong to it. An organisation sometimes helped to keep standards high and shield the right, and that was one of the dominant aims of the National Union of Scientific Workers. The problem of how science and administration were to be related was a difficult one. Scientific men were often impatient of administration and the Treasury, but though these institutions hindered imaginative enterprise, he was not altogether sure the case was against them. Considering the expenditure now afforded on scientific research, we had little cause to lament the present period. The highest science did not allow itself to be organised, but it did not follow that for this reason there was to be no limit placed on expenditure.

Prof. Bairstow avowed as his ideal world one which was so administered as to ensure remuneration adequate for work, and thus secure in great abundance that desirable product, the work of the worker. Though most people would subscribe to that idea, it was the failure to work it out effectively that was responsible for most of our troubles. We lived in an age of "brain-waves," of disproportionate rewards for accidental discoveries, and the union was strongly opposed

to such rewards. Scientific research was the foundation of progress; stop it, and industry would stagnate on the scientific side. Scientific ability should not be used up in applied research, which under existing conditions afforded more opportunities to the young and ambitious scientific worker than research at a university. University workers were under the perpetual shadow of financial anxieties, and could not, therefore, give their best work to instruction and research. The root of the problem was the resistance of the administrator to the idea of co-operation with the worker. Prof. Bairstow illustrated this point by reference to the programme for aeroplane construction prescribed in 1917 for the following year. Specifications for a number of types of machine were laid down without reference to the assistance of the technical *personnel* of the Air Board or of the aeronautical industry, with the result that manufacturers were unable to accept contracts on the basis of the specifications. The effect of this action was to denude the Department of its best technical men the moment the armistice was signed.

In proposing a vote of thanks to Prof. Bairstow, Sir Frank Baines congratulated him on the moderation he had shown, though he was convinced that under his reserve there was evidence of indignation against the position in which the scientific worker was placed to-day.

Dr. George Senter, in thanking Lord Haldane, ventured the opinion that only a short time would elapse before the whole nation would realise what scientific men realised already, the great value of the work he had done as the head of two Government Departments—work that was carried out in the true scientific spirit.

New Technical Applications of an Electrostatic Principle.

ON May 26 Messrs. A. Johnsen and K. Rahbek, two Danish engineers, gave a most interesting demonstration to the Institution of Electrical Engineers of new electrostatic microphones, telegraphic relays, etc., based on a little-known electrical phenomenon. If a smooth plate of brass is placed on a smoothly polished slab of lithographic stone about 1 in. in thickness resting on a conductor, and a potential difference of 400 volts is applied between the metal plate and the conductor, a strong attraction will be developed between the plate and the stone. Messrs. Johnsen and Rahbek demonstrated that the attraction between a metal disc about 2 in. in diameter and the stone was greater than 1 kg., although the current flowing was only a few micro-amperes. Provided the disc is in contact with the stone and the microscopic current is flowing, it lifts the stone as a magnet lifts its keeper. But when the current is broken the attractive force vanishes. The stone is a semi-conductor, but the voltage drop across the stone is very small compared with the voltage drop due to the resistance of the film between the brass plate and the stone. The force, therefore, is due to electrostatic attraction, which for a plate condenser varies inversely as the square of the distance between the plates.

This phenomenon has been utilised by the authors in the development of apparatus which will prove of great value in electrotechnics. Lithographic stone, slate, limestone, agate, flint, and many other semi-conductors can be used to show the electrostatic attraction. If the semi-conductor be rotating and a metal band slides on it, the friction between them will vary largely with the slightest variation of the microscopic current between them. As very appreciable mechanical forces are called into play, it is possible to utilise them in

technical applications. In radio-telegraphy, for instance, it is useful as a thermionic recorder, the current from the ordinary small valves being amply sufficient to operate it at a speed of several hundred words per minute provided that at least 100 volts be used for the valves. Excellent records obtained in Copenhagen were shown of the messages sent out from the Eiffel Tower. As the recorder is free from self-induction, there is no practical limit to the speed at which records can be taken. If the metal band be connected to a sound-producing diaphragm and telephonic currents pass between it and the rotating semi-conductor, an extraordinarily loud-speaking telephone can be obtained. Using the body of a violin as the diaphragm, it was shown that the sounds produced by a violin played at a distance could be perfectly reproduced in the lecture theatre. Ordinary speech also was excellently reproduced and could be heard all over the room.

In connection with their inventions it is interesting to recall that Edison's first loud-speaking telephone depended for its action on electrostatic attraction. A chalk cylinder was rotated and a metallic spring pressed against it, a current passing between them. Sir William Barrett described this instrument to the Royal Dublin Society on January 19, 1880, and a summary of his lecture was given in *NATURE* (March 18, 1880, vol. xxi., p. 483). The electrostatic theory, however, was not then favoured. In 1905 Mr. Rollo Appleyard in a paper to the Physical Society described the adhesion which occurs between a metal plate and a dielectric when a very minute current passes between them. Electricians also have attributed to the effects of electrostatic attraction the alteration in the insulation resistance of paper condensers as the voltage varies.

Dalton and Atomic Symbols.

IN an article in the *Moniteur Scientifique Quesneville* Prof. Maurice Delacre, stimulated by a passage in "The Life and Work of Gerhardt" by E. Grimaux, severely criticises the attitude which was taken up by Berzelius in his celebrated "Essai sur la théorie des proportions chimiques" (Paris, 1819) towards the work of Dalton. The chief ground of the criticism is that in this work, the original of which appeared in Swedish in 1818, Berzelius describes his well-known system of chemical symbols without making any mention of the fact that Dalton had more than ten years previously introduced true atomic symbols and used them for the construction of formulæ. The passage in the "Essai" of Berzelius reads as though he himself had been the first to conceive this happy idea, and has thus given rise to the erroneous view entertained by some writers on the history of chemistry that Berzelius invented atomic symbols, whereas the credit is entirely due to Dalton.

Berzelius further, in the opinion of the author, exaggerated the importance of the work of Wenzel and Richter and minimised that of Dalton in con-

nection with the discovery of the laws of chemical combination, whereas, in fact, these laws were clearly enunciated only after Dalton's ideas about atoms had become known. Prof. Delacre propounds the thesis that there is only one chemical law of weight, and this he proposes to call the "law of the symbol," regarding the laws of definite and multiple proportions as corollaries of this fundamental law.

There is here some confusion between experience and theory, and we do not regard this suggestion as judicious. It is, of course, true that Dalton's atomic theory has as necessary corollaries the laws of chemical combination, but the theory rests ultimately on the observations by which these laws were established, and to these observations it is undeniable that Wenzel and Richter made important contributions. In the matter of atomic symbols Dalton has, in this country at least and in most of the historical works with which we are acquainted, received full credit, and it is with surprise that we learn that some writers still erroneously attribute this important advance to Berzelius.

The Melbourne Meeting of the Australasian Association.¹

II.

Abstracts of Presidential Addresses to Sections.

SECTION A (Astronomy, Mathematics, and Physics).—Prof. H. J. Priestley, of the University of Queensland, in his presidential address traced the development of the theory of relativity. In discussing the Einstein spectral-line effect, he pointed out that the usual treatment of the question involves the assumption that the time-period of the source is transmitted by the radiation to the observer. He gave reasons for making the alternative assumption that the Einstein interval ds is transmitted by the radiation, in which case the displacement of spectral lines should arise from a change in the field of the observer, not in that of the source. To meet the possible objection that the usual method of establishing the deviation of light in a gravitational field appears to imply an underlying constant time-period in the radiation, Prof. Priestley showed that the light path in a gravitational field could be found by a method which made no appeal to pre-relativity physics, and implied, therefore, no assumption as to the constancy of the time-period.

Section B (Chemistry).—Prof. N. T. M. Willsmore, in the course of his presidential address, referred to the indispensable work of British chemists during the war, stating that in the manufacture of explosives and in devising counter-measures against the enemy the chemist held the key to the position. Chemists were needed to deal with poison gas, to supervise water-supply, for the manufacture and use of artificial fog in the Navy, in the munition factories, and in numerous other spheres. In future wars chemistry would play an even greater part, and in the United States the Chemical Warfare Service had been organised as an independent branch of the Army. Prof. Willsmore then indicated the immense amount of work done by the chemists in the explosives and other factories in Great Britain.

Section C (Geology and Mineralogy).—"Recent Advances in our Knowledge of New Zealand Geology" was the title of the presidential address delivered by Prof. W. Noel Benson. The geo-

logical history of New Zealand was divided into three major periods, the oldest closing about Carboniferous times, the second in Lower Cretaceous times, and the third at the end of the Pliocene period. Comparative tables showing the classification of the strata in each period by many students of New Zealand geology illustrate the gradual evolution of the knowledge of New Zealand stratigraphy. It has been customary to consider the complex of gneisses and associated rocks in "Fiordland" as of Cambrian or pre-Cambrian age, but recent work by various investigators tends to show that this view is incorrect. Prof. Benson concludes that while some of the crystalline complex may be pre-Ordovician, the bulk of it is probably post-Ordovician, and some may be even of Mesozoic age. These rocks have been invaded by more or less gneissic plutonic rocks during a period of orogeny, followed either immediately or at a later orogenic period by massive plutonic intrusions. To the second period belong the "Maitai" (? Permian) and the "Hokonui" (Trias-Jurassic) systems. The relationship between the Hokonui series and the underlying Maitai series was discussed at length, and the conclusion reached that there is little evidence of a great unconformity, though crust-warping probably occurred. An interesting problem of New Zealand geology, the origin of the Otago schists, was also discussed. These rocks have been assigned to ages ranging from pre-Cambrian to Mesozoic. Prof. Benson suggested that they occurred as a series of sheet-folds, occasionally upturned and crushed, and composed for the most part of the metamorphic equivalents of Middle and Lower Triassic and Permian formations. The varying views as to periods of orogeny and plutonic intrusion and the general direction of folding were described and a new interpretation of the facts was suggested. Following the Hokonui orogenic movements, marine deposits were laid down, commencing with Middle Cretaceous and extending into Upper Pliocene beds. The diverse views of the relationship between these series were discussed and a complete bibliography of the literature was given. It was pointed out that during the deposition of these marine beds only in Otago is there evidence of a persistent land surface. The affinities of the fossil

¹ Continued from p. 410.

faunas and floras of New Zealand were then outlined and various views as to the existence of a land connection between New Zealand, Antarctica, Australia, and Malaysia were reviewed. The latter portion of the address dealt with igneous rocks from Cretaceous to more recent times and with the later orogenic movements and resultant physiographic features. In conclusion, Prof. Benson appealed for detailed investigations in New Zealand in all branches of geology.

Section D (*Biology*).—The president, Prof. A. J. Ewart, gave a summary of the work done in botany and geology during the war period, and pointed out that, large as it was, these sciences were not stimulated by war activity, as chemistry and physics were. With the increased productive activity now necessary to replace the waste of war, botany and geology would resume their original importance as the primary sciences connected with productive activity.

Section E (*Geography and History*).—"Geographical Problems of To-day and the Status of Geography in Science" was the subject of the presidential address delivered by Sir Douglas Mawson. He referred to the geographical changes brought about by the war. The war had put a temporary brake on geographic exploration and curtailed the study of geography at the universities, but it had been a great stimulus to map-making. Three recent events, each of which marked a stage in the geographical development of Australia, were the completion of the transcontinental railway, the first aerial link with Europe established by Sir Ross Smith, and the founding of an associate professorship in geography at Sydney University. It was gratifying to record the beginning of what might confidently be expected to be a more general recognition of geography as a definite science subject in Australasian universities. Such a movement would be greatly advanced by the existence of a vigorous geographical organisation in Australia. There was an unrivalled field for geographical inquiry in the Commonwealth, and under the stimulus of modern movement great things were to be expected. Even the coast-line of Australia was as yet only partly charted. Now that the Commonwealth had instituted its own Navy it had need also of organising an efficient hydrographic service to cope with this undertaking. In this a beginning had already been made, but to do justice to the Melanesian dependencies as well as an extensive and well-founded organisation was needed. Fields for general exploration included parts of central and north-western Australia, Papua, and those territories for which Australia held mandates. Good geographical research could also be undertaken anywhere in Australia if investigators selected a definite area and worked it out in complete geographical detail.

Section F (*Ethnology and Anthropology*).—"Anthropology and the Government of Subject Races" was the title of the presidential address delivered by Mr. Justice Murray, Lieutenant-Governor of Papua. He pointed out that there were two methods of governing native races: (1) to abolish all native customs and institutions and introduce European substitutes, or (2) to use as an instrument of good government such customs as appeared to be useful, or even harmless. Anthropology was of service only with the latter, the "indirect" method, favoured by the British. Among savage races the different departments of thought and action were not clearly distinguished, as with us, and this must be borne in mind when dealing with them. Anthropology had so far not played an important part in administration. In the future, however, it was likely to become of the greatest help, either through the appointment of specialists or by encouraging the study among Govern-

ment officers. The capacity of "thinking black or brown" required more sympathy and insight than the average man possessed, but it was very necessary, for there was always danger that natives would misconstrue some policy. The best remedy was the study of anthropology. It was partly to encourage this study among officers, and partly to assist the Government more directly, that arrangements were being made for the appointment of an officer as Government Anthropologist.

Section G (*Social and Statistical Science*).—Mr. G. H. Knibbs, Commonwealth Statistician, selected as the subject of his presidential address "World and Empire Development." Mr. Knibbs pointed out that the huge destruction of material wealth and the world-wide dislocation of economic relations had accentuated the importance of obtaining systematised statistics. This was recognised in the endeavour to establish a statistical branch for the League of Nations, as well as the International Institute of Statistics at The Hague and the International Institute of Agriculture at Rome. The rate of growth in the population of the white races which had characterised the last century was about 1 per cent. per annum, so that the population doubled itself in slightly under seventy years. Such a rate could not possibly continue, because of the limitations of food- and water-supply. Various materials, especially aluminium, were also being used up at a rate which was increasing more rapidly even than the population. Statesmen must perforce take account in the wisest possible way of the rates of development and of exhaustion of supplies. The British Empire Trade Commission which visited Australia in 1913 realised that British business interests necessitated Imperial statistics, and it recommended a conference of the statisticians of the Empire. The conference recommended the establishment of a British Empire Bureau of Statistics, incorporated by Royal charter, the Prime Minister of the United Kingdom to be president in his capacity as *ex-officio* president of the Imperial Conference. The general aim was to facilitate the analysis of the drift of the past and to forecast the future position of the Empire. The falling-off of productive efficiency in Australia was an ominous fact for a young nation possessed of a valuable heritage and needing population for its development.

Section H (*Engineering and Architecture*).—In his presidential address on "The Present System of Education of Engineers and Architects" Mr. M. E. Kernot found grave faults in the education and training of men who were entering the profession. Experience with men who commenced at practical work and got into a groove often showed how much they might have done had they had the advantage of university training. With the system of articles results were also very variable; pupils who had completed their training in this way frequently showed themselves incapable of any design or construction work. The best hope for improvement in professional education lay in assuring university training to those fitted for it. Engineers recognised, too, that the community would be better served if more were made of the workman's brains and less of his muscle. The rough-and-ready estimating now in vogue should give place to scientific calculation.

Section I (*Sanitary Science and Hygiene*).—Taking as the subject of his presidential address "Accuracy in Medicine," Dr. J. H. L. Cumpston stated that two things were urgently necessary: (1) the education of the public to a proper conception of the need for accurate methods in medical diagnosis and treatment, and (2) the provision, within

practicable access of all medical practitioners, of the equipment necessary for the employment of these methods. Some form of common service must be provided so that each practitioner could have access either to the necessary instruments or apparatus or to some specialist who had the necessary knowledge and equipment. In the metropolitan areas such service was already largely provided by hospitals, specialists, and laboratories, but the provincial and country towns were at a disadvantage. The prevention of disease should be the first aim of medical science. The technical apparatus required for the application of many of the laws of public health was not unduly extensive, and could be made to serve large populations. There were enough trained medical men to make a commencement, and laboratories to serve all public health purposes should be forthwith established at all the principal country centres.

Section J (*Mental Science and Education*).—"The Need for the Scientific Study of Education" was the subject of Prof. A. Mackie's presidential address. He urged the need for a survey of the mental character of the school population for the effective practice of teaching and organisation, pointing out that the tests of general and scholastic intelligence devised by standard authorities must be re-standardised before they can be usefully employed for Australian children. The question of school examinations also stood in need of scientific investigation. The study of the errors made by pupils in the various branches of school-work might be expected to throw much light on the curative and preventive measures that should be adopted.

Section K (*Agriculture*).—That education should be general rather than special up to the age of fifteen was the plea of Prof. A. J. Perkins in his presidential address entitled "Agricultural Education." The bulk of those following agricultural pursuits were, in the main, home-trained, and the need for any other form of training was to some extent forced into the background. The State would do well to maintain agricultural colleges as half-way houses between the town and the country. Practical training in farming was of importance in conjunction with theoretical instruction, and the establishment of university training and chairs of agriculture must be backed up by the selection of adequate scientific staffs. Every effort should be made to overcome the effects of isolation of those engaged in agricultural pursuits. An extension of the agricultural bureau system of South Australia was advocated, under which agriculturists were grouped into local branches, where local interests were discussed and arrangements made for visits of experts and experimental work.

Section L (*Veterinary Science*).—The president, Prof. H. A. Woodruff, delivered an address on "The Development of the Present Conception of Immunity."

At a joint discussion (Sections A and B) on "The Applications of Physical and Chemical Science in the Great War" Mr. A. E. Leighton (Director of the Commonwealth Arsenal) gave a brief sketch of two war activities on the part of applied chemistry and the particular significance they held for Australia. These were the important factors of cordite and high explosive. It must be remembered, said Mr. Leighton, that Australia was not in a fortunate position as a manufacturing country, and her provision against attack must take the form of finished munitions. Until the industries of Australia were in a position to maintain a flow of munitions commensurate with requirements, they must adhere to the policy of importing and holding stocks. Australia had illimitable quantities of iron-ore, but what the munition-worker

wanted was steel rolled to a certain shape. He wanted caustic soda and chlorine. The tariff and recent legislation had given promises that the Ministry intended to encourage supply. But to become a manufacturing community was a slow and costly process. Protection should be scientific in the sense that in protecting the industry the people should also be protected from rule-of-thumb methods. The number of chemists and engineers should be increased, for without them the illimitable resources of the country could not be treated.

Dr. A. C. D. Rivett particularly directed attention to the lesson already learned by Germany and England, that the possession of flourishing chemical industries was not merely a means to material prosperity in times of peace, but also absolutely essential as an instrument of warfare. Men in Australia had to realise that to build up the chemical manufactures of Japan or America, or any other country, and to neglect their own, was precisely the same as building up other armies and navies while forming none of their own. Dr. Rivett urged the adoption of the following motion:—"That these sections of the Australasian Association for the Advancement of Science, recognising the vast importance of chemical science in modern warfare, recommend that the general council urge upon the Federal Ministry the necessity for fostering chemical industries in Australia under such conditions as will ensure the maximum readiness for the production of munitions of war in case of need." The motion was seconded by Prof. Orme Masson, and agreed to unanimously.

Prof. T. H. Laby read a paper on "The Organisation of Science in Australia." Prof. Laby pointed out that, although during the war period science had been applied most successfully to assist in the exploitation of Nature's resources for our material benefit, a greater achievement would be to instil into the national mind the high ideals which have actuated so many men of science. This would be assisted by a re-organisation of science such as had been undertaken by Great Britain, the United States, and Japan. The lack of any single Australian scientific society was also commented on, the political control exercised over the Commonwealth Institute of Science and Industry was criticised, and the position of the mathematical and physical sciences in Australia was indicated as illustrative of the need for organisation. In conclusion, the author urged the formation of an Australian scientific society representative of all research workers in science in Australia, which would be able to act in an advisory capacity to the Commonwealth Government upon scientific matters. This plea has now been answered to a large extent by the formation of the National Research Council referred to last week.

Numerous papers were read to the various sections and a number of joint discussions on problems common to more than one section were held. Especially is the association to be congratulated on the formation of a National Research Council, which should prove a real asset for the advancement of science in Australia.

University and Educational Intelligence.

BRISTOL.—Sir Isambard Owen, vice-chancellor of the University, is to retire at the end of the present session, having reached the age limit of seventy years prescribed by the rules of the Treasury with regard to superannuation.

LONDON.—Dr. R. R. Gates has been appointed to the University chair of botany tenable at King's Col-

lege in succession to Prof. W. B. Bottomley. He was appointed University reader in botany at that college in 1919, and has since that date been in charge of the department in the absence of Prof. Bottomley.

Mr. D. M. S. Watson has been appointed as from August 1 next to the Jodrell chair of zoology and comparative anatomy at University College in succession to Dr. J. P. Hill, now professor of embryology. Since 1912 Mr. Watson has been lecturer in vertebrate palæontology at that college. He has also lectured in the Universities of Munich, Cape Town, Sydney, California, Michigan, and Chicago.

Mr. H. G. Jackson has been appointed as from August 1 next to the University readership in zoology tenable at Birkbeck College. In 1912 Mr. Jackson was appointed research assistant to Prof. Herdman at the University of Liverpool, and since 1913 has been lecturer in zoology at the University of Birmingham.

Dr. William Wilson has been appointed as from September 1 next to the University chair of physics tenable at Bedford College. Since 1919 Dr. Wilson has been senior lecturer in physics at King's College, and in 1920 he received the title of reader in physics.

The following doctorates have been conferred:—*D.Sc. in Botany*: Mr. F. G. Gregory, an internal student of the Imperial College—Royal College of Science, for a thesis entitled "The Increase in Area of Leaves and Leaf-surface of *Cucumis sativus*." *D.Sc. in Chemistry*: Mr. H. Yaroslav, an internal student of University College, for a thesis entitled "The Electro-affinity of Aluminium." *D.Sc. in Zoology*: Mr. L. T. Hogben, an external student, for a thesis entitled "Studies on Synapsis." *D.Sc. (Engineering)*: Mr. F. E. Rowett, an external student, for a thesis entitled "The Resistance to the Flow of Oils through Rubber and Steel Pipes," and other papers.

Mr. L. H. Dudley Buxton has been elected to an Albert Kahn travelling fellowship for the year 1921-22. These fellowships, which are now of the value of 1000*l.* each, were founded in 1910 by Mr. Albert Kahn, of Paris, to enable the fellows to travel for at least one year in foreign countries, so that by the study and comparison of national manners and customs, and of political, social, religious, and economic institutions, they may become better qualified to instruct and educate their fellow-countrymen.

DR. A. G. GIBSON, lecturer in morbid anatomy in the University of Oxford, is to deliver the Schorstein memorial lecture at 4 o'clock on Friday, June 3, at the London Hospital Medical College. The subject will be "Chronic Inflammatory Diseases of the Spleen."

THE summer meeting of the Association of Science Teachers will be held at Cambridge on Saturday, July 9. There will be a short business meeting in the morning at Girton College (by kind permission of the Mistress of Girton), where members will have lunch. In the afternoon Dr. F. W. Aston will give a lecture on "Atoms and Isotopes."

Two research scholarships of the annual value respectively of 100*l.* and 75*l.* are being offered by the Huddersfield Technical College, the object being the encouragement of research upon problems connected with the coal-tar industry in Great Britain. Further information can be obtained from Dr. H. H. Hodg-

son, Colour Chemistry Department, Technical College, Huddersfield.

Two lectures entitled "The History of Map-making" and "Maps of the Principal Voyages of the Sixteenth Century" are being delivered at 7 p.m. on Mondays at Birkbeck College (University of London), the first on Monday last and the second on June 6, by Mr. W. H. Barker. In connection with these lectures there is being held an exhibition of maps, charts, and globes illustrating the history of map-making and geographical discovery. Admission to the lectures is free without ticket.

RESEARCH scholarships in agricultural and veterinary science (not more than five in number), each of the annual value of 200*l.* and tenable for two years, are being offered by the Ministry of Agriculture and Fisheries. The agricultural scholarships are open to graduates with honours in science of a British university. The veterinary scholarships are open to students who have secured the diploma of the Royal College of Veterinary Surgeons. Nominations on the prescribed form must reach the Secretary, Ministry of Agriculture and Fisheries, 4 Whitehall Place, S.W.1, by, at latest, July 15 next.

THE University of the West at Bristol, of which Lord Haldane is the Chancellor, has issued a striking illustrated appeal for the sum of 1,000,000*l.* for endowments and maintenance. The appeal takes the form of a series of thirty delightfully executed and printed folio drawings, not only of existing buildings connected with the University in Bristol and in its neighbourhood, but also of buildings in the course of erection on an admirable and unencumbered site of 13½ acres near the centre of the city, which are due to the munificence of the late Mr. H. O. Wills and his sons, Messrs. G. A. and H. H. Wills. The appeal is accompanied by a sheet of three remarkable cartoons by Mr. Louis Raemaekers illustrating the need for the more complete education of the youth of the nation, both men and women, who did it such splendid service in the eventful years 1914-18. Under the cartoons are respectively the remarkable, but true, words: "Genius is not drawn from any exclusive class or caste, but from the cradles of the nation; no longer can we afford to waste the development of ability if we are to maintain leadership." "It is the universities which train; it is in them that the fullness of knowledge dwells." "They look forward to an era of research, experiment, discovery, invention, and intellectual progress that shall surpass even the record of the century that is past." Not only are efficient buildings and equipment essential, but even more so are opportunities of free development unhampered by bureaucratic regulations, and of adequate maintenance for teachers and their satisfactory superannuation, whilst the provision of numerous maintenance scholarships is a necessity if the able children of the working community are to enjoy the advantage of a university education. No difficulty should be found in raising the funds necessary to ensure adequate support for the universities now so urgently appealing for funds in various parts of the country if only the wealthy members of society and the various local authorities within their respective areas would realise their responsibilities. There has arisen a great demand of late throughout England for the more complete provision of continued and higher education, and if this demand is to be met it is essential that the universities from which the chief inspiration should be derived shall be maintained in the fullest efficiency of means and methods.

Calendar of Scientific Pioneers.

June 2, 1886. James Apjohn died.—A lecturer and professor of chemistry at Dublin for more than fifty years and a vice-president of the Royal Irish Academy, Apjohn wrote on chemistry, mineralogy, and meteorology, and his name is connected with a formula for ascertaining the dew-point.

June 2, 1901. John Viriamu Jones died.—After a distinguished career at Oxford, Jones in 1881, at the age of twenty-five, became principal of Firth College, Sheffield, and two years later was made the first Principal of University College, South Wales. His principal scientific work referred to accurate determinations of electrical and physical standards.

June 2, 1903. Andrew Ainslie Common died.—An engineer by profession, Common devoted himself to the construction of large reflecting telescopes with silver-on-glass mirrors. Harvard and Lick Observatories possess instruments from his Ealing workshops. He received the gold medal of the Royal Astronomical Society for his photographs of the great nebula in Orion, and in 1895-96 was president of the society.

June 3, 1657. William Harvey died.—Born at Folkestone on April 1, 1578, Harvey was educated at Canterbury, Cambridge, and Padua, and, after graduating in medicine, settled in London. Appointed physician to St. Bartholomew's Hospital in 1609, six years later he became Lumleian lecturer at the College of Physicians, where he first publicly taught the doctrine of the circulation of the blood. His celebrated treatise, "Exercitatio Anatomica de Motu Cordis et Sanguinis," was published at Frankfurt in 1628. He was physician to James I. and Charles I. His tomb is at Hempstead, near Saffron Walden.

June 3, 1822. René Just Haüy died.—After many early privations, Haüy became a teacher in the College of Navarre in Paris. An accident to a crystal of calcareous spar led him to the discovery of the law of crystallisation. His first memoir on the structure of crystals appeared in 1784. He afterwards held important official positions, among which was the chair of mineralogy at the Jardin des Plantes.

June 5, 1716. Roger Cotes died.—In 1706, at the age of twenty-four, Cotes became the first Plumian professor of astronomy and natural philosophy at Cambridge. He assisted Newton in the revision of the "Principia," with Whiston gave one of the earliest courses of experimental philosophy, and in Trinity College erected an observatory. A man of exceptional genius, Newton, referring to his work on optics, remarked: "If Mr. Cotes had lived we should have known something."

June 7, 1826. Joseph von Fraunhofer died.—A glass-cutter's apprentice, Fraunhofer in 1804 became associated with Reichenbach, the instrument-maker. A skilful maker of telescopes, he invented the stage micrometer, the diffraction grating, and a form of heliometer. He discovered the dark lines in the spectrum previously seen by Wollaston, and laid the foundations of solar and stellar chemistry.

June 8, 1695. Christiaan Huygens van Zuylichem died.—The greatest of Dutch physicists, Huygens is a connecting link between Galileo and Newton. Born at The Hague in 1629, he spent many years of his life in Paris. He improved the telescope, discovered the first of Saturn's satellites, explained the nature of Saturn's ring, adapted the pendulum to clocks, and advocated the undulatory theory of light. His principal works were his "Traité de la lumière" and his "Horologium Oscillatorum." He is buried in St. Peter's, Leyden. E. C. S.

Societies and Academies.

LONDON.

Royal Society, May 26.—Prof. C. S. Sherrington, president, in the chair.—Sir Alfred Ewing: The atomic process in ferro-magnetic induction. The author's modification of Weber's theory of magnetisation is reconsidered in the light of (1) modern views regarding the structure of the atom and (2) the X-ray analysis of crystal structure. The rotatable Weber magnet seems to be an attribute of the atom, probably an electron system within it. Metallic iron is now known to be an aggregate of crystals, in each of which the space-lattice is the centred cube, with its atoms most closely grouped along the trigonal axes. It is along these axes that the Weber elements will point. Consequently an iron crystal is not magnetically isotropic. The small quasi-elastic or reversible part preceding the much larger changes which involve hysteresis corresponds to a reversible deflection of the Weber magnets through a small angle, generally of an order of 1° . The theory of the equilibrium of a row of magnets is considered. Experiments in which rows of Robison magnets with ball ends have their equilibrium upset by an extraneous field confirm the theory. The field which would break up rows of magnets set in the space-lattice close enough together to bring the reversible deflection within the above limit is calculated; it is larger than the field that suffices to produce strong magnetisation in iron, suggesting that the ordinary laws of force between magnetic elements cease to apply at interatomic distances.—C. D. Ellis: The magnetic spectrum of the β -rays excited by the γ -rays. The magnetic spectra of the β -rays ejected from various elements by the γ -rays of radium B have been examined by the focussing method. The positions of three strong lines occurring in the magnetic spectrum of radium B depend on the metal target used. Assuming that each of these three lines is due to a definite γ -radiation, it is shown that the energy of the β -rays forming a line is equal to an energy characteristic of the γ -radiation minus the work necessary to remove an electron from the K ring of the atom. By application of the quantum theory the frequency of the γ -rays can be determined from these characteristic energies. The natural β -ray spectrum of radium B can be explained in this way, the stronger lines resulting from the conversion of the γ -rays in the K ring, and the weaker lines from a similar conversion of the same γ -rays in the L ring.—S. Datta: The spectra of the alkaline earth fluorides and their relation to each other. A survey of the spectra of these compounds has been made and several new bands observed. These helped in the identification of homologous series of bands in the different spectra, and have suggested an empirical relation amongst them, based on the constants of the series equations and the molecular weight or the molecular number of the respective compounds. Starting with the series equation of the band-heads, an explanation has been given of the appearance of a "tail" in some of the bands. It has been shown that the frequency of the "tail" is a maximum or a minimum, and that the difference in wave-numbers of the heads and tails of the similar series is constant for the same compound, but varies from one another in a definite way.—Dr. W. L. Balls: A simple apparatus for approximate harmonic analysis and for periodicity measurements. The error involved in the use of this apparatus need not exceed 3 per cent. Its outstanding advantage is the speed with which determinations may be made. Thus in determinations of periodicity some fifty trial periods can be examined in less time than is required for the

computation of a single trial period under the periodogram arithmetical method.—Dr. G. R. Goldsbrough: The influence of satellites upon the form of Saturn's ring. The ring is supposed to be made up of small particles arranged in concentric circles and rotating about the primary. The satellite is assumed to follow an unperturbed circular orbit, and the influence of the rings upon one another is assumed negligible. To a close degree of numerical approximation the satellite Mimas is responsible for the position and width of Cassini's Division and for the clean-cut termination of the whole ring. Satellite Rhea accounts for the clean-cut commencement of the inner ring (or ring B), while a probable explanation is offered of the existence of the crêpe ring. If m be the mass of any particle, and M the mass of Saturn, and n the number of particles in any single ring, it is shown that

$$0 < m/M < 1.8/n^2.$$

The maximum mass of a particle is thus just below the limit given by Maxwell.—Dr. H. Jeffreys: Certain geological effects of the cooling of the earth. Mechanical consequences of the cooling of the earth from its formation to its present state are considered. The former fluidity of the earth is assumed and the information provided by radio-activity is utilised. The thermal contraction available for mountain-building is of the same order as that required to account for existing mountains. The Pacific type of mountain range can be explained as due to greater cooling and consequent greater strength of the rocks below the ocean. Isostatic compensation of surface inequalities is due to variation in the thickness of the light rocks constituting the crust, combined with plastic flow below. The fact that oceans have extensive regions of less depth in the middle is explained and theories of the formation of continents and geosynclines are suggested.—T. Kikuchi: The moving striations in a neon tube.

Geological Society, May 4.—Mr. R. D. Oldham, president, in the chair.—H. Hamshaw Thomas: An *Ottokaria*-like plant from South Africa. The discovery in the Vereeniging Sandstones of the Transvaal of a fossil plant which bears considerable resemblance to the genus *Ottokaria* is recorded. The specimen agrees with known examples in size, and in having an almost circular head seated upon a stalk; an additional feature is a thin flattened structure projecting beyond the head, provisionally called the "wing." *Ottokaria* was probably a reproductive structure, and its association with *Glossopteris* suggests a possible connection with this plant. The name of *Ottokaria Lesliei* is assigned to the specimen.—Dr. A. B. Walkom: On *Nummulospermum*, gen. nov., the probable megasporangium of *Glossopteris*. Seeds associated with some fronds of *Glossopteris* from Queensland are described under the name *Nummulospermum bovenense*. The vascular system is also partly described. The seeds have not been found in actual connection with *Glossopteris* fronds. Remarks are added on the scale-leaves of *Glossopteris*, and on the affinities of *Glossopteris*, which is classed with the Cycadofilicales. The anatomical features of the seeds suggest relationship with the Trigonocarpaceae.—Agnes McDonald and Dr. A. E. Trueman: The evolution of certain Liassic gastropods, with special reference to their use in stratigraphy. The gastropods dealt with are turriculate forms, formerly called *Cerithium*, now referred to the family Procerithidæ, Cossmann, and *Chemnitzia*, now referred to the family Loxonematidæ, Koken. Suggestions for the classification of these gastropods, based on ontogenetic and other evidence, are made. The position and characters of the ornamentation have proved of value in classifica-

tion, when taken in conjunction with the other characters of the shell. In numerous series acceleration or retardation of development is indicated, and examples of homœomorphy of several types have been noted. The Procerithidæ of the Lower Lias are chiefly species of *Procerithium*, in which the flattish whorls have reticulate ornament based on three spirals. This series probably gave rise to many recent *Cerithidæ* which have more than four spirals. Other genera of Procerithidæ are recognised. The pupoid forms which have been grouped in the genus *Exelissa* are regarded as catagenetic descendants of diverse species of *Procerithium*. The Loxonematidæ of the British Lias are of two types, one with axial ornament (*Zygopleura*), the other with axials and feeble spirals (*Katosira*). Each of these genera shows during the Lias an increase in the number and curve of the axials. In development axials always appear before spirals among the Loxonematidæ, while spirals are developed first among the Procerithidæ.

Physical Society, May 13.—Sir William Bragg, president, in the chair.—L. Hartshorn and E. S. Keeping: Notes on vacuum tubes used as detectors of electrical oscillations. The paper describes the development of a robust form of vacuum tube which was used as a detector of electrical oscillations in the "wireless" circuits carried by aeroplanes. Platinum electrodes are avoided, being replaced by strips of tinfoil, to which contact may be made by the spring clips holding the tube in position. It was found that when a discharge is passed through such a tube the walls are affected in such a way that thenceforth it is much easier to get a discharge to pass. The change produced by the first discharge is annulled by heating the tube above 210° C. Further, if the walls are coated on the inside with a metallic film, this first discharge is unnecessary, and the tube is unaffected by heating, but when the walls are coated with an insulator it is, if anything, more difficult to pass a discharge. A silica tube behaves like one coated with metal. It seems possible that the change in the tube may be due to the formation of a layer of gas molecules on the walls by the first discharge. The explanation of the behaviour of the silica tube is a difficulty.—B. W. Clack: The coefficient of diffusion of certain saturated solutions. This paper gives an account of experiments on the diffusivity of saturated solutions of KCl, NaCl, and KNO₃ at constant temperatures near 18° C., when the steady state of diffusion has been attained, employing a method similar to that previously used by the author (*Proc. Phys. Soc.*, vol. xxi., p. 863, 1908; vol. xxiv., p. 40, 1911; vol. xxvii., p. 56, 1914; vol. xxix., p. 49, 1916). The solution under investigation is maintained at complete saturation by the presence of salt crystals in the diffusion vessel; the theory takes into account the change in volume of this salt as it dissolves, and an expression is obtained for the coefficient of diffusion at complete saturation, which depends on the rate of change in weight of the diffusion vessel with time. The experimental results are found to agree very closely with the values obtained by extrapolation from the results previously found for less concentrated solutions. By the present paper the author has thus extended the range of concentration over which he has studied diffusion from very dilute solutions right up to complete saturation.—Dr. G. D. West: Experiments on thermal transpiration currents. Theoretical considerations are first introduced to show that if a radial temperature gradient be maintained over a disc so that the centre is the hottest part, thermal transpiration currents sweep radially inwards over the surface of the disc, and discharge themselves more or less radially outwards in the upper regions. To detect

these currents a narrow strip of foil is used which is placed perpendicular to the disc and to one side of the hot region. When at a considerable perpendicular distance from the disc, and when the gas pressure is sufficiently low to eliminate convection currents, the deflections of the strip of foil are always away from the hot region. When, however, the strip is placed very close to the disc its deflections over a certain range of gas pressure are towards the hot region. These facts are explained by the tendency of the thermal transpiration currents to drag the strip with them. The paper emphasises one of the essential differences between thermal transpiration currents and convection currents, namely, that while the latter clearly depend on gravitation, the former do not.

CAMBRIDGE.

Philosophical Society, May 2.—Prof. A. C. Seward, president, in the chair.—**E. K. Rideal**: Active molecules in physical and chemical reactions. The chemical nature of evaporation is established by the calculation of heats of reaction from spectral data with the aid of the quantum theory. Evaporation is regarded as a monomolecular chemical change; equating the rate of evaporation to the rate of condensation when equilibrium is attained, the unknown integration constants of the Clapeyron-Clausius equation, and thus the chemical constants of Nernst, have been determined. The values obtained agree closely with those experimentally derived. The energy of activation is probably an average value representing the mean energy of activation of a gram-molecule of reactant, and a formula from which it can be calculated is given. The hypothesis receives support from the fact that at the critical temperature the radiation intensity is at a maximum for light of the particular frequency with which the active molecules are in equilibrium. Wien's law $\lambda_m T = \text{constant} = 0.28986$ is shown to be a simple variant of Trouton's rule $L = KT_c$. The value of K as calculated from the purely radiation-derived data of Wien is found to be 0.866. The latent heats of evaporation calculated from Wien's law are found for non-associating liquids to agree very closely with those derived from vapour-pressure data. The equilibrium of the active molecules with the radiation may be ascribed to resonance.—**Dr. Hartridge**: (1) An experiment which favours the resonance theory of hearing. When the phase of a musical note is suddenly altered by π the note fades momentarily to silence, and returns a moment later to its former intensity. (2) A criticism of Wrightson's theory of hearing. A mathematical analysis is advanced to demonstrate the existence of the coincidences required by the theory between the lengths of the periodically repeated time-intervals in the separate tones and those present when all the tones are sounding together. They are found to be imaginary. (3) A method of projecting interference bands. If a celluloid replica diffraction grating be mounted in optical contact with a polished metal surface, and a beam of approximately monochromatic light be projected into it, the spectra produced are crossed by interference bands. (4) A method of projecting absorption spectra. If a celluloid replica diffraction grating be mounted on the hypotenuse of a right-angled glass prism, with the rulings parallel to the apex, and a beam of approximately parallel light be caused to enter along the normal to the base, a spectrum of wide dispersion and great intensity is produced. (5) The shift of absorption bands with change of temperature. The absorption bands of blood pigment in the visual region of the spectrum have been observed at the temperature of evaporation of liquid air and liquid nitrous oxide by drying films of a solution of the pigment

in gelatine on glass slabs and then immersing them in the cold liquids. It is found that such films retain their transparency. The reversion spectroscope shows that both α - and β -bands are sharper at low temperatures, and that they are displaced towards the violet end of the spectrum approximately 41 Å. The change in wave-length cannot be due to change in refractive index of the solvent, because dissolving blood pigment in glycerine instead of in water leaves the band unchanged.—**Dr. H. S. Carslaw**: The cooling of a solid sphere with a concentric core of a different material. The method used is to study the contour integrals over a certain standard path. Estimates of the age of the earth founded upon the present surface temperature gradient are discussed.—**C. R. G. Cosens**: An alignment chart for thermodynamical problems.—**Dr. T. J. I'A. Bromwich**: Symbolical methods in the theory of conduction of heat.—**C. V. Hanumanta Rao**: A property of focal conics and of bicircular quartics.

DUBLIN.

Royal Dublin Society, April 26.—**Dr. F. E. Hackett** in the chair.—**J. Davidson**: Biological studies of *Aphis rumicis*.—**H. G. Becker**: A new principle in blow-pipe construction. The essential features of a quick-change blow-pipe to operate with air at constant pressure, such as is supplied by a blower driven by power, are discussed and the necessity for air-jets of different bore for the different flames is emphasised. The tubular shape common to all hitherto existing blow-pipes is shown to be unnecessarily cumbersome, and is therefore abandoned. A form of blow-pipe giving a great range of flames (including a flat blow-pipe flame), each provided with an air-jet of suitable size and allowing of instantaneous change from one to the other, was described, and an actual blow-pipe constructed on this principle was shown in operation.

PARIS.

Academy of Sciences, May 9.—**M. Georges Lemoine** in the chair.—**F. Widal**, **P. Abrami**, and **J. Hutinel**: Comparative researches on the working of the liver following surgical anaesthesia produced by chloroform, ether, nitrous oxide, or novocaine. It has been shown in previous communications that slight functional alterations in the liver can be detected by simple leucocyte counts, after absorption of a glass of milk. The method has been applied to the study of the functional derangements of the liver produced by anaesthetics. Chloroform, ether, and nitrous oxide produced derangements of function, chloroform acting most powerfully. Injections of novocaine were without effect on the liver.—**M. Georges Urbain** was elected a member of the section of chemistry in succession to the late M. Emile Bourquelot.—**F. Vanev**: The polynomials of Laguerre.—**A. Angelesco**: A representation of polynomials by integrals.—**R. Birkeland**: The convergence of the developments which express the roots of the general algebraic equation by a sum of hypergeometric functions of several variables.—**B. Gambier**: Real non-unicursal algebraic curves with constant torsion.—**M. Idrac**: Experimental studies on hovering flight. In an earlier note the opinion was expressed that wherever birds are hovering in stationary flight they are always in a zone where the wind has a vertical ascending component. Results confirming this view are now given, and records of the variations in temperature and pressure of the air taken on apparatus carried by captive balloons are reproduced.—**J. Vallot**: Study of the diffuse radiation of the sky compared with the direct solar radiation. The total diffuse radiation is considerable, and may amount to one-third of the solar radiation.—**A. Leduc**: A new equation of state for gases based on a know-

ledge of the internal pressures.—H. Abraham and R. Planiol: The use of the Baudot telegraph in wireless telegraphy. The Baudot quadruple instrument used in the ordinary way records 7200 words per hour. A description of the adaptation of this to wireless transmission is given. The first experiments were made across Paris; later the apparatus was successfully used between Paris and Nogent-le-Rotrou.—M. St. Procopiu: Electrical double refraction of mixed liquids and crystalline structure.—A. E. Lindh: The absorption spectra of chlorine for the X-rays. All chlorides in which the chlorine is monovalent have similar X-ray spectra, but there is a displacement of the limits of absorption in $KClO_3$ and $KClO_4$, compounds in which the valencies are 5 and 7.—D. Coster: The principle of combination and the law of Stokes in the X-ray series.—MM. M. Menard and Pestel: Concerning the danger of radiological installations. The authors conclude that, provided the usual precautions required for the safety of the operator are taken, there is no real danger to third parties in neighbouring rooms.—A. Tian: A theory of the slow hydrolysis of salts.—MM. P. Jolibois and Bouvier: The reversibility of the reaction $CaCO_3 = CO_2 + CaO$. The self-recording apparatus described in an earlier paper has been applied to the study of the dissociation of calcium carbonate. The heating and cooling curves are not the same, and hence the reaction is not strictly reversible.—G. Dupont: Contribution to the study of the acid constituents of the exudation of the maritime pine. The composition of pimaric acid. Pimaric acid purified by Vesterberg's method is a mixture of 37 per cent. of dextropimaric acid and 63 per cent. of the lævo-acid.—L. Longchambon: The measurement of the rotatory power in biaxial crystals.—L. Cayeux: The petrographic rôle of fossil Alcyonaria deduced from the analysis of the Jurassic iron minerals of France.—L. Joleaud: A deep boring which demonstrates the existence of transported strata in northern Tunisia. A trial boring for oil made at Ain-Rhelal started in the Middle Miocene, then passed through the Trias (630 metres), and finally met with strata undoubtedly belonging to the Upper Cretaceous.—F. Ehrmann: The Trias of the Kabylie des Babors (Algeria).—J. Beauverie: The resistance of mitochondria and plasts, and relations with attacks by parasites.—G. Mangenot: The structure of the antherozoids of the Fucaceæ.—R. Lance: The use of coloured screens for fighting against cryptogamic diseases of plants. The plants are sprayed with solutions containing blue, green, and violet dye. The fluid dries and leaves the parts of the plant covered with a colour screen allowing blue, violet, and ultra-violet light to pass. No results of the treatment are given.—R. Lance: An anticryptogamic product. A proposal to use salts of zinc for spraying plants.—M. Mirandé: Seeds giving hydrogen sulphide by fermentation belonging to the family of the Papilionaceæ. Many leguminous seeds, including beans, peas, and lentils, when moistened with water undergo a spontaneous fermentation, one of the products of which (sulphuretted hydrogen) is poisonous.—C. Champy: The experimental change of sex in *Triton alpestris*. A male, subjected to starvation, had its testicle replaced by a fatty band containing neither spermatocytes nor spermatozooids. Two animals after winter starvation were intensively fed. The external colouring changed from male to female in character. One of these was killed, and showed the adipose band; the second, killed two months later, showed a genital gland (section shown in diagram) corresponding to the ovary of a young female.—L. Roule and F. Angel: Fishes of the family of the Diretmidæ and their place in classification.—A. Gruvel: The geographical distribution of some Madagascan lobsters

and their commercial exploitation.—J. Dragoiu and F. Vlès: The cytological consequences of the osmotic arrest of cell division. The increase of the external osmotic pressure first retards, then stops, the division of the cytoplasm. With additional increase of osmotic pressure the internal evolution of the cell is progressively changed in a regular manner. The whole process simulates a kind of regression of nuclear evolution.—M. Doyon: The use of chloroform for the preparation of nucleo-proteids and nucleic acids active *in vitro* on the blood. The complexity of the action of the nucleic acids *in vitro*.—M. Bordier: The usefulness of diathermal d'Arsonvalisation in atonic wounds.

Books Received.

The Works of Aristotle. Translated into English under the editorship of W. D. Ross. Vol. x.: *Politica*. By Benjamin Jowett. *Oeconomica*. By E. S. Forster. *Atheniensium Respublica*. By Sir Frederic G. Kenyon. Unpaged. (Oxford: Clarendon Press.) 15s. net.

Insects and Human Welfare. By Prof. Charles T. Brues. Pp. xii+104. (Cambridge, Mass.: Harvard University Press; London: Oxford University Press.) 10s. 6d. net.

Fugitive Essays. By Josiah Royce. Pp. 429. (Cambridge, Mass.: Harvard University Press; London: Oxford University Press.) 17s. net.

Aeroplane Performance Calculations. By Harris Booth. (The D.-U. Technical Series.) Pp. xv+207. (London: Chapman and Hall, Ltd.) 21s. net.

Landscape Gardening. By Andrew J. Downing. Tenth edition, revised by Frank A. Waugh. Pp. xv+439. (New York: J. Wiley and Sons, Inc.; London: Chapman and Hall, Ltd.) 36s. net.

The Study of Geological Maps. By Dr. Gertrude L. Elles. (Cambridge Geological Series.) Pp. viii+74+vii plates. (Cambridge: At the University Press.) 12s. net.

The Journal of the Royal Anthropological Institute. Vol. 1., 1920, July-December. Pp. x+237-465+12+plates. (London: Royal Anthropological Institute.) 15s. net.

The Relative Value of the Processes Causing Evolution. By Dr. A. L. Hagedoorn and A. C. Hagedoorn-Vorstheuveel a Brand. Pp. v+294. (The Hague: M. Nijhoff.) 9 glds.

The Reign of Relativity. By Viscount Haldane. Pp. xxiii+430. (London: J. Murray.) 21s. net.

Memoirs of the Geological Survey: England and Wales. The Water Supply of Buckinghamshire and of Hertfordshire from Underground Sources. By W. Whitaker. Pp. iv+368. (Southampton: Ordnance Survey Office; London: E. Stanford, Ltd.) 16s. net.

The Banana: Its Cultivation, Distribution, and Commercial Uses. By William Fawcett. Second and enlarged edition. Pp. xi+299. (London: Duckworth and Co.) 15s. net.

Diary of Societies.

THURSDAY, JUNE 2.

INDUSTRIAL WELFARE SOCIETY (at 51 Palace Street, S.W.1), at 10.30.—Dr. R. M. Wilson: Medical Service in Industry.—Prof. F. L. Collis, Dr. T. M. Legge, and Dr. H. Ross: Discussion on Health Problems in Industry.

ROYAL SOCIETY OF MEDICINE (Laryngology Section) (Summer Meeting), 2.30 to 6.

ROYAL INSTITUTION OF GREAT BRITAIN, at 3.—Sir Alexander C. Mackenzie: Beethoven.

INSTITUTE OF PATHOLOGY AND RESEARCH (at St. Mary's Hospital), at 4.30.—Prof. G. Dreyer: A New Departure in the Serum Diagnosis of Syphilis.

ROYAL SOCIETY, at 4.30.—Dr. T. M. Lowry and Dr. C. P. Austin: Optical Rotatory Dispersion (The Bakerian Lecture).

LINNEAN SOCIETY, at 5.—Prof. Garstang and Others: Discussion on Biogenetic Law (Recapitulation).

CHILD-STUDY SOCIETY (at Royal Sanitary Institute), at 6.
 ROYAL INSTITUTE OF BRITISH ARCHITECTS, at 8.—H. M. Fletoher: Building a House.
 CHEMICAL SOCIETY, at 8.—H. King: Derivatives of Sulphur in Commercial Salvarsan. Part I.—S. Glasstone: Physical Chemistry of the Oxides of Lead. Part I. The Solubility of Lead Monoxide.—M. O. Forster and W. B. Saville: Studies in the Camphaze Series. Part XXXIX. *p*-Aminophenylaminocamphor (Camphoryl-*p*-phenylenediamine).—K. Stratton and J. R. Partington: Latent Heats of Fusion. Part I. Benzophenone, Phenol, and Sulphur.—G. T. Morgan and H. D. K. Drew: Researches on Residual Affinity and Co-ordination. Part V. Gallium Acetylacetonate and its Analogues.—J. C. Thomlinson: Analysis of Cresol Disinfectants.—G. T. Morgan and D. Webster: Diazo-derivatives of 4-amino-phenyl-4'-methylbenz-2/7-thiazole (Dihydrothio-*p*-toluidine).—A. K. Macbeth and D. D. Pratt: The Labile Nature of the Halogen Atoms in Substituted Nitromethanes.—K. G. Naik: The Formation and Properties of Dithioketones (R₂C: S: S) and Dithioethers (R₂S: S). Part II.—K. G. Naik: The Formation and Properties of Dithioketones (R₂C: S: S) and Dithioethers (R₂S: S). Part III. Interaction of Sulphur Monochloride with Organic Compounds containing the grouping
 —CO—CH₂—CO—CH₂—CO—

K. G. Naik: The Formation and Properties of Dithioketones (R₂C: S: S) and Dithioethers (R₂S: S). Part IV. Interaction of Sulphur Monochloride with Organic Compounds containing —CO—CH₂—CO— grouping, forming the Part of a Closed Ring.—K. G. Naik: The Formation and Properties of Dithioketones (R₂C: S: S) and Dithioethers (R₂S: S). Part V. Nitration of Dithioketones and Dithioethers.—K. G. Naik: Interaction of Sulphur Monochloride with Organic Acid Amides.—S. J. Lewis and F. M. Wood: A New Adjustable Thermostat for all Temperatures between 0° and 100°.—H. Burton and J. Kenner: The Influence of Nitro-groups on the Reactivity of Substituents in the Benzene Nucleus. Part III. The Partial Reduction of the Dinitrotoluenes by Stannous Chloride and Hydrochloric Acid.—J. Kenner and E. Witham: The Influence of Nitro-groups on the Reactivity of Substituents in the Benzene Nucleus. Part IV. The Condensation of Ethyl 3- and 5-nitro-*o*-Chlorobenzoates with Hydrazines.
 SOCIOLOGICAL SOCIETY (at 65 Belgrave Road), at 8.15.—Prof. Abercrombie: The Municipal Survey of Sheffield.

FRIDAY, JUNE 3.

ROYAL SOCIETY OF MEDICINE (Laryngology Section) (Summer Meeting), 10 to 1.
 ASSOCIATION OF ECONOMIC BIOLOGISTS (in Botanical Lecture Theatre, Imperial College of Science), at 2.30.—F. L. Engledow: Methods of Increasing Yield in Crop Plants.—C. B. Saunders: Some Problems of Seed Testing.—W. Brown: The Physiology of Infection.
 ROYAL SOCIETY OF TROPICAL MEDICINE AND HYGIENE (at 11 Chandos Street, W.1) (Adjourned Meeting), at 5.—Lt. Col. H. Kirkpatrick: Some Points on Trachoma.—C. Franca: An Early Portuguese Contribution to Tropical Medicine.
 ROYAL PHOTOGRAPHIC SOCIETY OF GREAT BRITAIN, at 8.—M. Adams: Eyes in Portraiture.
 ROYAL INSTITUTION OF GREAT BRITAIN, at 9.—Dr. L. Huxley: Chronicle of the Cornhill.

SATURDAY, JUNE 4.

ROYAL INSTITUTION OF GREAT BRITAIN, at 3.—Dr. R. S. Rait: Scotland and France.

MONDAY, JUNE 6.

VICTORIA INSTITUTE (at Central Buildings, Westminster), at 4.30.—Rev. Prebendary H. E. Fox: The Roman Wall in North Britain.
 INSTITUTE OF ACTUARIES (Annual General Meeting), at 5.
 ROYAL INSTITUTION OF GREAT BRITAIN, at 5.—General Meeting.
 ROYAL INSTITUTE OF BRITISH ARCHITECTS, at 8.
 SOCIETY OF CHEMICAL INDUSTRY (London Section) (at Chemical Society), at 8.—Dr. L. Levy: Industrial Respirators.—Prof. K. G. Naik: The Gold and Silver Thread Industry in India.
 ROYAL GEOGRAPHICAL SOCIETY (at Eolian Hall), at 8.30.—E. Teichman: Journeys in Kam.

TUESDAY, JUNE 7.

ROYAL HORTICULTURAL SOCIETY, at 3.
 ROYAL INSTITUTION OF GREAT BRITAIN, at 3.—Sir James Frazer: London Life: Time of Addition.
 MIDICO-PSYCHOLOGICAL ASSOCIATION OF GREAT BRITAIN AND IRELAND (at Maudsley Hospital, Denmark Hill), at 4.30.—Sir Frederick Mott: Second Maudsley Lecture.
 ZOOLOGICAL SOCIETY OF LONDON, at 5.30.—Dr. F. M. Chapman: The Distribution of Bird-life in the Urubamba Valley of Peru.—S. Mauflk: New Indian Drilid Beetles.—Prof. J. P. Hill: Exhibition of Some Marsupial Embryos, especially the Koala and the Wombat.—R. I. Pocock: The External Characters of the Koala (Phascogaleos) and Some Related Marsupials.—Dr. C. F. Sonntag: The Comparative Anatomy of the Koala (Phascogaleos cinereus) and the Vulpine Phalanger (*Trichosurus vulpecula*).

WEDNESDAY, JUNE 8.

BRITISH SCIENCE GUILD (Annual Meeting) (at Goldsmiths' Hall, Foster Lane), at 3.—Lord Montagu de Beaulieu: The Work of the Guild.—The Dean of St. Paul's: The Road to Ruin and the Way Out.—Sir Richard A. S. Redmayne: The Importance of Research in Promoting the Development of the Mineral Industries.
 GEOLOGICAL SOCIETY OF LONDON, at 5.30.—Dr. W. Fraser Hume: The Relations of the Northern Red Sea and its Associated Gulf Areas to the "Rift" Theory.

INSTITUTION OF ELECTRICAL ENGINEERS (Wireless Section) (at Savoy Place), at 6.—Prof. J. S. Townsend: Electric Oscillations along Straight Wires and Solenoids.

THURSDAY, JUNE 9.

INSTITUTION OF MINING ENGINEERS (at Geological Society), at 11.—Third Report of the Committee on "The Control of Atmospheric Conditions in Hot and Deep Mines."—J. P. Rees: Observations of Temperature and Moisture in Deep Coal-mines.—Prof. H. C. Briggs: Characteristics of Outbursts of Gas in Mines.—H. O. Harrison: The Use and Distribution of Shale-dust in Mines. The following papers, which have already appeared in the Transactions, will be discussed:—A. E. Beet and A. E. Findley: The Better Utilisation of Coking Slack.—J. I. Graham: The Normal Occurrence of Carbon Monoxide in Coal-mines.—T. L. Galloway: An Improved Method of Determining the Relative Directions of Two Reference-lines or Bases for Mining Surveys.—E. Bury, W. Broadbridge, and A. Hutchinson: Froth Flotation as Applied to the Washing of Industrial Coal.
 INSTITUTE OF PATHOLOGY AND RESEARCH (at St. Mary's Hospital), at 4.30.—Dr. H. Head: Release of Function in the Nervous System.
 ROYAL SOCIETY, at 4.30.—Probable Papers.—Prof. C. S. Sherrington: Break-shock Reflexes and "Supramaximal" Contraction-response of Mammalian Nerve-muscle to Single-shock Stimuli.—R. J. Ludford and J. B. Gatenby: Dietyokinesis in Germ Cells, or the Distribution of the Golgi Apparatus during Cell Division.—Dr. F. W. Edridge-Green: The Effect of Red Fatigue on the White Equation.—E. Ponder: A Method for Investigating the Hæmolytic Activity of Chemical Substances.—W. H. Pearsall: The Development of Vegetation in the English Lakes, considered in Relation to the General Evolution of Glacial Lakes and Rook Basins.
 LONDON MATHEMATICAL SOCIETY (at Royal Astronomical Society), at 5.—M. J. Conran: Curvature and Torsion in Elliptic Space.—J. L. S. Hatton: The Inscribed, Circumscribed, and Self-conjugate Polygons of Two Conics.—M. J. M. Hill: The Differential Equations of the First Order derivable from an Irreducible Algebraic Primitive.—F. S. Macaulay: Note on the Resultant of a Number of Polynomials of the Same Degree.
 ROYAL COLLEGE OF PHYSICIANS OF LONDON, at 5.—Dr. F. L. Golla: The Objective Study of Neurosis (Croonian Lecture).
 OPTICAL SOCIETY (at Imperial College of Science), at 7.30.—H. Lee: Achromatism.—W. L. Custance: Demonstration of the Société Genevoise Universal Measuring Machine.

FRIDAY, JUNE 10.

ROYAL SOCIETY OF ARTS (Indian Section), at 4.30.—Sir George Seymour Curtis: The Development of Bombay.
 ROYAL ASTRONOMICAL SOCIETY, at 5.
 PHYSICAL SOCIETY OF LONDON (at Imperial College of Science), at 5.—Sir Ernest Rutherford: The Stability of Atoms (Lecture).
 ROYAL INSTITUTION OF GREAT BRITAIN, at 9.—Dr. A. G. Webster: Absolute Measurements of Sound.

CONTENTS.

PAGE

The Metric System and World Trade	417
Lamarckism Unshamed. By J. A. T.	419
Dyes and Dyeing. By Dr. J. Huebner	421
Time and Space. By J. F. T.	422
Our Bookshelf	422
Letters to the Editor:—	
Earth-worms, Mud-worms, and Water-worms.—Sir E. Ray Lankester, K.C.B., F.R.S.	424
Biological Terminology.—Sir G. Archdall Reid, K.B.E.	425
The Great Sun-spot Group and Magnetic Disturbances, May 8-21.—Father A. L. Cortie, S.J.	426
The Reparation Act and Scientific Research.—J. S. Dunkerly	427
The Cosmology of Dante. (Illustrated.) By Dr. J. L. E. Dreyer	428
The Natural History of Cultivated Plants	430
Obituary:—	
Prof. E. J. Mills, F.R.S. By J. M. T.	432
Notes	434
Our Astronomical Column:—	
Pons-Winnecke's Comet	438
Speculations on the Formation of Spiral Nebulae	438
The Companion of a Hercules	438
Administration of Scientific Work	439
New Technical Applications of an Electrostatic Principle	439
Dalton and Atomic Symbols	440
The Melbourne Meeting of the Australasian Association. II.	440
University and Educational Intelligence	442
Calendar of Scientific Pioneers	444
Societies and Academies	444
Books Received	447
Diary of Societies	447



THURSDAY, JUNE 9, 1921.

Editorial and Publishing Offices:

MACMILLAN & CO., LTD.,

ST. MARTIN'S STREET, LONDON, W.C.2.

Advertisements and business letters should be
addressed to the Publishers.

Editorial communications to the Editor.

Telegraphic Address: PHUSIS, LONDON.

Telephone Number: GERRARD 8830.

Co-operative Indexing of Periodical Literature.

THE selection, examination, and classification of the valuable matter contained in periodical literature is performed by two agencies, viz. certain abstracting and indexing societies and journals. "Science Abstracts" and the abstracts published by the chemical societies of England, France, Germany, and the United States are examples of the former class, while the "International Catalogue of Scientific Literature," the "Engineering Index," the "Index Medicus," the "Index to Legal Periodicals," and the various indexes published by the Anglo-American library associations represent the latter. Almost without exception, where the same field is covered by both types of publication, the two agencies work independently of each other. Further, in this country the publication of abstracts generally precedes the corresponding index publication, especially where the latter makes any pretence to completeness. This obviously is an indefensible arrangement; for the index material, which is the result of the wider survey, should be accessible to the abstractor prior to the preparation of the abstracts. We propose to indicate how this change could be accomplished with a minimum of disturbance to existing interests. It should be observed that the phrase "periodical literature" is used in its widest sense to include society publications and institutional reports, as well as annual, quarterly, monthly, and weekly publications.

The growth of periodical literature owing to the

increased specialisation of knowledge is one of the most significant features of our times. A union catalogue of the current periodicals preserved in the German libraries, published in 1914, comprised some 17,000 entries. A similar list for the periodicals filed in the libraries of the United Kingdom, prepared in 1914-15 by some English State and Copyright librarians, was submitted for publication to the Department of Scientific and Industrial Research, but the proposal met with no encouragement. Yet the compilation of such a list is an essential preliminary to the proper national organisation of knowledge. For a union list indicates the relative strength and weakness of our national libraries in respect of their periodical collections: it enables the librarian to correct the latter without unduly increasing the expenditure of the library in that department of literature. Moreover, while primarily a time-saving expedient for locating the place of deposit of a periodical, it emphasises the essential unity of the library service in the satisfaction of the legitimate requirements of research. Our first proposal, therefore, is that representations should be made to the Trustees of the British Museum with the view of inducing them to undertake this necessary piece of national work. These representations would carry greater weight if accompanied by some guarantee of financial support. The work done in 1914-15, which is in the custody of the British Museum library authorities, would, of course, require considerable revision and extension, but the cost of its publication should not exceed 500*l.*—a portion of which would be recouped by its sale.

That a large proportion of periodical literature is of an extremely composite character is, of course, a commonplace; but the labour which this feature entails upon those responsible for the collection of material relevant to their particular fields of inquiry is not equally well realised. This composite character applies not only to the popular magazines and journals, but also to the repositories of original investigations in all branches of knowledge. The *Comptes rendus* of the Paris Academy, for example, furnish material not only for the seventeen sections of the "International Catalogue," but also for psychology, education, archæology, and technology. In the *Sitzungsberichte* of the Berlin Academy theories of relativity jostle with disquisitions on Hittite inscriptions and Turco-Tataric philology. In short, periodical literature may be said to consist of two classes: (a) watertight

compartments containing homogeneous material, and (b) compartments which admit freely any literary matter of sufficient merit or popular appeal. The problem, therefore, is to devise a scheme by which information contained in the latter class—for class (a) presents no special difficulties—can be made to flow towards its proper recipient, and this, obviously, can be effected economically only by the acceptance of a common system of classification.

So far as the literature of science is concerned, a classification already exists in the scheme adopted by the "International Catalogue of Scientific Literature." This scheme has been incorporated in that of the Library of the United States Congress—a library the staff of which appears to possess special qualifications for dealing with the literature of the exact sciences. Further, this scheme has been published in two forms: (a) with its headings arranged in class order and, issued in separate sections, e.g. Q=science in general [QA=mathematics, and so forth]; and (b) with its headings arranged in one general alphabet. Thus science possesses a classification stamped with its own hall-mark, but grafted on to a scheme for the general classification of knowledge. Still, the acceptance of the Library of Congress classification is not an essential feature of these proposals, which are based on the recognition (1) of the division of periodical literature into (a) the homogeneous and (b) the non-homogeneous classes; (2) of the economic advantage of dealing on a co-operative basis with the latter; and further, since the non-homogeneous periodicals cover all departments of knowledge, (3) of the necessity of adopting some agreed system of classification for the purpose of establishing a means of exchange between the different interests.

Thus we have shown that the core or *umbra* of a subject is comprised in a body of homogeneous literature which unquestionably can best be dealt with by its representative professional society, but that outside this core there exists a *penumbra* of relevant matter dispersed through a literature of gradually increasing irrelevance, with the result that the recovery of the relevant matter can be effected economically only by co-operative effort. The solution, therefore, would appear to be to bring into existence a Central Bureau which should deal solely with the indexing of periodicals of the non-homogeneous character—and in the first stages of its work, with a restricted list of periodicals assigned to it by the

contributory bodies. These bodies would receive from the Central Bureau entries from the periodicals examined corresponding to their specified requirements. But as the professional abstracts became more fully representative of progress in their respective fields the need for the publication of the corresponding indexes would tend to disappear. The institution, therefore, of a Central Bureau would ultimately make for economy in all branches of science in which the publication of abstracts is admittedly indispensable.

So far as science is concerned, it will probably be found that the simplest and most effective method for obtaining the necessary index slips would be to invite the Central Bureau of the "International Catalogue of Scientific Literature" to provide them. Indeed, the possibility of co-operation between the "International Catalogue" and the abstracting journals was one of the subjects considered at the conference held last September. Any such arrangement would probably begin with the year 1921, and, as a preliminary, the "International Catalogue" should be brought up to date by the publication of volumes for 1915–20. The provision of funds for this purpose is an urgent necessity, as explained in NATURE for October 7, 1920, vol. cvi., p. 195.

In the foregoing observations we have assumed that the proper bibliographical equipment of the sciences will in the main be founded upon the possession of adequate abstracts. But if the subject were threshed out in an open conference at which representatives of all branches of knowledge were invited to attend, this proposition would not be accepted as holding good universally. Some branches would probably prefer periodical critical reviews or summaries of the year's progress, while others would be content with alphabetically arranged index entries. Our final proposal, therefore, is that such a conference should be held in order that the special requirements of each division of knowledge should be authoritatively ascertained, and the feasibility of co-operative or co-ordinated action discussed.

Piezo-chemistry.

Piezochemie kondensierter Systeme. By Prof. E. Cohen and Dr. W. Schut. Pp. ix+449. (Leipzig: Akademische Verlagsgesellschaft m.b.H.: Gustav Fock, 1919.)

THE direction and extent of a physical or chemical change are frequently determined or modified by pressure. This fact has long been

known, and has been the subject of occasional investigation at various times, even from the earliest periods of systematic scientific inquiry. It occupied the attention of the first Italian academies, and was among the matters experimentally studied by the Fellows during the early years of the Royal Society. Until comparatively recent times, however, work on the subject was sporadic, intermittent, and directed mainly to the investigation of particular cases rather than to the elucidation of general principles. The necessities of modern chemical manufactures have created a demand for further and more accurate knowledge, inasmuch as the whole course of a chemical reaction and its economic aspect may depend upon it. Many instances of this fact might be cited. One of the most recent, and also one of the most striking, is seen in the case of the synthetic production of ammonia from its elements under the influence of catalysts, in which the question of the appropriate pressure is of fundamental importance.

Prof. Ernst Cohen, of the van't Hoff Laboratory of the University of Utrecht, and his co-laborator, Dr. W. Schut, have placed chemists and physicists under a great obligation by their compilation of the book now under review. It does not profess to be a text-book on the subject. It is, as stated, a compilation of the facts known, or allowed to transpire, scattered through the volumes of some fifty different periodicals, and was originally made for the convenience of workers on the subject of piezo- (or pressure) chemistry in the laboratory which Prof. Cohen directs. The material thus accumulated has been arranged in a systematic and orderly manner. We have, first, a description of the methods of creating and measuring high pressures; next, a general discussion of compressibility, its methods, direct and indirect, with some account of their relative merits and defects. Then follows a full historical description of the several attempts to obtain accurate values of certain fiduciary constants generally necessary in piezometric work—viz. the compressibility coefficients of glass, mercury, water, and incidentally of ice, and their relation to temperature. Each section is accompanied by bibliographical references to the original sources of information.

The authors then treat of the compressibility coefficients of the various elements and such of their compounds as have been studied. Special attention is, of course, paid to the work of Richards, of Harvard, and his co-workers, and the question of the compressibility of atoms and

the existence of interatomic spaces in solids and liquids is shortly discussed, mainly in the light of the American chemist's published views on the subject. As regards liquids, an attempt is made to group them in conformity with their chemical relationships. Thus all the hydrocarbons are brought together, as are the alcohols, esters, halogen compounds, acids, etc., obviously with the view of facilitating the detection of general principles. It must be confessed, however, that as yet the data afforded by different investigators are too discrepant to afford a satisfactory basis for generalisations. This is due mainly to imperfections in the method of observation, and in a less degree in some cases to insufficient care in the purification of the liquids employed. Accurate work, like that of Bridgman, suffers by association with that of earlier inquirers whose measurements were largely of the pioneering order.

Although definite numerical values are lacking in many cases, certain conclusions may be said to be fairly well established. Thus, for example, Bartoli has shown that the compressibility-coefficient in an homologous series of the liquid paraffins decreases with the increase of molecular weight. That the same is true of the aromatic hydrocarbons appears from the observations of Richards and his co-workers. Measured at equal temperatures and pressures, benzol is more compressible than toluol, and toluol than xylo. The various isomerides of xylo have, however, different compressibilities, *o*-xylo being less compressible than *m*-xylo, which in its turn is more compressible than *p*-xylo, and still less compressible than ethyl-benzol. Identical thermometric temperatures, strictly speaking, are not absolute evidence of a comparable physical condition. Before any sound deductions can be made it will be necessary to establish what is a valid comparable condition. There is a considerable volume of work on the compressibility of liquids, but its treatment and discussion are vitiated by the circumstance that this point has hitherto been insufficiently appreciated. For a fuller account of the relation of compressibility to the chemical nature and constitution of liquids, Prof. Cohen's volume must be consulted.

The influence of pressure upon the expansion-coefficients of substances—solids, liquids, solutions, and alloys—and upon surface tension and melting-point has been studied by many observers. Their work has been systematically collated by the authors, and its outcome discussed. The case of water is of special interest, on

account of the abnormality it displays in so many particulars. It is well known that the temperature of maximum density of water is lowered by pressure, a fact which was established by Tait in 1883, and, later, by Amagat, and confirmed on theoretical grounds by van der Waals and Puschl. Each increment of 1 atmosphere pressure lowers the temperature of maximum density by 0.0217° C. The influence of pressure on the melting-point of ice is equally well known, and has been frequently studied since it was first pointed out by James Thomson and his brother, Lord Kelvin, in 1849, and its natural effect traced by Faraday and Tyndall in the phenomenon of regelation and the movement of glaciers. The large body of evidence on the relation of pressure to melting-point has been carefully collected and displayed in tabular form. For its discussion we must refer to the work itself.

A considerable section of the work is devoted to a consideration of the influence of pressure upon the flow and permanent increase of density of solid substances, and upon the viscosity of liquids. As regards water, the viscosity diminishes with increasing pressure up to 900 atmospheres, between 0° and 32° C., when it attains a minimum. Above this temperature it increases by pressure; below it it decreases in proportion to the increase of pressure. All the phenomena of the compressibility of water serve to confirm the general belief that it is an associated liquid—i.e. its molecular complexity under ordinary natural conditions is not properly represented by the simple formula H_2O .

Space will not permit of more than the briefest possible reference to the remaining sections of this valuable work. These treat of the influence of pressure on the electric conductivity of solutions and solids; on the thermo-electric properties of metals; on dielectric constants; on the validity of Faraday's first law; on solubility, diffusion, refractive index, and polarimetry.

It will be seen from this account that the work is mainly concerned with the influence of pressure upon the physical properties of substances, and to that extent its title is rather a misnomer. It might, perhaps, be more fittingly styled piezo-physics. However, the border-line between physics and chemistry is becoming more and more ill-defined, for the spheres of the two sciences gradually merge into each other. There is some point in the good-natured gibe that chemistry, after all, is only the dirty part of physics. We may, however, express the hope that the authors will add to our obligation by extending their work

so as to include the influence of pressure upon chemical change. There is now a fairly abundant literature upon the subject, but it requires to be collected, annotated, and digested, and its general principles elucidated. T. E. THORPE.

Social Degeneration.

- (1) *Social Decay and Regeneration*. By R. Austin Freeman. With an introduction by Havelock Ellis. Pp. xx + 345. (London: Constable and Co., Ltd., 1921.) 18s.
- (2) *The History of Social Development*. By Dr. F. Müller-Lyer. Translated by Elizabeth Coote Lake and H. A. Lake. With an introduction by Prof. L. T. Hobhouse and Prof. E. J. Urwick. (Studies in Economics and Political Science.) Pp. 362. (London: George Allen and Unwin, Ltd., 1920.) 18s. net.

(1) SAMUEL BUTLER tells us that the Erewhonians destroyed all their machines and lived happily ever after. An Erewhonian financier pointed to the "magnificent ruins of the railway-station" as an object of interest in his park. Mr. Austin Freeman, in all seriousness, agrees with the Erewhonians. His book is a searching indictment of the machine as the cause of our present discontents.

Ill fares the land, to hastening ills a prey,
Where wealth accumulates and men decay.

The decay wrought by machinery is not numerical; it is something much worse. The ultimate factor of national decline is racial deterioration; and in modern societies this is very extensive and pernicious. Unfavourable variations are not eliminated, and there is a reversed natural selection in favour of the unfit. The essential character of modern civilisation is a war of mechanism on man.

"Mechanism has destroyed industry and replaced it by mere labour; it has degraded and vulgarised the works of man; it has destroyed social unity and replaced it by social disintegration and class antagonism to an extent which directly threatens civilisation; it has injuriously affected the structural type of society by developing its organisation at the expense of the individual; it has endowed the inferior man with political power which he employs to the common disadvantage by creating political institutions of a socially destructive type; and finally, by its reactions on the activities of war, it constitutes an agent for the wholesale physical destruction of man and his works and the extinction of human culture. It is thus strictly analogous to those anti-bodies by

which the existence of aggregates of the lower organisms is brought to an end."

These charges are driven home in the most forcible manner. The old craftsman, who made a pair of boots and enjoyed his work, has been displaced by a crowd of factory hands, not one of whom could make a pair of boots, and whose work is irksome drudgery. By absorption into an organised aggregate the workman has become functionally atrophied; he has undergone degeneration. The working class is composed of men of a low average intelligence, in adjustment to the relatively small demands for intelligence made by the conditions of machine production. "That the working class consists largely of men of very slight skill was clearly shown during the war, when so-called 'skilled' men were called up for service and were easily replaced by admittedly unskilled men, or even by shop-girls and domestic servants." Machinery has changed a skilled into an unskilled population. The crew of the *Mayflower* could have established a civilised community; a modern company of factory hands and the like, who are normally parasitic on some machine, would starve on an uninhabited island, or relapse into complete barbarism.

Mr. Freeman has some criticisms, as true as they are scathing, on the component parts of our society. "Mere learning or scholarship, unaccompanied by additions to the sum of existing knowledge, furnishes no evidence of faculty above the level of mediocrity." "The professional politician whom democracy has brought into existence differs entirely from other professional men. He is totally unqualified. Such knowledge as the old parliamentary hand has acquired has no relation to social phenomena. It is purely egoistic." Our Government is as absurd as if medical and surgical knowledge were cultivated only by detached savants, while medical treatment was conducted and surgical operations were performed by strenuous but unlearned "men of action." The First Lord of the Admiralty may be a publisher, a brewer, or a stockbroker. Now that Government control is being extended in every direction, the system is disastrous, and has already produced social, economic, and industrial chaos. Our elaborate technical education, instead of training artists and craftsmen, produces only art-school masters and mistresses and technical-school teachers. The trade unions "have made no effort to regain liberty for their members as free workers or collective owners; though the money spent on a great strike would be sufficient to establish co-operative works on an extensive scale."

The manual workers are becoming frankly anti-social as well as anti-democratic. Their activities are directed, not against the employers, but against the community. "The working man tends to be a bad citizen." He plots "to starve the country into submission; to treat his fellow-citizens as a somewhat uncivilised invading army would treat an enemy population." "The profound lack of the most rudimentary ethical conceptions which underlies these anti-social actions becomes manifest when we contrast the implied standard of conduct with that of the more intelligent classes." We cannot imagine the medical profession striking for larger fees in the midst of an epidemic. The bulk of the men no doubt do not realise that they are committing a crime against their fellow-citizens; but this only proves the very low quality of their intelligence. "The sub-man is usually a radically bad citizen."

Society, in a word, is disintegrating. Parasitism, the curse of humanity, is becoming almost universal. "The manual labourer has long since ceased to support himself completely"; "he has obviously arrived at the belief that he has a definite lien on the property of his fellows." The industrious and intelligent—"the only class that matters"—are being taxed and bullied out of existence.

Mr. Freeman has perhaps not allowed quite enough for the power of a body politic, when attacked by disease, to generate anti-toxins to resist the invasion. But though his pessimism may seem too unqualified, the justice of his strictures can scarcely be denied. His remedy, however, is not practicable. It is the "voluntary segregation of the fit"; the establishment of self-contained communities of skilled craftsmen and others, who would help each other to live a wholesome and happy life. Such a community might well be founded in a new country—in Western Canada, Southern Chile, Tasmania, or Rhodesia; the experiment would be well worth making; but in this country the new community would not escape ruinous taxation for the benefit of incapables outside, and would, moreover, be attacked and destroyed by the trade unions.

(2) Dr. Müller-Lyer's book is as typically pre-war as Mr. Freeman's is post-war. It rests throughout on the assumptions of evolutionary optimism. Civilisation *must* be progressing towards a higher state. The author seems to be an admirer of Marx, for he repeats the false statement, so often refuted, that the course of industrialism has tended to make the rich richer and the poor poorer. The presuppositions of the book vitiate its argument, but it contains many

interesting facts and reflections, and, unlike English Socialists, the author sees clearly that the unchecked increase of population is the most fatal obstacle to social amelioration.

W. R. INGE.

X-rays in Medical Practice.

General Practice and X-rays. By Alice V. Knox.

With chapters on the production of X-rays and instrumentation by Dr. R. Knox. (The Edinburgh Medical Series.) Pp. xiv + 214 + xxxii plates. (London: A. and C. Black, Ltd., 1921.) 15s. net.

IN view of the great advance which has occurred in radiography and radiotherapy during the past ten years, the author is justified in her contention that the time has come to present to medical practitioners a general survey of the subject in order to enable them to gain a full appreciation of the value of X-rays in diagnosis and treatment. The author divides medical practitioners into three groups: (1) Those who look upon X-rays as something of a scientific plaything; (2) those who rely upon radiology to establish a diagnosis instead of making a careful physical examination; (3) those who recognise in the new science a powerful help in the daily fight against disease, to be applied after a thorough physical examination has been made, when it may be of the greatest use in establishing a diagnosis or in treatment.

When X-rays were first discovered, certain applications to medical diagnosis were at once obvious. These included the discovery and location of metallic foreign bodies, and the diagnosis of fractures and other injuries of the bones. As a natural corollary came the use of X-rays in the study of disease of the bones and joints. With improvement in the construction of apparatus, and with advance in technique, it was found possible to extend the uses of X-rays to the diagnosis of certain internal disorders, such as calculi in the kidneys, and disease of the lungs, heart, and aorta.

The most noteworthy advance of all dates from the discovery that insoluble opaque salts can be administered to patients in sufficient amount to fill the gullet, the stomach, and the intestines, and so enable these hollow organs to be studied. Not only are their size, shape, and position revealed by the opaque meal, but also their contractile activities can be studied. In this way many valuable additions have been made to our knowledge of the physiology and pathology of the organs of digestion. With this far-reaching addi-

tion to the uses of X-rays there remain few organs or parts of the body which are not accessible to investigation by them, with good prospect of settling a doubtful diagnosis. If this were all, it would be clear that no medical man could afford to dispense with the services of radiology in the practice of his profession; but X-rays have done a great deal more than this. They have revealed the fact—previously suspected by few—that all disorders of the digestive tract are interdependent: that the stomach, for instance, does not become the subject of a gastric ulcer if all other parts of the digestive tract are healthy, and that the appendix does not become diseased so long as it is in a healthy environment.

Text-books on medicine arrange all diseases under the headings of the various organs of the body. Each organ has a chapter to itself, and each disorder of this organ occupies a "water-tight compartment." For teaching purposes this arrangement, no doubt, has advantages, but it also has the great disadvantage of perpetuating the notion that a chronic disease can arise in an organ of a patient who is otherwise in perfect health. X-ray investigation of the digestive system has demonstrated the fallacy of this conception of disease; it has led to a wide recognition of the importance of "chronic intestinal stasis," a condition due to abnormal delay of the intestinal contents, setting up bacterial decomposition and leading to contamination of the blood-stream. The result of this "toxæmia" is that every tissue of the body receives vitiated blood and becomes depreciated, so that it loses some of its power of repelling the invasion of microbes. Many chronic ailments, such as rheumatism, arise in this way and resist all efforts to cure until the contamination of the intestinal contents has been rectified. The stretching of ligaments, which gives rise to spinal curvature, flat foot, etc., is likewise due to the toxæmia of chronic intestinal stasis. The far-reaching importance of this new conception is clear, for in prescribing remedial exercises to strengthen the muscles of the back, or those of the foot and leg, it is important to attend to the general nutrition of the patient and to the efficient drainage of the intestinal canal, for muscles that are depreciated by contaminated blood cannot respond to attempts to strengthen them by exercises, massage, or electrical treatment, although such treatment would certainly strengthen healthy muscles.

These are only a few instances of the way in which the radiological study of the digestive tract is modifying our entire conception of the causes and treatment of disease.

Our Bookshelf.

Report of the Proceedings of the Third Entomological Meeting held at Pusa on the 3rd to 15th February, 1919. Edited by T. Bainbrigg Fletcher. (In three volumes.) Vol. i., pp. xii+417+69 plates. Vol. ii., pp. vi+418-835+70-129 plates. Vol. iii., pp. vi+836-1137+130-182 plates. (Calcutta: Superintendent Government Printing, India, 1920.) Rs.17 8 annas (3 vols.).

This bulky report is a record of thirteen days' deliberations given to the discussion of almost every aspect of entomology which is likely to concern the Indian Empire. During the congress ninety-two papers were read, and these are printed in the three volumes before us, together with a verbatim report of the discussions which were the outcome of these papers. A good deal of the information has already been published elsewhere, but it is doubtless convenient to have it gathered together and made available within the compass of a single publication. It is gratifying to note that the meetings were attended by forty-six professional entomologists and other officials, a fact which indicates the importance which this aspect of zoology has attained in the East. It is also pleasing to find an instance where a Government Department has been sufficiently generous to allow the publication of so detailed and profusely illustrated a series of volumes during these times of financial stress.

The greater number of the papers directly concern the economic entomologist, and perhaps the two most important are those entitled "Borers in Sugar Cane, Rice, etc.," and "Stored Grain Pests," which are written conjointly by Messrs. T. B. Fletcher and C. C. Ghosh. The last-mentioned paper might well be read by all interested in the reports of the Grain Pests Committee of the Royal Society. A paper by Capt. F. de Mello on "The Trichonymphid Parasites of Some Indian Termites" is of general biological interest, and the author brings to light several new forms of these remarkable Protozoa. Major Fraser writes on certain night-flying dragonflies—a habit scarcely suspected among such insects. Mr. A. W. Slater contributes a paper on the preparation and reproduction of scientific illustrations, and Mr. C. F. C. Beeson details a method of subject-indexing entomological literature. These few examples fail to do any justice to the wealth of information embodied in this report, but they will perhaps serve to indicate the wide range of subjects which came up for discussion. The volumes are clearly printed and illustrated, and reflect great credit upon all concerned in their production. A. D. IMMS.

Instinct in Man: A Contribution to the Psychology of Education. By Dr. J. Drever. Second edition. Pp. x+293. (Cambridge: At the University Press, 1921.) 10s. 6d. net.

DR. DREVER'S important book on "Instinct in Man," which was reviewed in NATURE of Jan-

uary 31, 1918, is enriched in this second edition with an appendix which will be read with great interest by all who have followed the controversy over the nature of the human instincts and their relation to the emotions. The chapter is entitled "The Emotional Phase of Affective Experience."

There are two divergent views concerning the place the instincts occupy in the psychology of man, though the facts are not in dispute. What is in question is rather a principle of classification, which at times may seem no more than a matter of nomenclature. According to one view, the human instincts are a kind of action-patterns, or it may be chains of actions, automatically or even mechanically set in motion, similar in nature to the nest-building instincts of birds. In this view the human instincts are few in number, most of them probably vestiges, and all comparatively unimportant; but the affective or emotional side of experience becomes important. This is not limited to specific responses, but built up into "sentiments," which are affective systems and the foundations of human character.

The other view is that the whole basis of human experience is instinctive, and that the instincts are distinguishable and may be enumerated; but they are not partial and intermittent; rather they are pervasive and comprehensive. Each instinct is bound up with a specific emotion and only functions in connection with it, and these primary emotions, with their instincts, are practically constitutive of human nature.

Between these two views Dr. Drever does not exactly steer a middle course—he is too original to be content with that—but he does in his criticism try to conserve what is valuable in each and reject what is untenable. H. W. C.

Energétique Générale. By Dr. Félix Michaud. Pp. vii+229. (Paris: Gauthier-Villars et Cie, 1921.) 10 francs.

"ENERGETICS" deals with the relations between the various forms of energy according to a uniform plan. Each form is assumed to be representable as a product of two factors—an "extensity" or "capacity" (x), and an "intensity" (X), related by the equation $\partial U/\partial x = X$. In the case of heat the extensity is the entropy, Q/T , and the intensity the temperature, T . General laws are then reached connecting U , X , and x .

The problems considered in the present treatise are most varied; they include mechanics, electricity, heat, and chemistry. The applications of the general principles are very clearly and elegantly presented, and the treatment, which is mathematical, is strictly logical. The question arises as to whether thermodynamics, which is a branch of "energetics," according to the exponents of the latter, is best considered in this somewhat formal manner. Boltzmann and Planck have emphasised the essential distinction between heat and the other forms of energy, but the theory of probabilities seems to have no place in the scheme of "energetics." J. R. P.

Letters to the Editor.

[The Editor does not hold himself responsible for opinions expressed by his correspondents. Neither can he undertake to return, or to correspond with the writers of, rejected manuscripts intended for this or any other part of NATURE. No notice is taken of anonymous communications.]

Phenomena of "Intelligence" in the Protozoa.

I REGRET to observe the spirit of the letter in which Mr. Dunkerly (NATURE, May 26, p. 395) replies to Mr. Ludford, though, as being primarily responsible for the statement of the theory suggested, and periodically referred to of late years, I fully realise how extremely careful one should be in the choice of words in conducting the discussion. There is probably no theory occupying the attention of zoologists in connection with which the motto of the Royal Society, "Nullius in verba," applies with greater force. Unfortunately, the "journalistic instinct" of many writers on scientific subjects has led them to credit observers with views which they have—to put it mildly—not yet reached, and to saddle them with responsibilities which they have never assumed. For instance, in Prof. Boycott's letter on the same page he credits my friend Earland with my views on "the selective intelligence of the Foraminifera," which is the one subject upon which my esteemed collaborator does not entirely agree with me.

The term "gregarious instinct" used by Mr. Ludford is an unfortunate one. The "grouping" of Protozoa to which he refers must be considered with a cautious appreciation of the elements of (a) fear, (b) reflex action, and (c) surface tension, but the most indignant opponent of my views will scarcely deny that the sense of fear is perhaps the most elementary phenomenon dependent upon a sensory system. It is, no doubt, related to, but it must not be confounded with, the "intelligence" displayed by many arenaceous Foraminifera in building their tests of adventitious material, and in using that material in such a manner as to protect the surface of the test from naturally incidental dangers of damage, and to protect the apertures of the tests against the entrance of predatory parasites.

The "grouping" to which Mr. Ludford directs attention must not be confounded with the associations of marine Rhizopoda, which gain protection against suffocation in soft muds by the co-operative use of spicules, arranged as catamaran spars to maintain them upon the surface (as in *Psammosphaera rustica*, H.-A. and E.), or with the aggregation of simple arenaceous tests for purposes of strength and protection, which, unfortunately, has led some of the earlier rhizopodists to treat such associations as new genera or species. It is as if they were to describe a litter of little pigs huddled together for warmth (which is an elementary phenomenon of intelligence) as a new and "polythalamous" genus of pig.

EDWARD HERON-ALLEN.

Large Acres, Selsey, May 31.

An Algebraical Identity $4X=Y^2-37Z^2$.

THE following is a well-known theorem derived from the theory of numbers. Let p be any ordinary odd prime, and let $X=(x^p-1)/(x-1)$; then there is an algebraical identity

$$4X=Y^2 \pm pZ^2,$$

where Y, Z are polynomials of degree $\frac{1}{2}(p-1)$ and $\frac{1}{2}(p-3)$ respectively; and the sign of the ambiguity is + or - according as p is of the form $4n+3$ or $4n+1$. The cases up to $p=31$ inclusive have been published; the result for $p=37$ has just been communicated to me by Pundit Oudh Upadhyaya,

NO. 2693, VOL. 107]

research scholar of the University of Calcutta. He finds that

$$4X=Y^2-37Z^2$$

with

$$Y=2x^{18}+x^{17}+10x^{16}-4x^{15}+15x^{14}-5x^{13}+17x^{12}-8x^{11}+11x^{10}-4x^9+11x^8-8x^7+17x^6-5x^5+15x^4-4x^3+10x^2+x+2.$$

$$Z=x^{17}+ox^{16}+2x^{15}-x^{14}+3x^{13}-x^{12}+2x^{11}-x^{10}+2x^9-x^8+2x^7-x^6+3x^5-x^4+2x^3+ox^2+x.$$

I have tested this result in various ways, and have no reason to doubt its correctness.

It should be noted that Y may be obtained by expanding $2(x-1)^{18}$, and reducing the coefficients to their absolutely least residues mod. 37. It would be interesting to know the least value of p for which this rule does not apply. It must be less than 61.

G. B. MATHEWS.

7 Menai View, Bangor, May 29.

Atmospheric Refraction.

THE following proposition regarding the effects of refraction may be known, but I do not remember to have seen it stated. It is: "The course of a nearly horizontal ray of light in the lower part of the atmosphere is a circular arc having a radius of 14,900 geographical miles."

The velocity of light in that lower part of the atmosphere for which the decrease of pressure with the increase of height is nearly linear is given by the relation

$$v_h=v_0\left(1-a\frac{H-h}{H}\right),$$

where v_0 is the velocity in vacuo, v_h the velocity at the height h above the ground, and H the height of

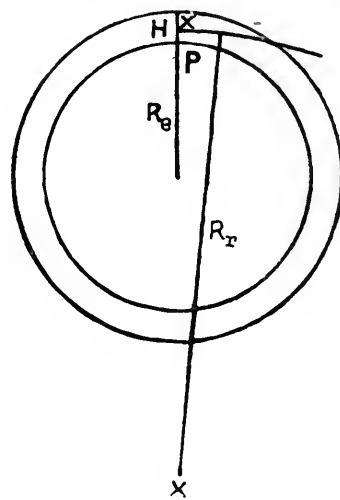

FIG. 1.

the homogeneous atmosphere ($a=0.0029$ nearly). At ground level the velocity is $v_0(1-a)$.

Let a plane vertical wave surface start from P as in Fig. 1. After the lapse of the time t it will have advanced v_0t at the height H , and $v_0(1-a)t$ at the surface of the ground. (This assumes the linearity of the relations between v_h and h to hold up to H , and though this is not true, the conclusions drawn from the assumption are correct, at any rate up to a few thousand feet.)

Thus at the time t the wave surface will be inclined forward, making an angle

$$\frac{v_0-v_0(1-a)t}{H}, \text{ or } v_0\frac{a}{H}t,$$

with the surface at P. Since this angle is directly proportional to the distance between the two wave surfaces, the normal at any point—that is, the direction of the ray—varies at a constant rate, and is therefore the arc of a circle. If $v_a t = x$ and R_r is the radius of this circle (which may be called the refractive radius),

$$R_r v_a \frac{a}{H} = x, \text{ so that } R_r = \frac{H}{a}.$$

In geographical miles $H = 4.32$ about, which makes

$$R_r = 14,900 \text{ miles.}$$

The course of the ray is the same as it would be if it passed through an infinite number of vertically placed acute prisms of height H , having a refractive index $\mu_a/(1-a)$, with their bases occupying the whole surface of the ground. Since for horizontal rays these prisms are in the position of minimum deviation, rays which are pointed a few degrees up or down will still be arcs of the circle with 14,900 miles radius. The usual tables for the distance of the sea horizon assume that the horizon is x miles distant, when the height of the eye (h) = $\frac{x^2}{2 R_e}$, R_e being the earth's radius.

If refraction is taken into account,

$$h = \frac{x^2}{2} \left(\frac{1}{R_e} - \frac{1}{R_r} \right),$$

or, in numbers, without refraction,

$$h = 0.87 x^2;$$

with refraction allowed for,

$$h = 0.67 x^2.$$

Thus the sea horizon viewed from a height h , or a mountain of this height just visible from sea-level, is a good deal further off than the ordinary tables would indicate.

If an atmosphere of the same height and density as that of the earth covered a globe of 14,900 miles radius, an elevation at any one point of its surface would be visible from every other point, and a light at one end of a diameter would appear to an observer at the other end as a bright line extending round the whole of his horizon. A. MALLOCK.

9 Baring Crescent, Exeter, May 12.

Young's Interference Experiment and the Spectrometer.

IN NATURE of April 28, p. 268, Dr. R. A. Houstoun directs attention to the use of the spectrometer for Young's double-slit experiment. In a letter on "The Visibility of Interference Fringes and the Double Slit" (NATURE, July 26, 1917, vol. xcix., p. 424) the present writer made reference to a similar optical arrangement. In that letter emphasis was laid, not on the advantages of the method for observing fringes and evaluating wave-length, but on its use for studying the changes in the visibility of fringes which occur as the width of the spectrometer slit is altered. In view of Prof. Michelson's recent use of the double slit for the measurement of the angular width of distant stars, I may be pardoned for directing attention to my note of some years ago, and for pointing out the ease with which an experiment similar in method to that of Prof. Michelson may be performed by means of an ordinary spectrometer. It is true that, instead of using a source of fixed (but finite) width and a variable double slit, the converse arrangement was employed, but in principle the methods are identical. It might be worth while, however, to vary the experiment by replacing the spectrometer slit by a small circular aperture and using a double slit of variable width.

May I also point out that the spectrometer may be used advantageously for an experiment on the limit of resolution of a telescope? It will be recalled that in the standard experiment a distant piece of gauze of fairly large mesh is viewed through a telescope before the objective of which an aperture is gradually narrowed until one set of wires disappears. If the slit of the collimator of a spectrometer be removed and in its place a piece of gauze of fine mesh be substituted, a much more convenient arrangement is available. During the past winter I found that students make quantitative measurements with such an arrangement without even darkening the laboratory.

In conclusion, it is well to note that for much of the above work even a spectrometer is not necessary. A telescope, a good lens, and adjustable slits are the only essentials.

JOHN K. ROBERTSON.

Queen's University, Kingston, Canada,

May 12.

The Reparation Act and Scientific Research.

THE columns of NATURE could, no doubt, be crowded with complaints concerning the Reparation Act, but as a sufferer I may be permitted to give the following instance of the extraordinary way in which this Act is used to hinder research.

I ordered a case of chemicals from Germany for myself and other workers in the Biochemical Laboratory, Cambridge, on February 2. In order that these should not come under the Reparation Act, they were dispatched on March 24 and arrived on April 8. Although the Reparation Act did not come into force until April 15, the goods were seized at Grimsby, and after a week's delay I was asked for all the original documents showing that the goods were ordered before March 8 and delivered before April 15. These were at once sent to London, but no reply was received from the Customs until I was forced to request the Medical Research Council, for whose work the chemicals were required, to apply to the Customs to free the goods as soon as possible. After three weeks' delay I received a letter from the Customs saying that the original documents were insufficient, and that a statutory declaration was required to confirm the particulars and to prove that the contract had not been fulfilled. This necessitated two visits to a commissioner of oaths and the preparation of a lengthy manuscript document adorned with red seals, the cost of which I have still to discover. This evidence was forwarded to the Customs a fortnight ago, and I have received no answer. The goods are still at Grimsby, the work of several people is being delayed, and the goods will apparently remain impounded (although they never came under the Act) unless I am prepared to submit to what might almost be called blackmail. To obtain the chemicals I must pay the full 50 per cent. myself, the funds of the Medical Research Council being unavailable for the purpose, and I must trust to recover the money from the Customs when my claim has been recognised—evidently a very doubtful eventuality.

All this delay, the expense, including the commissioners of oaths, not to speak of the worry and waste of time of an interminable correspondence, are apparently due to nothing but the red tape of a Government office.

H. ONSLOW.

May 27.

British Laboratory Ware and Chemicals.

THE question of the quality, supply, and prices of British laboratory glassware, porcelain, and chemicals, including research chemicals, is under consideration by a committee of the British Science Guild. The

committee, the chairman of which is Sir Richard Gregory, is anxious, in view of the conflicting statements which have appeared from time to time on these matters, to obtain the views of scientific workers who have experience of recent articles of the kind described, both of British and foreign manufacture. It is obvious that the information can be of use only when it applies to goods of definitely known origin. The points on which information is desired are:—The quality of the goods; their price as compared with that of imported articles of the same quality; the facilities for obtaining supplies; and the effects, if any, on research work of restrictions imposed on the importation of German goods. The committee would also welcome statements made, or reasoned conclusions arrived at, by competent bodies who have investigated these questions recently, and from manufacturers who wish to add any further definite information to that which has already appeared in the Press. The information should be sent to the secretaries of the committee, Prof. J. R. Partington, East London College, or Mr. C. L. Bryant, 23 Peterborough Road, Harrow, as soon as possible.

J. R. PARTINGTON.
C. L. BRYANT.

Science and Technology in Palestine.

IN a lucid article, "Water-Power of Jordan," which appeared in the *Times* of May 18 the twofold scheme of the Jewish engineer, Mr. Rutenberg, was explained. Mr. Rutenberg proposes, first, to establish a barrage at the southern end of the Sea of Galilee to be used as the main power-house for the general purpose of electrification. Secondly, the malaria-breeding marshes of Lake Huleh are to be drained and a power-house constructed which will utilise the fall of the Jordan between Lake Huleh and the Sea of Galilee for power generation.

Readers of NATURE may be interested in a few further details of these plans. The latest calculations value the total potential water-power of Palestine at 1,000,000 h.p., plus a water-supply which will suffice to irrigate 1,200,000 acres of land. There is, of course, no intention of generating electricity to the full extent of this power; e.g. the proposed power station on the lower part of the Jordan, capable of generating 100,000 h.p. in twenty-four hours, would be sufficient to electrify the already existing railways of Palestine—which would need approximately 30,000,000 kw.h. per annum—as well as to supply the present general needs of Palestine. This station would also produce about 200,000,000 cubic yards of water for irrigation purposes; the installation would probably cost about 2,000,000l.

It is not necessary to emphasise the value of such schemes, both as regards increased fertility and productivity of the land, and in their effects on the social and economic life of the country.

In view of the local need for scientific knowledge, particular attention has to be paid to the Scientific Department which is to form the nucleus of the proposed University of Jerusalem. Already in 1913 Dr. Weizmann and the University Committee (whose chief scientific adviser was the late Prof. Paul Ehrlich) decided that research institutes should be founded, to be transformed as soon as possible into complete teaching faculties. Institutes of physics, chemistry, and microbiology were included in the initial scheme. It is hoped that through these institutes opportunity will be given for the solution of practical problems by Jewish experts on the spot. Obviously, from a practical point of view, it is better that Jewish talent should be utilised locally in this way, and from a

wider point of view the University in its humanitarian as well as in its scientific aspects will form an integral part of the national life.

DAISY L. ADLER.
The Zionist Organisation, 77 Great Russell Street, London, W.C.1, May 20.

Foreign Scientific Literature.

PROF. GARDINER in NATURE of May 19, p. 359, writes of the difficulty of obtaining Continental publications, whilst the complaint from Central Europe is all about the difficulty of getting English scientific literature. Perhaps something can be done by exchange. There are probably readers of *Die Naturwissenschaften* and of the *Elektrotechnische Zeitschrift* willing and eager to exchange with NATURE and the *Electrician*. Second-hand books with pages cut and owners' names inscribed would probably follow the analogy of worn clothes and be exempt from the interest of Customs officials. A year ago the Swiss bookshops in Berne seemed to carry a heavy stock of recent German scientific literature. Travellers returning from the Alps may wish to inspect these. For exchange of transactions of learned societies the mediation of the Anglo-American Library (hon. secretary, Mr. B. M. Headicar, School of Economics, Clare Street, London, W.C.2) might be invoked.

HUGH RICHARDSON.
Stocksfield-on-Tyne, May 26.

Flint Implements in the Cromer Forest Bed.

SINCE the reading of my paper on the humanly fashioned flints found upon the foreshore at Cromer before the Royal Anthropological Institute on May 3, I have again visited the Norfolk coast. This visit, in company with my friend Mr. Frank Barclay, of Cromer (who has recently collected close upon one thousand specimens of the ochreous artefacts from the foreshore), has resulted in the discovery of two flints, exhibiting the now well-known yellow coloration, *in situ* in the surface of the ferruginous "pan" or Stone Bed resting upon the chalk, and exposed, I conclude recently, at the base of the cliff above the beach deposits under Beeston Hills at Sheringham. This ferruginous deposit is of extreme hardness, and the two ochreous flints discovered could be dislodged only with great difficulty. There is, therefore, no doubt of any kind that the specimens form part of the deposit in which they occurred, which, without question, passes in under the very lofty cliff present at this spot.

Mr. Clement Reid ("Pliocene Deposits of Britain," p. 155) regarded the "pan" and Stone Bed at Sheringham as of Weybourne Crag age, and I think that, speaking generally, this opinion is correct. The two flints which have now been found were embedded in the surface of the Stone Bed, associated with a number of examples of clay pebbles such as occur in the lowermost strata of the Cromer Forest Bed deposits, and seem, therefore, to be referable to the horizon mentioned by me (NATURE, February 10, 1921) as that to which the Cromer artefacts might, in all probability, belong.

I have now found that the ochreous flint implements and flakes occur upon the foreshore exposed at low water at Sheringham and West and East Runton, as well as at Cromer, though they are much more numerous at the latter place. The peculiar form and technique of the specimens from all the sites mentioned are almost precisely similar, and I entertain no doubt that they may all be referred to one and the same "industry." The two flints now discovered, to which this letter especially relates,

are not large, and have attached to portions of their surfaces the very hard ferruginous matrix in which they were embedded. The larger specimen is a roughly shaped flint such as are found in some quantity at Cromer. The yellow-stained surfaces are typical, and exhibit the well-marked band of black unchanged flint under the layer of cortex. The other specimen is a small flake, with bulb of percussion, radiating fissures, and *écaillage*, and shows similar characteristics to the last-described flint, together with a whitish coloration on the bulbar surface, which is encroached upon extensively by the ochreous staining. This discovery establishes the fact of the occurrence at Sheringham of ochreous flints, comparable in every respect with many found at Cromer, *in situ* in the surface of the sub-Crag Stone Bed. It is established also that artefacts of the same order are to be found scattered among the large flints resting upon the chalk, and exposed at low water immediately opposite to the section in the cliff where the two flints were found *in situ*. There would seem, therefore, to be little doubt that the Cromer specimens are referable to the same horizon as those discovered at Sheringham, namely, the basal layer of the Cromer Forest Bed deposits.

In my paper read before the Royal Anthropological Institute I record the finding, at the Cromer site, of a large, yellow-stained flake exhibiting a mass of ferruginous "pan" material firmly adherent to a portion of its surface. This ferruginous deposit appears to be, in all respects, similar to that in which the two Sheringham flints were embedded, and its presence upon this flake supports the conclusion above stated as to the geological age of the Cromer artefacts.

J. REID MOIR.

One House, Ipswich.

The Physical Status of "Space."

It does not appear from Dr. Jeffreys's letter in NATURE of May 26, p. 394, that we are at variance about anything really vital. What I do contend is this: that, thanks to the searching character of the theory of relativity, the time has come when it is profitable to attempt a much-needed unification of fundamental terms and conceptions, particularly in face of the curious indifference to such matters shown by some of those physicists who, with consummate skill, have developed the differential equations representing the natural forces. As the space of NATURE is limited, may I briefly, in a series of categories, amplify my previous letters (April 7 and 21 and May 5), stating the case for the extension theory suggestively, but in no way dogmatically?

(1) If you objectify the pure spatial co-ordinate system of the mathematician you are of necessity dealing with attributes of some entity which, speaking within the limitations of human experience, must be supposed to answer to the designation "physical." I press for no other use of the term "æther," and this only as a safeguard against language suggestive of nothingness or absolute emptiness.

(2) The validity of the logical step (1) is supported by the theory of relativity, particularly the generalised theory, which actually affirms that the only objective space of human experience is physical space—out of which basis of experience the mathematician constructs his subjective spaces and pure geometries (in Dr. Jeffreys's sense of the word) representing various ideal, or possible, universes.

(3) The whole trend of twentieth-century physics is to teach us to think in terms of energy, not in those of matter. Matter is to be regarded as so much bound energy, as symbolised, indeed, in Einstein's expression, mc^2 , for the energy equivalent of mass. It

seems legitimate, therefore, to infer that the attribute of extension or extendedness ultimately belongs to energy.

(4) In the light of (1), (2), and (3), I submit that a desirable unification of ideas can be effected, and much confusion of thought avoided, if, instead of regarding the universe as *containing* energy, we regard it as *being* energy. Let the physical universe be defined as an evolutionary system of energy—that is to say, as an extensive entity the very nature of which is to express itself in changes and transformations (motions). This definition would render Comdr. McHardy's artifice of "container" and "content" (NATURE, May 19, p. 360) unreal; and I cannot see that the distinction he makes is ontologically sound. Furthermore, does not the picture of the universe herewith presented throw into relief the necessary association of time with space, and illustrate that physical difference which leads us to regard time as *imaginary* space?

Finally, I would like to refer to the passage in Sir Oliver Lodge's article (NATURE, February 17, p. 800) wherein he speaks of the necessity of "diving down into the æther." The metaphor is literally pregnant with meaning. It suggests, indeed, that when we shall have peered into the untold depths of the mere nameless *thing*—call it "space," "æther," "world," "metric," "substratum"—which is the scene of such momentous phenomena as light transmission and gravitational potential, it will prove to be a veritable mine of energy and a truly formidable physical reality. The great "æther" controversy seems now nearly spent, and I think it could be settled to-day if only the "non-ætherites" would frankly acknowledge that the world-energy is *continuous*, and the "ætherites" would think of their entity as an energy *continuum* rather than as functioning as a kind of independent luminiferous medium.

L. C. W. BONACINA.

May 29.

The Colours of Primroses.

IN view of the turn given to this discussion by Dr. Heslop Harrison's letter in NATURE of May 19, it may be worth while to state that in the Island of Sark twenty-four years ago, in addition to an abundance of normal primroses, there were also plenty of (a) white, (b) pink, and (c) red flowers. Necessarily there can have been no appreciable difference of altitude.

Occasionally we find red primroses hereabouts, but my impression is—although I will not venture to write positively—that they do not run to the deep red of the Sark specimens. I remember finding one plant on the edge of a field three miles east of Polperro at an altitude of possibly 200 ft. or so.

I feel fairly certain that I never saw any cowslips in Sark—and I explored the island fairly thoroughly.

FRANK H. PERRYCOSTE.

Higher Shute Cottage, Polperro, R.S.O.,
Cornwall, May 27.

Gold-coloured Teeth of Sheep.

DURING the early part of the war the transport of sheep about the country districts was strictly regulated so that a local butcher could state definitely in which locality his meat had been fed. I noticed a large number of sheep's teeth encrusted with bright yellow tartar, identical in appearance with good average bright non-arsenical iron pyrites. I was assured that the sheep were fed upon Rye Marshes. I have a number of these jaws, and I should be pleased to send specimens to any museum interested in them or to anyone who would undertake to publish a full analysis and report upon the material.

W. J. LEWIS ABBOTT.

Prehistoric Art in Caves and Rock-shelters.

By M. C. BURKITT.

PREHISTORIC art is a branch of prehistoric archaeology or prehistory, and, as a study, is comparatively new. Although the discovery of the Altamira paintings was made many years ago, their palæolithic age was not accepted until after Rivière's discoveries at La Mouthe (Dordogne). Rivière, in the course of digging out the Magdalenian deposits of this cave, discovered an entrance leading to a long passage behind. The entrance had been completely obstructed by undisturbed layers of the deposit. Man could only have entered the inner cave previous to the deposition of these datable layers. In the cave behind were found a number of engravings, many of them quite primitive, and a few paintings. Once the palæolithic age of these drawings was accepted, M. Piette recalled the then almost forgotten paintings of Altamira. The fact that animals like the bison were found painted there (*i.e.* animals long ago extinct in Spain) further vindicated their palæolithic age, and any stray sceptic was finally won over by M. Cartailhac, when he published his famous retractation.

Since the beginning of the present century a very great deal of work has been done and further discoveries have been made in this fascinating study of early art. Not only do all the recognised text-books on prehistory devote considerable space to this early art, but also a number of books dealing specially with the art itself have appeared. These profess to cover the whole development of the art from its first appearance until early historical or even later times. The specialist, however, generally finds that there is a certain lack of balance in books of this type, which is by no means the fault of their authors, but simply due to the fact that a very large amount of material, especially of Neolithic or Eneolithic age, has not yet been published. Practically all the work on prehistoric rock drawings or paintings has been due to the Abbé Breuil (professor at the Institute of Human Palæontology, Paris). All the drawings that we see in the popular books are reproductions from his tracings of the originals. But besides these there are a great number which he has not yet had time to prepare for publication. The present writer, who is a pupil of Prof. Breuil, and has travelled with him in Spain and elsewhere, has neither the space here nor the right to anticipate his future publications, but perhaps a general survey of the rock drawings and paintings from Palæolithic to Bronze-age times may not be out of place, as well as a brief account of some of the more important recently published discoveries that have been made.

The prehistoric art in Western Europe that is to be found emblazoning the walls of caves and rock shelters, etc., can be divided into six groups:—

1. The ordinary Upper Palæolithic cave paintings and engravings.
2. The Eastern Spanish style, rock shelter paintings of Upper Palæolithic age.
3. The Spanish third group rock shelter paintings of Neolithic and Eneolithic age.
4. The Western Scandinavian rock carvings and paintings of Late Neolithic and Eneolithic age.
5. The South Swedish Bronze-age group of rock carvings, with an outlier on the shores of Lake Onëga, North Russia.
6. The group of rock carvings, probably of Bronze age, that occurs high up on the flanks of Monte Bego, etc., in the Maritime Alps.

It may be well to discuss briefly each of these groups.

Group 1. The distribution of the ordinary Upper Palæolithic cave art depends first of all on the presence of suitable natural caves. This in turn demands the presence of limestone formations in the district. Secondly, it depends on whether the prehistoric tribes of the region employed this particular form of magic ritual to ensure a good success in hunting. These suitable conditions are found:—

(i) In Dordogne (France), especially concentrated round the little village Les Eyzies, on the River Vézère, some miles above where it falls into the River Dordogne.

(ii) In the Pyrenees, especially concentrated, so far as it is at present known, in the Ariège and adjacent departments.

(iii) In Cantabria and Asturias, North Spain, *i.e.* north of the Cordillera Cantabrica, that chain of mountains which forms a continuation of the Pyrenees along the north coast of Spain. Geographically, this region is South France rather than North Spain. The cave art here is specially concentrated near the town of Santander, which forms a good centre for visiting the caves.

(iv) A small series found in caves in South Spain. There is no doubt of the similarity of the art of this series and of the rest, but the apparent absence of the Upper Palæolithic cultures over the intervening Iberian Peninsula makes the actual connection rather obscure.

(v) In a single cave in the extreme south of Italy.

A proof of the age of this group has already been adduced, and there are others into which we need not go here. They would seem to have been executed for magical purposes, and this is shown from the following considerations:—

(a) The animals are often painted or engraved one on the top of another haphazard, which would not be the case if they were made for decoration.

(b) They are found in deep caves and often in obscure spots, difficult of access. At Niaux (Ariège) they are not found until the explorer

has penetrated half a mile into the hill. Man did not live in deep, dank caves requiring artificial light; his habitation was made under overhanging rocks on the sunny side of the valley, or occasionally in the mouth of a cave. These cave drawings, then, were not home decorations, and one could scarcely imagine a prehistoric man rushing half a mile into a hill with a blazing brand to light him in order to paint an animal in some narrow crack from mere *joie de vivre*. The only other explanation is that this art was used for some form of magic or ritual ceremonial. When we recall that the animals sometimes show arrows in their flanks, and when we find the human hand depicted (in one cave at any rate, mutilated by certain joints of the fingers being removed), not to speak of the presence of a number of queer signs at the meaning of which we can only guess, we are forced back to the conclusion that sympathetic magic is the sole explanation. A good catch is all-important to a hunting people,

figures of even a later date are sometimes placed in a fifth phase. The fact that the succession of styles is the same over such a wide area indicates either schools of tradition for the medicine men or priestly caste—*i.e.* for those who did the magic in the caves—or, at any rate, a fairly close intercourse between the various regions. This is still more startling in the case of decorated bones from the deposits themselves, where we find similar peculiar geometric decorations from Cantabria to the Ukraine.

In a new and unpublished cave there is the painting of a sorcerer masked as a stag dominating a frieze of engraved animals.

Group 2. The Eastern Spanish style. This is thought to be of Upper Palæolithic age, for the following reasons: (a) There is a painting of a bison at Cogul; of an elk at Cueva del Queso; of a chamois at Tortosilla (chamois have long ago disappeared from the province of Albacete, South Spain); of an elk, a reindeer, and a rhinoceros at



FIG. 1.—Panel in the second rock shelter at Cantos de la Visera (Albacete, S. Spain). Paintings in the Eastern Spanish group of horses, stags, bulls, etc.

and no doubt these paintings and engravings, that are so lifelike in appearance, were used to further this object.

All the drawings are not of the same age, and they can be divided into a number of phases of different ages. These phases are determined by a careful consideration of the various styles that are painted or engraved one over the other. When such a palimpsest occurs, the engraving or painting on the top is obviously newer than those underneath. When a number of caves in the various regions are examined it is found that the succession of the styles is the same, whether we are in Cantabria, in the Pyrenees, or in Dordogne. Of course, certain local styles make their appearance in various places, but the main succession is the same. Detailed studies have enabled us to assign dates to these various styles, and we can now confidently affirm that phase 1 is Aurignacian; phase 2, Lower Magdalenian; phase 3, Middle to Upper Magdalenian; and phase 4, Upper Magdalenian. Certain geometrical

the newly discovered rock shelter of Minateda (Albacete). (b) The figures of horses painted in the Eastern Spanish group at Cantos de la Visera are exactly similar in technique to a small horse painted in red among the northern group 1 at Portel in the Pyrenees. This Eastern Spanish style is peculiar in that it is found, not in deep caves, but under rock shelters, that are, however, deep enough to protect the paintings from actual moisture, which would give rise to moss growth that would soon destroy the paintings. The climate of East Spain is neither rigorous nor damp, and there is no reason why these paintings, made with oxides of iron as pigments, should not have lasted until to-day. Another characteristic of this group is the number of human beings depicted, often armed with bows and arrows. The most important discoveries made in this group in recent years are: (a) The rock shelter of Cantos de la Visera; (b) the rock shelter of Minateda; (c) the rock shelters of the Barranco de Valltorta (province of Castellón). The first of these was

discovered by the writer, and is of importance from the occurrence of horses, which have been compared with one at Portel (see above) (Fig. 1); also by the occurrence of two painted birds (a great variety at all times in Palæolithic art, and above all in the Eastern Spanish group).

Minateda is important from the great wealth of paintings found there, among which are animals long ago extinct in the region. There is also a battle scene of men fighting (Fig. 2). Prof. Breuil has been enabled, from a study of the superpositions of the paintings, to unravel a very large number of different styles. These do not seem, however, to indicate any very great difference in age, or, if they do, we have as yet no means of correlating them with deposits of Upper



FIG. 2.—Panel at the new rock shelter of Minateda (Albacete, S. Spain). It belongs to the Eastern Spanish style, which is of Upper Palæolithic age.

Palæolithic age, as the latter seem to be absent from East Spain.

The rock shelters of the Barranco de Vallorta are specially interesting for the number of painted human beings which they contain, exactly similar in style to those found in Bushman paintings. The resemblance is startling—in fact, a research student in ethnology at Cambridge, when shown pictures of these rock shelters without being told their provenance, turned away, saying, "Oh, yes, those are some more Bushman paintings." There are several hunting scenes depicted.

The object for which paintings of this Upper Palæolithic, Eastern Spanish group were made cannot be determined with the same degree of certainty as in the case of Palæolithic group 1; it

is probable, however, that magic was at the bottom of it.

Group 3. The Spanish third group of Neolithic or Eneolithic age. This group comprises scores of rock shelters all over Spain. Examples are also found in East Spain alongside the older Spanish group 2. Where examples of both groups occur in the same rock shelter, the examples of the Spanish group 3 are always painted over, and are therefore newer than the Spanish group 2. The style is altogether different, whereas in the Spanish group 2 the animals at any rate are naturalistic, even if the human beings are more or less conventionalised. In Spanish group 3 there is no attempt at a naturalistic drawing at all; the animals are often similar to what a child of four would make, and even more simplified than this, while conventions for the human form are bewildering. For example, the human form is sometimes represented by a vertical line from which two pairs of oblique lines are drawn forming arms and legs, or by the painting of a sort of hour-glass, or by a circle with a vertical line drawn through it, or again by the letter "D" placed horizontally with a vertical line drawn from it and dividing it into two segments; an eye is often indicated in each of these segments; although these figures often seem but remotely to resemble a human form, a complete series from an unmistakable human being to the most conventionalised example can be made out.

This Spanish group 3 is widely distributed over Spain. In the south-west area limited by Cadiz, Gibraltar, and Bobadilla, there are more than sixty rock shelters decorated with this art. Further east there is a large group in the province of Almeria, with the little village of Velez Blanco as a centre. All along East Spain this art occurs, sometimes, as has been said, in the same rock shelters, with examples of the Spanish group 2. The Sierra Morena and its continuation towards Portugal contains numerous examples of this group, while further north, south-west of Salamanca, in the valley of Batuecas (mentioned by Borrow in his "Bible in Spain" as a weird place, full of queer legends), this Spanish group 3 art is found in conjunction with some small semi-naturalistic figures that are of rather earlier date.

As in the case of the Spanish group 2, this Neolithic or Eneolithic art is found painted on the walls of fairly shallow rock shelters. The shelter, however, must be sufficient to prevent the access of damp, which, by promoting the growth of moss, etc., would rapidly destroy the paintings.

Certain pots dug up from deposits, dated as being of Late Neolithic or of Eneolithic age, carry engravings of the human form, etc., conventionalised in the same way as those found in the rock shelter. Pots of this nature have been discovered by M. Siret and Don Federico de Motos in the province of Almeria, while Dr. Obermaier has described the same kind of thing from near Madrid. The discovery of these engraved pots enables us to date

the similarly conventionalised drawings of this Spanish group 3. Further, there is a painting of a man armed with a sickle, and another with what must have been a metal hatchet. Stone hatchets are, however, also occasionally figured. Again, a painting of a man occurs at Peña Tú, convention-

side of a prominent bluff, jutting out into a wide valley, made it eminently suitable for some form of temple, but the ritual could no longer have been a simple, sympathetic magic to ensure a good catch of game. Was there an element of real religion, and were these drawings, although apparently not orientated one to another, of the nature of pictographic writing? The other example is near Velez Blanco, where there is a small rock shelter known as Gabal. It contains no paintings, but a niche over the entrance, reached to-day by a ladder, contains quite a number. Are these the sacred emblems of the household; a protecting *tabisman* for the "Home" below?

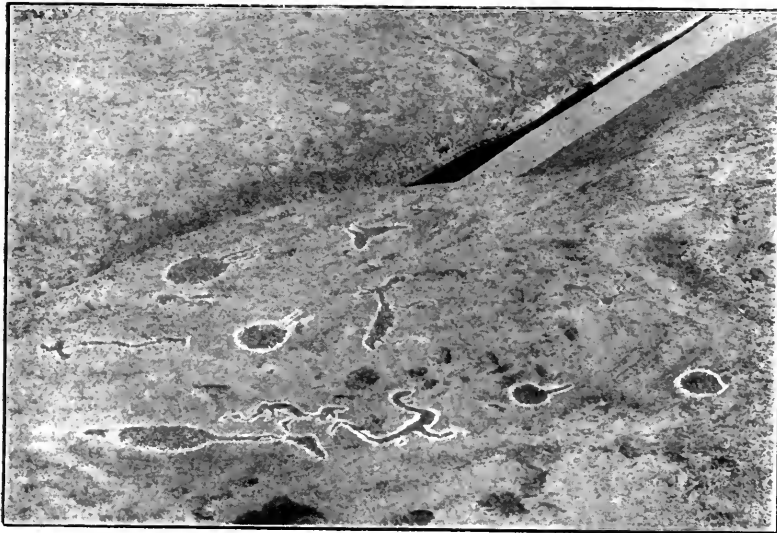

FIG. 3.—Two groups of rock engravings on the shores of Lake Onéga (N. Russia). Probably of Bronze age.

alised in the same way as some found carved on certain menhirs, etc.; and in another rock shelter there is a painting of a man leading an animal, which indicates that domestication of animals had been learnt.

The object for which they were made would seem to be rather different from that of the Palæolithic groups. It may be noted, first, that the animals are no longer naturalistic, and, secondly, that the human form is the commonest object figured. At the same time, these rock paintings were not made for decorative purposes, for in many cases they are painted in situations difficult of access and impossible as homes.

Two examples of this may be given. In the western region there is a small cave called Las Figuras. This takes the form of a short tunnel about 10 yards long which opens some 15 ft. up on the side of a precipice. From the entrance the tunnel slopes up so steeply that it is with difficulty one can avoid slipping back over the edge of the entrance. The walls and roof of the tunnel are covered with paintings, and there are no signs left in the cave walls that any wooden constructions had ever existed, such as would have been necessary if man had ever inhabited the tunnel. The position of Las Figuras, opening as it does on the

Group 4. The Western Scandinavian engravings. This interesting group of rock carvings on hard, glacier-worn surfaces of rock is found fringing the western coast of Scandinavia from Narvik, in the north, to Vingen Fjord, in the south. Occasionally, when the mountains of the interior open out, they are to be found stretching back, even into Sweden. They consist of a number of carvings of semi-naturalistic animals, the best of which is the well-known reindeer at Böla. A few paintings of this age are also known, including some conventionalised human figures at Leka. Prof. Breuil has always considered that there is some connection in culture, if not in time, between

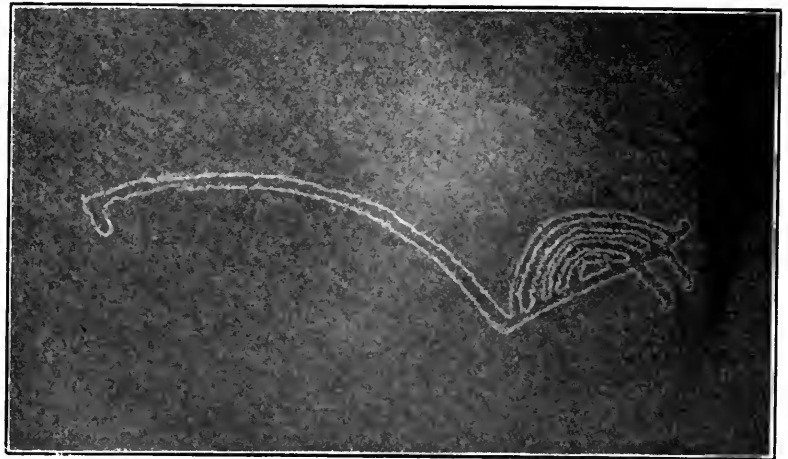

FIG. 4.—Onéga (site B). A swan with wing feathers indicated.

the folk who made these carvings and the Maglemose civilisation of the Baltic areas. This group is certainly earlier than the next Bronze-age group, for at Bardal, near Trondhjem, the latter is found superposed upon it. On the other hand, it has been thought that the

rocks at Bardal were under the sea before *Allée Couverte* times. There may have been a cultural survival from the Maglemose civilisation, even if they are Late Neolithic in age. Is it possible that the new and interesting find of an engraved animal on a piece of crust at Grime's Graves is to be correlated with this group?

Group 5. Bronze-age rock carvings of South Scandinavia, with an outlier in North Russia. This group, which is especially concentrated in Bohuslain (north of Göteborg), is too well known to be discussed here further. It is dated from a consideration of the form of daggers figured, as well as from the carved ornamentation. Runes

are never found in association with these rock carvings.

The North Russian outlier is of some interest, and will be partly described this year. The carvings are found here on extremely hard, glacier-worn surfaces of rock, forming the eastern shore of Lake Onęga, south of Pudosh, and north of the Black River. There are ships, swans, a devil 10 ft. long, animals, a phallic scene, fish, signs, etc. (Figs. 3 and 4).

Group 6. Maritime Alps. This group is also too well known to require further discussion. The occurrence of a ploughing scene, very similar to one found in the Bronze-age group of South Scandinavia, may be noted.

Dark Nebulæ.

By DR. A. C. D. CROMMELIN.

SEVERAL years ago photographs taken by Prof. E. E. Barnard and Max Wolf rendered the hypothesis highly probable that many of the dark lanes and spaces met with in the Galaxy and in regions of diffused nebulosity were due to the intervention of occulting matter rather than to actual diversity of star distribution. One of the most notable examples occurs in a long strip of nebulosity that runs southward from

here reproduced, and is quite startling from the hard, clear-cut outlines of the marking, which is blacker than the neighbouring sky background. It would seem that this sharp outline must indicate a stratum of dust rather than one of gas; it can be traced for some distance outside the long nebula, and is probably connected with an isolated bright nebula some 15 minutes of arc distant to the north-east. It will be remembered that a great part of Orion is covered with faint nebulosity, first revealed as a large spiral by Prof. Barnard's photo-



FIG. 1.—Nebulosity south of ζ Orionis. From a photograph taken by Mr. Duncan with the 100-in. telescope of the Mount Wilson Observatory.

ζ Orionis. Dr. Isaac Roberts noted that there was "an embayment, free from nebulosity, dividing it into halves." Prof. Barnard afterwards remarked that this space appeared to be "a dark body, projected against, and breaking the continuity of, the brighter nebulosity." More recently still the object has been photographed at the Lick and Mount Wilson observatories. The Mount Wilson photograph, taken with the 100-in. Hooker telescope, is



FIG. 2.—Enlargement of dark nebulosity in Fig. 1.

graphs with a lantern lens. There is a striking falling off of star-density to the east of the long ζ Orionis nebula as compared with that to the west, which presumably indicates a general absorption of light.

The Proceedings of the Amsterdam Academy of Science, vol. xxiii., No. 5, contains two papers by Dr. A. Pannekoek on a region of dark nebulosity in Taurus. Dr. Pannekoek refers to a paper by Sir F. W. Dyson and P. J. Melotte (M.N.R.A.S., vol. lxxx., p. 3). He uses their figures of star-density in these regions to make an estimate of

the distance of the occulting screen, and obtains the distance 140 parsecs, which is about four times that estimated for the Hyades. Since the angular extent is 30° , this implies a real length of 70 parsecs, and gives a vivid idea of its gigantic dimensions.

Dr. Pannekoek next proceeds to make an estimate of the mass of the nebula; he first works on the assumption that it is composed of hydrogen. The star-counts indicate an absorption of two magnitudes. Using Dr. Abbot's absorption coefficient for atmospheric air, and taking the thickness of the stratum as 10 parsecs, he finds 10^{-16} for the density of the gas-cloud. The mass is independent of the thickness assumed, and comes out twenty thousand million times that of the sun. This is greater than many estimates of the combined mass of the whole sidereal system, and at once suggests the probability that the larger portion of that mass is not condensed into stars, but distributed in cosmic clouds. Some striking consequences of the presence of such a great mass at a comparatively moderate distance are drawn by

Dr. Pannekoek. The sun would travel round it in a very eccentric ellipse in a period of some two million years, being now near apocentron.

While so large a mass of the universe as a whole would render it easier to account for the numerous cases of high velocity among the stars, it would make the moderate velocities of the bulk of the stars difficult to explain. The author notes a suggestion by Prof. De Sitter that the necessary mass of the occulting clouds may be greatly reduced if we postulate that they consist of dust instead of gas. It has already been pointed out that the aspect of the dark marking near ζ Orionis accords with the hypothesis of solid matter. However, even in this case the necessary mass is enormous, since it is *a priori* improbable that the thickness of the stratum should in all cases be a very small fraction of its visible dimensions.

The demonstration of the existence of these immensely massive cosmic clouds seems to make it desirable to rediscuss the dynamics of the stellar system.

Obituary.

PROF. E. B. ROSA.

THE death, on May 17, of Prof. Edward Bennett Rosa, of the Bureau of Standards at Washington, at the age of sixty years, is a serious blow to electrical science. Born in 1861, Prof. Rosa gained distinction as a student in the Johns Hopkins University under Rowland, and after some experience in professorial work in the Wesleyan university where his early undergraduate days had been passed was in 1901 appointed to the staff of the Bureau of Standards as a physicist. There his main work was done. In 1910 he became chief physicist, and as head of the electrical department was responsible for many of the valuable researches which have been carried out at the bureau.

Among the earliest of these was his determination, in collaboration with Dr. Dorey, of " ν ," the ratio of the electrical units, and most of them turn on questions relating to the measurement of the fundamental units, the ohm, the ampere, and the volt. He combined in a marked degree the insight required to design and carry through to a successful result a difficult experiment and the mathematical skill needed to develop to a high degree of accuracy the theory on which the experiment is based.

Prof. Rosa's papers on the calculation of coefficients of self- and mutual induction, and on the theory of the instruments employed in absolute measurements, will always be standard; while his own experimental determinations of some of the fundamental quantities are among the best which have been made. He realised the need for accuracy and exactness in the processes of measurement, whether applied to scientific work or to industry, and he organised the electrical section

of the bureau in a manner which fitted it to respond to the requirements both of scientific and industrial research. The list of his papers covers a wide range, and in all of them he added to our knowledge in a substantial manner.

Prof. Rosa visited England in 1908, acting, along with Dr. Stratton and Prof. Carhart, as one of the American representatives to the International Electrical Conference, held in London under the presidency of the late Lord Rayleigh. At that conference a formal distinction was drawn between the absolute and the international units of measurement: between the ohm (10^7 absolute C.G.S. units) and the international ohm—the resistance at 0° C. of a uniform column of mercury weighing 14.521 grams, and 106.300 centimetres in length; or the ampere (10^{-1} absolute C.G.S. units) and the international ampere—the current which under certain carefully defined conditions deposits from a solution of nitrate of silver a mass of 1.11800 milligrams of silver per second.

Prof. Rosa would probably have preferred to retain as standards for legal purposes the absolute magnitudes 10^7 C.G.S. units for resistance and 10^{-1} C.G.S. units for current, but he accepted the views of the majority of the conference, and at a later date lent his valuable assistance in defining accurately the conditions necessary for the realisation of the international ohm, ampere, and volt. As the outcome of the work of the conference, a committee, known as Lord Rayleigh's Committee, was appointed to define these conditions, and representatives of England, France, and Germany met at Washington and carried out a series of experiments, the results of which have determined the practice of all National Standardising Laboratories. Of the

committee engaged in this work. Prof. Rosa was the active head, and its successful issue was due in no small degree to his skill in overcoming the technical difficulties of the task and to his tact in dealing with the varied views of those engaged in the research.

The volume giving an account of these experiments, published by the Bureau of Standards in 1912, will form a fitting memorial of one who for the last twenty years devoted himself unweariedly to the advancement of electrical science. During the war he directed the development of a number of instruments of great use to the American forces in France. Among these may be mentioned a sound-ranging device and much radio apparatus suitable specially for aircraft. He was greatly instrumental in establishing the splendid radio laboratory at the bureau. Throughout his life he was keenly interested in the prevention of industrial accidents and in the provision of safety standards for the guidance of public authorities. The national electrical safety code at present in use in the United States owes much to him. His last work, now in the press, was an analysis of the expenditure of the Government Departments, which contains a number of statistics of great importance and interest.

Prof. Rosa was married in 1894, and Mrs. Rosa survives him; she has the deep sympathy of all those on this side of the Atlantic who knew her husband and appreciated his work.

MISS CZAPLICKA'S sudden death on May 20 cuts short a brilliant career. Having studied geography at Libau and Warsaw, she came with a research scholarship to this country in 1910, and soon after joined Somerville College, Oxford. She then turned her attention to anthropology, and, after taking the diploma in that subject, conceived the bold project of an expedition to the almost un-

known part of the Siberian *tundra* lying between the Yenisei and Lena valleys—a project that was carried out with brilliant success in the years 1914–15. It was in keeping with her spirit of thoroughness, however, that by way of preparation she should first review the existing literature, mostly Russian, relating to this region, thus producing "Aboriginal Siberia" (Clarendon Press, 1914), a book not only full of out-of-the-way information, but likewise showing interpretative power of a high order. Her return from an adventurous journey involving great privations was marked by the appearance in 1916 of a popular work, "My Siberian Year"; but the full report by herself and her colleague, Mr. H. Hall, of the University of Pennsylvania, has not yet been published. At Oxford Miss Czaplicka acted as lecturer in ethnology until the end of the war, when she passed on to the University of Bristol to serve in a like capacity under Prof. Fawcett. In the meantime she found time to compose a valuable monograph on "The Turks of Central Asia," as well as to contribute many articles on the Siberian tribes to Hastings's "Dictionary of Religion and Ethics"—articles which might well be reprinted together in book-form. This brief account must suffice of the work of one whose intellectual energy was on a par with her personal charm and lofty spirit of self-devotion. Poland, so prolific of genius, can count her among its best. In Oxford, London, and Bristol alike she was the centre of a circle of admiring friends, whose lasting regret it now is that they did not somehow prevent the too courageous spirit from fatally overtaxing the delicate frame.

R. R. M.

WE regret to announce the death, on May 31, of COL. JOHN HERSHEL, R.E., retired, F.R.S., youngest son of the late Sir J. F. W. Herschel, Bart., in his eighty-fourth year.

Notes.

THE list of honours conferred on the occasion of the King's birthday includes the following names of men known to the world of science:—*Knights*: Prof. Arthur Keith, Hunterian professor and conservator of the Royal College of Surgeons; Dr. T. Lewis, hon. consulting physician since April, 1918, to the Ministry of Pensions; Dr. S. Russell-Wells, Vice-Chancellor of the University of London; Dr. F. Conway Dwyer, ex-president of the College of Surgeons, Ireland; Mr. J. B. Harrison, Director and Government Analyst, Department of Science and Agriculture, British Guiana; and Brig.-Gen. D. J. McGavin, Director-General of Medical Services in New Zealand. *C.B.*: Mr. Ll. S. Lloyd, Assistant Secretary to the Department of Scientific and Industrial Research. *K.C.I.E.*: Col. W. H. Willcox, late Medical Adviser to the Civil Administration in Mesopotamia. *C.I.E.*: Dr. M. N. Banerjee, Principal of Carmichael Medical College, Belgatchia, Bengal. *Companion Imperial Service Order*: Mr. G. J. Williams, Senior Inspector of Mines, Mines Department.

AN interesting ceremony took place at the Cosmos Club in Washington on Tuesday, May 10, when Mr. Henry S. Wellcome presented Dr. F. B. Power with a gold medal, specially struck to commemorate the latter's tenure of the directorship of the Wellcome Chemical Research Laboratories in London from their foundation in 1896 to 1914, when for family reasons he returned to the United States. During that period more than 170 papers were published from the laboratories, mostly in the Transactions of the Chemical Society. These papers deal chiefly with the constituents of plants, more especially with those plants used in medicine, and they form a notable contribution to our knowledge of the chemistry of drugs of vegetable origin. It will be remembered that in 1913 Dr. Power received the Hanbury medal, which is bestowed periodically by a joint committee of the Chemical, Linnean, and Pharmaceutical Societies in recognition of specially meritorious research on drugs.

A DISCOVERY in the Channel Islands of considerable interest to archæologists is announced in the *Times*

of May 31. Mr. L. M'Lellan Mann, of Glasgow, has found on the surface of a rock at Green Island, Jersey, a series of shallow depressions or "cups." Similar cup-markings are found in Great Britain and on the Continent, and are widely distributed over other parts of the world, including India, Australia, and North America. Green Island, where these cups have been found, is an island at high tide only, and has been severed from the mainland in comparatively recent times. From previous discoveries it is known to have been the site of a Neolithic burial-place. This would be in agreement with the usual attribution of rock carvings, such as these in Jersey, to the Neolithic or early Bronze age. On the other hand, cup-marks with one or more concentric rings, which have a more restricted distribution and, with a few exceptions, are found only in the United Kingdom and Sweden, are usually more or less closely associated with remains of the Bronze age. It is stated that cup-markings have not hitherto been recorded from the Channel Islands. This, however, is an error. Sir J. Y. Simpson figured two cup-marked stones from Guernsey, one being the prop stone of a dolmen with eleven cups, the other a conical standing stone with three large cups placed at some distance apart (J. Y. Simpson, "Archaic Sculptures," Proc. Soc. Scot. Ant., 1864-65, plate viii., Figs. 2 and 3; see also C. Rau, "Observations on Cup-shaped and other Lapidarian Sculptures in the Old World," in "Contributions to North American Ethnology," vol. v., Washington, 1882, pp. 12-13). No cup-marked stones have, however, previously been recorded from Jersey.

THE Advisory Council for Scientific and Industrial Research has quite recently granted an application made to it to assist in carrying out a piece of research work relating to the determination of the parallaxes of stars having a certain type of spectrum. The grant has been made to Mr. W. B. Rimmer, who up to the present has been employed in spectroscopic researches at the Imperial College of Science and Technology under the direction of Prof. A. Fowler, but will now carry out this research at the Norman Lockyer Observatory at Salcombe Hill, Sidmouth. This observatory was founded by the late Sir Norman Lockyer in 1912, and the programme of work has been confined strictly to the photography of the spectra of stars and their subsequent classification according to his scheme of increasing and decreasing temperatures, which has been confirmed in its general features by the more recent work of Russell and Hertzsprung on giant and dwarf stars. The researches of Prof. W. S. Adams have now rendered it possible to differentiate almost at a glance between a giant and a dwarf star. As a large amount of spectroscopic material was available at the Norman Lockyer Observatory for the application of Adams's method a trial research was begun. The method is based on a connection found by Adams to exist between the true brightness of a star and the intensity of certain lines in its spectrum. These line-intensities were determined by him by estimation, the plates being examined under a spectro-comparator. At the Norman Lockyer Observatory the method employed is to cover

the lines gradually with a dark wedge, the position of which when a line is obliterated indicates the intensity of the line. The results of this trial research have proved very satisfactory, and were commented upon very favourably by Prof. H. N. Russell on the occasion of a visit to the observatory. The above grant has been awarded to aid the extension of this research to all stars of suitable type down to declination -10° and of magnitude 6.5 and brighter. It is very opportune, for the staff of the observatory is small, and the work could not have been undertaken without such additional help.

THE annual visitation of the National Physical Laboratory, Teddington, will be held on Tuesday, June 28, from 3 to 6 p.m.

THE Safeguarding of Industries Bill was read a second time in the House of Commons on Tuesday, June 7.

THE annual conversazione of the Institution of Electrical Engineers will be held at the Natural History Museum, South Kensington, on Thursday, June 30, from 8.30 to 11 p.m.

AT the meeting of the Physical Society of London on June 10, to be held at the Imperial College of Science, South Kensington, S.W.7, Sir Ernest Rutherford will deliver a lecture entitled "The Stability of Atoms."

PROF. EINSTEIN was expected to arrive at Manchester yesterday, and will deliver the Adamson lecture on "Relativity" at the University at 5.0 this afternoon, June 9, when the honorary degree of Doctor of Science will be conferred upon him. He will leave Manchester for London to-morrow morning, June 10.

MR. CHURCHILL announced at Manchester on Tuesday, June 7, that the Government has decided to devote the sum of 1,000,000*l.* to fostering cotton-growing in the British Empire. The money will be placed at the disposal of the British Empire Cotton Growing Corporation, and will be in place of the Government's former promise of 50,000*l.* a year for five years to the corporation.

THE Hugo Müller lecture of the Chemical Society, entitled "The Natural Photosynthetic Processes on Land and in Sea and Air, and their Relation to the Origin and Preservation of Life upon the Earth," will be delivered by Prof. Benjamin Moore on June 16 at 8 p.m. in the lecture hall of the Institution of Mechanical Engineers, Storey's Gate, Westminster, S.W.1.

AT a general meeting of members of the Royal Institution held on June 6 special thanks were given to Sir Humphry Davy Rolleston for his present of a safety-lamp which was in the possession of Dr. John Davy, brother of Sir Humphry Davy, and to Sir David L. Salomons for his present of a privately printed Life and Study of the Works of Breguet, the famous watchmaker, Arago's watch, and two others of special interest, the first working aneroid made by Vidi in 1857, and a series of models illustrating the development of the chick.

It is proposed to hold an additional ordinary meeting of the Royal Meteorological Society for the reading and discussion of papers in Edinburgh on September 7. The British Association will be in session in Edinburgh on September 7-14, and arrangements are being made to hold the society's meeting, probably in the afternoon, immediately before the work of the Association begins. The possibility of a "meteorological luncheon" and of an excursion of special meteorological interest is also under consideration.

THE Newcomen Society for the Study of the History of Engineering and Technology is one of our younger societies, having been founded only a year ago. The titular name adopted by the society is that of the eighteenth-century engineer to whose labours we owe the steam-engine as we know it to-day. The subject which the society takes for its field is one which has been too much neglected in the past, perhaps more so in this country than elsewhere, in spite of the fact that England has been the cradle of so many leading inventions. To some extent this indifference is caused by the fact that the materials needed by the historian in this branch of human endeavour are all too scanty, and it is the aim of the society to help in supplying this deficiency. Besides holding meetings, the society intends to help in the preservation of records, MSS., and drawings of engineering work, as well as of biographical matter concerning those who have been prominent in such work. It is also intended to publish at the end of each session a yearbook containing original papers and historical matter not readily accessible. The summer meeting will be held in Birmingham on June 16-17 (headquarters, Queen's College, Paradise Street), under the presidency of Mr. A. Titley, and visits to places of interest are arranged for both days. On the first day the president will give his address, and Mr. A. Seymour-Jones will read a paper on "The Invention of Roller Spinning." This is appropriate in view of the little-known fact that the first attempts in this direction were made in Birmingham. The hon. secretary of the society is Mr. H. W. Dickinson, and communications should be addressed to him at the Science Museum, South Kensington, S.W.7.

THE thirty-second congress and health exhibition of the Royal Sanitary Institute will be held on June 20-25 at Folkestone under the presidency of the Earl of Radnor. Some five hundred delegates have already been appointed to attend the meeting, representing Government Departments interested and health authorities of the British Isles, as well as delegates from Australia, New Zealand, Canada, France, and Denmark. The congress will be divided into five sections:—Section A (president, Sir Leslie Mackenzie) will deal with sanitary science and preventive medicine; Section B (president, Major W. H. Prescott) with engineering and architecture; Section C (president, Mrs. H. A. L. Fisher) with the hygiene of maternity and child welfare; Section D (president, Mrs. R. G. Wood) with personal and domestic hygiene; and Section E (president, Viscount Burnham) with industrial hygiene. Conferences have been

arranged for medical officers of health, sanitary authorities, engineers and surveyors, veterinary inspectors, sanitary inspectors, health visitors, and rat officers. A long list of subjects for discussion has been published, among which are such important topics as the control of developmental and wasting diseases, the relation of hospitals to preventive medicine, tuberculosis, industrial fatigue and welfare, the prevention and destruction of rats, and smoke abatement. A popular lecture on June 23 by Prof. E. Mellanby on "Vitamins and their Relation to Health" has been arranged, and excursions will be made to places of interest in the neighbourhood of Folkestone. June 25 will be devoted to a whole-day visit to Boulogne, during which the members of the various sections will be conducted over appropriate institutes in the town. Further information on local arrangements can be obtained from the Secretary, the Royal Sanitary Institute, 90 Buckingham Palace Road, S.W.1.

DR. CAPITAN and M. Peyrony have contributed to the *Revue Anthropologique* a résumé of the works of art which they have discovered at La Ferrassie. The specimens are now deposited in the museum of the Château des Eyzies. The engravings, etc., belong to an early phase of the Aurignacian period, and are among the most ancient works of art known to exist. One of the earliest, which the explorers themselves unearthed, is a human figure from which the head and limbs are absent and only the trunk remains. This is rudely shaped and by no means beautiful; it is not steatopygous. Deeply outlined carvings of horses' heads and deer's heads were found on rocks. All the figures are exceedingly rude. One stone is occupied with cup markings in concentric circles, and cups appear mingled with other designs. Two complete figures of deer in outline, coloured red and black respectively, were found. Another figure represents the head of a rhinoceros, but only one engraved human figure appears. The authors note that all the engraved figures were placed face downwards, except in one case which could not be so treated; this had been designedly mutilated. They hold that these rudimentary, yet already complicated, images are the earliest known artistic manifestations and are ritual representations of magical practices.

MISS NINA F. LAYARD has published an interesting account of her discovery of mammalian remains with Mousterian flint-implements in a Pleistocene clay in the Stoke railway cutting at Ipswich (Proc. Pre-historic Soc. East Anglia, vol. iii., part ii.). Besides well-preserved teeth and bones of the mammoth, horse, large ox, and red deer, there are remains of three individuals of a large lion and fragments of a large bear. There are no traces of the reindeer. Close to the crushed skull of a mammoth were found some characteristic pieces of the shell of the small freshwater tortoise, *Emys orbicularis*, which had not previously been observed in late Pleistocene deposits in England. Miss Layard desires to mention that all the fossils were named in the geological department of the British Museum (Natural History).

THE greater part of the skull and neck, with a nearly complete shoulder-girdle, of a new Plesiosaurian from the Wealden of Berwick, Sussex, has just been added to the exhibited series of fossil marine reptiles in the geological department of the British Museum (Natural History). The specimen was found in a hard nodule in the pit of the Cuckmere Brick and Tile Co., and was presented to the museum by the managing director, Mr. Stanley Tooth. It represents a small reptile, about 6 ft. in length, and is of great interest as probably being a freshwater species. Just as among existing Cetacea the river-dolphins are generally smaller than the marine porpoises, so among the extinct Plesiosauria the freshwater forms may have been smaller than those living in the sea. In the structure of its shoulder-girdle the new species resembles the early Jurassic Plesiosaurs more closely than those of later Jurassic times. It, therefore, seems to have been an out-of-date survivor preserved by such an isolated mode of life as a freshwater habit would allow. The shoulder-girdle is uncrushed, retaining its original shape, and showing that the reptile was round-bodied, not depressed like a turtle.

THE Rhodesia Museum, Bulawayo, being in urgent need of a new exhibition gallery, has been promised 100*l.* by the Rhodes Trustees, and Sir Otto Beit has promised 250*l.*, provided the sum of 750*l.* be subscribed by the public. By the end of 1920 486*l.* had been subscribed, and the museum committee now appeals for further donations.

WE are glad to see that the *Museums Journal* is not fulfilling its threat to appear only quarterly instead of monthly, though it has overcome a temporary difficulty by an April-May number. In this Dr. Hecht, of the Nancy museum, makes some suggestions for co-operation between French and British curators, which should bear fruit when the Museums Association meets in Paris next month. One is that examples of the rings attached to migrating birds should be shown in the museums of the Continent, so that visitors to them may become aware of their meaning.

THE report of the South African Museum for 1920 records the death of the old Seychelles tortoise known as "Peter." It proved to be a female. So long ago as 1834 she had reached a gigantic size, but how old she then was is not known. One of the Cape tortoises belonging to the museum had reached a great size in 1843, and still fulfils the objects of her sex. Among much other interesting matter in this report, Dr. Peringuey adduces fresh evidence that the stone querns of the Bushmen were not for grain, but were grinding mills for crushing ore. The craft of these African smiths, however, never enabled them to make so much as an iron hammer or to dispense with the use of stone implements.

THE Journal of the Royal Society of Arts for May 13 contains a paper by Sir James Cantlie describing Thomson's machine for armless men in whom the amputations are so high that it is impossible to fit artificial limbs. The apparatus consists of a table under which are pegs which are worked by the toes.

These actuate rods and levers which communicate movements to rods above the table, which constitute artificial "arms" by means of which all kinds of instruments may be grasped and worked. The patient is thus able to use a spoon, knife, and fork, drink from a cup, pick up a cigarette from the table, place it in his mouth, open an ordinary box of matches, strike a match, and light the cigarette, write with pen or pencil, typewrite, turn over the leaves of a book, play draughts, wash and dry his face and neck, etc. The condition of the armless is indeed pitiable, and the inventor deserves the greatest commendation for the design and construction of this ingenious machine.

IN the Gardens' Bulletin, Straits Settlements (vol. ii., Nos. 9-11, 1921), Mr. T. F. Chipp publishes a list of the fungi of the Malay Peninsula, which it is hoped may facilitate the work of mycologists engaged on the study of plant diseases and lead to a more detailed systematic study of Malayan fungi.

SEVERAL papers dealing with the fungus flora of South Africa appear in the Transactions of the Royal Society of South Africa (vol. viii., part 4, 1920, and vol. ix., part 2, 1921). Miss Ethel Doidge contributes a revision of the native species of a family of moulds (Microthyriaceæ) which are abundant on the leaves of plants in humid wooded districts. Descriptions, and in many cases figures, are given of the species, a large proportion of which are new to science. In a second paper Miss Doidge describes in detail the method of attack and nutrition of the tropical genus *Meliola*, which occurs on shoots and leaves of forest trees and shrubs. The fungus is shown to be a true parasite, sending penetrating suckers through the epidermis of the host, blocking up the stomata, and causing considerable disorganisation of the cells. Mr. Paul van der Bijl describes for the first time a fungus (*Ovulariopsis papayae*) which attacks the pawpaw plant along the coast of Natal, forming a powdery covering on the under-face of the leaves.

THE Liverpool Geological Society has done well in publishing in its Proceedings (vol. xiii., part i., 1920) a translation, somewhat abbreviated, of Dr. A. Heim's paper "The Weight of Mountains." The original appeared in the Annual of the Swiss Alpine Club for 1918, and the illustrations are now reproduced. The map shows the variation of gravity throughout Switzerland from what is regarded as the normal value, and is based on results recently obtained with the seconds pendulum for a large number of localities. The measurements are recorded as if values below the normal were due to an excessive thickness of rock underlying the station with a specific gravity of 2.4, and curves are drawn representing these thicknesses at 100-metre intervals. Lines of normal gravity-effect (o) occur on the south side of the Black Forest and north of the Lago Maggiore. Between these regions the lines are approximately parallel with the strike of the Alpine folding, and the gravity-defect runs up to -1600 in the Engadine and to -1450 on the southern flank of the Rhône Valley near Visp. Dr. Heim regards the Alpine mass as floating, partially submerged, in a plastic "sima" underlayer, into which

it has sunk back to some extent since its maximum elevation in late Miocene times. There is thus beneath its surface a region of mass-defect, a "gravity-synclinal." The sheets of detritus from the early chain now dip towards their source, and the author once more urges that the lakes penetrating the foothills on either side are due to a reversal of the slope of primary valley floors. The paper thus presented to English readers is a clear and valuable addition to the literature of isostasy.

In the *Meteorological Magazine* for April a summary is given of the rainfall of San Domingo, dealing chiefly with the eastern half of the island. Meteorological data from the Dominican Republic are said to be extremely rare; the rainfall records discussed have been received by the Meteorological Office, and are roughly summarised by Mr. C. E. P. Brooks. The observations were forwarded by Mr. W. A. Elders, the general manager of the Samana and Santiago Railway, who since 1913 has had twelve rain-gauges installed. A map is given showing the annual average results for the twelve stations, which are situated along the valley of the Yuna River and its tributaries. Detailed monthly averages are given for Sanchez, on the border of Samana Bay, at the eastern extremity of the island, and for La Vega, situated near the centre of the island, about sixty miles westward from Sanchez. Results for Port au Prince, in the west of the island, are added for comparison. Over the eastern half of the island the heaviest rain occurs from May to August, and there is a subsidiary maximum in November. The driest months are from December to March. There is a considerable range in the annual rainfall. At Sanchez the average for the year is 71.09 in., ranging from 56.00 in. in 1918 to 81.52 in. in 1913; whilst at La Vega the average annual fall is 67.58 in., ranging from 41.28 in. in 1920 to 100.85 in. in 1917. The prevailing wind is from the east, distinctly a trade wind, trending somewhat from the south-east in the summer months and from the north-east in the winter months. The country is mountainous, but very fertile in the valleys.

At the April meeting of the Optical Society Mr. F. Twyman described an instrument for testing camera lenses. The method depends on interference, and permits of the measurement, in wave-lengths of the light used, of the deviation from sphericity of the whole of the wave-surface transmitted by a lens from a point source behind it. This is secured by mounting the lens under test so that it can be rotated about a line at right angles to its axis passing through its second principal point. The apparatus brings the beam which has traversed the lens into interference with one which has travelled a fixed distance, as in the case of a Michelson interferometer. The isochromatic lines of the interference pattern then correspond to equal deviations from sphericity of the transmitted wave surface. The instrument affords a most severe test, and defects of lenses by first-class makers have been found by its means.

THE report of the council presented at the annual meeting of the Illuminating Engineering Society on May 31 contains evidence of further useful work, new

joint committees in co-operation with various other bodies having been formed to study special problems arising from recent discussions. Amongst the subjects thus dealt with are photometry, motor-headlights, and the lighting of kinema studios. It is also remarked as gratifying that international co-operation in connection with illumination is being resumed. A session of the International Illumination Commission, the first since the outbreak of war, is being held in Paris in July, and such questions as motor-headlights, "artificial daylight," and regulations for industrial lighting will be discussed. Following the formal business at the annual meeting Mr. J. S. Dow read a paper on "The Use of Artificial Light as an Aid to various Games and Sports." An account of the lighting of various covered tennis courts was given, and it was suggested that even the artificial illumination of football and cricket grounds and golf links, though admittedly presenting considerable difficulties, might be accomplished in the future.

WE have received from Messrs. C. Baker, High Holborn, a descriptive pamphlet of a universal geometric slide photomicrographic apparatus made by them from the design of Mr. J. E. Barnard and originally described by him in 1911. The base is designed on the girder principle to obtain rigidity, and the portion carrying the microscope is constructed to swing out so that the object may be searched. The camera, a half-plate one, has a 3-ft. extension. The upper surface of the base carries two parallel metal rods, and the camera slides on these by two V-grooves on one and a plane surface on the other, the latter being intermediate in position between the V-grooves. The principle of the geometric slide is thus obtained, the apparatus being supported practically on three points forming the apices of a triangle, while alignment is maintained by the V-grooves. It may be clamped down in any position, and by means of a spindle running in bearings along the centre of the casting, which actuates a pulley "belted" to the fine adjustment with a thin cord, focussing may be carried out at any position. All subsidiary apparatus, including the illuminant, is similarly carried on geometric slides. The price of the apparatus is 33*l.*, or with arc lamp and some subsidiary apparatus about 40*l.*

THE April issue of the *Whitehall Gazette* contains an interesting article on the fraudulent proceedings that were practised to avoid service when conscription was in force in this country. Some claimed exemption on the ground that they were suffering from consumption, but declined to provide sputum there and then, promising to send samples. The samples forwarded did contain tubercle bacilli, but they were dead, and the specimens were found to be artificial concoctions. A good many forged passports were produced by Russians who remained in this country. In some cases a passport belonging to another would have the written details bleached out by chemical means and the desired name, etc., inserted. Sometimes the date of birth of the man's own passport might be put back ten years. These forgeries were detected by the change in reflecting power of the surface of the paper caused by the removal of the size

by the bleaching agent or by the attempt to replace it, by the spreading of the ink caused by the removal of the size, by the restoration to visibility by chemical means of the bleached-out writings, by the finding of the bleached inscriptions by photography under suitably coloured lights, and so on. The article is illustrated with excellent photographs and reproductions of photographs.

ON May 10, at the Institute of Petroleum Technologists, Prof. P. Carmody (late Government analyst, Trinidad) read a paper on "Trinidad as a Key to the Origin of Petroleum." Prior to the meeting the title of the paper had created much interest and curiosity, especially among those members who have had professional experience in the island, but unfortunately both the paper and subsequent discussion were scientifically somewhat disappointing. The author's main contention was that in a comparatively small area, within reasonable access of Europe, and under conditions of life peculiarly satisfactory for a tropical island, there exist all the requisite natural factors for an exhaustive research into the origin of petroleum, as yet a little understood problem. The solution of which must perforce have far-reaching scientific and economic results. The natural factors referred to include the occurrence of varied forms of solid, liquid, and gaseous hydrocarbon compounds within the rocks of the island, and in illustration of his idea the author gave a brief description of these, supplemented with a large number of chemical and physical

data obtained during the course of some thirty years' work in the Government laboratory. There is obvious value in the publication of such data by one whose long experience entitles him to speak with authority, but the *raison d'être* of the paper suffered much from the somewhat narrow view taken as to the origin of oil, viz. its derivation entirely from vegetable matter, *i.e.* cellulose. On this assumption, and in view of the many known oil occurrences wherein marine organisms have unquestionably been involved, it is doubtful whether Trinidad does indeed constitute the desired "key," and whether, as the president remarked later, the existence of all these forms of petroleum is not a disadvantage rather than an aid to the solution of the problem.

PROF. R. S. TROUP, of the forestry department of the University of Oxford, has written for publication by the Oxford University Press a work in three volumes on "The Silviculture of Indian Trees." The first volume, dealing with Dilleniaceæ to Leguminosæ—Papilionaceæ, is promised for appearance by an early date.

A FULL report of the meeting held on May 30 by the National Union of Scientific Workers on "The Administration of Scientific Work," of which a short account was given in last week's NATURE, p. 439, will appear in the next issue of the union's Journal. Copies may be obtained from the Secretary, N.U.S.W., 25 Victoria Street, S.W.1, at the end of this month (post free 6d.).

Our Astronomical Column.

COMETS.—Reid's comet is rapidly fading, but should be within reach of moderate instruments for another month. An extension of the ephemeris from Ebell's elements for Greenwich midnight is therefore given:

	R.A.	N. Decl.		R.A.	N. Decl.
	h. m. s.	° ' "		h. m. s.	° ' "
June 9	8 8 33	51 38	June 29	8 17 41	43 31
	13 8 10 41	49 35	July 3	8 19 16	42 21
	17 8 12 37	47 48		7 8 20 49	41 18
	21 8 14 24	46 13		11 8 22 19	40 19
	25 8 16 3	44 48		15 8 23 46	39 24

Values of $\log r$, $\log \Delta$: June 13, 0.0665, 0.2311; June 25, 0.1054, 0.3035; July 7, 0.1459, 0.3543.

The following observation of Pons-Winnecke's comet was obtained at Greenwich: G.M.T. June 2d. 10h. 57m. 38s.; apparent right ascension, 20h. 37m. 15.85s.; apparent north declination, $37^{\circ} 12' 45.8''$. The position deduced from Crawford and Levy's second elements is right ascension 20h. 38m. 5s., north declination $37^{\circ} 3'$. The elements are therefore fairly near the truth.

The comet now appears large and diffused owing to its small distance from the earth. It will be nearest to both earth and sun on June 12.

Mr. G. Merton obtained an observation of Dubiago's comet on June 1. He states that its position agreed closely with the ephemeris given in NATURE of May 26.

NOVA CYGNI III. (1920).—Mr. Denning writes that he observed this object on June 5 at 10h. 40m. G.M.T. with a $6\frac{1}{2}$ -in. refractor: He estimated the magnitude to be 9.6, so that the star's light would appear to have declined very slightly during the last $7\frac{1}{2}$ months. It will be remembered that the magnitude of the star decreased from 1.8 to 8.5 during the 72 days from

August 24 to October 6, 1920, so that the average decline of light was 0.16 per day. Since about the middle of October, however, the nova appears to have maintained its brightness in a rather unexpected way.

COLLISION OF STAR AND NEBULA.—Prof. Ernest W. Brown contributes a paper on this subject to the April issue of the *Astrophysical Journal*. Taking the star as origin and the line of relative motion as the Z-axis, particles of the nebula equidistant from this axis would all be deflected into similar hyperbolic orbits meeting in a point on the axis. There would thus be numerous collisions of particles along the axis which would generate a fan-shaped nebula with its apex towards the star. Another nebulous envelope surrounding the star would be formed by collisions of particles with the star or its appendages. The nebula is supposed to be non-gaseous at the start, being composed of widely scattered particles.

Hubble's variable nebula round the star R Monocerotis is discussed in detail, and it is shown that its form agrees closely with that indicated by the theory. It is suggested that the variations in the light of the fan-shaped appendage may arise from irregularities in the density of the nebula that the star is supposed to be traversing. It is shown that Prof. Slipher's observation that the stellar envelope and the fan-shaped appendage have identical spectra is in accord with the hypothesis, for both would arise from the gas resulting from collisions of the nebular particles. Slipher and Lampland's further statement that the spectra resemble those of novæ in their early stages suggests to Prof. Brown that a similar explanation may be available for the phenomena of novæ.

The Edinburgh Meeting of the British Association.

THE preliminary programme and invitation circular for the eighty-ninth annual meeting of the British Association, to be held in Edinburgh on September 7-14, is now ready for distribution. Members of the Association will receive it shortly if it has not already reached them; others who propose to attend the meeting may obtain a copy on application to the Assistant Secretary of the Association, Burlington House, London, W.1. The circular, which is more comprehensive than has been customary, contains more than a merely preliminary programme, for many of the definitive arrangements for the meeting are set forth and a time-table of the principal engagements is appended. The circular is a pamphlet of sixteen pages with a three-leaf cover. One leaf, detachable at a perforation, provides two reply forms—one for intimation of attendance and the other for intimation of the member's local address—and, in order to assist the organisation of the meeting, members who propose to be present are requested to complete and return these forms at their earliest convenience. On another cover is a useful map of central Edinburgh, on which are indicated the principal buildings, especially those to be used for the meetings, the railway stations, the bus and tram routes, and the principal hotels.

A prefatory note on Edinburgh is followed by the announcements regarding conditions of membership and railway communications. In the latter we note that the general officers of the Association have made, and will continue to make, every endeavour to secure a reduction of return fares for members attending the meeting, but up to the present they have been unable to obtain this concession from the railway authorities, and, failing the issue of a further intimation, it must be assumed that the concession formerly customary cannot be given this year. Enclosed in the circular is a printed slip directing attention to a proposal to run motor coaches from London (following routes *via* Oxford and Cambridge) and from Bristol, Liverpool, and other towns north of these, to convey members to Edinburgh, and back again if so desired. The fares would be approximately two-thirds of those charged by the railways in each case. The motor coaches would leave London and points south of Liverpool on September 5, completing the journey to Edinburgh in two days, and arrangements would be made for hotel accommodation *en route*. From Liverpool, Manchester, Leeds, and points north thereof the journey to Edinburgh would be made in one day—September 6. Passengers' luggage would be collected and delivered, each passenger being allowed 56 lb. free of charge. This enterprising project can be realised only

if the transport company has a guarantee as to the number of members who would be prepared to avail themselves of it, and members are therefore requested to state on their intimation forms if they would make use of the motor service.

The programme gives the titles of the addresses, discourses, and principal discussions. The presidential address by Sir Edward Thorpe will deal with some aspects and problems of post-war science pure and applied. The evening discourses are on subjects especially appropriate to a meeting in Edinburgh. Prof. C. E. Inglis will make a comparison of the Forth and Quebec bridges, showing the evolution of cantilever-bridge construction during the past thirty years; and Prof. W. A. Herdman will give an account of the important part played by Edinburgh in the progress and development of the science of oceanography.

The sectional presidents' addresses will cover a wide range of subjects; for example, the laboratory of the living organism, the boundaries of physiology, experimental geology, evolution, the theory of descent in relation to the early history of plants, the study of native races, consciousness and the unconscious, the place of music in a liberal education, water-power, the principles by which wages are determined, and agricultural economics. Several of these addresses are to be introductory to discussions. The president of the Conference of Delegates of Corresponding Societies is to give an address, followed by a discussion, on "Science and Citizenship." Arrangements have been made for a number of joint sectional discussions, and the following are announced as the respective subjects: The structure of molecules, the age of the earth, biochemistry, the proposed mid-Scotland canal, the origin of the Scottish people, and vocational training and tests. The times of the sectional presidential addresses and of the principal discussions have been arranged so that those on cognate subjects are not held at the same hour; for instance, the addresses are distributed over the Thursday, Friday, and Monday mornings, and not more than two are at the same hour.

From this summary it will be evident that the arrangements for the meeting are in an advanced stage, and we understand that this is also the case in regard to the programme of papers to be presented to the various sections.

The forthcoming meeting in Edinburgh—restored to its pre-war length of a full week—promises to be one of great scientific interest and value, and all well-wishers of the Association are looking forward to a full resumption of the activity and influence of the Association.

The Royal Observatory, Greenwich.

THE visitation of the Royal Observatory took place on June 4, when the report of the Astronomer Royal, which covers the year ended on May 10, was presented. The report states that strenuous efforts are being made with the transit circle to complete the present catalogue, which embraces some two thousand stars of the list prepared by Dr. Backlund and Mr. Hough; the aim of that list was to obtain a convenient number of reference stars uniformly distributed over the sky. These observations will be concluded at the end of this year, after which observations will be commenced of all stars down to magnitude 8.0 between N. declination 32° and 64° . It will be remembered that stars down to magnitude 9.0

between declination 64° and 90° , and also between 24° and 32° , have recently been observed at Greenwich. The catalogue of the last-named region was distributed during 1920; it includes the determination of the proper motions of 12,000 stars.

The mean error of the longitude of the sun, as given in the Nautical Almanac, is $-1\frac{1}{2}''$; that of the moon is $-13''$, which is deduced from observations on 114 nights. Eight occultations of stars by the moon were observed, and also both phases of the solar eclipse of April 8.

The 28-in. equatorial has undergone extensive repairs by Messrs. Cooke; observations of double stars have now been resumed. The working catalogue

has been drawn up with the idea of avoiding overlapping of observation and of including stars the orbit determination of which is hopeful. Many orbits of binaries have recently been computed by Mr. Jackson, who has also, together with Mr. Furner, published an investigation showing that the mean mass of binary systems is double that of the sun. Working on this assumption, hypothetical parallaxes have been deduced for several hundreds of stars. The observations with the 28-in. equatorial since 1893 have been collected into a volume, which is nearly ready for publication; it also contains the orbits found by Mr. Jackson, and notes on the relative motion in cases where orbits cannot yet be determined.

The programme of parallax determination with the 26-in. equatorial is being continued. The plan of taking double exposures on the same plate at six-month intervals has been dropped; each plate is now developed after exposure. Fiducial plates of each field are prepared by making rulings with a diamond in the positions of the parallax star and reference stars; all the plates are compared in succession with the appropriate fiducial plate. Forty-nine parallaxes have thus been deduced in the year, the number of plates measured being 829; the probable error of a determination is 0.009".

There are two extensive investigations in progress with the aid of diffraction gratings. The grating employed with the astrographic equatorial gives a first diffracted image 2.83 magnitudes fainter than the principal image. By successive steps it is possible to compare the magnitudes of all stars within the range of the instrument. The magnitudes of the stars in the Harvard polar sequence are being re-determined. The results obtained so far confirm the Harvard scale for the fainter stars, and the Mount Wilson one for the brighter.

The grating on the 30-in. reflector is being used to obtain the effective wave-length, and hence to infer the spectral type, of the stars in the Greenwich astrographic zone (declination 64° to 90°). An exposure of seven minutes suffices to give satisfactory results for

stars of magnitude 10.5. Effective wave-lengths have already been determined for 550 stars within 3° of the Pole, the mean probable error being 10 angstroms.

The astrographic equatorial will shortly be dismounted in preparation for its removal to Christmas Island for next year's eclipse. Sir Howard Grubb and Sons are making an equatorial mounting for use there, as the cœlostast method proved unsatisfactory in 1919 for a problem involving such great precision as the investigation of the Einstein bending of light. Mr. Jones and Mr. Melotte will start for Christmas Island early next year, and remain six months on the island. The fact of having an astrographic equatorial close to the equator will be utilised for taking series of photographs for the purpose of comparing the magnitude scales of northern and southern zones.

The Reid and Pons-Winnecke comets have been observed both visually and photographically on several nights. The first photograph of the latter was secured within a few hours of the receipt of Prof. Barnard's telegram announcing his detection of the comet.

The usual magnetic and meteorological observations have been continued. The mean magnetic declination for 1920 was $14^{\circ} 8' 7''$ W.; it is diminishing by $9\frac{1}{2}'$ annually, which will bring it to zero about the close of the century. The chief magnetic disturbance was from March 22 to 25, 1920, being associated with a large group of sun-spots. The mean temperature for the first four months of 1921 was the highest for that period during the last eighty years, January being 7.5° above the average. The rainfall was 18.77 in., being 5.47 in. below the average of seventy-five years. July and September alone were above the average.

The Astronomer Royal refers to the success attained by Mr. Bowyer in the mechanical registration of wireless signals on a siphon recorder. Signals are received from the Eiffel Tower, Nauen, Annapolis, Darien, Bordeaux, and Lyons; some special series were sent from Lyons for the determination of Australian longitudes. These were recorded both at Greenwich and in Australia.

A. C. D. C.

The Chinese Earthquake of December 16, 1920.

By DR. C. DAVISON.

A PRELIMINARY report on the destructive Chinese earthquake of December 16 last has been prepared by Father E. Gherzi, and is published by the Zi-ka-wei Observatory. Though brief, it is of considerable interest, as it is the first scientific account that we have received of this great earthquake. The report is based on the letters received from correspondents of the observatory (nearly all missionaries), on articles in Chinese and other newspapers, and on the seismograms provided by the Wiechert astatic pendulum (mass 1200 kg.) at the observatory.

The first shock registered there occurred on November 16, others on December 4, 6, and 10, and possibly three early on December 16. The primary waves of the great shock arrived on that day at 12h. 9m. 16s., and the secondary waves at 12h. 11m. 45s. In less than two minutes later one of the recording levers was dismantled, and after $3\frac{1}{2}$ minutes more the other passed off the paper and was put out of action. Such as it is, the seismogram shows that the epicentre was about 1400 km. from Zi-ka-wei, and that the time at the origin was 12h. 6m. 5s. (G.M.T.).

The area most strongly shaken lies in the provinces of Kansu and Shensi, in the north-west of the country, in which are situated the origins of the most dis-

astrous of Chinese earthquakes. From the somewhat scanty materials at his disposal, Father Gherzi has constructed the probable courses of the isoseismal lines, using the Mercalli scale. The curves of chief interest are those of degrees 10 and 1. The former surrounds all the places at which the destruction of buildings was total or nearly so. It includes the towns of Pingliang, Kingchow, Kuyuan, and Tsingningchow, and covers a district about 180 miles long, 60 miles wide, and more than 8000 square miles in area. Its longer axis is directed N.N.W. and S.S.E., and is roughly parallel to the axes of the great crust-folds of this region. Assuming this isoseismal to be drawn correctly, it follows that the position of the epicentre is about 35.8° N., 106.2° E.

As in all earthquakes of the first magnitude, the duration of the shock was considerable—according to one observer, who measured it, certainly three minutes. Throughout all this time the shock seemed to vary but little in intensity, though becoming slightly stronger near the middle. The effects of the shock were aggravated by the structure of the country—the rock in the central area being capped by a thick bed of loess, through which the streams have worn ravines with nearly vertical sides. Roads are said to be cut up

by fissures in which houses have disappeared, and are blocked by avalanches which have fallen from the ravines. Father Gherzi estimates the loss of life at more than 40,000, by no means a large figure for an earthquake of this character. Probably the real number will never be known, as it is a custom in this district for families to live in caves hollowed out in the loess along the river-sides, which in many cases were blocked by the fall of avalanches.

The isoseismal 4, which forms the boundary of the known disturbed area, is incomplete towards the west. Its mean radius, in the portion drawn, is about a thousand miles. Thus the disturbed area probably contains more than three million square miles, and is perhaps not much inferior in extent to the whole of Europe. At the present time the largest disturbed areas known to us are those of the Assam earthquake of 1897 (about $1\frac{3}{4}$ million square miles), the Kangra earthquake of 1905 (nearly 2 million square miles), and the Charleston earthquake of 1886 (about 2,800,000 square miles). The last area is, however, bounded by an isoseismal line of intensity 2. If the corresponding isoseismal could have been drawn for the Chinese earthquake, the figure given above for its disturbed area would have to be multiplied several times. In any case it is clear that we are dealing with a shock which, if not the greatest, is certainly one of the greatest, known to us since earthquakes began to be studied.

Since the foregoing was written, a report by a small party of foreign travellers has appeared in the *Times* of June 4. Though the travellers were unable to examine the whole of the central region, they state that the shock was felt principally within an area of 15,000 square miles, bounded approximately by the parallels of 35° and 37° and the meridians of 105° and 107° , thus agreeing with the result deduced from Father Gherzi's map. The loss of life, however, is estimated at a far higher figure than that given above. "The prefectural Taoyin of Pingliang puts the total loss of life at 180,000, or one-third of the whole population; 30,000 perished at Kuyuan. Haicheng appears to have been almost completely buried by the surrounding hills tumbling in upon it, about 70,000 people being entombed." Such a total has but rarely been approached, and only twice, I believe, surpassed. The number of deaths due to the Messina earthquake of 1908 cannot fall far short of 100,000. In the Indian earthquake of 893 180,000 persons are said to have perished; in the Japanese earthquake of 1703, 200,000; and in the Indian earthquake of 1737 the reported number rises to a maximum of 300,000.

Stereochemistry.

AT the seventh Indian Science Congress Prof. B. K. Singh, who presided over the chemistry section, delivered an address on "Recent Advances in Stereochemistry," which has since been published in pamphlet form.

After reviewing the early development of the subject by Pasteur, the theory of the asymmetric carbon of van't Hoff and Le Bel, and the later researches on asymmetric nitrogen, sulphur, and selenium by Pope, Peachey, and others, Prof. Singh proceeds to discuss the more obscure relations subsisting between the amount of rotation and the constitution of the active substances. In this connection he touched on the work of Pickard and Kenyon, the main outcome of whose researches was to indicate a sudden rise of rotation produced at the end of a chain of five or a multiple of five carbon atoms—a phenomenon which was explained by the proximity of the first and fifth

carbon atoms in the chain. Reference was also made to the work of H. O. Jones on the activity of quaternary ammonium bases containing different radicals and certain generalisations which followed. The influence of conjugation, as illustrated by the work of Rupe, and the abnormally high rotations produced in the derivatives of amino-camphor were also reviewed. This was followed by a reference to the relation of optical activity to position isomerism, with a discussion of Frankland's theory.

Prof. Singh, who has himself contributed certain observations on the subject, comes to the conclusion that neither Frankland's theory nor what he terms "Cohen's rule" accords with the facts; but omits to point out that both his own and Frankland's observations are made with dissolved substances in which the solvent may, and frequently does, modify the rotation, whereas Cohen and his co-workers purposely avoided the use of any solvent. Finally, the address dealt with those mysterious changes of rotation known as "the Walden inversion," which are effected by certain reagents, when one constituent of an asymmetric group undergoes replacement. The earlier theories based upon change of structure due to the reagent have since been shown to be untenable in the light of the work of Senter and Drew, who find that with the same reagent different solvents may produce a similar inversion.

J. B. C.

University and Educational Intelligence.

BIRMINGHAM.—At the meeting of the Council of the University held on Wednesday, June 1, Mr. Walter H. Moberly was appointed to the chair of philosophy to succeed Prof. J. H. Muirhead, who is retiring from the chair in September next. Mr. Moberly is dean, fellow, and tutor of Lincoln College, Oxford, and one of the best known of the younger teachers of political and social philosophy in the Philosophy and History School of that University. His experience of municipal administration as a member of the Oxford City Council and his work with the Workers' Educational Association should contribute to make him a fitting successor to Prof. J. H. Muirhead.

Dr. H. J. W. Tillyard has been appointed to the chair of Russian, and Signorina L. P. di Castelvecchio to the Serena chair of Italian. Dr. Tillyard is the first occupant of the chair of Russian in the University—a chair founded on the fund collected for the purpose by the Birmingham Chamber of Commerce. Signorina di Castelvecchio is the first professor of Italian to occupy the chair founded on a generous benefaction from Mr. Arthur Serena and on funds collected by the Birmingham Chamber of Commerce. She is the first woman to be appointed to a chair in the University.

The Council has also appointed Mr. E. H. F. Mills, fellow of St. John's College, Cambridge, and secretary of the University Library, Cambridge, to the office of librarian which will shortly be vacant by the retirement of Mr. W. H. Cope.

CAMBRIDGE.—Dr. G. E. Moore, Trinity College, and Mr. W. E. Johnson, King's College, have been re-elected University lecturers in moral science, and Mr. F. Debenham, Gonville and Caius College, has been re-elected University lecturer in surveying and cartography. Mr. J. A. Venn, Trinity College, has been nominated Gilbey lecturer in the history and economics of agriculture. Mr. J. C. Wallace has been elected a junior fellow of Emmanuel College.

Miss F. E. Haines has been elected to a scientific fellowship at Girton College, and Miss M. T. Budden to an associates' fellowship in mathematics at Newnham College.

It is proposed to appoint a committee of nine to manage the low-temperature station for research in biochemistry and biophysics, which is nearing completion. Five members of the committee are to be nominated by the council of the Senate and four by the Department of Scientific and Industrial Research.

The Syndicate to consider possible alterations affecting the Mathematical and Natural Sciences Tripos is to consist of Dr. Fitzpatrick, Sir Joseph Thomson, Prof. H. F. Baker, Sir Ernest Rutherford, and Messrs. W. B. Hardy, A. Hutchinson, W. H. Mills, J. Barcroft, J. F. Cameron, A. Wood, C. G. Darwin, R. H. Fowler, and G. P. Thomson.

Dr. H. Hartridge, King's College, has been appointed senior demonstrator in physiology.

Owing to the continued difficulties of railway travelling, the vote on the admission of women to membership of the University or to titular degrees has been postponed from June 16 to October 20.

The Arnold Gerstenberg studentship will be awarded to the science student of proper standing who writes the best essay on one of the following six subjects:—The Ultimate Data of Physics, Philosophical Aspects of the Theory of Relativity, Mechanical Explanation and the Problems of Biology, The Theory of an "Elan Vital" and Related Conceptions, Heredity and Memory, Instinct and Intelligence.

MANCHESTER.—Dr. Harold Robinson, senior lecturer in physics and assistant director of the physical laboratories, has resigned his appointment as from September 29 next.

The following have been recommended for the degree of Doctor of Science:—Frederick William Atack, William Broadhurst Brierley, Colin Campbell, Robert George Fargher, William Harold Pearsall, and Henry Smith Holden.

IN connection with the department of coal gas and fuel industries of Leeds University a Corbet-Woodall scholarship in gas engineering is being offered. It is of the annual value of 60*l.*, and tenable for three years, with the possible extension to a fourth. Full particulars can be obtained from the registrar of the University. The latest date for receiving applications for the scholarship is June 15.

SUMMER schools for practical work in open-air geography, geology, botany, and allied sciences will be held under the auspices of the Geographical Association at Chamonix (July 28–August 11) and in Snowdonia (August 13–27). The original glacial researches of De Saussure, Forbes, and Tyndall will be retraced in the Chamonix district, and, similarly, Ramsay's work on the ancient glaciers of North Wales will be studied in Snowdonia. Particulars of the arrangements may be obtained by sending a stamped addressed envelope to Mr. H. Valentine Davis, "Noddfa," Wistaston, Crewe.

THE Bulletin of the National Research Council for March (vol. ii., part 1, No. 9) contains a classified statement compiled by the Research Information Service of the funds available in 1920 in the United States for the encouragement of scientific research. The publication falls into seven sections, of which the first is introductory, and sections ii. to vi. contain lists of the medals, prizes, fellowships, etc., in connection with which specific mention is made of research. In section ii. the various medals and prizes are brought together; section iii. deals with grants for research; section iv. with institution funds for research; and section v. with the fellowships and scholarships available for research workers. In every case reference is made to the awarding body, the nature of the research for which the award is made, the frequency of award,

and usually the monetary value. Section vi. consists of an index to the subjects in which funds for research are available; while section vii. forms an index to the various institutions which make awards and to the funds from which grants for research are allotted. A truly remarkable amount of information from widely scattered sources is thus brought together conveniently in a single publication.

THE programme of the Summer School of Civics, to be held this year at Guildford, Surrey, from July 30 to August 13, offers opportunities for good all-round social study. The courses of lectures to be given fall into three groups. In the first come those on geography, descriptive economics, primitive and present-day institutions, and anthropology; through these the student will be given a condensed view of community life at the present day. In the second group are the courses which develop a theory of community life, e.g. those on social biology, psychology, philosophy, etc. In the third group come the courses on the principles and practice of civics, social education, public administration, and economic problems. A special course for teachers on modern developments in education will also be given. Informal discussions will be, as formerly, a great feature of the school's work, and there will be exhibitions of civics, rustic surveys, housing and town-planning schemes, and excursions in Guildford and the neighbourhood. Mr. A. Farquharson will be responsible for the general direction of the school, and a number of well-known lecturers have offered their services. The inaugural lecture will be given by Prof. Patrick Geddes, professor of sociology and civics in the University of Bombay, and special lectures on psycho-analysis are being given by Miss Barbara Low. Full particulars of the school may be obtained from Miss Margaret Tatton, secretary, Civic Education League, Leplay House, 65 Belgrave Road, Westminster, S.W.1.

ONE of the prime features of the Education Act of 1918 was that establishing day continuation schools for young persons entering upon employment at fourteen years of age. Immediate provision was to be made by the various local education authorities for education during working hours for such young persons for seven or eight hours weekly for forty weeks of each of two following years. Many large firms in the North of England, chiefly textile and engineering, took advantage of the provision so made and established for their own employees classes of a liberal character during working hours. Some education authorities, of which Manchester is a notable example, also established facilities for continued day education. The London County Council was one of the very few authorities which adopted the Act, and the Board of Education thereupon named an appointed day in the terms of the Act. The Education Committee of the L.C.C., among its other activities, made large provision for the means of continued day education, which received a gratifying response. It is therefore a matter of much surprise that the Education Committee of the Council resolved on May 9, and confirmed at a meeting held on June 1, that the Council's interim scheme adopted on May 4 of last year be amended so as to provide for the continued day education of employed young persons up to 15 years of age only. The reason given for this decision is that the cost of continued education for two years under the Act is too great in face of the growing unwillingness of the people to pay increased rates. Apart from the serious injury to the young persons concerned, it is a proposal of very doubtful legality, and it is to be hoped that the recommendation to the Council, which was carried by a majority of only one, will be summarily rejected.

Calendar of Scientific Pioneers.

June 9, 1875. Gérard Paul Deshayes died.—A founder of the Geological Society of France, Deshayes was distinguished for his study of the fossil mollusca of the Paris basin. He assisted Lyell in the classification of the Tertiary system into Eocene, Miocene, and Pliocene.

June 10, 1836. André Marie Ampère died.—A teacher first at Bourg and Lyons, Ampère in 1805 became a professor at the Ecole Polytechnique, and in 1824 was appointed to the chair of experimental physics in the Collège de France. Like Oersted, Faraday, and Henry, he was a pioneer in the science of electrodynamics, which he developed with mathematical skill. His "Observations Electro-dynamiques" appeared in 1822 and his "Théorie des Phénomènes Electro-dynamiques" in 1830.

June 10, 1858. Robert Brown died.—Beginning life as an assistant surgeon in a Scottish regiment, through Banks Brown in 1801 went to Australia with Flinders in the *Investigator*, and four years later returned with a collection of 4000 plants. He was afterwards placed in charge of Banks's collections and became botanical keeper at the British Museum. The foremost botanist of his day, his works embrace not only systematic botany, but also plant anatomy and physiology. Humboldt called him "facile princeps botanicorum."

June 10, 1903. Luigi Cremona died.—Distinguished for his work in synthetic geometry, Cremona for thirty years was professor of higher mathematics in the University of Rome. He reorganised the mathematical instruction in Italy, and for a time was Minister of Education.

June 11, 1875. Joseph Winlock died.—For some years superintendent of the American "Nautical Almanac," Winlock in 1865 succeeded G. P. Bond as professor of astronomy and director of the observatory at Harvard.

June 11, 1897. Karl Remegius Fresenius died.—A student at Bonn and then assistant to Liebig, Fresenius from 1845 onwards was professor of chemistry and technology at the Agricultural Institute at Wiesbaden. He made many analytical researches, wrote standard text-books, and in 1862 founded the *Zeitschrift für analytische Chemie*.

June 12, 1885. Henry Charles Fleeming Jenkin died.—The assistant of Lord Kelvin in his important experiments on the resistance and insulation and the making of electric cables, Jenkin afterwards occupied the chairs of engineering in University College, London (1865), and in Edinburgh University (1868).

June 13, 1844. Thomas Charles Hope died.—Hope in 1799 succeeded Black as professor of chemistry in Edinburgh University. Unrivalled as a popular teacher, more than 16,000 students attended his lectures. To him we owe the demonstration that water attains its maximum density at 4° C.

June 14, 1746. Colin Maclaurin died.—Born in 1698, Maclaurin at the age of nineteen became professor of mathematics at Aberdeen. In 1725 he was appointed to the similar chair at Edinburgh. After Newton's death he was recognised as the foremost British mathematician. He died at York, his death being due to his exertions during the Rebellion of '45.

June 14, 1875. Heinrich Louis D'Arrest died.—Of Huguenot descent, D'Arrest was born and educated at Berlin. He assisted Encke, held the chair of mathematics and astronomy at Leipzig, and in 1857 became director of Copenhagen Observatory.

June 14, 1903. Karl Gegenbaur died.—Famous for his work in comparative anatomy, Gegenbaur held the chairs of anatomy at Jena and Heidelberg. His "Elements of Comparative Anatomy" appeared in 1874.
E. C. S.

Societies and Academies.

LONDON.

Royal Society, June 2.—Prof. C. S. Sherrington, president, in the chair.—Bakerian lecture by Dr. F. M. Lowry and Dr. C. P. Austin: Optical rotatory dispersion. Although no case is known in which Biot's law of inverse squares, $\alpha = k/\lambda^2$, is accurately true, the rotatory dispersion in a very large number of organic compounds can be expressed by the *simple dispersion formula*, $\alpha = k/(\lambda^2 - \lambda_0^2)$, which differs from Biot's formula only in the introduction of a "dispersion constant" λ_0^2 . This formula is a special case of the general formula $\alpha = \sum k_n/(\lambda^2 - \lambda_n^2)$ introduced by Drude as an approximation based upon the electronic theory of radiation and absorption of light. Substances which require more than one term of this equation are said to show *complex rotatory dispersion*. Tartaric acid and its esters give dispersion curves which frequently show an inflexion, a maximum, and a change of sign; they are described as cases of *anomalous rotatory dispersion*. These can be represented by two terms of Drude's equation, while the rotatory dispersion in quartz was represented by a similar equation, in which the dispersion-constant of the negative term was negligible. In order to express recent measurements it is necessary to assume finite values for both dispersion-constants and to introduce a term to express the influence of the infra-red absorptions; this can be taken as a constant. The anomalous dispersion of tartaric acid was attributed by Arndtsen in 1858 to the presence of two modifications of the acid differing in the sign of their rotations and in the magnitude of their dispersions. This view has been confirmed (1) by the proof that the complex rotatory dispersion of the acid and its derivatives can be expressed as the sum of two simple dispersions, and (2) by the discovery of certain "fixed" derivatives of tartaric acid which exhibit simple rotatory dispersion. Attention is directed to some analogies between tartaric acid and nitrocamphor, which give two isomeric compounds in solution.

Zoological Society, May 24.—Prof. E. W. MacBride, vice-president, in the chair.—Dr. C. W. Andrews: The skull of *Dinotherium giganteum* in the British Museum.—Dr. C. F. Sonntag: (1) The comparative anatomy of the tongues of the Mammalia, Families 3 and 4, Cebidæ and Hapalidæ. (2) Some points in the anatomy of the tongues of the Lemuroidea.—Prof. R. Broom: Some new genera and species of anomodont reptiles from the Karroo beds of South Africa.—R. I. Pocock: The external characters of some species of Lutrinæ (otters).

Geological Society, May 25.—Mr. R. D. Oldham, president, in the chair.—G. W. Lamplugh: The junction of Gault and Lower Greensand near Leighton Buzzard (Bedfordshire). The paper, a continuation of one by the author and the late J. F. Walker published in 1903, describes about twenty sections exhibiting the base of the Gault in excavations around Leighton Buzzard. The variable "Basement Beds" of the Gault are "condensed" deposits, falling mainly within the "zone of Ammonites mammillatus" as recognised in northern France. The evidence bears out Jukes-Browne's suggestion of the occurrence of a current-swept strait in this quarter during late Lower Cretaceous times. During the accumulation of the "Basement Beds" a shoal in this strait north of Leighton formed a reef, while the deeper water to the southward gathered a stratum of gritty glauconitic loam and clay with fossiliferous phosphatic nodules. The transitional stages are visible in the sections. The dark clays above the "Basement Beds" belong to the Lower Gault, here reduced to about half its thickness at Folkestone. They rest sharply on the

ironstone "pans" of the reef, but usually pass downward by gritty intercalations into the glauconitic loams. The incoming of the Upper Gault, with keeled ammonites, is shown in three of the sections. A band of corroded phosphatic nodules, like those of the "Junction-Bed" at Folkestone, occurs near the base of the division, and marks a long pause in the sedimentation. This band has yielded many fossils. The palæontology of the deposits is discussed, and is held to be in general agreement with that of the same succession in northern France.

Physical Society, May 27.—Sir W. H. Bragg, president, in the chair.—H. Pealing: The reflection of the X-ray spectrum of palladium from fluorspar. An examination of the odd order spectra reflected from the 100 plane of fluorspar, using palladium X-rays, has been made with the view of testing the Lewis-Langmuir theory of the motion of valency electrons in compounds. Evidence in partial confirmation of the theory has been obtained.—Sir W. H. Bragg: The intensity of X-ray reflection by diamond. The relative intensities of the reflections of monochromatic X-rays by the crystallographic planes of diamond are given. The special difficulties due to the small size of available crystals are discussed. The results lie very closely on smooth curves, indicating that if the outer electrons of the carbon atom lie at any considerable distance from the centre they must be in motion over a wide range, or for some other reason must contribute little to the reflection. The properties of the carbon atom in diamond are based on a tetrahedral form. The tetrahedra point away from any (111) plane in the case of half the atoms, and towards it in the case of the other half. Consecutive 111 planes are not exactly of the same nature, and consequently some slight second-order reflection from the tetrahedral plane might be expected. This effect, though slight, has been found.—Research Staff of the **General Electric Co., Ltd.**: A method for the micro-analysis of gases by the use of the Pirani pressure gauge. A method of analysis of gases at a pressure between 0.61 and 0.001 mm. is described, based on the characteristic vapour-pressure temperature curve of any substance. A gauge such as the Pirani gauge, which will measure the pressures of vapours, as well as of permanent gases, over the range mentioned is used.

MANCHESTER.

Literary and Philosophical Society, February 8.—Sir Henry A. Miers, president, in the chair.—C. W. Duckworth: Note on a unique set of hydrometers.—Prof. G. Unwin: Samuel Oldknow, the first manufacturer of British muslins. An account of Oldknow's records (1782-1812), including the whole process of manufacture.

Literary and Philosophical Society and the Faraday Society (Joint Meeting), February 11.—Prof. A. W. Porter, president of the Faraday Society, in the chair.—Dr. A. Ferguson: Studies in capillarity. Part i.: Some general considerations, and a discussion of the methods of measuring interfacial tensions. The importance of accurate measurements of surface tensions, in view of the development of colloid physics, is becoming increasingly manifest, and a systematic determination of capillary constants is urgently needed. In this paper the "genetic" relations of various methods for the measurement of surface tensions are discussed. A critical comparison of these shows that among the most promising methods for systematic use are those depending on the measurement of (1) large bubbles or drops, (2) the maximum pressure required to release a bubble of air from the end of a capillary tube immersed in the liquid, and

(3) the maximum pull on an anchor ring which is immersed in the liquid and slowly withdrawn. Dealing with the ascent of a liquid in a capillary tube, it is shown that where a^2 is the specific cohesion and h the height to which the liquid rises in a tube of radius r , the equation

$$2a^2 = rh(1 + rh) - 0.1288 r^2 h^2$$

is adequate for all requirements. Methods are proposed for the measurement of the surface tensions of such liquids as molten metals, and the problem of the accurate measurement of interfacial tensions is discussed.—Dr. A. Ferguson and P. E. Dowson: Studies in capillarity. Part ii.: A modification of the capillary tube method for the measurement of surface tensions. A modification of the usual method is proposed in which the meniscus is forced down to the end of the capillary immersed vertically in the liquid, and the pressure required to effect this is measured on a separate manometer. Apart from small corrections, the difference in level of the surfaces of the liquid in the gauge is equal to the heights to which the same liquid would rise in the capillary tube employed. By using a specially light liquid in the gauge this difference may therefore be magnified. But any manometer of sufficient delicacy may be used and the use of a cathetometer avoided. Thus the differential manometer or a simple sloping-tube manometer will give accurate results by ordinary naked-eye estimations. Temperature control becomes relatively simple, and the temperature of the meniscus may be estimated by means of a thermo-junction placed close to the end of the tube. Calibration of the capillary is unnecessary, for measurements are always made with the meniscus in one definite position—at the end of the tube.

DUBLIN.

Royal Dublin Society, May 24.—Dr. F. E. Hackett in the chair.—Prof. T. Johnson and Miss J. G. Gilmore: The occurrence of *Dewalquea* in the core of the bore made at Washing Bay, Co. Tyrone. This bore, made to tap a concealed coalfield if possible, had to be abandoned owing to the unexpected thickness of the bed of Lough Neagh Clay encountered (1196 ft. instead of 250 ft.), and from other causes. Plant-remains were obtained, especially at a depth of 870-930 ft., above the lithomarg; or basalt. The hellebore-like foliage of *Dewalquea* was found represented by three new species, *D. hibernica*, *D. fraxinifolia*, and *D. denticulata*, of which particulars are given. The authors restored the leaves and found peltate scales, like those of *Engelhardtia*, present. They regard *Dewalquea* as an ancient member of the Juglandaceæ. It is recorded from the Cretaceous of America and Europe, also from Belgium (Lower Eocene) and Italy (Oligocene). The plant-beds at Washing Bay are probably Upper Oligocene.—The late Prof. J. A. McClelland and J. J. McHenry: Uncharged nuclei produced in moist air by ultra-violet light and other sources. The uncharged nuclei produced in moist air by ultra-violet light were given an electric charge through the agency of uranium. Their number and size could then be readily found under varying conditions. It is concluded that they are minute drops of water, and that they probably owe their formation to the production of hydrogen peroxide. The nuclei produced by heating glass were also studied. Moderate heating caused a temporary evolution of nuclei, attributed to surface impurities absorbed from the atmosphere. Strong heating caused a continuous evolution, attributed to disintegration of the glass. Similar effects were observed with metals.—H. G. Becker: A simple apparatus for observing the rate of reaction between gases and liquids, and the determination thereby of

the effect of stirring on the rate of solution of oxygen in water. The principle is similar to that already described elsewhere by Dr. Adeney, and consists in enclosing the liquid with a known volume of gas in a space connected to a manometer and observing the change of pressure due to absorption. Experiments made on the effect of stirring on the rate of absorption of oxygen from the air showed that the rate of solution is enormously increased even by gentle stirring of the liquid, and with more vigorous stirring tends to the maximum value already found by a different method. The experiments form a link between conditions occurring in Nature and those obtaining in the method previously described by Adeney and Becker in the society's Proceedings.

PARIS.

Academy of Sciences, May 17.—M. Georges Lemoine in the chair.—A. Denjoy: The calculation of the coefficients of any convergent trigonometrical series the sum of which is given.—G. Dumas: The tracing contours.—M. Bratu: Series the general term of which tends towards zero.—G. Valiron: Integral functions of finite order.—J. Le Roux: The theory of relativity and the secular movement of the perihelion of Mercury.—B. Lyot: The aurora borealis of May 14-15, 1921, and the simultaneous magnetic phenomena. Intense magnetic disturbances commenced twenty hours before the passage of an important group of sun-spots across the central meridian, and this passage was followed by a remarkable aurora borealis.—J. Guillaume: Observation of Pons-Wincke's comet (1921b) made with the equatorial of the Observatory of Lyons. Position on May 10 is given. The comet is roughly circular, with a faint central condensation. Magnitude about 11.5.—G. Vavon and J. Detrie: The transformation of phenol into cyclohexanol. A study of the addition of hydrogen to phenol, with platinum as the catalyst. It is shown that cyclohexanone is formed as an intermediate product.—T. Martinet and P. Coisset: The action of chloraloxim on the aromatic amines; the synthesis of isatins. When the oxime of chloral condenses with aromatic amines the chlorine, and not the aldehydic oxygen, reacts. The product of the condensation treated with hot sulphuric acid yields isatin. Starting with various substituted amines, the corresponding substituted isatins can be readily prepared.—M. Lespieau: The action of 2:3-dibromopropylene upon isopropylmagnesium bromide.—M. Delépine, Fleury, and Ville: Researches on $\beta\beta$ -dichloroethyl sulphide. The material prepared from ethylene and chlorides of sulphur contains various impurities. These give some sulphur as sulphuric acid on oxidation, and only from 60 to 70 per cent. of the chlorine is removed by hydrolysis with water at 80° C. The pure material gives no sulphuric acid on oxidation, and the whole of the chlorine is removed by hydrolysis.—R. Fosse and G. Laude: Syntheses of cyanic acid and of urea by the oxidation of ketones, acids, and amines in the presence of ammonia.—G. Arambourg: The ichthyological fauna of the Sahelian of the Oran region.—A. Magnan: The ratio of the wing surface to the caudal surface in birds.—F. Ladreyt: Histological and histochemical researches on the pigmentary atrophy of the liver.—A. Weber: Researches on the toxicity of the internal medium of Batrachians towards their eggs.—V. Galippe and Mme. G. Souffland: Researches on the presence in meteorites, hard stones, minerals, quartz, granite, basalt, volcanic ashes, and lava of "organites" susceptible of reviving, and on their resistance to high temperatures.—E. Chatton and R. Courrier: A trypanosome of the bat,

Vesperugo pipistrellus. Hypothesis relative to the etiology of endemic goitre. In Lower Alsace about 10 per cent. of these bats are infected with a trypanosome resembling *Schistotrypanum Cruzi*, but smaller. The suggestion is made that this organism may possibly be the cause of endemic goitre.—A. Sartory and P. Bailly: The agglutinating power of thorium sulphate on the spores of *Aspergillus fumigatus*. An emulsion of the spores was clarified by solutions of thorium sulphate, the maximum effect being produced at concentrations between 0.001 and 0.0005. Concentrated solutions do not agglutinate the spores.—G. Marinesco and E. Craciun: Lesions of the nervous system in exanthematic typhus and their relations with neuritis.—C. Lebailly: The preservation of the aphthous virus by cold.

ROME.

Reale Accademia nazionale dei Lincei, March 6.—V. Volterra, vice-president, in the chair.—Paper by a fellow:—Col. G. A. Crocco: Utilisable energy of the wind. The variability of winds, coupled with the fact that the energy varies as the cube of the velocity, has hitherto prevented this source of energy from being put to much practical use. Referring to accumulators, the author considers that recent researches on thermal accumulators offer an opportunity for storing this energy in a form adapted for heating purposes at a moderate cost. Regarding the installation of generators, the author suggests the construction of barrages fixed in such localities as a gap between mountains, where the prevailing wind is more or less constant in direction. It is also pointed out that after passing an obstacle the wind soon almost recovers its original velocity, so that by fixing several installations one behind the other it is possible to utilise the energy contained in a considerable height of air.—Papers communicated through fellows:—M. Picone: Potential of a double surface layer. This extract from a letter to Prof. Levi Civita deals with a proof that the potential of a magnetic shell has finite, definite value of the surface of the shell except at a singular point.—Prof. A. Lo Surdo: A spectroscope with catoptric grating. This arrangement consists of a number of reflecting laminae of equal thickness overlapping each other by the same amount, their edges thus resembling a flight of steps, by reflection from which a diffraction spectrum is formed of a beam of light incident normally to the laminae.—Prof. G. Magrini: Preliminary notice of the Italian expedition for exploring the seas of the Levant. This expedition formed the part assigned to Italy in carrying out the programme arranged in 1919 under the auspices of the International Commission for the Scientific Exploration of the Mediterranean. For this purpose the *Tremitti*, of 500 tons, was equipped, the fundamental problem to be investigated being the distribution and cause of the currents in the Bosphorus and the Dardanelles.—Dr. C. Perrier: The true nature of Rosasite, ii.—G. Stefanini: Geology of Cyrenaica: i., Eocene strata. An examination of literature and materials, considered especially in relation to the previous researches of Prof. J. W. Gregory (*Quart. Journ. Geol. Soc.*, vol. lxvii., 1911).—A notice of the life and work of the late Prof. P. A. Saccardo, read on February 6 by Prof. O. Mattiolo, occupies twelve pages at the end of the number of the *Atti* containing the previous papers.

March 20.—F. D'Ovidio, president, in the chair.—Papers by fellows:—F. Severi: Theory of simple integrals of the first species belonging to an algebraic surface, i.—C. De Stefani: Ligurian fossil sponges, v. Mulino di San Giovanni, Biscazza, Casa Buzzano,

Caffarella.—G. **Pellizzari**: Transition from guanidine to cyanoamide, and from diguanide to dicyanodiamide.—Papers communicated through fellows:—C. **Burali-Forti**: Real numbers and magnitudes, i.—A. **Artom**: Apparatus for directional radio-mechanics. The currents from two receivers at right angles (or at any other angle) operate on two separate galvanometer coils, fixed at a similar angle to the receivers, in such a way that the deviation of the galvanometer needle depends on the difference of intensity of the currents generated in the coils, and its position thus indicates the direction from which the radio-telegraphic waves are received. The apparatus admits of several modifications.—The present number of the *Atti* contains obituary notices read at the preceding meeting (March 6) by Prof. R. Pirota on the late Prof. G. Cuboni, and by Prof. Cerulli on the late Prof. Giovanni Celoria.

NEW SOUTH WALES.

Linnean Society, March 30.—Mr. J. J. Fletcher, president, in the chair.—J. J. **Fletcher**: Presidential address. The work of the society during the past year was reviewed and reference made to recent important events of scientific interest, including the establishment of the Australian National Research Council and of the Commonwealth Institute of Science and Industry; the first Pan-Pacific Science Conference; and the resumption of regular meetings of the Australasian Association for the Advancement of Science. The last part of the address referred to the Macleay Museum of the Sydney University, founded by Sir William Macleay. The history of the formation of the Macleay collections was related. In conclusion, the University of Sydney, which is joint trustee with the society for the museum, was criticised for neglect of its trust. Changes made in the building have caused the disruption of the Macleay collections, so that they no longer form an exposition of the fauna of Australia.—Mr. G. A. Waterhouse, elected president for the year 1921–22, then took the chair.—E. W. **Ferguson**: Revision of the *Amycterides* (Coleoptera). Part vi., *Acantholophus*. A detailed historical account is given, together with a critical revision of the genus and of the species referred to it. The genus is divided into two sections; in the first, the head is separated from the rostrum by the intercrystal ridge, the prothorax is produced above, and ocular lobes are present; in the second, the head is separated from the rostrum by a transverse impression, the prothorax is subtruncate above, and ocular lobes are absent. Fifty-nine species, ten of them new, are referred to the genus.—Dr. R. **Greig-Smith**: The high-temperature organism of fermenting tan bark. Part i. The fermentation of spent wattle-bark in the corrosion of white lead is caused by a stout, rod-shaped bacterium having a terminal spore. Its optimum laboratory temperature is 60° C.; in the corroding stacks the temperature may rise to 80°. Raw spent wattle-bark requires preliminary treatment. As conditions which oxidise tannin substances favour the fermentation of the raw bark, it is probable that the residual tannins inhibit fermentation.

Books Received.

Introduction to the Theory of Fourier's Series and Integrals and the Mathematical Theory of the Conduction of Heat. By Prof. H. S. Carslaw. Second edition, completely revised. Vol. i.: *Fourier's Series and Integrals*. Pp. xi+323. (London: Macmillan and Co., Ltd.) 30s. net.

The Fine Cotton Spinners' and Doublers' Association. No. 2693, VOL. 107]

tion, Ltd., Manchester: Experimental Department. A Method for Measuring the Length of Cotton Hairs. By Dr. W. Lawrence Balls. Pp. 62. (London: Macmillan and Co., Ltd.) 3s. 6d. net.

The Purple Sapphire and other Posthumous Papers. Selected from the Unofficial Records of the University of Cosmopoli by Christopher Blayre. Pp. x+210. (London: P. Allan and Co.) 7s. 6d. net.

The Scientific Papers of the Hon. Henry Cavendish, F.R.S. Vol. i.: *The Electrical Researches*. Edited by Prof. J. Clerk Maxwell, revised by Sir Joseph Larmor. Pp. xxviii+452. Vol. ii.: *Chemical and Dynamical*. Edited by Sir Edward Thorpe. Pp. xii+496+vi plates. (Cambridge: At the University Press.) 6l. net the 2 vols.

The Salvaging of Civilization. By H. G. Wells. Pp. v+202. (London: Cassell and Co., Ltd.) 7s. 6d. net.

Festschrift der Kaiser Wilhelm Gesellschaft zur Förderung der Wissenschaften zu ihrem Zehnjährigen Jubiläum Dargebracht von ihren Instituten. Pp. iv+282. (Berlin: J. Springer.) 100 marks.

The Psychology of Day-Dreams. By Dr. J. Varendonck. Pp. 367. (London: G. Allen and Unwin, Ltd.; New York: The Macmillan Co.) 18s. net.

The Case-Hardening of Steel. By Harry Brearley. Second edition. Pp. xi+207. (London: Longmans, Green and Co.) 16s. net.

Factory Chemistry: Preparatory to Courses in Metallurgy and Metallography. By Wm. H. Hawkes. Pp. vii+59. (London: Longmans, Green and Co.) 4s. 6d. net.

The Correspondence of Commerce. By A. Risdon Palmer. (Pitman's Commerce Series.) Pp. xii+159. (London: Sir I. Pitman and Sons, Ltd.) 6s. net.

Ameboid Movement. By Prof. Asa A. Schaeffer. Pp. vii+156. (Princeton: University Press; London: Oxford University Press.) 10s. 6d. net.

Medical Research Council and Department of Scientific and Industrial Research: Reports of the Industrial Fatigue Research Board. No. 13: *A Statistical Study of Labour Turnover in Munition and other Factories*. (General Series, No. 4.) Pp. 92. (London: H.M. Stationery Office.) 3s. net.

Einführung in die Theoretische Physik mit besonderer Berücksichtigung ihrer Modernen Probleme. By Prof. Arthur Haas. Zweiter Band. Erste und Zweite auflage. Pp. vi+286. (Berlin and Leipzig: Walter de Gruyter and Co.) 12s. 6d.

Vorlesungen über die Theorie der Warmestrahlung. By Prof. Max Planck. Vierte auflage. Pp. xi+224. (Leipzig: J. A. Barth.) 36 marks.

Elemente der Theoretischen Physik. By Prof. C. Christiansen and Prof. Johs. J. C. Muller. Vierte auflage. Pp. xxiv+680. (Leipzig: J. A. Barth.) 80 marks.

Moderne Magnetik. By Felix Auerbach. Pp. viii+304. (Leipzig: J. A. Barth.) 48 marks.

Stanford University Publications: University Series. Mathematics and Astronomy, vol. i. No. 1: *Primitive Groups*. By Prof. W. A. Manning. Part i. Pp. 108. (California: Stanford University.) 1.25 dollars.

Die Theorie der Allotropie. By Prof. A. Smits. Pp. xvi+500. (Leipzig: J. A. Barth.) 100 marks.

Etudes élémentaires de Météorologie Pratique. By Albert Baldit. Pp. ix+347. (Paris: Gauthier-Villars et Cie.) 15 francs net.

La forme et le Mouvement. Essai de Dynamique de la Vie. By Georges Bohn. Pp. 175. (Paris: E. Flammarion.) 4.50 francs net.

Petrographic Methods and Calculations, with some Examples of Results Achieved. By Dr. Arthur Holmes. Pp. xix+515+iv plates. (London: T. Murby and Co.) 31s. 6d. net.

Diary of Societies.

THURSDAY, JUNE 9.

INSTITUTE OF MINING ENGINEERS (at Geological Society), at 11.—Third Report of the Committee on "The Control of Atmospheric Conditions in Hot and Deep Mines."—J. P. Rees: Observations of Temperature and Moisture in Deep Coal-mine.—Prof. H. Briggs: Characteristics of Outbursts of Gas in Mines.—H. O. Harrison: The Use and Distribution of Shale-dust in Mines. The following papers, which have already appeared in the Transactions, will be discussed:—A. E. Beet and A. E. Findley: The Better Utilisation of Coking Slack.—J. I. Graham: The Normal Occurrence of Carbon Monoxide in Coal-mine.—T. L. Galloway: An Improved Method of Determining the Relative Directions of Two Reference-lines or Bases for Mining Surveys.—E. Bury, W. Broadbridge, and A. Hutchinson: Froth Flotation as Applied to the Washing of Industrial Coal.

INSTITUTE OF PATHOLOGY AND RESEARCH (at St. Mary's Hospital), at 4.30.—Dr. H. Head: Release of Function in the Nervous System.

ROYAL SOCIETY, at 4.30.—Prof. C. S. Sherrington: Break-shock Reflexes and "Supramaximal" Contraction-response of Mammalian Nerve-muscle to Single-shock Stimuli.—R. J. Ludford and J. B. Gatenby: Dietyokinesis in Germ Cells, or the Distribution of the Golgi Apparatus during Cell Division.—Dr. F. W. Edridge-Green: The Effect of Red Fatigue on the White Equation.—E. Ponder: A Method for Investigating the Hæmolytic Activity of Chemical Substances.—W. H. Pearsall: The Development of Vegetation in the English Lakes, considered in Relation to the General Evolution of Glacial Lakes and Rock Basins.

LONDON MATHEMATICAL SOCIETY (at Royal Astronomical Society), at 5.—M. J. Conran: Curvature and Torsion in Elliptic Space.—J. L. S. Hatton: The Inscribed, Circumscribed, and Self-conjugate Polygons of Two Cones.—M. J. M. Hill: The Differential Equations of the First Order derivable from an Irreducible Algebraic Primitive.—F. S. Macaulay: Note on the Resultant of a Number of Polynomials of the Same Degree.—Lt.-Col. A. Cunningham: The Congruence $2^{p-1} \equiv 0 \pmod{p^2}$.—T. Stuart: Diophantine Equations.—G. H. Hardy: A Chapter from Ramanujan's Note-book.

ROYAL COLLEGE OF PHYSICIANS OF LONDON, at 5.—Dr. F. L. Golla: The Objective Study of Neurosis (Croonian Lecture).

ROYAL INSTITUTE OF BRITISH ARCHITECTS, at 5.—H. S. Goodhart-Rendel: Some Fashions in Architecture.

OPTICAL SOCIETY (at Imperial College of Science), at 7.30.—H. Lee: Achromatism.—W. L. Custance: Demonstration of the Société Genevoise Universal Measuring Machine.

PAINT AND VARNISH SOCIETY (at St. Bride's Institute), at 7.30.—C. A. Klein: The Need for Science and Common Sense in the Practical Testing of Paints.

FRIDAY, JUNE 10.

ROYAL SOCIETY OF ARTS (Indian Section), at 4.30.—Sir George Curtis: The Development of Bombay.

ROYAL ASTRONOMICAL SOCIETY, at 5.—Rev. J. G. Hagen: The Origin of Temporary Stars and of Planetary Nebulæ.—S. D. Tscherny: Results of Observations of Sun-spots and Faculæ, 1916-1920, made at the Observatory, Rostow-on-Don.—A. A. Rambaut: Parallaxes of 516 Stars, from Photographs taken at the Radcliffe Observatory, Oxford.—E. A. Milne: Radiative Equilibrium: The Effect of a Strong Absorption Line.—W. M. Smart: Proper Motions of Stars in the Pleiades.—Rev. A. L. Cortie: The Sun-spot Group and the Magnetic Disturbances, 1921 May 8-21.—F. Sargent: Remarkable Spot on the South Equatorial Belt of Jupiter.—Rev. T. E. R. Phillips: Micrometrical Measures of Double Stars.—Royal Observatory, Greenwich: Note on the Measurement of Groups of Sun-spots.—Royal Observatory, Greenwich: Observations of Comets *a* 1921 (Reid); *b* 1921 (Pons-Winnecke); *c* 1921 (Dubiago).

PHYSICAL SOCIETY OF LONDON (at Imperial College of Science), at 5.—Sir Ernest Rutherford: The Stability of Atoms (Lecture).

ROYAL INSTITUTION OF GREAT BRITAIN, at 9.—Dr. A. G. Webster: Absolute Measurements of Sound.

TUESDAY, JUNE 14.

ROYAL COLLEGE OF PHYSICIANS OF LONDON, at 5.—Dr. F. L. Golla: The Objective Study of Neurosis (Croonian Lecture).

WEDNESDAY, JUNE 15.

ROYAL METEOROLOGICAL SOCIETY, at 5.—G. M. B. Dobson: Causes of Errors in Forecasting Pressure Gradients and Wind.—R. F. Granger: The Physical Structure of Cloud-Form in the Lower Atmosphere.—N. A. Comissopulos and J. Wadsworth: Variability of Temperature over North America and Europe during the Ten Years, 1900-1909.

ROYAL MICROSCOPICAL SOCIETY, at 8.—Prof. F. J. Cheshire: A Selection from the Abbe Letters.—Dr. C. F. Sonntag: Some Points in the Histology of the Three-Toed Sloth.—F. Chapman: Ostracoda, Foraminifera, and Some Organisms related to Calciisphæra, from the Devonian of Germany.—G. T. Harris: Note on Mounting in Glycerine Jelly.

THURSDAY, JUNE 16.

INSTITUTE OF PATHOLOGY AND RESEARCH (at St. Mary's Hospital), at 4.30.—Prof. W. Bulloch: Use and Abuse of Scientific Medical Literature.

ROYAL SOCIETY, at 4.30.—*Probable Papers*.—Prof. H. B. Dixon, Dr. C. Campbell, and Dr. A. Parker: The Velocity of Sound in Gases at High Temperatures, and the Ratio of the Specific Heats.—Prof. J. R. Partington: The Ratio of the Specific Heats of Air and of Carbon Dioxide.—Dr. A. B. Wood and Dr. F. B. Young: "Light Body" Hydrophones and the Directional Properties of Microphones.—Dr. A. B. Wood and Dr. F. B. Young: The Acous-

tic Disturbances produced by Small Bodies in Plane Waves transmitted through Water, with Special Reference to the Single Plate Direction Finder.—M. A. Giblett: Some Problems connected with Evaporation from Large Expanses of Water.—F. C. Toy: The Photographic Efficiency of Heterogeneous Light.

LINNEAN SOCIETY, at 5.

ROYAL COLLEGE OF PHYSICIANS OF LONDON, at 5.—Dr. F. L. Golla:

The Objective Study of Neurosis (Croonian Lecture).

CHEMICAL SOCIETY (at Institution of Mechanical Engineers), at 8.—Prof. B. Moore: The Natural Photo-synthetic Processes on Land and in Sea and Air, and their Relation to the Origin and Preservation of Life upon the Earth (Hugo Müller Lecture).

RÖNTGEN SOCIETY (at University College), at 8.15.

ROYAL PHOTOGRAPHIC SOCIETY OF GREAT BRITAIN, at 8.15.—Lecture.

ROYAL SOCIETY OF MEDICINE (General Meeting), at 8.30.—Sir Thomas Horder, Dr. A. F. Hurst, Sir Berkeley Moynihan, Sir Humphry Rolleston, and Others: The Problem of the Private Clinic System in Great Britain.

FRIDAY, JUNE 17.

ROYAL ASTRONOMICAL SOCIETY, Geophysical Discussion, at 5.—Changes of Level in the British Isles, opened by H. L. P. Jolly, followed by Col. Sir C. F. Close and O. G. S. Crawford. Chairman: Col. Sir G. Lenox-Clyneham.

ROYAL PHOTOGRAPHIC SOCIETY OF GREAT BRITAIN, at 8.—J. C. Warburg: Foregrounds.

WEST LONDON MEDICO-CHIRURGICAL SOCIETY (at Kensington Town Hall), at 8.15.—Dr. C. Addison: The Part of the State in the Prevention of Disease (Cavendish Lecture).

ROYAL INSTITUTION OF GREAT BRITAIN, at 9.—Sir J. J. Thomson: Chemical Combination and the Structure of the Molecule.

CONTENTS.

PAGE

Co-operative Indexing of Periodical Literature . . .	449
Piezo-chemistry. By Sir T. E. Thorpe, C.B., F.R.S.	450
Social Degeneration. By The Very Rev. Dr. W. R. Inge	452
X-rays in Medical Practice	454
Our Bookshelf	455
Letters to the Editor:—	
Phenomena of "Intelligence" in the Protozoa.—	
Edward Heron-Allen, F.R.S.	456
An Algebraical Identity $4X = Y^2 - 37Z^2$.—Prof. G. B. Mathews, F.R.S.	456
Atmospheric Refraction. (<i>Illustrated</i>).—A. Mallock, F.R.S.	456
Young's Interference Experiment and the Spectrometer.—Prof. John K. Robertson	457
The Reparation Act and Scientific Research.—The Hon H. Onslow	457
British Laboratory Ware and Chemicals.—Prof. J. R. Partington and C. L. Bryant	457
Science and Technology in Palestine.—Daisy L. Adler	458
Foreign Scientific Literature.—Hugh Richardson	458
Flint Implements in the Cromer Forest Bed.—J. Reid Moir	458
The Physical Status of "Space."—L. C. W. Bonacina	459
The Colours of Primroses.—Frank H. Perrycoste	459
Gold-coloured Teeth of Sheep.—W. J. Lewis Abbott	459
Prehistoric Art in Caves and Rock-shelters. (<i>Illustrated</i>). By M. C. Burkitt	460
Dark Nebulæ. (<i>Illustrated</i>). By Dr. A. C. D. Crommelin	464
Obituary:—	
Prof. E. B. Rosa	465
Notes	466
Our Astronomical Column:—	
Comets	471
Nova Cygni III. (1920)	471
Collision of Star and Nebula	471
The Edinburgh Meeting of the British Association	472
The Royal Observatory, Greenwich. By A. C. D. C.	472
The Chinese Earthquake of December 16, 1920. By Dr. C. Davison	473
Stereochemistry. By J. B. C.	474
University and Educational Intelligence	474
Calendar of Scientific Pioneers	476
Societies and Academies	476
Books Received	479
Diary of Societies	480



THURSDAY, JUNE 16, 1921.

Editorial and Publishing Offices:
 MACMILLAN & CO., LTD.,
 ST. MARTIN'S STREET, LONDON, W.C.2.

Advertisements and business letters should be
 addressed to the Publishers.

Editorial communications to the Editor.

Telegraphic Address: PHUSIS, LONDON.
 Telephone Number: GERRARD 8830.

The Safeguarding of Research.

THE fact that the Bill for the Safeguarding of Industries has passed its second reading in the House of Commons has directed renewed attention to the manner in which its provisions will react on the prosecution of scientific research in this country. It will be remembered that the supply of scientific apparatus and chemicals was the subject of a discussion in our correspondence columns about a year ago, and we have received many further letters showing the importance of the question. In NATURE for June 9, p. 457, attention was directed to the formation of a committee of the British Science Guild to report upon the matter. We hope that all our readers who have knowledge of facts bearing on the problem, or suggestions to offer, will give this committee the benefit of their views.

Our concern here is for the advancement of scientific discovery, which is the only real basis for the safeguarding of all industrial development. For this reason we think that the point of view of the user and consumer, more particularly that of the worker in science, should receive chief attention. Certain documents that have been issued suggest rather that the interest of the manufacturer is to be the primary consideration. Although British men of science are undoubtedly desirous of supporting the industries of their country, even if they have to pay a somewhat higher price for the goods, it is clearly their duty to see to it that the main object of their work does not suffer thereby. Great improvements have been made in British laboratory ware, but there are still difficulties in obtaining a sufficient supply

of apparatus and chemicals on which reliance can be placed.

Users would be saved no small waste of time and receive encouragement in their purchase of British goods if they knew how far they could really depend on these being what they profess to be. Prof. Cohen's experience with propyl alcohol, as given in NATURE for March 3, p. 12, is to the point here. It is not meant to imply that even the best German chemicals are beyond reproach, although some workers appear to be under the impression that if they use Kahlbaum's preparations no further control of purity is needed. Excellent glass and porcelain is certainly being made here, and our optical and electrical apparatus is second to none. But the price is often very high, and there are still uncertainties in the uniformity of the supply. There appear to be no difficulties in the manufacture of articles for domestic use, and if manufacturers do not find it worth while to put good workers on to scientific apparatus, which has a comparatively small sale, why do they not give it up? The suggestion has been made that purchasers should return any unstamped glass ware, while payment might be refused for goods the origin of which is not stated.

The problem is to discover how best to enable manufacturers to perfect their processes and to protect them from loss while this is being done. It is superfluous to say that the great need is for more and more research, and any legislation that tends to remove the opportunity for this is to be deprecated. The manufacturers appear to dread the competition of countries of which the currency is depreciated. But it is to be noted that the Bill applies to Allied and neutral countries as well as to Germany. Moreover, as was evident in the discussion in the House of Commons, the opinion of many competent speakers is that such competition is exaggerated, and that in any case a depreciated currency is of no real advantage in the world markets, and will continue until normal trade relations are restored. The bankers' manifesto points out that the only satisfactory way of dealing with the situation is to allow trade complete freedom to develop on its own initiative. Artificial attempts to remedy conditions that can right themselves only by the greatest expansion of trade in all directions delay any real solution. This is very far from saying that nothing is to be done at all. The most effective way of avoiding dumping is surely to aim at raising depreciated money value, rather than to restrict trade by import duties.

So far as makers of scientific apparatus are

concerned, we believe they are not satisfied with import duties, and want prohibition of import for a time, with permits to import in special cases. Many consumers have stated their preference for a system of subsidies to enable prices to be low enough to compete with foreign goods. Such a scheme naturally offers difficulties, and there would need to be assurance that efforts at improvement are being made. There seems to be no reasonable objection to the price being made as nearly as possible equal to that of the foreign article, so that the competition should become one of quality. The Bill, however, will probably be passed, although it may still be possible to insert provisions to enable free import to recognised scientific institutions. Such permits must be of a general character, not requiring renewal, and not demanding the intervention of the Customs or other Government Department. No special licences for individual cases would be satisfactory.

How obstructive to scientific progress the Customs regulations may be is shown by letters that have appeared in these columns. The question of books is a very serious one. Incidentally, reference may be made to the increasing difficulty of publication of scientific papers, which seems to be greater in England than in other countries. But here again what is wanted is a general fall in prices, and this can be brought about only by a return to normal trade relations throughout the world.

Much stress was laid by certain speakers in the House of Commons on the necessity of our industries as a national insurance in case of future war. The only remark that need be made in this place is that the most important matter is to keep abreast of scientific work in other countries. Restriction of research is likely to do more harm than the more or less ineffective artificial protection of a few industries would do good. It is to be hoped, therefore, that institutions in which such scientific research is carried on will be placed beyond the effect of the new restrictions on import.

Steam and Thermodynamic Theory.

Properties of Steam and Thermodynamic Theory of Turbines. By Prof. H. L. Callendar. Pp. xi + 531. (London: Edward Arnold, 1920.) 40s. net.

IN this substantial volume Prof. Callendar has set his seal to the experimental and theoretical investigations of the properties of steam on

which he has been engaged for many years. By these investigations, which have done much to advance technical thermodynamics, Prof. Callendar has made the engineering world his debtor. It is twenty-one years since he first published, in the Proceedings of the Royal Society for June, 1900, his paper on "the thermodynamical properties of gases and vapours as deduced from a modified form of the Joule-Thomson equation, with special reference to the properties of steam."

With the publication of the book now under review Prof. Callendar's theory comes of age. The book leads up to, and includes, his steam tables, which were issued separately five or six years ago and are accepted as the standard tables, at least by English engineers. Here the author describes, much more fully than before, the basis of the tabular work, discusses its agreement with the latest results of observation, and replies to objections that have been taken to his method on the part of some American writers. Into this controversial matter there is no need to enter here: the replies will have answered their purpose if they succeed in removing misconceptions regarding the scope and character of Prof. Callendar's fundamental work, which, indeed, his own earlier papers can scarcely be said to have presented in a form that made its meaning very clear or its importance obvious.

Perhaps for that reason engineers were slow to appreciate the practical bearing of Prof. Callendar's treatment of the properties of steam. The first of them to do so was Prof. Mollier, of Dresden, himself distinguished for original contributions to technical thermodynamics, who in 1906 published a set of tables and diagrams for steam based on the Callendar characteristic equation. Shortly afterwards the methods of Prof. Callendar and the tables and diagrams of Prof. Mollier were brought to the notice of English engineers by the present writer in the third edition of his book on "The Steam-Engine and other Heat-Engines."

Prof. Callendar's own tables, published in 1915, embody the results of a more complete application of his methods, and make use, in some particulars, of later data. They give all the necessary figures for properties of steam throughout the range of temperature and pressure which is usual in the practice of steam engineering. It is the essence of Prof. Callendar's method to secure results which will be thermodynamically consistent with one another, and will also agree with the results of experiment within a limited but sufficient range. His characteristic equation makes no pretension to be applicable outside that range.

In this respect it differs from characteristic equations such as those of Van der Waals or Clausius. But within the range of its application it gives results the agreement of which with the results of direct observation is as close as the agreement of one set of observations with another.

Prof. Callendar treats steam as a gas the deviations of which from perfection may be expressed by writing the characteristic equation in the form

$$V = RT/P - c + b,$$

where RT/P is the ideal volume of a perfect gas, b is the "co-volume," or volume occupied by the molecules—a volume which is not reducible by lowering the temperature—and c is what he calls the "coaggregation volume," which is the volume lost by the interlinking or pairing of molecules. He treats c as a function of the temperature only, within the range of temperature and density to which the equation applies, making c vary as $1/T^n$. He makes the further assumption that when the pressure is indefinitely reduced the specific heat of the gas is not altered by changes of temperature within that range. These assumptions not only accord with the results of experiment; they also have the great practical advantage of yielding expressions that are easily integrable for all the properties of steam with which the engineer is concerned, such as the total heat, the internal energy, the entropy, the specific heat, the Joule-Thomson cooling effect, and the thermodynamic potentials of Willard Gibbs. Prof. Callendar shows that, by help of his equation and of the assumption which has been stated, expressions for all these quantities are readily obtained by applying the usual thermodynamic relations, and, being so derived, the resulting numerical values, which he calculates for his tables, are necessarily consistent amongst themselves. It was the absence of mutual consistency that was perhaps the gravest defect in earlier tables of the properties of steam.

The range through which the Callendar characteristic equation is applicable may conveniently be described as the range through which the Amagat isothermals (of PV and P) are sensibly straight lines. The slope of these lines depends on the values of the quantities b and c in the characteristic equation: it is, in fact, equal to $b - c$. But to determine the constants of the equation Prof. Callendar relies mainly on experiments of the porous-plug type, which measure the cooling effect produced by forcing the gas through a constricted orifice. In his own experiments of this kind he employed an ingenious differential device which, with his platinum thermometers, went far to eliminate sources of error that affected the somewhat

discordant results obtained by other observers. When a gas passes a throttling orifice of any kind, under conditions which prevent loss or gain of heat by conduction, there is one function of its state that undergoes no change, namely, the function which Willard Gibbs represented by the symbol χ . This function is equal to the internal energy plus the thermal equivalent of the product PV . It is now usually called the "total heat"—a name first applied to it by Prof. Callendar himself. Its value in technical thermodynamics was emphasised by Prof. Mollier, who introduced charts exhibiting the total heat in relation to other functions of the state, notably the entropy. The "heat-drop," or loss of total heat which the working fluid undergoes in passing through a turbine or engine of any type, is the basic quantity in all calculations of thermodynamic performance. It is equally useful as a means of analysing the reversed thermal cycle that is gone through by a refrigerating machine, for which purpose tables or charts are needed of the total heat of such working substances as carbonic acid and ammonia.

Besides his detailed tables of all the properties of steam, saturated or superheated, within the usual working range, Prof. Callendar gives in this volume an empirical table of the properties of saturated steam up to the critical point, to "serve as a guide for future work." In the extended table the critical temperature is taken as 374°C ., in accordance with the results of Traube and Teichner, and the latent heat is calculated by a formula of the Thiesen type, which makes it vanish at the critical point. The critical volume becomes 3.25 c.c. per gram. The critical state lies, of course, far outside the region within which Prof. Callendar's characteristic equation is applicable. He deals with it in a separate chapter, which includes an interesting discussion of recent experiments on carbonic acid by Jenkin and Pye.

Another section of the book deals with the theory of flow through nozzles and of the steam turbine. In this field also Prof. Callendar's work has been of fundamental importance by showing that the conditions of adiabatic flow are not, in general, equilibrium conditions, but involve complications due to supersaturation. By taking account of the effects of supersaturation he has brought the theory of steam-jets into harmony with the results of observation, removing what had been a puzzling discrepancy and explaining why it is that the measured discharge from a nozzle is actually greater than the limit which, according to the older theory, would be found even under frictionless conditions. The same

considerations are here applied to the analysis of what occurs in the steam turbine as a whole.

The book is completed by three appendices; the first is on general thermodynamic relations, and the second is on the use of a steam diagram in which the co-ordinates are the total heat and the logarithm of the pressure. The third appendix gives the steam tables in the same form as that in which they were separately presented in his earlier publication.

It is not a book for beginners: it will be intelligible only to those who have a working knowledge of general thermodynamics and are fairly familiar with the use of partial differential coefficients. But engineers and physicists who have this equipment will find it a valuable work of reference. They will welcome so detailed a statement of original views and methods from one whom they gratefully recognise as a leader and a pioneer. Prof. Callendar writes with the authority of an investigator whose knowledge of steam and its properties is probably unique.

J. A. EWING.

Ore Deposits of Utah.

The Ore Deposits of Utah. By B. S. Butler, G. F. Loughlin, V. C. Heikes, and Others. (U.S. Geol. Surv. Professional Paper 111.) Pp. 672+lvii plates. (Washington, D.C.: Government Printing Office, 1920.) 1½ dollars.

THE series of monographs in preparation by the Geological Survey of the United States to summarise existing knowledge of the ore deposits of the separate American States will render readily available much valuable information now dispersed through a voluminous and scattered literature. The first of the series was on New Mexico (1910). The second deals with Utah, an area of special interest as regards both its geological structure and the variety of its ore deposits. The study of Utah has introduced many new conceptions into structural geology; some of them, like that of the laccolite, a term introduced for the Henry Mountains by Gilbert, have been fully confirmed; others, such as the support to antecedent rivers by the oft-quoted case of the Green River, have been set aside by fuller knowledge of the facts, or, like the igneous sequences proposed by Dutton and Spurr, are dismissed as too uncertain.

Utah has given exceptionally clear evidence of the importance of block faulting in determining the existing relief, and of the cause of such faulting by subsidence after long periods of igneous activity and earth movement. The views of le Conte and Suess, based on the earlier studies of

Utah, are fully justified by the latest contributions to its geology. The tectonic history of the region presents a significant coincidence with that of Africa in the importance of east-to-west folds in the late Cretaceous, and of subsequent north-to-south faults that may be even still in progress.

The economic geology of Utah is especially instructive on account of the remarkable variety of its ore deposits. Some, such as the silver sandstones, are well known owing to the controversy as to the origin of the ores; the authors of this survey adopt Lindgren's conclusion that they were sedimentary grains concentrated by hot water in consequence of the igneous intrusions. Probably the most valuable general conclusion in the volume (pp. 196-201, and the instructive diagram, Fig. 31) is that the quantity of the ore deposits beside masses of intrusive igneous rock depends on the lowering of the surface by denudation. This principle had been previously used to explain the contrast between the gold veins in the adjacent fields of Bendigo and Castlemain in Victoria, and also the fact that the ores beside the granites of Burma are richer beside narrow than beside the wider outcrops. It receives its fullest and most authoritative expression in this volume. The clearness of the diagrammatic figures of the ore bodies and tectonic structures is an especially notable feature of this important and well-executed monograph.

Medical Science and Practice.

- (1) *Obstetrics: Normal and Operative.* By Prof. G. P. Shears. Third edition, revised by Dr. P. F. Williams. Pp. xxii+745. (Philadelphia and London: J. B. Lippincott Co., 1920.) 35s. net.
- (2) *Principles and Practice of Operative Dentistry.* By Dr. J. S. Marshall. Fifth edition. Pp. xxix+711+xvi plates. (Philadelphia and London: J. B. Lippincott Co., 1920.) 35s. net.
- (3) *Diagnosis and Treatment of Brain Injuries: With and Without a Fracture of the Skull.* By Prof. W. Sharpe. Pp. vii+757. (Philadelphia and London: J. B. Lippincott Co., 1920.) 35s. net.
- (4) *Lippincott's Quick Reference Book for Medicine and Surgery.* By Dr. G. E. Rehberger. (Philadelphia and London: J. B. Lippincott Co., 1920.) 63s. net.

MESSRS. LIPPINCOTT'S series of textbooks on medical subjects is well known in this country. Many of the volumes, as is the case with two of the four under review, have already reached the third or later editions.

Like nearly all American books, they are

copiously illustrated, and most of the pictures are helpful. A great many are borrowed, as may be judged from a list of between two and three hundred acknowledgments in Prof. Shears's book. Among these figures are four of a condition which, says the author, "one reads about but does not see"! Prof. Sharpe in his work uses photographs abstracted from kinematograph series to illustrate the stages of an operation and also the gait in spastic palsies of cerebral origin; the method is interesting and perhaps useful. The reproductions of microphotographs of dental tissues, normal and diseased, given by Dr. Marshall in his work on dentistry are really very good.

(1) and (2). Two of these books, those on obstetrics and dentistry, are text-books "for the student and practitioner," and both suffer a little from their dual aim. Whilst not large enough for works of reference, there is a tendency to include mention of methods or procedures but little used or of doubtful value, lest the author should appear "not up to date." The practitioner, therefore, must make use of larger or more specialised works, while the student is distracted from essentials and perhaps conceives wrong ideas of proportional values. The fault is by no means peculiar to these volumes—it pervades very many similar publications—which are, in fact, both very readable, for they are founded on extensive personal experience. With them as guide the student will not go far astray in practice, but it is just questionable whether the British student would do well to face his examiners without other help.

(3) Prof. Sharpe's book is not quite in the same category. It, too, is founded on personal experience; it embodies a large number of case records and might almost be called a thesis on the use of subtemporal decompression as a routine treatment in the presence of undue intracranial tension. In this country Harvey Cushing is looked upon as the exponent of this operation as to both indications and technique, and it is a little surprising not to find here a more ample acknowledgment of his pioneer work. The author's advocacy of the operation, at any rate in the birth palsies of children, in preference, apparently, to attack nearer the known site of the lesion, will scarcely suffice to secure a verdict in his favour from a jury of British surgeons. His documents, however, demand and deserve study by specialists. He is probably right in his view that recent severe injuries of the brain are too often treated on the principle of wait-and-see, but his method of demonstrating a long-persistent, high cerebro-spinal pressure seems a little

inadequate. The accepted physiological view of the maintenance of normal pressure and of the feasibility of modifying it by surgical measures must be altered, if the operation of decompression undertaken months or years after the injury be indeed sufficient to accomplish so much amelioration of symptoms. Nevertheless it makes a very interesting book.

(4) The last book on the list is a little difficult to place, at least for the British public, if not for the American. It is a large and expensive work, alphabetically arranged in eleven sections which are indicated by lettering in incised spaces at the free margin. The frontispiece is a folding manikin of value only to the layman, whilst the eleventh section consists of a hundred pages of pharmacology and therapeutics of use only to the practised and practising physician.

There is necessarily a lavish use of cross-referencing which is sometimes irritating; to be sent from "myotonia congenita" to "amyotonia congenita" only to be referred to "dystrophy" is annoying. It is obviously impossible to cover the whole range of medicine, surgery, and the specialties, such as eyes, skin deformities, nasal and aural surgery, gynæcology, obstetrics, and genito-urinary diseases, in one volume, however bulky it may be.

After all these complaints, when one comes to the subject-matter it is impossible not to appreciate the skill with which the "quick reference" book has been compiled, or to overlook the immense industry that has enabled Dr. Rehberger to skim the cream of all recent work and to present a mass of information in which it is difficult to detect a serious error. Moreover, when a controversial statement slips in, there is always a name or a reference to take the onus.

Compendia are not looked upon with much favour by those responsible for teaching, but probably there is a demand for such a book by busy practitioners, and it would not be surprising if even the well-informed and well-read should find it handy.

Our Bookshelf.

Chemie der Hefe und der alkoholischen Gärung.
By Prof. H. Euler and Prof. P. Lindner. Pp. x+350+2 Tafel. (Leipzig: Akademische Verlagsgesellschaft m.b.H.: Gustav Fock, 1915.)

HORACE BROWN, in his charming reminiscences, maintains the thesis that it is to the study of the processes of brewing and other fermentation industries that we owe many of the advances which have so greatly extended our knowledge in the domains of preventive medicine, modern

surgery, and sanitation. Be this as it may, and there is much to be said for it, there can at any rate be no doubt that yeast has been more thoroughly studied than any other micro-organism—and from the most diverse points of view. The book under review gives a clear and comprehensive account of these investigations, written by men who are peculiarly fitted for the task by their long experience in different branches of the subject. To Prof. Lindner fall the chapters on morphology, classification, and cultivation, whilst the remainder of the subject—the chemistry of the cell contents, the enzymes, and the energy relations—is dealt with by Prof. Euler.

Turning over the pages and remembering that the date of the book is 1915, one cannot help being struck by the great activity which is still being shown in research on this subject, and by the many notable additions which will have to be included in any new edition. The stream of work which has flowed uninterruptedly since Buchner laid bare the secret of zymase shows no signs of shrinking, but rather increases in volume year by year. Fresh facts are constantly being discovered and fresh light thrown on related subjects. At the moment the centre of interest and discussion is shifting from alcoholic fermentation, over which it has long rested, to the important problems raised by the nutrition of yeast and by the abundant production in the yeast-cell of one of those mysterious dietary essentials, the vitamins. In this connection many early observations were made concerning yeast, culminating in the experiments of Wildiers, who in 1901 postulated the necessity for a substance of unknown nature—which he termed "Bios"—for the growth of yeast. Some investigators have identified this with the vitamin B (water-soluble B factor) of McCollum, and an interesting controversy has arisen over the question. Another instance of the inexhaustible vitality of the subject is thus afforded, and it can be asserted with confidence that we are far from the end, perhaps rather only at the commencement, of the biochemical discoveries originating in the study of yeast. A. HARDEN.

The Man who Did the Right Thing: A Romance of East Africa. By Sir Harry Johnston. Pp. vii+444. (London: Chatto and Windus, 1921.) 8s. 6d. net.

THE man who did the right thing, and (except for one moral lapse, not of his own seeking) continued to do the right thing to the end of the chapter, was, as one might expect from a narrative so naively autobiographical as this "romance," an African pioneer, explorer, naturalist, and proconsul. The scene is laid in East Africa, mainly in the missionary field, and the period covered in the narrative dates back to the entry of Germany into the race for territory that led to the partition of Africa. Apart from the underlying love-story, which does duty for the sub-title, this novel of adventure (in treatment as well as in action) is remarkable for its fidelity to detail and its trenchant analysis of character.

To those who know something of the environments and are acquainted with the types of the leading actors in this story—not excluding the author—the interest is unflagging and the appeal irresistible. Truly it is a section cut out of real life, transparent and convincing. Names are unnecessary. The mordant criticism of officials in "the Service" (F.O. and C.O.), frankly contrasting with efficient German representatives, in the opening up of East Africa to European diplomacy, is further emphasised by the hero taking service as director (Herr Direktor!) in an Anglo-German undertaking for the exploitation of a certain concession, known as "The Happy Valley," somewhere in the Kilimanjaro region, and thereby achieving a remarkable success.

It is a book well worth reading for its information no less than for the story it tells. We confess, however, to some irritation at the originality of the author's treatment in places—e.g. his abrupt changes of mood and tense, and the actual "staging" of some of his lengthy dialogues, as in a play. A. S. W.

Artificial Light: Its Influence upon Civilization.

By M. Luckiesh. (The Century Books of Useful Science.) Pp. xiv+366. (London: University of London Press, Ltd., 1920.) 12s. 6d. net.

MR. LUCKIESH, who is well known as the author of a number of works upon illumination of a somewhat technical nature, has in this new volume written an interesting popular account of the development of artificial lighting. The influence of light upon civilisation is a fascinating subject. The author traces its early origins in the initial chapters of the book, which are illustrated by photographs of primitive pine-splinters, oil lamps, etc., and alludes particularly to its use as an element in religious ceremonial. Other chapters deal with early gas lighting, electric incandescent lamps and arcs, and the "light of the future." Later various applications of light—domestic, industrial, and spectacular—are discussed, and a chapter is devoted to artificial light in warfare. The type and paper are excellent, and there are insets of some remarkable photographs of lighting installations. The concealed lighting of the statue of Liberty in New York harbour forms an appropriate frontispiece, while several of the views of street lighting are striking; perhaps the most pleasing of all is a view of the Panama-Pacific Exposition at night. Generally speaking, the author has dealt with developments and applications of lighting in a popular manner rather than attempted a detailed analytical study of its effect upon civilisation, though the figures tracing the progressive diminution in the cost of light and its influence on health, safety, and efficiency are instructive. In the final chapter, entitled "Light—A Fine Art," the author writes with enthusiasm on the applications of light and colour for spectacular and decorative purposes. At the end of the volume a series of references to works on illumination and an adequate index are provided.

Letters to the Editor.

{The Editor does not hold himself responsible for opinions expressed by his correspondents. Neither can he undertake to return, or to correspond with the writers of, rejected manuscripts intended for this or any other part of NATURE. No notice is taken of anonymous communications.}

Human and Other Tails.

IN NATURE of February 24 last, p. 845, there appears a report of Prof. Arthur Keith's remarks at the meeting of the Royal Anthropological Institute held on February 8. It may be that the Journal of the institute will contain a more detailed paper on the same subject, and that the fuller paper will somewhat modify the dicta put forward in the report as it appears in NATURE. But in the absence of any further details it seems worth while to note some of the points raised by Prof. Keith which appear open to criticism.

My right to criticise may perhaps be sustained by the reference on p. 846 to Tarsius and to my published views concerning its systematic position. Prof. Keith's rather far-reaching generalisations were called forth by the examination of one of those fleshy sacral appendages commonly known as human tails. It is obvious from every sentence in the article cited that Prof. Keith believes that the human tail was lost because man became an orthograde—that is, adopted a vertical instead of a horizontal poise for his body. No doubt that is a very well justified position to take up, and, in so far as a human orthograde poise implies a cessation of tail utility, I entirely agree with him. But when Prof. Keith says, "With the evolution of the upright posture the pelvic muscles which act on the tail had to bear the steady burden of the abdominal viscera—had to be in action as long as the orthograde posture was maintained. They could not serve in the support of the viscera and the movements of the tail at the same time," I dissent from him altogether. Indeed, to me it seems a remarkable thing that one who is in constant association with the museum of John Hunter could possibly believe that, if this dual duty of support of viscera and production of tail movements were thrust upon them, the muscles would fail in one respect or the other. We need, as a matter of fact, go no further afield than the kangaroo to see how an animal which is typically orthograde may support its abdominal viscera in the upright posture, and yet possess a tail which is one of the most wonderful of muscularly controlled caudal appendages met with among the mammals.

Man has not lost his tail because the caudal musculature is incapable of undertaking the dual rôle of visceral support and caudal mobility. He has lost it because it has ceased to be of any use to him. For the same reason the gibbon, the orang, the chimpanzee, and the gorilla have lost theirs. For the same reason certain "pronograde apes" (which Prof. Keith appears to assume possess uniformly "basal or pelvic," as well as "free or terminal," portions of their tails) have lost theirs. *Cynopithecus* possesses no more than a button, the Barbary ape still less, and, indeed, the reduction of the tail is seen to the best advantage in the most typically pronograde group (the baboons) of the Primates. Because the tail has ceased to be of any functional use certain of the lemurs have also lost it, and so have a host of other mammalian forms belonging to other orders. Did it not appear flippant, one might ask if Prof. Keith imagines the guinea-pig lost its tail because its caudal musculature could not fulfil a dual rôle. Recession of the tail has been effected, and prehensile tails have been

developed, over and over again in the mammalian phylum. But one may not argue phylogeny, or the limits of the possibilities of muscular adaptation, to account for these things. No argument which bases the loss of the tail on the grounds cited by Prof. Keith carries the least conviction or bears any interpretation which may be distorted into human phylogeny.

Prof. Keith further goes on to state that "in pronograde apes the pelvic visceral musculature is attached to the peculiar chevron-like bones (hæmal arches) placed beneath the pelvic vertebræ of the tail; the reappearance of the hæmal arches in the human embryo during the second and third months of development may be regarded as definite proof that man comes of a pronograde ancestry." This is a common type of argument, one that has been current far too long, and one against which I have been attempting to teach for some time past. Apart from the confusion that may be caused by identifying "hæmal arches" with definite "chevron bones" is the gross fallacy involved in the argument that because hæmal arches are present in pronograde apes and in man, therefore man is developed from a pronograde ape. Hæmal arches are a primitive vertebrate heritage, but they are no more; they have no more to do with the pronograde poise *per se* than have the neural arches or the gill bars. We all know that the pronograde habit is typical of lower vertebrates, and we need not quibble about a pronograde vertebrate ancestry for man. But to argue that the pronograde simian ancestry of man is evidenced in the "re-appearance of the hæmal arches in the human embryo during the second and third months of development" is sheer nonsense. Hæmal arches are developed in birds, and one would have as good justification for saying that this proved that man descended from a volant ancestor as Prof. Keith has, by the parallel argument, for claiming man's descent from a simian pronograde ancestor. Both arguments are fallacious and stupid.

Whilst the whole trend of Prof. Keith's remarks appears to be directed towards a vindication of the pronograde simian ancestry of man, he seems, in the end, to disagree with the ancestral position of "*Tarsius spectrum*, for which Prof. Wood Jones claims a special human relationship." Yet of this animal he says: ". . . in its tail and tail-musculature *Tarsius* is a pure pronograde Primate." I should be sorry to destroy the last bridge by which Prof. Keith's views might be reconciled with my own; but I have no hesitation in saying that *Tarsius* is certainly not a pure pronograde, and that, moreover, no living animal the habits of which are open to observation should be judged as a pronograde by an examination of the musculature of its tail.

F. WOOD JONES.

The University, Adelaide, South Australia,

April 10.

TWENTY-FIVE years ago it was my privilege to teach Prof. Wood Jones; he now repays me with interest and with some degree of vigour. The matter wherein we differ has a very direct interest, not only for those who are seeking to unravel the history and relationships of man by means of anatomical evidence, but also for every zoologist who relies on structural details for arranging animals in a natural or evolutionary series. In man and in the four anthropoid apes—the gorilla, chimpanzee, orang, and gibbon—the tail has undergone a peculiar transformation—a sacralisation it may be named—for its vertebræ have become a mere submerged appendix of the sacrum. The depressor muscles of the tail have become spread out to form a muscular hammock on which the pelvic

viscera are supported. With this sacralisation of the tail there are numerous correlated changes in the vertebrae and muscles of the spine, in the musculature of the body-wall and thorax, and in the shape and arrangement of the viscera of the body-cavities.

As will be seen from his letter, Prof. Wood Jones is of opinion that each member of this orthograde group of Primates—man, gorilla, chimpanzee, orang, and gibbon—has acquired the sacralisation of the tail independently of each other; in his opinion we are dealing with remarkable resemblances produced by convergence. On the other hand, it seems to me a more rational explanation to believe that evolution is true, and that all the orthograde Primates are the progeny of a common stock—the primitive orthograde stock—and that we are therefore dealing with a common inheritance. Seeing that all have a nervous system cast in a common mould, with vascular, alimentary, muscular, and bony systems which differ only in detail, we do much less violence to what we know of the laws of evolution by adopting my explanation than if we accept that offered by Prof. Wood Jones. In no other Primate, save the five mentioned above, has the tail undergone sacralisation. The guinea-pig, the Barbary ape, and Cynopithecus have no bearing on the point in question; their tails have not undergone sacralisation. To compare the posture and method of progression of the kangaroo to man or an anthropoid ape is of the nature of burlesque.

In my original paper on vestigial tails I made special allusion to *Tarsius* because Prof. Wood Jones has misled public opinion as to the structural relationship that exists between anthropoid apes and man. He holds, on what I consider a flimsy basis, that man has been evolved from a *Tarsius*-like ancestor, and that between this ancestor and man there must be a series of undiscovered links. *Tarsius* has a particularly long tail; in no sense can its posture or method of progression be said to be like that of the orthograde Primates. In the manner in which its tail-muscles are arranged *Tarsius* resembles pronograde or dog-like apes. It has no claim to be called humanoid, whereas in this, as in a thousand other structural characters, the anthropoid apes can claim, not a resemblance, but an identity. ARTHUR KEITH.

The Stationary H- and K-lines of Calcium in Stellar Atmospheres.

It has been noticed by many observers that the space surrounding early B-classes of stars (e.g. δ Orionis) often show absorption of H- and K-lines of calcium, which do not share in the Döpler displacements of the other absorption-lines of the stellar spectra. This suggests that these stars are enveloped in an atmosphere of calcium vapour which does not partake in the orbital motion of the stars (NATURE, April 21, p. 247).

There is, of course, naturally a difficulty in realising why calcium, alone of all elements, should be found to occur in the attenuated atmospheres surrounding a stellar system. Very closely connected with this phenomenon is the observational fact that in the flash-spectrum of the sun the longest arcs are those corresponding to calcium H- and K-lines, indicating that in the sun also the outermost layers (according to Mitchell, 14,000 km. above the solar disc) are composed of calcium. Hydrogen, the lightest of elements, which we should expect to occur in the highest layers, disappears at a much lower level (8000 km., according to Mitchell).

The problem is naturally a complicated one, but

I think that a way to solution is afforded by the theories of selective radiation-pressure and of the temperature-ionisation of gases advanced by me in the following papers:—"On Radiation Pressure and the Quantum Theory" (*Astrophysical Journal*, September, 1919); "On Selective Radiation Pressure, etc." (*Journ. Coll. of Science, Calcutta*, 1920); "Ionisation in the Solar Chromosphere, etc." (*Phil. Mag.*, vol. xl., 1920); and "On a Physical Theory of Stellar Spectra" (*Proc. Roy. Soc. Lond.*, May, 1921).

According to these papers, the H- and K-lines are the resonance-lines of Ca^+ , i.e. of a calcium-atom which has lost one electron. The resonance-line of neutral calcium is the g-line, $\lambda=4227$. In the Fraunhofer spectrum we get H, K, and g, showing that in the solar photosphere calcium is largely ionised owing to the high temperature prevailing there. At higher levels, owing to diminution in concentration, the ionisation becomes complete, so that the g-line disappears entirely, leaving only the H- and K-lines.

The sun is a dwarf star of the Go class, corresponding to a surface temperature of 7000-7500° K. When we consider the spectra of the still hotter stars, classes F, A, and B, we find that the g-line becomes fainter and fainter, until it disappears altogether from the B8A class. In the still hotter stars we have only the H- and K-lines, showing that they do not contain neutral calcium at all, but only ionised calcium.

This explains the varying behaviour of the g-line and of the H- and K-lines, but we have still to determine the force which drives Ca^+ to the outermost layers. It is natural to conclude that the forces which are responsible for driving calcium absorbing H and K to the greatest height in the solar atmosphere are also responsible, in the case of stars having a larger surface temperature, for driving calcium to the surrounding parts of space. Now what can this force be, and why should this show a preference for calcium?

In the case of the sun I have attempted to show that this force is furnished by the pressure of radiant energy from the solar disc acting in a selective way upon the Ca^+ -atoms. The term "selective" is most important here, and requires an explanation. Radiation-pressure is due to absorption, and therefore, in the case of a gas illuminated by white light, only those pulses which the gaseous atom is capable of most frequently absorbing are effective in producing pressure. A gas can usually absorb lines of the principal series alone, but the lines of the subordinate series are absorbed only in exceptional circumstances, and even then to a much smaller extent; so that the maximum lifting effect of radiation-pressure is to be expected only in the case of atoms absorbing the resonance-lines. (For more detailed arguments see the papers above-mentioned.) In addition to this, the lifting force would depend on the intensity of the region corresponding to the absorbed lines in the spectrum of the continuous background of white light, and on the solid angle subtended at the atom by this background.

In the case of the sun the surface temperature is 7300-7500° K (Biscoe, *Astrophysical Journal*, vol. xlvii., p. 355), so that, according to Wien's law, $\lambda_m T = b$, the maximum of emission lies at $\lambda = 3920$ Å.U., very close to the H- and K-lines of Ca^+ . Also these lines are the resonance-lines of Ca^+ , so that we have here the maximum effect of selective radiation-pressure. The resonance-line of hydrogen is at $\lambda = 1216$ Å.U., and therefore the effect of radiation-pressure is extremely small.

It is not possible to say whether the lifting power

of selective radiation-pressure alone is capable of neutralising the force due to the gravitational attraction of the sun, but it looks very much as if this were so. Without being dogmatic on this point, we can work out the consequences of this assumption. In the case of stars having a much larger surface temperature, say $14,000^{\circ}$ K, B8A class, the value E_{λ} for H- and K-light would be much larger, so that the radiation-pressure is still greater, and in some cases preponderates over the greater value of gravitational force on these stars. Thus Ca^{+} -atoms would be driven very far into the surrounding space. They will be prevented from absolutely leaving the system, because with increase of distance the solid angle subtended by the disc of the star at the atom would diminish, and a condition of equilibrium would at last be reached.

The same phenomenon occurs to a smaller extent, in the case of the sun, with Sr^{+} and Ba^{+} , which have their resonance-lines near the spectral region of maximum intensity, but owing to their greater atomic weight the compensation is not so marked. Still Sr^{+} is very prominent in the chromospheric spectrum, rising to a height of 6000 km.

The question may be asked: Why do we not obtain the same phenomenon in the case of the other light elements? These can be divided into two broad groups: (1) non-metals like H, He, N, O, Ne, and A, having a high ionisation-potential, of which the resonance-lines lie in the extreme ultra-violet—e.g. for H, at $\lambda=1216$ Å.U.; for He, at $\lambda=585$ Å.U. (Lyman and Fricke, *Phil. Mag.*, May, 1920)—and can be detected only by subordinate lines—for helium, by D_{β} , $2p-md$; for hydrogen, by the Balmer lines. Naturally the effect of selective radiation-pressure is small on these elements. (2) Elements like Na, K, Mg, Al, Sc, Ti, Fe, which have an ionisation-potential varying from 5 to 8 volts. Under the conditions treated here these are mostly ionised, but the resonance-lines of these ionised elements lie mostly outside the region available for observation, e.g. the resonance-lines of Mg^{+} are $\lambda=2795.5, 2802.7$. The resonance-lines of Na^{+} and K^{+} have not yet been discovered, and probably lie in the extreme ultra-violet. Sc^{+} and Ti^{+} are represented by prominent lines in the chromospheric spectrum, but it is not yet known whether these are resonance-lines of these elements.

The hypotheses thus appear to be promising, but nothing final can be said before we can calculate the absolute value of the selective radiation-pressure on an atom. According to Eddington (*Monthly Notices, R.A.S.*, 1920, vol. lxxx., p. 723), the absolute value of the radiation-pressure is too small to account for the total neutralisation of gravitational force on the sun; but in that paper the consequences are worked on the basis of the continuous theory of light. The foregoing line of investigation at least brings out the intimate connection between the stationary character of the H- and K-lines in the space round the stars and the great prominence of these lines in the chromospheric spectrum. It shows that the higher chromospheric levels, as well as the space round B- and A-stars, may probably contain, besides Ca^{+} , also Na^{+} , K^{+} , Sc^{+} , Ti^{+} , and Mg^{+} , but owing to the fact that our observations have to be limited between $\lambda=3000$ Å.U. and 6000 Å.U., and that none but the resonance-lines of Ca^{+} lie within this region, we can detect nothing but Ca^{+} . But if some day we can overcome the limitation imposed by atmospheric absorption, probably we shall be able to detect Li^{+} , Na^{+} , Mg^{+} , K^{+} in the atmospheres surrounding B-stars which show stationary H- and K-lines.

MEGH NAD SAHA.

Berlin, May 8.

Biological Terminology.

My gentle touch has started an avalanche indeed, but I remain unmoved. Sir Archdall Reid asks (*NATURE*, June 2, p. 425): "Is not all systematic zoology and botany founded on this kind of classification?"—a classification based on definite, concrete facts of structure, in which there is "little or nothing" based on causes, on antecedents and consequents, or on hypothesis. The answer is in the negative. May I illustrate briefly some kinds of interpretation that a systematist has to employ?

There lie before me some mushroom-shaped objects from the Permian of Timor, clearly echinodermal, and actually described as the swollen spines of a sea-urchin. Such a spine is normally attached to the shell of the urchin by a ball-and-socket joint. These bodies, however, present at the end of the stalk three articular facets, each with a straight fulcral ridge, so placed that the fulcral ridges form an approximately equilateral triangle. Now, setting all resemblances aside, it is obvious that a single appendage cannot be attached to an immobile base by three facets so disposed, because the result of such an arrangement is immobility. It follows, from equally clear mechanical principles, that each facet must itself have borne a single appendage. Consequently the mushroom-like body is not an appendage, but a base which once bore three appendages. In short, it must be the cup and base of a crinoid. Having reached this conclusion by the application of mechanical principles, one attempts to apply some test, even if not a crucial test in the strict sense. The stereom of a spine is relatively light, and the meshwork in the axial region is still more open; the stereom of a fused crinoid base is dense. Sections across the Timor fossil show that its stereom is of the latter character. Not until all the facts have thus been interpreted can we proceed to apply the methods of a postal address and deliver our fossil at its proper street and number in Crinoid-town.

But there are cases in which the address is almost illegible, or has been so often crossed through and re-written that recourse must be had to skill higher than that of a letter-carrier. I am at the moment trying to identify some fossil Blastoids from North America. Of recent years the rocks in which these genera are found have been so minutely subdivided and the species have been so finely discriminated that the ordinary descriptions and keys (postal directories) cease to be of much help. In this class, as in others, the same forms appear to recur at intervals of time, and a correct interpretation demands a close study of the development in correlation with the chronology; by applying, as others have done, the theory of recapitulation we may unravel the tangle. It is not only fossils that furnish such problems to the philosophic interpreter; Dr. Annandale was showing me yesterday some Gastropods from Asiatic lakes that have to be dealt with in just the same way.

If we turn to the broader divisions of systematic zoology we derive still less aid from those simple rule-of-thumb methods which represent to Sir Archdall Reid the principles of taxonomy. At every step the modern systematist is considering origins; for him the truth or falsity of such principles as "the irreversibility of evolution" is of vital importance; his very diagnoses embody speculations. But the systematist recognises the metaphysical nature of his classifications, and he is perpetually seeking some crucial instance that shall give them a more secure basis of fact. He prophesies, for example, the existence of some connecting type at a certain period, and then he goes and finds it.

So much for the systematist! As for the biologist

at large, I do not believe he is averse from employing crucial tests. His difficulty in the manifold processes of life is to formulate tests that really are crucial. Sir Archdall Reid thinks it an easy matter, and he takes recapitulation as an instance. At the moment when his letter was published some of us were discussing that very question at the Linnean Society, and Sir Archdall Reid, had he been present, would have seen that the issue was far from being the simple one that he imagines.

F. A. BATHER.

June 4.

A New Acoustical Phenomenon.

WHEN living near Croydon aerodrome during the earlier part of the war, I noticed that the higher-pitched sounds apparently given out from an aeroplane flying nearly overhead varied with the height of my ear above the ground; thus, by bending down to one-half one's normal height, the pitch of this higher note rose an octave. I have on many recent occasions confirmed this result. This phenomenon is most noticeable when standing on a smooth road or lawn, and is scarcely distinguishable on a rougher surface, such as a hayfield; the logical conclusion is therefore that it is due in some manner to reflection from the ground. The pitch of the note varies also with the angle of elevation of the aeroplane; and is not generally audible unless this is more than about 45° . Since the pitch rises continuously as the head is lowered, the apparent explanation is that the note is due to the interval between the arrival of the direct and reflected waves from impulses radiated from the aeroplane—that is to say, no note of this definite pitch comes through the air from the aeroplane, only a regular, or irregular, succession of impulses, the time periods of which have no relation to the observed note, for it is obvious that merely bowing to the aeroplane could not alter the pitch of any note it might be giving out. (It is well known that a note of much lower pitch, due to the engine, is always present, but it is not in this sound that the variation takes place, although it is possible that these are the waves from which the variable high note is produced by reflection.) The pitch of the sound with which we are concerned is thus due to the fixed interval between the arrival of the direct and reflected impulses, and thus depends upon the height of the observer and the angle of elevation of the aeroplane. An interesting deduction from the discovery is that the ear is able to appreciate pitch from a succession of double impulses, if the interval between the elements of each double impulse is constant.

The phenomenon is not in any way peculiar to aeroplane noises; I have observed it with equal distinctness, though the sound was fainter, when standing under an aspen tree in a light breeze. Through the rustle of the leaves could be distinguished a note of quite definite pitch, which, as before, rose to its octave on lowering the head to half one's height.

In support of the explanation I have given, it may be remarked that the pitch of the note observed seems to correspond with the interval of time between the arrival at the ear of the direct and reflected impulses as calculated from the velocity of sound in air.

From the physiological point of view it would be interesting to make a laboratory test, using a disc siren with the holes pierced in groups of two, all pairs being similar to one another, but grouped at unequal spaces on the circumference; thus the passage of each pair would give a double puff, but the double puffs would be in an irregular succession. This would, no doubt, give a definite note corresponding in pitch to the interval between members of a pair of

holes, and would be a further confirmation of my explanation.

That two impulses alone appear to give a sense of definite pitch is interesting, and seems to indicate the existence of a resonating system in the ear. Experiments such as I have suggested, with a disc siren, might therefore help in the solution of the much-discussed problem of the function of Corti's organ. Another and more general series of experiments would have the object of finding whether, as is indicated by my observations, all sounds when heard by an observer near a reflecting surface have, in addition to the incoming fundamental note, a note of a pitch depending on the distance of the observer from the reflector. This phenomenon is known to have occurred, as regards electric waves, in Hertz's classical experiments. Unfortunately press of other research work prevents me from carrying out tests in this fascinating subject, but perhaps someone more directly interested may find time to develop it further.

J. ERSKINE-MURRAY.

Directorate of Research,
Air Ministry, Kingsway, London, W.C.2.

June 7.

Hérons and Fish.

It was commonly believed and asserted by old-time writers on natural history that from the feet and legs of the common heron exuded an oil with a peculiar odour which attracted fish within striking distance of the bird's powerful beak. Anglers used to mix the fat of a heron with flour and other matter and anoint their baits with it, whereby, says John Jonston in his "Historia Naturalis" (1657), "mirifice pisces illiciuntur."

I have never regarded this theory as of greater value than many others propounded by medieval empirics, but it was recently brought vividly to mind by what has taken place in the garden of one of my country neighbours. In this garden there is a rectangular pond measuring about 30 ft. by 20 ft. The sides are of dressed masonry, which extends under 9 in. of water so as to form a continuous ledge a yard broad, beyond which the depth drops suddenly to between 3-4 ft., wherein some of Marliac's water-lilies are grown. The pond was stocked with goldfish, which thrived well until a heron found its way there, and has succeeded in exterminating them. The owner of the garden, a good observer upon whose statement I can rely, tells me that the bird always took its stand in one corner of the pond, on the ledge covered by the shallow water, and that the goldfish moved out of the deep water into the centre and congregated round the heron, who picked them up at leisure. Had the fish remained in the deep water which they usually inhabited, of course the heron could not have reached them.

Although I draw no inference from this incident, it seems worth mentioning. It would be interesting to hear of an authentic parallel case.

HERBERT MAXWELL.

Monreith, Wigtownshire.

Why do Worms Die?

MANY times during the last twenty years I have been tempted to make the following communication. My house backs on to, and is partly built into, the old cliff at St. Leonards-on-Sea, and my back door opens on to a road cut into the face of the cliff. The road is well tar-macadamed and watertight. The esplanade at St. Leonards is wide, tar-gritted, and

watertight, and it contains a number of ornamental flower-beds surrounded by low brick and cement walls, surmounted by cornices which overhang 2-3 in. The surfaces of the beds are about 12 in. below the top of the walls.

On certain occasions I find worms in the back street, generally of medium to a rather large size, which have the appearance of being "drowned," although it is very rarely that life is extinct. On the esplanade they are present in large numbers. They occur at all points between the beds and the sea-wall, over which many of them must pass, for one can find them on the watertight stone undercliff. One naturally expects worms to rise after rain, but in a wet season I have known eleven wet days in succession without a single worm appearing, while on the twelfth day large numbers were to be found on the pavements, the road, and the back street. On the other hand, I have known them to occur after a rain-storm following dry weather. In several years the dates in November and January have coincided. The first thing that strikes one is that the phenomenon occurs only at long intervals, and then such large numbers participate in it. At other times one may never see a single worm. I have often wondered if it were in response to a migratory instinct.

The mystery is how these worms mount a wall 12 in. high and negotiate the overhanging cornice. On several occasions I have known quantities of "whitebait" and other things that occur at the surface of sea-water similarly strewn upon the esplanade and roads, and I have been tempted to ask if these worms have not been caught up similarly and returned to earth with the rain.

W. J. LEWIS ABBOTT.

I THINK Sir Ray Lankester (NATURE, June 2, p. 424) will agree with me that earthworms when underground must frequently or usually be in contact with other moist surfaces. My impression is that in dry weather, when the upper layers of soil contain only adsorbed water and are what we call "dry," earthworms seek the lower layers where the particles are moist—that is, are surrounded by a surface film of liquid water, however thin this may be. When in such a moist layer the surface of the worm must at many points be obtaining its air-supply through the medium of water which is not part of itself. The air, as Sir Ray Lankester says, reaches the worm through the porous soil, and I think in part through the moisture on the surface of the particles. The statement in my letter in NATURE of May 19 can admittedly be read as implying that the worm was partly dipped in slime or mud, but this was far from my meaning.

J. H. COSTE.

Teddington.

Vitality of Gorse-seed.

By way of supplementing my letter to NATURE of September 26, 1918 (vol. cii., p. 65), on the above subject, it may be of interest to record the fact that the seedlings arising from seed which has lain dormant in the soil for a quarter of a century have produced vigorous plants. A small part of the 20-acre field was not reploughed owing to its steepness, and the gorse seedlings which came up on it after the war-ploughing of the winter 1917-18 have been allowed to grow. They are now in their fourth season of growth, and are good-sized bushes averaging 2 ft. in height, which have been this spring a mass of bloom, like the gorse generally in this district and, I believe, throughout the country.

I can also add another year, making twenty-six in all, to the vitality of buried gorse-seed; the field in

question, save for the above-mentioned steep slope, was reploughed in the winter 1918-19, with the result that a fresh crop of gorse seedlings appeared the following summer. The field has now reverted to grass, and these two-year-old seedlings are being grubbed up.

JOHN PARKIN.

The Gill, Brayton, Cumberland, June 3.

Habits of the Hedgehog.

IN the article on the hedgehog which appeared in NATURE of May 19, p. 375, mention is made of the widespread belief that hedgehogs suck the teats of cows. Although farmers have assured me that they have found evidence of milk on the hedgehog, I do not think that any credence can be given to the statement. The belief probably arises from the extrusion of the contents of the vesiculæ seminales of the buck hedgehog when crushed, kicked, or otherwise injured. The vesiculæ seminales are, when full, extraordinarily large in proportion to the size of the animal, and the milky fluid can easily be mistaken for cow's milk, especially when the hedgehog has rolled itself up for defensive purposes and the face has become smeared with the seminal fluid.

That hedgehogs will eat young birds I have had personal experience, but I doubt if they do much damage to game in this way.

In 1906 and 1907 several albino hedgehogs were found at Goathland, Yorkshire. I attempted to cross an albino doe with a normal buck, but when placed together the latter promptly attacked and killed it. In attempting to breed them in semi-captivity, i.e. in a large walled garden, I found that the bucks harried the does a good deal, thus rendering it difficult to secure a litter, and that if the nest was disturbed the mother would frequently eat her young. This proved a real difficulty in the experiments.

G. A. AUDEN.

Birmingham, May 29.

Principles of Picture-hanging.

THERE is no need for picture-wire (NATURE, May 19, p. 362; May 26, p. 395; June 2, p. 438) if the principle is adopted described in the *Times Engineering Supplement* of April, 1919, of the application of Kelvin's Five-Point principle to the picture-hanging.

A rail, say of black enamelled electric conduit tube, is supported along the wall at an appropriate height on bracket-hooks fixed in the wall, and the pictures are hung on the rail by two bent iron hooks fastened on the back of the upper edge of the frame. This gives four points of contact, and the fifth is made by a round-headed screw in the lower edge to set the face at an appropriate cant. One degree of freedom is still left of a motion of the picture sideways into the desired place. A picture is lifted off in a trice and thrown out of the window in case of fire, as of a gallery of portraits in an old mansion; and the pictures can be hung over each other, two and three deep if space is limited, as in the Royal Academy.

The principle is appropriate in a modern physical workshop for the support of apparatus, however heavy, bracketed out from the wall, if a plate is built into a course with a projecting lip. A nail cannot be driven into the glazed-brick wall, but a picture-board can be kept for that purpose and placed where required. The difficulty is avoided of the suspension of apparatus from the roof or ceiling.

The principle seems to have been employed in the Pinacotheca of the ancient Acropolis of Athens.

G. GREENHILL.

1 Staple Inn, W.C.1, June 6.

Oersted—the Discoverer of Electro-magnetism.¹

ON July 21, 1820, Hans Christian Oersted, of Copenhagen, announced his great discovery to the world in a circular letter in Latin, "Experimenta circa effectione conflictus electrici in acum magneticam." He describes in detail the apparatus he employed, emphasising the fact that "the galvanic circle must be complete, and not open, which last method was tried in vain some years ago by very celebrated philosophers," gives a list of distinguished men who had witnessed the new effect, and then writes:—

"Let the straight part of this wire"—i.e. the wire uniting the two poles of the battery—"be placed horizontally above the magnetic needle, properly suspended and parallel to it; if necessary the uniting wire is bent so as to assume a proper position for the experiment. Things being in this state, the needle will be moved, and the end of it next the negative side of the battery will go westward. If the distance of the uniting wire does not exceed three-quarters of an inch from the needle, the declination of the needle makes an angle of about 45°. If the distance is increased, the angle diminishes proportionally; the declination likewise varies with the power of the battery."²

A later communication³ states that "he discovered by continual experiments during a few days the fundamental law of electro-magnetism, viz. that the magnetical effect of the electric current has a circular motion around it."

The Royal Danish Society of Sciences is celebrating the centenary of Oersted's discovery by the issue of a collected edition of his scientific papers, and the work before us is an essay by Mrs. Kirstine Meyer, forming the first volume of the collection.

H. C. Oersted was born at Rudkjøbing in 1777. His father was an apothecary, and Hans Christian and his younger brother, A. C. Oersted, afterwards a distinguished jurist, received their early education from a German wig-maker and his wife, who taught them to read and speak German, but whose knowledge of arithmetic was limited to addition and subtraction; an older schoolfellow taught them multiplication; a friend of the family, division. From their eleventh and tenth years respectively they helped their father in his pharmacy. In 1794 they went to Copenhagen to finish their preparation for their first academic examination, which they passed with honours. As undergraduates they were admitted to Elers College, founded in 1691, which still provides free residence and a small scholarship for needy students. They went through the university course together with distinction, studying mathematics and chemistry, and being greatly interested in philo-

sophy. Kant's teaching was then expounded in Copenhagen by Prof. Riisbrigh, and his lectures markedly influenced them. The lectures on astronomy and physics attracted H. C. Oersted to the study of science; his brother became distinguished for his philosophical writings; but throughout Hans Christian's life we can trace the effect of his early philosophical studies in his work. In 1798 he writes: "I promised you in our last conversation to give you an account in letters of the systematic part of chemistry. . . . I keep my promise with pleasure both for your sake and for that of science, which you know I find so much pleasure in communicating to others." The same year the brothers became members of the editorial staff of a short-lived journal, a philosophical repertorium, the chief object of which was to defend Kant's works.

As regards experimental work, the elder Oersted was limited mainly to the chemical training received in pharmacy where he was employed; the university had no physical equipment. He was helped, however, by Prof. Manthey, professor of chemistry, and owner of the Lion Pharmacy. Manthey was abroad during 1800 and 1801, and Oersted managed his pharmacy. Volta's discovery of the galvanic battery had just been published, and Oersted's earliest experiments were connected with the behaviour of various forms of cells and with the testing of a theory, advanced by Ritter, to account for the decomposition of water by a current: that water *plus* negative electricity produced hydrogen, while water *plus* positive electricity produced oxygen. He measured his currents for these experiments by the aid of a voltmeter arranged to collect in a graduated tube the products of the decomposition.

In 1801 Oersted had hopes of a professorship or readership in the university, but he was then looking forward to the prospect of a journey abroad, rendered possible by a grant from "Cappel's Travelling Legacy"; and in a letter to Manthey he says that he would rather resign any post than give up the prospect of the journey. He started in the summer of 1801, and was away until the end of 1803. For a time the world was at peace. Napoleon was First Consul; the war between France and Austria was stayed temporarily by the Peace of Lunéville (February, 1801). The victory of the Nile, 1798, and of Aboukir Bay, 1801, ruined the French plans for an attack on India through Egypt, while access to the Baltic and the defeat of a combination of the Northern Powers against England were secured by Nelson's victory at Copenhagen in April, 1801. The Peace of Amiens followed in March, 1802, and intercourse between men of science of all nations was at once renewed. To us, in 1921, the rapidity with which this took place is somewhat surprising.

Oersted went first to Weimar. At Göttingen he was introduced to Ritter, whose electrical re-

¹ "Scientific Life and Works of H. C. Oersted." By Kirstine Meyer. (From H. C. Oersted: "Scientific Papers," vol. i.) Edited by the Royal Danish Society of Sciences. Pp. clxvii. (Copenhagen: Andr. Fred. Høst and Son, 1920.)

² Thomson's "Annals of Philosophy," vol. xvi. (1820), translated from a Latin account sent by the author.

³ "Edinburgh Encyclopædia," vol. xviii. (1830).

searches impressed him greatly. From Weimar he went to Berlin, where he heard Fichte and Schlegel lecture. At Weimar he had become acquainted with a work by Winterl, "Prolusiones ad Chemiam Decimi Noni," and set himself to make this more widely known, publishing in 1802 a book, "Materialen zu einer Chemie des neunzehnten Jahrhunderts," the object of which was to show the common origin of physical and chemical forces. The book was severely criticised everywhere, and Winterl's chemistry, founded on two mysterious substances, Andronia and Thelycke, has long since been consigned to the oblivion it deserved; but the root-idea, the common origin of most natural forces, lay at the basis of much of Oersted's future work.

From Berlin Oersted went to Paris, visiting Ritter at Weimar on the way, and taking part in some of his experiments. On describing these in Paris, especially the invention of what was probably the first storage battery—a storage column, Ritter called it: a pile of copper plates separated by discs of moist cardboard, which retained a charge for some time after it had been connected to a battery, and was capable itself of giving out a current when its extremities were connected by a wire—Biot asked him to write and advise Ritter to compete for a prize of 3000 livres offered by the First Consul for the most important electrical or galvanic experiment which might compare with the invention of the voltaic pile.

Oersted re-wrote in French the essay Ritter sent in, but the author had stated that his storage column, when placed in a vertical position, became charged through the electrical influence of the earth. Experiments at Paris failed to verify this, and the prize went elsewhere.

Oersted returned to Copenhagen in January, 1804, and was disappointed at not receiving the professorship of physics, which had been vacant for some time. The warden of the university considered him a philosopher rather than a physicist, and it was not until 1806 that he became professor extraordinarius. In 1807 he repeated and extended Chladni's work on vibrating plates, using *Lycopodium* in place of sand. He noted, but could not explain, the action of the *Lycopodium* in collecting in the places of maximum vibration; that was left for Faraday.

In 1812 and 1813—the years of Moscow and Leipzig—Oersted again visited Berlin and Paris, and, encouraged by the reception he met with, published his "View of the Chemical Forces of Nature," in which, while expressing his indebtedness to Ritter and Winterl, he dissociates himself in many respects from their theories. He avows his continued belief in the essential unity of natural forces, and, while his views are often vague and unsatisfactory, he proposes that "the experiment should be made whether electricity in one of its most latent forms could act on the magnetic bodies as such." The answer came in 1820. The book was well received everywhere. Thomson writes in the "Annals of Philosophy, 1819," deal-

ing with a later French edition: "The book is highly worthy the perusal of all those British chemists who aim at the improvement and perfection of their science. It is rather surprising that a work of such originality and value should have remained for these four years quite unknown in this country."

In the years which followed, Oersted was busily occupied with routine work. In 1815 he became secretary of the Society of Sciences, and in 1817 professor ordinarius. In this capacity he delivered a series of monthly lectures to advanced students on the progress of science, and it was at one of these in the spring of 1820 that his great discovery was made. His own description of this will be found in the article in the "Edinburgh Encyclopædia" already referred to. After stating that the luminous and heating effect of the electrical current goes out in all directions, "so he thought it possible that the magnetical effect could likewise emanate"; and after referring to magnetic effects produced by lightning; he continues: "The plan of the first experiment was to make the current of a little galvanic trough apparatus commonly used in his lectures pass through a very thin platina wire which was placed over a compass covered with glass. The preparations for the experiment were made, but, some accident having hindered him from trying it before the lecture, he intended to defer it to another opportunity; yet during the lecture the probability of its success appeared stronger, so that he made the first experiment in the presence of his audience. The magnetical needle, though included in a box, was disturbed; and as the effect was very feeble, and must, before its law was discovered, seem very irregular, the experiment made no strong impression on his audience." Nothing further happened for three months; he delayed his researches until a more convenient time, when a large battery, constructed by his friend Esmark and himself, was available, and then, during a few days in 1820—July 15–20—he made the series of experiments which was announced in the Latin circular letter of July 21 already quoted.

A letter from his pupil Hansteen to Faraday, printed in Bence Jones's "Life of Faraday," gives a fuller account of the original discovery: "At first he had placed the wire at right angles to the direction of the magnet, and found no effect. After the end of the lecture he said: 'Let us now once, as the battery is in activity, try to place the wire parallel to the needle'; as this was made, he was quite struck with perplexity by seeing the needle make a great oscillation almost at right angles with the magnetic meridian. Then he said: 'Let us now invert the direction of the current,' and the needle deviated in the contrary direction. Thus his great detection was made, and it has been said, not without reason, that he tumbled over it by accident. He had not before any more idea than any person that the force should be transversal. But, as Lagrange has said of Newton on a similar occasion: 'Such accidents only meet persons who deserve them.'" Hansteen's remark

would appear to do less than justice to his master, and has proved rather unfortunate, lending colour to the impression that the whole discovery was due to chance. This was far from being the case. Oersted had for years been seeking a connection between electricity and magnetism, and the discovery was the result of his search.

Not the least instructive part of Mrs. Meyer's very interesting book is a series of sheets reproduced in facsimile from notes, mostly in his own handwriting, found among Oersted's papers, which give in detail the experiments with the large battery during July, 1820. Not only did he experiment with a straight wire, but also with one bent into a loop so as to form one complete turn of a circuit, which thus had its north and south face. Oersted saw that such a circuit acted like a magnet. The effect of replacing the magnet by needles made of non-magnetic material was tried, and it was found that they were not disturbed by the current.

The results, announced to all centres of scientific activity, at once produced a great sensation. The paper was published in various journals, and among others in Schweigger's *Journal* for July, 1820, and the same number contains an account of further experiments of importance. Oersted showed in this second communication that the effects "do not seem to depend upon the intensity of the electricity, but solely on its quantity"—in modern words, on the current, and not on the e.m.f. of the supply. Further, he showed, by suspending by a fine torsion wire a small battery and the circuit through which the current passed, that the effect is reciprocal: on bringing a magnet pole up to one face, the circuit is repelled; on bringing the same pole up to the other face, it is attracted.

But while Oersted's experimental work is admirable and his demonstration complete, it is not easy to follow his theoretical ideas. He speaks continually of the "conflict of the electricities" which constitutes a current. The positive and negative electricities flowing in opposite ways round the circuit come into conflict, and it is through their struggle that the various effects are produced. It would almost appear as though he thought that the heat and light radiated from a glowing conductor needed some violence for their origin—violence provided by the struggle between the positive and negative electricities. "He did not consider," he writes himself, "the transmission of electricity through a conductor as a uniform stream, but as a succession of interruptions and re-establishments of equilibrium in such a manner that the electrical powers in the current were not in equilibrium, but in a state of continual conflict." To this conflict he attributes also the magnetic action which originally he anticipated would be radiated outwards from the wire, like heat and light. Experiment proved otherwise; the magnetic action showed itself effective in directions at right angles to the wire, but he did not grasp the idea of a current of electricity flowing in the

wire accompanied by a field of magnetic force arranged in circles round the path of the current. In his view, the electricity acted directly on the poles of his magnet, and as the force was due to the electric conflict, this conflict took place, not only in the wire, but also throughout the surrounding space through which the electricity flowed in a series of flat spirals encircling the wire itself. There was a transference of electricity in the direction of the wire; the path, therefore, of the current could not be a circle in a plane normal to the wire, but a spiral giving rise to a component of the motion parallel to the wire. According to his first ideas, though he modified these later, "negative electricity repels the north pole, but does not act on the south pole," while positive electricity acts on the south pole, but not on the north.

In 1828 Oersted writes thus, possibly after he had become aware of Faraday's work: "The electrical stream has a magnetic circulation about its axis. Every act of decomposition due to an electrical current in a given direction is accompanied by a circulation. Through this electrical stream, which, as I have shown elsewhere, is propagated by alternations of positive and negative electricity, there is brought about a series of charges and discharges of particles in the direction of the stream, and a circulation in planes at right angles to it."

The importance of this discovery was recognised everywhere. In Germany, at a somewhat later date, an attempt was made by Gilbert and others to lay stress on its accidental nature. "Was alles forschen und Bemühen nicht hatte geben wollen das brachte ein Zufall Herrn Professor Orsted in Kopenhagen," he wrote in his *Annalen* in October, 1920, and this view was accepted by many of his contemporaries; but elsewhere Oersted received full and generous credit. The French physicists, led by Arago and Ampère, took up eagerly the investigation of the new phenomena, and in a few months Ampère established the laws of the mechanical action between electric currents. "The whole theory and experiment," writes Maxwell, "seems as if it had leaped full grown and full armed from the brain of the 'Newton of Electricity.'" It is perfect in form and unassailable in accuracy, and it is summed up in a formula from which all the phenomena may be deduced, and which must always remain the cardinal formula of electro-dynamics." Ampère's brilliant work somewhat overshadowed Oersted's merit, which, however, the French investigators fully recognised.

In England Sir Humphry Davy was the first to repeat the experiments, using for the work "the great battery of the London Institution, consisting of 2000 plates of zinc and copper"; he showed at an early date that the arc between two charcoal electrodes was altered in shape when a magnet was brought near. In April, 1821, Faraday wrote an historical survey of the growth of the subject up to date, stating that Oersted's results "comprise a very large part of the facts that are yet known relating to the subject," and pointing out that his constancy in the pursuit of his

inquiries respecting the identity of chemical, electrical, and magnetic forces "was well rewarded in the winter of 1819 by the discovery of a fact of which not a single person besides himself had the slightest suspicion, but which when once known instantly drew the attention of all those who were at all able to appreciate its importance and value."

From the autumn of 1822 to the summer of 1823 Oersted was in Germany, France, and England. He is less enthusiastic than in the past about the German men of science whom he met. "Schweigger at Halle has brains, but is a reed shaken with the wind. His experiments are not of much importance. Kastner at Erlangen writes thick volumes compiled with much toil but without all judgment. Yelin at Munich makes indifferent experiments and lies much. But I have found much that was instructive with Fraunhofer at Munich, so that I have been able to occupy myself with benefit there for about a fortnight."

To the Frenchmen he is more kindly. "My stay here grows more and more interesting to me every day. The acquaintances I have made grow every day more cordial and intimate," he writes to his wife from Paris in February, 1823. He saw Biot, Fresnel, Pouillet, Ampère, Arago, Fourier, Dulong, and many others: such was the brilliant list of physicists then at work in Paris. With Ampère he had many discussions as to their rival theories; at one time he thought he had disproved the existence of the molecular currents which in Ampère's view constitute a magnet. Mrs. Meyer quotes from another letter an amusing account of a three hours' discussion which took place after a dinner given by Ampère. Among the guests were two of the host's pupils, and of them Oersted writes: "Even Ampère's two disciples declared that my theory was able to explain all his phenomena. They declare that so will Ampère's, and as his theory is nothing but the reverse of mine, he having removed the circuits of forces discovered by me from the conductor to the magnet, it will no doubt be difficult to find an entirely decisive objection to his theory."

The experiments which Ampère arranged for his benefit were not successful. "On the 10th I was at Ampère's by appointment to see his experiments. He had invited not a few. . . . He had three considerable galvanic apparatus ready; his instruments for showing his experiments are very complex; but what happened? Hardly any

of his experiments succeeded. He is dreadfully confused, and is equally unskilful as an experimenter and as a debater." Somehow this is hard to believe; some at least of the confusion existed, we may suspect, in the mind of the narrator. Ampère's own descriptions of his work are models of clearness; his formula remains, as has been said above, "the cardinal formula of electro-dynamics."

Oersted lived for some thirty years after the discovery of 1820, engaged almost to the last in physical work. During part of the time he was greatly interested in measurements of the compressibility of liquids. Details of some of these are given in a letter to Brewster dated December 30, 1826. He was one of the first to realise the necessity of allowing for the expansion of the vessel containing the liquid, and a piezometer which he described in the Proceedings of the Danish Society of Sciences for 1821 has been frequently employed for measurements of the kind, though Oersted was mistaken in thinking that it avoided all the difficulties arising from the expansion of the containing vessel.

Under date 1845 we have the following suggestion for a moving coil galvanometer: "A metal wire bent as a multiplier and able to revolve easily round two points is placed opposite the poles of a strong magnet in such a way that it will be deflected as soon as it is traversed by electricity."

In 1848 Denmark was at war, and in a letter of that date Oersted alludes to the fact that thirty years earlier he had experimented on the use of electricity for firing mines, and makes the suggestion of "burying in a road to be taken by an attacking enemy, under a comparatively thin layer of earth, small reservoirs filled with gunpowder and earth or small fragments of stones which could be fired by a communicating wire on a given signal and that in a shorter time than one second after the signal."

More will be found in Mrs. Meyer's excellent volume about the activities of a remarkable man; she has done her work admirably, and we are indebted to her for her labours in producing this most interesting work. The book, which is printed in English, has been published in Copenhagen under the editorship of the Royal Danish Society of Sciences, and is in every way a worthy memorial of perhaps the most distinguished member of that society. R. T. G.

Native Life in the Loyalty Islands and Southern Nigeria.¹

By HENRY BALFOUR.

(1) **M**RS. HADFIELD'S book on the Loyalty Islands is the outcome of a long residence in this group, in connection with the work of

¹ (1) "Among the Natives of the Loyalty Group." By E. Hadfield. Pp. xix+316 (London: Macmillan and Co., Ltd., 1920.) 12s. 6d. net.

(2) "Among the Ibos of Nigeria: An Account of the Curious and Interesting Habits, Customs, and Beliefs of a Little Known African People by One who has for Many Years Lived amongst Them on Close and Intimate Terms." By G. T. Basden. Pp. 315. (London: Seeley, Service, and Co., Ltd., 1921.) 25s. net.

the London Missionary Society. The greater part of the time was spent on Lifu Island, but eight years were spent on the smaller island of Uvea. The account which she gives of the natives is unpretentious and straightforward, written in an easy and attractive style and with a vein of humour. She reveals her sympathy with the natives, with whom she became on excellent terms, and much

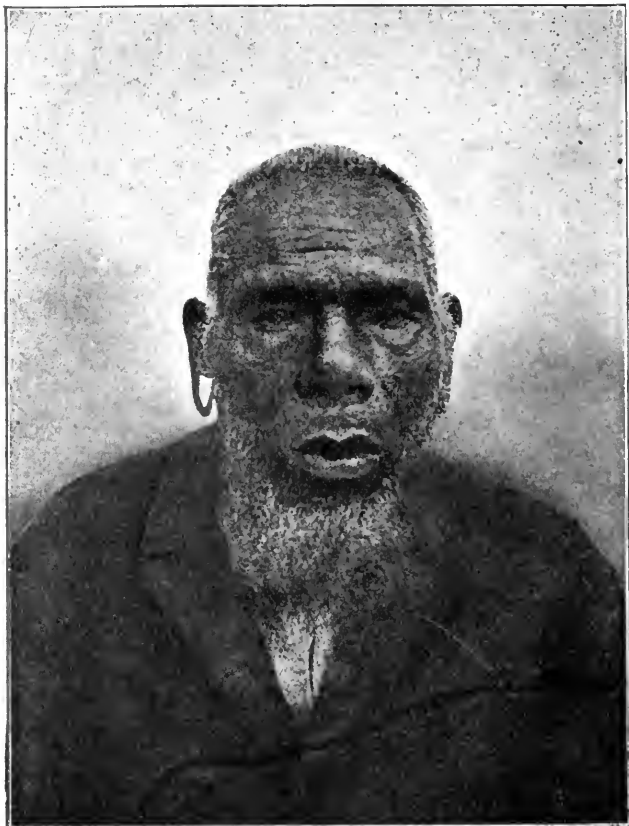

FIG. 1.—Type of Uvean native, Loyalty Islas. From "Among the Natives of the Loyalty Group."

of the information acquired regarding their habits, customs, and ideas was the reward of having gained the confidence of the islanders. Although but some sixty miles separate the Loyalty group from New Caledonia, the natives of the former, with their cheery disposition and laughter-loving habit, differ markedly from the dour, sullen natives of the latter. The tradition that Uvea was peopled partly by immigrants from the Polynesian Wallis Island (also called Uvea), lying about 1000 miles away, is borne out by the fact that Uvea boasts of two languages, the original "Iaian" and a distinct and apparently intrusive language spoken in the north and south of the island. This Polynesian intrusion explains, perhaps, the temperamental difference which is noticed between the Loyalty Islanders and the more strictly Melanesian New Caledonians, and also accounts for certain customs

and appliances which exhibit Polynesian affinities.

The account given by Mrs. Hadfield of the mentality, daily life, useful and æsthetic arts, and also of the customs, social ethics, and legends of the Loyalty Islanders, is very concise and full of interest. One cannot but recognise how rapidly the old indigenous culture is disappearing. The author dwells upon their many good qualities, and endeavours to account for those characteristics which civilisation deems undesirable and bad. Allowances must be made for the native point of view and for the environment, though the former is always difficult of diagnosis. Even in war a system of sportsmanlike etiquette prevailed, and certain unwritten laws were studiously observed. Due notice was given of an impending "state of war," and operations were not commenced until after the expiry of a period of several days. The heads and noses of children were modified by pressure in order to induce the orthodox, fashionable shape, a practice which is of much interest owing to its wide dispersal over the world, but is disconcerting to the ethnological craniometrist.

The natives exhibit skill and boldness in surgery, though their methods are necessarily of the crudest. Trepanation was freely resorted to, and with success; fractures were dexterously reduced. Hygienic principles are practically non-existent, and the spread of infectious diseases is rapid. The intro-

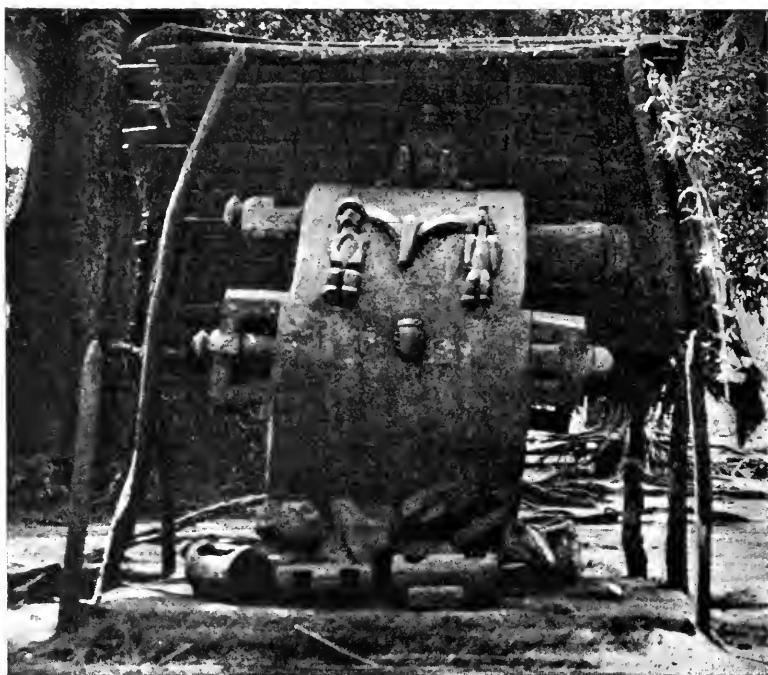

FIG. 2.—The wonderful wooden gong of Umu-nze, the maker of which was murdered lest he should make an even finer one for another town. From "Among the Ibos of Nigeria."

duction of foreign diseases has had a disastrous effect, accentuated by the imported vices, which are usually more attractive and more easily assimilated than are the white man's virtues. Fear of death does not appear to weigh heavily upon the natives. A number of native legends is given at the end of the volume, affording useful material for comparative study.

It may seem ungrateful to express the wish that Mrs. Hadfield's descriptions of industries,

intercourse with natives, involving close personal contact, is the Rev. G. T. Basden's volume dealing with the Ibos of Southern Nigeria. The author has aimed at giving a fairly detailed, though popularly written, account of these interesting natives, and has succeeded in producing an instructive and attractive volume. He sounds a note of caution which may well be taken to heart by globe-trotters and stay-at-home amateurs who, with little or no experience, write books about native ideas and beliefs. He writes: "The longer one lives amongst West African natives, the more one is convinced that it is a practical impossibility for the European to comprehend fully the subtleties of the native character. Some white men claim to have done this, but my experience leads me to think that the claim can rarely, if ever, be substantiated with definite assurance."

This is an honest admission on the part of one who has lived long enough among the natives to realise the difficulties involved in the diagnosis of their mentality, and to recognise the fundamental difference between their "philosophy" and ours. The Ibo people, who form nearly one-half the population of Southern Nigeria, occupy the country lying mainly between the Niger and Cross rivers, a huge tract extending from the coast to 7° N. lat. There is a westerly extension across the Niger. The Ibos are not homogeneous, important variations occurring in the extensive area occupied. The environment varies considerably, from the low-lying swamps of the Delta to the higher land around Onitsha.

The book is a timely one, since the indigenous customs are very rapidly undergoing changes, though in 1900, when Mr. Basden arrived there, primitive conditions still largely persisted. The general life of the Ibos is well presented. A man's greatest desire in life is to advance in social status, and many crimes

are committed in order to promote this advancement. Theft (to obtain the necessary funds), murder, and head-taking (as a sign of prowess) are very usually the outcome of this craving for higher titles. Cannibalism has been rampant, human flesh being regarded as a valuable food product. Polygamy is favoured equally by both sexes, and will be suppressed only with great difficulty. The first wife takes prece-



FIG. 3.—Hair-dressing as a work of art. From "Among the Ibos of Nigeria."

appliances, and habits might have been more detailed, since the production of a complete textbook was not her intention. In asking for more, one does so in full recognition of the praiseworthy and useful work performed by the author in giving us this very readable and well-illustrated book, which deserves fuller notice than can here be given.

(2) Another product of many years of missionary
NO. 2694, VOL. 107]

dence of all the others, and is regarded as the legal wife, *anasi*, who is priestess of the household gods. Belief in the survival of the soul prevails, and adequate burial of the dead is a matter of great concern. A first, necessarily hurried burial takes place soon after death, but a second more elaborate and very costly "burial" by proxy is performed later, with the view of keeping the spirit of the deceased in contentment. Failing this propitiation, the spirit may become restless and malignant. Reincarnation is believed in. Children are well treated and thrive, and although their treatment is often very drastic and appears cruel, the parents evince great fondness for them. Twins, however, are held in abhorrence. In this respect the Ibos differ from the neighbouring Ekoi, who welcome twins. Boys are initiated into the mysteries of the Ayakka secret society at the age of ten.

The secret societies are dealt with by the

author in detail, and the religion and superstitions are well, if briefly, described. The chief deity is Abwala, and at her shrine oracles are sought and "trials" are conducted. The priests, in consequence, exercise a great controlling influence, as is so often the case in Africa. The arts and crafts and the trading methods are interestingly dealt with, and one feels that the author has command of more information than could be published in a single volume. The illustrations are excellent and fairly numerous. One wonders why the household god called in the text *Ikenga* (p. 219) is designated *Skenga* on the plate (p. 120), and why the illustrations are sometimes inserted far from the text to which they refer. It would have been advantageous if all native names had been printed in italics. Such minor blemishes, however, do not materially lessen our appreciation of this very useful and instructive volume. Both the author and his readers may be congratulated.

Obituary.

PETER DONALD MALLOCH.

ARDENT naturalists in humble ranks of life during last century, such as Edwards, of Banff, and Robert Walker, of St. Andrews, in zoology, and Sergeant Sim, of Perth, in botany, have not been rare in Scotland, but few showed more acute penetration, combined with artistic skill and fitness for administration, than Peter Donald Malloch, the premier angler and skilful taxidermist, as well as the originator and able administrator of the Tay Salmon Fisheries Co.

A native of the neighbourhood, Malloch spent most of his life in the Fair City, taking the foremost place, after the death of Mr. Lamb, as a taxidermist (many examples of his skill being now in the Perth Museum), then well known for his remarkable success as a practical angler, and, lastly, as manager of the salmon syndicate just mentioned. It was in Perthshire that the artificial hatching of the salmon at Stormontfield ponds first attracted the attention of men of science in the fifties and early sixties of last century, and the work of Robert Buist, Wm. Brown, and John Dickson made it widely known. Malloch, however, following these, and in the unique position he held on the finest salmon-river in the country, one which carries the largest body of fresh water to the sea, was able to clear up certain ambiguities, and though he had no training in science he grasped the information derived from an investigation of the scales of the salmon, sea-trout, and other fishes, and worked out their life-history with great accuracy and acuteness. In 1910, indeed, he collected all his information in an interesting work entitled "Life-history and Habits of the Salmon, Sea-trout, and other Fresh-water Fish," a work illustrated by as many as 239 exquisite life-like photographs—mainly by himself.

Malloch's observations on the various classes of

salmon ascending the rivers, and a comparison of their movements with those of the sea-trout (the latter feeding in fresh water, whilst the salmon does not), are of great interest and value in this complex subject. He believed that almost all salmon in the sea make for the rivers where they were born. He had some hesitation in accepting the view that some of the parr become smolts at the end of their first year, but old "Peter of the Pools" at Stormontfield would have strengthened the case by demonstrating that many of the year-old parr reared there grew apace, assumed the silvery coat, passed down the rivulet to the pen near the river, and would even leap over its edge in their eagerness to migrate seaward.

Malloch's efficient marking of the smolts with silver wire gave him much information as to the rate of growth of the salmon, irregularity in spawning, and other points. His wide experience of the Tay and other rivers and of numerous lochs enabled him to corroborate Dr. Gunther's opinion as to bull-trout, and so with his remarks about yellow fins and whitling, the young of the sea-trout. Further, the acuteness of his observations is shown by his finding a new char (*Savelinus Mallochii*, Tate Regan) in a lake in Sutherland. That he was able to accomplish so much in the midst of strenuous commercial fisheries work, comprehending the Tay from Stanley to the sea, the surveying of rivers and lochs, and the letting and sale of highland estates, shows that his capacity was of no ordinary kind. Perth has always been the centre from which has emanated much of the life-history of the salmon, and Malloch enhanced and extended that reputation. He died toward the end of May at the age of sixty-eight years.

W. C. M.

WE much regret to see the announcement of the death, from heart failure, on June 5, of DR. A. M. KELLAS, of the Mount Everest Expedition.

Notes.

THE Albert medal of the Royal Society of Arts for 1921 has been awarded to Prof. J. A. Fleming in recognition of his many valuable contributions to electrical science and its applications, and especially of his original invention of the thermionic valve, now so largely employed in wireless telegraphy and for other purposes.

NOTICE is given by the University of London that the advanced lectures by Prof. A. D. Waller and Mr. J. C. Waller on "Experimental Studies in Vegetable Physiology and Vegetable Electricity," announced for delivery on June 15, 22, 29, and July 6, cannot now be given.

THE Importation of Plumage (Prohibition) Bill, as amended in Standing Committee, was read a third time in the House of Commons on June 10.

THE grant of 5000*l.* a year promised by the Government for five years to the Empire Cotton Growing Corporation (on condition that 90 per cent. of the cotton industry should agree to contribute by means of a voluntary levy on every bale of cotton imported into England, which agreement has now been obtained) is to be replaced by the grant of a capital sum of 1,000,000*l.* to the corporation. This announcement was made by Mr. Winston Churchill in Manchester on June 7. The capital sum in question is about a quarter of the total profits made by the British and Egyptian Governments from their joint control of the cotton supply during the war. These profits are being shared equally between the two Governments, and half the British Government's share is to be utilised for the promotion of Empire cotton.

THE Minister of Agriculture has announced the gift to the nation by Lord Lee of a large estate of 1300 acres, being part of the Chequers estate, of which 700 acres is farmland and the remainder woodland. The Ministry proposes that the main farm should be conducted as an example of the stock-rearing farm, showing how land of that character could be improved so as to produce the maximum output of livestock consistent with sound commercial agriculture. It is considered that the farm could be made a valuable demonstration of the growth and value of improved varieties of cereals and fodder crops and of the amelioration of grassland to be utilised for the intensive breeding and rearing of livestock, without departing from the prime economic purpose of any farm which is intended to guide the practice of the working farmer. At the same time it is hoped to come to some arrangement with the Bucks County Council, under which the Dropshort Farm could be utilised for more definitely educational purposes as the holding attached to a farm institute. It is a hopeful augury, and one not without significance, that future Prime Ministers should be able to see at their doors an example of agricultural education in being. Lord Lee's munificent donation adds to the debt of gratitude which the nation already owes him, and gives

the agricultural authorities an opportunity of carrying out work which has long been needed, and which they have long desired to do.

THE fifth International Rubber Exhibition was opened on June 3 by Sir Owen Philipps, M.P., at the Royal Agricultural Hall, Islington. Notable exhibits of rubber and other tropical produce were shown by commercial firms and by British overseas and foreign Governments, the colonial exhibits of the latter being particularly good. From the scientific point of view the display illustrating the mycological work which is being carried out under the auspices of the Rubber Growers' Association, and the fine exhibit of the Java rubber research stations, call for special mention. The most important feature of the exhibit of the Rubber Growers' Association was the effectively arranged demonstration of the discovery by the Botany Department of the Imperial College of Science and Technology that, in all probability, "brown bast" (the most serious disease of *Hevea brasiliensis*) is essentially a question of phloem necrosis. Sanderson and Sutcliffe (the latter a former student of the college), in their investigation of the anatomy of burr-formation, which is the principal external symptom of brown bast, had shown that the burrs result from the inclusion of areas of diseased laticiferous tissue in stone-cell "pockets" formed by the activities of wound cambiums. The recent work at the Imperial College, however, focusses attention upon the probability that the disease has its origin in an affection of the sieve-tubes (phloem), the symptoms described by Sanderson and Sutcliffe being a secondary development. The important information now available should be a step forward to the discovery of the causative factors of this baffling disease. Another series of preparations demonstrated the action of certain fungi (*Diplodia*, *Nectria*, and *Fusarium*) as wound parasites; cultures of fungi obtained from Hevea trunks were also shown. A further exhibition of the department comprised a series of seed-germination experiments, which showed that rubber seed which had failed to germinate was already infected with *Diplodia*, a fungus known to cause a disease of Hevea seedlings. Reference must also be made to the interesting exhibit illustrating the course of instruction in rubber technology which is being conducted at the Northern Polytechnic Institute, Holloway.

THE British Cast-Iron Research Association has been approved by the Department of Scientific and Industrial Research as complying with the conditions laid down in the Government scheme for the encouragement of industrial research. The secretary of the association is Mr. Thomas Vickers, Central House, New Street, Birmingham.

At the anniversary meeting of the Linnean Society of London, held on May 24 last, the following officers were elected:—*President*: Dr. A. Smith Woodward. *Treasurer*: Mr. H. W. Monckton. *Secretaries*: Dr. B. Daydon Jackson, Prof. E. S. Goodrich, and Dr.

A. B. Rendle. *Members of Council*: Prof. Margaret Benson, Prof. V. H. Blackman, Mr. E. T. Browne, Mr. H. Bury, Mr. S. Edwards, Prof. E. S. Goodrich, Dame Helen Gwynne-Vaughan, Sir Sidney F. Harmer, Dr. B. Daydon Jackson, Mr. C. C. Lacaïta, Mr. G. W. E. Loder, Mr. H. W. Monckton, Mr. R. I. Pocock, Capt. J. Ramsbottom, Dr. A. B. Rendle, Lord Rothschild, Dr. E. J. Salisbury, Mr. C. E. Salmon, Mr. Thomas A. Sprague, and Dr. A. Smith Woodward.

THE nineteenth annual meeting of the South African Association for the Advancement of Science will be held at Durban on July 11-16, under the presidency of Prof. J. E. Duerden, of Rhodes University College, Graham's Town. As in previous years, the association will meet in six sections, the presidents of which are as follows:—Section A (Astronomy, Mathematics, Physics, Engineering, etc.), Dr. J. Lunt, of the Royal Observatory, Cape of Good Hope; Section B (Chemistry, Geology, Geography, etc.), Dr. J. Moir, Chemist to the Mines Department, Johannesburg; Section C (Botany, Forestry, Agriculture, etc.), Prof. J. W. Bews, of Natal University College, Maritzburg; Section D (Zoology, Physiology, Hygiene, etc.), Prof. H. B. Fantham, of University College, Johannesburg; Section E (Anthropology, Philology, etc.), Dr. C. T. Loram, of the Natal Education Department; and Section F (Education, Sociology, History, etc.), Prof. W. A. Macfadyen, of Transvaal University College, Pretoria. The general secretaries of the association are Dr. C. F. Juritz, Department of Agriculture, Cape Town, and Mr. H. E. Wood, Union Observatory, Johannesburg. Capt. H. A. G. Jeffreys, P.O. Box 6894, Johannesburg, is acting as assistant general secretary. It is announced that the 1922 meeting will be held at Lorenço Marques under the presidency of Dr. A. W. Rogers, Director of the Geological Survey of the Union of South Africa.

EVIDENCE of considerable interest in relation to the character and distribution of Iron-age culture in the Balkan Peninsula has been obtained by Mr. Stanley Casson in the course of a journey through parts of Macedonia. This journey was undertaken under the auspices of a research committee, of which Sir William Ridgeway is chairman, of the British Association, appointed to excavate early sites in Macedonia. Starting from Dedeagatch, the port at the mouth of the Maritza River, Mr. Casson worked westward through Enos, Drama, and Cavala. He also visited Vodena and Ostrovo. Excavations were undertaken at Chouchitsa, which during the war was one of the rail-heads on the British Doiran-Vardar front. The "finds" included bronze ornaments, pottery, some gold, and a number of iron knives. The results of Mr. Casson's investigations of this area, of which little is known archaeologically, will be described in full in the Anthropological Section at the Edinburgh meeting of the British Association in September next.

THE lectureship established to commemorate the work of Mr. Moncreu Conway was held this year by Dr. A. C. Haddon, who selected as his subject "The Practical Value of Ethnology." After a preliminary survey of the relations of sociology and his-

tory to anthropology, Dr. Haddon proceeded to discuss the relations of peoples of the higher to those of the lower culture under the heads of Conduct, Control, and Care. In regard to "conduct," he urges that dealings between groups, as well as those between individuals, should be conducted with the greatest possible consideration for their several sentiments and prejudices. Under the head "control" he considers the value of the knowledge of anthropology to the statesman and administrator. By "care" he means the efforts which can be made to check the evil results which arise from the contact of the higher with the lower civilisation in the prevention of epidemics, the problem of the dying-out of native races, the avoidance of meddlesome interference, and so on. Problems of this kind are familiar to all ethnologists, but Dr. Haddon's exposition of the subject is admirable, and it is illustrated by an interesting selection of facts drawn from his wide knowledge of anthropological literature and practical experience as a traveller. The lecture deserves the careful attention which it is sure to receive from all who are interested in the advance of our common humanity.

AN interesting phase of the social life of Roman society in the Ciceronian age is described by Messrs. A. W. Van Buren and R. M. Kennedy in a paper contributed to the *Journal of Roman Studies* (vol. ix., part 1) on Varro's aviary at Casinum. Marcus Terentius Varro, author of the famous work on agriculture, "De Re Rustica," gives a long account of this building, which is here quoted and translated. It contained fish-ponds and duck-houses, the latter enclosed by fine gut nettings, and spaces shut off by nets for songsters, such as nightingales and black-birds, supplied with water by means of a small channel, while food was thrown to them under the net. Several of the elements which enter into the arrangement of Varro's aviary recur in a contemporary Pompeian painting from the villa of Julia Felix.

THE American Museum of Natural History has set a good example in founding a new journal for the publication of preliminary announcements and the description of new species. It is to be known as the *American Museum Novitates*. No. 1, which has just reached us, is devoted to an extremely interesting and stimulating survey of the evolution, phylogeny, and classification of the Proboscidea by Prof. H. F. Osborn, who within the compass of a few pages has provided food for thought and much debate for some time to come. All interested in palæontology will note with satisfaction that the author frankly rejects his earlier views in regard to *Mœritherium*, and subscribes to the opinion originally started by Dr. C. W. Andrews, of the British Museum, that it is to be regarded as an indubitable proboscidean. But they will probably fail to grasp the precise meaning of the author's contention that "the enlargement of the second upper and lower incisor teeth . . . presents a firm ground of affinity with a still unknown primitive Lower Eocene proboscidean-stem form. There the resemblance ends." We venture to think that when Prof. Osborn's studies of this remarkable fossil are

completed he will still further modify his conception as to the ancestral position of this animal, when the system of proboscidean classification proposed in this essay will be materially changed.

THE annual report of the Smithsonian Institution for the year ending June, 1918, contains as usual, in addition to the secretary's report, a valuable general appendix consisting of twenty-seven papers illustrating the more important developments in physical and biological science, among them being translations of contributions by foreign men of science. In one of these, "On the Law of Irreversible Evolution," Dr. Branislav Petronievics sets forth an exposition based on Lewis Dollo's own works of the principle that "an organism cannot return even in part to a previous condition already passed through in the series of its ancestors." Another translation is "The Fundamental Factor of Insect Evolution," by S. S. Chetverikov—a paper which was first published in Russian. The opposite direction of the paths of evolution of vertebrates and invertebrates is accounted for by assuming that the chitinous skeleton of insects enabled them to diminish continuously the size of the body and so to obtain for themselves an independent place among terrestrial animals while increasing in endless variations of form. The third translation included in the volume is "The Psychic Life of Insects," by E. L. Bouvier—a paper in which the author attempts to show that the predominance of instinctive activity among insects is due to the multiplicity of appendages, and that, in consequence, their main psychical task consists in engraving on their memory and in repeating instinctively the acts to which these organs are adaptable.

EXCELLENT photographs of the skull, mandible, cervical vertebrae, and fore and hind feet of the giant extinct marsupial *Nototherium*, found last year at Smithton, Tasmania, are published by Messrs. H. H. Scott and Clive E. Lord in their account of the specimen, which is now in the Tasmanian Museum, Hobart (*Proc. Roy. Soc. Tasmania*, 1920). *Nototherium* seems to have borne a dermal horn on the nose, and may have played the part of a rhinoceros in the marsupial fauna of the Australian region. Its feet, however, are peculiar, and closely resemble those already known in *Diprotodon*. Messrs. Scott and Lord discuss these features specially, but their use of English words and their style of composition are so unfamiliar that it is difficult to grasp their meaning.

In the *Brooklyn Museum Quarterly* for January, Mr. R. C. Murphy, the curator of natural history, continues his account of "The Sea-coast and Islands of Peru," dealing here with the Chincha Islands, and including a narrative by Dr. F. A. Lucas, who spent three months there on a guano ship in 1869.

PART 2 of the *Quarterly Journal of the Geological Society* for 1920 (vol. lxxvi.) is occupied by palæontological papers. Mrs. Eleanor Mary Reid describes two pre-Glacial floras from beneath the Boulder Clay of Castle Eden, on the Durham coast. By a careful comparison with French and Dutch deposits, the

author assigns one to the Middle and the other to the Upper Pliocene. She follows with "A Comparative Review of Pliocene Floras based on the Study of Fossil Seeds," the inspiration for which came from the work carried on by herself and her husband, the late Mr. Clement Reid, between 1904 and 1915. The general conclusion is that at the opening of Pliocene times a flora existed in western Europe which was closely allied to the living floras of far-eastern Asia and of North America; but this gradually disappeared, until, in the Upper Pliocene bed of Cromer, it was represented by only 0.74 per cent. of the plants examined. The succession of the floras is Pont de Gail (Cantal), which is practically Miocene; Reuverian (from Reuver, north-east of Roermond, Holland); Castle Eden (Durham); Teglian (from Tegelen, on the Meuse, south of Venlo, and north-east of Reuver, in Holland); and Cromerian (Norfolk). In the same issue of the journal Dr. F. J. North publishes a detailed study of the brachiopod genera *Syringothyris* and *Spiriferina*, which he finds to be unrelated. He establishes a new genus, *Tylothyris*, for McCoy's *Spirifera laminosa*.

In a paper on "The Nature of Palæozoic Crustal Instability in Eastern North America" (*Amer. Journ. Sci.*, vol. 1., p. 410, 1920) Dr. C. Schuchert connects considerable epochs of diastrophism with the close of geological periods. He urges that the latter are determined by changes of fauna, and the "quickenened evolution of the earth's plants and animals" is a response to altered conditions of the surface. Hence the unconformities after epochs of disturbance, such as the "Nevadian" epoch of mountain-building at the close of the Jurassic period, which affected the whole region from Lower California to Alaska, may fairly be taken as stratigraphical boundaries. It may be remembered that similar reasoning was put forward by Prof. T. C. Chamberlin in the *Journal of Geology* for 1909. Dr. Schuchert hesitates, however, at closing the Mesozoic era in America with the top of the Jurassic, and it is obvious that a review of the contemporary faunas throughout the world is necessary for a reasonable delimitation of the groups and systems.

THE utilisation of the artesian water resources of Western Australia is making progress. An article on the subject by Mr. A. G. Maitland appears in the *Mining Handbook* (Geological Survey Memoir, No. 1) issued by the Minister of Mines. Mr. Maitland maps the location of five artesian basins in Western Australia which vary much in size and importance. Most significant, as bearing on the pastoral possibilities of the State, is the so-called desert basin in the north-west covering the area usually known as the great sandy desert. The disposition of the rocks gives ideal artesian conditions, the water being, in the main, derived from the rainfall of the Kimberley district. The six or seven bores which have been sunk in this desert area have been sufficiently successful to give high promise for further operations. North of the Great Australian Bight artesian conditions seem to be favourable in the Eucla basin, but more investigation is required. In five out of thirteen bores the water rose freely.

At the request of the American Geographical Society, Sir John Scott Keltie has prepared a short report on "The Position of Geography in British Universities" (Research Series No. 4). Sir John Keltie, in addition to giving some details for each university, reviews briefly the history of geographical education in Great Britain, and shows that considerable progress has been made in this country since his well-known report on the subject in 1885. At that date geography was practically unrecognised in British universities, while at present there are only two universities in England and one in Scotland in which there is no separate department in geography. Despite this progress, much remains to be done. In many universities the departments are understaffed, and the subject has a hard, and not always successful, fight to find its due place in the curricula. There is diversity of opinion regarding the scope of the subject and methods of treatment. In a few universities the subject is in both the faculties of arts and sciences, but in some it is only in arts. The addition of degrees in commerce has resulted in increased demand for geography, but on somewhat restricted lines, which cannot do justice to the subject. Sir John Keltie thinks there is need for geography to limit the field of its operations and to avoid the embarrassment of overcrowding.

THE Ministry of Finance, Egypt, has recently issued a Blue Book embodying the programme and policy of the Egyptian Government in regard to the development of the oil resources of that country. The chief point of interest in the publication is the defence put forward by the Under-Secretary of State for Finance, Mr. E. M. Dowson (under whose name the book appears), in support of the policy of State boring for oil determined upon in 1919. In other words, the justification of the expenditure of public money on petroleum mining in Egypt is pleaded in view of the growing scarcity and enhanced price of oil fuel as a measure of internal economy and as an attempt to further the scientific development of the oil resources of the country. State enterprise in such a risky business as oil-finding is usually to be deplored, but there are certain factors to be recognised in the political elements here engendered which not only warrant some co-ordinated efforts to deal with a difficult situation, but also make it essential that some authoritative scheme should be adopted to stabilise the oil industry of the country. The present policy includes the reservation of certain likely petroliferous areas for the Government as a result of a preliminary geological survey; such areas include Abu Durba, the west coast of Sinai, several isolated areas in northern Sinai, two smaller areas on the west coast of the Gulf of Suez at Ras Dib and Zeit Bay, and a larger area at Abu Sharr adjoining the better-known Hurghada field. The location of a commercially productive field in any one of these areas would justify, at any rate from a Government point of view, all the expenditure entailed in obtaining, transporting, refining, and distributing the oil. Failure, on the other hand, will be severely criticised, not only at home in Egypt, but also abroad. The scientific results accruing from the borings, however, must have considerable value in the task of

assessing the oil potentialities of the country, but ultimately it will be for the Egyptian people to pass judgment on a policy the merits or demerits of which as yet remain to be substantiated.

In the *Radio Review* for May Mr. T. L. Eckersley concludes his inquiry as to whether the errors in the apparent bearings of radio stations from which messages are received at night can, in whole or in part, be explained by the existence in the atmosphere of an outer conducting layer which he calls "the Heavyside layer," at the under-surface of which the electric waves are reflected. He thinks that the existence at night of such a reflected wave-train must now be taken as proved, and proposes to determine by measurement whether there is any component of the electric force horizontal and perpendicular to the plane of propagation. If this proves to be the case, the surface of the conducting layer at which reflection takes place cannot be taken as horizontal. Mr. Eckersley is disposed to think that in many cases the reflection is of this kind. The influence of the layer in the daytime is less marked, as it extends down to the ground and produces absorption of the waves propagated through it. In the night it has a more or less sharp under-boundary, at which reflection can take place and the waves are confined almost entirely to the layer of air underneath.

THE February issue of *Radium* contains a report of the Leonard prize for research recently instituted by the American Röntgen Ray Society. The prize, which commemorates the name of Dr. C. Lester Leonard, a victim to X-rays, is for the best piece of original research in the field of X-rays, radium, or radio-activity, and is of the value of 1000 dollars. This competitive award is open to anyone living in the western hemisphere. In the same issue notice is given of a correspondence course in the physics of radio-activity suitable for the needs of biologists and surgeons as well as of physicists. The course is being arranged by Dr. N. E. Dorsey, of Washington, consultant to the National Bureau of Standards.

DR. C. E. K. MEES, director of the research laboratory of the Eastman Kodak Co., Rochester, N.Y., contributes to the *Journal of the Franklin Institute* of May 21 an excellent summary of the present knowledge of the structure and many of the properties of photographic films before and after use. Concerning the unexposed emulsion, the silver bromide particles are crystals belonging to the regular system. They show evidence of strain, perhaps because there is absorbed in them some other substance, such as silver iodide, soluble bromide, or gelatine. The sizes of the crystals are determined during the formation of the silver salt when making the emulsion, and their diameters range from ultra-microscopic particles below 0.1μ to occasional grains up to 10μ . The curve relating the sizes of grains to the number of each size present is probably closely related to the "characteristic curve" of the emulsion. Grains of the same size may vary in sensitiveness, and the sensitiveness of grains of different sizes in the same emulsion may vary from group to group. A geometric relation between the sensitiveness of grains of different sizes is

sufficient to account for the properties of emulsions prepared in different ways. The author treats of the character of the developed image, and distinguishes between the graininess due to the individual particles of silver, the aggregations of these particles, and the agglomeration of these primary aggregations. The sharpness of the image is discussed, curves showing the quantitative values of these properties are given, and the methods by which these properties have been investigated are described.

YEAR BOOK No. 19 of the Carnegie Institution of Washington contains the nineteenth annual administrative report of the president, together with the reports on investigations and projects submitted by the various departments of the institution. Two sections of the presidential address, the financial records and the list of the institution's publications for the year, disclose some interesting facts. The total income available for the year ending October 31, 1920, was roughly 388,000l., and of this sum about 278,000l. was allotted to the various departments. The Department of Terrestrial Magnetism received the biggest

grant, some 51,000l., while Mount Wilson Observatory received 45,000l., and the Geophysical Laboratory the notable sum of 31,000l. Another large item in the expenditure was the production of the well-known publications of the Carnegie Institution, of which twenty-two were issued and a further eight authorised for publication during the course of the year; this work absorbed some 17,000l. The bulk of the Year Book is devoted to reports showing the progress of investigations carried on during the year; reports of directors of departments are given first, followed by reports of recipients of grants for other investigations, the latter being arranged according to subject.

THE latest catalogue (No. 415) of second-hand books offered for sale by Mr. F. Edwards, 83 High Street, Marylebone, W.1, deals with works relating to British and foreign birds, and natural history voyages and travels. It contains nearly 400 items, many formerly the property of the late Dr. F. du Cane Godman, and several choice and scarce works. It will appeal to ornithologists. The catalogue is to be obtained upon application.

Our Astronomical Column.

DR. HILL'S CUSPED ORBIT.—Dr. Hill in his "Researches on the Lunar Theory" described a certain case of satellite motion in which the orbit of the satellite relatively to the primary was cusped at first and last quarter. The period of such a satellite in the earth's case would be 205 days. Dr. Hill supposed that this was the orbit of maximum lunation, but M. Henri Poincaré later showed that still larger orbits were possible, with loops replacing the cusps.

Astr. Nach. No. 5101 contains a paper by Prof. T. J. J. See quoting results of the late Dr. John N. Stockwell, in which the latter claimed to have shown that Dr. Hill's cusped orbit was erroneous and should be replaced by a flattened oval with a period of lunation of $247\frac{3}{4}$ days. He further asserted that Jacobi's integral (used by Dr. Hill) was based on incorrect mechanical principles. Both Prof. See and Dr. Stockwell appear to have overlooked a paper by R. Moritz in *Mon. Not. R.A.S.* for November, 1917, in which the latter re-investigated the cusped orbit of Dr. Hill by the method of mechanical quadratures used by Dr. P. H. Cowell for the eighth satellite of Jupiter and for Halley's comet. Needless to say, this method is independent of Jacobi's integral, and involves nothing beyond the elementary principles of accelerated motion. The result has led to the detection of a few unimportant numerical errors in Dr. Hill's work, but the accuracy of the cusped orbit is substantially verified. If Dr. Hill's figures had been rigorously exact, the minimum distance of the satellite from the earth would have been attained when the angle of motion relatively to the sun was exactly 90° from the cusp. The actual figures given by the quadrature method are $90^\circ 6' 51''$. The error is mainly due to the small errata in Dr. Hill's work, though a little may be ascribed to the inevitable cumulative error of mechanical quadratures. It would therefore appear that Dr. Stockwell's method must involve some fallacy, since the orbit that he gives for a period of $208\frac{3}{4}$ days is of quite a different shape from the cusped orbit, and differs little from an ellipse.

STONYHURST COLLEGE OBSERVATORY.—We have received the annual report of this observatory from the director, the Rev. A. L. Cortie, S.J. The regular observation of the sun has been continued, and the results show a steady decline in spot-activity; the disc being without spots on four days in September last for the first time since 1916. The director communicated a paper to the British Association at Cardiff on the connection between faculæ and calcium flocculi, showing that the correlation of the two is so close that the faculæ are probably the bases of the flocculi.

It will be remembered that on a former occasion Father Cortie dwelt on the importance of the latitude of sun-spots as an index of their magnetic effect on the earth. This was borne out by the spot of last month, which, although not at all abnormal in its extent, passed very near the centre of the disc, producing great magnetic disturbance and extremely bright auroræ.

The report contains an obituary notice of Bro. W. McKeon, S.J., who died on May 18, 1920. He was on the observatory staff for forty-two years, the majority of the drawings of spots made at the observatory being his work.

"L'ASTRONOMIE ET LES ASTRONOMES."—M. Auguste Collard, librarian of the Royal Observatory of Belgium, has published a useful bibliography under this title, which forms a brochure of 119 pages. It is divided under the headings: (1) Dictionaries and Encyclopædias of Astronomy; (2) Biographies of Astronomers; (3) Treatises on Astronomy, subdivided into many sections; (4) Histories; (5) Bibliographies; (6) Atlases; (7) Reviews; and (8) Tables.

The works under the various headings are not arranged in alphabetical order, but there are alphabetical indices at the end. There are also in many cases brief notes summarising the scope of the work, which are a useful supplement to the mere statement of the author's name and the title. The book promises to be useful; it is one of a series of similar works of reference published by G. Van Oest et Cie, National Library of Art and History, Brussels.

Prof. Einstein's Lectures at King's College, London, and the University of Manchester.

THE most noticeable circumstance in the lecture which Prof. Einstein delivered on June 13 at King's College on "The Development and Present Position of the Theory of Relativity" was the beauty and simplicity of his account of the theory. He made no attempt to enliven it by introducing any of the delightful illustrations which, however illuminating and attractive they may be to the popular mind, surround it with a halo of scientific romance. On the other hand, he found no occasion to have recourse to the blackboard, and he entirely omitted anything which required mathematical formulæ for its expression. He seemed, too, with earnestness and obvious sincerity to disclaim for himself any originality, and he deprecated the idea that the new principle was revolutionary. It was, he told his audience, the direct outcome and, in a sense, the natural completion of the work of Faraday, Maxwell, and Lorentz. Moreover, there was nothing specially, certainly nothing intentionally, philosophical about it. The whole theory was experimental in its origin, and the satisfaction it brought was simply in the fact that it put us in possession of a method of scientific research which not only did not bring us into conflict with observed facts, but also positively accorded with them.

The most absorbing part of the lecture was the exposition of his concept of our universe as being spatially a closed system and yet boundless. In this connection he referred to the work of Ernst Mach, who had been the first to direct attention to a distinct point in which the Newtonian theory of motion is unsatisfactory. It led Mach to endeavour to alter the mechanical equations so that the inertia of bodies should be attributed to their relative motion with reference, not to Newton's fictitious absolute space, but to the sum total of all other measurable bodies.

Prof. Einstein's modesty served only to give force to the impression which all received, and which Lord Haldane (who presided) admirably expressed, that we were welcoming not only one who is himself a man of genius, but one whose discovery is to be ranked with those of Newton, Galileo, and Copernicus—discoveries which in revolutionising thought have turned scientific inquiry in a new direction and enlarged the scientific horizon. In one aspect, as Lord Haldane pointed out, Einstein's revolution is more profound than that of the greatest of his predecessors, for while Copernicus and those who followed him corrected our deductions from phenomena within a generally accepted framework, Einstein has shown us the need of reconstituting our conception of that framework itself. It is not of choice, but of necessity, that the principle of relativity has raised a problem, and that the profoundest problem, in metaphysics—the problem of the relation of reality itself to knowledge.

After the public lecture Prof. Einstein was the guest of the Principal of King's College at a dinner given in the college. The Principal's guests included Lord Haldane, the Dean, the Vice-Principal, and many of the professors of King's College, the Astronomer Royal, Prof. Eddington, Prof. Lindemann, Prof. Whitehead, and others. In responding to his health, Prof. Einstein made an interesting revelation of his attitude to the quantum theory. This theory was, he said, presenting a difficult problem to physics, but the very nature of the difficulty served to bring into relief the attractiveness and satisfaction of the principle of relativity. That principle had served to give a simple and complete explanation of experimental facts which under any other aspect were discordant. In the quantum theory as it stood at present we were faced with discordant experimental facts, and were searching for the principle on which to interpret them.

The Adamson lecture was delivered at the University of Manchester on Thursday, June 9, by Prof. Einstein, who had been invited by the council in accordance with a Senate recommendation passed on February 3. At the opening of the proceedings the honorary degree of D.Sc. was conferred on Prof. Einstein. The lecture, which was delivered in German without an interpreter before a very large audience, was on the theory of relativity, and dealt in particular with the relation between geometry and physics. Prof. Einstein described how geometry had developed from a collection of individual theorems discovered empirically to a body of doctrine in which the logical connection between these theorems is perceived and explained. The logical structure required as its foundation a set of axioms, which constitute the residue of empiricism in the theory. The axioms of Euclid acquired such authority that in time they came to be regarded as necessities of human thought owing to the inherent nature of the mind, and thus the illusion was created that Euclidean geometry is free from anything empirical or arbitrary. On applying geometry to physics the tacit assumption was made that lengths measured by and on solid bodies correspond to lengths in Euclidean geometry. Prof. Einstein showed how the gradual discovery, through physical experiment and observation, of the fact that for objects of astronomical dimensions the axioms of Euclid do not hold good, had led first to the special, and then to the general, theory of relativity. He devoted the latter part of his lecture to the exposition of a non-Euclidean geometry (interpreting geometry in the sense of the theory of the possible positions of objects in space) in a plane, the objects in the plane being shadows of circular "beetles" inhabiting a sphere, the source of light being on the sphere, and the plane being a tangent plane at the opposite end of the same diameter.

Physico-chemical Problems Relating to the Soil.

THE Faraday Society held a general discussion on May 31 on physico-chemical problems relating to the soil. Sir Daniel Hall, in taking the chair, said that the papers to be presented would show that physico-chemical studies of soil were now as necessary as those of a purely chemical or physical nature:

Dr. E. J. Russell, director of the Rothamsted Experimental Station, in opening the discussion, gave a general review of the phenomena associated with the four main headings into which the subject was divided:—Soil moisture, organic constituents of the soil, adsorption phenomena, colloidal phenomena, etc.

The section on soil moisture was opened by Mr.

B. A. Keen (Rothamsted), who dealt with the system soil-soil moisture, and pointed out that it was necessary to assume a complex colloidal coating over the soil-grains. The paper concluded with an account of the quantitative relations brought out by the freezing-point method of examining soil solution. Prof. Sven Odén (Stockholm), in a note on the hygroscopicity of clay, showed that the hygroscopicity of soils was not necessarily proportional to the total surface area of the particles. Prof. Hoagland (University of California) and Prof. Shull (University of Kentucky) forwarded papers dealing with the relation between the soil solution and the plant. The former dealt mainly

with the seasonal variations of the salts in the soil solution and with the absorption of nutrient elements by the plant, and the latter with the mechanism of osmotic phenomena associated with the root-hairs of the plant.

In the discussion of this group of papers Dr. Hackett dealt with the capillary rise of water in soils, and Mr. Wilsdon mentioned some interesting experiments on hygroscopicity and osmotic pressure.

The second group of papers, on the organic constituents in the soil, opened with a review by Mr. H. J. Page (Rothamsted) of the nature and properties of the organic matter and its influence on soil moisture, soil temperature, and the reaction, composition, and concentration of the soil solution. Prof. Odén gave an account of his important researches on humus from peat soils, in which he has shown that the term "humic acid" is chemically correct. Dr. E. J. Salisbury (University College, London) described experiments on the relations between organic matter and the vertical distribution of acidity in natural soils.

In the discussion Dr. Ormandy directed attention to the necessarily complex nature of the material used in Prof. Odén's experiments, and suggested that parallel experiments on a simpler substance like china-clay would be useful.

In the third section—adsorption phenomena—Mr. E. M. Crowther (Rothamsted) dealt with the measurement of the hydrogen-ion-concentration of acid soils, both electrometrically and with the indicators used by Clark and Lubs. Mr. E. A. Fisher (Leeds University) critically discussed the application of the adsorption formula to soil problems, in view of the empirical nature of the equation and the facility with which, by numerical modifications, it can be used to fit experimental data of phenomena which cannot be related. He showed that the modified form of Way's chemical theory, which assumes exchange of bases by double

decomposition between silicates and added salts, would account for the observed phenomena.

Dr. Russell in the course of the discussion referred to the necessity for taking account of the colloidal material known to exist in soil and the consequent difficulty of accepting an exclusively chemical explanation of base exchange.

A paper in this section by Mr. C. T. G. Morison (School of Rural Economy, Oxford) on pan formation was taken as read, as was also Dr. Mellor's introductory paper in the concluding section—colloidal phenomena—on the plasticity of clays from the ceramic point of view. Prof. Odén gave an account of his work on clays as disperse systems. He described the apparatus employed, which consists essentially of a balanced plate on which the suspended particles slowly settle, the gradual increase in weight being automatically recorded. Mathematical analysis of the data enables a distribution curve to be constructed, giving the percentage of particles present between any specified range of diameters.

Mr. N. M. Comber (Leeds University) dealt with his suggestive experiments on the flocculation of soils, in which the difference between silt and clay was shown, and the conclusion drawn that clay is protected by an emulsoid of a siliceous nature.

In the concluding paper Mr. G. W. Robinson (University College, Bangor) indicated certain physical constants of soil which would be of great help when employed statistically in soil surveys.

The forthcoming publication of the papers and discussion by the Faraday Society will be of use not only to soil investigators in general, but also to members of bodies such as the Association of Economic Biologists and the Agricultural Education Association, which, among others, were invited by the Faraday Society to co-operate in the discussion.

B. A. K.

British Science Guild.

NOTABLE VIEWS ON PRESENT-DAY PROBLEMS.

WELL-KNOWN leaders of scientific thought discussed the difficult and pressing problems of the times with hopefulness, sagacity, and insight at the fifteenth annual meeting of the British Science Guild, held at the Goldsmiths' Hall on Wednesday, June 8. The president (Lord Montagu of Beaulieu) was in the chair, and there was a large and representative assembly, which welcomed with much gratification the announcement that his lordship had consented to occupy the presidency for another year.

The president, in opening, expressed their sincere sense of loss at the death of Sir Norman Lockyer, who not only took a great interest in the work of the Guild, but was also one of its most distinguished founders. They had also sustained another serious loss in the death of Sir William Mather. During the past year the Guild had given consideration to many matters of importance to scientific workers. They held that civil servants in these days ought, at any rate, to be of scientific mind or appreciate science, even though they might not be highly educated in science itself. The work of the State year by year needed more and more scientific handling and treatment, and the Civil Service as a whole should be encouraged to consult scientific men and to have recourse to scientific advice when occasion demanded. They had tried to spread their influence from London to the provinces, and so far had been very successful. They were doing their best to bring in great provincial centres, which in many ways were more promising scenes for scientific education than London

itself. He was sorry they could not announce that day what they hoped last year would be the case—a conference with the representatives of Labour. They thought they had better wait for a calmer state of things before they asked either Capital or Labour or representatives of the State to consider their mutual relations to each other and to science. He thought they ought to ask themselves in regard to the generally unsettled state of the country, in fact of nearly all civilised countries to-day, whether it was possible to go on putting up our scale of living for all classes and to reduce our hours of work at the same time; and, what was more serious in many cases, reduce the output more than in proportion to the number of hours put in. It was quite certain that in this country, if we were to compete with the world and maintain a high standard of living at the same time, we must increase our output per man of machine work even if we worked shorter hours. That was a very difficult problem to solve, but he did not despair with the help of science, in some trades at any rate, of its solution. Then they had to aim at the better education of all classes in scientific facts and inculcate more and more the scientific habit of mind. But our system of education must be less of the parochial and insular kind and more scientific, broad, and world-wide in outlook. The difficulty to-day, he thought they would agree, was that in many of the great subjects which they had to consider facts were very difficult to get at. Science aimed at the truth, and in social and political matters, as well as in scientific matters, if they knew the real facts, a

solution was not always easy, but at any rate it was made much easier. Education was the great hope of the future, and in that education science must play a prominent part.

The annual report of the executive committee having been adopted, on the proposition of Lord Avebury, seconded by Sir John Cockburn, Dean Inge delivered a striking address entitled "The Road to Ruin and the Way Out." It was obvious, he said, that the first half of the subject was easier than the second. The road to ruin was the road along which we were travelling; the way out was not easy to find, and possibly difficult to follow. It was useless to utter mere jeremiads, and it took a great deal to destroy a powerful nation. Medical science taught that the more acute and violent the disease, the more vigorous was the production of anti-toxins, and it added the comforting assurance that if the constitution survived an invasion of poisonous microbes the patient would probably have acquired immunity for a considerable time to come against that particular disease. Perhaps it might be so in our social and political life. Very few politicians and sociologists allowed nearly enough for the swing of the pendulum. The false doctrine of continuous progress had led most of us to treat the flowing tide as a permanent encroachment of the sea. The direction in which the tide was flowing was called "progress," the opposite direction "reaction." History should have taught us better. Political experiments were welcomed enthusiastically until they had been tried; when they were in operation disillusionment began at once. The more revolutionary the change, the quicker was the process of conversion, so that it was almost a commonplace that the young firebrands of a revolutionary age—men like Wordsworth, Coleridge, Southey, Carlyle, and Ruskin—often ended as uncompromising Tories. We had not by any means done with aristocracy and monarchy in Europe. Human nature remained the same, and it tried one way after another to misgovern itself and mismanage its affairs. The first thing necessary was diagnosis. It was obvious that the most ruinous feature of modern society was the strike. This country depended for its very existence on being able to export manufactures to pay for imported food, and our power of exporting manufactures was rapidly disappearing. No scheme of "redistributing" property, however drastic and iniquitous, could have the slightest effect in preventing the starvation of a country which could not feed itself and would not work under economic conditions. There were two forces available which could bring a country out of the worst of holes. These were science and religion. They in that Guild were chiefly concerned in the application of scientific knowledge and scientific method to British industry. We were always abusing ourselves for being behind the time—so unlike the Germans, for example. That was the British lion's little way; he was always lashing himself with his tail and calling himself a fool and a slacker, until foreign nations came to believe him. When they tried conclusions with him they found that he was by no means such a fool as he looked, and they complained that it was very unfair. Still, he had no doubt that this Guild would continue to find plenty to do. But behind scientific method there was something deeper—scientific faith and the scientific temper. They must not shut their eyes to the fact that science had many enemies; science as such was disliked by many people. But science had one enormous advantage over its old enemies—it had the nature of things on its side, and wherever it was disregarded and disobeyed it did not talk, but struck. Dame Nature was a good teacher, but her fees were high. It was

worth a great deal to impart the scientific way of looking at things—the scientific conscience (should he call it?) in education. He was himself an enthusiastic humanist, and he should be sorry indeed if science were to oust humanism in our education; he should be sorry for the sake of science itself, for a man could scarcely be a scientific worker without being also a humanist; but science we must have as a part of everyday training. Only he would suggest that the faith and temper and conscience of science were a more important acquisition than any mere facts. We wanted to teach the next generation to respect all facts wherever they might find them. A scientific training marked a man who would not commit his soul and his conscience to the keeping of anyone, whether priest or Labour official. We needed this independence badly; some whole classes were in danger of losing it. The other force that might help us out of the mud was religion or, as he should prefer to say, Christianity. The fundamental message of Christianity was that we must get our values right, and that if we got our values right nothing else would be seriously wrong. Science was daughter to one of the absolute and eternal values—truth; art paid its homage to another—beauty; and morality to the third—goodness. Religion consecrated and endeavoured to humanise those three absolute values which it regarded as revelations of the nature and character of God. Our generation might be very stiff-necked and perverse, but sooner or later wisdom would be justified of her children. They must just go on giving their testimony, whether men would hear or whether they would forbear. "The mills of God grind slowly, but they grind exceeding small."

Sir Richard A. S. Redmayne (chairman of the Imperial Mineral Resources Bureau) next spoke on "The Importance of Research in the Development of the Mineral Industries." He remarked that the cessation of hostilities was succeeded almost at once by a period of feverish industrial activity—it would be erroneous to apply the words "general prosperity"—to be followed by a cycle of great depression. The demand for goods was great, but production was falling. What was the explanation? It lay, he thought, in a combination of circumstances:—(1) A feeling of insecurity due to unsettled political and financial conditions. Hence a disposition to conserve rather than to utilise in commercial ventures such capital as is available. (2) The incidence of the rate of exchange. (3) The high cost of production consequent on the high cost of living and the higher standard of comfort demanded by the labouring classes (and rightly so demanded) than formerly obtained. (4) The lower, and still apparently decreasing, productive power of Labour. The first two conditions would in part right themselves in process of time as the various political problems were solved, or partly solved, and rates of exchange would then tend towards the normal; but a very great deal depended upon the last two conditions, as the future position of production was not easy to forecast. Higher and cheaper production were difficult desiderata to obtain in view of the high rate of wages now ruling and the diminishment in working time either achieved or claimed by the manual workers of the day, and these were demands which were not likely to show much abatement in the future. What was the solution? The answer he ventured to give was "research," to discover by research cheaper means of production, and, by research, to create new outlets. How should research be organised and carried out? Empirical investigations must be based upon a scientific foundation if they were to be of ultimate and practical value. It had, however, been well said that if an investigator did not possess the inventive as well as the purely

scientific faculty, the value of the work was apt to be largely lost. The discovery of new things was one matter, and was a characteristic of the academic type of mind; the discovery of new uses for things was another matter, and was typical of the commercial mind. In this work of research the universities were peculiarly fitted to take an important—a leading—part. The research should not necessarily be pursued along definite lines with a definite object in view; the great discoveries were not made in that way. The Department of Scientific and Industrial Research might well endow university scientific research on chemical, metallurgical, and engineering work, supervising and co-ordinating and publishing the results. Effort was largely commensurate to the prize offered, and the discoverer should be rewarded for his labour and genius; but that would be a matter easy of arrangement. Research associations undoubtedly performed useful, even highly valuable, functions, but the wind of science bloweth where it listeth, and the time was ripe for a realisation of the fact that scientific research could not profitably be hampered by restrictions confining the efforts of those who were employed therein. It was of the essence of research that it should be free and untrammelled.

Sir Richard Gregory proposed a vote of thanks to the speakers, and remarked that the addresses of their two distinguished new vice-presidents were of a very inspiring and instructive character. Dean Inge had referred to the fact that a disease produced in the organism an anti-toxin to fight it, and the anti-toxin, Sir Richard suggested, that existed now for certain social diseases was the British Science Guild. It was really a British Efficiency Guild, and in the forefront of its activities must be the promotion, not only of research, but also of the application of research. We had numerous scientific societies, each of which was concerned with adding to scientific knowledge by research, but there was no society or organisation in the kingdom which existed, as the Guild existed, to see that knowledge thus gained was made good use of for national welfare. That was why the Guild could perform a most useful service in bringing before the public the value of research, science, truth, and righteousness to a nation that desired to maintain a leading position in the world. The trade unions referred to by Dean Inge and Sir Richard Redmayne were not trade unions, but wage-unions. If they were really trade unions, and if Labour were united with science to increase production instead of merely scrambling for pence on a Tom Tiddler's ground, then together they would be the greatest force in our Constitution.

On the proposition of Lady Lockyer, hearty thanks were also accorded to the Warden and Court of Assistants of the Worshipful Company of Goldsmiths for the use of their hall. Lady Lockyer paid a graceful tribute to the munificence of the Goldsmiths' Company in educational and other directions, and made an appeal to those who were not members of the British Science Guild to become associated with it, whether they were scientific workers or not.

University and Educational Intelligence.

CAMBRIDGE.—Mr. E. K. Rideal, Trinity Hall, has been appointed to the Humphry Owen Jones lectureship in physical chemistry. Dr. L. Cobbett, Trinity College, has been re-appointed University lecturer in pathology.

The Rede lecture was delivered on June 9 by Sir Napier Shaw on "The Air and its Ways." The

lecturer likened the atmosphere to a steam-engine, for which the heated surface of the earth and sea acted as boiler, the cold polar regions and the cold upper air as condenser, and the normal winds and cyclonic depressions as flywheel. The normal winds were the equatorial belt of air passing westwards and the circumpolar motion of the upper air travelling eastwards. Between them were the anticyclonic circulations which, like the driving-belts of tanks, carried forward the westward moving air of the equatorial, and the eastward moving air of the polar, circulation.

MANCHESTER.—At the meeting of the council of the University on June 8 the following appointments were made:—Miss Winifred S. Clarke, lecturer in education; Miss May A. B. Herford, lecturer in classical archaeology; Mr. S. Williams, assistant lecturer in botany; Mr. W. Cartwright, assistant lecturer in metallurgy; Mr. P. I. C. Gibson and Mr. A. Haworth, demonstrators in pathology; and Miss Georgina May Duthie and Mr. R. C. Shaw, demonstrators in anatomy.

Mr. W. E. Alkins has resigned his appointment as lecturer in metallurgy as from September 29 next.

OXFORD.—Mr. W. Brown, Christ Church, has been elected Wilde reader in mental philosophy.

ST. ANDREWS.—The honorary degree of LL.D. is to be conferred on July 12 upon the following:—Prof. W. M. Bayliss, Sir William Henderson (chairman of Dundee Technical College), Emeritus Prof. D. Macewan, and Prof. A. N. Whitehead.

THE University of Wales has decided to confer the honorary degree of D.Sc. upon Prof. T. W. E. David, Sir J. J. Dobbie, and Prof. A. Gray.

MR. R. J. PYE-SMITH, formerly professor of surgery in the University of Sheffield, has bequeathed the sum of 1000*l.* to the University in question for a chair in surgery.

MR. A. MACCULLUM, of Edinburgh, who gave 25,000*l.* during his life towards the erection of the new Royal (Dick) Veterinary College buildings in Edinburgh, has bequeathed, under certain conditions, on the death of his wife, a further sum of 10,000*l.* for equipping and furnishing the college buildings.

THE following appointments have been made in connection with the Royal College of Surgeons of England:—Dr. F. W. Edridge-Green, Mr. V. Z. Cope, and Prof. T. Swale Vincent, Arris and Gale lecturers; Prof. S. G. Shattock, Erasmus Wilson lecturer; Sir Arthur Keith, Arnott demonstrator; and Sir Charles A. Ballance, Thomas Vicary lecturer.

THE London School of Economics and Political Science is prepared to award one or more post-graduate studentships, of value up to 200*l.* a year for one or two years, to suitable candidates who wish to combine research with a certain amount of teaching at the school, or to follow approved courses of study with the view of qualifying themselves for such teaching. Applications, stating qualifications and giving two references, should be made as soon as possible to the Director, London School of Economics and Political Science, Clare Market, London, W.C.2.

THE Selborne Society has issued a list of lectures, most of them illustrated by lantern-slides, which its lecturers are prepared to give during the coming

winter season. The officers of the society deliver five lectures dealing with its objects and activities, e.g. Gilbert White and Selborne, the Brent Valley bird sanctuary which the society has recently secured, the value of science to the community and suggestions for the organisation of natural history societies, and archaeological and historical rambles. Beyond these official lectures there is available a long list of lecturers who cover a wide range of subjects. Prof. J. R. Ainsworth-Davis lectures on science and agriculture; Capt. W. H. S. Cheavin on nature study, particularly in its microscopic aspects; the Rev. J. T. W. Claridge on stars and comets, and he also gives a historical lecture entitled "Some Famous Astronomers"; Mr. O. H. Latter deals with the nature study of sand dunes, wasps, and evidences of evolution; Prof. J. T. MacGregor-Morris lectures on electricity in home-life and in nature; Mr. F. Martin-Duncan deals with the natural history of the sea and the forest, and particularly with the insect world; Mrs. R. A. Proctor lectures on astronomy in everyday life and the story of the moon; Mr. J. J. Ward deals with pond-life, insects, animal life and evolution, and the wonders of wild and garden flowers; Mr. W. M. Webb, in addition to the lectures on the objects of the Selborne Society, which as general secretary of the society he delivers, also gives lectures on evolution in dress and plumage, mimicry, and protective resemblance in animals. Such is a selection from the list of the better-known lecturers. Further information regarding the lectures can be obtained from Mr. P. J. Ashton, extension secretary, 72 High Street, Bromley, Kent.

IN view of the announcement made in NATURE of April 14 last, p. 220, that the Finsbury Technical College will not be closed in July next, it is of interest to read the correspondence which passed during last winter between the City and Guilds Institute and the London County Council on the subject. It has been published in full in the forty-first annual report of the council of the City and Guilds Institute, and is preceded by a statement by the council on the circumstances under which it was decided to close the college. In the face of the decision of the London County Council to make the Northampton Polytechnic its engineering school and the tendency of the policy of the Board of Education to substitute public for private effort in education, it was not considered feasible or practicable to raise the 13,000*l.* per annum required in excess of pre-war expenditure. However, towards the end of last year the education authorities of the London County Council reviewed the matter, and decided that since a depletion of the facilities for technical education was highly undesirable they would assist the college. Various minor conditions have been imposed, but in effect the London County Council will contribute a sum of 10,000*l.* per annum for five years provided that the City and Guilds Institute finds 3500*l.* per annum for a similar period for the maintenance of Finsbury Technical College. The council of the City and Guilds Institute expresses the hope that the City Corporation and the contributory livery companies will continue to give their support in order to make possible the development of their educational schemes. An interesting list in the report is that showing the contributions made yearly to the institute since 1878. The Goldsmiths' Company heads the list with contributions amounting to 275,508*l.*; then come the Clothworkers', Fishmongers', and Mercers' Companies with gifts ranging from 152,000*l.* to 101,000*l.* The remainder of the report is devoted to a review of the academic activities of the City and Guilds (Engineering) College during the year 1919-20.

Calendar of Scientific Pioneers.

June 16, 1889. Gaetano Cacciato died.—The able director of the Palermo Observatory, in which position he succeeded his father in 1843, Cacciato extended the observatory and contributed memoirs to the Società degli Spettroscopisti.

June 18, 1816. Thomas Henry died.—Henry was a Manchester apothecary, the translator of Lavoisier's chemical essays, and the first to observe the use of carbonic acid to plants. In 1781 he became the first secretary of the Manchester Literary and Philosophical Society, and in 1807 was chosen president.

June 18, 1905. Per Theodor Cleve died.—Professor of chemistry in the University of Upsala, Cleve was well known for his researches on the rare earths. He investigated the compounds of yttrium, erbium, thorium, lanthanum, and didymium, and he showed that scandium, discovered by Nilson, was identical with the ekaboron of Mendeléeff.

June 19, 1715. Nicolas Lemery died.—The contemporary of Mayow and Homburg, Lemery wrote a "Cours de Chimie," which was translated into various languages and passed through thirteen editions in his lifetime. This work, from which the fancies of the alchemists were excluded, was one of the first in which chemistry was divided into organic and inorganic. Lemery was a Paris apothecary.

June 19, 1820. Sir Joseph Banks died.—For more than forty years president of the Royal Society, Banks was indefatigable in his exertions on behalf of natural science. He made four oversea journeys himself, assisted various expeditions, founded the African Society, and advised George III. as to the Kew Gardens. His library and collections were bequeathed to the British Museum.

June 19, 1844. Etienne Geoffroy Saint-Hilaire died.—The pupil of Daubenton and Haüy and the friend of Cuvier, in 1793 Saint-Hilaire became professor of zoology in the Musée d'Histoire Naturelle. In 1798 he accompanied Napoleon to Egypt. Admitted to the Academy of Sciences in 1807, he afterwards became professor of zoology and comparative anatomy in the Faculty of Sciences. Among his most important works was his "Philosophie Anatomique" (1818-22).

June 20, 1794. Félix Vicq d'Azyr died.—The successor of Buffon in the Paris Academy of Sciences and physician to Louis XVI., Vicq d'Azyr wrote an important work, "Discours sur l'anatomie," in which he stated in a masterly way the methods of biological science.

June 21, 1846. James Marsh died.—The assistant to Faraday at the Royal Military Academy, Woolwich, Marsh invented electromagnetic apparatus, and also the quill percussion tube for ships' cannon, and in 1836 discovered the Marsh test for arsenic.

June 21, 1857. Louis Jacques Thénard died.—Born in poor surroundings, Thénard was assisted by Vauquelin, and gradually rose to a high place among French chemists. He held chairs at the Ecole Polytechnique, the Collège de France, and the Sorbonne, and though he did important work on the compound ethers and discovered hydrogen peroxide, he was, above all, a great teacher.

June 21, 1874. Anders Jons Ångström died.—Ångström held the chair of physics in Upsala University and was secretary to the Royal Society there. He did pioneering work in spectroscopy, in 1862 discovered the existence of hydrogen in the sun, and in 1868 published his map of the normal solar spectrum. Knut Johan Ångström (1857-1910), also a well-known physicist, was his son.

E. C. S.

Societies and Academies.

LONDON.

Royal Society, June 9.—Prof. C. S. Sherrington, president, in the chair.—Prof. C. S. Sherrington: Break-shock reflexes and "supra-maximal" contraction-response of mammalian nerve-muscle to single-shock stimuli. The maximal twitch-contraction of tibialis anticus muscle (cat) evoked by a single break-shock applied to the cut motor nerve exceeds the contraction evoked reflexly (spinal preparation) by a single break-shock applied to an afferent nerve. This is due to the reflex response being tetanic in nature. If the break-shock is strong it excites, even when applied to the motor nerve, a response of tetanic quality. The so-called "over-maximal twitch," now termed "supra-maximal response," is a response of this kind. A reaction of like kind probably obtains in the afferent nerve when the single-shock applied to it is of comparably high value. In this case there is also a tetanic reaction from afferent nerve-fibres themselves. With weaker break-shock stimuli the origin of the tetanic character of the reflex discharge lies in the centre itself. It arises there from a "charge" process which is relatively long-lasting in comparison with the cycle of a nerve-impulse, and increases in intensity and duration with the number of afferent fibres excited.—R. J. Ludford and J. B. Gatenby: Dictyokinesis in germs-cells, or the distribution of the Golgi apparatus during cell-division. Maturation mitoses in the germ-cells of *Cavia*, *Mus*, *Helix*, *Limnæa*, and *Stenobothrus* were examined. In all cases the Golgi apparatus breaks up into its constituent granules, and these are distributed haphazardly to the two daughter-cells at mitosis. In no case examined are they divided between the daughter-cells as equally as are the chromosomes. Hence the Golgi apparatus takes no important part in the transmission of factors from cell to cell.—Dr. F. W. Edridge-Green: The effect of red fatigue on the white equation. A white equation is formed by means of a mixture of a red of $\lambda 6670-6770 \text{ \AA.}$, a green of $\lambda 5144-5156 \text{ \AA.}$, and a violet of $\lambda 4250-4267 \text{ \AA.}$, matching a simple white. When the eye is fatigued with light viewed through a red glass, or with pure spectral light in the region of $\lambda 6700 \text{ \AA.}$, and the equation is again made, about half the amount of green is required. The white equation and its match cannot be due to similar physiological processes, or both would change in the same ratio. When the fatiguing light is in the region of $\lambda 7800 \text{ \AA.}$, no difference is seen between the mixed and simple white.—E. Ponder: A method for investigating the hæmolytic activity of chemical substances. The relation between the time taken by a given quantity of hæmolytic substance and the temperature at which it acts is expressed by a hyperbola. The relation between the constants of such a hyperbola and the quantity of hæmolytic substance to which it applies are given. Certain general relations hold for all substances examined. Experimental and calculated results are compared.—W. H. Pearsall: The development of vegetation in the English lakes, considered in relation to the general evolution of glacial lakes and rock basins. The English lakes are of the same age (glacial), of similar origin, and lie among rocks possessing relatively uniform characters. The differences they show are due to variations in the rates of erosion and sedimentation of the lake basins; therefore it becomes possible to describe the stages in the post-glacial development of a rock basin, and also of its vegetation. The differences observed between primitive and evolved lakes are regarded as being dependent upon their physical condition.

Association of Economic Biologists, June 4.—Sir David Prain, president, in the chair.—F. L. Engledow: The problem of increasing the yield of cereal crops by plant breeding. Aspects of experimental investigation, such as breeding for disease resistance, non-lodging, or high intrinsic yield, were considered, and the great difficulty of obtaining any simple criterion for so complex and elusive a total resultant as "yield" was emphasised. Bevan's studies on the migration coefficient as an index of yield were destructively criticised. The relation of yield to the weights of individual grains, to the number of grains per ear, to the number of ears per plant, and to the tillering of the plant was considered. At present comparative estimates are based on "yield per acre," but the author's work suggests that "yield per tiller" may, perhaps, be a better measure, "yield" itself being estimated in terms of starch, carbon, or some other chemical criterion, in place of the commercial standards now accepted.—C. B. Saunders: Problems of seed testing. The technique adopted at the official seed-testing station for the testing of purity and germinative capacity was described. Many problems arise in this work of both a mechanical and biological nature. Simple and effective instruments for sampling and non-selective counting are required, as well as selective mechanical devices for the extraction of dodder and other seeds from a mixture. Biological problems largely concern the relation of seed germination to environmental factors, and the apparent inconstancy shown in this relation. Thus seeds of apparently the same kind may under standardised conditions differ considerably not only from year to year and from month to month, but also from sample to sample, and may show periodicities and external factor relationships which give rise to a very great complexity of varying combinations. The whole technique is empirical, and much fundamental research is needed.

CAMBRIDGE.

Philosophical Society, May 16.—Prof. A. C. Seward, president, in the chair.—Dr. E. H. Hankin: The soaring flight of dragon-flies. From observation it appears improbable that undiscovered wing-movements or ascending currents of air can be accepted in explanation of soaring flight. Alterations in the amount of sunlight, even when slight, make considerable differences in the flight of dragon-flies. Lowering of the abdomen as a brake on speed in catching prey, etc., is a common phenomenon. Dragon-flies, flying-fishes, and birds all exhibit soaring flight, and in each class evidence is accumulating that low-speed flight depends on the presence of sunshine and high-speed flight on the presence of wind. If not identical, the speeds attained in the three classes are comparable.—C. G. Lamb: Note on secondary sexual characters in the Diptera, with a description of a novel type. The author discussed some points in the structure of the hypopygium in flies, and gave a description of some secondary characters in a new genus of Dolichopodidæ which were situated centrally instead of peripherally.—L. A. Borradaile: A note on the mouth-parts of certain Decapod crustaceans. Some Decapods, as *Hapalocarcinus* and *Porcellana*, seize food-particles directly; others, as *Pinnotheres* and the *Pontoniinae*, take it from sessile organisms. The mouth-parts of the former are modified for their mode of feeding. Similar modifications are not found in the latter, possibly because their food reaches them entangled in strings of mucus. *Porcellana* has no such jaw-reduction as is found in *Hapalocarcinus*, and this is as yet unexplained.—J. Gray: Hermaphrodite sea-urchins.—A. B. Appleton: (1) Preliminary note on the development of muscle, bone, and body-weight in

sheep. A summary was given of some results obtained in conjunction with Mr. J. Hammond over a number of years. The data brought forward referred to parts much utilised in the judging of sheep, viz. "hind-limb," "loin," "behind the shoulder," and "over the shoulder." In normal rams the muscles increase in weight after birth faster than the associated bones, while the ratio found in adults is nearly attained at the age of three months. From birth onwards the carcass forms an increasing proportion of the live-weight of the animal. The development of the hind-limb proceeds as a wave of growth passing upwards from below. Histological examination of the muscles in the prize animals shows that a very large amount of fat is present between the muscle-fibres in addition to that between muscle-bundles. Fat in the popliteal space and around the pelvis was notably increased. The characteristic "feel" and appearance of prize animals appear to be due to bone reduction as well as to fat and muscle increase. (2) The alleged inheritance of an acquired character in man. Photographs were shown of ankle-joints of new-born English children. Features are present which, from their presence in the newly born natives of India, have been claimed as the inheritance of a character acquired by their parents through adoption of the squatting posture. This cannot be the case in the English child. The features found in the new-born child are held to be the anatomical outcome of the normal attitude of the fœtus. (3) The so-called gluteus maximus of Tarsius. This is stated to be a compound muscle, since it includes the femorococcygeal and caudofemoral muscles. This is the interpretation given of the position of the great sciatic nerve, which passes through the gluteus maximus. In lemurs and in the primitive insectivore Tupaia a similar condition was found.—H. P. **Waran**: The effect of a magnetic field on the intensity of spectrum lines, ii. The earlier work of Kent and Frye on the subject is discussed and the invalidity of conclusions obtained under adverse experimental conditions proved by proper control experiments. Further study of the phenomenon conducted in a quartz tube are described. The enhancing effect of the magnetic field on the negative glow bands of nitrogen and the Balmer series of hydrogen are described, and the Balmer series is suggested to be mainly the radiations of the atom while the gas is at a high pressure. Experiments with a condensed discharge have proved the difference between its effect and that introduced by the magnetic field.—C. G. F. **James**: The theoretical value of Sutherland's constant in the kinetic theory of gases.—T. S. **Yang**: Orthogonal systems and the moving trihedral.

DUBLIN.

Royal Irish Academy, May 23.—Prof. Sydney Young, president, in the chair.—G. A. J. **Cole**: The problem of the Bray series. The stratigraphical position of the series of quartzites and slates that form Bray Head and Howth in the Dublin district has always seemed obscure. While the few organic remains indicate a Cambrian age, these rocks appear in places to overlie Ordovician strata, and they have suffered no invasion or metamorphism by the closely adjacent Leinster granite. Examination of the successive M.S. notes in records of the Geological Survey of Ireland shows how the problem was under discussion between 1855 and 1865. In the present paper it is suggested that the Bray series has been brought into position along a thrust-plane from the south-east during the later phases of the Caledonian folding, and that the outlying mass of Carrickgallogan is a "klip" resting, as Du Noyer believed, on Ordovician slates.

PARIS.

Academy of Sciences, May 23.—M. Georges Lemoine in the chair.—C. **Moureu**, M. **Murat**, and L. **Tampier**: Acrylic acid and acrylic esters. Halogen propionic acids and esters. Starting with pure acrolein, now readily obtainable in quantity, a method of preparing acrylic acid is described based on the intermediate production of β -chloropropionic acid. The acrylic acid was purified by repeated fractional crystallisation, and its physical constants were determined. The pure acid combines quantitatively at the ordinary temperature with the halogen acids.—A. **Blondel**: The topographical representation of the couples of alternating-current motors.—**Prince of Monaco**: Official visit to the United States.—C. **Guichard**: The 3I systems all the right lines of which belong to a linear complex.—M. Jean Massart was elected a correspondant for the section of botany in succession to the late M. Pfeffer.—G. **Julia**: The discontinuities of the solutions of certain Fredholm's equations.—P. **Humbert**: Hypergeometrical polynomials.—P. **Lévy**: Some questions of the functional calculus.—E. **Esclangon**: The aurora borealis of May 14-15, 1921, observed at Strasbourg.—M. **Luce**: Chemical reactions and radius of curvature. A continuation of work previously published on the same subject. It is shown that the influence of the curvature of a solid is the same in liquids as in gases, and that the data in both cases can be expressed by a similar formula.—M. **Bridel**: The application of the law of mass action to the results obtained in the reaction of β -galactosidase on galactose in solution in propyl alcohol. The application of the law of mass action to this reaction shows that in many cases equilibrium had not been reached when the experiments were stopped. For the stronger alcohols it would be necessary to prolong the experiments for months, or even years, to attain equilibrium.—A. **Tian**: A cause of dispersion of the colloid in an important class of hydrosols.—A. **Boutaric** and M. **Vuillaume**: The flocculation of colloidal arsenic sulphide. Principle of a method of study. The opacity of the solutions was measured in a Féry spectrophotometer; absorption curves are given showing the influence of time, of excess of hydrogen sulphide, and of excess of arsenious oxide. To have strictly comparable flocculation the colloidal solution must contain neither free sulphuretted hydrogen nor arsenious oxide.—E. **André**: Contribution to the study of the oil from grape pips. The chemical and physical constants of eleven samples of oil from different sources are given; the figures show great divergences, and it is evident that the composition of this oil varies considerably with the kind of grape.—P. **Gaubert**: The artificial coloration of crystals obtained by the solidification of a fused substance and on crystalline diffusion.—F. **Ehrmann** and J. **Savornin**: The stratigraphical scale of the Kabylie des Babors.—R. **Dongier**: The simultaneous oscillations of the pressure and wind at the top of the Eiffel Tower, and their relation with the squall surface (J. Bjerkness) of a depression. A reproduction of the curves of the recording instruments, showing the atmospheric pressure, wind velocities at the summit and base of the tower, and temperatures on September 15, 1906. The conclusions resulting from a detailed examination of these diagrams are in agreement with the theory of J. Bjerkness.—Ad. **Davy de Virville** and R. **Douin**: The modifications of form and structure of liverworts submerged in water. Seven species have been studied, and were found to adapt themselves to the new medium, undergoing remarkable changes in development, size, and structure.

If these forms had been met with in Nature, without knowing their history, they would have been described as varieties, and even as new species.—P. **Choux**: A new leafless *Asclepias* from the north-west of Madagascar.—S. **Jonesco**: Contribution to the study of the physiological rôle of the anthocyanins.—A. **Lumière** and H. **Couturier**: Anaphylaxy in plants. Experiments are described and illustrated by reproductions of photographs proving definitely that an anaphylactic state can be established in plants.—R. **Courrier**: The interstitial gland of the testicle and secondary sexual characters in fishes.—Mlle. **Larbaud**: New technique for the inclusions and microscopical preparations of vegetable and animal tissues. The use of butyl alcohol instead of ethyl alcohol is proposed for dehydrating the tissues. It has the advantage of dissolving paraffin wax, thus rendering unnecessary the use of xylene or toluene, and the number of treatments can be reduced from six to two.—G. **Truffaut** and N. **Bezssonoff**: Increase in the number of *Clostridium pastorianum* in soils partially sterilised by calcium sulphide.—R. **Poisson**: Researches on the determinism of the loss of the faculty of flight in the aquatic Hemiptera.

ROME.

Reale Accademia nazionale dei Lincei, April 3.—V. Volterra, vice-president, in the chair.—Papers by fellows:—G. **Castelnuovo**: Abelian functions, iii.: Jacobi's varieties.—C. **Segre**: The principal lines of a surface of S_3 and a characteristic property of Veronese's surfaces, i.—F. **Severi**: Theory of simple integrals of first species belonging to an algebraic surface, ii.—Communicated through fellows:—G. **Rovereto**: Erosive development considered as starting from a fundamental surface.—C. **Jucci**: Metabolism of true royal forms in the society of the Termites, ii.—Prof. Corbino read an account of the life and work of the late Prof. Augusto Righi, who died on June 8, 1920, and a similar notice relating to the late Prof. Michele Rajna, who died on September 29, 1920, was contributed by Dr. Legge. Among additions to the Academy library were mentioned treatises on dynamics of systems by Prof. Maggi and on statics of dams for lakes and science of construction by Prof. Guidi, presented through Prof. Levi Civita, in addition to several mathematical works.

Books Received.

Solvency or Downfall? Squandermania and its Story. By Viscount Rothermere. Pp. xi+160. (London: Longmans, Green and Co.) 2s.

Dairy Bacteriology. By Prof. Orla-Jensen. Translated from the second Danish edition by P. S. Arup. Pp. xii+180. (London: J. and A. Churchill.) 18s. net.

Tables, Factors, and Formulas for Computing Respiratory Exchange and Biological Transformations of Energy. Prepared by Thorne M. Carpenter. (Publication No. 303.) Pp. 123. (Washington: Carnegie Institution.) 2 dollars.

Index to United States Documents relating to Foreign Affairs, 1828-61. By Adelaide R. Hasse. (In three parts.) Part iii.: R to Z. (Publication No. 185, part iii.) Pp. 1331-1980. (Washington: Carnegie Institution.) 7 dollars.

Principes de Biologie Végétale. By Prof. Noël Bernard. (Nouvelle Collection scientifique.) Pp. xii+212. (Paris: F. Alcan.) 8 francs net.

Microbiology: A Text-Book of Microorganisms General and Applied. Edited by Prof. Charles E. Marshall. Third edition, revised and enlarged. Pp.

xxviii+1043+1 plate. (London: J. and A. Churchill.) 21s. net.

From a Modern University: Some Aims and Aspirations of Science. By Prof. Arthur Smithells. Pp. 124. (London: Oxford University Press.) 12s. 6d. net.

The Commercial Apple Industry of North America. By J. C. Folger and S. M. Thomson. (Rural Science Series.) Pp. xxii+466+xxiv plates. (New York: The Macmillan Co.; London: Macmillan and Co., Ltd.) 18s. net.

L'Astronomie et les Astronomes. By Auguste Colard. Pp. viii+119. (Bruxelles: G. Van Oest et Cie.)

Pneumatic Conveying: A Concise Treatment of the Principles, Methods, and Applications of Pneumatic Conveyance of Materials. By E. G. Phillips. (Pitman's Technical Primers.) Pp. xii+108. (London: Sir I. Pitman and Sons, Ltd.) 2s. 6d. net.

Tanning Materials. With Notes on Tanning Extract Manufacture. By Arthur Harvey. Pp. vii+182. (London: Crosby Lockwood and Son.) 15s. net.

Perfumes, Essential Oils, and Fruit Essences Used for Soap and other Toilet Articles. By Dr. Geoffrey Martin. (Manuals of Chemical Technology, X.) Pp. vii+138. (London: Crosby Lockwood and Son.) 12s. 6d. net.

Elements of Practical Geometry. A Two Years' Course for Day and Evening Technical Students. By P. W. Scott. Pp. v+185. (London: Sir I. Pitman and Sons, Ltd.) 5s. net.

A Geological Excursion Handbook for the Bristol District. By Prof. S. H. Reynolds. Second edition. Pp. 224. (Bristol: J. W. Arrowsmith, Ltd.; London: Simpkin, Marshall and Co., Ltd.) 5s. net.

Exponentials Made Easy; or, The Story of "Epsilon." By M. E. J. Gheury de Bray. Pp. x+253. (London: Macmillan and Co., Ltd.) 4s. 6d. net.

A Text-Book of Inorganic Chemistry. Edited by Dr. J. Newton Friend. Vol. ix., part ii.: Iron and its Compounds. By Dr. J. Newton Friend. (Griffin's Scientific Text-books.) Pp. xxv+265. (London: C. Griffin and Co., Ltd.) 18s.

Tuberculosis: Its Prevention and Home Treatment. By Dr. H. Hyslop Thomson. (Oxford Medical Publications.) Second edition. Pp. ix+99. (London: H. Frowde and Hodder and Stoughton.) 4s. net.

Year-Book of the Royal Society of London, 1921. (No. 25.) Pp. iv+201. (London: Harrison and Sons, Ltd.) 7s. 6d.

Library of Congress. A List of Geographical Atlases in the Library of Congress, with Bibliographical Notes. Compiled under the direction of Philip L. Phillips. Vol. iv. Pp. clxiii+639. (Washington: Government Printing Office.) 1.25 dollars.

Biochemistry: A Study of the Origin, Reactions, and Equilibria of Living Matter. By Prof. Benjamin Moore. Pp. vii+340. (London: E. Arnold.) 21s. net.

Fabre, Poet of Science. By Dr. G. V. Legros. Translated by Bernard Miall. Second impression. Pp. 352. (London: T. Fisher Unwin, Ltd.) 8s. 6d. net.

Oxford University Junior Scientific Club. Electrons and Ether Waves. Being the Twenty-third Robert Boyle Lecture, on May 11, 1921. By Sir William Bragg. Pp. 14. (London: Oxford University Press.) 1s. net.

Oxford and the Rural Problem. Being the First Sidnev Ball Memorial Lecture, December, 1920. By the Right Hon. Sir Horace Plunkett. (Barnett House Papers, No. 6.) Pp. 18. (London: Oxford University Press.) 1s.

Hyperacoustics. By John L. Dunk. Division ii.: Successive Tonality. Pp. xi+160. (London: J. M. Dent and Sons, Ltd.; New York: E. P. Dutton and Co.) 5s. net.

Greek Medicine in Rome. The Fitzpatrick Lectures on the History of Medicine, delivered at the Royal College of Physicians of London in 1909-10, with other Historical Essays. By the Right Hon. Sir T. Clifford Allbutt. Pp. xiv+633. (London: Macmillan and Co., Ltd.) 30s. net.

The Psychology of Industry. By Dr. James Drever. Pp. xi+148. (London: Methuen and Co., Ltd.) 5s. net.

Motya: A Phœnician Colony in Sicily. By Joseph I. S. Whitaker. Pp. xvi+357. (London: G. Bell and Sons, Ltd.) 30s. net.

Diary of Societies.

THURSDAY, JUNE 16.

INSTITUTE OF PATHOLOGY AND RESEARCH (at St. Mary's Hospital), at 4.30.—Prof. W. Bulloch: Use and Abuse of Scientific Medical Literature.

ROYAL SOCIETY, at 4.30.—Prof. H. B. Dixon, Dr. C. Campbell, and Dr. A. Parker: The Velocity of Sound in Gases at High Temperatures, and the Ratio of the Specific Heats.—Prof. J. R. Partington: The Ratio of the Specific Heats of Air and of Carbon Dioxide.—Dr. A. B. Wood and Dr. F. B. Young: "Light Body" Hydrophones and the Directional Properties of Microphones.—Dr. A. B. Wood and Dr. F. B. Young: The Acoustic Disturbances produced by Small Bodies in Plane Waves transmitted through Water, with Special Reference to the Single Plate Direction Finder.—M. A. Giblett: Some Problems connected with Evaporation from Large Expanses of Water.—F. C. Toy: The Photographic Efficiency of Heterogeneous Light.

LINNEAN SOCIETY, at 5.—Dr. N. Annandale: The Vegetation of an Island in Chilka Lake on the East Coast of India, considered as a Preliminary to a Study of its Fauna.—Col. Godfrey: The Fertilisation of Cephalanthera.

ROYAL COLLEGE OF PHYSICIANS OF LONDON, at 5.—Dr. F. L. Golla: The Objective Study of Neurosis (Croonian Lecture).

ROYAL SOCIETY OF MEDICINE (Dermatology Section), at 5. CHEMICAL SOCIETY (at Institution of Mechanical Engineers), at 8.—Prof. B. Moore: The Natural Photo-synthetic Processes on Land and in Sea and Air, and their Relation to the Origin and Preservation of Life upon the Earth (Hugo Müller Lecture).

ROENTGEN SOCIETY (at Royal Photographic Society), at 8.15.—Major G. W. C. Kaye and Others: Discussion on the Physics of the X-ray Tube.—Exhibition of Modern X-ray Tubes.—British Thomson-Houston Co., Ltd.: Demonstration of New Portable Coolidge Outfit.

ROYAL PHOTOGRAPHIC SOCIETY OF GREAT BRITAIN, at 8.15.—Lecture.

ROYAL SOCIETY OF MEDICINE (General Meeting), at 8.30.—Sir Thomas Horder, Dr. G. C. Anderson, Mr. Clayton-Greene, W. S. Dickie, B. Harman, Dr. A. F. Hurst, Dr. Drury Pennington, Sir Humphry Rolleston, Dr. Gilbert Scott, and Dr. M. Wright: The Problem of the Private Clinic System in Great Britain.

FRIDAY, JUNE 17.

ROYAL ASTRONOMICAL SOCIETY, Geophysical Discussion, at 5.—Changes of Level in the British Isles, opened by H. L. P. Jolly, followed by Col. Sir C. F. Close and O. G. S. Crawford. Chairman: Col. Sir G. Lenox-Conyngham.

ROYAL SOCIETY OF TROPICAL MEDICINE AND HYGIENE (Annual Meeting), at 8.15.—Major R. Knowles: The Mechanism and Treatment of Snake-bite in India.

ROYAL PHOTOGRAPHIC SOCIETY OF GREAT BRITAIN, at 8.—J. C. Warburg: Foregrounds.

WEST LONDON MEDICO-CHIRURGICAL SOCIETY (at Kensington Town Hall), at 8.15.—Dr. C. Addison: The Part of the State in the Prevention of Disease (Cavendish Lecture).

ROYAL INSTITUTION OF GREAT BRITAIN, at 9.—Sir J. J. Thomson: Chemical Combination and the Structure of the Molecule.

MONDAY, JUNE 20.

ROYAL SOCIETY OF MEDICINE, at 5.—Special General Meeting.

ROYAL INSTITUTE OF BRITISH ARCHITECTS, at 8.

ROYAL GEOGRAPHICAL SOCIETY (at Æolian Hall), at 8.30.—Dr. W. F. Hume: The Egyptian Wilderness.

TUESDAY, JUNE 21.

ROYAL HORTICULTURAL SOCIETY, at 3.

ROYAL COLLEGE OF PHYSICIANS OF LONDON, at 5.—Dr. F. L. Golla: The Objective Study of Neurosis (Croonian Lecture).

ROYAL SOCIETY OF MEDICINE (General Meeting), at 5.

ROYAL STATISTICAL SOCIETY (at Surveyors' Institution), at 5.15.—Mrs. W. J. Barton: Women's Minimum Wages.

MINERALOGICAL SOCIETY (at Geological Society), at 5.30.—Prof. H. Hilton: Note on Crystal Measurement.—A. Brammell: Reconstruction Processes in Shales, Slates, and Phyllites.—A. Richardson: The Micro-petrography of the Rock-gypsum of Nottinghamshire.

WEDNESDAY, JUNE 22.

GEOLOGICAL SOCIETY OF LONDON, at 5.30.—F. Dixey: The Norite of Sierra Leone.—Dr. C. T. Trechmann and F. L. Späth: The Jurassic of New Zealand.

FARADAY SOCIETY (at Chemical Society), at 8.—C. J. Smithells: High Temperature Phenomena of Tungsten Filaments.—E. Hatschek: A Simple Apparatus for Determining the Coagulations Velocity of Gold Sols.—Prof. A. W. Porter: Variation of Surface Tension with Temperature.—S. M. Neale: The Influence of the Solvent upon Ionisation and the accompanying Heat Effect.—A. McKeown: The Potential of the Iodine Electrode and the Activity of the Iodine Ion at 25° C.—E. Kilburn Scott: Demonstration of the Transmission of Sounds by means of Rochelle Salt Crystals.

THURSDAY, JUNE 23.

ROYAL SOCIETY, at 4.30.—*Probable Papers*.—Dr. E. F. Armstrong and T. P. Hilditch: A Study of Catalytic Actions at Solid Surfaces. VI. Surface Area and Specific Nature of a Catalyst: Two Independent Factors controlling the Resultant Activity.—Sir J. B. Henderson: A Contribution to the Thermodynamical Theory of Explosions, Part I.; and (with Prof. H. R. Hassé) Part II.—S. Butterworth: Eddy Current Losses in Cylindrical Conductors, with Special Applications to the Alternating-current Resistances of Short Coils.—E. S. Bieler: The Currents induced in a Cable by the Passage of a Mass of Magnetic Material over it.—Dr. G. Barlow and Dr. H. B. Keene: The Experimental Analysis of Sound in Air and Water: Some Experiments towards a Sound Spectrum.—Dr. G. Barlow: The Theory of Analysis of an Electric Current by Periodic Interruption.

FRIDAY, JUNE 24.

PHYSICAL SOCIETY OF LONDON (at Imperial College of Science), at 5.—S. Butterworth: Capacity and Eddy-current Effects in Inductometers.—Dr. E. Griffiths: New Specific Heat Apparatus.—Prof. A. O. Rankine: Encounters between Non-spherical Gas Molecules.—Dr. C. Chree: An Electro-culture Problem.

MONDAY, JUNE 27.

ROYAL SOCIETY OF MEDICINE (Odontology Section), at 8.—K. Fry: The Dental Treatment of Congenital and Other Perforations of the Palate.

TUESDAY, JUNE 28.

ROYAL ANTHROPOLOGICAL INSTITUTE, at 8.15.—L. H. Dudley Buxton: The Ancient and Modern Inhabitants of Malta.

CONTENTS.

	PAGE
The Safeguarding of Research	481
Steam and Thermodynamic Theory. By Sir J. A. Ewing, K.C.B., F.R.S.	482
Ore Deposits of Utah	484
Medical Science and Practice	484
Our Bookshelf	485
Letters to the Editor:—	
Human and Other Tails.—Prof. F. Wood Jones; Sir Arthur Keith, F.R.S.	487
The Stationary H- and K-lines of Calcium in Stellar Atmospheres.—Prof. Megh Nad Saha	488
Biological Terminology.—Dr. F. A. Bather, F.R.S.	489
A New Acoustical Phenomenon.—Dr. J. Erskine-Murray	490
Hérons and Fish.—Right Hon. Sir Herbert Maxwell, Bart., F.R.S.	490
Why do Worms Die?—W. J. Lewis Abbott; J. H. Coste	490
Vitality of Gorse-seed.—John Parkin	491
Habits of the Hedgehog.—Dr. G. A. Auden	491
Principles of Picture-hanging.—Sir G. Greenhill, F.R.S.	491
Oersted—the Discoverer of Electro-magnetism. By R. T. G.	492
Native Life in the Loyalty Islands and Southern Nigeria. (Illustrated.) By Henry Balfour	495
Obituary:—	
Peter Donald Malloch. By W. C. M.	498
Notes	499
Our Astronomical Column:—	
Dr. Hill's Cusped Orbit	503
Stonyhurst College Observatory	503
"L'Astronomie et les Astronomes"	503
Prof. Einstein's Lectures at King's College, London, and the University of Manchester	504
Physico-chemical Problems Relating to the Soil. By B. A. K.	504
British Science Guild: Notable Views on Present-day Problems	505
University and Educational Intelligence	507
Calendar of Scientific Pioneers	508
Societies and Academies	509
Books Received	511
Diary of Societies	512



THURSDAY, JUNE 23, 1921.

Editorial and Publishing Offices:
MACMILLAN & CO., LTD.,
ST. MARTIN'S STREET, LONDON, W.C.2.

Advertisements and business letters should be
addressed to the Publishers.

Editorial communications to the Editor.

Telegraphic Address: PHUSIS, LONDON.
Telephone Number: GERRARD 8830.

"Index-Numbers" and Wages-Regulation.

IF we want to study the movements of prices, whether within some more or less narrowly defined group of commodities (*e.g.* foodstuffs or textiles) or over a wider range (*e.g.* all the commoner commodities consumed in the United Kingdom), the necessity is soon felt for some means of summarising the diverse fluctuations noted. This can be readily effected by taking some particular price of each commodity as a standard (usually the price in a particular year or the average over a series of years), expressing the price of that commodity at any epoch as a percentage of the standard price—thus rendering the various movements comparable—and then averaging in some way for the whole series of commodities the *index-numbers* thus obtained. The average so calculated is usually itself termed an *index-number of prices*, with some qualifying expression to show to what it relates—*e.g.* an index-number of wholesale prices, of retail prices, or whatever it may be.

When consideration is given to the planning of such an (average) index-number, a great variety of questions at once arises. For example: (1) What commodities shall be included? (2) What sorts or qualities of each commodity? (3) What prices shall be used? Wholesale prices? Retail prices? Import values? Export values? At what markets? (4) How is the standard price for each commodity to be determined? For what reference year or reference period? (5) Finally, how are the individual index-numbers to be aver-

aged? The answers to be given on these points evidently must depend on the question that the index-number is intended to answer. Only a definite question permits of a definite answer; and two very distinct questions have dominated researches into the movements of prices: (a) The question of the effect of currency changes—*e.g.* the substitution of paper for gold, or the varying supplies of the precious metals. (b) The question of changes in the "cost of living."

Questions of the first type present their own and numerous, difficulties; but from the point of view of practice there is one simplification, that the answer must be based on wholesale prices, quotations for which can be obtained with comparative ease. Such questions are certain to arise in a time following important new discoveries of the precious metals, as they did after the gold discoveries of 1848-49, which gave rise to two classical researches, those of William Newmarch and of Jevons.

Newmarch¹ used twenty-two quotations, no fewer than four of which were for cotton. 1845-50 was taken as the reference period. At first no summary was attempted; later the index-numbers for the individual commodities were simply added together instead of being averaged, so that the base-figure was 2200 instead of 100. Virtually, however, the index-number was the simple arithmetic mean of its components. This index-number has been given monthly in the *Economist* almost without a break since 1869, and remained on precisely the same basis until 1911. The inconvenience of the old basis had by this time become very marked—such vital commodities as foreign wheat, steel, petroleum, and rubber were not included—and the whole basis was revised. The number of quotations was raised from twenty-two to forty-four, and the base-period was altered from 1845-50 to 1901-5. When the simple arithmetic mean is used for the average the base-period is important, as it determines a virtual system of weighting.

The work of Jevons² (1863-65) is mainly of importance from his use of the geometric mean as the form of average. Without entering into the reasons that he assigned, some of which are obscure, one reason is clear and important. If the geometric mean be used, the ratio of the index-number for any year B to year A is the

¹ Cf. vols. v. and vi. of "The History of Prices," by Tooke and Newmarch; the Mercantile Reports by Newmarch in the Journal of the Royal Statistical Society, vols. xxii., xxiii., and xxiv.; and the volumes of the *Economist* from 1864. The summary figure appears to have been first given in 1869.

² Reprinted in "Investigations in Currency and Finance" (Macmillan, 1864).

same whatever year be used as base, and this is not the case if the arithmetic mean be used. Jevons's calculations were not maintained, but his work on this point of method has been fruitful.

Sauerbeck,³ having regard to the unsatisfactory character of the old *Economist* number, constructed in 1886 a fresh index, using forty-five quotations. His base-period was the eleven years 1867-77, and he again used the simple arithmetic average for his mean. The calculation of the index-number was maintained, and it has now become the index-number of the *Statist*. In some ways this number also is no longer entirely satisfactory; foreign meat, for example, is not included, nor rubber.

The Board of Trade⁴ in 1903 constructed an official index-number of wholesale prices in which a weighted arithmetic mean of the individual index-numbers was used, weights being given by the estimated values consumed. It was not a satisfactory number. The correct method of weighting does not seem to have been realised, and the weights actually used were based on a period different both from the reference year first employed (1871) and from that used later (1900), with the result that two widely divergent series of figures have been given. Very rightly the Board has decided that the old number should now be entirely dropped and a fresh index constructed on a new basis. This basis was fully described in a paper by Mr. A. W. Flux,⁵ of the Board of Trade, read before the Royal Statistical Society for discussion in January last. So many as 150 quotations are used for the new number, and the geometric mean is employed, thus freeing the results from any influence of choice of reference period, and obtaining a completely consistent series of averages. No actual weights are used, but, as in the case of the *Economist* and the *Statist* index-numbers, there will be an approximate weighting by assigning more quotations to the more important commodities. It must be noted also that this number is really devised to answer a question different from that faced by Newmarch or Jevons—the effect, not of currency on prices, but of prices on currency. In the case of dutiable commodities the duty will therefore be included in the price; prices will not be quoted duty-free as in the case of the other wholesale numbers. The number, the first figures for which

have been published in the *Board of Trade Journal*, represents a great advance.

All the above index-numbers are essentially index-numbers of wholesale prices, and deal preponderantly, though not wholly, with raw materials. Clearly this is not what is required for an index-number of "cost of living." But what do we mean by that very elastic phrase? As soon as we endeavour really to analyse the term, it becomes extraordinarily difficult to say. The clearest definition is "the cost of purchasing year by year the same schedule of commodities and services." It is nearly a century since Joseph Lowe⁶ attempted calculations on this basis for the change in "cost of living" between 1792, 1813, and 1823 for a country labourer, a town mechanic, and a middle-class family, using estimated budgets of normal expenditure as his foundation. He also suggested the voluntary regulation of wages and salaries on such a basis.

It cannot be said that we have advanced much beyond this work of a century ago so far as regards method. The Board of Trade, soon after the beginning of the war, began the publication of an index-number of retail prices in the *Labour Gazette*, afterwards maintained by the Ministry of Labour. At first it was termed an index-number of "cost of living," but, very judiciously, that phrase was afterwards dropped, and it is now referred to only as a measure of changes in retail prices. It is to be regretted that not only members of the public, but also members of the Government themselves, still, nevertheless, continue to refer to it as an index of the "cost of living." The process of calculation was fully described in the *Labour Gazette* for March, 1920. A fixed schedule of foodstuffs was taken, based on the pre-war consumption of a working-class family, and the total cost of this schedule at the prices of the day compared with the prices of July, 1914, gives an index-number for food; index-numbers for working-class rents, clothing, fuel and light, and miscellanea (ironmongery, brushware, and pottery; soap and soda; tobacco and cigarettes; fares and newspapers) are determined by other inquiries, and these several group-indexes are combined into a general average on the basis of weights determined from pre-war expenditure.

The number is thus based entirely on the conception of purchasing a fixed schedule—the maintenance of a fixed mode of life. But when prices

³ Journ. Stat. Soc., vol. xlix., 1886; subsidiary papers and annual reviews since.

⁴ Report No. 321, 1903, and later *Labour Gazette* or "Annual Abstract of Labour Statistics."

⁵ Journ. Stat. Soc., March, 1921. The paper has also been separately printed.

⁶ "The Present State of England" (London, 1822, and second edition, 1823).

change, people do not maintain their previous mode of life in absolute fixity, and in war-time they cannot do so. What, then, is to be done? The Committee⁷ appointed in March, 1918, to report on "the actual increase since June, 1914, in the cost of living to the working classes," under the chairmanship of Lord Sumner, based its number on the actual *expenditure on living*—i.e. if a working-class family of definite size spent £*x* in the earlier year, and £*y* in the later year, the index-number of "cost of living" was taken as y/x . However interesting such a figure⁸ may be—and it obviously has its interest—it is certainly not deserving of the title "an index-number of cost of living." To its use for regulating wages Labour leaders made the obvious objection: "If we can buy next to no food, you will say that we need have next to no wages." Had the Committee suggested (and the suggestion arises naturally out of its report) that, in the case of food, the Calorie-value of the dietary should be kept constant, this objection would have been obviated. If an index-number is to deserve the name of an index-number of cost of living at all, there must be fixity of a standard of some kind.

But the virulence of the discussion that has centred round the Ministry of Labour number is largely due to this fact, that it has been used as the basis of wages-regulation. Need a number for regulating wages (if they ought to be so regulated, which is itself a very debatable question) be a number for "cost of living"? For example, Customs and Excise duties certainly contribute to cost of living; but they are meant to be paid by those who choose to consume the dutiable commodities. Ought they, then, to be included, as duties are included in the Ministry of Labour number, in an index for regulating wages, thus merely shifting payment to the employer? Again, ought luxuries to be included? Neither tobacco nor newspapers can be called necessities. They are rightly included when it is a question of constructing an index-number of "cost of living." Ought they to be included in a number for wages-regulation, as in the Ministry of Labour number? These, and the like, are certainly questions that ought to be discussed, and if it is realised that the index-number is intended to serve the purpose of regulating wages, and not of indicating some

vaguely conceived "cost of living," it may be possible to arrive at definite and agreed answers. The revision of the Ministry of Labour number will certainly have to be considered in the near future. Any revision should be carried out with a definite conception of the real end in view. If the Ministry of Labour would extend its views so far as to have some regard to working members of the community other than those who work with their hands for a weekly wage, it might consider the formation of a number more nearly related to the expenditure of the middle classes. No index-number of prices exists which forms any adequate basis for the regulation of salaries. Both the Ministry of Labour number and various wholesale numbers have, we believe, been used, but they are not satisfactory.

It is, in fact, time that the entire question of regulating wages and salaries in accordance with price movements, its justification, the formation of index-numbers for different classes of wage-earners (skilled and unskilled labour do not have the same budget; miners who get coal free and houses free ought not to have their wages affected by movements in rents and coal prices) and of salary-earners, and the relation that should subsist between a given movement in the index and the movement in the wage or salary should be fundamentally reconsidered.

Psychology and Psychopathology.

- (1) *Instinct and the Unconscious: A Contribution to a Biological Theory of the Psycho-Neuroses.* By Dr. W. H. R. Rivers. (The Cambridge Medical Series.) Pp. viii + 252. (Cambridge: At the University Press, 1920.) 16s. net.
- (2) *Psychoanalysis: Its History, Theory, and Practice.* By André Tridon. Pp. xi + 272. (London: Kegan Paul, Trench, Trubner, and Co., Ltd., 1919.) 10s. 6d. net.

THE investigations and theories of Freud have exerted a profound effect upon the development of psychology. This can be seen not only in the rapidly increasing body of teaching put forth by Freud and his orthodox followers, but still more in the mass of writings now appearing which are based largely on certain of Freud's fundamental doctrines, although they are developed along lines diverging widely from those accepted by the psychoanalyst.

In this latter group Dr. Rivers's work merits special attention, because, unlike so many of that prolific harvest of psychological and psychopatho-

⁷ Cd. 8980, 1918. Cf. also Cd. 76, 1919, on "Cost of Living of Rural Workers," and the paper by Dr. A. L. Bowley on the measurement of changes in the cost of living, *J. r. n. Stat. Soc.*, vol. lxxxii., 1919.

⁸ Indexes of "expenditure on food" as against food prices were given for some time during the war in the *Labour Gazette*.

logical books of which the war has sown the seed, it is not a mere *réchauffé* of other people's views, but the fruit of independent and efficient thought, and a solid attempt to advance scientific knowledge. The main portion of the book, comprising 158 pages, consists of a series of lectures delivered at Cambridge. The remaining pages contain reprints of papers written for various journals, which are related only indirectly to the consistent plan of development carried out in the lectures.

The author accepts in the main Freud's conception of the unconscious, and the "mechanisms" of conflict, repression, and so forth whereby Freud seeks to explain the processes occurring in consciousness, although considerable modifications in nomenclature and definition are introduced. He accepts also the view that the activities of consciousness are to be regarded as the resultant of various instinctive forces, but he develops this conception along lines which are partly akin to those worked out by McDougall, and partly the result of an independent mode of approach. The subject is regarded from a biological point of view, and the essential feature of the author's treatment is an attempt to bring the processes of consciousness, both in the normal and in the psychoneuroses, into relation with processes occurring at physiological levels, all being incorporated in a scheme of biological development. Thus suggestion, conflict, repression, and even such phenomena as sleep and hypnosis, are analysed into modes of reaction comparable with those discovered by Head and his fellow-workers to exist in physiological reflexes and in the mechanism of sensation. This view is extremely interesting and suggestive, though it may be doubted whether the relation is not one of analogy rather than of the identity which Dr. Rivers seems to postulate.

The same line of thought is carried on into the author's treatment of the psychoneuroses. Here, again, he accepts the main Freudian position that the psychoneuroses are due to conflicts occurring between the great instinctive forces of the mind, and that they are to be regarded biologically as attempts to find some solution of these conflicts. With regard to the nature of the instinctive forces concerned, however, he brings forward hypotheses which are open to considerable criticism. He suggests, for example, that hysteria is essentially dependent upon the activity of the danger-instincts, and implies that the type of hysteria met with in the war is the fundamental form of that disorder. This generalisation seems to be subject to the same accusation of narrowness and one-sidedness as has been levelled at the corre-

sponding view of Freud that hysteria is essentially dependent upon the sex instincts, and it can scarcely have behind it the weight of clinical experience upon which the latter view was founded. It is to be remarked, moreover, that Dr. Rivers does not discuss the recent work of the Freud school on narcissism and the attempts which have been made to explain the war type of hysteria by means of this conception.

Another noteworthy omission is the absence of any reference to Trotter's views on herd-instinct, which surely ought at least to be considered in a work dealing with the fundamental reactions of the mind.

The papers forming the appendix are all of considerable interest, although, as has been said, they have only an indirect bearing on the main argument of the lectures. The book as a whole is, without doubt, one of the most important recent contributions to psychological literature.

(2) Dr. Tridon's book is of an altogether different type. It makes no claim to put forward any original line of thought, and its aim is best expressed in the author's own words as an attempt "to sum up in a concise form the views of the greatest American and foreign analysts." It includes a description not only of the doctrines of the orthodox Freud school, but also of those of Jung and Adler, who, although they originally worked with the Freud school, have now diverged from it to a very wide extent. To carry out such an aim within the limits of a small book is clearly a very difficult task, and Dr. Tridon will probably fail to satisfy the exponents of any of these divergent schools. He has, however, succeeded in producing a very readable and interesting book.

French Chemists and the War.

La Chimie et la Guerre, Science et Avenir. By Prof. Charles Moureu. ("Les Leçons de la Guerre.") Pp. iii + 384. (Paris: Masson et Cie, 1920.) 10 francs net.

THE well-known publishing house of Masson et Cie, Paris, is issuing a series of volumes under the general title of "Les Leçons de la Guerre," with special reference to the experiences, circumstances, and prospects of France. The books which have already appeared deal with the military, naval, and aeronautical lessons of the war; with the effect of the war, immediate and prospective, on French industry; with alimentation and revictualling; and lastly with the influence of science, and particularly of chemistry, on the war, and, reciprocally,

with the influence of the war on the present condition and future development of that science. The volume under review is the work of Prof. C. Moureu, member of the Institute of France, professor of the Collège de France, president of the Chemical Society of France and of the International Union of Chemistry. No one is better fitted to expound the mutual relations of chemistry and war than Prof. Moureu, for no one during its course took a more active part in placing all the resources of that science at the disposal of his country. As is now well recognised, all the Allies vied with Germany in enlisting the services of their chemists in the prosecution of the war, and their united energy, resourcefulness, and skill eventually crushed their adversary. As the war was conducted, military valour, tenacity, and intelligent direction would not alone have decided the issue. Germany had imported a new element into the struggle which gave her an enormous initial advantage. The services of her great chemical manufacturing establishments had been deliberately and sedulously linked up for years previously with the war which was being prepared for in such a manner that, on its outbreak, all their appointments and machinery could at once be made available for its ruthless prosecution by every means which the diabolical ingenuity of their chemists could suggest.

April 22, 1915, which first saw the yellowish-green suffocating cloud of chlorine slowly wafted from the German trenches between Bixschoote and Langemark, is a black-letter day in the history of warfare. The infamous action of the Germans, done in cynical disregard of all international effort to mitigate the horrors of war, shocked the conscience of the civilised world. Whatever trace of knightly prowess or chivalry was left in modern war was thereby destroyed. To employ poisons against your enemy was the work of savages. What, it may be asked, was the ethical value of the boasted *Kultur* of a nation which could not only initiate, but also strive to develop and to intensify the evil of such agencies by all the means that its scientific knowledge and skill could suggest? The following table, taken from Prof. Moureu's book, giving a list of the chemical poisons, solid, liquid, and gaseous, which the Germans flung at their adversaries in the course of the war, requires no comment—at least to the organic chemist at all familiar with the noxious characters of such products. Their physiological action became only too well known by bitter experience.

Date when first used on the field of battle.	Name of substance.	Chemical formula.	Physiological action.
1915	Chlorine (gas)	Cl_2	Suffocating
April	Bromine (liquid)	Br_2	Suffocating
June	Benzylbromide (liquid)	$\text{C}_6\text{H}_5-\text{CH}_2\text{Br}$	Lachrymatory
July	Bromoacetone (liquid)	$\text{CH}_3-\text{CO}-\text{CH}_2\text{Br}$	Suffocating, lachrymatory
Aug.	Methyl chloro-sulphonate (liquid)	$\text{SO}_2 \begin{cases} \text{Cl} \\ \text{OCH}_3 \end{cases}$	Suffocating
Aug.	Chloromethyl chloroformate (liquid)	$\text{Cl}-\text{COOCH}_2\text{Cl}$	Suffocating
Aug.	Bromomethyl ethylacetone (liquid)	$\text{CH}_3-\text{CO}-\text{CHBr}-\text{CH}_3$	Suffocating, lachrymatory
1916	Trichloromethyl chloroformate (liquid)	$\text{Cl}-\text{COOCCl}_3$	Suffocating
Dec.	Phosgene (gas)	COCl_2	Suffocating
1917	Chloropicrin (liquid)	CCl_3NO_2	Suffocating, lachrymatory
July	"Mustard gas" (ypérite) (liquid)	$\text{S} \begin{cases} \text{CH}_2, \text{CH}_2\text{Cl} \\ \text{CH}_2, \text{CH}_2\text{Cl} \end{cases}$	Suffocating, lachrymatory, vesicant
Sept.	Diphenylchloroarsine (solid)	$(\text{C}_6\text{H}_5)_2\text{AsCl}$	Suffocating, sternutatory
	Phenyldichloroarsine (liquid)	$\text{C}_6\text{H}_5\text{AsCl}_2$	
Sept.	Phenylcarbylamine chloride (liquid)	$\text{C}_6\text{H}_5\text{N} : \text{C} : \text{Cl}_2$	Nauseous and toxic
1918	Ethylarsine dichloride (liquid)	$\text{C}_2\text{H}_5\text{AsCl}_2$	Toxic, sternutatory
April	Ethylarsine dibromide (liquid)	$\text{C}_2\text{H}_5\text{AsBr}_2$	Toxic, sternutatory
June	Diphenylarsine cyanide (solid)	$(\text{C}_6\text{H}_5)_2\text{AsCN}$	Sternutatory
Sept.	N-Ethylcarbazol (solid)	$\text{C}_6\text{H}_4-\text{C}_6\text{H}_4$ NC_2H_5	Sternutatory

Lord Kitchener at first refused to sanction reprisals of a like nature. But the French were prompt to meet the new danger. They realised that such reprisals were imperatively necessary in self-defence. Although, as was the case with all the Allies, France was totally unprepared for such savagery, before the end of April, 1915, she had organised means of protection and of counter-aggression in which the author of the book under review took a leading part.

Considerations of space preclude any detailed account of the way in which the dastardly action of the Germans was met and finally mastered. By the united efforts of the Allies, working in concert, the Germans were eventually taught a lesson which made their leaders bitterly regret that they had ever resorted to "poison gas" as an offensive

agent. It brought its own Nemesis by ultimately destroying the German *moral*.

The story of the organisation of the chemical and medical services of the war, as regards France, is the main theme of Prof. Moureu's book. He explains in detail how the whole procedure was gradually systematised. Nothing is more remarkable than the rapidity with which the chemical and medical strength of the nation was enlisted and co-ordinated. France is pre-eminently a logical nation, and her mental habitudes served her admirably, and, indeed, saved her in the crisis which had well-nigh overwhelmed her.

As regards her chemists, practically every name of note in the French chemical world is to be found in the lists furnished by Prof. Moureu. From first to last 268 French chemists were employed in the chemical services of the war. Thirteen of the laboratories in Paris were wholly concerned with the study of counter-aggressives alone. But the work of reprisals extended far beyond counter-aggressives. The services of the chemists were concerned with metallurgy, the production of alloys, the manufacture of explosives, aeronautics, camouflage, supply, sanitation, alimentation, medicaments, photographic chemicals, radio-active substances, and a host of minor matters, such as the recovery of solvents, optical glass, potash, platinum, etc. France, like this country, had gradually allowed Germany to obtain control of the manufacture of many articles as essential in war as in peace. Their production by the Allies had to be suddenly improvised. In some cases little or nothing was known concerning the details of their manufacture, and study and experiment were needed before their preparation on the large scale could be attempted.

But when the German onslaught had spent itself at the Marne France gained a breathing time, and she rapidly made up her leeway. Her success will permanently benefit her industry. She has consolidated the manufacture of certain articles for which, like us, she was formerly wholly dependent on Germany, and is now in a position to export them—a consummation which she owes, in great measure, to the patriotism and self-sacrifice of her chemists.

Prof. Moureu has conferred a benefit on his country by the compilation of this admirable work. The lessons it conveys are of profound importance to the national well-being. So far we have had nothing exactly like it in this country. But England has a no less thrilling story to tell. And it should be told quickly, lest we forget. Prof. Moureu's book affords an example of how to tell it.

T. E. THORPE.

Sport and Administration in Central Africa.

The Backbone of Africa: A Record of Travel during the Great War, with Some Suggestions for Administrative Reform. By Sir Alfred Sharpe. Pp. 232. (London: H. F. and G. Witherby, 1921.) 16s. net.

SIR ALFRED SHARPE first entered East Africa for the purpose of big-game shooting in about 1886. He was on long leave just then from a magistracy in Fiji. In 1887 he joined Lugard at the north end of Lake Nyasa, Lugard being engaged in a desperate fight with the Arab slave-traders established to the north-west of the Nyasa lake. In 1888 Sharpe was wounded in this bitter struggle, and in 1889 he returned and became a British Vice-Consul in that region. In 1891 he was made a Consul under the present writer's Commissionership, and served with him in what was then called "British Central Africa" until Johnston's transference to Tunis in 1897. Afterwards Sharpe became Governor of Nyasaland, and remained in that position until his retirement after the Coronation of King George in 1911. He was given a prominent part in the Coronation procession.

In 1912, unable to abate his interest in Africa, Sir Alfred Sharpe returned there as a private traveller and an adviser of highly placed trading companies. In this capacity, and still more as just one athirst for the solving of African secrets in fauna, flora, geography, and ethnology, he penetrated and re-penetrated the eastern half of Africa from the southernmost parts of Portuguese East Africa to the Sudan and Egypt in the years between 1912 and 1917. He had hoped to serve strenuously in our wars with Germany during much of that period, but just because he so singularly knew East Africa, South-east Africa, Uganda, and Tanganyika, any British commission was withheld from him by Lord Kitchener; and his war service, for which he was recently rewarded, was with the Belgian armies. Since 1918 he has been making a special study of Liberia and contiguous regions in West Africa.

The book here reviewed is of great interest because it is so truthful. Sir Alfred Sharpe has no object to serve other than that of telling the truth about Africa, whether it suits one's theories or not. Whilst the material of the present work was being put together he was already lecturing to the Royal Geographical Society on Liberia, in the most forested part of West Africa.

For the naturalist, the best parts of the book under review are the statements about elephants (Sir Alfred, though never an offender against big-

game regulations, has discriminatingly shot elephants in Central, South-east, North Central, and West Africa), about a sub-fossil relic of the small forest elephants of West Central Africa, the tsetse-flies, the giant gorilla in the Lake Kivu region, and the vast herds of cattle to be found in Ruanda, a region which since the Great War has been handed over to Belgium to administer. The author thinks that the cattle in Ruanda—of an exaggerated straight-backed Indian type, with immense horns—must amount to two and a half millions. They die away (I might add) when brought down from the upland region to the countries of the tsetse-fly at lower levels. Unfortunately, the Watusi of Ruanda, once the "great" people of all that region and under other names of the lands between Tanganyika, Victoria and Albert Nyanzas, have become deplorably idle and wanton, and circumstances will oblige them to pull themselves together and reform.

H. H. JOHNSTON.

Our Bookshelf.

The Modern Teacher: Essays on Educational Aims and Methods. Edited by A. Watson Bain. With an Introduction by Sir W. Henry Hadow. Pp. xv+272. (London: Methuen and Co., Ltd., 1921.) 10s. 6d. net.

THIS attractive volume contains ten essays, by writers of undoubted authority, on the chief subjects of school curricula, including civics, but excluding art and music. As each author has written independently of the others, there is a refreshing diversity in the modes of treatment. These vary from what is almost an apology by Mr. George Smith for the teaching of classics to Mr. A. W. Lucy's confident assurance, which allows him to plunge straight into practical details, in the case of mathematics. Even in defining the chief aims of education the essayists give conflicting opinions—which is all to the good, for it is when we think alike that we have ceased to think at all. In the section on science, for example, Mr. F. W. Sanderson reaffirms that it is the duty of education to "teach the average man the glory of his daily work and trade." The conspicuous success which has attended Mr. Sanderson's work at Oundle School makes his contribution to the volume a welcome one; the more so since, besides stating his ideals, he has indicated the lines along which they may be approached in practice.

The teacher who reads this book will not fail to find useful suggestions scattered about the more familiar paths of his knowledge; but probably its chief value for him will lie in the restoration of a true perspective, an appreciation of the complementary nature of the various branches of learning.

NO. 2695, VOL. 107]

The Yearbook of the Universities of the Empire. 1921. Edited by W. H. Dawson. (Published for the Universities Bureau of the British Empire.) Pp. xiv+571. (London: G. Bell and Sons, Ltd., 1921.) 15s. net.

WE are glad to be able to extend a welcome to the fifth edition of this useful volume. The plan adopted in the fourth edition of arranging the universities in groups—England, Wales, Scotland, Ireland, Canada, Australia, and so on—has been adhered to, and a brief introductory note precedes each group. A feature of the new edition is the numerous appendices, into which a vast amount of useful information has been incorporated. Short accounts are given of the institutes of accountants, architects, auctioneers, engineers, pharmaceutical chemists, and chartered secretaries, and of numerous other societies such as the Institute of Chemistry, the various colleges of physicians and surgeons of the United Kingdom, together with the regulations as to admission to these bodies. Particulars are also included of the matriculation examinations by joint boards and of inter-university scholarships, fellowships, etc. In Appendix XVIII, an account is given of the conditions under which undergraduates and research students are admitted to foreign universities. The facilities for foreign students in most of the principal universities in America and in Europe, with the exception of the German and Austrian universities, are included in this section. The records are necessarily brief, but the information brought together is not readily available in any other single volume, and it makes the book invaluable as a work of reference.

Laboratory Manual of Organic Chemistry. By Dr. H. L. Fisher. Pp. x+331. (New York: John Wiley and Sons, Inc.; London: Chapman and Hall, Ltd., 1920.) 12s. 6d. net.

FULL experimental details and numerous practical hints which should be found very helpful form an unusual feature of manuals of practical organic chemistry. The theory of the preparations is not given, even in outline, but references to other textbooks are provided. This method does not seem likely to be so successful as that in which a brief but clear account of the reaction is given before the experiment is described. The section on organic analysis, which takes up 92 pages, is out of proportion, and far too detailed for a book of this kind.

Annual Reports on the Progress of Chemistry for 1920. Issued by the Chemical Society. Vol. xvii. Pp. x+264. (London: Gurney and Jackson, 1921.) 7s 6d. net.

THE annual reports of the Chemical Society are valued as accurate and concise summaries of the main lines of advance in all branches of the pure science made during the year. The present volume maintains the high standard associated with previous issues.

Letters to the Editor.

[The Editor does not hold himself responsible for opinions expressed by his correspondents. Neither can he undertake to return, or to correspond with the writers of, rejected manuscripts intended for this or any other part of NATURE. No notice is taken of anonymous communications.]

The Constitution of Nickel.

MY latest experiments have enabled me to obtain the mass spectrum of the element nickel by using the vapour of nickel carbonyl mixed with carbon dioxide. The ordinary discharge tube was employed to produce the positive rays, and difficulties of maintaining a steady discharge were overcome to some degree by the use of comparatively high pressure and a heavy current. The rays were analysed in the usual way by means of the mass spectrograph.

The spectrum consists of two lines, the stronger at 58 and the weaker at 60. They are most conveniently placed between the mercury groups of the third and fourth order, with which they can be compared with an accuracy of 1/10th per cent. The results were also checked by comparison with the CO₂ line 44, and appear to be integral within the above error. Nickel therefore consists of at least two isotopes. The intensities of the lines are about in the ratio 2 : 1, and this agrees with the accepted atomic weight 58.68.

F. W. ASTON.

Cavendish Laboratory, Cambridge, June 10.

A Novel Magneto-Optical Effect.

EARLY in April last, while my son, Malcolm Thomson, was operating, in a building of the River Works plant of the General Electric Co., a resistance welder for closing the seams of steel Langmuir mercury vacuum pumps, in which work the current is applied and cut off at about one-half second intervals, there was noticed by one of the working force, Mr. Davis, who happened to be favourably located, a peculiar intermittent illumination of the space near the welder as the current went on and off. My son at once placed himself in a similar position and saw the novel effect, and noted a number of conditions accompanying it, perhaps the most important being that a single-turn loop from the welding transformer to the work and back was carrying about 7000 amperes, and that the luminous effect was spread in the space in which would be located the magnetic field from this loop; that the sunlight was entering the building through high windows and shining across the space in which the field was produced at intervals; that the effect was most conspicuous when one looked towards the shadows and across the sunbeams, and also across the magnetic field.

This would be expressed by saying that the best effect was observed when the line of vision was downward at an angle intersecting the entering sunbeams, and into the shadows under the beam furnished fortunately by a partition a few feet high, over which the sunlight came. The magnetic field, neglecting the curvature of the lines, was, generally speaking, at right angles to the line of sight and to the direction of the sunlight. My son also noticed that the effect of increased luminosity was coincident with the putting on of the current, and disappeared at once on cutting off the field. It was thus clear that it depended on the establishment of the magnetic field. He reported these facts to me, and they were confirmed by me. Other observers were soon enlisted, and on several favourable sunny days all the above

observations were confirmed by them. Further, my son had not been able to see any effect when looking across the sunbeam from the opposite side. This means that, with the sunbeams streaming in from the south, the effect was observed looking southward and downward, the windows admitting the light being to the south. Looking from the south across the beam gave no result, though it was not possible to look directly across the beam on a slant upward into any dark shadows and at the same time have the line of vision cross the magnetic field.

It is interesting to note at this point that the luminosity filled the whole space, and extended as far away as four feet or more from the magnetic loop, and that it was not especially noted as more intense near the loop than at a distance therefrom of, say, two feet or more.

Mr. Malcolm Thomson had further observed that by cutting out the loop from the secondary terminals (clamps) of the welding transformer, and simply joining those terminals by an iron bar, as is done in resistance welding, the luminous effect in the neighbourhood of the transformer was still visible, but was much more feeble than when the heavy loop was used. It occurred to me to examine the light by a large Nicol's prism. It was found that there was a distinct polarisation of the light from the space. This means that when the magnetic field was on the sunlight was scattered in the direction of the observer from the space occupied by the sunlight beam and the magnetic field, and that such scattered or deflected light was polarised.

It occurred to me, as a possible factor in the case, that as the building was used in part to carry on arc welding by iron arcs there might be suspended in the air of the building iron particles or finely divided oxides or compounds of iron which in some way were oriented by the magnetic field, resulting in the scattered light noted. This was confirmed in part by making the test observations when the large doors of the building had been open for some hours. The effect was present, though difficult to detect. This led to the suggestion to bring an iron arc into operation near the space in which the luminous effect had been seen. This was done, and with an enhancement of the effect.

At this stage the further observations were carried on in the Thomson Laboratory at Lynn, Mass., with the aid of the laboratory staff (A. L. Ellis, H. L. Watson, Dr. Hollnagel, and others).

Two sets of test apparatus were prepared at my suggestion. One large welding transformer was mounted in a special room, into which the sunbeams could be received in the afternoon as the windows faced south by west. The secondary terminals were joined by a large loop of heavy copper cable (about 12 sq. cm. section) of a loop diameter of 0.6 m. The loop consisted of two turns. The plane of the loop was vertical and was nearly north and south, or in a plane parallel to the direction of the entering sunbeams, so that the magnetic field would be in the main horizontal and transverse to the light of the sun entering downward as before. An iron arc was arranged to be operated so that the smoke from it would rise from below and enter the field of the loop, and by changing the relative position of the arc the smoke column, widening as it rose, could be made to bathe the turns of the coil, cross its axis, or, at a distance away, merely enter the field. As the experiments thus far had always involved connection to the shop plant, with 60-cycle alternating current, a check apparatus was set up, consisting of a storage battery (of a type such as is used in automobile

starting) arranged on a stand. In circuit with it, and under control of a switch, was a coil of about 0.2 m. diameter, and giving a field due to about 2500 ampere turns when the switch was closed. This second apparatus could be moved about, and was entirely independent of supply circuits or static disturbances which might be present in them.

The first tests were made with the transformer loop (representing a field of 20,000 ampere turns), and were very striking. The rising smoke from the small iron arc, only moderately visible in the sunbeam, became decidedly luminous when the field was put on. Each closure of the current switch to the primary of the transformer was instantly followed by the brilliant smoke effect, and the effect instantly disappeared on the opening. A black background had been provided in front of which the smoke rose. After the arc had been running a few minutes only it was seen that the air of the room was carrying sufficient of the smoke particles to give the effect anywhere in the space covered by the magnetic field and the sunbeams, even a number of feet away from the coil. In this case the appearance was as if in the air there were diffused some substance or material which became visible only in the combined sunlight and magnetic field. That in this case the luminous effect is not greater near the coil loop than some feet away indicates that orientation, or whatever causes the effect, is complete even in a rather weak field. Thorough ventilation of the room by opening windows caused the effect to fade out gradually by removal of the active particles.

The experiments with direct-current coil and battery conclusively showed that the effect was present with it as with alternating current, and incidentally established the fact that the effect on the particles is independent of the direction of magnetisation. It is doubtful if high-frequency tests would allow us to discover whether the establishment of the effect requires time. Probably not. Observations made through the axis of the loop of two turns show a minimum of effect, from which it may be inferred that it is not present if the viewing is exactly along the field-line direction.

Polarisation.—Having obtained, as described in the foregoing, a controllable and relatively brilliant source of the luminosity, tests with the Nicol's prism were resumed. It was soon noted that the polarisation was decided as controlled by the magnetic field. Moreover, the very curious fact was discovered by me, that the fumes from the iron arc were composite so far as analysis by the polarising prism was concerned. The bluish-coloured smoke arising gave but little effect, but there was with it a yellowish-grey fume, which was highly luminous in one position of viewing by the prism, and invisible when the prism was at right angles to that position. This indicates complete polarisation when the field is on for the light diffused from the particles in the yellowish-grey fumes. This is an extraordinary effect for which no explanation suggests itself, for the field lines are not straight, but wrap themselves around the coil or loop in curved directions, and the effect is apparently complete even with the fumes rising in the space where the lines are strongly curved.

It remains to use a vertical beam of light and make tests from opposite directions across the field, also to use artificial light instead of sunlight. It would seem possible to design a small demonstration apparatus consisting of a coil to be put on a battery or lighting circuit, A.C. or D.C., a small iron arc between two wires, a box with darkened interior to be filled with fumes, having two sides of glass, one for the admission of the light beam and the other a window at

right angles for observation. Two coils placed outside the box space and opposite each other, or capable of application in different relations, would have advantages. Eye shields to cut out extraneous light and a tortuous chimney conveying the smoke, but cutting off the light from the iron arc, are desirable additions to the equipment, as also an analyser as part of the apparatus for the polarisation effect.

The Microscope.—Attempts have been made to catch the particles in the smoke from the arc upon a glass slide for microscopic examination as to their form under high powers. That they are exceedingly fine is evident from their remaining in suspension so long in the air and diffusing themselves rapidly through the air. That an exceedingly small amount of material suffices for making the whole air of a large room capable of showing the effect is evident also. The sunbeam may enter the room, and its course is not disclosed by them unless the magnetic field exists. It seems natural to suppose that the particles consist of some form of iron or iron oxide, but without proof this cannot be fully decided. Other particles might exist, giving such an effect, but it must be confessed this does not seem probable. Other fumes and smoke from arcs so far have given no results. The smoke from a nickel arc does not give the effect. Whether a cobalt arc will yield fumes behaving like iron smoke is not yet known.

The fumes and smoke of an iron arc were caught on a clean microscope slide until a patch of sediment of a slightly yellowish-brown tint, but very pale, was deposited. Under moderate powers very little of any definiteness is shown, but under the high power of an oil-immersion lens of about $1\frac{1}{2}$ mm. focal length there is disclosed a curious structure of particles seemingly between 0.002 and 0.001 mm. diameter, which particles are frequently strung together, 4, 5, 6, or more, in a line, giving the effect of a short piece of chain made of small roundish particles, slightly spaced apart, or of a short section of a string of beads (round beads) not touching one another. Many of these structures appear to be straight, and some are curved. Evidently in a magnetic field these chains of particles, presumably of oxide of iron and magnetic, would line up and reflect or diffuse light of the sun striking them. If the direction of vision was such as to favour polarisation of the rays in a direction nearly at right angles to the incidence of the solar beam the polariscope effect would be accounted for measurably. Apart from polarisation, the lining up of the chains would also account for the extra visibility of the smoke under the conditions of the experiment.

It would seem from the foregoing that a considerable length of column of smoke from the iron arc, subjected transversely to a magnetic field, might be expected to act as a means of obtaining polarised light in the direction of the beam itself. This assumes that there will be a considerable scattering of light polarised as above described in a direction sidewise, leaving the light which passes through polarised in a plane at right angles. The apparatus might be compared in its action to a Nicol's prism, transmitting rays in one plane and throwing out laterally those in the other. This suggestion will be tested as soon as proper arrangements can be made.

The polarised light which is sent out from the smoke particles in a direction transverse to the sunlight beams, when the magnetic field is put on, is in the same plane as that reflected from a sheet of glass at the polarising angle receiving the same beam. This fact is in accordance with what might be ex-

pected if the short sections of chain or beaded particles were oriented or lined up by the magnetic field; the transverse waves of light vibrating in a plane intersecting the length of the chains would not be deflected on account of the extremely small diameter of the particles composing them, but waves vibrating in the plane of the length of the chains would be reflected to the side, and this would account for their plane of polarisation being what it is. Such waves would behave as if reflected from short rods in line with the plane of vibration, while the extremely small diameter of the rods would not sufficiently intercept the light vibrating in a plane transverse to their length.

The continuation of the investigation with artificial light and other varied conditions is anticipated.

ELIHU THOMSON.

Thomson Laboratory of General Electric Co.,
Lynn, Mass., May 23.

Geometrical Isomerism in Monomolecular Films.

IN the course of investigations on these films by a method differing only in details from that described by Langmuir (Journ. Amer. Chem. Soc., 1917, p. 1868) I have found striking differences between the properties of films formed from the "cis" and "trans" forms of some fatty acids containing an ethylenic linkage, which indicate that of the two pairs of acids, oleic and elaidic, erucic and brassidic, oleic and erucic are the "cis" forms and elaidic and brassidic the "trans." The results appear to be consistent with Langmuir's conception of the structure of the films, and this stereochemical configuration is that usually regarded as correct from chemical considerations.

According to the theory, the films are one molecule in thickness. With saturated acids, such as palmitic, the molecules are attracted to the water by the

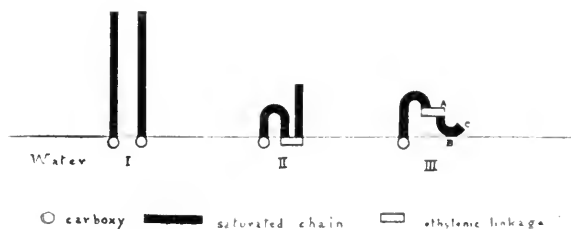

FIG. 1.

carboxyl groups, and are arranged as in Fig. 1, I. Unsaturated acids are also attracted by their ethylenic linkages, and when, as in the acids mentioned, these are approximately in the middle of the chains, the molecules in the film will take up the position in Fig. 1, II, or III. The attraction of the double bond for water is less powerful than that of the carboxyl, and when a lateral compression is applied to the film the area per molecule will diminish by some or all of the molecules straightening out to the position I.

Fig. 1 shows that a difference is to be expected between the "cis" and "trans" isomers. The double bond in the "cis" form can approach as closely as desired to the water, but in the "trans" form the saturated portion of the chain ABC must be forced in among the water molecules. Although it is known from stereochemical considerations that a hydrocarbon chain is flexible, yet its radius of curvature cannot be reduced below that of a ring of five carbon atoms without encountering resistance; there will, therefore,

probably be a considerably greater resistance to the approach of the double bond to the water in the case of the "trans" form than in the case of the "cis."

The results obtained point clearly, I think, to a greater tendency to occupy the larger area with oleic than with elaidic acid, and a larger with erucic than with brassidic acid. Oleic acid, when first put on distilled water and a compression of about 1.4 dynes per cm. applied to the film, occupies about 40×10^{-16} sq. cm. per molecule; the area decreases steadily with time, however. Elaidic acid occupies about 30 units of area at the earliest moment when readings can be taken, and the area diminishes rapidly to about 22 units, when the film behaves like one of palmitic acid.

In the 22-carbon series there appears to be a smaller tendency than in the 18-carbon series for the double bond to approach the water. Erucic acid gives films rather similar to elaidic acid, but brassidic acid occupies the greater area for so short a time that the curves of compression of the films are not very different from those of a saturated acid such as palmitic.

It is hoped to amplify these experiments and publish full details later.

N. K. ADAM.

Trinity College, Cambridge, May 28.

Sources and Sinks.

LORD KELVIN in a paper "On the Forces Experienced by Solids Immersed in a Moving Liquid" (Proc. Roy. Soc. Edin., 1870) compared two tubes, with liquid flowing through each, with two hard steel magnets and stated that the forces are opposite in the two cases; unlike poles attracting and like poles repelling in the magnetic system, while in the hydrokinetic there is attraction between like ends and repulsion between unlike.

That two sources of like sign attract and two of unlike sign repel, as here stated, is generally accepted. An examination, however, of the case of a source and an equal sink appears to contradict this. When source and sink coincide the fluid medium is at rest, but when they are separated it is in motion and possesses kinetic energy. Work, therefore, must be done to effect the separation. This suggests that the force between source and sink is one of attraction. That this is actually the case is shown by the following experiment.

Two glass tubes A and B (Fig. 1) are connected by short lengths of rubber tubing to short tubes, which pass about 1 cm. apart through a cork in the neck of a Winchester bottle full of water. The tube A is connected to a water-supply and its open end constitutes an experimental source. The end of the tube B is an equal sink. The source and sink attract smartly and the ends of the tubes remain in contact so long as the water flows.

A. F. DUFTON.

The Royal School of Mines, South
Kensington, May 25.

Polarisation Phenomena in an X-ray Bulb.

HITHERTO the potential difference required to produce a discharge through a well-exhausted vacuum tube has been considered to vary only with the pressure of the gas. In the course, however, of some experiments with an X-ray bulb (where the pressure

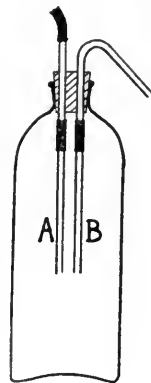

FIG. 1.

could be regulated by a Gaede pump and measured by a McLeod gauge) a continuous discharge was maintained for about eight hours on several consecutive days, and I have observed a gradual hardening in spite of the maintenance of a comparatively high pressure. Further experiments carried out in this direction have revealed a remarkable effect which takes place in an X-ray bulb or, more generally, in any vacuum tube after a sufficiently long and continuous run—an effect similar to the polarisation of an electrolytic cell. This is, that after the discharge has been kept running for a sufficiently long time through a tube (inside which the pressure is kept nearly constant) a time arrives when the current flowing through the tube begins to decrease, and finally ceases altogether. To continue the discharge it is then necessary to increase either the potential difference applied to the electrodes or the pressure inside the tube. By repeating this operation several times I could ultimately reach a stage where a potential difference of more than 50,000 volts was not sufficient to produce a discharge in the bulb, although the pressure was as high as 0.060 mm., whereas under ordinary conditions in the same bulb a much smaller potential difference was sufficient to produce a discharge under a pressure of the order of 0.001 mm. After the discharge has been stopped the bulb gradually returns to its normal condition, but afterwards a comparatively short run is sufficient to bring the bulb back to the state of polarisation.

It could be further shown that the effect is not due to changes in the nature of the gas in the bulb brought about by the discharge. A large side-tube containing two electrodes, the shape and distance apart of which were essentially the same as in the X-ray bulb, was fused into it. When after a long run the main bulb became polarised, so that the highest available voltage could not break down its resistance in spite of a high pressure of about 1/20 mm., a potential difference of 1200 volts, supplied by a battery of small cells, when put across the side-tube was found to produce a normal discharge.

Experiments, which will be described elsewhere, give some evidence in support of the view that this effect is due to the destruction by the discharge of the gaseous layer on the surface of the electrodes.

It seems probable that the hardening of an X-ray bulb with usage is due not only to the disappearance of the gas in the bulb, but also to the phenomenon described in this letter.

S. RATNER.

The Physical Laboratory, Victoria University,
Manchester, June 1.

Observations of Plant-growth with the Recording Ultramicrometer.

At the meeting of the Royal Dublin Society on January 25 last, as reported in NATURE for February 24, p. 850, I described a form of ultramicrometer in which the minute movement of one plate of a parallel plate condenser, forming part of a thermionic-valve oscillating circuit, is recorded by a galvanometer. We are now applying this apparatus to the study of plant-growth, and as some of the preliminary observations show very clearly the pulsations of growth described by Sir J. C. Bose, it may be of interest to give a short account of these results.

In applying the method to this problem the upper plate of the condenser is a thin aluminium disc, about 6 cm. in diameter, supported by a long flat strip of spring steel, so as to be situated about 1/10 mm. above the lower fixed (horizontal) plate. The latter plate may be given small vertical movements by means of a micrometer screw for adjustment or cali-

bration of the apparatus. In many of our observations the apparatus is adjusted to give 150 divisions on the galvanometer scale for a displacement of the upper plate through 1/1000 cm., but it can be made many times more or less sensitive simply by altering the galvanometer shunt.

To the recording (upper) plate is rigidly attached a short wooden arm against which the plant member presses lightly. It is found that a weight of 1/10 gram placed on this causes a galvanometer deflection of 100 divisions. This indicates the order of magnitude of the stress on the plant under observation. During experiments on roots the root-tip presses

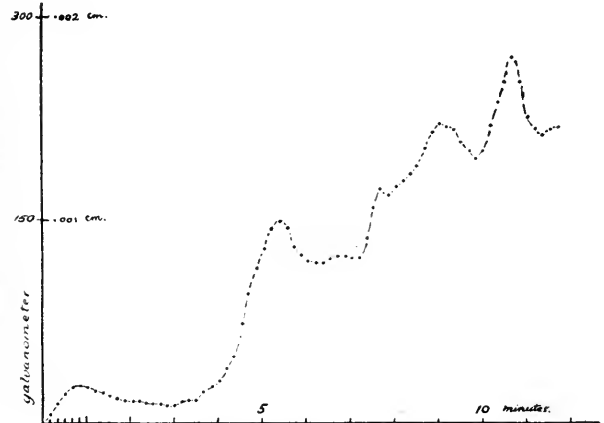

FIG. 1.—Broad bean root-shoot (four days old).

the plate downwards; in other cases the movement is upwards.

As an example of one type of record obtained the accompanying curve is appended. It represents the (downward) growth of the root-shoot of a broad-bean which had been planted some four days before and had just been removed from the ground. A considerable time had been allowed to elapse after placing the plant in position before observations were commenced.

I have to thank two botanical students, Miss Cannon and Mr. Saunders, for the part they are taking in the work.

JOHN J. DOWLING.

Department of Physics, University College,
Dublin.

Cup and Ring Markings.

REFERRING to the note anent the above which appeared in NATURE of June 9, p. 468, may I mention that these peculiar surface-features can frequently be seen upon old mortar, stucco, and calcareous sandstones, and that they are due to molecular re-arrangement of the calcium carbonate, and not to any artistic efforts on the part of prehistoric man, as is frequently supposed?

At the Royal Society in 1896 I exhibited photographs of some remarkable examples of "cup and ring markings" which had developed on the stucco of one of the houses in Warrior Square, St. Leonards-on-Sea. Similar "patterns" may sometimes be seen on old "American cloth" which has been subjected to tension, and also on old oil paintings. In these cases the gradual shrinkage of the canvas backing has produced the effect by causing lines of fracture in the more homogeneous layers of paint.

June 11.

C. CARUS-WILSON.

Some War Developments of Explosives.¹

By SIR ROBERT ROBERTSON, K.B.E., F.R.S.

IT is not proposed to describe the great factories that arose during the war for the manufacture of explosives, but to indicate by one or two examples some of the conditions which led to developments.

PRODUCTION.

The enormous weekly production was reached of 1500 tons of trinitrotoluene, 300 tons of picric acid, 3000 tons of ammonium nitrate, and 2000 tons of cordite. To produce these were required such weekly quantities as the following: 6600 tons of pyrites, or 2700 tons of sulphur, 8300 tons of Chile saltpetre, 720 tons of toluene (from 600,000 tons of coal), 162 tons of phenol (which would have required 1,000,000 tons of coal, if synthetic production had not been established), 700 tons of ammonia (from 250,000 tons of coal), 374 tons of glycerine (from 2700 tons of fat), 700 tons of cotton cellulose (from 1060 tons of wastes), and 1200 tons of alcohol and ether (from 4200 tons of grain).

These numbers indicate not only the magnitude of the production, but also the interdependence of a large number of industrial chemical activities, and, although many of the products were derived from our own coal, it brings home the dependence of the country on overseas transport of many of the essential substances, such as pyrites, sulphur, Chile nitrate, and cotton.

FIRING AND DETONATION OF A SHELL.

The Propellant.—The processes for the manufacture of cordite and of its ingredients had been the subject of study, and considerable advances had been made, so that it might fairly be claimed that this country led the way in the technique and safety precautions involved in the manufacture of propellants. The existing factories were also capable of extension, until the demand became so great that additional ones had to be erected.

At first, the propellant used was cordite M.D., composed of nitroglycerine, guncotton, and mineral jelly, in which acetone was used to gelatinise the guncotton. A nitrocellulose powder obtained from America was also used. The demand for propellant to be made in this country ultimately reached 1500 tons a week, and this, even with an efficient system of acetone recovery, would have involved an expenditure of that solvent of above 400 tons a week. On account of the shortage of supply of this solvent, a new propellant for the Land Service was introduced—cordite R.D.B.—in which ether-alcohol was substituted for acetone as a solvent, a change necessitating the choice of a nitrocellulose of a lower degree of nitration than guncotton, and alterations in the proportions of the other ingredients. For the

new propellant the conditions were laid down and met that it should have the same heat energy, that it should give the same ballistics as cordite M.D., in order to avoid alteration in calculating ranges. From data obtained with the older propellant, and that it should be capable of being manufactured by the machinery available and with the technique of manufacture known in the country.

The main changes introduced were in the manufacture of the nitrocellulose and in the supply of the solvent. As ether-alcohol is a less powerful solvent than acetone, even for the special nitrocellulose employed, a strict definition of the nitrocellulose was necessary, and the necessity to provide this in suitable form led to much investigative work on the nature of the cellulose, with the result that its manufacture was brought under a system of strict chemical control. This control had among its objects the elimination of ligneous impurities and the standardisation of the viscosity of the cellulose, since if its viscosity were uniform and low, it was found that the gelatinisation of the nitrocellulose when incorporated with the nitroglycerine and mineral jelly was greatly facilitated, and the production of uniform cords assisted. Ligneous matter in the cellulose was rendered visible by a process in which the woody matter was selectively dyed, and the viscosity of the cellulose was measured by the rate of fall of a steel sphere falling through a solution of cellulose.

The supply of alcohol was obtained entirely from the distilleries of this country, and a large plant for converting a portion of it into ether was erected at Gretna. Nearly 1000 tons of alcohol, or the equivalent of about 200,000 gallons of proof spirit, were required for the production of the 1500 tons of R.D.B. cordite a week, and this requirement it was which led to the restricted sale and increased cost of whisky.

THE HIGH EXPLOSIVE SHELL.

Prior to the war the Land Service used for the most part shrapnel shell, designed to project a shower of lead bullets, efficacious against *personnel*, but of little value in attacking fortified positions, for which high explosive shell are required.

Shrapnel was very largely used by the Land Service throughout the war, but the earlier type of high explosive shell filled with lyddite (picric acid), and brought to explosion by the ignition of a fiercely burning mixture, was abandoned for one in which true detonation was secured with certainty. The latest type of high explosive shell was exemplified by a 4.5-in. howitzer shell fitted with a graze fuze (Fig. 1).

The Fuze.—A graze fuze is a mechanism which gives rise to a flash when the shell grazes on

¹ Summary of a Friday evening discourse delivered at the Royal Institution on May 6.

the ground. It must be capable of being handled roughly without firing, and must not act when the considerable forces involved in firing it from a gun are impressed upon it and upon all its parts. The magnitude of these forces is illustrated by the fact that a fuze weighing $2\frac{1}{2}$ lb. when fired from an eighteen-pounder gun weighs about 11 tons—the stress corresponding to 15,000 times the acceleration due to gravity. These forces are taken advantage of to render the fuze “live”—that is, to put it into a condition when it will act on the slightest provocation.

In the interior of the fuze is a brass cylinder with an axial hole, on the top of which is placed a capsule containing a highly sensitive flash composition. To prevent this cylinder from moving forward in handling, a bolt lies athwart its top edge, and this bolt is retained in this position by a small pin placed vertically at the back of the bolt and having its base pressed upward by a spring working in a vertical cylindrical cavity. On firing, this pin, weighing 1.3 grams, is acted on by a force equivalent to 20 kg., overcomes the resistance of its spring, and recedes into its cavity. The force due to the shell's rotation causes the bolt to fly outwards, thus freeing the brass cylinder, which now is prevented from moving forward on to a needle only by the interposition of a light spring. The fuze is now “live,” and on the slightest check being given to the forward movement of the shell, as, for example, by grazing on soft earth, the cylinder moves forward by its own inertia on to the needle, which pricks the capsule, causing a jet of flame to pass down the centre of the fuze. The object of all this mechanism is to supply at the proper time a flash for operating the next member, the *gaine*, where it gives rise to a detonation.

The Gaine.—This is a tube (from French *gaine*, a sheath) with steel walls of quarter-inch annulus. In its upper portion is a pellet of gunpowder which is ignited by the flash from the fuze, and sends a larger flash on to an open capsule containing fulminate of mercury situated over pellets of tetryl. The fulminate detonates, and in turn causes the tetryl to detonate, and to deliver from the bottom end of the *gaine* a very intense blow to a series of explosive intermediaries which communicate the detonation to the main bursting charge.

Intermediaries.—The first of these is a bag of T.N.T. crystals situated in a thin steel container tube which encloses it and the *gaine*. This T.N.T., on detonation, brings to detonation an annular layer of T.N.T. cast round the container, and this in turn brings about the detonation of the main charge of the shell. The train of detonation is thus somewhat complicated, and in its evolution many important principles had to be observed.

Sensitiveness and Violence.—Thus the sensitiveness of the various explosives used had to be de-

termined, since, on account of the magnitude of the acceleration imparted to all parts of the shell on firing it from a gun, a column of a sensitive explosive over a certain length and weight will be liable to detonate on account of the sudden force applied. In proportion to their sensitiveness to mechanical shock, therefore, explosives in shell must be graduated in regard to length of column employed. A general principle is to have next to the detonator a somewhat sensitive explosive, and to reinforce the impulse derived from it by one less sensitive, but still delivering an intense blow. It is important, therefore, to have quantitative values for the sensitiveness of explosives to mechanical shock, and some of the values thus obtained are given in the following table:—

	Figure of insensitiveness (Picric acid=100)
Mercury fulminate	10
Nitroglycerine	13
Dry guncotton	23
Tetryl	70
Tetranitroaniline	86
Picric acid	100
Trinitrotoluene	115
Amatol 80/20	120

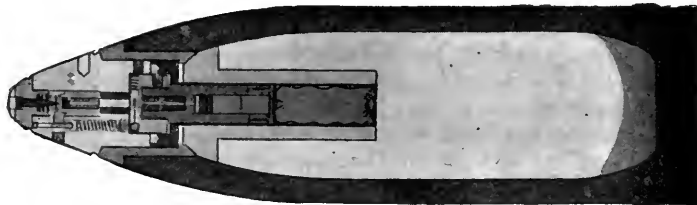

FIG. 1.

It is important also to know the violence of the various explosives used, both by themselves and also when assembled in the various components, and it was in this connection that the principle of the pressure bar, enunciated by the late Prof. Bertram Hopkinson in a discourse to the Royal Institution in January of 1912, was of the greatest value. This depends on the experimental resolution of the momentum of the blow into pressure and time. When a charge is fired against the end of a cylindrical steel bar ballistically suspended, a wave of compression travels along the bar and is reflected at the far end as a wave of tension. To investigate the properties of the wave, a short length of the end of the bar farthest from the end to which the blow is delivered is cut off and the faces are surfaced, the short piece (known as the time-piece) being caused to adhere closely to the bar, usually by a film of vaseline. The compression wave travels unchanged through the joint into the time-piece, but the reflected tension cannot pass through it. Hence when the amplitude of the reflected tension wave reaching the joint becomes greater than that of the oncoming compression wave, the time-piece is projected from the shaft with a momentum which depends on the pressure exerted by the explosive

and the time taken by the wave to traverse the length of the time-piece. This momentum is measured by catching the time-piece in a ballistic pendulum, and, the velocity of the propagation of the wave through steel being known, the mean pressure exerted during an extremely small time interval can be calculated.

(One of the instruments for determining the pressure developed by a detonator was shown, and a detonator fired, the mark drawn by the swing of the pendulum which caught the time-piece being shown on the screen.)

The application of this apparatus not only gave important information as to the limiting quantity of fulminate necessary to bring about complete detonation of the tetryl and as to the effect of the thickness of the wall of the gaine, but it also emphasised the necessity for avoiding gaps in the train of detonation on account of the very rapid falling off in violence of the blow when even a small air-gap is introduced.

Main Filling.—It was early recognised that the supply of picric acid and T.N.T. by itself would be quite insufficient. It was at this point that the late Lord Moulton took steps to secure supplies of essential explosives and their ingredients, with such success that the supply of explosives in no long time came to be ahead of the demand. But even when a method for the production of T.N.T. had been worked out, and its supply on a fairly large scale was in prospect, it was apparent that the demand for high explosive was such that it could not be met by the supplies of nitro-compounds in sight.

Experiments were then made to test the capabilities of mixtures of ammonium nitrate and trinitrotoluene for shell filling, and these gave much promise from the start. They were found to possess the requisite degree of inertness and insensitiveness to enable them to withstand setback on firing from a gun, to have a high rate of detonation, and when detonated in a shell, as was done first in March, 1915, to give evidence of the required violence necessary to fragment the shell.

The first mixture (later termed amatol 40/60, these being the proportions of ammonium nitrate to T.N.T.) was capable of being poured as a thick porridge into shell, and so presented few difficulties for large-scale production. This was at once followed up by similar experiments with a still greater proportion of ammonium nitrate, up to that which is practically the theoretical one for complete combustion of all the carbon of the trinitrotoluene to carbon dioxide, and of all the hydrogen in both substances to water. This explosive, amatol 80/20, was fired in a shell in April, 1915, and gave excellent results. Its explosive properties, as regards insensitiveness, stability, and tests for power, were satisfactory, and it was almost immediately approved as a Service explosive.

Amatol 80/20.—The development of amatol 80/20 was slower. Prepared originally on the large scale by bringing together the finely powdered ingredients in a mixing machine, or by grinding them under edge-runners, 80/20 amatol was ultimately most readily produced by taking advantage of the plasticity of the heated mixture due to the trinitrotoluene melting. Hydraulic presses were used for introducing the powdered or ground explosive into shell; for the plastic 80/20, a worm feed was found expeditious and rapid.

In the course of the manufacture of the enormous quantities of these substances many points of interest and of difficulty arose, which were solved by the assistance of more and more scientific investigators.

The following tables give some data on the explosive properties of the amatols in comparison with some other explosives:—

Heat of Detonation and Gases Evolved.

	Calories per gram (water gaseous)	Total gases c.c. per gram
Picric acid ...	914	744
Trinitrotoluene ...	924	728
Amatol 40/60 ...	920	892
Amatol 80/20 ...	1004	907
Tetryl ...	1090	794
Guncotton ...	892	875
Nitroglycerine ...	1478	713

Rates of Detonation.

	Density of loading (Liquid)	Metres per second
Nitroglycerine ...	(Liquid)	8000
Tetryl ...	1.63	7520
Guncotton (dry) ...	1.20	7300
Picric acid ...	1.63	7250
Trinitrotoluene ...	1.57	6950
Amatol 40/60 ...	1.55	6470
Amatol 80/20 ...	1.50	5080

Pressures developed by Ammonium Nitrate, Amatols, and T.N.T.

Ammonium nitrate	Trinitrotoluene	Tons per sq. in. in 0.5×10^{-5} sec.
100	0	12.5
99.5	0.5	15.2
99	1	18.3
98	2	20.0
95	5	25.2
90	10	30.5
80	20	38.1
40 (at density 1.55)	60	53.9
0 (at density 1.55)	100	55.0

It will be seen that the addition of 40 per cent. of ammonium nitrate to T.N.T. does not markedly reduce its heat value, rate of detonation, or pressure developed, and that amatol 80/20 has a high content of heat energy, but a rate of detonation and pressure lower than T.N.T. itself. It is, however, still sufficiently violent to fragment shell satisfactorily, and the somewhat slower development of the pressure, together with the high calorific value of the explosive, may be of advantage in enabling the fragments to acquire a

higher velocity. It will also be observed that ammonium nitrate itself under a powerful initial impulse gives rise to a notable pressure, so that that ingredient is not to be looked on as a diluent of the T.N.T., but as an explosive substance, as well as a purveyor of the oxygen in which T.N.T. is deficient.

Smoke.—For the purpose of correct ranging and locating the position of burst, an explosive developing smoke is desirable. Amatol 80/20, when used alone, had the disadvantage that it gave no smoke, as the products of the detonation are colourless gases, thus :—

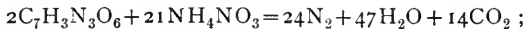

whereas, when picric acid or trinitrotoluene detonates, a large quantity of unconsumed carbon is set free, affording a black cloud useful for the purpose of observation.

Mixtures capable of producing a white smoke, useful for aerial observation, were then added, and as a result of investigations as to the best method of securing its dissociation, ammonium chloride in conjunction with the ingredients of amatol was localised at the base of the filling.

Needless to say, there were many other developments in explosives practice during the war, but the example of the train of detonation leading up to the complete detonation of a high explosive

shell was chosen to exemplify the subject of this discourse, since it included many features and new problems which had an intimate connection with the technical development of the subject.

To secure the high percentage of detonations that our artillerists obtained with the freedom from prematures which they always demanded, it was necessary to have each part of the somewhat complicated train as nearly perfect as possible not only in design, in order to withstand the effects of rough usage and of set-back in the gun, but also in workmanship, both mechanical and chemical as to purity of materials. This was achieved by the co-ordination of a large number of industries organised on a scientific basis, and these were becoming every day more and more efficient. War is now so highly organised that for its successful prosecution all the technical industry of the country is brought under requisition, and to succeed requires a higher development in research, applied methods, and industrial progress than belongs to the enemy.

The effort made by this country in the time of stress to overcome deficiencies in these respects was successful as a great technical achievement, and should be an encouragement to us to look forward to an equal development of our scientific industries under the stress of a competitive peace.

Stellar Parallax.¹

By SIR FRANK DYSON, F.R.S.

IN the past ten years a number of the large telescopes of the world have been applied to the determination of stellar parallax. The principle of the method is well known and is extremely simple, merely consisting in the detection of the small annual movement of a near star with reference to more distant stars caused by the different position occupied by the observer in consequence of the earth's annual revolution round the sun. The whole difficulty consists in the extreme minuteness of the angle to be measured. If two railway lines, starting at King's Cross, instead of remaining parallel, met at Newcastle the angle between them would be of the order of the angle to be measured in finding the distances of the nearest stars. To form an idea of what is now being done by large telescopes using photographic methods, imagine two plumb-lines 5 ft. apart. They are sensibly parallel, but actually meet at the centre of the earth, and the angle between them is 0.05". An angle of this size is measured with an accuracy of $\pm 0.01''$. Results of this high value were first obtained by Prof. Schlesinger at the Yerkes Observatory. At the present time the observatories of Allegheny, Greenwich, McCormick, Mount Wilson, Yerkes, and a number of others are engaged on a

comprehensive programme. At Greenwich we determine the parallaxes of fifty stars a year; at some of the American observatories many more.

Necessarily, a good deal of care is required both in taking the photographs and in measuring them. The image of a star may have a diameter of 2" or 3", and the position of its centre should be measurable to between 1/50th and 1/100th of this amount. The methods of measurement present some points of interest which need not be described now, but a word or two about the precautions to be observed in taking the photographs may be of interest. The images must be as circular and uniform as possible. (1) The guiding of the telescope must be as perfect as possible. (2) The lenses of large object-glasses must be adjusted with great care so that there may be neither tilt nor eccentricity between them. (3) Photographs should all be taken with the telescope pointing in the same direction. One cannot be taken when the field is east and another when it is west. Atmospheric dispersion and possibly minute flexure of the lenses cause slight deformation of the images which may be scarcely visible to the eye, but appear in measures. (4) The star the parallax of which is being determined and the comparison stars should have approximately

¹ From a discourse delivered at the Royal Institution on Friday, April 29.

equal images on the photograph. This is secured by means of a rotating shutter, a neutral screen, or the use of a grating in front of the objective.

The purpose of (3) and (4) is to make any residual errors the same for the parallax star and the comparison stars, and so far as possible the same on all photographs.

The knowledge of the distance of a star gives us immediately its luminosity or the amount of light it emits as compared with the sun. There is a very great range in luminosity even for stars of the same spectral type. Now the stars have been arranged in an order according to the spectra, which agrees fairly well with their order in colour from blue to red, and is essentially an arrangement according to temperature. This may be regarded as an extremely good first approximation to a classification of stellar spectra. But it does not detect any differences attributable to absolute luminosity, though presumably density and gravity at the surface layer of the star from which the lines in the spectrum have their origin must be widely different.

A few years ago a very fruitful investigation was commenced at Mount Wilson by Adams and Kohlschuter. By a close comparison of the spectra of stars of the same spectral class, but differing greatly in absolute luminosity, they detected lines the intensities of which differ. Adams and his coadjutors at Mount Wilson have pursued this research with very great success. They have found in stellar spectra a number of pairs of neighbouring lines, one line of each pair being independent of the absolute luminosity, while the other changes in intensity with the luminosity of the star. They have measured the relative intensities of these pairs of lines, and compared their measures with the luminosities of 650 stars already known through the trigonometrical determinations of parallax made at Allegheny, McCormick, Mount Wilson, and Yerkes. Thus they have found the luminosities of stars corresponding to different intensities of the lines. They have recently published a catalogue (*Astrophysical Journal*, March, 1921) giving the luminosities and parallaxes of 1680 stars.

The advantage of this method is that it extends the range of parallax determinations beyond the limit (say) 0.02" of the trigonometrical method, the limit of the spectroscopic method being determined only by the capacity of large telescopes to give measurable spectra. In the table a comparison is given with unpublished results at Greenwich obtained by the trigonometrical method:—

No.	App. mag.	Mag. at 10 parsecs ".	Parallax	
			Mount Wilson	Greenwich
B 1673	5.6	4.2	0.052	0.034
B 2897	6.1	4.3	0.044	0.040
B 2971	7.8	7.2	0.076	0.088
C 1604	8.2	4.9	0.022	0.015
B 3983	6.9	5.7	0.058	0.052
B 4181	5.0	1.7	0.022	0.041
B 4234	6.4	2.4	0.016	0.013
C 2242	7.6	5.4	0.036	0.046
B 4322	4.8	3.6	0.058	0.031
B 5009	4.8	3.8	0.158	0.171
B 6129	6.6	6.7	0.105	0.076

Comparison of these results, obtained by entirely different methods, shows the accuracy of 20 per cent. claimed for Mount Wilson, and $\pm 0.010''$ for Greenwich is reached.

A third method is being employed extensively for determining stellar distances depending on the fact that the masses of stars lie within very restricted limits. It is applicable only to double stars, and depends on Kepler's third law, $M + m = a^3/P^2$, where M , m are the masses, a is the mean distance between the components, and P the period of a double star. When P is known and $M + m$ assumed, a is found, and, further, as the cube root of $M + m$ is involved, an error in the assumed mass produces a much smaller error in the mean distance. Now the *angular* mean distance is determined by direct observation for all double stars the orbits of which can be calculated. At the present time this amounts to more than 150. But it has been shown by Hertzsprung and Russell that for double stars which have completed too small a portion of their orbits for their periods to be known it is still possible to obtain their "hypothetical" parallax with considerable probability. The method has been recently applied at Greenwich to obtain the parallaxes of a large number of stars, and the accordance with the results found by the trigonometrical and spectroscopic methods is very satisfactory (see a paper in *Monthly Notices R.A.S.*, November, 1920, by Messrs. Jackson and Farmer).

I believe there is in preparation by American astronomers a catalogue giving the parallaxes of 3000 stars, about half of which have been determined by two at least of these three methods. We may expect that in the course of a very few years the distances of all stars visible to the naked eye in the northern hemisphere will have been determined, as well as those of many fainter stars. This great accession of knowledge of stellar distances carries with it a corresponding increase with reference to the luminosities, sizes, masses, densities, and velocities of stars of different spectral classes.

Obituary.

WILLIAM WARDE FOWLER. 1847-1921.

WARDE FOWLER, like Arthur Sidgwick, was one of the men we can least spare—a classical scholar of distinction and a writer of great charm who sympathised warmly with the

aims and methods of science, and strove to give them a larger place in the life of his University. It would scarcely be possible to gain a clearer insight into the strength and weakness of an Oxford education as it was nearly twenty years

ago than by reading his "Oxford Correspondence of 1903" (Blackwell, Oxford; Simpkin, Marshall and Co., London) between a college tutor and one of his pupils whose eyes are opened to the meaning of research by meeting a Zürich Professor in the Long Vacation. Warde Fowler's opinions and the long experience on which they were based appear in the charming letters of the tutor. We owe it to him, and many others like him in this respect that the years since 1903 have brought a steady growth in the amount of original work and in the significance attached to it by the University.

In the brief space available I do not propose to say more of Warde Fowler's writings, excellently described in the *Times* of June 16, than just this—that he brought to his classical work the spirit of the naturalist, always seeing through the beautiful veil of literature to the everyday human lives and interests that lay behind, and as he delighted in them himself, so he made them a delight to others.

He was a most interesting and arresting lecturer, and had the supreme gift of selecting and describing an observation so that it both illuminated and fixed in the mind some far-reaching conclusion. No one could forget that the lines of bird-migration are determined, and may be varied, by sight and memory, after hearing him tell of the misty autumn day when he stood on the chalk cliff near Swanage and watched the little bands of swallows arriving from the west and flying round the English coast to the north of the Isle of Wight, on their eastward journey, to cross near Dover; and lo! as he stood watching, there suddenly arrived a band which acted very differently, circling up into the air and darting directly eastward across the sea; and then, following their flight, he saw for the first time what they had seen, that the mist had lifted and the Needles were in sight. Then, and then only, had they taken the direct and shortest eastward route along the chalk midrib of the Isle of Wight.

Or he would tell of the thrush that, in the middle of its song, saw one of its young carried off by a cat, and expressed its emotions by singing more loudly and passionately.

Or it was the want of attention in observation that was illustrated by the fishermen, he being one of them, who, after their day's sport was over, began discussing the position of the fins of the trout, and, unable for the life of them to remember the arrangement, paid a visit to the larder to find out!

It is interesting to compare with this experience the unconscious yet keen attention and the sure memory which come into play when man observes his fellow man. And this is to be expected. There have been long periods when the recognition of a man by his shoulder or head seen from behind, or by his gait, has meant the difference between life and death.

The memories I have recalled belong to the early days of the Ashmolean Natural History

Society of Oxfordshire, and probably all are more than thirty years old. The charm and arresting personality of the speaker have left them clear and bright.

E. B. P.

R. E. DENNETT.

MR. R. E. DENNETT, who died in London on May 28 at the age of sixty-four, was a student of the religions, languages, and customs of the indigenous races of West Africa, and his work was marked by great ability and originality. Son of an Anglican clergyman of unusual individuality—a Devonshire man—Mr. Dennett was born at Valparaiso, and had his early education at Marlborough School. He went out to West Africa in his early twenties, and he spent more than forty years in Nigeria and in what are now the French and Belgian Congo territories. Comparatively early in his career he was brought into association with that remarkable woman, Mary Kingsley, and his mind, already sympathetically disposed towards the native races, received an additional powerful impetus in the same beneficent direction. Thereafter he bent a great part of an intellect naturally strong to the attempt to interpret the character and institutions of the Africans to the reading public in Great Britain.

Mr. Dennett had special opportunities for observation, for in turn he was trader, explorer, and official, a combination not often found in one person. It was (indeed, still is) work highly necessary, for it is probably safe to say that the main impression left upon the minds of most people in Britain as the result of reading the accounts of the Stanley expeditions was that all Africans are absolutely primitive and all at the same stage of development. Nothing could be more grotesquely inaccurate, and Mr. Dennett's careful, patient, above all sincere and sympathetic, researches did much to make clear the truth, which is, of course, that the greater facts of man's life are represented among Africans by institutions and observances much the same in root significance as those of Europeans, but in some respects less highly developed. He believed firmly that the most hopeful course in British West Africa was, while suppressing accompaniments of native rule which are inconsistent with individual rights, carefully to preserve and support the main body of African custom, which he held to be essentially just and based upon the life and needs of the people. That is to say, he wished the African to be governed by his own people in his own way, the European Powers keeping the peace while the native races gradually advanced along their own lines.

Of several noteworthy books that by which Mr. Dennett will best be remembered is probably "At the Back of the Black Man's Mind," a close and penetrating study of the great subject indicated by the title. Others are: "Seven Years among the Fjort," "Nigerian Studies," "My Yoruba Alphabet," "Universal Order," and "Periodic Law." One of the most painstaking of inquirers,

Mr. Dennett was also one of the most genial and simple-natured of men, and his death will be most deeply regretted by a wide circle here and in Africa. C.

SIR THOMAS WRIGHTSON, BART., M.INST.C.E.

SIR THOMAS WRIGHTSON, BART., a master of industry in the North of England, died at Neasham Hall, his seat on the banks of the Tees, on June 18, in the eighty-second year of his age. Like his cousin, the late Lord Armstrong, in whose Elswick works he served his apprenticeship, Sir Thomas combined a business aptitude with the qualities which go to make a research worker and inventor. He contributed numerous papers on professional and technical subjects to the Proceedings of engineering and metallurgical institutes and societies with which he was associated, but of his contributions to knowledge the one which is most likely to be remembered is connected with a pastime rather than with his profession. He was an ardent musician in his earlier years, and became interested in the power possessed by the human brain of resolving compound sound-waves into their component notes. He was not satisfied with the theory put forward by von Helmholtz in 1863, and in 1876, when giving a presidential address to the Cleveland Institution of Engineers, he put forward an observation which he afterwards made the basis of a new theory of the mechanism of hearing. This observation was that if the sine curves representing a compound sound-wave are plotted out on a zero line, and if it is supposed that each crest, trough, and "crossing point" on such a tracing could give rise to a

stimulus on entering the ear, the time intervals of all the primary component notes could still be recognised. The cochlea, he supposed, must be able to detect these as pressure pulses, and acted not as a resonator but as an hydraulic apparatus. A little later he became involved in public life and in politics, and sat first for Stockton and afterwards for St. Pancras East in the Conservative interest. In 1906 he abandoned politics to devote himself anew to working out the idea he had first put forward in 1876. In 1907 he published a monograph under the title, "On the Impulses of Compound Sound Waves and Mechanical Transmission through the Ear." In this publication he describes and figures a machine of his own invention—an ohmograph he named it—by which he could combine the tracings of two, three or four simple notes into their combined form. Associating himself with Prof. (now Sir) Arthur Keith, a reinvestigation of the finer anatomy of the cochlea was undertaken, with the result that many facts came to light which were favourable to his interpretation of the mechanism of the internal ear, but could not be explained on the supposition that the cochlea serves as a resonator. In 1918 Sir Thomas brought his evidence together in the form of a book which was published by Messrs. Macmillan under the title, "An Enquiry into the Analytical Mechanism of the Internal Ear." The theory thus put forward is at present being subjected to a searching criticism, and if it be too much to claim that anything like finality has been reached, it may be safely stated that the author has made a contribution which has a permanent value for students of auditory mechanism.

Notes.

THE formal opening of the new Intermediate Scale Chemistry Laboratory of the Imperial College of Science and Technology by Mr. A. J. Balfour (the Marquess of Crewe presiding) will take place tomorrow (Friday) at 4 o'clock.

THE annual general meeting of the Research Defence Society will be held at 11 Chandos Street, W.1, on Wednesday, June 29, at 3.30, under the chairmanship of Lord Lamington. Dr. H. H. Dale will give an address on "The Work of the National Institute for Medical Research."

THE Semon lecture for 1920-21 in connection with the University of London will be given at 5 o'clock on Tuesday, July 5, at the Royal Society of Medicine, 1 Wimpole Street, W.1, by Dr. J. Horne, who will take as his subject "The Relationship of the Larynx to Pulmonary Tuberculosis." Admission will be free, without ticket.

A BILL to provide for the time in the British Isles being in advance of Greenwich mean time during a certain period of the year has been presented to the House of Commons.

THE president and council of the Royal Society have appointed Mr. H. Robinson, of the University

of Manchester, to the Moseley studentship for research in molecular physics, the funds for which were bequeathed to the Royal Society by the late Lieut. H. G. J. Moseley.

THE John Fritz gold medal has been awarded by the National Societies of American Engineers to Mr. Schneider, past-president of the Iron and Steel Institute, in recognition of his work in connection with the development of artillery.

By the will of the late Sir Felix Semon, the laryngological library of this well-known throat specialist is left to the Royal Society of Medicine.

A GOLD loving-cup was presented on Friday last by the members of the Royal Institution to Sir James and Lady Dewar on the occasion of their golden wedding.

IN consequence of the illness of Dr. J. Rennie, it has been found necessary to suspend the arrangements made by the Ministry of Agriculture and Fisheries for the examination of diseased bees. The Ministry will issue a further announcement as soon as other arrangements have been made.

At the evening meeting of the Royal Geographical Society on Monday last the president stated that the

society had heard with great regret of the death of Dr. Kellas, who had been invited to join the Mount Everest Expedition that he might carry out on Mount Everest the experiments in the employment of oxygen at high altitudes which he had already planned to carry out this summer on Kamet. It is feared that Dr. Kellas's death may have been due to his own untiring energy, for instead of resting after his great climb last summer he had spent nearly all the winter in climbing peaks in Sikkim.

CAPT. ROALD AMUNDSEN has asked the Storting by telegram from Nome, Alaska, for 300,000 kroner (about 12,000*l.*) for the purpose of refitting his vessel, the *Maud*, in order to enable him to continue his expedition in the Arctic regions. The *Maud* lost a propeller off Cape Serge, and is to be towed to Seattle for repairs.

As already announced, the Congress of the Universities of the Empire will be held at Oxford on July 5-8. In the morning of July 5 the following subjects will be discussed: "The Universities and the Balance of Studies." (1) The place of the humanities in the education of men of science and men of affairs. (2) The place of the physical and natural sciences in general education. (3) The question of specialism in university curricula. In the afternoon: "The Universities and the Teaching of Civics, Politics, and Social Economics." "The Universities and Secondary Education." (1) The frontiers of the secondary school and the university. (2) The influence of university entrance requirements upon the curricula of secondary schools. In the morning of July 6: "The Universities and Adult Education." (1) Lectures for the general public within the walls of the university. (2) Extra-mural work. In the afternoon: "The Universities and Technological Education." In the morning of July 7: "The Universities and Training for Commerce, Industry, and Administration." "The Universities and the Training of School Teachers." In the afternoon: "University Finance." In the morning of July 8: "The Universities and Research." In the afternoon: "Interchange of Teachers and Students." (1) The institution of a Sabbatical year for professors. (2) Provision of temporary junior posts for graduates of Colonial and foreign universities. (3) How to raise funds to make a trust for the promotion of the migration of students. (4) Equivalence of entrance examinations. (5) Mutual recognition of study and examinations.

A NATIONAL exhibition of maternity and childhood has been organised in Paris from June 15 to July 25. The exhibition is located in the Jardin Zoologique d'Acclimatation, Bois de Boulogne, and is divided into five sections. The object of the exhibition is to encourage larger families than at present obtain in France, and in the various sub-sections such subjects as the small birth-rate, its causes and prevention, infantile mortality, and the rearing of large families are dealt with. Conferences, *fêtes*, and sports are included in the programme. A large and influential committee has charge of the organisation, which is under the patronage of the President and Ministers of the Republic, the secretary-general being M. Em. Brocherioux.

A PROVISIONAL programme for the Paris Conference of the Museums Association, to be held on July 12-18, has been issued. The headquarters of the association while in Paris will be the Hôtel Moderne, Place de la République, and the meetings will be held at the Musée National D'Histoire Naturelle, Rue Cuvier. Papers on museum administration and numerous tours of French museums have been arranged, and there will be at least one joint meeting with the French Museums Association. Information regarding tickets, passports, and hotel accommodation, both for those attending the meeting and for those contemplating a more extended tour after the conference, can be obtained from Mr. W. J. W. Barrier, 31, Lime Grove, Shepherd's Bush, W.12.

A CONFERENCE of the International Union against Tuberculosis will be held in London, under the auspices of the National Association for the Prevention of Tuberculosis, on July 26-28. The annual conference of the National Association will be merged in the larger gathering. The object of the International Union, which was founded last year, is to promote an effective combination of the nations of the world against tuberculosis, and its first president is M. Léon Bourgeois. For the occasion of the coming meeting, however, Sir Robert Philip will act as president. Official delegates from countries within the League of Nations, from America, and from authorities interested in the subject, are invited to attend. The principal business of the conference will be a discussion, opened by Prof. A. Calmette, on the modes of diffusion of tuberculosis throughout the races of the world. Sir Humphry Rolleston will open another discussion on the rôle of the medical profession in the prevention of tuberculosis. There will be an official reception of the Union by the Lord Mayor of London on July 26, and visits to institutions of particular interest are being arranged.

THE executive committee of the council of the American Association for the Advancement of Science held its regular spring meeting at Washington, D.C., on April 24 last. The business transacted at the meeting is reported in *Science* of May 20, and some of the resolutions will be of interest to men of science in Great Britain. The next meeting of the association will be held at Toronto, and it was resolved that a special committee should collaborate with the local committee for the meeting to invite an eminent British man of science to attend to present papers before the section of the association to which his field of work is related and to deliver a general public lecture. The executive committee of the council also resolved that the British Association for the Advancement of Science be invited to send a representative to the Toronto meeting, and Dr. J. McK. Cattell was elected official delegate of the American Association to the forthcoming Edinburgh meeting of the British Association. A further resolution, which is of great interest in view of the letters which have appeared in our columns on the same topic, asks for the restoration of the privilege of duty-free importation of English scientific works by recognised educational institutions and faculties. The committee also directs the attention of Congress to the burden which would be im-

posed on scientific education and research by the proposal to repeal that part of the Tariff Act of 1913 which permits the duty-free importation of scientific materials, and on behalf of its 12,000 members asks for reconsideration of the suggestion.

A FURTHER step in the movement towards the standardisation of automobile, motor-cycle, and cycle parts has been taken by the British Engineering Standards Association in the formation of seven sub-committees the subjects and chairmen of which are as follows:—Nomenclature, Major C. Wheeler; Steels, Mr. A. A. Remington; Small Fittings, Mr. W. D. Williamson; Electrical Fittings, Mr. E. Garton; Shafts and Shaft Details, Mr. L. A. Legros; Wheels, Rims, and Tyres, Lt.-Col. D. J. Smith; and Cast Iron, Dr. L. Aitchison. Before the sub-committees actually embark upon the detailed work the various organisations concerned are being consulted in order to ensure that the proposed *personnel* meets with their approval as adequately representing their respective interests. In the meantime, technical data in regard to the specific subjects to be taken in hand immediately are being collected, and this should greatly facilitate the progress of the work as soon as the membership of the sub-committees is officially approved.

DR. A. C. HADDON selected as the subject of the Huxley memorial lecture, published in the *Journal of the Royal Anthropological Institute* (vol. 1., part ii.), "The Migrations of Cultures in British New Guinea." He remarks that along the coast a traveller notices a series of cultures, some evidently related to one another, while others are as obviously unrelated. The differences indicate that there is no immediate relation between them, though their affinity points to a common origin. The cultural problems of the south-eastern peninsula and the outlying islands are in the main quite distinct from those of the west, and the differences between these two groups indicate clearly that there cannot have been any extensive cultural movements from the Papuo-Melanesian to the western Papuan. We are driven, on general grounds, to the supposition that the cultures of the southern coast of New Guinea came down more or less from the north. The difficulty is that we have as yet no precise knowledge of the inhabitants of the interior of the island, and the socio-religious customs of the natives of many of the coastal areas have yet to be investigated. The lecture, with its appendix of material, is a valuable contribution to our knowledge of the ethnology of New Guinea.

It is a significant indication of the change of view in relation to anthropometry that in his paper on "Ancient Skulls from Greenland" Mr. W. E. Le Gros Clark (*Journal of the Royal Anthropological Institute*, vol. 1., part ii.) remarks that many attempts have been made to deal with the various races of man as the zoologist deals with the various species of mammals; to find some specific features which may serve to differentiate the skull of one race from the skull of another, in the same way that the concave post-orbital process distinguishes the skull of a fox from that of a dog. "This method was carried to an ex-

treme by Sergi when he subdivided the Mediterranean Race into a number of varieties, each characterised by the shape of the cranium as seen from above. These attempts have all failed, and it must be realised that the variation of individual skulls of modern races is so great that it is often extremely difficult to assign an isolated skull of unknown origin to a definite race with any degree of certainty." Mr. Clark points out that the construction of a type contour obviates these difficulties, and on its use the future of the science of craniology must depend.

ALL lovers of Oxford will welcome the pamphlet issued by the Clarendon Press in which Mr. H. E. Salter, after an exhaustive study of the college records and other literature, discusses "The Historic Names of the Streets and Lanes of Oxford. *Intra Muros*." It is remarkable that during the last 900 years only two new streets have been constructed—New Road in 1770, and King Edward Street about a hundred years later. The old lane near Christ Church meadow was called Shulinstoke, the pool above the mill where the cucking-stool was used; The Seven Deadly Sins was perhaps the sign of an inn, or a set of seven small cottages; Bocardo Lane was called after the Bocardo or Town Prison; the Turl was the Twirling Gate on the foot-way which led from Ship Street to Broad Street, and is not, like "The Broad," an undergraduates' abbreviation. Broad Street was known as Horsemonger Street in the thirteenth century, and that running from the west end of Broad Street towards the station was Irishman's Street. The author ends by suggesting that Cat Street should be restored for Saint Catherine's Street, Bocardo Lane for St. Michael's Street, and that Alfred Street should be rechristened Vine Hall Lane.

At the Royal Society conversazione on June 15 an exhibit was given illustrating the life-history of *Chermes Cooleyi*, Gillette. This insect has been recently observed in Britain. It is spreading rapidly throughout the southern counties of England, and occurs in two localities in Scotland. A study of it is being made by Mr. R. N. Chrystal under the direction of the Forestry Commission with the view of working out its biology and determining its relation to Douglas fir and Sitka spruce plantations in this country.

VOL. LVIII. (pp. 483-576, 1920) of the Proceedings of the U.S. National Museum contains a revision of the Nearctic ichneumon-flies of the genus *Apantales* by Mr. C. F. W. Muesebeck. As natural controlling agents of injurious insects many species of *Apantales* play important parts. Thus the larvæ of the common cabbage butterfly, those of the gipsy and brown-tail moths, and many cut worms and army worms are heavily parasitised by these insects. There appears to be no authentic record of an *Apantales* having been bred from any insects outside the Lepidoptera. In this revision 164 species are known to the author, and a list of their hosts is appended wherever known. On pp. 327-62 of the same serial Mr. R. A. Cushman revises the ichneumon-flies belonging to the tribe Ephialtini, the members of which are internal parasites of Lepidopterous pupæ.

WITHIN a year after the armistice some thirty nations and States agreed to two series of international air maps, the general and the local. The Geographical Section of the General Staff has undertaken the work of those sheets which fall within the British Empire. In the *Geographical Journal* for May Lt.-Col. E. F. W. Lees discusses the proposed maps at some length. For the general map it appears that Mercator's projection, despite all its disadvantages, is to be employed, principally because of its use in navigation and the general training of pilots on naval lines. The scale is to be 3 cm. to 1° of longitude at the equator, and the index is to be based on the index of the international million map. An overlap of 1° of latitude and 3° of longitude is to be allowed. As regards colouring and symbols, some departures must necessarily be made from the conventional usages of maps for terrestrial purposes. Experience has shown what features are of value to the airman in locating his position and finding his way. All water is to be blue; aeronautical information, such as positions of aerodromes, seaplane stations, lightships, etc., black; roads, deep yellow or burnt sienna; railways red, because of their conspicuousness to airmen; and woods green. Red is also to be used for buildings. Hill shading for the depiction of relief on the general map was recommended by the International Convention, but the employment of the layer system does not lack advocates. The general ground colour is to be pale green for ground covered with vegetation and pale buff for arid ground. Names apart from those applying to aeronautical information will be sparingly used. The local maps are to be on a scale of 1:200,000. For these the International Convention does not suggest the use of Mercator's projection. An innovation that will cause some criticism is the adoption of a new system of co-ordinate reckoning. Latitudes commence with zero at the South Pole and increase to 180° at the North Pole, and longitudes begin with the present 180° as zero or 360° and run eastward round the sphere. This departure from convention seems to carry no merits beyond the elimination of the letters N. and S. in latitudes and E. and W. in longitudes.

THE Report of the Director, United States Coast and Geodetic Survey, for the year ending June 30, 1920, is of considerable interest on account of the large number of charts it contains, many of which illustrate the extent of hydrographic survey along important steamer tracks on the coasts of America and its possessions. These maps show how much detailed work is required even in much-frequented channels in order to ensure safe navigation. Special emphasis is laid on the need for wire-drag surveys on the rocky coasts of the Pacific States and Alaska. The Director also makes a plea for the survey of Alaska, and shows in several charts and diagrams how little has already been done. Ninety per cent. of the coastal waters are uncharted; where surveys have been made a startling number of dangers to navigation has been discovered. It is essential also that the survey control points in Alaska should be linked up with other surveys of the United States or Canada. Operations have been begun with the co-

operation of the Canadian Government for a line of triangulation from Seattle through south-eastern Alaska, the so-called "panhandle," to the Yukon Valley and Bering Strait. The report indicates the progress made in the detailed survey of the Virgin Islands recently acquired from Denmark.

MR. A. W. GILES has studied and mapped the eskers in the vicinity of Rochester, New York, in Proc. Rochester Acad. Sci. (vol. v., pp. 161-240). A very useful bibliography of 126 papers is appended. Mr. J. G. Goodchild's Eden Valley papers (*Geol. Mag.*, 1875, and *Quart. Journ. Geol. Soc.*, vol. xxxi.) might be included, since he was one of the first authors to urge a sub-Glacial origin for gravel ridges. Mr. V. Tanner's detailed description of the Lapland eskers (*Bull. Comm. géol. Finlande*, 1915) might also be added as an elaborate modern study of the deposits of continental ice. Mr. Giles systematically reviews objections to the sub-Glacial theory of eskers, and concludes firmly in its favour. The knolls on esker-crests and the interruptions in chains are accounted for in several reasonable ways, and it is made more than ever apparent that an unnecessary amount of mystery has grown up round the subject since Hummel's explanation was published nearly fifty years ago. Even the nomenclature has become confused, and Mr. Giles's sentence, "The Swedish word 'os,' plural 'osar,' sometimes written 'as (asar),' has priority," contains, unfortunately, two linguistic errors.

THE history of geological research in the United States has been enriched by Mr. G. P. Merrill's "Contributions to a History of American State Geological and Natural History Surveys," a volume of 550 pages, published as Bulletin 109 of the Smithsonian Institution in 1920. Numerous portraits of the pioneers are given, and a great deal of instructive information may be gathered as to the functions of local surveys and their relations to other State Departments. Much of the material was originally collected by the U.S. Geological Survey, which has now permitted publication in this convenient and comprehensive form. The author refers also to Bulletin 565 of that Survey, in which Mr. C. W. Hayes summarised the work of the Surveys of the separate States.

RECENT drainage operations in the Awanui Swamp in North Island, New Zealand, have disclosed the existence of an elaborate drainage system many miles in extent which, there is good reason to think, may antedate both the Maori and their predecessors, the Moriori. The discovery is described by the *Times'* New Zealand correspondent in the issue of June 16. The drains are said to be uniformly about 5 ft. in width and 5 ft. in depth, with regularly sloped sides, the bottom being about 3½ ft. wide. They run for many miles across country in parallel lines perfectly straight, with numerous right-angle cross-drains. An indication of their age is afforded by the fact that in places huge trees of slow growth have grown up in the drains after their formation and decayed. The remains of deeply embedded posts with sharpened ends on a mound in one part of the swamp indicated that

it had been the site of a building. A remarkable piece of carved wood in the shape of a lintel, which was found at a depth of 5 ft., has just been secured for the Auckland Museum. In its centre is represented a human figure "almost gorilla-like in appearance"; it has a broad, wedge-shaped head with projecting ears, small broad nose, and a large oval mouth with small tongue. The body is small, short, and squat. The outstretched hands of the figure rest upon a perforated framework spreading right and left, the ends of which each terminate in a saurian-like head. Water-worn stones of the size of a hen's egg which have human features carved on them have also been found. The antiquity of these remains, as well as their style and technique, would appear to preclude their attribution to either Maori or Moriori.

THE American Association for the Advancement of Science, the National Academy of Sciences, and the National Research Council have appointed small committees which held a joint meeting on April 9 last to consider the problem of the conservation of the natural resources of the United States (*Science* of June 3). A resolution was passed recommending that the committees already in existence should function as a joint committee on national conservation, and at subsequent meetings of the three organisations represented the resolution was confirmed, and funds were provided for defraying the immediate expenses of setting up an executive and secretarial agency for the prosecution of the work. The main objects of the organisation which is to be established are stated under five headings; first, to direct scientific research so that it may bear more directly on the problems of conservation, a consideration which will involve a wide knowledge of the scope of any problem, and its relation to the programmes of research in other fields of work; secondly, the collection of data relating to natural resources, and their interpretation in relation to the economic, industrial, and social welfare of different regions, and of the nation as a whole; thirdly, to introduce the principles of conservation into the curricula of educational institutions; fourthly, to lead a campaign of popular education in the meaning of conservation; and fifthly, to correlate the efforts of existing agencies which are striving for conservation in their own particular fields. We shall await with interest the development of this scheme for economising the natural resources of the United States.

DRY weather has been persistent in England during several months, and now that we are more than half-way through the first month of summer the absence of rain has become serious. The observations at Greenwich, which very fairly represent England, show that the conditions are most exceptional. The Greenwich rainfall was below the normal for each of the eight months from October, 1920, to May, 1921, and compared with the average for 100 years the deficiency of the period is 6.21 in.—approximately equal to the normal rainfall for the four months February to May. There have, however, been only two months, November and February, with the rain-

fall less than an inch. The total measurement of rain for the eight months is 9.32 in., which is 60 per cent. of the average. An examination of the Greenwich observations for the last 105 years shows only one corresponding period as dry, the rainfall for October, 1879, to May, 1880, amounting to 8.24 in., a deficiency of 7.29 in. October, 1873, to May, 1874, had 9.60 in. of rain, and the next driest was apparently October, 1897, to May, 1898, with 10.50 in. There have been several spring droughts in the last 100 years, and for the four months February to May there have been ten years with the total measurement less than 4 in. This year the measurement for February to May was 3.78 in. The years with the smallest measurements for the corresponding period are 1834 with 2.60 in., 1857 with 2.76 in., 1863 with 2.90 in., and 1874 with 3.16 in. Temperature throughout the past eight months was abnormally high, the mean for each month at Greenwich being above the average and the excess for the whole period 2.3°.

AN interesting paper on the cause of quenching cracks in steel was presented at the May meeting of the Iron and Steel Institute by Messrs. Honda, Matsushita, and Idei. The cause is generally believed to be (1) the non-uniform distribution of temperature in the specimen during quenching and (2) the difference in martensitic expansion of adjacent parts during quenching. A closer examination of the phenomena, however, shows that the true cause is not so evident, for the sound due to cracking is often heard some ten seconds after quenching. In small pieces of steel the periphery is harder than the central portion only in a mild quenching; with a medium quenching the hardness is nearly equal throughout; while with hard quenching the periphery is always softer than the interior. This anomalous phenomenon is explained by the presence of arrested austenite in martensite. The quenching cracks in small pieces of steel occur when the hardness in the central portion is much greater than in the periphery, and they are attributed to the stress caused by the difference in the specific volumes of austenite and martensite. The specific volume of the former is smaller than that of the latter, and hence the central portion exerts a large tangential tension on the periphery. Since the difference in the specific volumes increases as the temperature falls, the cracking usually takes place when the temperature of the quenched specimen approaches that of the room. In a hard quenching the hardness gradually increases with the lapse of time owing to the gradual transformation of the arrested austenite into martensite.

MR. A. S. E. ACKERMANN'S first paper dealing with experiments with clay in its relation to piles was the subject of a note in *NATURE* for March 27, 1919. In his second paper on the same subject—read before the Society of Engineers in October last—the author takes the opportunity of correcting some errors which appeared in the first paper, and points out that further work has confirmed all the previous conclusions excepting that the effect of temperature on the supporting capacity appears to be limited to stresses below the pressure of fluidity, and that the sides of a hole appear to crush in before the statical

head is equal to the pressure of fluidity. Unquestionably the most interesting of Mr. Ackermann's results is that clay possesses a pressure of fluidity at which the loaded pile sinks through the clay without further increase in the load. This critical pressure depends upon the percentage of water present, being greater with less water. Mr. Ackermann has added to his former work in the direction of experiments designed to separate the work done against frictional resistances from that done in displacing the clay, and finds that the former is by far the larger quantity. A number of experiments have also been made on chalk, and the author finds that wet powdered chalk has a modified pressure of fluidity, and that the water-content affects greatly the properties of chalk. There is a marked difference in the physical properties of powdered chalk as compared with precipitated chalk. The adhesion and cohesion of wet chalk are much less than those of clay; clay is hygroscopic and chalk is not.

THE *Daily Mail* of June 13 published an article by a scientific correspondent under the sub-heading

"Can Eyes Radiate Energy?" which gives some account of a new instrument showing that "rays proceed from the eye which are capable of being registered just as wireless messages are detected." Dr. Charles Russ, the inventor of the instrument, writes to us stating that the paragraph constitutes a breach of confidence on the part of someone to whom the instrument was shown. It was intended that the phenomenon should be announced at the Ophthalmological Congress at Oxford on July 7, and some annoyance has been caused to Dr. Russ by this premature disclosure.

MR. A. RISDON PALMER is bringing out through Messrs. George Bell and Sons, Ltd., a series of Handbooks of Commerce and Finance planned to meet the need of a simple and graphic presentation of the fundamental principles of commerce and finance. The first three volumes, dealing respectively with "Transport and the Export Trade," "The Import Trade: Mixing Commodities," and "The Use of Graphs in Commerce and Industry," will be ready shortly.

Our Astronomical Column.

THE METEORIC RADIANTS OF JUNE 25-30.—Mr. Denning writes:—The possible occurrence of an abundant meteor shower from Pons-Winnecke's comet will attract a great number of astronomical observers to watch the heavens. The moon will rise late, and, being at her last quarter, will not offer any serious impediment to observation.

There are a considerable number of radiant points visible at this period of the year, though the usual rate of apparition is not nearly so great as in the two following months of July and August.

The great shower of Perseids probably begins at the end of June, and the radiant is then situated at about $0^{\circ}+36^{\circ}$. As it may prove useful for reference, a list of the principal radiant points observed in past years between June 25 and 30 is appended:—

announced by Prof. W. H. Pickering. It was found that change of altitude produced no change in the wave-lengths in the Venus spectra, the range of altitude extending from below 20° to above 40° .

The use of an ultra-violet spectrograph with a quartz collimating lens demonstrated the solar origin of the ammonia band in the solar spectrum at $\lambda 3360$, since the rotation shift between the east and west limbs was shown.

The spot activity, as indicated by the number of groups, diminished 40 per cent. in 1920 as compared with 1919. It is noteworthy that the spot group associated with the great magnetic storm of 1920 March 22-23 returned five times (1920 January to May), there being a magnetic storm on each occasion.

Unlike the spots, there was an increase in both prominences and hydrogen absorption markings as compared with 1919. A great eruptive prominence seen in 1920 December 31 strongly resembled that seen in the eclipse of 1919 May. A continuous series of spectrograms was secured, which showed the prominence matter ascending rapidly and fading away at a height of $16'$ above the limb.

POPULAR ASTRONOMY IN SWEDEN.—We have already directed attention to the *Popular Astronomisk Tidsskrift*; Häfte 1 o. 2, 1921, is another number full of interest. We may refer specially to an illustrated article by V. Carlheim-Gyllensköld on Tycho Brahe and his observatory on the island of Hven; many photographs of the present aspect of the latter are given, showing that it is still possible to trace out the outlines of the foundations of all the buildings and instruments. A portrait of Tycho Brahe and a photograph of the house where he was born are also reproduced, together with many relics unearthed from the ruins.

The latitude of Sweden favours observations of auroræ, which are made systematically at several stations. The auroræ of September 28 and October 17, 1920, are described in detail, with diagrams indicating the exact locations of auroral streamers among the stars.

$0+36$	$238+47$	$282-12$	$314+61$
$24+42$	$245+64$	$282-24$	$320+11$
$30+36$	$260-24$	$291+52$	$320+21$
$43+37$	$261-12$	$291+60$	$334+57$
$48+44$	$261+4$	$294+40$	$334+28$
$161+58$	$263+63$	$304+23$	$342+39$
$193+57$	$270+47$	$305-12$	$354+39$
$213+53$	$270+30$	$314+47$	$354+77$

REPORT OF THE KODAIKANAL OBSERVATORY FOR 1920.—It has already been mentioned in this column that direct comparisons of the solar lines with those of cyanogen and iron gave results fairly near those predicted by Einstein, but since the shifts were different for different substances, and also not proportional to the wave-length, they could not be wholly due to a gravitational effect. Tests made on the Venus spectrum gave further evidence of the shift being in part an "earth effect." A considerable improvement has been effected in the Venus spectra by using "Barnet Ultra Rapid" plates hypersensitised with ammonia; these enabled a very narrow slit to be used. When the terminator was placed normal to the slit, no evidence was obtained of an inclination of the spectral lines due to rotation of the planet. A recent letter from the director states that further photographs will be taken to test the rotation in sixty-eight hours about a highly inclined axis that was recently provisionally

The Second Royal Society Conversazione.

THE second Royal Society conversazione of this year was held at Burlington House on June 15, when Prof. C. Sherrington received the fellows and guests.

Some of the exhibits had been displayed at the first conversazione and were described in NATURE of May 19, p. 377; others were new, and the following brief descriptions have been taken from the descriptive catalogue.

Sir John Dewrance and Prof. E. G. Coker: Apparatus for investigating the action of cutting tools by polarised light. A transparent disc is turned at a slow speed by an electric motor through a worm reduction gear, and the cutting tool of glass or other material is clamped in a slide rest and receives a determinate radial feed from the main drive. The mode of action of various forms of cutting tools is observed in polarised light, and the stress distributions in both work and tool are investigated by this latter means.

Mr. R. N. Chrystal (Forestry Commission): An insect enemy of the Douglas fir recently introduced from America, *Chermes Cooleyi*, Gill. This insect may prove a serious enemy of our two most important exotic conifers, the Douglas fir and the Sitka spruce.

Mr. Percy J. Neate: Recording extensometer for textile yarns, etc. The specimen is secured vertically between an upper grip attached to a spring and a slowly descending lower grip. The movement of the lower grip is therefore the sum of the extensions of spring and specimen. This movement is halved and transmitted to a platen travelling downwards at an angle of 60° to the vertical. The spring is designed for a scale of $12 \text{ o.z.} = 3 \text{ in.}$ ordinate, but is calibrated to extend $3 \times 2/\sqrt{3} \text{ in.}$ at that load. The combined effect is to eliminate spring extension from the abscissæ and excess spring extension from the ordinate.

Mr. William Barlow: The methods of chemical graphic formulæ modified so as to interpret crystal structure by means of models. Certain partitionings of space into similar cells embody the conception that stable equilibrium of a crystal indicates the presence of similarly situated centres of repulsion. In the case of the diamond when regular dodecahedral cells are employed and four cells, forming a tetrahedral group, are allotted to each atom, the symmetry traced by the Bragg is presented by the group centres. The case of benzene is found to be met if, while four cells stand for each carbon atom, one is representative of each hydrogen atom. Further investigation has revealed the general principle that the allotment of the cells among the atoms follows the fundamental valencies; thus a monovalent atom requires one cell, a divalent two, a trivalent three, and a carbon atom four. In a large number of cases an appropriate partitioning into similar unit-cells when fully allotted on the principle just stated yields assemblages of cells almost identical in symmetry and relative dimensions with the corresponding crystals.

Sir Henry Howarth: A Dutch house interior. A *tour de force* in perspective, painted by De Hooge or his pupil Hoogestratten, whose name occurs on a representation of a letter on the table, probably for exhibition at a Kermeez or Dutch fair. The late Lord Kelvin and others were puzzled to know how it was executed, since the picture is painted on three planes; since a different view is seen when looked at from the holes at either end and there are no lenses in the holes, it would be interesting to know how the artist accommodated his drawing.

Prof. R. C. Punnett: Hen-feathered cocks. In some breeds of poultry the cocks are feathered like the hen, lacking the characteristic hackles and sickles

of normal cocks. Experiments have shown that the assumption of henny feathering by the cock is due to a factor which behaves as a Mendelian dominant. Castration of such birds leads to the assumption of normal male plumage. Experiments by Goodale in America and Pézard in France have shown that the castrated hen also develops cock feathering. It seems probable that hens and henny cocks alike contain a factor which inhibits the development of the normal cock plumage.

Royal Observatory, Greenwich: Astronomical photographs. (1) Four Franklin Adams chart plates in frame. (2) Solar eclipse, 1919, May 29, showing prominence and corona. (3) Solar eclipse, 1919, May 29, showing surrounding stars. (4) Solar eclipse, 1921, April 8. (5) Sun-spots, 1921, May 13.

The Rev. A. L. Cortie: Astronomical photographs and drawings from Stonyhurst College Observatory. (1) Bright-line spectra of Nova Cygni III., 1920, August 29 and 30 and September 6. The great intensity of $H\alpha$ is shown on the plate of August 30. (2) The genesis of the great sun-spot group of 1920, March 22-27. The drawings were the last made by the late Br. Wm. McKeon, S.J. They were reproduced by him from drawings made at the telescope, and show the development of the disturbance from 1919, December 27.

Dr. William Wilson: A new form of astronomical model designed for educational purposes. The model, while demonstrating the more familiar motions of the sun, earth, and moon and the various phenomena resulting therefrom, reproduces, in addition, the retrograde motion of the moon's orbital nodes (with its synodic revolution of 346 days) and the forward motion of the moon's apsides (with its synodic revolution of 412 days), and is thus capable of affording a demonstration of the Chaldean "Saros" or eclipse cycle of 18 years and 11 days, with its 41 solar and 29 lunar eclipses, the dates on which these eclipses will occur, and the further differentiation of them into total and partial in the case of the moon, and total, partial, and annular in the case of the sun.

The Meteorological Office: Apparatus for recording atmospheric pollution. Dr. Owens's automatic air filter is an instrument which at the end of every fifteen minutes automatically draws two litres of air through a piece of fine blotting-paper. The darkness of the circle of deposit left on the paper gives an estimate of the amount of suspended matter in the air. Records are shown illustrating the reduction in the amount during the coal strike and the relative importance of domestic fires and factories. The amount of suspended matter is found to be closely connected with the vertical electric force. The reduction in the latter at the end of a fog is illustrated by a record taken at Kew.

The National Physical Laboratory: (1) Paterson-Walsh electrical height-finder. Designed during the war for measuring the height of enemy aircraft; it depends on the Bennett-Pleydell "roof" principle of height measurement. The action of the electrical height-finder is, by means of a sliding bar situated in each sighting plane and passing over a horizontal uniform resistance, to obtain at each station a potential proportional to the cotangent of the angle of elevation at that station. These two potentials, combined in series by cables connecting the two stations, and operating across a resistance proportional to B , give a current inversely proportional to the height, and thus a milliammeter may, by making it with an inverse height-scale, be made to give a continuous indication of the height of any object on which the two planes are constantly sighted. (2) Photomicro-

graphic transparencies (Metallurgical Department). Photomicrographs, shown as enlarged transparencies, illustrating recent work relating to the constitution of various alloys of aluminium. They show typical structures found in the alloys of aluminium with magnesium, copper, silicon, iron, and zinc when treated in various ways. Some illustrate particularly the method of determining the temperature at which the alloys become completely solid by quenching small specimens from various temperatures. The presence of liquid at the moment of quenching makes itself felt by a characteristic fine micro-structure.

The Cambridge and Paul Instrument Co., Ltd.: Darwin-Hill mirror position-finder. This instrument enables the position of an object moving in the air to be accurately recorded in terms of three rectangular co-ordinates. Two horizontal mirrors ruled in squares are placed one at each end of a common base line, the rulings being parallel and perpendicular to the base line. The object is observed through a fixed, but adjustable, aperture sight, and the position of the image in each mirror is marked on the glass surface either continuously or at simultaneous times controlled by telephone or signal. Each mirror gives two co-ordinates for any position of the image, from which the three co-ordinates of the object can be calculated for successive positions. These instruments have been used for the observation of high-angle gun-fire for the preparation of range tables, for checking anti-aircraft gun-fire, and for recording the flight of experimental aircraft, pilot-balloons, etc.

The Science Museum: Gravity torsion balance. This instrument was designed by Baron R. Eötvös, professor of physics at the University of Budapest, in order to determine the variation of gravity over comparatively short distances, and to make experimental investigations on the form of the earth. The instrument has also been used in Hungary for the location of mineral deposits when the density of the mineral differed considerably from that of the surrounding strata.

Radiological Branch, Research Department, Royal Arsenal, Woolwich: Pinhole photographs of the Coolidge radiator tube and photographs illustrating protection in the X-ray examination of materials. (1) Pinhole photographs illustrating the change in shape of the focal spot with current change. (2) Photographs illustrating the various parts of the target of the above tube which emit X-rays under varying conditions. (3) Photographs illustrating X-ray protection when radiographing large metal objects. (4) Photographs illustrating portable set designed and made in the Research Department, Woolwich, with complete protection, for visual examination of materials.

Instrument Department, Air Ministry: (1) Mercury barometer for use on airships. (2) Differential thermometer for airships. (3) Twin-pointer revolution indicator. (4) Gyroscopic turning indicator. (5) Aneroid altimeter with computer dial. (6) Permeameter. (7) Liquid oxygen vaporiser.

Mr. A. Leslie Armstrong: Engravings upon flint-crust discovered at Grimes Graves, Norfolk, together with flint implements, upon an ancient living level

3 ft. beneath the present surface. The most important engraving is a wonderfully lifelike drawing of a stag, or perhaps an elk, evidently disturbed whilst browsing. One foreleg is raised, the others are buried in herbage. The head is held erect and stalks of grass are shown hanging from its mouth. A second engraved piece has a well-drawn animal's head upon it, apparently that of a hind. Others bear lines and irregular forms on them. All were discovered in September last by the exhibitor upon an ancient living level upon glacial sand 3 ft. beneath the present surface, associated with flint implements of Mousterian type, bone tools, and pottery.

British Museum (Natural History): Fading of museum specimens exposed to light (Sir Sidney Harmer). The object of the experiments was to test the efficacy of "antifade" glasses in protecting specimens from fading. The conclusions reached are (1) that specimens kept in the dark do not fade when subjected to a considerable rise of temperature; (2) that objects exposed to direct sunlight are bleached even if protected by "antifade" glass; (3) that the injurious action of either diffused daylight or strong electric light is far less than that of direct sunlight; and (4) that "antifade" glasses may have some slight advantage in protecting specimens from the bleaching effect of diffused daylight or of electric light.

Department of Geology, British Museum (Natural History): An ancient human skull from the Transvaal (Mr. W. P. Pycraft). Towards the end of 1913 a human skull-cap and temporal bone, and a few other skeleton fragments, apparently of considerable antiquity, were found at Boskop, in the Potchefstroom district of the Transvaal. The skull-cap is remarkable for its great length and parietal width—length 205 mm., breadth 150 mm.—while the forehead is narrow. The skull is dolichocephalic and tapeinocephalic. The auricular height could scarcely have exceeded 125 mm., and from this it may be assumed that the cranial capacity did not exceed 1700 c.c. The precise affinities and geological age of this skull are matters now under investigation.

Department of Zoology and Comparative Anatomy, University College: Cytological preparations.—(a) Golgi apparatus; (b) polar body, *Ornithorhynchus* egg; and (c) *Anello cromatico*, *Dytiscus* (Dr. Gatenby).

Dr. C. T. Trechmann: Shell of the recent Pleurotomaria (*P. Adansoniana*) dredged off Barbados, West Indies, in 60 fathoms of water. Pleurotomaria is a "living fossil"; possibly only about five specimens of this species are known. Other species occur off Japan.

Zoological Laboratory, Imperial College of Science, South Kensington, S.W.: Effect of pineal gland administration on amphibian melanophores (Dr. L. T. Hogben). Administration of fresh gland or pineal extract causes contraction of the melanophores. This effect first appears after a previous treatment of ten days with tri-weekly administration, and follows each subsequent treatment lasting for six hours and attaining maximum contraction in half an hour. Tadpoles become exceedingly pale and quite transparent in the head region when under treatment while the effect lasts.

The South-Eastern Union of Scientific Societies.

THE twenty-sixth annual congress of the South-Eastern Union of Scientific Societies was held at Reading on June 8-11, under the presidency of Prof. E. B. Poulton, who, in his presidential address on "The Inspiration of the Unknown," showed that entomology was a world in which many workers were still needed, and that great blanks in knowledge

still required filling up. Dr. Dukinfield Scott contributed a paper on "The Earliest Land Flora," and brought under notice the work of Kidston and Lang on the Lower Devonian flora, and illustrated by the lantern the structure of *Psilophyton*, a genus founded by Dawson and only now at last coming to be generally accepted by palaeobotanists. Miss G. Lister

read a paper on "Conifers in English Gardens," and illustrated her remarks by a large number of specimens; great interest was shown by the delegates in this popular exposition of native and introduced conifers. A third botanical paper was by Prof. G. S. Boulger on "The Origin of the English Flora."

The Silchester rooms at the Reading Museum were crowded when Mr. Mill Stephenson gave a demonstration on the Silchester discoveries. The thoroughness with which the excavations were carried out revealed a complete picture of Romano-British life, including temple, baths, silver refinery, amphitheatre, hypocaust, dwellings, latrines, and all that went to make up a centre of commercial life of the period. The cemetery remains unexcavated. The city is now again buried, the walls alone showing, whilst outside there still remain the earthworks of an earlier period still, when Neolithic Britons planned a camp of wider dimensions. Roman ornaments in bronze called for special notice, these being beautifully executed. A carpenter's plane was remarkable in that it was of metal, and included screws for adjusting the blade. A visit to Silchester enabled many members to pick up fragments of Roman brick and Gaulish ware. Regret that no portions of the buildings or the foundations had been left uncovered was expressed. It is inconceivable that our British Pompeii was again buried out of sight almost as soon as it was excavated.

A visit to Windsor enabled members to see St. George's Chapel and the King's library and to ascend the Round Tower. Papers were read by the Hon. J. W. Fortescue and Dr. A. V. Baillie. A popular lecture was given by Mr. H. E. Peake on "Racial Types in South-East England," and this gave rise to an animated discussion as to whether all the portions of the Eoanthropus skull had been properly fitted as parts of one and the same skull. It was pointed out that portions of at least three individuals had been found. A paper by Prof. John Percival on "Species and Races of Wheat" was of valuable economic interest. Growing plants of *Aegilops ovata* were exhibited and the part it has taken in the evolution

of modern wheat expounded. Specimens of various wheats were shown, including the hard, snow-resisting *Triticum spelta*.

The afternoon excursions included a visit to the relics of Reading Abbey, of which the Chapter House is the most important and extensive. The hall measured 79 ft. by 42 ft. One of the tablets on the wall commemorates that ancient musical composition, "Sumer is icumen in," which is stated to have been written down at the abbey about A.D. 1240. A visit to the economic garden of Dr. J. B. Hurry showed the great care here exercised to make the garden of an educational nature. The medicinal plants growing numbered twenty-five, food plants twenty, fabric plants eleven, and dye plants twenty; whilst the herbal garden contained a very large number of useful plants which were grown extensively in the Middle Ages, and alluded to by Chaucer, Spenser, Shakespeare, and others. In the museum attached were many commercial derivatives from the plants. A fine fabric made from the common nettle was noticeable. Archaeologists paid an afternoon visit to the quaint Upton Court, with its many-gabled roofs and its hidden priest-holes, and to Padworth and Aldermaston churches, when Mr. C. E. Keyser acted as guide. The University College was also visited, after which the party proceeded to the Experimental Gardens at Shinfield.

It is worthy of note that Reading Museum possesses a copy in needlework of the famous Bayeux tapestry, executed by the Leek Needlework Society. We remember that when we last saw the original at Bayeux it had suffered mutilation by a relic-hunter, and the three-cornered piece which had been snipped out, having come into possession of the South Kensington Museum, had been returned to Bayeux, but instead of being replaced in position it was mounted separately on a block. Perhaps it has since taken its proper place in the tapestry and the modern piece which had been worked in been removed.

An important portion of the business of the congress was the complete revision of the rules, which after discussion were passed as presented by the council.

The Orientation of the Dead.

At a meeting of the Royal Anthropological Institute, held on May 31, Prof. H. J. Rose read a paper on "Celestial and Terrestrial Orientation of the Dead." Two forms of orientation were distinguished and illustrated by examples; namely, graves orientated (a) on a point in the heavens, as the east; (b) on a point on the surface of the earth, e.g., Mecca. The former Prof. Rose called celestial, the latter terrestrial, orientation. The deciding factor was normally the point towards which the face of the buried corpse turned. This point was often the former habitat, whether real or supposed, of the dead man's people.

The author compared the custom, common among many peoples, of burying in or near the hut, or facing towards the supposed home of the man's spirit at or before birth. This was combined with a belief in reincarnation: the ghost, feared and avoided as such, was welcomed when it became a baby, born of a woman of its own clan or tribe; but as the rebirth of some persons, e.g. notorious criminals, was not desired, means were taken to place their bodies in such a position that the ghost would get lost. Thus only the desirable people were buried in the normal place or with the normal orientation towards the dwelling-place of their potential mothers or towards Hades, whence in many cases the souls of the new-born come.

Belief in reincarnation, however, need not of necessity lead to the practice of orientation.

Celestial orientation was not always possible in low grades of culture which might have no knowledge of any such thing as cardinal points. Where celestial orientation existed such knowledge could not be assumed without further evidence. It might indicate (a) the departure of the dead to a land of darkness, marked by the position of the setting sun; (b) the departure to a land of light, marked by sunrise. Moreover, as some were too bad to be wanted back on earth, some also (e.g., important chiefs) were too exalted ever to become babies again. Hence to find a cemetery containing a number of bodies most of which face to one quarter while a considerable number face to another rather proved than disproved deliberate orientation. This applies, for example, to the burial-ground of Megara Hyblæa.

Orientation E.-W. was frequently accompanied by orientation N.-S. Houses were frequently constructed so as to facilitate observation of the position of the sun. If this was done, it was a matter of indifference whether the house ran N.-S. or E.-W. The grave was regarded as the house of the dead.

Another possibility was that the grave, as a sleeping place, was so arranged that the rising sun would warm and vivify the sleeper. This applies only to the E.-W. position.

The idea of the journey of souls to a place on earth, but far distant, may often be distinguished from

celestial orientations (a) by the fact that they tend to converge, not to diverge, in direction; (b) by the absence of graves at right angles to the prevailing direction.

They may also be orientated by being placed along a road of spirits. There were three main classes of non-orientated burials, those with (a) an absence of any intelligible arrangement whatsoever, as in the British round barrows, (b) a funeral feast arrangement, as among the Siculi and some Amerindians, (c) a "Sociocentric" arrangement, as among the Wotjobaluk, Omaha, Ponka, etc.

In conclusion, Prof. Rose suggested that if his deductions were sound, they afforded, *inter alia*, a new test of race.

In the discussion which followed the reading of the paper Dr. Rivers, the president, pointed out that Prof. Rose, in coupling reincarnation and terrestrial orientation, had suggested an entirely new con-

nection. In Melanesia orientation was usually terrestrial. There was, however, a form of orientation which, while being celestial, had no connection with the cardinal points. It was in the direction of a home of the dead in the sky, which he connected with the Melanesian variant of upright burial and the custom of burying the dead in the sea with weights attached to their legs. Dr. Rivers suggested, further, that our own practice of laying the corpse on its back may be connected with the home of the dead in the sky. Prof. Elliot Smith referred to the custom of the proto-dynastic Egyptians who buried their dead with the head to the south, while in the second and third dynasties they were buried with the head to the north, in each case towards the country of origin. Mr. H. Peake pointed out that the terrestrial orientation would tend to become celestial as a people in the course of its wanderings lost the memory of the direction of its original point of departure.

The National Academy of Sciences, U.S.A.

THE annual meeting of the National Academy of Sciences was held at the Smithsonian Institution on April 25-27. Unusual interest was taken in the meetings owing to the presence of his Serene Highness Albert I., Prince of Monaco, Prof. and Mrs. Albert Einstein, and Dr. Frank Adams, of Montreal, a foreign associate. In accordance with a precedent of long standing, President Harding received the academy.

On Monday evening, April 25, the Prince of Monaco gave an address, illustrated by moving pictures, on his researches in oceanography, for which the Agassiz medal, founded by the late Sir John Murray, was awarded to him by the academy in 1918. After the address the Prince graciously received the members of the audience at a reception held in the National Gallery of Art.

On Tuesday the president, Dr. C. D. Walcott, extended a welcome to Prof. Albert Einstein on behalf of the academy, to which Prof. Einstein briefly responded, expressing his sense of pleasure at being present at the meeting of the academy and receiving its welcome.

On Tuesday evening, at the annual banquet, the presentation of the academy's medals was made. The Mary Clark Thompson medal, for eminence in researches in palaeontology and geology, was awarded for the first time to Dr. Walcott for his classic studies in Cambrian palaeontology. The Agassiz medal for 1918 was presented to the Prince of Monaco. The Agassiz medal for 1921 was presented to Admiral Sigsbee for his investigations, including deep-sea soundings and other oceanographic work, mainly in the Gulf of Mexico. The Henry Draper gold medal, for eminence in astronomical physics, was awarded to Prof. P. Zeeman, of Amsterdam, for his discovery of the so-called "Zeeman effect" and for the study of the influence of magnetism upon light. In Prof. Zeeman's absence the medal was communicated through Dr. Hubrecht, secretary of the Netherlands Legation. The Daniel Giraud Elliot medal was awarded to Dr. Robert Ridgway for his studies of the birds of North America, especially part viii. of his "Birds of North and Middle America," which has recently appeared. The Hartley gold medal for eminence in the application of science to the public welfare was awarded to Dr. C. W. Stiles for his work in the investigation and eradication of the hookworm disease in the United States.

At the business meeting on Wednesday, April 27, Dr. Walcott tendered his resignation as president of the academy on account of his desire to lay down

something of the burden of administrative work which he has long carried, and in order to be able to devote himself more completely to his studies of palaeontology, but at the unanimous desire of the academy he consented to withdraw his resignation for the remaining two years of his term. Dr. George E. Hale resigned the office of foreign secretary on account of ill-health, and Dr. R. A. Millikan was elected to succeed him. Messrs. Hale and Pearl were elected to the council, and the following new members were elected to the academy: Messrs. Frank Michler Chapman, William Leroy Emmet, William Draper Harkins, Ales Hrdlicka, Arthur Edwin Kennelly, William George MacCallum, Dayton Clarence Müller, George Abram Miller, Benjamin Lincoln Robinson, Vesto Melvin Slipher, Lewis Buckley Stillwell, Donald Dexter Van Slyke, Thomas Wayland Vaughan, Henry Stephens Washington, and Robert Sessions Woodworth.

Numerous papers were presented at the scientific sessions. The principal feature was the address of Dr. W. S. Adams, of Mount Wilson Solar Observatory, on his spectrum researches on the motions in the line of sight and the absolute magnitudes of nearly 2000 stars. Dr. Adams pointed out the excellent confirmation of Russell's theory of giant and dwarf stars, and discussed the bearing of the observations on the dependence of stellar velocities upon spectral type and absolute magnitude. He also treated several other questions which are no longer insoluble now that, for the first time, the positions, directions, and velocities in space of such a large and homogeneous mass of stars have become known.

Dr. C. D. Walcott gave a profusely illustrated paper in which he directed attention to the great detail in the structure of the trilobite which he has found by the application of a new photographic process.

Dr. H. F. Osborn, of the American Museum of Natural History, New York, traced the evolution and geographical distribution of the Proboscidea. The two main groups of the mastodons and true elephants were followed, by the aid of skeletal photographs, restorations, and maps, from their original homes in northern Africa and Central Asia in the Eocene through their migrations over Europe and Asia to North and South America by way of Bering Strait.

Another paper of the same general character was given by Dr. J. C. Merriam, president of the Carnegie Institution, on his twenty years of study of the evolution and geographical distribution of the bear family.

Dr. L. R. Jones, of the University of Wisconsin, showed the pathological influence of temperature, and

the relation of it to the adaptability of certain soils and climates to the growth of the principal food crops.

Dr. Simon Flexner communicated the results of experimental epidemics produced in colonies of mice, in which it was shown that the mortality is enhanced by the introduction of fresh subjects after the epidemic has nearly run its course, the recurrence among the original colony seeming to be promoted by the disease of the new individuals.

Novel experiments on the skin temperature of pachyderms, reported by Dr. F. G. Benedict, embraced measurements of the temperatures of the elephant, rhinoceros, and hippopotamus at the New York Zoological Gardens. The difference between the results for these hairless animals and the results for man seem to depend largely on the great thickness of the skin, with accompanying control by outside as contrasted with interior temperature conditions.

A short popular account was given by Dr. C. G. Abbot of his experiments with solar cooking apparatus on Mount Wilson. The application of the solar heat is indirect through an oil circulatory apparatus, including a reservoir in which are inserted the ovens. All kinds of domestic cooking, except frying, and the preserving of fruits and vegetables were carried on. A jar of preserved pears prepared in the solar cooker was exhibited.

In a paper by J. R. Carson and J. J. Gilbert on transmission characteristics of the submarine cable, further employment was made of the extraordinary opportunity enjoyed by physicists during the war owing to the Government control of the Alaskan cable. A valuable paper had been given on the characteristics of this cable by signal corps officers at the academy meeting of 1920. Further applications of the results were now given.

A New Treatment of Sleeping Sickness.

AT a meeting of the Royal Society of Tropical Medicine and Hygiene held on May 20, Dr. Claude H. Marshall, senior medical officer of the Uganda Protectorate, read a paper on a new treatment of trypanosomiasis (sleeping sickness) which had been originated by Dr. S. M. Vassallo, of the Uganda Medical Service, and himself. Remedies injected into the circulation, though they may sterilise the blood, probably do not destroy the parasites in the central nervous system, since the trypanosomes produce thickening and occlusion of the choroid plexus at an early stage of the disease, and thus prevent the passage of drugs from the circulation into the spinal fluid. In 1918, therefore, in a well-marked case of sleeping sickness, an intravenous injection of neokharsivan was made, and three hours afterwards 2 oz. of the patient's blood was withdrawn; 20 minims of the serum was then injected into the spinal canal, and no further treatment was given; twenty-seven months afterwards the patient was quite well, and his blood free from parasites. Of thirty cases similarly treated a large majority were quite well at periods varying from six and a half to twenty-seven months afterwards. The results are supposed to be due only in part to the drug contained in the serum; it is held that an antibody, trypanolysin, is formed in the blood of an infected patient, but that this cannot in ordinary circumstances reach the parasites in the central nervous system. Acting on this view, Dr. Vassallo is now treating cases along similar lines, but without previous intravenous injection of the drug. Later speakers emphasised the value of the work of Dr. Marshall and his colleague; but it was pointed out that it was early as yet to claim that the cases were permanently cured.

NO. 2695, VOL. 107]

University and Educational Intelligence.

CAMBRIDGE.—The Frank Smart prizes for botany and zoology have been awarded to A. J. Smith, Downing College, and G. S. Carter, Gonville and Caius College, respectively.

GLASGOW.—Sir John H. Biles has intimated his intention to retire in September next from the John Elder chair of naval architecture and marine engineering, which he has held since 1891. Prof. Biles has served in many capacities under the Admiralty and the Board of Trade, and is Consulting Naval Architect to the India Office. He received the thanks of the India Council for his services in designing and constructing river craft for the Mesopotamia Expeditionary Force during the war.

The late Mr. William J. Chrystal, chemical manufacturer, of Shawfield Works, Rutherglen, has bequeathed 10,000*l.* to the University, to be applied as the Senate may determine; and also 10,000*l.* to the Royal Technical College, for endowment.

OXFORD.—Dr. E. Mallam, of Magdalen College, has been appointed Litchfield lecturer in medicine for two years as from October 5 next.

Final approval has been given in Convocation to the statute constituting the Delegacy for the Society of Oxford Home Students, and to the decree authorising the loan of 19,000*l.* from the special reserve fund for the completion of the Dyson Perrins Laboratory.

ST. ANDREWS.—Dr. R. Robinson, director of research in the British Dyestuffs Corporation, Huddersfield, has been appointed professor of chemistry and director of the chemical research laboratory in succession to Prof. Irvine, now Principal of the University.

THE award of the William Gibson research scholarship for medical women (the second since its foundation) has been made by the council of the Royal Society of Medicine to Miss Gertrude M. A. Herzfeld, of Edinburgh.

THE *Chemical Age* for June 18 announces that Mr. K. C. Browning, who for many years was Government analyst in Ceylon, has been appointed professor of chemistry and metallurgy at the Artillery College (formerly the Royal Ordnance College), Woolwich.

At the meeting of Leeds University Court, held on June 15, the sixteenth annual report for the year 1919-20 was adopted. The vice-chancellor, Sir Michael Sadler, addressed the court, and stated that the most urgent question before the university was one of finance. The cost of maintenance was almost double that of 1918, and the balance sheet for the current year would show a deficit of 14,000*l.* The present income was about 140,000*l.*, of which 32.7 per cent. came from Government grants, 16.4 per cent. from local education authorities, 14.8 per cent. from endowments, etc., and 36.1 per cent. from students' fees. At present the average cost per student is 75*l.* per annum, and the average fee paid is 27*l.* It has therefore been decided to adjust the fees to meet the difference between the total cost of the education provided and the funds derived from all other sources. Under present conditions this means an increase of 10*l.* per annum in the tuition fees and a small increase in examination fees. The report contains some account of the work in hand in the various departments, and concludes with a list of donations, etc., from which it appears that during the past year the university has received more than half a million sterling in donations, including eight gifts of 10,000*l.* and over, and one of 77,250*l.*, in addition to their annual subscription of 4000*l.* from the Clothworkers' Company of London.

Calendar of Scientific Pioneers.

June 23, 1881. Matthias Jakob Schleiden died.—At first an advocate at Hamburg, Schleiden afterwards held the chairs of botany at Jena and Dorpat. He did much to establish the cell theory, while among his important writings was his "Principles of Scientific Botany."

June 23, 1891. Wilhelm Eduard Weber died.—Professor of physics in the University of Göttingen, Weber was associated with Gauss in some of his investigations, and did valuable work on the definition and determination of electrical units.

June 23, 1896. Sir Joseph Prestwich died.—While in business as a London wine merchant, Prestwich studied the geology of Hampshire and the London basin, the coal supply of England, and the antiquity of man. At the age of sixty-two he succeeded Phillips as professor of geology at Oxford.

June 25, 1868. Carlo Matteucci died.—The recipient in 1844 of the Copley medal for his electrical researches, Matteucci was professor of physics, first at Bologna, and then at Ravenna and Pisa. For some years he was connected with the Italian telegraphs.

June 26, 1793. Gilbert White died.—Educated at Oxford, and for a time senior proctor, White passed most of his life at Selborne. His well-known "Natural History and Antiquities of Selborne" was published in 1789.

June 26, 1831. Sophie Germain died.—A versatile and learned woman, Sophie Germain was distinguished for her mathematical writings on elastic surfaces.

June 26, 1893. Sir Edward Sabine died.—An officer in the Royal Artillery, Sabine made valuable pendulum and magnetical investigations which gave an impulse to the systematic study of terrestrial magnetism. From 1861 to 1871 he was president of the Royal Society.

June 27, 1829. James Smithson died.—Owing to circumstances of birth, Smithson was educated at Oxford under an assumed name. His knowledge of chemistry and mineralogy led to his being admitted as a fellow of the Royal Society in 1787. Most of his life was spent on the Continent, associating and corresponding with men of science. He died at Genoa, leaving his fortune of more than 100,000*l.* to the United States, the Government of which founded the famous Smithsonian Institution.

June 27, 1876. Christian Gottfried Ehrenberg died.—After travelling through East Russia with Humboldt, Ehrenberg became a professor at Berlin, and in 1842 was made secretary to the Berlin Academy of Sciences. He was the first to show that certain rocks consisted of minute forms of animals or plants. His "Mikrogeologie" was published in 1854.

June 27, 1892. Carl Schorlemmer died.—A student of Bunsen's, Schorlemmer in 1858 came to England as assistant to Roscoe, and in 1874 was appointed professor of organic chemistry at Manchester.

June 28, 1897. Paul Schutzenberger died.—The successor of Balard at the Collège de France, Schutzenberger made important researches on colouring matters, the constitution of alkaloids, and on platinum compounds.

June 29, 1895. Thomas Henry Huxley died.—As a naval surgeon Huxley cruised in H.M.S. *Rattlesnake*, and sent home important papers on the Hydrozoa. From 1854 to 1885 he was professor of natural history at the School of Mines. His scientific work embraced vertebrate and invertebrate morphology, comparative anatomy, histology, and palaeontology. His lucid essays and crusade for freedom of thought attracted widespread attention, and as "a man and a citizen" he undertook much public work. E. C. S.

Societies and Academies.

LONDON.

Royal Society, June 16.—Prof. C. S. Sherrington, president, in the chair.—H. B. Dixon, Dr. C. Campbell, and Dr. A. Parker: The velocity of sound in gases at high temperatures, and the ratio of the specific heats.—Prof. J. R. Partington: The ratio of the specific heats of air and of carbon dioxide. The ratio of the specific heats, $\gamma = c_{-p}/c_{-v}$, has been determined by the method of adiabatic expansion for the gases air and carbon dioxide. The gas was contained in a 120-litre vessel, and the temperature change immediately after expansion followed by a platinum thermometer, with compensating leads of wire 0.001 mm. diameter, the resistance of which was observed by an Einthoven string galvanometer of 0.01 seconds period. The fundamental temperature measurements were made by a mercury thermometer. The results were calculated by the characteristic equation of D. Berthelot, so that deviations from the ideal gaseous state were allowed for. The final results, accurate to 1 part in 1000, are: γ for air at 17° C. = 1.4034; γ for carbon dioxide at 17° C. = 1.3022, whence c_{-p} for air at 17° C. = 0.2387 cal. and c_{-p} for carbon dioxide at 17° C. = 0.1996 cal. All the values refer to atmospheric pressure.—Dr. A. B. Wood and Dr. F. B. Young: (1) "Light-body" hydrophones and the directional properties of microphones. A light prolate ellipsoid possesses directional properties by virtue of its shape. Quantitative results obtained agree with calculated values supplied by Prof. Lamb. Owing to the pronounced intrinsic directional properties of the microphone, a spherical "light-body" hydrophone is practically equal in directional efficiency to one of ellipsoidal form. "Light-body" hydrophones are of value as experimental exploring instruments. (2) The acoustic disturbances produced by small bodies in plane waves transmitted through water, with special reference to the single-plate direction finder. Sound distribution was explored round a number of discs immersed at a distance from a small submerged source of sound. By means of a pair of miniature hydrophones—one bi-directional, the other non-directional—it was possible to chart (1) direction of oscillation of the water particles; (2) relative amplitude of the movements; and (3) relative amplitudes of the pressure oscillations. The charts obtained fall broadly into two classes, according as the discs are solid or contain air-filled cavities, very minute air-filled spaces giving marked effects. The behaviour of a typical baffle-plate is investigated, but no satisfactory theory of the baffle is offered.—M. A. Giblett: Some problems connected with evaporation from large expanses of water. The problems of distribution and amount of water-vapour present are considered for a current of air of uniform speed moving over a water-surface of uniform temperature. Near the surface is a thin layer of air, through which water-vapour diffuses slowly by molecular processes, but above this is a rapid transition to a turbulent régime, where diffusion becomes much more rapid. At and near the water-surface the problem is treated as one of eddy diffusion. Formulæ are obtained for humidity at any point of the air-current, and for rate of evaporation from stretches of water extending any distance downwind. The distribution of water-vapour is obtained for some typical cases, and an estimate made of the rate of evaporation from long stretches of water under various conditions of wind, water-surface, temperature, and turbulence. The effects which each of these elements exerts, when varied within their natural range, are examined. The results emphasise the control exercised by atmospheric turbulence over evapora-

tion from large areas.—F. C. Toy: The photographic efficiency of heterogeneous light. Two possible laws of action are discussed:—(1) All radiations composing the heterogeneous beam may act simultaneously but independently; and (2) all radiations may act simultaneously but not independently. The possibility of testing the laws depends on the form of law connecting the probability of a single grain of the photographic emulsion being made developable with the intensity of the exciting light. The form of this law proved experimentally by Slade and Higson is considered, and a result is deduced which can be tested by experiment. From the evidence obtained it is concluded that over the spectral range used in the experiments ($\lambda 4350$ to $\lambda 4000$) radiations of different frequencies act simply as a total amount even when a difference in quality exists.

Linnean Society, June 2.—Dr. A. Smith Woodward, president, in the chair.—Prof. W. Garstang: Haeckel's biogenetic law: A theory of ancestral heredity. Ancestors created, heredity transmitted, and development repeated the order of creation. A generalised recapitulation of the essential grades of ancestral structure was also possible without involving successive adult images in the ontogeny. The morphological test to apply to these theories was whether the stages of ontogeny resemble successive adult organisations more closely than the corresponding formative stages of ancestral ontogeny. This test was invariably in favour of the "persistence theory" of recapitulation and against the theory of accelerated adult incorporations.

Aristotelian Society, June 6.—Prof. Dawes Hicks, vice-president, in the chair.—Dr. Dorothy Wrinch: The structure of scientific inquiry. In the earlier stages of empirical generalisations results of a general character are built up and applied by means of the forms of reasoning employed in probability inference, viz. induction and analogy. In the more advanced stage the aim of science is to arrange the general propositions which cover, as particular cases, the phenomena of which we are aware in such a way that the phenomena of the world are deducible from the smallest possible number of assumptions. Logical necessity alone can knit together theories and the experimental results which go with them. It is found that logic consists of relations between sets of properties. The general study of the formal and abstract properties is at the foundation of the great advance in modern science. In particular the process of *true analogy*, whereby the problems of electrostatics, current electricity, thermodynamics, and hydrodynamics are simultaneously solved, is of the utmost importance.

PARIS.

Academy of Sciences, May 30.—M. Georges Lemoine in the chair.—A. Blondel: The application of distributed static transformers to the regulation of high-voltage mains.—B. Jekhowsky: Bessel's functions with two variables.—E. Kogbetliantz: The developments of Jacobi.—Et. Delassus: A consequence of the laws of friction.—J. Vallot: Diffuse radiation at Mont Blanc Observatory compared with that at lower altitudes. The stations chosen were at the altitudes 50, 1100, 2500, 4250, and 4350 metres above the sea. A table is given showing mean values for the observations on several exceptionally fine days. The diffuse radiation diminishes at first up to an altitude of 2500 metres, and then at the top of Mont Blanc increases suddenly to nearly double. This is explained by the intense radiation of the snow.—A. Schaumasse: Observations

of the Dubiago comet (1921c) made with the bent equatorial at the Observatory of Nice. Positions given for May 24 and 25. The comet was of the 11.5 magnitude, and showed a slight central condensation.—G. Bruhat and Mlle. M. Hanot: The Lippich black fringe and the precision of polarimetric measurements. From calculations and experiments cited it is concluded that even after choosing the best position of the line of separation it is not possible, with Nicol prisms, to measure a rotation of the order of 20° with an error less than one minute. With more intense sources of light, such as the mercury arc, this error can be reduced by one half.—R. Boulouch: The problem of achromatism of thick-centred systems.—M. Rothé: Radiogoniometry and atmospheric influences. Earlier observations (1914) had shown that in the course of the day Hertzian waves were absorbed by the atmosphere. The present research was an attempt to find out whether, in addition to absorption, the direction of the waves was modified. The deviations observed were of the order of the experimental error, and consequently no certain conclusion could be drawn as to the cause of the small variations observed.—G. Déjardin: The ionisation of argon by slow electrons. An account of the application of the lamp with three electrodes, of the type commonly employed in military wireless telegraphy, to the determination of the ionisation potential of argon. The value found was 15 volts.—A. Dauvillier: The L series of uranium and the principle of combination in X-ray spectra.—A. Cabrier: An automatic lighting and extinguishing apparatus for street gas lamps. An account of an apparatus which has been in use for eight years, and comparison with a similar apparatus recently described by Paul Bernard and Barbe.—V. Auger: Double catalysis of vanadic acid and hydrogen peroxide. Vanadic acid may be reduced to vanadyl sulphate or oxidised to pervanadic acid by hydrogen peroxide in the presence of sulphuric acid, the direction of the change being conditioned by the amount of acid present.—Mlle. Wolf: Furfuralcamphor and some of its derivatives. An account of the product of condensation of furfural with camphor and the substances obtained by reduction.—M. Manolesco: The action of ethylmagnesium bromide on dibenzylidene cyclohexanone and γ -methylcyclohexanone.—G. Tanret: The influence of ammonium molybdate on the rotatory power of some sugars. Changes in the rotatory power produced by adding solutions of ammonium molybdate to solutions of xylose, glucose, rhamnose, arabinose, galactose, sorbose, laevulose, and mannose are given. No change was produced in the rotation of saccharose, maltose, trehalose, lactose, melezitose, raffinose, stachyose, inulin, quercite, and inosite. In the cases of the sugars whose rotation was affected, some evidence is adduced of the formation of a compound between the sugar and the molybdate.—F. Bourion and Ch. Courtois: The formation of Julin's chloride in the preparation of electrolytic chlorine. In certain cases acicular crystals were found in considerable quantities in electrolytic cells. These have been collected, purified, and shown to consist mainly of hexachlorobenzene.—F. Roman and P. de Brun: The structure of the Alpine chain.—Mlle. G. Cousin: The individual variations of *Psiloceras planorbis*.—M. Flajolet: The strong magnetic perturbation of May 14–15, 1921. An account of the magnetic disturbance as shown on the recording instruments at the Lyons Observatory. The needle was at times beyond the limits of registration, and all the telegraphic circuits were seriously affected.—G. Dupont: Contribution to the study of the acid constituents of the secretion of the maritime pine.

Lævopimaric acid is readily isomerised by heat, acetic, and hydrochloric acids, whilst the dextro-acid is unaffected. With hydrochloric acid the change is effected in two stages, first into α -pimarabietic acid, and this into the stable form, β -pimarabietic acid. The latter acid has been isolated and identified with the pure abietic acid isolated by Schultz.—N. A. **Barbieri**: Anatomical study on the retinal termination of the optic nerve in the animal series. Results of anatomical analysis are given which, in the author's opinion, prove the complete and reciprocal independence of the retina and the optic nerve in animals. This would suggest the possibility of surgical intervention in the posterior chamber of the eye.—R. **Noel**: Some functional attitudes of the chondriome of the hepatic cell.—L. M. **Bétances**: Cells with eosinophil granulations of histioid origin in the blood circulating in the embryo.—C. **Gorini**: Sudden physiological mutations in lactic ferments by divergent individuals.—M. **Dervieux**: Method of individual diagnosis of the blood and of sperm. A serum is prepared by sensitising a rabbit by injections of human sperm. This serum gives precipitations with human sperm and human blood, and various applications in diagnosis are suggested. By its means it can be determined whether a given sample of blood is that of a man or a woman.—W. **Kopaczewski**: Food anaphylaxy and its therapeutics. In cases where horse flesh has been taken as food, or where infants have been nourished on the milk of the horse, exceptionally grave symptoms have been observed to follow the injection of antidiphtheric serum produced through the horse. It would appear to be probable that the body can be sensitised to a serum by food.—R. **Bayeux**: The use of oxygen mixed with carbon dioxide in subcutaneous injections, as a treatment of mountain sickness and certain toxic dyspnoea.—R. **Sazerac** and C. **Levaditi**: The action of bismuth on syphilis and on the Nagana trypanosome. Potassium tartarobismuthate exerts a marked curative action on experimental syphilis of the rabbit and on the spontaneous spirillosis of the same animal. The curative effects on Nagana trypanosomiasis, although clear, are inferior to the two above mentioned.

Books Received.

British Museum (Natural History). British Antarctic (*Terra Nova*) Expedition, 1910. Natural History Report. Zoology, vol. iii., No. 9, Insecta. Part i.: Collembola. By Prof. George H. Carpenter. Part ii.: Mallophaga. By James Waterston. Pp. 259-72+i plates. (London: British Museum (Natural History).) 2s. 6d.

Proceedings of the Cambridge Philosophical Society. Vol. xx., part iii. (Lent Term, 1921.) Pp. 285-397. (Cambridge: At the University Press.) 8s. 6d. net.

Traité de Dynamique. By Jean d'Alembert. (Les Maîtres de la Pensée scientifique.) No. i. Pp. xl+102. No. ii. Pp. 187. (Paris: Gauthier-Villars et Cie.)

Les Mouvements des Végétaux. Du Réveil et du Sommeil des Plantes. By Rene Dutrochet. (Les Maîtres de la Pensée scientifique.) Pp. viii+121. (Paris: Gauthier-Villars et Cie.)

Contributions to West Australian Botany. Part iii., Additions and Notes to the Flora of Extra-Tropical West Australia. By C. H. Ostenfeld. Pp. 144+xii plates. (København: A. F. Høst and Son.)

The Analysis of Mind. By Bertrand Russell. (Library of Philosophy.) Pp. 310. (London: G.

Allen and Unwin, Ltd.; New York: The Macmillan Co.) 16s. net.

Mediæval Contributions to Modern Civilisation: A Series of Lectures delivered at King's College, University of London. Edited by Prof. F. J. C. Hearnshaw. Pp. 268. (London and Sydney: G. G. Harrap and Co., Ltd.) 10s. 6d. net.

A Manual of Seismology. By Dr. Charles Davison. (Cambridge Geological Series.) Pp. xii+256. (Cambridge: At the University Press.) 21s. net.

Studies on Arthropoda. By Dr. H. J. Hansen. No. 1. Pp. 80+iv plates. (Copenhagen and London: Gyldendalske Boghandel.)

A History of Persia. By Brig. Gen. Sir Percy Sykes. (In 2 vols.) Second edition. Vol. i. Pp. xxviii+563. Vol. ii. Pp. xx+594. (London: Macmillan and Co., Ltd.) 70s. net.

Greenwich Catalogue of Stars for 1910.0. Part 1: Fundamental Stars. Part 2: Stars in the Zone +24°0' to +32°0'. From Observations with the Transit Circle made at the Royal Observatory, Greenwich, 1906-1914, under the Direction of Sir Frank W. Dyson. Pp. xvii+Axvii+A32+Bxxxvii+B249. (London: H.M. Stationery Office.)

Condensed Description of the Manufacture of Beet Sugar. By Dr. Franz Murke. Pp. v+175. (New York: J. Wiley and Sons, Inc.; London: Chapman and Hall, Ltd.) 15s. net.

Analyses and Energy Values of Foods. By Dr. R. H. A. Plimmer. Pp. 255. (London: H.M. Stationery Office.) 6s. net.

A Dictionary of Applied Chemistry. By Sir Edward Thorpe. Vol. ii.: Calculi to Explosion. Revised and enlarged edition. Pp. viii+717. (London: Longmans, Green and Co.) 60s. net.

Koninklijk Nederlandsch Meteorologisch Instituut. No. 106. Ergebnisse Aerologischer Beobachtungen. No. 7, 1918. Pp. x+76. No. 110. Oceanographische en Meteorologische Waarnemingen in den Atlantischen Ocean, December, Januari, Februari, 1870-1914. Pp. ix+217. (Utrecht: Kenink & Zoon.) 7 florins.

Publications of the Astronomical Laboratory at Groningen. No. 30. Pp. vi+110. No. 31. Pp. iii+83+2 plates. (Groningen: Hoitsema Bros.)

Annalen van de Sterrewacht te Leiden. Deel X., Eerste Stuk. Beobachtungen am Meridiankreis in den Jahren 1899-1902 und Deren Bearbeitung. Pp. At12+111. By Dr. E. F. van de Sande Bakhuyzen and Dr. A. Pannekoek. Deel XII., Eerste Stuk. Outlines of a New Mathematical Theory of Jupiter's Satellites. By W. de Sitter. Pp. 53. Deel XII., Tweede Stuk. Analytical and Numerical Theory of the Motions of the Orbital Planes of Jupiter's Satellites. Secular Terms. By Dr. A. J. Leckie. Pp. iii+100. (Leyden.)

Arabian Medicine: Being the Fitzpatrick Lectures delivered at the College of Physicians in November, 1919, and November, 1920. By Prof. Edward G. Browne. Pp. viii+138. (Cambridge: At the University Press.) 12s. net.

Prehistory. A Study of Early Cultures in Europe and the Mediterranean Basin. By M. C. Burkitt. Pp. xx+438. (Cambridge: At the University Press.) 35s. net.

The Principles of Immunology. By Prof. Howard T. Karsner and Dr. Enrique E. Ecken. Pp. xvii+309+2 plates. (London: J. B. Lippincott Co.) 21s. net.

Ministry of Agriculture and Fisheries. Intelligence Department: Plant Pests Branch. Report on the Occurrence of Insect and Fungus Pests on Plants in England and Wales for the Year 1919. (Miscellaneous Publications, No. 33.) Pp. 68. (London.) 1s. 6d. net.

Diary of Societies.

THURSDAY, JUNE 23.

ROYAL SOCIETY, at 4.30.—Dr. E. F. Armstrong and T. P. Hilditch: A Study of Catalytic Actions at Solid Surfaces. VI. Surface Area and Specific Nature of a Catalyst; Two Independent Factors controlling the Resultant Activity.—Sir J. B. Henderson: A Contribution to the Thermodynamical Theory of Explosions, Part I.; and (with Prof. H. R. Hassé) Part II.—S. Butterworth: Eddy Current Losses in Cylindrical Conductors, with Special Applications to the Alternating-current Resistances of Short Coils.—E. S. Bieler: The Currents induced in a Cable by the Passage of a Mass of Magnetic Material over it.—Dr. G. Barlow and Dr. H. B. Keene: The Experimental Analysis of Sound in Air and Water: Some Experiments towards a Sound Spectrum.—Dr. G. Barlow: The Theory of Analysis of an Electric Current by Periodic Interruption.

FRIDAY, JUNE 24.

PHYSICAL SOCIETY OF LONDON (at Imperial College of Science), at 5.—S. Butterworth: Capacity and Eddy-current Effects in Inductometers.—Dr. E. Griffiths: New Specific Heat Apparatus.—Prof. A. O. Rankine: Encounters between Non-spherical Gas Molecules.—Dr. C. Chree: An Electro-culture Problem.

MONDAY, JUNE 27.

ROYAL SOCIETY OF MEDICINE (Odontology Section), at 8.—K. Fry: The Dental Treatment of Congenital and Other Perforations of the Palate.

TUESDAY, JUNE 28.

ROYAL ANTHROPOLOGICAL INSTITUTE, at 8.15.—L. H. Dudley Buxton: The Ancient and Modern Inhabitants of Malta.

INSTITUTION OF CIVIL ENGINEERS (Engineering Conference), at 9.—Sir George T. Beilby: Fuel Problems of the Future (James Forrest Lecture).

WEDNESDAY, JUNE 29.

INSTITUTION OF CIVIL ENGINEERS (Engineering Conference), at 10 a.m.—The President: Opening of the Conference and Presentation of the John Fritz Medal to Sir Robert A. Hadfield, Bart.—A. Ross: The Structural Outlines of our Home Railways.—O. G. C. Drury: Tunnel Maintenance.—C. R. S. Kirkpatrick: To what Dimensions should Docks be Constructed to Provide for Future Requirements.—A. R. T. Woods: Ship and Harbour Design and Equipment as affecting the Rapid Loading and Discharging of Cargo Vessels.—H. J. Deane: The Development of Crunage Facilities for Discharging Vessels of the Largest Size.—G. FitzGibbon: Reinforced Concrete for Wharves and Breakwaters.—F. E. Wentworth-Shields: The Best Way of Protecting Reinforced Concrete from Marine Deterioration.—L. H. Savile: Reasons for the Deterioration of Reinforced-Concrete Structures above Mean Tide Level.—H. Lupton: Comparison between Reciprocating Pumping Engines and Turbo-driven Centrifugal Pumps.—E. R. Dolby: Exhaust Steam: its Employment for Power, Heating, etc.—J. W. Evans: The Employment of Water Power in the Development of the Mineral Industry.—R. Nelson: Recent Developments in Coal-cleaning Processes.—H. S. Ball: The Francois Cementation Process.—W. L. Roxburgh: The Necessity for and the Possibility of Development of the Coasting Trade.—E. G. Stewart: The Utilisation of Waste Heat in Gasworks.—Dr. J. S. G. Thomas: Desiderata in the Qualities of Town's Gas.—R. O. Kapp: Low Power-factor.

ROYAL SOCIETY OF ARTS, at 4.—Annual General Meeting.

THURSDAY, JUNE 30.

INSTITUTION OF CIVIL ENGINEERS (Engineering Conference), at 10 a.m.—W. W. Grierson: The Use of Reinforced Concrete on Railways.—H. J. Fereday: Impact Tests and Allowances.—A. H. Hall: The Influence of the Automatic and Semi-automatic Machine on the Skill and Resourcefulness of the Mechanic and Operator.—A. Musker: Mechanical Appliances and Labour in Loading and Unloading Ship's Cargoes.—Prof. W. E. Dalby: The Elastic Limit.—Prof. E. G. Coker: The Effect of Scratches in Materials.—C. P. Sandberg: Damage to Tires and Rails caused by Brakes or Slipping Wheels.—G. Hatton: The Existing Practice of Inspecting Work and Materials.—M. E. Denny: The Design of Fabricated Ships from the Labour-saving Point of View.—J. C. Telford: Economy of Labour on Shipbuilding as effected by Fabricated Ships, etc.—E. R. Mumford: Recent Tank Research in Screw Propellers.—E. H. Richards and M. G. Weekes: Straw Filters for Sewage-purification.—J. Haworth: Activated Sludge.—J. D. Watson: De-watering Sludge.—J. Dalziel: Battery Locomotives.

INSTITUTION OF MECHANICAL ENGINEERS, at 10.15 a.m.—Conference on the Means of Increasing the Thermal Efficiency of Heat Power Plants.

ROYAL SOCIETY, at 4.30.—*Probable Papers*.—Sir J. J. Dobbie and Dr. J. J. Fox: The Absorption of Light by Elements in a State of Vapour. The Halogens.—Prof. W. A. Bone and the Late W. A.

Haward: Gaseous Combustion at High Pressures. Part II. The Explosion of Hydrogen-Air and Carbon-monoxide-Air Mixtures.—Prof. A. E. H. Love and F. B. Pidduek: Lagrange's Ballistic Problem.—J. Proudman: The Principles of Internal Ballistics.—R. H. Fowler: A Simple Extension of Fourier's Integral Theorem and Some Physical Applications in particular to the Theory of Quanta.—Capt. D. Brunt: The Dynamics of Revolving Fluid on a Rotating Earth; and other papers.—The following papers will be read in title:—Takeo Shimizu: A Preliminary Note on Branched α -ray Tracks.—Takeo Shimizu: A Reciprocating Expansion Apparatus for detecting Ionising Rays.—Prof. R. W. Wood: The Time Interval between Absorption and Emission of Light in Fluorescence.

FRIDAY, JULY 1.

INSTITUTION OF CIVIL ENGINEERS (Engineering Conference), at 10 a.m.—R. G. H. Clements: Road Vehicles and their Relation to Road Surfaces.—A. Dryland: Advantages of Bituminous Macadam.—C. H. J. Clayton: The Conservancy and Maintenance of Rivers from the Point of View of Land Drainage.—R. F. Grantham: The Effect of Sluices and Barrages on the Discharge of Tidal Rivers.—G. E. W. Cruttwell: The Utility of Models for Estuarial Experiments.—H. C. Reid: The Relative Advantages of Dredging and Training-walls in Estuaries.—E. Latham: The Use of Inertia Gauges in Pile Driving.—A. L. Bell: The Bearing Power of Soils.—Sir James McKeechnie: Internal-combustion Engines with Large Cylinders.—Sir Vincent L. Raven: The Mechanical Advantages of Electric Locomotives compared with Steam.—T. Crook: The Effect of the War on Mineral Supplies.—M. Deacon: The Utilisation of Exhaust Steam in Turbines.—W. C. Mountain: Steam *versus* Electric Winding.—S. Cowper-Coles: The Relative Values of Protective Metallic Coatings for Iron and Steel.—J. Richardson: Recent Progress in Large Diesel Engines for the Mercantile Marine.—R. J. Walker and S. S. Cook: Experience with Marine Turbine Reduction-gears.—E. Sandeman: Compensation Water.—F. W. Macaulay: Pipes for Pressure Conduits.—Dr. H. Lapworth: The Relation of Run-off to Rainfall.—Economic Limits of Distribution from Coal-fired Stations.—B. Welbourn: Low-voltage Overhead Distribution.

INSTITUTION OF MECHANICAL ENGINEERS, at 10.30 a.m.—Conference on the Means of Increasing the Thermal Efficiency of Heat Power Plants.

CONTENTS.

	PAGE
"Index-Numbers" and Wages-Regulation	513
Psychology and Psychopathology	515
French Chemists and the War. By Sir T. E. Thorpe, C.B., F.R.S.	516
Sport and Administration in Central Africa. By Sir H. H. Johnston, G.C.M.G., K.C.B.	518
Our Bookshelf	519
Letters to the Editor:—	
The Constitution of Nickel—Dr. F. W. Aston, F.R.S.	520
A Novel Magneto-Optical Effect.—Prof. Elihu Thomson	520
Geometrical Isomerism in Monomolecular Films. (<i>Illustrated</i>).—N. K. Adam	522
Sources and Sinks. (<i>Illustrated</i>).—A. F. Dufton	522
Polarisation Phenomena in an X-ray Bulb.—Dr. S. Ratner	522
Observations of Plant-growth with the Recording Ultramicrometer. (<i>Illustrated</i>).—John J. Dowling	523
Cup and Ring Markings.—C. Carus-Wilson	523
Some War Developments of Explosives. (<i>Illustrated</i>). By Sir Robert Robertson, K.B.E., F.R.S.	524
Stellar Parallax. By Sir Frank Dyson, F.R.S.	527
Obituary:—	
William Warde Fowler, 1847-1921. By E. B. P. R. E. Denrett. By C.	528
Sir Thomas Wrightson, Bart., M.Inst.C.E.	530
Notes	530
Our Astronomical Column:—	
The Meteoric Radiants of June 25-30	535
Report of the Kodaikanal Observatory for 1920	535
Popular Astronomy in Sweden	535
The Second Royal Society Conversazione	536
The South-Eastern Union of Scientific Societies	537
The Orientation of the Dead	538
The National Academy of Sciences, U.S.A.	539
A New Treatment of Sleeping Sickness	540
University and Educational Intelligence	540
Calendar of Scientific Pioneers	541
Societies and Academies	541
Books Received	543
Diary of Societies	544



THURSDAY, JUNE 30, 1921.

Editorial and Publishing Offices:

MACMILLAN & CO., LTD.,

ST. MARTIN'S STREET, LONDON, W.C.2

Advertisements and business letters should be
addressed to the Publishers.

Editorial communications to the Editor.

Telegraphic Address: PHUSIS, LONDON.

Telephone Number: GERRARD 8830.

American and British Superannuation Systems.

THE fifteenth annual report of the president and of the treasurer of the Carnegie Foundation for the Advancement of Teaching provides some interesting reading, particularly with regard to the pension system in operation in the universities and colleges of the United States. The work of the Foundation falls into three parts: (1) the completion and liquidation of the old system of full-paid pensions; (2) the development of the contractual forms of insurance and of old-age annuities through the policies of the Teachers' Insurance and Annuity Association; and (3) the prosecution of significant studies and reports through the Division of Educational Inquiry. The last-named constitutes an important and active branch of the Foundation, with an income derived from the investment of a capital of one and a quarter million dollars. Its most recent inquiries relate to the subjects of legal education and the training of teachers. As a result, "A Study of the Training of Teachers for the Public Schools" has recently been published, and there is promised in the immediate future the first section of a "Study of Legal Education." Without doubt, such inquiries form an increasingly valuable feature of the work of the Foundation.

On the other hand, it is to be noted that the trustees administer a total sum of almost twenty-five million dollars, the income from which is at present mainly devoted to superannuation purposes. For the year ending June 30, 1920, the sum

of 875,514 dollars was granted in retiring allowances to administrative officers and teachers or their widows in certain of the colleges and universities in America. As is well known, the gift was intended primarily to establish retiring allowances for teachers in the higher institutions of learning in the United States, Canada, and Newfoundland. The income was, however, quite insufficient to provide for all these, and at present the pension obligations of the Foundation are confined to some five or six thousand teachers and administrative officers who were in the service of institutions associated with the Carnegie Foundation on November 17, 1915. As the income is released, it will be devoted to the advancement of teaching in American colleges and universities.

With regard to the officers and teachers who do not participate in these pensions—the large majority—the trustees have promoted a contractual plan of old-age annuities, and some fifty pages of the report give an account of its progress and development. In brief, it is a contributory system of deferred annuities which will gradually supersede the previous non-contributory pension scheme. It is intended that the teacher should contribute 5 per cent. of his salary, and the institutions a like sum, the combined premium to be paid to the Teachers' Insurance and Annuity Association and to become the property of the association. In exchange the teacher will receive an annuity policy—a contract which guarantees that in case he dies before the stated age a sum equal to the premiums with interest will be paid to his dependents, and that in case he lives to the stated age a selected annuity of equivalent value will be paid. It will be observed that insurance is considered a responsibility of the teacher alone. The success of the scheme so far may be measured by the fact that the association, which began the issuing of contracts in March, 1919, had, by July, 1920, issued policies representing more than two and a half million dollars insurance, and also annuities representing the payment at maturity of nearly half a million dollars annually.

It is instructive to compare this scheme with the Federated Superannuation System of British universities. In the first place, some five or six thousand American teachers who were in service in the associated institutions before November 17, 1915, are well provided for by the Foundation by means of a non-contributory scheme for which there is no parallel in the British scheme. The nearest approach to this splendid provision is the

recent Government grant of 500,000l.—a sum, however, which is less than half what is required to put the pensions of the senior members of the university staffs upon a satisfactory footing. In addition, the Carnegie Foundation will continue to provide retiring allowances on the same non-contributory basis to a certain number of old and distinguished teachers. Next, in the British system there is no specific provision for widows or orphans, nor is there provision for disability such as has been instituted by the Carnegie Foundation “for the teacher who, despite his own foresight and self-denial, finds himself and his family the victims of disease or of accident.” The reserve accumulated to meet such claims is now 220,000 dollars.

Further, the American scheme is administered from within, as opposed to the Federated System, which is worked through insurance companies. In consequence, there is economy in administrative and other expenses. Insurance companies are not philanthropic institutions. Mr. Fisher, President of the Board of Education, on the second reading of the School Teachers (Superannuation) Bill, 1918, was aware of this when he stated that if the Act were worked through insurance companies there would be the objection that public money was going in dividends to the shareholders of these companies. This is precisely what is happening in the Federated Superannuation System to-day. The Teachers' Insurance and Annuity Association furnishes policies better suited to the teacher's needs, and at lower cost, than companies operating on a commercial basis.

The report contains a mass of interesting matter relating to pensions and pension schemes, including arguments, by no means convincing, in favour of contributory schemes as opposed to non-contributory.

Lord Rayleigh's Scientific Papers.

Scientific Papers. By Prof. John William Strutt. Vol. vi., 1911-19. Pp. xvi+718. (Cambridge: At the University Press, 1920.) 50s. net.

THE sixth¹ volume of Lord Rayleigh's collected works, just issued by the Cambridge University Press, contains his papers, nearly one hundred in number, published between 1911 and his death in 1919. In fact, the last two papers, Nos. 445 and 446, of the whole series were left ready for publication, but had not appeared when

¹ A notice of vol. v. appeared in *NATURE* for October 28, 1913. The other volumes were reviewed at an earlier date.

he died, while the concluding paragraphs of No. 444, on “The Travelling Cyclone,” were dictated by him only five days before his death on June 30. He was happy in being able to continue his work until so near the end, and in his fifty years of active scientific life to achieve so much.

The papers in the volume range over a wide list of subjects, and while none of them have the importance of some of those appearing in earlier volumes—e.g. the series on the fundamental units of electrical measurements, or the publications describing his work on gases and the discovery of argon—they are marked, as ever, by his power of clear thinking, his grasp of first principles, and his ability to appreciate the essentials of any problem which appealed to him. Some three or four of the articles were contributed to the discussions of the Advisory Committee for Aeronautics, over which he presided for ten years. Among these may be specially mentioned No. 389, the note on the formula for the gradient wind, in which the formula connecting the velocity of the wind, the barometric pressure, the latitude, and the rotation of the earth, which had been employed by Gold and other meteorologists, is derived, assuming the motion in two dimensions, from hydrodynamical principles. The paper No. 444, already mentioned, on “The Travelling Cyclone,” though not formally communicated to the Committee, arose out of its discussions.

There are also some notes and reviews communicated to *NATURE*, but most of the other articles appeared in the *Philosophical Magazine*. Hydrodynamics, optics, and acoustics form the subject-matter of many—problems of vibrations in the solution of which the methods developed in the theory of sound or in some of his earlier optical work are employed with success. Of recent years he returned to a number of optical problems which in earlier days had interested him, and advanced our knowledge by his work. Among these papers may be mentioned several on the scattering of light by small particles. The problem was discussed in the well-known paper on “The Blue of the Sky,” published in 1871, and in 1918 Lord Rayleigh gave the complete solution for a sphere in which the structure is symmetrical, but periodically variable, along the radius, while a further paper—*Phil. Mag.*, vol. xxxv.—discussed the case of the scattering of light by a cloud of similar small particles of any shape oriented at random. He was led to investigate the question by the results of his eldest son's experiments on light scattered by carefully filtered gases.

One of the papers communicated to the Advisory Committee for Aeronautics deals with the analogy between the conduction of heat from a surface and the transfer of momentum in a viscous fluid flowing over the surface. Lord Rayleigh shows that the analogy, which holds so long as the motion is laminar, breaks down when it becomes turbulent. A letter to Prof. Nernst, dated October, 1911, is of rather special interest, though there is nothing in the later pages of the volume to indicate whether or not Lord Rayleigh continued to hold the same opinion to the end. He is discussing some of the difficulties which attend the kinetic theory of gases, and writes:—

“Perhaps this failure might be invoked in support of the views of Planck and his school that the laws of dynamics (as hitherto understood) cannot be applied to the smallest parts of bodies. But I must confess that I do not like this solution of the puzzle. Of course, I have nothing to say against following out the consequences of the [quantum] theory of energy—a procedure which has already, in the hands of able men, led to some interesting conclusions. But I have a difficulty in accepting it as a picture of what actually takes place.”

A paper in the *Philosophical Magazine* for 1919 of somewhat greater length than the majority of those in the present volume deals with the optical character of some brilliant animal colours. The question whether the colours displayed by various birds, by butterflies, and by beetles are structure colours more or less like those of thin plates or are due to surface or quasi-metallic reflection is discussed, and the conclusion reached by Lord Rayleigh is thus stated:—

“The impression left on my mind is that the phenomena cannot plausibly be explained as due to surface colour, which in my experience is always less saturated than the transmission colour, and that, on the other hand, the interference theory presents no particular difficulty unless it be that of finding sufficient room within the thickness of the cuticle.”

In the paper a reference is made to the drawings and conclusions of the Hon. H. Onslow, some of which have since been published.

It is not necessary to add more, or to attempt to give a full account of the contents of the volume under review; there is interest to be found in every page, and throughout it is marked by the characteristics of Lord Rayleigh's writings. He is to be commemorated by a tablet and inscription in the Abbey; the six volumes of his collected works form his true memorial, built by himself, to live so long as there are students of physical science to read and learn the truths which they contain.

The volume has been edited by his son, the present Lord Rayleigh, with the help of Mr. W. F. Sedgwick. It is published by the Cambridge University Press in its usual admirable style, and concludes with a classified table of contents of the whole of the six volumes. The list, occupying some forty pages, shows in a remarkable way the extent of ground covered by Lord Rayleigh's contributions to physical science.

Studies of British Mammals.

Habits and Characters of British Wild Animals.

By H. Mortimer Batten. Pp. 346. (London and Edinburgh: W. and R. Chambers, Ltd., 1920.) 21s. net.

THERE are several trustworthy and readily available books on British mammals, such as Lydekker's and Sir H. H. Johnston's, not to speak of the expensive volumes of Millais and others, but there is a distinctiveness in Mr. Mortimer Batten's studies which makes them welcome. They have a broad basis of personal observation, they give prominence to habits, and they try to get at the character of the creatures. The book is written in excellent style; it smacks of the open country, and it is packed with interesting information without being overloaded. The very artistic illustrations by Mr. Warwick Reynolds appeal to us as revealing the temperament of the animals portrayed and also as pictures, e.g. the charming coloured frontispiece of roe-deer jumping up at rowan berries.

Mr. Mortimer Batten deals with red deer, roe-deer, fox, weasel, stoat, otter, pine-marten, badger, polecat, brown hare, mountain hare, rabbit, hedgehog, squirrel, brown rat, water-vole, and wild cat. Without rigidly adhering to any scheme, he discusses range, feeding habits, breeding, struggle for existence, interrelations, general characteristics, size, weight, and last, not least, the disposition or character. We wish that, when he was at it, he had completed his survey of British mammals so that his excellent book might have been a comprehensive unity. A second edition should remedy this. We do not mean that there need be any treatment of the Orkney vole and that sort of thing, but we miss the little gentleman in the velvet coat; we should like to have seen the book representative of all the short list of British mammals. We must protest, of course, against the usage which calls this a book on British wild *animals*.

We have found Mr. Mortimer Batten's studies full of interest, and we have a lively appreciation of their originality and independence. Sometimes, we confess, his theoretical interpretations

make us pause, e.g. the suggestion (after rejecting all others known to the author) that the biological significance of the stag's antlers is to divert the attention of enemies from the hinds. Sometimes we wish the author had been a little more bookish, for his remarks on the correlation between antlers and reproductive organs are far from being up to date. We are sorry that he has no contribution to make to our knowledge of the method of the ermine's assumption of its white dress, the precise mode of which seems still uncertain. Was Prof. MacGillivray right or Mr. Aplin, or were both right? Sometimes the author's generalisations pull us up with a start: "There is no logic in the ways of Nature." But we thought that Darwin proved there was! The fact is that Mr. Mortimer Batten is stronger on the side of natural history than on the side of biology. He rather scoffs at the protective value of the whiteness of the mountain hare in winter, but he does not mention the other utilitarian interpretation—in relation to body-temperature. He says of the common hare: "Wherein lies the secret of the hare's survival? In its fecundity, and there alone." Yet the preceding pages make it perfectly clear that this is not the case. Again, to take a more concrete point, it is surely in a metaphorical sense only that we can speak of the hedgehog's fat serving "as sustenance during the foodless days of sleep." It is interesting to notice that the author occupies a Lamarckian position as regards the mental endowment of the subjects of his studies:—"All these things the water-voles of to-day do not, probably, reason out for themselves; the knowledge of them has been inherited from countless generations of forefathers who, atom by atom, grain by grain, have profited by their experience, and, acting accordingly, have handed their lessons on to their children, thus establishing such life habits and customs of the species that we have to-day a water-vole that can hold its own." But we are afraid there is no plane-sailing for this theory.

We have often thought that great benefit might result to science if a field-naturalist like Mr. Mortimer Batten were to test biological theories in the light of the everyday life of the creatures he knows. If, however, this is to be of avail, the field-naturalist must first sit at the feet of the biologists, and he will not do this because they do not know a badger's track. Thus the possibilities of a mutually profitable partnership are lost. We must not forget, however, that this book was meant, not for biologists, but for ordinary folk interested in the country, especially for those who can understand and sympathise with the author's plea for the pine-marten. To such the book is

strongly to be recommended. It is first-hand material, vividly presented, abounding in picturesque and essential detail, and making a resolute attempt to see each of these wild mammals as an individuality with a character and temperament of its own.

Forestry in France.

Studies in French Forestry. By T. S. Woolsey, jun. With two chapters by W. B. Greeley. Pp. xxvi+550. (New York: John Wiley and Sons, Inc.; London: Chapman and Hall, Ltd., 1920.) 36s. net.

MR. T. S. WOOLSEY, who is well known as an expert in and an authoritative writer on forestry, has given to American and British foresters in his "Studies in French Forestry" a means of gaining a deep insight into the theory and practice of forestry in France. The material for the present book was collected largely in 1912, but administrative work at home and service with the U.S. Corps of Engineers during the war prevented earlier publication. That is, we think, a fortunate thing, because the author has been able to include much information regarding the wonderful organisation of the French Forestry Service and the Allied Forestry Corps in maintaining an adequate supply of timber. Many forests had to be clear-felled, and others were so depleted of growing stock that "normal" production cannot be secured for a century or more. There are more than a million acres of French soil to be restored to productivity, and the rehabilitation of innumerable forests—300,000 acres—the growing stocks of which have been cleared or seriously depleted, must be brought about by the strictest economy at a time when the economic demands for wood products will be at least double the normal consumption.

The attitude of public opinion in France in regard to the rôle of the forest in national economics is reflected in the extremely stringent regulations contained in the National Forest Code. The common law alone is regarded as inadequate for the protection of forests in France; therefore the special forest code provides not only against wilful damage, but also against damage due to carelessness or ignorance in dealing with forests and forest lands. Still, it is not by these means that France has established her State, communal, and privately owned forests. She has in actual practice relied more on methods of example and co-operation in building up and establishing for all time her excellent forest reserves and systems of management.

The influence of the forest or its indirect value

is a matter of great importance from national, economic, and æsthetic points of view, yet this phase of forest utility is only too often ignored. In a short but interesting chapter the author has succeeded in summarising the main facts and focussing them in an admirably lucid manner.

In the succeeding chapter the forest regions of France and the important tree species are described. An interesting review is given of the area, topography, and prevailing climatic conditions of France, and striking illustrations are given of the recent wonderful development of the natural resources of the country in hydraulic power. Further on are presented the forest statistical data, which bring out many points of absorbing interest. One striking fact is that the number of small forest owners is incredibly large. The small owner of less than 25 acres of forest is greatly in the majority, but the proportion of sawn timber to fuel wood in State-owned or technically managed forests is much more advantageous than in those privately owned.

The natural and artificial regeneration of forests, as practised in France, is well worth the close attention of students of silviculture. An excellent account is also given of the control by afforestation of mountain torrents and lowland floods, which in the past have caused privation and ruin to thousands of the population, and untold loss to the nation.

The author also gives a most interesting account—historical, statistical, and technical—of the wonderful forests of the Landes. The almost magical transformation of a barren, fever-stricken waste of something like two million acres into a healthy and prosperous revenue-yielding territory, to the enormous advantage of France and every individual Frenchman, was a marvellous achievement. The State, as the author puts it, "blazed the trail," the good lead was followed by the "communes," and private effort did the rest. Much useful information is given concerning French Government regulations and working plans, the features of French national forest administration, and private forestry in France.

An interesting account is given of the activities of the Forest Engineers in France. The vital importance of timber in modern warfare is shown in many ways, and it is safe to conclude that without the well-planned forests and timber resources of France "the war might have been a draw or a defeat instead of a victory."

A number of interesting appendices are added which deal with specific forestry subjects, including an exhaustive list of French forestry literature, and there is a good index. The book is well illustrated with photographs and diagrams.

Our Bookshelf.

Official Statistics. By Prof. A. L. Bowley. (The World of To-day.) Pp. 63. (London: Humphrey Milford: Oxford University Press, 1921.) 2s. 6d.

A LITTLE book on statistics by so well-known an authority as Prof. Bowley is sure of a welcome from the educated public. In these times, when copious reports are issued by many Government departments, it is not only interesting, but also necessary, to appreciate fully the significance and limitations of official statistics. This is admittedly difficult, and it is with the view of steering the uninitiated through the mass of detail which necessarily obscures the real value of statistical information that Prof. Bowley has written this little book. A brief account is given of the more important reports and papers published officially in recent years containing statistics of general interest. The use of reports is illustrated by collecting details scattered throughout such a volume as the Report on Pauperism and retabulating them so as to show how the various tables are connected. In all cases exact references have been given to the original documents. The scope of the volume is well indicated by the chapter headings, four in number: population; industry, trade, and prices; income and wages; and social conditions.

A Laboratory Manual of Organic Chemistry for Medical Students. By Prof. M. Steel. Second edition. Pp. xi+284. (New York: John Wiley and Sons, Inc.; London: Chapman and Hall, Ltd., 1920.) 9s. 6d. net.

A CHAPTER on colloids which contains some interesting experiments forms the principal addition to this edition. Many careless expressions have been overlooked: "fused" copper sulphate and "fused" calcium oxide are not common reagents, and "hyroscopic" (p. 32) appears instead of "hygroscopic." Moreover, some of the directions for experiments do not seem to be based on trials, e.g. the preparation of acetylene would be dangerous if carried out as described on pp. 19-20, for air could not be displaced from the apparatus under the conditions named; also the directions given for the preparation of colloidal platinum on p. 220 do not seem correct—it would be difficult to pass a current of 10 amperes through distilled water by applying only 40 volts.

Ammonia and the Nitrides: With Special Reference to their Synthesis. By Dr. E. B. Maxted. Pp. viii+116. (London: J. and A. Churchill, 1921.) 7s. 6d. net.

THIS small volume contains an account of laboratory investigations of the nitrides of the elements. No mention is, however, made of the very important industrial applications of the results except in the case of the Serpek process, which is not in use in the form described by the author. "Deville," on p. 37, should be "Regnault."

Letters to the Editor.

[The Editor does not hold himself responsible for opinions expressed by his correspondents. Neither can he undertake to return, or to correspond with the writers of, rejected manuscripts intended for this or any other part of NATURE. No notice is taken of anonymous communications.]

Co-operative Indexing of Periodical Literature.

THE following remarks refer to the periodical literature of science alone. The present lack of system in indexing this leads, we all know, to a huge waste of energy. If this could be saved by intelligent co-operation it might be set free for more profitable work. The leading article in NATURE of June 9 may help towards this both by the information that it gives and by that which it may elicit. For example, it recognises that a necessary preliminary is a survey of the periodicals in the libraries, and it states that for the United Kingdom such a survey was prepared in 1914-15 and is in MS. at the British Museum. This can scarcely have been within the knowledge of the Conjoint Board of Scientific Societies when it issued a recent appeal for this information to the scientific libraries of London, nor can it have been known to the Zoological Record Committee of the Zoological Society when it still more recently instructed its editor to make a similar survey for its own purposes. If NATURE can help forward the publication of a complete survey it will do good service.

The next step, so far as this country is concerned, will be to fill up gaps and to render all the periodical literature of any consequence accessible to the indexers. Your article does not touch on this, but it is surely more important for us that a paper should be accessible than that an index-slip for it should be sent from Bulgaria or Bolivia.

You consider the publication of abstracts before that of the index to be indefensible. This is not clear. It is possible to publish an abstract at the same time as (or even before) the original paper; the abstract is complete in itself, and, since it is in the nature of news, the sooner it is distributed the better. The index-slips can also be issued at the same time; but they have little meaning until arranged in an index, and the more complete the index is, and the larger (within limits) the period it covers, the better. Consequently, the index volume falls to be published later than the abstracts. The index material is of no use to the abstractor, and the indexer should not work from an abstract. Index and abstract are different in aim, in substance, and in mode of preparation. Their sole connection is that they deal with the same material, and both demand that material to be accessible. We return then to the primary need of completing our libraries as the best way of helping both parties.

This conclusion is opposed to your other suggestion, that the best way, so far as science is concerned, is to get index-slips from the Central Bureau of the International Catalogue of Scientific Literature. If this means a return to the attempt at furnishing slips through a number of national bureaux, it may be dismissed as discredited and now less workable than ever. If it means that the Central Bureau is to embark on all the work of collecting the literature, analysing it, and preparing the slips, may one ask if the proposer has considered whence the staff, offices, and funds are to be obtained?

Finally, what is the use of a general conference to determine the requirements of special branches of knowledge? Let each branch of science look after

its own abstracts and indexes. Probably this would best be done by the leading societies, as for some sciences it already is. Any society taking the lead in its own branch should receive ungrudging aid from the others who are not so ready to shoulder the burden. Let general international help be concentrated on supplying the first essential, namely, the publications that are to be indexed. And so we are back where we started—at the foundation that has to be laid firmly and broadly.

F. A. BATHER.

June 11.

In considering the future of indexing, must not the method of indexing and abstracting depend on the purpose and future utility of abstracts? Do we want the means of manufacturing footnotes by unlimited references, or a guide in research? If for research, does a worker wish—or have time—to look up every reference, or does he want to get the sense of what has been done that will affect him? Can all classes of subjects be treated usefully on a uniform system, or is there any reason for doing so? Can a discrimination be expressed between papers that advance a subject, by new facts or new arrangements, and those that are inconclusive? Should an abstractor be entirely mechanical, or should any criticism be allowed?

A small experience in one department, of abstracting the produce of some twenty foreign periodicals (special and general) with a view to future utility, has led me to adopt the following standard:—

(1) State briefly every new fact and argument that leads to a definite result.

(2) Add references to any confirmatory or contradictory facts that have been omitted.

(3) Suggest if the paper is essential.

Such abstracts should be indexed at suitable intervals.

Some such standard seems likely to be the most useful for present reading and future research, in some subjects. How far would such a standard be desirable or applicable to different subjects? How far can individuals be found to make themselves responsible for dealing with their own special branch?

Too often, after struggling through thorn-brakes of German, or seas of Italian diffuseness, one emerges at the same point again, and finds that the whole is a rhetorical exercise. Should not workers be protected from such writing? Think of the future, with another century of accumulated writing, even at the present rate.

W. M. FLINDERS PETRIE.

I AM in entire sympathy with the leading article in NATURE of June 9 on the subject of the co-operative indexing of scientific communications to periodicals. If, however, any scheme is to be carried out efficiently competent workers must be employed, and they must be adequately paid, which is no easy matter in these days.

I cannot, however, subscribe on the scientific side to the assumption that there is any considerable amount of periodical literature consisting of "water-tight compartments containing homogeneous material" presenting "no special difficulties" in indexing. The different sciences are becoming more and more interdependent. For example, geological investigators are continually in need of results obtained in other spheres of work, such as chemistry, physics, astronomy, geodesics, botany, and zoology. Numerous facts important to geologists also occur scattered through technical mining publications. It is important that all these fields should be gleaned in the interests of

geology, as well as the common land of general periodical literature. The index of advances in physics required by a geologist will differ materially from that which meets the needs of a physicist.

JOHN W. EVANS.

Imperial College, South Kensington, June 12.

In the very interesting and important leader of your issue of June 9, dealing with the co-operative indexing of periodical literature, attention is mainly confined to the natural sciences, but whatever is said as to the necessity for some new co-operative effort there in order to render more accessible the contributions in what you call the non-homogeneous class of periodicals, the need is even greater in another field of knowledge. May I venture to point out that in the field of one of the political sciences, if history and its allied subjects can be included in such a term, co-operation is even more urgently needed, and may be profitably undertaken along similar lines and in close concert? In very few fields of historical investigation do workers possess the advantages that are afforded by comprehensive bibliographies of recent publications, and practically nowhere are there to be found abstracts such as are familiar to their colleagues in chemistry, physics, and other natural sciences. The "Lists of Writings on American History" that have been published since 1902 under the auspices of the American Historical Association, and the bibliography of "Publications relating to the History of Canada," published at Toronto, show that it is entirely practicable to undertake such work with success. At the approaching conference of Anglo-American Historians, to be held in the University of London on July 11-16, various schemes for co-operative effort are to be considered, and among them may possibly be projects for co-operative lists of periodical publications. It is hoped by many of those who are taking part in the conference that some concrete results will arise from these discussions. May I, therefore, suggest that when any steps are taken to summon a conference such as you propose for the extension of the bibliographical equipment of the sciences opportunities should be afforded to the historians to take part? It would be an inestimable boon if the principle of co-operative and co-ordinated action on common lines could be extended as widely as possible in the fields where the scientific method can be profitably employed.

ARTHUR PERCIVAL NEWTON.

University of London, King's College,
June 18.

I HAVE read with great interest the leading article on "Co-operative Indexing of Periodical Literature" in NATURE of June 9.

I have never been concerned with any work involving indexing of scientific periodicals, and those which have been my business, dealing with the classics, Oriental subjects, and bibliography, are essentially of the "watertight" character which present a much less serious problem to the student.

I think, however, there is one class of publication to which I should direct attention in connection with the subject of indexing for the use of present and future students, namely, official publications (Parliamentary papers, Stationery Office publications, reports of committees, etc.), which contain a great quantity of material which must necessarily be of value to investigators in various lines of research, and the lack of a clue to them is serious, especially as they are, from their quasi-anonymous

nature, difficult to discover in the ordinary library catalogue.

If any conference such as that suggested in your article were called, I hope it would consider the indexing of these as well as of periodicals in the strict sense of the word. I do not think that any endowment will be forthcoming from public funds, but librarians in Government Departments and other Civil Servants with bibliographical interests would probably be willing to help in the work of compilation. I should certainly be prepared to make myself responsible for slips analysing the papers laid before Parliament by the Foreign Office.

June 11.

STEPHEN GASELEE.

W. Warde Fowler: A Personal Appreciation.

ALL who know his "Tales of the Birds" will deplore the loss of this gifted observer and writer. My review—three and a half pages long!—of his charming booklet, "An Oxford Correspondence of 1903," under the title "Oxford on the Up Grade," in NATURE, June 16, 1904, was the beginning of an all too infrequent correspondence. He was good enough to write that I had entered into the spirit of his views more than any other critic. They certainly appealed to me at the time; and to-day, when mere memorising and over-examination—including psycho-analysis—are becoming more and more of a curse and subversive of all mental progress, they merit the most careful consideration. Warde Fowler had cast off the blinkers worn usually by the literary man and could see widely. He could console his pupil's father for the son's failure in the I.C.S. examination by saying, "Never mind; he will do good work in life as soon as he recovers from the effects of his education."

In a postscript to his last letter to Jim Holmes, his young correspondent, he remarks:—

I agree with what you said in your last letter about Greats. We had better grow our own plants instead of introducing exotics; but we must take care that our own plants get a real chance of coming to perfection.

Here the Oxford position is stated in a sentence; but the newer Universities are still more open to the implied criticism—as in all of them far too many things are attempted and the plants consequently are of stunted growth. In the interval, there has been advance at Oxford but not on an even grade; and the beer-point of enthusiasm (see my review) is not yet reached. So ineffective is the influence of its environment, that a professor, who over a long period had shut up the instruments of research in glass cases, into whose lap a great fortune had been dropped, could die recently without benefit to the University.

Take, too, his interesting quotation from Roger Ascham's "Scholemaster":—

"All such Authors as be fullest of good matter and right judgement in doctrine be likewise always most proper in wordes, most apte in sentence, most plain and pure in uttering the same."

On this he makes the comment:—

If I am not mistaken, this would have delighted Darwin.

This is not only a just recognition of Darwin's literary gift but should serve to confound Sir A. Quiller Couch and all those who presume to scoff at the literary shortcomings of scientific workers—without recognising how few literary men can be plain or pure in their utterance and how few either have

matter to write about—rarely anything novel—or can produce doctrine worth consideration. Usually they are but dealers in hashed mutton; they may spice it pleasantly but it is still hash. "It is astonishing what nonsense able men will sometimes write, just because they don't know even the elementary laws of scientific investigation," said Warde Fowler.

I have a letter of his before me, from Kingham, Chipping Norton, dated July, 1913, acknowledging a pamphlet on Nature Study which I had sent to him:—

I must confess (he writes) to an innate aversion from "Nature Study" in inverted commas and capital letters, *i.e.* as practised in too many schools, because I know that the teachers are quite ready to "teach" what they don't understand a bit and that the only person who can really help the children in these things is one who is learning himself all the time and learning not only from books but using them just as a help. I am very glad to see that you have the same kind of feeling.

Then he speaks of his work in the village school:—

This week, for example, I have given away two copies of my recent book on this village (which is sought after in the village) as prizes for accounts of the growth of corn (which is growing all around us in different stages) from the seed to the fruit, with specimens. Two girls won the prizes and there were some dozen good answers. The boys seemed more interested in the processes of agriculture than in the growth of the plant and the boys are fewer in number than the girls. I myself have learnt much that I did not know before and so has the schoolmaster. They were all silent or in difficulties about the bloom of the corn and no wonder. What a number of beautiful and interesting things there are to be learnt about it. To-day I have been learning something about the corn smut and turned out a book about diseases of cereals which I had hardly opened since I wrote my "Roman Festivals" and wanted to know something about the *robigo*, for the Festival of *Mildew* (*Robigalia*). One wants a microscope, however, to interest children in such things as that.

I feel as if I should like to go on talking to you but I must be content with thanking you for your reminiscence of my young friend Jim Holmes, for whom I still have a sneaking fondness, as the only (or almost the only) creature of my brain.

In the "Roman Festivals," a work of marvellous erudition and research, he devotes quite a long section to the discussion of the *Robigalia* and remarks that "the red mildew was at times so terrible a scourge that the *Robigalia* (April 25) must in early Rome, when the population lived on corn grown near the city, have been a festival of very real meaning. A red dog was sacrificed to *Robigus*, the spirit who works in mildew. Nowadays nothing that happens in agriculture is marked by sacrifice."

Whether we think of Warde Fowler as literary man or naturalist, however, for the man who could write:—

I will tell you that the joy of discovering something that you did not know before is in my experience very great and that the joy of finding that so far as your knowledge goes no one ever found it out before is far greater,

we shall long keep a place in our memory. Oxford will best serve his memory by increasing the number who can have that joy, as to-day, it may be feared, we are farther off than we ever were from that "general and vehement spirit of search in the air,"

which Lord Morley long ago proclaimed to be our prime need: not a few schools, too, are aiming at a classical revival; the meaning of science is not yet with them generally.

H. E. A.

Ionisation Potential and the Size of the Atom.

It is known that there is for different elements a relation between the ionising potential and atomic volume, the one increasing as the other diminishes. Hughes in his book on "Photo-electricity" (p. 51) indicates that the work in removing an electron wholly from an atom might be expected to vary inversely as the radius. In other words, the ionising potential might be inversely proportional to the cube-root of the atomic volume.

Now W. L. Bragg, in the *Philosophical Magazine* (August, 1920), has given the diameters of atoms in Angstrom units (10^{-8} cm.), on the assumption of close packing in crystal structure. The diameter which he determines is more strictly the distance from centre to centre of contiguous atoms of the same kind. The dimensions which he thus found are far smaller than those deduced from calculations by kinetic theory.

It appears desirable to make a comparison of the ionisation potentials (1) with the diameters as given by W. L. Bragg, and (2) with the cube-root of the atomic volume.

In the subjoined table the name of the element, the ionisation potential, and Bragg's diameter ($\times 10^8$), are set forth in the first three columns. The product of the diameter and ionising potential appear in the fourth column. The cube-root of the atomic volume is stated in the fifth column, and its product with the ionisation potential in the sixth column.

Group I.					
I.	II.	III.	IV.	V.	VI.
Element	Ionisation potential	Diameter $\times 10^8$	II. \times III.	Cube root of atomic volume	II. \times V.
Na	5.11	3.55	18.1	2.87	14.7
K	4.32	4.15	17.9	3.57	15.4
Rb	4.16	4.50	18.7	3.81	15.9
Cs	3.88	4.75	18.4	4.12	16.0
			Mean 18.3		Mean 15.5
			Range 0.8		Range 1.3
Group II.					
Mg	7.61	2.85	21.7	2.40	18.3
Ca	6.09	3.40	20.8	2.96	18.0
Sr	5.67	3.90	22.2	3.25	18.4
Ba	5.19	4.20	21.8	3.31	17.2
			Mean 21.6		Mean 18.0
			Range 1.4		Range 1.2
Group II.B.					
Zn	9.35	2.65	24.8	2.09	19.5
Cd	8.95	3.20	28.6	2.35	21.0
Hg	10.38			2.45	25.4
Group III.B.					
Tl	7.3	4.50	32.8	2.58	18.8
Group IV.B.					
Pb	7.93	3.80	30.1	2.63	20.8

<i>Group V.A.</i>					
As	11.5	2.52	29.0	2.36	27.2
				or 2.52	or 29.0
P	13.3			2.37	31.5
				or 2.57	or 34.2
<i>Group VI.</i>					
S	8.30	2.05	17.0	2.50	20.8
	or 12.2	2.05	or 25.0	2.50	or 30.4
<i>Group VII.A.</i>					
I	10.1	2.80	28.3	2.95	29.8
	or 8.0	2.80	or 22.4	2.95	or 23.6
<i>Inert Gases.</i>					
He	25.4			2.86	73.0
Ne	16	1.30	20.8	2.67	42.8
A	12	2.05	24.6	3.03	36.4

In the first group of the periodic table the products shown in each of the fourth and sixth columns of the above table are fairly concordant, so that we may conclude that the work done in the removal of an exterior electron is nearly proportional inversely as the radius.

The same remark applies to four elements of the second group, while the members of sub-group B diverge considerably from the values for the A group. According to Urbach (*Phys. Zeit.*, February, 1921, p. 116), the elements of the B sub-group have a double ring of electrons in the outer zone, while those of the A sub-group have a single ring. In the case of the inert gases, neon and argon, the diameters estimated by Bragg give products in the fourth column in far better accord with theory than those found from the cube-root of the atomic volume set forth in the sixth column.

The values for certain elements in groups iii.-vii. are given in the table for comparison, but our knowledge of ionising potentials is as yet too fragmentary to permit of any definite conclusions.

The ultimate solution of this problem may involve calculations of the character given by Sir J. J. Thomson in his recent paper in the *Philosophical Magazine* (March, 1921, p. 526).

I am indebted to Prof. A. L. Hughes for his assistance in endeavouring to collect the most trustworthy values for the ionising potentials.

A. S. EVE.

Macdonald Physics Building,
McGill University, Montreal, June 6.

A Novel Magneto-Optical Effect.

THE interesting observation recorded by Prof. Elihu Thomson in *NATURE* of June 23, p. 520, seems likely to have a bearing on the old Reichenbach experiments, which were for the most part disbelieved by orthodox science, but on which Sir William Barrett and others made some careful observations, to ascertain what truth there might be in them. The effects could not be denied, but they were capricious; and in view of Prof. Elihu Thomson's discovery, it seems possible that the luminosity may have been visible to sensitive percipients when there was a trace of magnetic dust in the room and when other light was not excluded. The obvious precaution of excluding other light may have been the condition which militated against the examination of the phenomenon, which it was then thought was presumably of a subjective character.

OLIVER LODGE.

June 25.

NO. 2696, VOL. 107]

Helicopters.

ONE often sees published statements to the effect that a helicopter has been invented and that wonderful things are expected of it. If the design gets as far as an actual trial a few alterations are found to be required, and then nothing more is heard of the matter.

To make a machine which without an extravagant expenditure of power will raise itself vertically and remain poised in the air is possible and most desirable, and the many failures in the attempt to do this are all attributable (omitting mistakes in mechanical design) to the same cause, namely, that of giving an insufficient area to the lifting surface.

The sort of area required may be gathered from the following illustration. Let two aeroplanes facing in opposite directions be connected by a few hundred yards of light line joining their wing-tips. The machines so connected could rise and circle round each other without much difficulty. When in the air the line might be hauled in until the wing-tips were almost in contact, and in this condition the combined machines would form a helicopter. There would be no banking, as the connecting line would take the centrifugal force, but more power would be required than when the machines were flying independently on account of the lower speed and efficiency of the inner pair of wings.

The function of a screw or lifting surface is to generate a downward current of air, the reaction of which on the surface shall be equal to the weight supported. If L^2 is the cross-section area of this current (dependent on, though not identical with, the area of the lifting surface), V its velocity, and W the weight, $L^2 V^2 \times (\text{constant somewhat greater than half the density of air}) = W$. Hence LV is a constant, and V is inversely proportional to L .

The power required to maintain the current is WV , and can therefore be reduced by making L/V large.

For instance, if W can be sustained on a current of area L^2 by P horse-power, only half this power would be required if the current area were $4L^2$.

A. MALLOCK.

A Physical Interpretation of the Energy Quantum.

THE work of Bohr (*Phil. Mag.*, 1913-15) indicates that we may assume stability only for *some* electronic orbits, i.e. amplitude changes occur discontinuously. We arrive at a similar conclusion in the case of the vibrating atoms of solids if we accept the quantum explanation of the change in their specific heats with temperature.

It is here suggested that the amplitude of a periodic disturbance in the æther can alter only by definite amounts which depend on its frequency, so that as soon as any part of a wave-front meets with something that is capable of inducing a decrease in amplitude, such as a suitably situated electron, that part suffers a definite decrease of amplitude, which extends back into the wave-train (uniformly in all directions in an isotropic medium) to the extent of one quantum. The æther is relieved of its energy of strain, not continuously, but in quanta.

With the modification suggested above the wave theory renders understandable, on one hand, phenomena such as interference, and, on the other, phenomena such as the photo-electric effect, a detailed discussion of which is here impossible owing to lack of space.

More light might be thrown on this subject by a mathematical treatment.

IAN AUCKEN.

The County School, Long Eaton,
June 13.

University Statistics of the United Kingdom, 1919-20.¹

UP to the year 1913-14 the Board of Education presented Annual Reports relating to university institutions in England and Wales in receipt of grants from the Board, but during the war this publication was discontinued. The volume now issued by the University Grants Committee marks the end of this five-years statistical holiday and the starting-point of a series of returns which, including, as they do, Scottish and Irish institutions in receipt of annual grants, and, as they presumably will, the Universities of Oxford and Cambridge and Trinity College, Dublin, will be far more comprehensive and significant than the pre-war returns published by the Board of Education. In eight comparative tables the public is provided with an abundant, but compact, store of information regarding university students of both sexes—whence they came, at what ages they were admitted, where they resided while pursuing their studies, the directions and durations of the courses they followed, the degrees and diplomas they gained—as well as complete statements of the grants made from the Treasury in each of the years 1913-14 to 1919-20. These are followed by notes and statistics and accounts concerning each institution separately. The notes are arranged under such heads as "Faculties and Subjects," "Extension Work," "Cost of Living and Hostel Facilities," "Local Support." To the accounts of income and expenditure are appended expenditure schedules showing, separately for each department, the salaries of departmental heads, number and salaries of other teachers, cost of departmental and laboratory maintenance, etc. In future years income and expenditure are to be tabulated in comparative statements, and the cost per student of each institution is to be exhibited.

In the following paragraphs an attempt is made to indicate the more salient features of the information given in the collated statistics, and as these do not, as yet, include the students of Oxford, Cambridge, Trinity College, Dublin, the colleges at Durham, Guy's Hospital Medical School and some other schools of the University of London, and University College, Exeter, supplementary figures have been quoted from the 1921 edition of "The Yearbook of the Universities of the British Empire."

The number of full-time students, as given in the tables, was 37,081, of whom 27 per cent. were women. The total for England alone, 20,486, may be analysed topographically as follows, using round numbers: London institutions, 8000; North Midland group of universities—Birmingham, Leeds, Liverpool, Manchester, and Sheffield—with the Manchester College of Technology and Nottingham University College, 9300; Bristol University, with the Merchant Venturers'

Technical College and the University Colleges of Southampton and Reading, 2000; Armstrong College and the College of Medicine, Newcastle-upon-Tyne, 1200. The totals for Wales, Scotland, and Ireland are 2473, 10,992, and 3130 respectively. Compared with the returns for 1913-14, the numbers show increases of 83, 101, 31, and 76 per cent. in England, Wales, Scotland, and Ireland.

The results obtained by adding to the above figures statistics from the "Yearbook" may be stated thus: Oxford and Cambridge (including 1100 women), 11,800; London, 10,100; North Midlands, 9300; the rest of England, 3400; Scotland and Wales, as above; Ireland, 4500; grand total of full-time students, 52,600.

In any estimate of the significance of these statistics it is important to bear in mind that a very large number of persons engaged in studies of university grade are not accounted for either in the Grants Committee's tables—because they are not students of grant-receiving institutions—or in the "Universities' Yearbook"—because they do not belong to any university or university college. The institutions in the United Kingdom in which professional education of university grade is provided, although they are not organically connected with any university—theological colleges, training colleges, agricultural colleges, schools of mines, etc.—are numerous and important. Moreover, there are many students reading privately for the external degrees of the University of London, for the Bar, etc. On the other hand, it must be remembered, as pointed out in the Grants Committee's introduction to its returns, that there were in 1919-20 nearly 17,000 full-time ex-Service students in attendance at university institutions in the United Kingdom (including 11,500 attending institutions in receipt of Treasury grants), and that when this special source of supply comes to an end there may be a substantial fall in the numbers.

Again, in any attempt to compare the number of university students in the United Kingdom with the corresponding number in, for example, the United States of America, where, in 1918, there were 224,000 men and 151,000 women in 672 universities, colleges, and professional schools, it would be necessary to allow for several important differences in the conditions of higher education between the countries compared. For example, the work of the higher forms of many of our secondary schools corresponds with the earlier stages of the work done in many of the American colleges and collegiate departments of universities, and in many of the American institutions the enrolment of part-time students constitutes a very large proportion of the total number. In France the number of students in 1913-14 in the University of Paris (17,500) and the fifteen provincial universities amounted to 39,000, but special branches of knowledge, tech-

¹ Returns from Universities and University Colleges in Receipt of Treasury Grant, 1919-20. Presented to Parliament by the University Grants Committee, April, 1921. (Cmd. 1263.) 3s. 6d.

nology, and research were cultivated in numerous institutes and schools outside the universities.

A new and interesting feature of the returns is the classification of full-time students according to *locality of home residence*. The homes of approximately 60 per cent. were within 30 miles of the university, of 35 per cent. in other parts of the United Kingdom, of 4 per cent. (1390) within the British Empire overseas, of 2 per cent. (646) in foreign countries. The following institutions drew a noticeably high percentage of their students from beyond the 30-mile radius: University of Glasgow (50 per cent.), London Medical Schools (52), King's College Household and Social Science Department (58), Westfield College (61), University Colleges of Galway (62), Dublin (71), Reading (72), Aberystwyth (78). Those most frequented by students from outside the United Kingdom are shown in the following list, wherein the first figure (A) represents the total number of such students, and the second (B) the number from *foreign countries*:

	A	B
University of Edinburgh	494	58
„ „ Glasgow	202	100
„ „ Aberdeen	52	7
„ „ Birmingham	139	48
„ „ Liverpool	56	9
Armstrong College	49	41
Royal Technical College, Glasgow ...	41	24
College of Technology, Manchester ...	51	29
Imperial College of Science and Technology	90	42
London Medical Schools	338	60
London School of Economics	88	75
University and King's Colleges, London	176	54

It will be noticed that a large proportion of the students from overseas in schools of technology and the London School of Economics were foreigners.

As regards Oxford and Cambridge and the other university institutions which find no place in these tables, the "Yearbook" does not indicate the sources from which their students are supplied, but the Universities Bureau of the British Empire a few months ago collected lists of students from other countries, both British and foreign, studying in the universities and university colleges of the United Kingdom, and it has permitted the publication of the following totals, taken from these lists, of students from (a) the British Empire overseas, (b) foreign countries: Oxford (a) 307, (b) 308; Cambridge (a) 290, (b) 126; Dublin (a) 91, (b) 2; Guy's Hospital Medical School (a) 195, (b) 26. The Oxford figures reflect the influence of the Rhodes Scholarships, which provide for the continuous residence at Oxford of 186 scholars drawn from the United States of America (two from each State), as well as from Canada and Newfoundland, Australasia, South Africa, the West Indies, and Malta. Apart from this, however, Oxford

exerts on American students a powerful attraction, as is shown by an analysis of the (b) figures given above. Separating students from the United States of America (c) from other foreign students (d), the totals for Oxford are (c) 217, (d) 91; for Cambridge, (c) 34, (d) 92. Nearly all the students from overseas at Trinity College, Dublin, came from South Africa.

From the same source the following statistics have been compiled: Students from Asia, 1228; Africa, 1046; Europe, 703; America and the West Indies, 676; the Pacific (Australasia), 282. The countries contributing most largely to these totals are listed below with the distribution of the students to London (a), Oxford and Cambridge (b), Edinburgh (c), and Glasgow (d):—

	Total	(a)	(b)	(c)	(d)
India, Burma, and Ceylon	974	418	200	157	58
South Africa	781	267	155	178	30
U.S.A.	362	72	251	25	4
Australia and New Zealand	279	50	151	57	4
Egypt	223	78	13	28	4
Canada and New- foundland	164	33	105	18	1
China	112	36	14	22	10
Japan	54	34	7	2	3
Russia	113	70	25	4	5
Serbs, Croats, and Slovenes	75	7	18	11	9
Rumania	68	32	3	2	4
France	66	21	15	2	3
Norway	62	20	8	3	12
Greece	50	17	18	1	3

Of the students from South Africa, 229 were at the London Medical Schools, and 32 at Aberdeen. Of those from Egypt, 51 were at the London Medical Schools, 41 at Manchester and Liverpool, and 39 (24 medical) at Birmingham.

In future years the Grants Committee will present a comparative statement showing the number of new entrants who had previously attended a secondary school for three years or more, and the number who commenced their education in a public elementary school. In a few cases this information is given for 1919-20 in the separate chapters devoted to the several institutions; thus the College of Technology, Manchester, reports that of 286 full-time students 137 began their education in a public elementary school.

"The increasing demand for *Halls of Residence* and for more facilities for corporate life," says the Committee in its introduction, "makes it important to show the extent to which provision of the kind is made." Accordingly, Table 1 classifies students with reference to university residence. Half of them, it appears, lived at home, 37 per cent. in lodgings (22 per cent. of the women and 42 per cent. of the men), and 11 per cent. (4025) in halls of residence, these

constituting 26 per cent. of the women and only 5 per cent. of the men. These proportions would, of course, be very different if the figures included the students of Oxford, Cambridge, and Trinity College, Dublin. In Wales, Scotland, and Ireland the proportion of students in lodgings is much higher—of those living at home, lower—than in England. There are good grounds for believing that future returns will show a substantial increase in the proportion of students living in halls of residence. Meanwhile, it may be noted that accommodation of this kind has already been provided for 80 per cent. of its students by Reading University College, for 47 per cent. of their students by the London Women's Colleges, for 36 per cent. by Dublin University College, for 30 per cent. by the University Colleges of Southampton, Aberystwyth, and Bangor, and for 23 per cent. by the University of Bristol.

The total number of full-time students admitted in 1919–20 for the first time for degree and diploma courses is given in Table 2 as 17,381, of whom rather more than one-fifth were women. They represent half and 38 per cent. respectively of the full-time men and women students in the institutions in question. The *ages at admission* of two-thirds of the men and one-half of the women were nineteen and over; of four-fifths of the men and five-sixths of the women, eighteen and over; while only 352 men and 53 women were under seventeen. Of these last-mentioned juvenile entrants Glasgow is responsible for 71, Birmingham for 51, and East London College for 26.

Table 3 gives particulars of *part-time students* taking courses of university standard. The total number, 15,234, of whom 23 per cent. were women, includes (a) 10,524 occasional, (b) 2389 diploma, (c) 890 degree, (d) 576 research, and (e) 1055 other post-graduate students. The chief contributors to these totals were:—

	(a)	(b)	(c), (d), (e)
Royal Technical College, Glasgow	2787	255	—
London School of Economics	1934	28	228
University and King's Colleges, London ...	1403	391	796
University of Leeds ...	661	33	39
University of Sheffield ...	416	663	34

Tutorial classes are organised in co-operation with the Workers' Educational Association by all the universities of England and by those of Wales, Aberdeen, Edinburgh, and Belfast. Particulars given in the several returns show that upwards of 5000 students attended these classes.

Research students were at work in all the institutions figuring in the returns except a few medical schools. Their total number was 1009, including 533 full-time students. Women researchers numbered 339. London institutions had 586 research students, Manchester 133, Liverpool 126, Birmingham 43. Post-graduate students

other than those engaged in research numbered 1592, including 1055 part-time students. London alone accounts for 869 of these (765 part-time). Such data as are available for estimating the number of research and other post-graduate students at work in the university institutions excluded from these tables point to a total of about 1200.

The classification of full-time students by *faculties* gives the first place to medicine, including dentistry, with 12,657, including 2949 women. In the faculties of arts, theology, law, music, commerce, economics, and education were 11,745, including 5309 women; in pure science, 6571 (1538 women); in engineering, applied chemistry, etc., 6114 (145 women). Medical and dental students were most numerous in London (3347), Glasgow (1838), Edinburgh (1739), Liverpool (741), and Aberdeen (704). They outnumbered all other students put together in Belfast and the colleges of the National University of Ireland (in University College, Dublin, they were in a majority of almost 2 to 1), and were above 40 per cent. of the total in Glasgow, Aberdeen, and Edinburgh. Corresponding figures for Oxford, Cambridge, and Trinity College, Dublin, are not available. The statistics of degrees and diplomas gained so soon after the war present, of course, abnormal features. The total numbers of recipients were: Of degrees, 4054, including 1275 women; diplomas, 2062 (599 women); degrees according to faculties: arts, theology, law, music, commerce, economics, and education, 1666; pure science, 1074; medicine, 1008; engineering, applied chemistry, etc., 306.

Tables 7 and 8 exhibit the Treasury grants, annual and special, made to university institutions for 1913–14, when they amounted to 442,147*l.*, and each later year to 1919–20. The annual grants show but few important variations up to 1918–19, but in the following year they were increased, on the whole, by 70 per cent., and amounted to 786,500*l.* Of this, 198,000*l.* went to London institutions, 260,000*l.* to others in England, 52,500*l.* to Wales, 165,000*l.* to Scotland, and 111,000*l.* to Ireland. The special grants amounted to 104,000*l.* in 1915–16, 12,000*l.* in 1918–19, and 304,000*l.* in 1919–20, in which year special emergency grants pending the reports of the Royal Commissions inquiring into their financial resources were received by Oxford (30,000*l.*), Cambridge (30,000*l.*), and Trinity College, Dublin (12,000*l.*). The Civil Service Estimates of March last show 1,000,000*l.* for grants in 1920–21, and 1,500,000*l.* for grants in 1921–22. A further sum of 500,000*l.* is provided for grants in 1921–22 to the Federated Super-annuation Funds for Universities. The principles upon which it is proposed to allocate grants in future are discussed in a report presented by the University Grants Committee on February 3, 1921, a paper which is likely to exercise a far-reaching influence on the further development of our universities and their relations with the State.

Protective Measures against X-rays and Radium.

A COMMITTEE was recently formed in London to see whether some general precautionary measures could be outlined which would be of service to those employed in the use of X-rays or radium for medical, scientific, or industrial purposes. The members of the committee are as follows: Sir Humphry Rolleston (chairman), Sir Archibald Reid, Dr. Robert Knox, Dr. G. Harrison Orton, Dr. S. Gilbert Scott, Dr. J. C. Mottram, Dr. G. W. C. Kaye, and Mr. Cuthbert Andrews. Dr. Stanley Melville and Prof. S. Russ are acting as honorary secretaries to the committee. The need for a statement on this subject has been felt for some time. During the war the Röntgen Society issued a printed card pointing out the dangers of exposing parts of the body to X-rays unduly, but the uses of these forms of radiation are becoming so numerous in medicine and the arts that it was felt that the ground should be gone over in more detail, and general recommendations drawn up as to the conditions under which work of this character should be carried out.

The preliminary report of the committee has just been issued. It is a carefully thought-out statement of present knowledge in regard to the equipment, ventilation, and working conditions of X-ray and radium departments. We are glad to see from the introduction to the report that the committee holds the view that the dangers which may attend the use of these radiations can be avoided entirely by the provision of efficient protection and suitable working conditions.

The damage which people have suffered in the past falls into two categories:—

(1) Visible injuries to the superficial tissues which may result in permanent damage.

(2) Derangements of internal organs and changes in the blood. These are especially important, as their early manifestation is often unrecognised.

The protective measures to be employed naturally vary with the work in hand, and the report contains details of the measures which the committee thinks appropriate to (1) X-rays for diagnostic purposes, (2) X-rays for superficial therapy,

(3) X-rays for deep therapy, (4) X-rays for industrial and research purposes, (5) electrical precautions in X-ray departments, (6) ventilation of X-ray departments, and (7) radium therapy.

The report concludes with a statement bearing upon several aspects of the subject, and we accordingly reproduce it in full:

“The governing bodies of many institutions where radiological work is carried on may wish to have further guarantees of the general safety of the conditions under which their *personnel* work.

“(1) Although the committee believe that an adequate degree of safety would result if the recommendations now put forward were acted upon, they would point out that this is entirely dependent upon the loyal co-operation of the *personnel* in following the precautionary measures outlined for their benefit.

“(2) The committee would also point out that the National Physical Laboratory, Teddington, is prepared to carry out exact measurements upon X-ray protective materials, and to arrange for periodic inspection of existing installations on the lines of the present recommendations.

“(3) Further, in view of the varying susceptibilities of workers to radiation, the committee recommend that wherever possible periodic tests—*e.g.* every three months—be made upon the blood of the *personnel*, so that any changes which occur may be recognised at an early stage. In the present state of our knowledge it is difficult to decide when small variations from the normal blood-count become significant.”

It is satisfactory to learn that the committee intends to continue to meet and to consider the advisability of directing some researches which arise out of the considerations involved in the memorandum in question.

Suggestions and offers of personal or other assistance are invited; they should be forwarded to the honorary secretaries of the X-ray and Radium Protection Committee, from whom copies of the preliminary report may be obtained, c/o Royal Society of Medicine, Wimpole Street, W.1.

Cosmogony and Stellar Evolution.¹

By J. H. JEANS, SEC.R.S.

I.—*The Evolution of Gaseous Masses.*

THE progress of observational astronomy has made it abundantly clear that astronomical formations fall into well-defined classes; they are almost “manufactured articles” in the sense in which Clerk Maxwell applied the phrase to atoms. Just as atoms of hydrogen or calcium are believed to be of similar structure no matter where they are found, so star-clusters, spiral nebulae, binary stars are seen to be similar, although in

a less degree, no matter in what part of the sky they appear. The problem of cosmogony is to investigate the origins of these comparatively uniform formations and the process of transition from one class to another.

In attacking this problem the cosmogonist of to-day stands upon the shoulders not only of previous cosmogonists, but also, what is of even greater importance, upon the shoulders of the brilliant and industrious astronomical observers of the past century. We shall find it convenient

¹ Lectures delivered at King's College on May 3 and 10.

to take as our starting point the most famous theory of cosmogony ever propounded—the nebular hypothesis of Laplace—and we shall examine to what extent it remains tenable in the light of modern observational and theoretical research.

Laplace's hypothesis referred primarily to the genesis of the solar system, which he believed to have originated out of a hot nebulous mass that shrank as it cooled. The nebula was supposed to be in rotation, so that the principle of conservation of angular momentum required that as the mass cooled its speed of rotation should increase. It is well known that a mass either of gas or of liquid in rotation cannot rest in equilibrium in the spherical shape which would be assumed in the absence of rotation. If the rotation is very slow the equilibrium shape will be an oblate spheroid of small eccentricity. As the rotation increases, the ellipticity will increase, but it is found that the spheroidal shape is soon departed from. Laplace believed, as a matter of conjecture rather than of reasoned proof, that with continually increasing rotation a mass of gas would in time reach a stage at which it could no longer exist as a single continuous mass. When this stage was reached he believed that a ring of particles would be discharged from the equator through the centrifugal force of rotation outweighing the centripetal force of gravitation. The mathematical researches of Roche (1873) provided some support for this general conjecture, and more recent investigations put its general accuracy beyond doubt.

It is found that the changes of shape which accompany increase of rotation are, in their general features, the same for all masses, whether gaseous or fluid, provided only that there is sufficient central condensation of mass. When the rotation becomes so great that the spheroidal figure is departed from, the equator of the mass is found to pull out into a pronounced edge which ultimately becomes perfectly sharp (see Fig. 1). The mass has now assumed a lenticular shape, and any further increase of rotation results in matter being discharged from this sharp edge. The lenticular shape is retained from now on, the sharp edge acting like a safety valve and emitting just so much matter as is necessary to carry off the excess of angular momentum beyond the maximum which can be carried by the central mass. Fig. 1 shows the configurations of the lenticular figures for masses of gas in adiabatic equilibrium, in which γ (ratio of specific heats) has the extreme values 1.2 and 2.2 respectively. Other calculated lenticular figures show generally similar shapes. With a further increase of rotation beyond that for which these curves are drawn, the figures would remain unaltered save for the addition of a distribution of matter in the equatorial plane—the matter already thrown off from the sharp edge of the lens.

If gaseous stars assume these forms our telescopes refuse to reveal them. Even in the most powerful telescopes the stars remain infinitesimal

points of light; the only bodies which show any observable shape are the nebulae. It is highly significant that a number of these exhibit precisely the lenticular shape just described. This is in most cases accompanied by a distribution of matter in the plane through the sharp edge of the lens. A number of such nebulae have been found by direct spectroscopic observation to be in rotation about an axis perpendicular to this plane. Thus there is very strong justification for supposing that these nebulae are masses of gas or other matter with high central condensation behaving precisely as imagined by Laplace—rotating and throwing off their excess of angular momentum as they cool by the ejection of matter in their equatorial planes.

There is, however, almost incontrovertible evidence that the nebulae which have just been described are nothing but ordinary spiral nebulae seen edgewise, for observation discloses a continuous sequence of nebulae the shapes of which bridge completely the gap between the lenticular nebulae, in which we are looking at right angles to the axis of rotation, and the familiar spiral nebula in which we look approximately along this axis. The characteristic nebula shows a nucleus which we can now identify with the lenticular

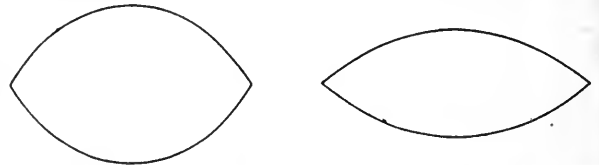

FIG. 1.—Figures of equilibrium for rotating masses of gas.

figure demanded by theory, having two arms emerging symmetrically from opposite points of the nucleus. If our identification is correct these arms must be formed out of the matter already discharged from the nucleus. It has in point of fact been found by van Maanen and Kostinsky that the matter in the arms appears to be in motion approximately along the arms and in the outward direction.

Any external gravitational field, whether of the universe as a whole or of neighbouring stars or nebulae, would produce a tidal field similar to that produced by the sun and moon on the surface of our earth, a field specified mathematically by a second harmonic. This field, no matter how small in amount, would suffice to destroy the exact circular shape of the "equator" of the nucleus and so would concentrate the emission of matter at two opposite points on this equator. Thus it is easy to understand why the nebulae, as a rule, exhibit two symmetrical arms emerging from antipodal points. It is very much less easy to understand why these arms should be of the universal spiral form—the absence of any explanation of this form must be regarded as a serious drawback to our interpretation of the spiral nebulae. It is readily proved that the ejected filaments of matter, whatever the shape they assume, could not remain of uniform line-density.

Such a distribution of density would be unstable, and it can be proved that nuclei would form at approximately equal distances, around which the matter of the arms would condense. In this way it is possible to explain the nuclei and condensations which are observed in the arms of the spiral nebulae. It is also found possible to calculate the amount of matter which will condense around each nucleus; the mass of each is found to be of the order of magnitude of the known masses of the stars.

In this way I have been led to conjecture that the spiral nebulae are whirling masses of gas which, owing to their rapidity of rotation, throw off gaseous stars such as a "Catherine-wheel" firework throws off sparks. If so, the condensations in the arms of these nebulae are stars in the process of birth. Dynamically the mechanism is almost identical with that imagined by Laplace as resulting in the birth of systems of planets and satellites, but on a far more stupendous scale. The final product of the chain of events we have been considering must be some type of star-cluster—perhaps a globular star-cluster, or possibly an "island-universe" similar to our galactic system. The difficulties in the way of an exact mathematical investigation into the history of the ejected gas as the filaments condense around nuclei and as these form stars and begin to move as detached bodies are enormous. On the other hand, the determination of the final steady states possible for a system of stars created in this way is quite simple. There is found to be only one type of final steady state possible for a system of stars created out of a rotating mass of gas, and this shows exactly the features presented by the system of stars of which our sun is a member. The system of stars will be of a flattened shape, symmetrical about the plane of greatest cross-section (the galactic plane in our system); the velocities in any small region of space will not be distributed at random, but will show a preference for two opposite directions ("star-streaming"); these directions will be parallel to the plane of symmetry and perpendicular to the radius to the centre of the system. This last direction is that given by Charlier for the direction of "star-streaming" in our system. Our system passes all tests for having been born out of a spiral nebula the plane of which was what is now the plane of the Milky Way; indeed, Easton and others have claimed to find traces of the two spiral arms still surviving in the distribution of stars in this plane, as though the final steady state had not yet been reached.

Let us now turn to a study of the lives of individual stars. To the naked eye the stars appear as mere points of light of varying brightness. The telescope adds little except possibly differences of colour. The spectroscope appears at first to add a wealth of new information, but a detailed study of stellar spectra discloses the unexpected fact that all stellar spectra, apart from a few exceptions, fall into one single linear series. Photographs of the spectra of all stars, in which

varying exposures have been made to compensate for varying brightnesses, can be arranged uniquely in a consecutive order in which each spectrum differs only imperceptibly from its neighbour. All the complicated diversities of stellar spectra appear to be determined, in the main, by one single variable. This is believed, with good reason, to be the temperature of the star's surface.

Positions on this linear series are specified by reference to six selected points denoted by the letters B, A, F, G, K, M in this order. The order given is that of decreasing surface temperature. Stars having B-spectra are of bluish colour with a surface temperature of 10,000° C. or more. Stars of type M are red with a surface temperature of only 3000° C. Our sun is of type G, with a surface temperature of about 6000° C.

We might also arrange the stars in order of brightness. The distances of many stars are known, and for these we can calculate the "absolute brightness" or "luminosity"—*i.e.* the amount of light emitted as compared with our sun. Since the masses of the stars are all approximately the same, it might be expected that the order of "luminosity" would prove to be substantially the same as that of surface temperature, but this does not prove to be the case. Eight years ago it was found by Hertzsprung and H. N. Russell that the red M-stars fell into two widely different classes, one class having abnormally high luminosity, and the other abnormally low. The ratio of luminosities in the two classes is of the order of 10,000 to 1, and since the surface temperatures are the same, this ratio must imply a corresponding ratio in the areas of the radiating surfaces. Thus the two classes of M-stars must have volumes in a ratio of about 1,000,000 to one, for which sufficient reason they have been designated "giants" and "dwarfs." From a comprehensive discussion by Russell, recently confirmed by Adams and Joy, it is clear that the demarcation between "giants" and "dwarfs" extends, although with diminished intensity, through the types K, G, and F, while at types A and B the classes coalesce.

Lately Shapley, by determining the distances of the globular clusters, has greatly increased our knowledge of stellar luminosities, and has calculated the individual luminosities of 1152 giant stars in clusters. If we plot the logarithms of the luminosity (or the absolute magnitude) against spectral type as in Fig. 2, the vast majority of Shapley's 1152 stars are found to lie within the belt marked "giants," while of the stars previously discussed by Russell and by Adams and Joy nearly all lie either within this belt or within that marked "dwarfs." In this diagram a few typical stars have been marked. The stars α Orionis and our near neighbour Lalande 21,185 are examples of giant and dwarf red stars. The diameter of the former has recently been found by direct measurement to be about 300 times that of our sun, corresponding to a density of the order of at most one-thousandth of that of atmospheric air; the latter has a luminosity only 0.009 times that of the sun, and probably a mean density com-

parable with that of the earth. Our sun and our nearest stellar neighbour, α Centauri, are marked as typical dwarfs of type G, and Sirius is a representative A-type star.

From the known luminosity and surface temperature of any star it is easy to calculate its surface and so its density. Giants of types G and K are found to have densities of the order of 0.004 and 0.0005 respectively, agreeing with the known densities of binary stars of these types. Sirius, with a luminosity of forty-eight times, and a surface temperature about one and a half times, those of our sun, must have a surface nine times as great. Its mass is 3.4 times the solar mass, so that its density must be about 0.2. In general it is found that all giant stars must be gaseous, of

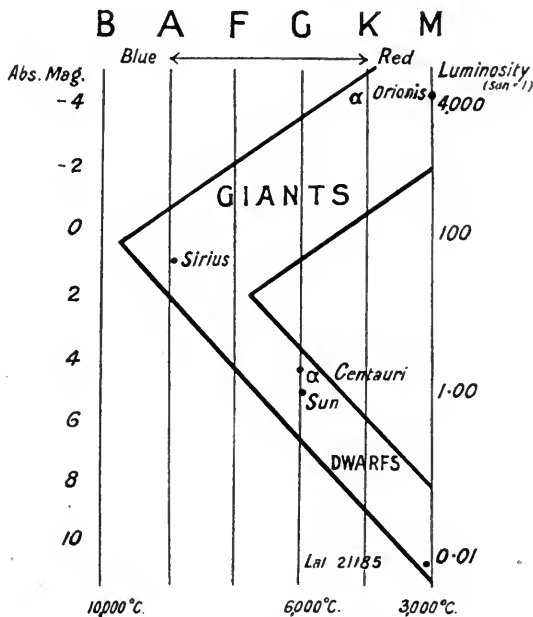

FIG. 2.—Luminosity-temperature diagram.

density so low that the ordinary gas-laws will be approximately obeyed. Dwarf stars may be gaseous or liquid or solid, but, if gaseous, they are so dense that the gas-laws will be nowhere near the truth. It is now easy to see why, in the giant stars, increase of temperature and density go together; this is merely a consequence of Lane's law. But the dwarfs may be

thought of as approximating rather to masses of fixed dimensions, and for these the luminosity falls off as the temperature decreases.

Our sun radiates light at a rate of about 2 ergs per second per gram of its mass. Gravitational contraction, as Lord Kelvin showed, could provide energy at this rate for only about 20,000,000 years, and radio-active and chemical energy could only slightly lengthen this period. For a giant star, radiating at 1000 times the rate of the sun, the maximum period would be only a few thousand years. This period is far too short, and it is now generally accepted that, so far from gravitation and known sources of energy providing the whole of a star's radiation, they can provide only an insignificant fraction. Energy of adequate amount can originate only from sub-atomic sources, as, for instance, from internal rearrangements in the positive nuclei of the atoms or from the transformation of a small fraction of the star's mass into energy. It is a matter of simple calculation to show that all other stores of energy in a star can constitute only an insignificant reservoir of energy which, unless continually replenished from sub-atomic sources, would be exhausted in, astronomically, a moment. Thus the rates of radiation and of generation of sub-atomic energy must be practically equal, and the luminosity of a star will be determined by the latter rate at any instant.

We may now think of the evolution of the stars as represented by the march of a vast army through our diagram (Fig. 2), the individuals keeping, for the most part, within the marked belt. Each individual takes his marching orders from the supply of sub-atomic energy, and so long as we remain in ignorance of the exact source and nature of this we cannot be certain whether the motion of the army is up or down, or even that it is all in the same direction. But if we are right in conjecturing that the stars were born out of a nebula of very low density, the order of march will be from low density to high; our army will be marching downwards in the diagram. Its tail, except for a few stragglers, is about at absolute magnitude -4, its head is lost in darkness. In the next lecture we must study the incidents which may occur during the march of this army of stars.

(To be continued.)

Obituary.

DR. A. M. KELLAS.

BY the death of Dr. A. M. Kellas we have lost one of the best authorities on the effect of high altitudes on the human system. No one else had so great a practical knowledge, or worked scientifically at the subject with more persistence than he.

Born in Aberdeen, he was educated there, and afterwards went to Edinburgh, London, and Heidelberg. For some time he was assistant to

Sir William Ramsay, and afterwards lecturer on chemistry at Middlesex Hospital.

As a teacher he was most successful, taking endless trouble in helping backward students. In pure chemistry he did little research, his chief contribution being a long and careful investigation on "The Determination of the Molecular Complexity of Liquid Sulphur," published in 1918. But during the last ten years he gave up most of his spare time to study the physiological and physical

difficulties connected with the ascents of high mountains.

This subject he was particularly fitted to investigate, for he had probably climbed to heights above 20,000 ft. more often than anyone else. For instance, in 1910, in the Sikkim Himalaya, he was nine times above 20,000 ft., the highest altitudes being the first and only ascents of Pawhunri, 23,180 ft., and Chumiomo, 22,430 ft.

He also visited other parts of the Himalaya, the Nanga Parbat district, north of Kashmir, and Garwhal, where last summer he reached 23,600 ft. on Kamet. It was, however, in Sikkim that he did most of his mountaineering.

From time to time he published papers and reports in the *Journal of the Royal Geographical Society* and in the *Alpine Club Journal*. But as he was of a retiring disposition, there are few accounts of his extraordinary mountaineering record. Perhaps his most important paper was on "A Consideration of the Possibility of Ascending the Loftier Himalaya" (*Journal of the Royal Geographical Society*, 1917), in which he discussed all the factors conditioning acclimatisation to high altitudes, and the question whether it was possible to climb Mount Everest. His conclusion was: "A man in first-rate training, acclimatised to maximum altitude, could make the ascent of Mount Everest, without adventitious aids (*i.e.* oxygen), provided that the physical difficulties above 25,000 ft. are not prohibitive."

Dr. Kellas had a unique knowledge of the Sikkim Himalaya, and his death has deprived the Mount Everest expedition of one of its most valuable members, for he had studied the geography of the country round Mount Everest more deeply than anyone else.

WE regret to report the death, on June 26, of Mr. WILLIAM SHACKLETON, at the age of fifty. Mr. Shackleton received his early training at the Keighley Institute, and after completing a three years' course at the Royal College of Science,

became an assistant to the late Sir Norman Lockyer. By his skill and enthusiasm he contributed largely to the success of the early work at South Kensington on the photography of stellar spectra. In 1893, in company with Mr. Albert Taylor, he observed the total eclipse of the sun in Brazil, and was one of the first to obtain photographs with a prismatic camera of adequate power. In 1896, with Dr. E. J. Stone, he took part in the expedition which was conveyed to Novaya Zemlya by Sir George Baden-Powell in his yacht *Otaria*. Favoured by a brief interruption in a snowstorm, he then achieved a notable success in photographing for the first time the complete "flash" spectrum, with perfect definition, notwithstanding that an accident to the yacht had left but little time for preparation. On this occasion some admirable photographs of the corona were also obtained under his supervision. This expedition was further memorable for a meeting with Nansen at Hammerfest on his return from the polar regions.

For some years Mr. Shackleton was occupied with the late Dr. Common in the design of range-finders and other optical instruments, and a special interest in optics was added to that in astronomy during the remainder of his life. In 1905 he took up an appointment at the India Stores Depôt as Inspector of Scientific Supplies, and scientific workers in India have profited much from his extensive technical knowledge and careful supervision of their requirements. Mr. Shackleton was elected a fellow of the Royal Astronomical Society in 1893, and of the Optical Society in 1913. He was secretary of the Optical Society from 1916 to 1920, and rendered valuable services to the society in that capacity, besides contributing papers of practical importance; he was a vice-president of the society at the time of his death. Mr. Shackleton's health had not been good for several years, but his death came unexpectedly, and will cause deep regret to his many friends in scientific and technical circles.

Notes.

A CHEMICAL laboratory of a new type was opened at the Imperial College of Science and Technology by Mr. A. J. Balfour on June 24. The laboratory is fitted with apparatus of a size which will render it necessary for chemical processes to be carried out under conditions closely resembling those which are present on the large scale. Just as the ordinary scientific laboratory contains specimens of all types of apparatus necessary for small-scale work, the new laboratory contains appliances which will enable the student to carry through the corresponding large-scale operations in a manner which will render it possible for him to study the influence of those factors, such as heat exchange, etc., which are not of vital importance in ordinary laboratory work. Students, and especially research students, whether they intend to follow an academic or an industrial career, will thus obtain a knowledge

of large-scale conditions which it has hitherto been possible to acquire only by actual works experience. Moreover, the means for preparing initial material in large quantities will be of the greatest value for the research workers in the chemistry department of the college. It is hoped that a full description of the new laboratory, with illustrations, will appear in a forthcoming number. The equipment was provided by Mr. W. G. Whiffen, an old student of the college.

WE learn from the *Times* of June 24 that the West London Hospital is in possession of electrical plant capable of delivering current at 200,000 volts for X-ray purposes. The X-rays are of a penetrating character, and are being used for the treatment of patients suffering from malignant disease, on the lines laid down by the Bavarian doctors Seitz and Wintz. The

use of more and more penetrating X-rays in medical work has been a gradual growth, and, quite apart from any marked differential action which the short wave-length radiation may have on cancer cells as compared with the longer wave-lengths, the employment of the more penetrating rays has technical advantages when dealing with deep-seated tumours. One sees in their use a natural development which depends very largely upon the electro-technician. It is greatly to be deplored that statements as to how this development may improve the results of cancer treatment are based, not upon facts, but upon the hopes of those engaged in this work. The use of X-rays and of radium in the treatment of cancer has been justified by results, and these results continue to improve, but we think that the public may be expecting more than is warranted when it is told that "a conservative estimate of the possibilities of the new treatment is to put the number of cures in the future at double that ever known in the past."

On June 27 the president of the Royal Society of Arts, the Duke of Connaught, presented the Albert medal of the society to Dr. J. A. Fleming "in recognition of his many valuable contributions to electrical science and its applications, and specially of his original invention of the thermionic valve, now so largely employed in wireless telegraphy and for other purposes." It may be of interest to recall the important part that Dr. Fleming played in the development of the thermionic valve and its applications to wireless telegraphy and telephony. The first form of valve was made in 1904, and led to revolutionary developments in that and other branches of electro-technics. It is perhaps less generally realised that he gave scientific assistance in the early developments of "wireless" so far back as 1899, and directed some of the constructional work in connection with the first long-distance station at Poldhu. Dr. Fleming was also actively connected with the early progress of electric lighting in this country. In 1882, and for twelve years after, he held an advisory position with the Edison Electric Light Co., of London, and later with the Edison and Swan Co. He carried out the installation on board one of the first ships of the Royal Navy to adopt the new illuminant when it was introduced in 1882, and during succeeding years assisted several of the London companies and provincial corporations in electric lighting matters. Still older is his connection with telephony, for so far back as 1879 he was scientific adviser to the Edison Telephone Co., formed to begin telephone-exchange working in London. Other scientific work which Dr. Fleming has accomplished includes an important research into the electric and magnetic properties of matter at very low temperatures carried out in conjunction with Sir James Dewar.

On June 22 a portrait of Sir Napier Shaw, painted by W. W. Russell, was presented to him by the staff of the Meteorological Office, South Kensington, for preservation in the office. A copy of the portrait was presented to Lady Shaw.

An International Hydrographic Bureau has been established at Monaco, with the following directors:

NO. 2696, VOL. 107]

Vice-Admiral Sir John Parry (Great Britain), Capt. Phaff (Netherlands), and Capt. Muller (Norway). The secretary is Capt. Spicer-Simson (Great Britain).

It is announced in the *British Medical Journal* for June 25 that the International Labour Office has decided to appoint a committee of experts to deal with the question of industrial hygiene. Accordingly letters have been dispatched to the Governments of Great Britain, France, Belgium, Germany, Holland, Italy, Spain, Sweden, Switzerland, and Japan, inviting each of them to nominate one of its health inspectors or factory inspectors as a member of the advisory committee. The committee will meet from time to time, preferably on the occasion of the International Labour Conference, and its members will keep in touch with the International Labour Office and its industrial hygiene section by correspondence.

THE twelfth annual meeting of the Oxford Ophthalmological Congress will be held on July 7-9, when the following communications will be made:— Discussion on "The Causes of Infection after Extraction of Senile Cataract," Dr. V. Morax and others; "Stereoskopometry," R. J. E. Hanson; Petrosal sinus sepsis, A. Greene; The Doyne memorial lecture on "Heterophoria," E. E. Maddox; An instrument which is set in motion by the eye, *i.e.* by vision, or by proximity of the human body, *e.g.* the hands, Dr. C. Russ; Experiences of 606 and its substitutes in eye diseases, J. Hern; The trench operation for chronic glaucoma, with account of cases, N. C. Ridley; A plea for early diagnosis and operation in chronic glaucoma, with some remarks upon the treatment of acute glaucoma, Dr. T. H. Butler; A modified operation for chronic glaucoma, P. H. Adams; Some points in the performance of the Lagrange operation for chronic glaucoma, B. Cridland; Loss of vitreous during cataract extraction, Dr. T. H. Butler; Sight-testing with coloured test types, P. J. Hay; Some points of interest in the work of a school oculist, Dr. H. McIlroy.

An exhibition, free of charge, of Egyptian antiquities from Tell-el-Amarna will be held in the rooms of the Society of Antiquaries on July 5-13, from 10 a.m. to 5 p.m. A lecture on "The Season's Work at Tell-el-Amarna" will be delivered by Prof. T. E. Peet on July 7, at 8.30, in the Royal Society's rooms.

THE seventy-third annual meeting of the Somersetshire Archaeological and Natural History Society will be held at Crewkerne on July 19-21, under the presidency of Sir C. Hercules Read, who will deliver his presidential address, "Somerset Archæology—a Suggestion," at 11.20 a.m. on the opening day.

THE first exhibition of prehistoric art, organised by the Society of Friends of Art under the superintendence of the well-known archæologist, Don Elias Tormo, is now being held at Madrid. The object of the exhibition is to display reproductions of the remarkable series of rock paintings from the Spanish caves, the first discovery being that of the Altamira cave-paintings by the small daughter of the archæologist Sautuola in 1879. Since that date discoveries,

encouraged by the Prince of Monaco and others, have been made in great numbers. The present exhibition includes what are supposed to be examples of early Iberian script, figures of suns, fishes, horseshoes, women weaving short skirts, drawings of the chase, tiny and most artistic stags from the eastern regions of the Peninsula, and splendid life-size wild boars and bisons from Altamira in the north-west. These figures, in drawing and colouring, are splendid examples of prehistoric art.

BARON EDMOND DE ROTHSCHILD has intimated to the Paris Academy of Sciences his intention to place at the disposal of the Academy the sum of 10,000,000 francs for the purpose of creating a fund for the development of physico-chemical research in France. According to the *Morning Post*, the revenue from the capital sum will be used first for assisting young students who devote themselves to pure science; secondly, to furnish investigators with the means to carry out their work; thirdly, to help inventors who have made discoveries as a result of being assisted by the new foundation to take out patents protecting their discoveries; and, fourthly, to create later on, if it should be deemed necessary, an institute with laboratories to be named after the founder.

At the annual general meeting of the Röntgen Society, held on June 16, the following officers and council were elected:—*President*: Prof. J. W. Nicholson. *Vice-Presidents*: Dr. G. H. Rodman, Sir Ernest Rutherford, and Sir William Bragg. *Hon. Treasurer*: Mr. G. Pearce. *Hon. Secretaries*: Dr. E. A. Owen and Dr. J. R. Reynolds. *Hon. Editor*: Dr. G. W. C. Kaye. *Council*: C. Andrews, Dr. H. Black, A. E. Dean, Major Kenelm Edgcumbe, N. S. Finzi, Dr. F. L. Hopwood, Dr. F. H. Johnson, Dr. R. Morton, C. E. S. Phillips, Prof. A. W. Porter, Prof. A. O. Rankine, and Sir Archibald D. Reid.

THE seventy-fourth annual meeting of the Palæontographical Society was held in the rooms of the Geological Society, Burlington House, on Friday, June 17, Mr. E. T. Newton, vice-president, in the chair. The report referred to the completion of Dr. Reed's monograph of Bellerophontacea, and the early publication of a new monograph of carboniferous insects by Mr. Herbert Bolton. It also announced further instalments of the monographs of Pliocene Mollusca, Palæozoic Asterozoa, and Pleistocene Mammalia (Hippopotamus). The size of the annual volume had unfortunately to be reduced owing to the higher cost of production and to the difficulty of increasing the membership of the society. Dr. J. S. Flett, Mrs. Longstaff, Mr. A. W. Oke, and Dr. C. T. Trechmann were elected new members of council. Dr. Henry Woodward was re-elected president, Prof. E. J. Garwood was elected new vice-president, and Mr. Robert S. Herries and Dr. A. Smith Woodward were re-elected treasurer and secretary respectively.

THE council of the Society of Chemical Industry has nominated Prof. R. F. Ruttan, of Montreal, as president for the session 1921-22. The council, in view of the fact that the current annual meeting will be held

in Montreal, requested the Canadian sections to suggest one of their members for nomination for the office of president, and Prof. Ruttan's name was proposed.

EARLY last year, as announced in NATURE, the Medical Research Council, by the courtesy of the Governing Body of the Lister Institute, made arrangements to maintain a national collection of type cultures at the institute. The scheme is under the general direction of Prof. J. C. G. Ledingham, with Dr. R. St. John Brooks and Miss M. Rhodes as curator and assistant curator respectively. It now appears that mycologists feel the need of a similar collection. Since the formation of such a collection is not at present contemplated by any institution it is considered that the scope of the national collection should be extended. The British Mycological Society has appointed a fully representative standing committee to consider the ways in which the collection can be made most valuable, and to advise and assist in all questions appertaining to fungi. It is proposed to collect and maintain cultures of fungi of importance in phytopathology, medicine, veterinary science, technology and soil biology, types useful for teaching purposes, and any rare or interesting species. At present it is not possible to cope with the innumerable strains of common fungi, and room can be found only for those forms with some published distinguishing name or symbol. The co-operation of bacteriologists and mycologists is earnestly invited, and in return every effort will be made to supply the needs of applicants for cultures. All communications respecting the collection should be addressed to the Curator, National Collection of Type Cultures, Lister Institute, Chelsea Gardens, S.W.1.

THERE was an interesting demonstration of new wireless telegraph apparatus by the R. M. Radio Co. on Thursday last. This company has developed and shown in operation a Morse printing wireless receiver, which, in addition to the ordinary detector and amplifier valves, is provided with another valve, to rectify the currents that would normally go into the receiving telephone circuit, so that a relay can be made to work. The relay is of a sensitive Post Office pattern, and is actuated by upsetting the balance of a Wheatstone bridge arrangement, in one arm of which the valve is connected. The relay controls an ordinary Morse inker, so that a permanent record of the messages is produced. This apparatus is due to Mr. F. H. Haynes, of the R. M. Radio Co., and Mr. V. Ramage, of the Central News, Ltd., and can easily take down messages from Paris, Moscow, etc., as well as from ship installations up to a considerable distance. Capt. H. de A. Donnisthorpe also showed a new form of thermionic valve known as the R.M.R. triode. In this, improved efficiency is obtained by the use of a hemispherical anode which avoids the fringing effect produced by the more usual cylindrical electrodes, and thus utilises the electron stream more completely. In a further development of this apparatus a "soft" tube of this kind is surrounded by a current-carrying coil, which produces a magnetic field having the effect of concentrating

the ions where they are wanted, so that an increased flow of electrons is produced, giving a steeper characteristic curve and improving the sensibility by something like a further 50 per cent. The increased anode current when the field was applied was seen by means of an ammeter, and in another experiment the effect of a powerful electromagnet in controlling the position of the glow in a softer tube was demonstrated. It was pointed out that this action is similar to that taking place in the aurora borealis, according to the theory that in the layers of reduced pressure of the upper atmosphere the earth's field concentrates the ions and thus locates the glow produced by the bombardment of electrons shot off from sun-spots. This apparatus, which Capt. Donnisthorpe calls the "Thermagnion," can also be used to produce continuous oscillations with an equal gain in efficiency.

THE tercentenary of the death of Thomas Harriot, the mathematician and astronomer, occurs on July 2. Not only was he the most celebrated English algebraist of his time, but he was also one of the first astronomers in England to use a telescope, and, like Galileo, Fabricius, and Scheiner, was one of the early observers of the spots on the sun. Born at Oxford in 1560, he was a year older than Henry Briggs. He graduated from St. Mary's Hall, and became an ardent student of mathematics forty years before the inauguration of the first university chair of mathematics. At the age of twenty-five he entered the service of Sir Walter Raleigh, by whom he was employed in the survey of the newly founded colony of Virginia. The greater part of Harriot's life, however, was passed in the neighbourhood of London, where he came under the patronage of Henry Percy, Earl of Northumberland, who gave him a pension and assigned him rooms at Sion House, which stands on the banks of the Thames opposite Kew. When the earl was confined to the Tower through the complicity of some of his family in the Gunpowder Plot, Harriot and two other mathematical worthies, Thomas Hughes and Walter Warner, often bore him company. They were known as "the three magi." Harriot appears to have passed an uneventful life, and at his death was buried in St. Christopher's Church, on the site of which now stands the Bank of England. A monument erected to his memory was destroyed in the Great Fire of 1666. As an algebraist Harriot is a connecting link between Vieta and Descartes. His "*Artis Analyticae Praxis*" was not published until ten years after his death. The revival of his fame as an astronomer was due to von Zach, who, while on a visit to the Earl of Egremont in 1784, discovered some of Harriot's writings beneath a pile of old stable accounts at Petworth Castle; while the reduction of Harriot's observations of the comet of 1607 formed one of the first tasks of Bessel's astronomical career. Some of Harriot's manuscripts are in the British Museum.

At the annual meeting of the British Pharmaceutical Conference at Scarborough on June 14, Mr. E. Saviile Peck, in his presidential address on "British Pharmacy and its Possibilities," said he looked forward to the time when pharmacy in this country shall have

established itself as a separate professional entity. It could not be raised to this status without the combined efforts of its members, and would have to move forward with the advance of general education and of applied science. In his opinion every student before registration should be required to pass one of the school leaving certificate examinations which the Board of Education has recognised as equivalent to matriculation. While not advocating any serious extension of the syllabus for the qualifying examination, Mr. Peck favoured the addition of commercial science. In the major examination, which should be renamed the fellowship examination, practical physiological chemistry and bacteriology (with clinical microscopy) should be included among the compulsory subjects, and steps should be taken to establish a degree in science with pharmaceuticals as one of the subjects in the final examination. If pharmacy is to take its position with other professional bodies it must bring its final qualification up to university standard. He looked forward to the ultimate evolution of a real profession of pharmacy.

MRS. SCORESBY ROUTLEDGE has made another important contribution to our knowledge of the ethnology of Easter Island in her account of a series of carved rocks and stone houses, published in the *Journal of the Royal Anthropological Institute* (vol. 1., part ii.). The houses built of slabs of stone procured from an adjoining quarry are remarkable. The soil is excavated on a sloping site; the foundations are made of large rough cubes of rock, on which slabs are laid on edge, and the roof is formed of similar slabs. The house is entered by a rectangular tunnel. A series of excellent photographs enables us to understand the methods of construction, and the accommodation provided for the occupants.

IN *Ancient Egypt*, 1921, part ii., Prof. Flinders Petrie explains that the work of the British School has been moving southward, in the course of a systematic clearing of the western bank of the Nile valley. The excavation of the cemetery of Herakleopolis, which had been wrecked in ancient times, provided some important results. In particular, a number of well-dated skeletons gave an opportunity to compare them with those of other sites on either side—Medum, Tarkhan, and Deshashe. This showed important differences between the types of the Second, Sixth, and Ninth Dynasties, but the question whether the interments were those of nobles or of plebeians may to some extent confuse the results.

In the April issue of the *Entomologist's Monthly Magazine* Dr. R. C. L. Perkins writes on the variation exhibited by the British species of parasitic bumble-bees of the genus *Psithyrus*. It is evident from the many colour forms which are recorded in this article that variation in these bees has been very inadequately studied. The subject is an interesting one, and species of *Psithyrus* need to be much more extensively collected before we shall be able to learn the distribution of their varietal forms. Dr. Perkins also refers to the very rare bumble-bee *Bombus pomorum*, Panz. A few examples of this insect were

captured by the late F. Smith in Devon in 1857, but since that time the species has been lost sight of in this country. Owing to the resemblance which the male bears to a variety of the same sex in *Psithyrus rupestris*, F., and the similarity of the female to more common Bombi, Dr. Perkins is of opinion that *Bombus pomorum* may have been overlooked, and possibly may be re-discovered by some enterprising entomologist.

PAMPHLET No. 12 (1921) of the Economic Series issued by the British Museum (Natural History) is written by Mr. F. Laing, and deals with the ubiquitous cockroach. In addition to the common species (*Blatta orientalis*, L.), three other kinds of cockroach have established themselves in sufficient numbers in this country to be occasionally troublesome. The general reader is far more interested in their control than in their biology, and Mr. Laing finds that a powder consisting of three parts of sodium fluoride to one part of pyrethrum is a successful remedy. The mixture should be scattered about the haunts of the cockroaches in the evening, and the dead ones removed the next morning. The powder is harmless to any domestic pets and is cheaply and easily prepared.

THE inhabitants of Buckinghamshire and Hertfordshire will be grateful to Mr. W. Whitaker for his memoir on the water-supply of the two counties, recently published by the Geological Survey. In both counties chalk is the principal water-bearing rock, but supplies are also obtained from overlying gravels, sands, etc., Tertiary beds, and the Greensand and Jurassic rocks. The deepest bores recorded are 1000 ft., and from some of the wells more than 1,000,000 gallons a day are being obtained. Numerous analyses of the water are given, and the details are of considerable interest to all concerned in the well-being of the community. The geological student will be particularly interested in the full description of the swallow holes in which surface-water disappears, and which are numerous in Herts. Probably the best known are those in North Myms, which can easily be seen at Water End; here the drainage of some 20 square miles of the county is lost. Swallow holes are found in two sets of conditions: along the junction of the Tertiary beds and chalk, and in the chalk itself, where the saturation level is below the bottom of the valley. The former are active at all seasons, the latter may not be. Directions are given for finding good examples. There is also an interesting discussion on the effect of pumping on the adjacent wells.

A PAPER by Mr. S. H. Warren on "A Natural 'Eolith' Factory beneath the Thanet Sand" (Quart. Journ. Geol. Soc., London, vol. lxxvi., p. 238, 1921), has already raised considerable discussion. It is clear that many persons would have accepted Mr. Warren's naturally flaked specimens as eoliths had their early Eocene age and their mode of origin not been demonstrable. The specialists in eoliths, on the other hand, maintain that the natural product, due to interaction under earth-tremors, is inartistic compared with an eolith for which human origin can reasonably be

claimed. Mr. Warren's "natural factory" occurs at Grays in Essex.

IN a short paper of four pages, reprinted from the Proceedings of the U.S. National Academy of Sciences for June, 1920, Prof. A. G. Webster, of Clark University, directs attention to a necessary connection between the equation of state of a gas and the specific heats of the gas at constant pressure and at constant volume which does not take the simple form given to it by some authorities. In particular, he shows that a characteristic equation of the form $T = pf(v)$ does not indicate that the two specific heats are independent of the pressure; on the contrary, neither of them is a constant or independent of the pressure, nor is their difference constant, although it is independent of the pressure. Such a gas has no cohesion pressure, although it may have a finite Joule-Kelvin effect. In the same way a gas having a characteristic equation of the form $T = vF(p)$, although it has a zero Joule-Kelvin effect, has specific heats which are neither constant nor independent of the pressure. In conclusion, Prof. Webster expresses the opinion that the present method of teaching thermodynamics by means of the equations of the ideal gas or of the van der Waals equation "is by no means conducive to clearness."

WE have received from the Decimal Association a pamphlet entitled "The High-Value Penny," in which a proposal is put forward to increase the token value of the penny and employ the existing penny, half-penny, and farthing coins to represent values 20 per cent. higher than at present, thus dividing the shilling into ten pence instead of twelve, while leaving the values of the shilling and the £ sterling unaffected. All the existing notes and silver coins would be retained at their present values, and the sixpenny and threepenny coins employed as half-shilling and quarter-shilling pieces exchangeable into 5 and 2½ high-value pence instead of 6 and 3 low-value pence respectively. At convenience the unpopular silver three-penny piece could be withdrawn from circulation and a more useful nickel twopenny piece issued. It is claimed that by the adoption of this proposal the purchasing power of the penny would be brought into closer harmony with modern needs. Owing to the absence of a coin intermediate in value between 1d. and 1½d., the price of articles sold at 1d. before the war has been increased earlier than necessary to 1½d., and will be retained longer than necessary at this figure when prices are falling. The chief defects of the recent decimal coinage proposals would be avoided by continuing to reckon in pence instead of in mils, and no new coins or knowledge of decimal arithmetic would be required.

IN the *Meteorological Magazine* for May Dr. C. Chree gives a brief account of "Recent Work on Aurora." The subject was suggested to him by the installation of an observatory in Shetland, one of its objects being auroral observations. Due acknowledgment is made of the work done by Norwegian physicists. Arcs and curtains are said to be the most frequent forms of aurora portrayed, and many, if

not all, are built up of rays. Illustrations are given both from drawings and from a photograph, the preference being given somewhat to the former method, although reference is made to the method devised by Prof. Störmer of measuring auroral heights by taking photographs simultaneously from the two ends of a base, the inclusion of stars determining the position of the aurora in space. Reference is made to the exceptional occurrence of aurora in England, whilst it is said that in high latitudes aurora seems to be the rule, rather than the exception, when the sky is free from cloud and the absence of strong moonlight permits. It is suggested that the spectrum of aurora at different heights may add to our knowledge of the composition of the atmosphere and throw light on the electrical conditions of the air, whilst relations to wireless phenomena are also foreshadowed. The occurrence of aurora, associated with the sun-spots in May, although apparently of little importance in

England, may in more northern latitudes afford useful information.

WE understand that part 1 of vol. iv. of "Annual Tables of Constants and Numerical Data: Chemical, Physical, and Technological," is now ready. The work since 1910 has been published under the patronage of the International Union of Pure and Applied Chemistry. Copies are obtainable from M. Ch. Marie, 9 rue de Bagneux, Paris 6^e.

MR. W. H. ROBINSON, 4 Nelson Street, Newcastle-upon-Tyne, has just circulated a lengthy catalogue (No. 3, 1921) of upwards of 1000 second-hand books. The contents are of a varied character, but many items should be of interest to readers of NATURE, e.g. a number of books illustrated by Thomas and John Bewick, folk-lore publications, and those in the large section devoted to science and technology. The prices asked appear very moderate.

Our Astronomical Column.

OCCULTATION OF VENUS.—A daylight occultation of Venus will take place on Saturday morning, July 2 (civil reckoning). The planet's stellar magnitude will be -3.9 , and it should be plainly visible to the naked eye, especially with the lunar crescent as a guide. The following table is extracted from the B.A.A. Journ. for May, p. 302:—

Place	Summer time of		Angle from N Pt.	Altitude
	Disap. h. m.	Reap. h. m.		
Greenwich ...	5 3.4	6 9.5	67 262	23 33
Edinburgh ...	5 11.8	6 14.2	58 273	22 31
Liverpool ...	5 6.6	6 10.4	62 268	22 31
Dublin ...	5 6.3	6 8.2	59 271	20 29

The times are for the centre of Venus; they should be diminished by about 0.5m., owing to the error of the moon's place. Venus will be just half-illuminated. The occultation (disappearance and reappearance) of the illuminated limb will take place about 28s. later than the centre. Accurately timed observations of the different phases will be of use for correcting the places of moon and planet.

Circular No. 10 of the Cracow Observatory gives full details of the circumstances for about 400 stations spread over Europe. These circulars are written in Prof. G. Peano's "Latino sine flexione," which is easily read by anyone with an elementary knowledge of Latin or the derived languages.

THE TOTAL AMOUNT OF STARLIGHT.—Prof. Newcomb pointed out the importance of ascertaining the total amount of light given to us by all the stars, including those that are altogether invisible as units in the largest telescopes. It is only in this manner that limits can be fixed to the amount of light given by the fainter and more distant stars. Prof. Newcomb himself made observations for this purpose (*Astrophys. Journ.*, vol. xiv.); he was followed by Mr. G. J. Burns (*Astrophys. Journ.*, vol. xvi.), Mr. L. Yntema (Groningen Publications, No. 22), and Dr. P. J. Van Rhijn. The last-named has now made a new and more complete research (Groningen Publications, No. 31), utilising the experience previously gained, and analysing the total skylight into its components. An artificial star of magnitude about 5 was used, formed by reflection from a bulb; its light was compared with that of standard stars, and then spread out by

changing the focus until it became equal to the skylight. The observations were made at Mount Wilson; the nearest towns were distant 13 km. and 26 km., and the effect of their lights was found to be inappreciable above altitude 35° . Use was made of the star counts in different galactic latitudes to estimate the increase of starlight as the galaxy is approached. The final result is that the total starlight is equal to 1440 first magnitude stars (Yntema found 1350), and that the skylight is made up as follows:—Starlight, 17 per cent.; zodiacal light, 43 per cent. (this varies at different hours of the night); perpetual aurora, 15 per cent. (it is noted that Prof. Slipher found the green auroral line on all photographs of the sky spectrum); the preceding sources scattered by the atmosphere, 25 per cent. The starlight has been reduced to the zenith by the application of Abbot's coefficients of atmospheric absorption. The starlight per square degree in various galactic latitudes is:—Lat. 0° , 0.085; lat. 10° , 0.065; lat. 20° , 0.044; lat. 30° , 0.026; lat. 40° , 0.015; lat. 50° , 0.014; lat. 60° , 0.012; lat. 70° , 0.011; lat. 80° , 0.010; and lat. 90° , 0.010 (the unit is mag. 1.0).

PERIODICITY OF VARIABLE STARS.—In order to facilitate further research on the cause of the periodicity of variable stars, Dr. J. G. Hagen has collected together in the May number of *Scientia* the salient differences between the stars of period less than three months and those of greater period. The short-period stars change less than 1.5 magnitude, while those of long period change three or four magnitudes. For the former the minima are sharp, followed by a rapid recovery, while for the latter the minima are flattened and the recovery relatively slower. The long periods oscillate, while the short change in the same direction with time. The former collect about 300 days, the latter about half a day and five days. The long-period stars are generally orange-red in colour and are spread evenly over the sky, while the short-period stars are whitish-yellow and collect in the Milky Way.

Dr. Hagen looks forward to the appearance of the results of the Mount Wilson measurements with the new 100-in. telescope, and hopes that it will then be possible to test whether the phenomena can all be explained by the theory that the variable stars are binaries.

Royal Sanitary Institute: Folkestone Congress, June 20-25.

THE Royal Sanitary Institute was founded in 1876. For more than forty years it has been, as it were, a chorus to interpret to the official and general public the methods of applying scientific ideas to the improvement of the environment and to the promotion of individual health. Among its earliest congress presidents it included Edwin Chadwick, Ward Richardson, Douglas Galton, and others well known in the history of the modern public health movement. The annual congress has always been a convenient occasion either for the announcement of some fresh application of hygienic ideas or for the discussion of administrative difficulties in their realisation. This year the congress was held at Folkestone. The Earl of Radnor was president. In his address he pleaded for the retention of the voluntary hospital system, arguing that unpaid medical service is somehow superior to paid service. There is, perhaps, a sense in which the consultants of the great and small hospitals are unpaid, but it is an abuse of words to suggest that they are philanthropists. The hospital problem, however, is rapidly coming to a point when discussion will yield to action, and with their usual elastic adaptivity our institutions will emerge into something better. The "science" of the transition will not be traceable until after the event. His lordship's plea was put with lucidity and dignity—a typically good illustration of a voluntary administrator's attitude. The later discussion on hospital service and medical service generally took a much wider sweep, and made manifest how far we have already travelled along the lines of official medical organisation. But this is a practical rather than a scientific question, and may safely be left to the administrators.

Not so the question of smoke prevention. Doubtless it is a practical question, and is probably as old as the oldest British health congress. It is one of the by-products of the industrial revolution. From the merely commercial point of view the waste has been incredible, whether we think of the factories or of the home fires; but not until the last twenty or thirty years have the evil effects of smoke-spoiled light and air begun to be understood or studied scientifically. More than twenty years ago, at Glasgow, Sir William Ramsay in a popular lecture put forward the suggestion that the fog-clouds due to smoke absorbed the sun's violet and ultra-violet rays, and, therefore, prevented those rays from having their proper germicidal effect on the bacterial life of the streets; hence the increase of microbic epidemics. The remedy, he said, was to use gas-fires. Sir William Ramsay at a later stage bettered this when he suggested the production of energy from coal without bringing it to the surface. These suggestions deserve exploiting. But Prof. Leonard Hill, of the Medical Research Council's Department, put the whole problem in a new setting. This is what we should expect from a man whose experimental work has given a richer meaning to the term "ventilation," and shown that our cardinal practical concern should be with the cooling-rate of the body in relation to the air. On the present occasion he explained the peculiar effects of light, particularly the visible rays. "Men live long who work in the clean moving air and sunshine of the fields. While the expectation of life for females (1911-12) in Westmorland was 66.6 and in the rural districts of Norfolk and Suffolk 61.03, it was in the county boroughs of the North 49.93, in Middlesbrough 46.65." It need not be assumed that the whole responsibility for this rests on smoke, but the cumulative case against it is very

strong. On the other hand, the positive value of light in its effects on metabolism is extraordinarily high. This is accepted in therapeutics. "The visible (luminous) rays of sunlight are of immense importance, because they penetrate the skin and locally warm up the blood, which absorbs them in the subcutaneous vessels, while the body as a whole is kept cool by the cool moving air." (This refers to the sun-treatment of tubercular bones and joints in Alpine sanatoria.) "On the other hand, the dark heat rays are absorbed by the surface of the skin and make this warm. The ultra-violet rays have also no power to penetrate. They are absorbed by as little as one-tenth of a millimetre of the outer horny layer of the skin." It is, then, the luminous, not the ultra-violet, rays that have "so powerful an effect on health." The inference from this double fact is obvious. "Sunlight warming the blood locally, cold moving air keeping the body cool and stimulating metabolism, open-air exercise—these are the great factors for health next to good food and sufficient sleep, and of these the people of the cities are largely deprived." There are many practical deductions, but it will take the medical schools and the administrative authorities a long time to exhaust the value of this piece of science revealed by research.

In supplement to Prof. Hill's paper, Dr. Owens, of the Committee on Atmospheric Pollution, gave actual figures as to the tons of matter per square mile deposited from the air. The broad facts are (a) that industrial smoke is a small fraction of the whole and can be completely controlled by existing methods, and (b) that domestic smoke accounts for a vastly greater quantity, and at present cannot be controlled. That is the smoke problem.

There were many other practical discussions, each involving a good deal of nascent science. For example, the discussion of infant feeding is, in spite of the innumerable army of skilled observers, still losing itself among unresolved factors. Dr. Vynne Borland showed that in certain cases the overfeeding of infants results in wasting. This conclusion was based on carefully analysed cases. Dr. Jervis gave other cases to show that in certain forms of malnutrition no variation of food has any effect, and that here we are face to face with unknown factors, such as deficiency or excess of secretion in the endocrinal glands. It seems clear that until the relatively rough work of clinical treatment can be better illuminated by the work of the laboratories we shall have to continue our practice empirically.

Science is taking a steady grip of industrial fatigue. Mr. Wilson, of the Industrial Fatigue Research Board, gave a summary of results under the title "Some Effects of Environment on Efficiency and Safety." Temperature, humidity, ventilation, and lighting, all have definite relations to output, but the precise effects are not easy to estimate. Heavy work in high temperatures produces more in winter than in summer. Good ventilation is found to neutralise the reducing effects of humidity. In silk weaving artificial light reduces production by 10 per cent. compared with daylight. There is an obvious case for continuing research into these "raw materials" of industry, if only to secure some scientific basis for a system of "welfare work."

The science of rat destruction was represented at the congress. Research has not got much beyond the "aniseed" of the older rat-catchers and certain familiar poisons. Mr. Claremont, of the Ministry of Agriculture, gave a careful summary of facts. The rat, it appears, is "peculiarly susceptible [to

poisons], for it has a very delicate stomach, and, I believe, cannot vomit; at any rate, does not readily do so." There is room for an extended biological and psychological study of the rat, for it does seriously affect the commerce of the world both directly as a consumer and indirectly as the international carrier of plague.

Perhaps the most fascinating item of the congress programme was the popular lecture by Prof. Mellanby, of Sheffield, on "Vitamins." A health congress without a discussion on diet would be a solecism, and to-day the whole theory of diet has been transfigured by the "vitamin" hypothesis. It is well to regard the word as provisional, for in this way the methods of research are likely to remain more fluid. No one has established a better right than Prof. Mellanby to be heard on the recent developments. He set forth the data with persuasive lucidity. He showed that experiment discredited the old view that diet could be exhaustively expressed in terms of proteins, carbohydrates, fats, salts, and water. There is a *sextum quid*. From Eyckman's discovery that beri-beri was due to rice robbed of certain portions by "polishing" to the latest experiments with puppies

to show the production and arrest of rickets, Prof. Mellanby made clear the reasons for assuming the existence of the three factors: Fat-soluble A, water-soluble B, and the anti-scorbutic factor. The work of Prof. Mellanby and his wife in this field is well known to the technical and official public, but there is much need to spread the ascertained facts among the wider public, for this is the only way to generate sufficient pressure to secure that the consumer shall have the benefit of the latest discoveries. The fact that hypotheses are disputed is no reason for not making them known. In this matter the facts even as now ascertained are of high practical value. The physiological and biochemical departments of the various schools ought to work in more intimate touch with the administrative public, especially with the clinical investigators.

Of the congress as a whole it can be said truly that the mayor and councillors did everything to show that they understood the importance of the institute's educational work, and as we parted in the clean air and light of a perfect summer day we assured each other that on the scientific, as well as on the social, side it had been "a very nice congress."

The Importance of Research in the Development of the Mineral Industries.¹

By SIR RICHARD REDMAYNE, K.C.B.

THE present state of the civilised world is, economically, paradoxical. The need for commodities is very great, yet the production of them is so costly that industry is languishing for lack of orders. On the termination of the war, after four years of excessive waste and destruction, the world is found short of houses, food, and other commodities; railways and rolling stock are in sad need of repair, restoration, and expansion; the output of fuel, the life-blood of our economic existence, is greatly decreased, and the mines from which it is produced are in a backward state of development.

The cessation of hostilities was succeeded almost at once by a period of feverish industrial activity—it would be erroneous to apply the words "general prosperity"—followed by a cycle of great depression. The demand for goods is great, but production is falling. What is the explanation? It lies, I think, in a combination of circumstances:—

(1) A feeling of insecurity due to unsettled political and financial conditions. Hence a disposition to conserve rather than to utilise in commercial ventures such capital as is available.

(2) The incidence of rate of exchange.

(3) The high cost of production consequent on the high cost of living and the higher standard of comfort demanded (and rightly demanded) by the labouring classes than formerly obtained.

(4) The lower, and still apparently decreasing, productive power of labour.

The first two conditions will in part right themselves in process of time as the various political problems are solved, or partly solved, and rates of exchange will then tend towards the normal; but a very great deal depends upon the last two conditions, as the future position of production is not easy to forecast. Higher and cheaper production is a difficult desideratum to obtain in view of the high rate of wages now ruling and the diminishment in working time either achieved or claimed by the manual workers of the day, and these are demands which are not likely to show much abatement in the future. What is the

solution? The answer I venture to give, the solution which I presume to propound, to this problem, is "research." To discover by research cheaper means of production, and by research to create new outlets.

The object, then, of my address to-day is to direct attention to the necessity for research work in the mineral industries. Let me make more clear what I have in mind by taking one special case in point, a most important case—that of coal. It is an axiom that a cheap and plentiful supply of suitable fuel is necessary for our prosperity as a manufacturing country. This situation will remain, and is bound to remain, until some other means of producing power cheaply is discovered.

I think it may be taken that, roughly speaking, the rate per cent. of return on the capital invested in coal-mining in Great Britain over the last hundred and fifty years has, on the average, not varied much—reckoning in, say, periods of ten years—yet the progress made during the last two or three generations in every respect, except in the rate of return on capital, has been enormous.

Thus such everyday features of a colliery working at the present time as shaft cages and guides, the safety lamp, the steam locomotive, the trade in coke and by-products, ventilating fans, wire ropes, mechanical haulage, mechanical screening, the use of compressed air, the application of electricity to signalling, lighting, and motive power, and the mechanical cutting of coal have all been introduced in the course of the last hundred and twenty years. There is scarcely an appliance (save the simplest tools) or a machine in use at a modern colliery which could have been made at the beginning of the nineteenth century; and during this period the wages of the workmen—I omit the war period and the present abnormal time from consideration—have been increased certainly between 200 and 300 per cent., and this though the price of coal did not greatly increase; as a matter of fact, between the years 1828-1900 the variation was small and the price was lower in the latter year than in the former.

It was *because* of the improvements introduced into coal-mining that it was possible to keep down the

¹ Address delivered at the annual meeting of the British Science Guild held at the Goldsmiths' Hall on June 8.

cost of production, allowing of an increasing trade being done and the maintenance of a fair return on the capital invested in the industry. Further improvements are, to my mind, the only satisfactory solution to our present economic difficulties. Let me repeat: Lessen the cost of production by applying new methods, the result of research, and by research discover extended and new uses for minerals. Let me briefly indicate examples of possible research work in the mineral industry.

Coal—mineral fuel—naturally occurs at once to the mind. I am one of those who believe that the cost of production can be reduced by the wider application of the most up-to-date methods of the "getting" of the coal, in the transport and usage of the coal, but I doubt very much, even if and when these methods are applied to the fullest extent practicable, whether it will be possible to reduce the price to quite the pre-war level.

In some of our largest industries coal, next to wages, is the highest item of cost. The way of research would, therefore, appear to lie along the lines of the more efficient use of coal.

We know in the smelting of Cleveland iron in Yorkshire under present methods that about 74 per cent. of the total available heat of the fuel used is usefully applied, which for economy of smelting large quantities of iron is a remarkable result to have achieved. But is it beyond the bounds of possibility to reduce the consumption of one ton of coke to produce one ton of iron? And, as was pointed out by the Coal Conservation Committee in their final report of 1918, the economy of fuel which would result from the combination in single units of coke-ovens, blast furnaces, steel furnaces, and rolling mills would be very great indeed. The idea was foreshadowed in Belgium and Germany in the early years of the present century, and in 1910 Mr. T. C. Hutchinson, in his presidential address to the Cleveland Institution of Engineers, expressed the view "that the time would shortly come when ironstone would be brought in at one end of the works and finished steel would be turned out at the other, only such coal being used as was required for the coke-ovens to make sufficient coke to smelt the ironstone." In 1913 Mr. Hutchinson repeated this belief at the Brussels meeting of the Iron and Steel Institute, and in 1912, in his presidential address to the Iron and Steel Institute, Mr. Arthur Cooper also expressed the belief that the time was close at hand when the iron and steel industries would be forced by the stress of competition to adopt this reform.

The economic utilisation of low-grade fuels is a matter of great moment. There are in the United Kingdom, as in all coal-producing countries, vast quantities of coal which it does not pay to work owing to the low price realisable thereon. Probably the use of so-called colloidal fuel offers a solution, and will render the use of these low-grade coals practicable and profitable; for very fine coal mixed in about equal quantities with fuel oil produces a fuel which can be burnt in the same way as oil, and, bulk for bulk, though not weight for weight, gives in thermal values results equivalent to those of the fuel oil alone.

The recovery of coal and its more perfect cleaning by the froth flotation process, for some years applied to the recovery of metalliferous ores from their associated gangue, presents features of interest and probably profitable results.

The low-temperature carbonisation of coal, too, is at present occupying the minds of many investigators and may lead to the more extensive use of low-grade fuels. But to be commercially successful such a process should be continuous, and the resultant fuel capable of being sold at a price below that of coal.

Oil Shale.—The stores of liquid mineral oil will not last for ever; indeed, it is probable that the next fifty years will see, if not the exhaustion of this source of oil, a great reduction in the supplies available. We must turn, therefore, towards distillation of oil-bearing mineral—oil shales and coal—to take the place of our present petroleum supplies. Although there are very few retorts erected in the United States for the treatment of oil shale, and such as are being applied to experimental purposes only, yet even that country of oil supplies is turning its attention to the consideration of its oil-shale potentialities. Research work would naturally be directed towards the economic desulphurisation of the oil and the minimising of losses in refining, so allowing of oil shales being worked which at present cannot be made available. The loss in refining oil from Scotch oil shale is about 23 per cent. of the crude oil treated, as compared with a loss of $3\frac{1}{2}$ -4 per cent. only in the case of straight-run refining of American petroleum. The process of refining is the process of getting rid of offensive substances, but in those cases where refinement results in such high losses, as in the case of shale oil, it is probable that other than the objectionable substances are lost—substances which might be retained with advantage in the finished product.

Iron.—I have already alluded to the cheaper reduction of iron ores. The available reserves of high-grade iron ores in Great Britain are vastly nearer exhaustion than are the coal supplies. More and more, too, the world will have to turn to the poorer grade of ore—a wide field is here offered for research work in devising economic methods for their reduction. The economic smelting of ferruginous sands, in which connection may be mentioned those of Sweden and New Zealand, has so far defeated the efforts of metallurgists, rich in iron though these sands are.

In connection with blast furnaces, two products, the possible recovery of which is worth investigation, are those contained in the dust in the gases, namely, iron and potash; these dusts contain a high percentage of iron.

The possible economic recovery of vanadium, a mineral much in request in respect of the manufacture of a certain class of steel, from ashes of carbonaceous substances has been mooted.

Minerals Used to Harden Steel.—In respect of several minerals which until of late years were unimportant, or comparatively so, an important use has been found in connection with steel. One of these is tungsten. Tungsten metal powder is, as all metallurgists know, required for the manufacture of high-speed tools. The position in respect of tungsten is one which is at present exercising the minds of those interested in its extraction from wolfram; the business is now practically unprofitable. During the war high-speed steel was in great demand; now the demand has fallen away. Cannot new uses be found for tungsten? I have heard that the metal can be used for making piano-strings. The application of tungsten to branches of industry other than to steel offers a fruitful field for research.

I incline to the belief that, given a cheap and abundant production of some of the minor metals, uses will be found for them; and, conversely, with the discovery of uses enhanced production will be forthcoming. A case in point is the recent development in the production of stainless cutlery, which is made of chromium steel, and is in process of providing an important outlet for supplies of chromium ore.

Probably 95 per cent. of the world's production of manganese ores is used directly or indirectly in the manufacture of iron and steel. Self-hardening steels, made before the development of "high-speed tool

steels," contained from $3\frac{1}{2}$ to 4 per cent. of manganese. Nickel steels containing from 5 to 6 per cent. of manganese and from 20 to 25 per cent. of nickel have been largely used for many years for electrical resistance wires. But the output has fallen away considerably. India is now our great source of supply of manganese. The output from that country was, however, for 1919 only about five-eighths of that for 1913, and the cost of production has greatly increased owing to the increased rate of wages demanded by the native labourers. The rupee exchange and high freights also hamper the export trade. The value of the ore for metallurgical purposes, as indeed in the case of the ores of nearly all metals, depends on three factors:—

(1) The percentage of the metal contents (the metals in the case of manganese being manganese and iron).

(2) The percentage of the impurities (which in the case of manganese are phosphorus, silica, alumina, copper, cobalt, lead, zinc, barium, etc.).

(3) The physical condition in which the material is delivered to the furnace.

There are fairly extensive deposits of low-grade and impure manganese ores which research might render available, if not for metallurgical, then for chemical uses.

The position of zinc is interesting. The British zinc industry is in a very depressed state, and to this matter the Imperial Mineral Resources Bureau has been devoting much anxious thought. The Bureau was fortunate in having the benefit of the views on this subject of Mr. Gilbert Rigg and other well-known experts. Mr. Rigg, in a paper which he contributed on the subject of the position of the zinc industry at the close of 1919, points to the successful application of the electrolytic reduction of zinc ores in the face of much scepticism as to its commercial possibilities, and concludes his paper with these words:—"What is going to be the position of England's spelter industry in the next five years? If we are going to compete successfully, having regard to the high cost of fuel and materials and high cost of labour and labour difficulties, we must start to put our house in order. Fuel and labour are going up in price all over the world. The relation of labour to the general scheme of production is changing, and generating more or less friction in the process, and the successful competitors will be those who have tackled the problem of spelter production most radically and with least regard to hampering tradition." Wise words these.

Another instance of the value to the mineral industry of scientific research of possible far-reaching results may be mentioned. Mr. Picard, in his admirable presidential address to the Institution of Mining and Metallurgy in 1919, covering a wide survey of recent metallurgical progress, said:—"In the province of general metallurgy the increasing use of the Cottrell process deserves special mention. As an example of painstaking research in developing a practical process from long known, but unused, scientific fact it has few equals. We have to go back to 1870, to the work of Tyndall, for the first disclosure of the phenomenon on which the process is based. This was further examined by Frankland, Lord Rayleigh, and Oliver Lodge; but for the useful application of the principles involved we had to wait for Dr. Cottrell. He first applied the method to depositing sulphuric acid produced in the contact process, and it is still being used for this purpose. It is satisfactory to report that the merits of the invention have been recognised in this country, the first plant to be erected here in 1917 being at one of the Government acid plants. It is also in use here for the precipitation of fumes from metallurgical works, following established practice in

America; its further application in this country seems certain. The advantages of the process are far-reaching; not only are valuable products recovered, but agriculture in the neighbourhood of the operations is saved from serious damage."

The Cottrell electrostatic recovery process of flue-dust and furnaces consists, as you are doubtless aware, in separating solid and liquid substances from gases in which they are held in suspension and electrically precipitating them.

There are many more fields of research on minerals which I should have liked to discuss had time permitted, such, for instance, as the extraction of aluminium from clays and from the felspar labradorite; the possible utilisation of magnesia cement for the protection of mine timber; the use of ferroboron in making remarkably strong and tough steels; the possibility of extracting on a commercial scale potash from orthoclase felspar; the cheapening of the production of thorium nitrate from monazite—large residues of cerium compounds are obtained as a by-product, formerly regarded as useless, but now used for supplying the cerium required in the manufacture of the alloy ferro-cerium used in sparking devices—and so on. But all minerals present a field for research, and time does not permit my passing these fields in review. The few instances I have given have been selected with the view of emphasising the point I started off with, namely, that scientific research is one of the factors, and an important one at that, necessary to the development of the mineral industries and to our commercial prosperity. Much more extensive research work is necessary if we are to take full advantage of our mineral resources (with which a bountiful Providence has provided us) by rendering available ores and products therefrom which cannot now be used, and extending the use of those already in commercial consumption and producing them more cheaply.

How should research be organised and carried out? Empirical investigations must be based upon a scientific foundation if they are to be of ultimate and practical value. It has, however, been well said that if an investigator does not possess the inventive faculty as well as the purely scientific, the value of the work is apt to be largely lost. The discovery of new facts or principles is one thing, and is a characteristic of the academic type of mind, whereas the discovery of new uses for such facts or principles is another thing, and is typical of the commercial mind.

In this work of research the universities are peculiarly fitted to take an important, a leading, part. The research should not necessarily be pursued along definite lines with a definite object in view; the great discoveries were not made in that way. The Department of Scientific and Industrial Research might well endow university scientific research on chemical, metallurgical, and engineering work, supervising and co-ordinating and publishing the results. Effort is largely commensurate to the prize offered, and the discoverer should be rewarded for his labour and genius; but that would be a matter easy of arrangement. A certain amount of overlapping in scientific work is not inadvisable, but the Department would see to it that there was not undue overlapping. I offer the suggestion for what it is worth. Research associations undoubtedly perform useful, even highly valuable, functions, but the wind of science bloweth where it listeth, and the time is ripe for a realisation of the fact that scientific research cannot profitably be hampered by restrictions confining the efforts of those who are employed therein. It is of the essence of research that it should be free and untrammelled.

The Imperial Mineral Resources Bureau is not a

Bureau for research, as research is ordinarily understood, but owing to the nature and extent of the machinery which it has at its disposal, including its corresponding members throughout the Dominions and Colonies, its technical advisory committees—active bodies comprising some 151 members, who are among the leading authorities on the respective minerals and the industries connected therewith—it is

in an exceptional position for disseminating suggestions, shaping problems to which they give rise, and carrying out the necessary preliminary surveys, without which it would be difficult to advise as to whether a problem should be brought before organisations such, for instance, as the Department of Scientific and Industrial Research, the province of which is the carrying out of research.

The Genetics of Sex.

By PROF. R. RUGGLES GATES.

THE investigation of the chromosomes in a large number of insects and other animals has shown that the so-called X- and Y-chromosomes furnish a mechanical basis for the determination of sex in the fertilised egg, its inheritance in later generations, and the usual occurrence of approximate equality of the two sexes when one of them is heterozygous (XY or XO). The fundamental character of this relation between the X- and Y-chromosomes and sex is now generally admitted. It would appear that the difference in the chromosome content of the nuclei in the two sexes affects the metabolism during development in such a way as to produce one sex or the other, and in some groups to affect the secondary sexual characters as well. Combined cytological and breeding investigations have shown further that in most insects and mammals, including man, the male is the heterozygous sex, while in the Lepidoptera and birds the female is heterozygous.

Recent work on the subject of sex in animals accepts this situation, and is building upon it a further analysis of sex-differences. The most active lines of work have been (1) in connection with the discovery and interpretation of intersexes in various animals and plants, and (2) in the explanation of the departures from equality in the numbers of the sexes under a variety of conditions, normal or experimental. It is now clear that these results do not negative a chromosome hypothesis of the fundamental distinction between the sexes, at least in animals, but rather supplement it in an important way. Sex intergrades have been studied by Goldschmidt in the Gypsy moth, by Banta in *Daphnia*, and by Sturtevant and others in *Drosophila*; also in plants there have been the studies of intersexes in *Mercurialis* by Yampolsky and in *Plantago* by Bartlett and others. These investigations are still in progress, and it is only necessary to say that they are not out of harmony with a chromosome hypothesis of the origin of the sex-differences, although the situation in plants remains to be cleared up.

Of more immediate interest here are the cases where one of the sexes preponderates. Mr. Julian Huxley (see reference in NATURE, March 24, p. 116) has recently shown how in the millions fish (*Girardinus poeciloides*) a great preponderance of females, followed by a lesser preponderance of males, and finally by equality of the sex-ratio, can be best explained by assuming that the chromosome-constitution of the individual has been temporarily overridden by external influences. The important work of Riddle in controlling the sexes in pigeons may ultimately receive a similar explanation.

In an article by Mr. Alan S. Parkes (*Science Progress*, April, 1921) the author has applied somewhat similar conceptions to the explanation of the well-known departures from equality of the sex-ratios in man. The statistics from the reports of the Registrar-General, 1838-1914, show an average for this period

of 1040 males to 1000 females. There is a similar preponderance of male births in most parts of the world, but in a few regions females preponderate. It is also a remarkable fact that fluctuation in the proportion of male births follows closely the rise and fall in the price of food. Statistics appear to show further a remarkable rise in the proportion of male births throughout Europe during the war, and it is suggested that war conditions were "in some obscure way beneficial to the welfare of the Y-gametes." That racial differences in the sex-ratio exist is shown by comparing Jews with Christians; it appears that the former in all countries show a greater excess of male births, while the crossing of races is also known to disturb the sex-ratios.

From a study of a number of genealogies of British families Mr. Parkes finds that families occur in which the preponderance of males is much greater than 1040:1000, and that this condition is inherited through the male, some strongly male-bearing strains producing more than 58 per cent. in excess of the above frequency considered as the normal.

A new type of inheritance of secondary sexual characters has recently been discovered by Schmidt (*C. r. Trav. Lab. Carlsberg*, vol. xiv., No. 8) in the fish *Lebistes reticulatus* from Trinidad. He shows that the inheritance of a black patch on the dorsal fin of the males in one race is transmitted exclusively from male parent to male offspring, never appearing in the female line at all. This is explained by assuming that the spot is determined by the Y-chromosome, for it is distributed in inheritance as the Y-chromosome is distributed. Hitherto in all cases investigated the Y-chromosome has appeared to be inactive in inheritance, the only evidence against this being the fact that males of *Drosophila* which lack it are sterile. The chromosomes of *Lebistes reticulatus* are now being investigated.

On the basis of this result of Schmidt, Castle (*Science*, April 8, p. 339) has built up an interesting speculation concerning the origin and relationships of the various types of sex-determining chromosomes. Briefly, his suggestion is that the X-chromosome was originally a cytoplasmic body handed on exclusively through the egg, like a plastid, and determining the female condition by its presence. This becomes included in the egg nucleus and is duplicated by splitting, thus giving rise to the condition XX in females and XO in males. If it does not split, a Y element may "develop" as its synaptic mate in the egg, passing later into male offspring, and, through non-disjunction (as in *Drosophila*), ultimately producing YY males which are assumed to be viable; they would give rise, as in *Abraxas*, to the condition in which the female is the heterozygous sex. In criticism it may be said that there is no cytological evidence of the transformation of a cytoplasmic body into a chromosome, unless the "chromatoid body" of Wilson be such a case. But it occurs in addition to the

X-chromosomes. The sex-chromosomes, it is true, frequently differ in their behaviour from the other chromosomes, but the usual assumption that the Y in insects is undergoing gradual reduction has strong evidence in its favour, and the XO condition in males can be accounted for either by its ultimate disappearance in this way or by non-disjunction. This, however, admittedly leaves unexplained the origin of the condition in moths and birds, in which the female is the heterozygous sex.

Finally, it may be added that the discovery of sex chromosomes in the liverwort *Sphaerocarpos* by Prof. Allen (Proc. Amer. Phil. Soc., vol. lviii., p. 289) places the sex differentiation of this group of plants in a new light, and affords a basis for an instructive comparison with the conditions in animals. For a large X-chromosome is found in the nuclei of the female gametophyte, and a small Y in the cells of the male gametophyte. The fertilised egg then contains an X and a Y, which are separated in sporogenesis. Half the spores contain an X and half a Y. This is quite different from the situation in insects where the XY combination produces a male. It is also simpler, the differentiation of the sexes arising through segregation of the X and Y, and the chromosome combination of the sporophyte corresponding to that of males in animal species in which the male is the heterozygous sex.

University and Educational Intelligence.

CAMBRIDGE.—Mr. P. Lake, St. John's College, has been reappointed to the Royal Geographical Society's readership in geography; Dr. J. A. Crowther, St. John's College, appointed University lecturer in physics as applied to medical radiology; and Mr. S. E. Hollingworth, of Clare College, elected to the Harkness scholarship in geology. The Wiltshire prize in geology has been awarded to Mr. A. G. Brighton, Christ's College, and Mr. H. C. G. Vincent, Fitzwilliam Hall.

Mr. W. Campbell Smith and Mr. R. H. Thouless have been elected fellows of Corpus Christi College.

LIVERPOOL.—Dr. McLean Thompson, of the University of Glasgow, has been appointed to the Holbrook Gaskell chair of botany in succession to Prof. R. J. Harvey-Gibson, resigned.

LONDON.—At a meeting of the Senate held on June 22 Sir Sydney Russell-Wells was re-elected Vice-Chancellor for the year 1921-22.

Dr. G. Cook was appointed to the University chair of mechanical engineering tenable at King's College, and Mr. L. Hawkes to the University readership in geology at Bedford College. The title of emeritus professor of philosophy and comparative psychology in the University was conferred on Mr. Carveth Read.

Grants were made from the Dixon Fund to Mr. F. J. F. Barrington, Mr. E. J. Evans, Prof. J. P. Hill, Miss G. Z. L. Le Bas, Mrs. M. M. Neilson-Jones, Prof. Karl Pearson, Mr. J. W. D. Robinson, Mr. D. M. Shaw, Mr. H. G. Smith, and Miss D. M. Wrinch.

The following doctorates were conferred:—*D.Sc. in Zoology*: Mr. W. A. Cunningham. *Ph.D. in the Faculty of Economics*: Mr. S. G. Panandikar. *Ph.D. in the Faculty of Science*: Mr. H. E. Cox and Mr. H. H. Morgan.

MANCHESTER.—The sum of 1000*l.* has been contributed to the appeal fund by Alderman H. Plummer.

OXFORD.—On Wednesday, June 22, the honorary degree of Doctor of Science was conferred on Prof. C. S. Sherrington, president of the Royal Society.

It is announced that Mr. F. S. Edie, lecturer in biochemistry at Aberdeen University, has been appointed to the chair of biochemistry in the University of Cape Town.

M. E. DEUTSCH DE LA MEURTHE has made a donation of 10,000,000 francs to the University of Paris to provide for a university quarter where students may live at a moderate cost.

MR. W. J. JONES, senior lecturer in chemistry in the University of Manchester, has been appointed professor of chemistry in the University College of South Wales and Monmouthshire, Cardiff; and Prof. A. W. Sheen, of the Welsh National School of Medicine, to the chair of medicine at the same institution.

THE Aitchison memorial scholarship of the value of 36*l.*, tenable in the full-time day courses in technical optics at the Northampton Polytechnic Institute, Clerkenwell, is being offered. The examination for the scholarship, open to both sexes, will be held on September 27 and 28. Full particulars can be obtained from Mr. H. F. Purser, 35 Charles Street, Hatton Garden, E.C.1.

Two scholarships, each of the value of 200*l.*, are being offered by the Rubber Advisory Committee of the Northern Polytechnic Institute, Holloway, to enable students who have obtained a good degree in chemistry to attend for a year's special training in rubber technology. Applications, with particulars of the candidates' careers, copies of recent testimonials, and names of referees, must be sent to the Principal of the institute not later than July 5.

THE announcement which appeared in the daily Press last week of the retirement of Prof. Henri Bergson from his chair at the Collège de France merely meant to his friends that he had at last given effect to an intention long contemplated. Owing to the strain of the international work which he undertook for the French Government with such fervour during the critical years of the war, he was compelled to avail himself of the privilege which the Collège allows its members of nominating a deputy, and for some time past M. Edouard Le Roy has occupied his place in the lecture-room. Now that Prof. Bergson is able to take up again the interrupted work of philosophy, he finds that he can hope to do original research only by obtaining relief from the routine work of lecturing. This, and nothing else, is the reason of the resignation which is now announced. The Collège de France, in which Prof. Bergson has held the chair of philosophy for more than twenty years, is a unique institution. Founded by Francis I. in 1530, in opposition to the Sorbonne and the universities, it has retained its high position and character. It is perhaps the only educational institution which survived the Revolution unchanged. Its lectures are without exception open to the public and free. Even a registered student cannot obtain the privilege of a reserved seat. When a professorial chair becomes vacant the successor is elected by the professors, who are not handicapped in their choice by academical regulations of any kind. The appointment entails the duty of delivering two courses of lectures in each session, neither of which may be a repetition of a course previously delivered either in the Collège or elsewhere.

Calendar of Scientific Pioneers.

June 30, 1817. Abraham Gottlob Werner died.—The most renowned geologist of his day, Werner for forty years was professor in the Mining School at Freiberg, which became under him "the European lodestar for the study of mineralogy and geognosy."

June 30, 1857. Alcide Dessalines d'Orbigny died.—Distinguished in early life for his journeys in South America, d'Orbigny in 1840 began the publication of his great work, "Paléontologie Française." In 1853 a chair of palæontology was specially created for him at the Musée d'Histoire Naturelle.

June 30, 1919. John William Strutt, third Baron Rayleigh, died.—Born in 1842, Lord Rayleigh succeeded to the title in 1873. He was educated at Cambridge, succeeded Maxwell in 1879 as Cavendish professor of experimental physics, and in 1887 followed Tyndall as professor of natural philosophy at the Royal Institution—a position he resigned in 1905. His scientific writings embrace every branch of physics, and are known for their extreme accuracy and definiteness. His name is associated with that of Ramsay in the discovery of argon.

July 1, 1881. Henri Etienne Sainte-Claire-Deville died.—Professor of chemistry at the Ecole Normale and in the Sorbonne, Sainte-Claire-Deville carried out important investigations on dissociation.

July 1, 1899. Sir William Henry Flower died.—Flower was Hunterian professor of comparative anatomy and physiology, and for fourteen years acted as director of the British Museum (Natural History).

July 2, 1621. Thomas Harriot died.—The contemporary of Napier and Briggs, Harriot made important improvements in algebra, and his "Artis Analyticæ Praxis," published ten years after his death, did much to bring analytical methods into general use.

July 3, 1672. Francis Willughby died.—An original member of the Royal Society, Willughby was the companion of Ray, and wrote on birds and fishes.

July 4, 1850. William Kirby died.—Rector of Barham, in Suffolk, from 1796 to 1850, Kirby was known for his writings on entomology.

July 4, 1901. Peter Guthrie Tait died.—Tait succeeded Forbes in the chair of natural philosophy at Edinburgh. He was known for his collaboration with Lord Kelvin, his advocacy of quaternions, and his work on thermodynamics and other subjects.

July 4, 1902. Hervé Auguste Etienne Alban Faye died.—President of the Bureau des Longitudes from 1874 to 1893, Faye in 1884 published his "Sur l'Origine du Monde."

July 4, 1910. Giovanni Virginia Schiaparelli died.—A great observer of comets, meteors, double stars, and especially of the planets, Schiaparelli from 1862 to 1900 directed the Milan Observatory.

July 5, 1833. Joseph Nicéphore Niepce died.—One of the pioneers in photography, Niepce began his experiments in 1813. He afterwards collaborated with Daguerre.

July 5, 1859. Baron Charles Cagniard de la Tour died.—Cagniard de la Tour made improvements in mechanical and chemical processes and invented the siren.

July 5, 1906. Paul Drude died.—A distinguished physical investigator, Drude applied the theory of Maxwell as developed by Hertz to the problem of light. He edited the *Annalen der Physik*.

July 5, 1911. George Johnstone Stoney died.—Stoney held important educational posts in Ireland, and contributed to physical optics and molecular physics. To him we owe the term "electron."

E. C. S.

Societies and Academies.

LONDON.

Royal Society, June 23.—Prof. C. S. Sherrington, president, in the chair.—E. F. Armstrong and T. P. Hilditch: A study of catalytic actions at solid surfaces. VI.—Surface area and specific nature of a catalyst: two independent factors controlling the resultant activity. The influence of the surface area of a nickel catalyst on its activity has been traced by examination of the bulk gravity of various types of catalyst: the most efficient catalyst occupies the greatest volume per unit mass. The rate of reduction in hydrogen of nickel oxide prepared in various ways has been examined at various temperatures. A light nickel oxide prepared from the precipitated hydroxide gave curves (hydrogen consumption/time) showing faint points of inflexion, which varied with the temperature of reduction; dense, fused nickel oxide gave a smoother curve, and nickel hydroxide deposited on kieselguhr as a support showed a smooth, continuous curve. The reduction curves are related to the physical conditions rather than to the formation of any definite compounds. When a support (kieselguhr) is overloaded with nickel hydroxide and reduced so that varying proportions of the nickel are in the metallic state, catalytic activity increases rapidly to a maximum, which is maintained until all the nickel hydroxide has been reduced to the elementary state. Catalytic activity is dominated by the condition of the surface layer of reduced nickel.—Sir J. B. Henderson: (i) A contribution to the thermodynamical theory of explosions; (ii) with Prof. H. R. Hassé. Advances in chemical thermodynamics, dealing with dissociation of gases and variation of their specific heats with temperature, are applied to the science of internal ballistics. Direct experiments on specific heats of gases are limited to temperatures below 1500° C., and extrapolation, based upon thermodynamic theory and extending to temperatures of 3500° C. and to pressures of 20 tons per sq. in., tests the theory severely. Part (i) contains the application of these theories to the calculation of the explosion-pressure of cordite in closed vessels, and the calculation of the curve of adiabatic expansion of the products of explosion by considering a series of states of equilibrium and, following thereon, the ideal indicator diagram of a gun. In part (ii) the curve of rise of pressure and the maximum pressure allowing for burning of cordite in parallel layers and for varying capacity of chamber during burning, due to movement of the projectile, are calculated. The results enable the indicator diagram of gun, maximum pressure, and muzzle velocity of projectile to be calculated accurately from the chemical composition of explosive used and rate of burning of the cords. They also show the effects produced by variations in initial pressure, density of loading, temperature of charge, diameter of cords, etc. The method is also applicable to internal-explosion engines using gas or oil.—S. Butterworth: Eddy current losses in cylindrical conductors, with special applications to the alternating current resistances of short coils. A general series for the eddy current losses produced in a non-magnetic metallic cylinder when placed in a transverse field of any form is developed. The theory gives an approximate solution of the problem of the effective resistance of two equal parallel wires carrying equal currents either in the same or in opposite directions. The "uniform field" theory is applied to determine the effective resistance of parallel wire systems, and, by calculating the mean square field acting throughout the section of the coil, formulæ are obtained for the effective resistances of single- and multi-layer sole-

noidal coils of either solid or stranded wire. Conditions producing the maximum value of L/R' for a given length of wire of given diameter are deduced. The observed inferiority of stranded wire coils as compared with solid wire coils at high frequencies is due to the lack of internal spacing of the strands of the coils making the best conditions unattainable.—**E. S. Bieler**: The currents induced in a cable by the passage of a mass of magnetic material over it. The mass used is in the form of a spherical shell, and the deflection of a critically damped galvanometer in series with the cable is deduced. The results agree with those of experiments carried out in the laboratory on a small scale. The theoretical results are used to determine the law of variation of the galvanometer with different factors, and the relation between the galvanometer deflection and the E.M.F. which produces it.—**Dr. G. Barlow** and **Dr. H. B. Keene**: The experimental analysis of sound in air and water: some experiments towards a sound spectrum. The original sound vibration gives rise to an electric current of telephonic magnitude, which is analysed by a method of periodic interruption. A motor-driven interrupter with a range of interruption frequency from 3–2000/sec. is placed in series with a Broca galvanometer in the circuit containing the alternating current to be analysed. The speed of the interrupter is then slowly varied. When the interruptions synchronise with any component of the current, the galvanometer gives a steady deflection, the magnitude of which depends on the phase difference. Thus the amplitude of each component may be determined, and at the same instant the corresponding frequency is observed stroboscopically. Experiments were made (1) to test the trustworthiness of the method by analysing alternating currents containing known constituents; (2) to analyse different types of sound in air, using both carbon microphone and magnetophone receivers; (3) to analyse sounds in water. The variations of the sound spectrum with distance, depth, and direction are investigated, and the spectrum of a motor-driven boat is obtained under various conditions.—**Dr. G. Barlow**: The theory of the analysis of an electric current by periodic interruption. A mathematical treatment of the method of periodic interruption used in the experimental analysis of sounds described in the previous paper is given, with an explanation of the effects of periodic interruption on the intensity and quality of sounds heard in a telephone.

Geological Society, June 8.—**Mr. R. D. Oldham**, president, in the chair.—**Dr. W. F. Hume**: The relations of the northern Red Sea and its associated gulfs to the "rift" theory. The areas specially considered are the northern portion of the Red Sea and the "Clysmic Gulf" (from "Clysmia," the Roman name for Suez), defined as the district lying between the fault-bounded ranges of Egypt and Sinai. Within its borders Miocene deposits are of wide distribution; beyond them they are absent. The folds within this region are from north-west to south-east, outside it the trend is frequently almost at right angles. A line prolonging the direction of the western coast of the Gulf of Akaba to the shores of Egypt divides the Clysmic Gulf from the Red Sea, the former being one of complicated fold-and-fracture effects, while in the latter only fold effects have been observed. It is concluded that the whole region underwent extremely slow submergence, the negative movements continuing from early Jurassic to late Cretaceous times. Emergence of new land probably took place near the close of the Eocene period. It is suggested that the area was occupied by an anticline plunging northwards in the Clysmic Gulf region, and

that it was subject first to marine and then to sub-aerial erosion. This formed part of the continent on which grew the trees of the Petrified Forest, and on which wandered animals such as the *Arsinoitherium* and the earliest elephants. The continental period was most marked during late Eocene and early Miocene times, and the area dealt with here appears to have become one of very varied ridge and depression. The whole region was slowly invaded by the ancient Mediterranean during the Miocene and Pliocene periods. The pre-existing ridges became coral-reef centres and the intervening depressions were filled up, first by land-derived deposits and then by lagoon formations. The earliest of these formations appear to have been of Schlier (Middle Miocene) age. The whole region of the Clysmic Gulf became folded and fractured. There is strong faulting at the borders with the igneous hills, and fold-ranges are of asymmetrical anticline type. Compression of the area, with uplift of portions, offers the best solution for the fact observed. Dislocation so marked and so widespread could scarcely arise under rift formation as defined by Prof. J. W. Gregory, nor can the whole of the surface-differences be ascribed to erosion. No simple solution of the problem can be offered on the evidence at present available, especially in view of the fact that no important faulting has been noted on the western borders of the Red Sea. The portion of the Nile Valley about latitude 26° N., where faulting is most conspicuous, may have been initiated by erosion of a sharp anticlinal fold due to the compression of almost horizontal strata. Sharp folds exist in the desert east of the Nile, but their origin is doubtful.

Physical Society, June 10.—**Dr. C. Chree**, vice-president, in the chair.—**Sir Ernest Rutherford**: The stability of atoms. Traces of hydrogen and helium had been found in discharge tubes believed to be initially free from these gases; but it was impossible to establish that no source of contamination was available. It is necessary to attack the nucleus of the atom, and to do this successfully requires extremely swift particles. The effects produced when α -particles fired through hydrogen collide with an atom were shown, and experiments were described from which the conclusion had been drawn that when an α -particle collides with a nitrogen atom, a hydrogen atom is expelled from the nucleus. The speed of these is in excess of what can be obtained by collisions in hydrogen gas itself, so that the result must be due to the disintegration of the nitrogen nucleus rather than to contamination with hydrogen. Results on the disintegration of aluminium and other elements were also indicated.

Linnean Society, June 16.—**Dr. A. Smith Woodward**, president, in the chair.—**Prof. A. H. R. Buller**: The ocellus function of the subsporangial swelling of *Pilobolus*. The subsporangial swelling of *Pilobolus* functions as a squirting apparatus, and also as an ocellus, which receives the heliotropic stimulus which causes the stipe to turn the fungus gun towards the light. The swelling is transparent and refracts light. It appears to be the only orthoheliotropic plant organ known which has a special light-perceiving cell-structure, which is sometimes described as a simple eye.—**Dr. N. Annandale**: The vegetation of an island in the Chilka Lake. The area of the island is about one-third of a square mile, and the rocks are composed of garnet-bearing quartzite which yields an infertile and scanty soil on weathering. The climate is relatively dry. The vegetation consists mainly of trees, shrubs, and perennial creepers, with a great scarcity of herbs, ferns, and epiphytes, and a complete absence of palms, bamboos, screw-pines, and

orchids. Several distinct zones of vegetation can be distinguished. The peculiarities of the fauna can be correlated directly with the vegetation.—Col. M. J. **Godfery**: The fertilisation of the orchid genus *Cephalanthera*. The author holds that *Cephalanthera* is an old genus, and was not derived from *Epipactis*.

PARIS.

Academy of Sciences, June 6.—M. Georges Lemoine in the chair.—The president announced the death of M. J. B. A. Gaillot, correspondant for the section of astronomy.—G. **Friedel**: The calculation of the intensity of X-rays diffracted by crystals: A correction.—S. **Pincherle**: An integral equation in the complex domain.—B. **Gambier**: Applicable surfaces and the equation of Laplace.—M. **Auric**: The theory of ideal algebraical numbers.—A. **Tian**: The stability and the reversibility of the transformations of the hydrosols obtained by the hydrolysis of salts.—Mlle. **Wolff**: Studies on the molecular refraction and specific rotatory power of furfuralcamphor and some of its derivatives.—Mlle. S. **Veil**: Allotropic varieties of oxides. The conductivity of various metallic oxides measured at varying temperatures has been shown to increase with the temperature, similarly to electrolytes. Magnetic iron oxide and cadmium oxide offer peculiarities, since the conductivity-temperature curves for these show points of inflection. These changes can be attributed to the formation of allotropic forms of the oxides.—C. **Chéneveau**: The variation of the specific refraction of dissolved salts in dilute solution. A study of the specific refraction of dilute solutions of ammonium nitrate, potassium chloride, and magnesium nitrate.—M. **Billy**: The peroxide of titanium. The hydrates of titanium, hitherto regarded as derived from the oxide TiO_2 , are shown to be complexes of hydrogen peroxide and the peroxide Ti_2O_3 .—E. **André**: Contribution to the study of the oils from grape-seeds.—J. **Martinet** and O. **Dornier**: Some new sulphonic derivatives of oxindol and of isatin.—A. **Mailhe** and F. **de Godon**: The preparation of mixed secondary and tertiary phenolic amines. The vapours of aniline and ethyl alcohol passed over alumina at 350° to 380° C. gave a mixture of mono- and di-ethylanilines. The method is shown to be of general application.—F. **Zambonini**: The palmierite of Vesuvius and the minerals which accompany it.—M. **Romieux**: The controversy as to the displacement of shore levels and the phenomena of equideformation.—J. **Cvijić**: Relief of the seashore and river terraces.—A. **Carpentier**: Discovery of a Weald flora in the neighbourhood of Avesnes.—P. **Schereschewsky**: Systems of clouds. Suggestions for a new system of cloud observations. Different states of the sky should be observed simultaneously from a number of stations spread over a wide area.—O. **Mengel**: Influence of the relief and of the heating of the soil on surface winds.—M. **Bridel** and R. **Arnold**: A method allowing the application to plants of the biochemical method of detecting glucose. The method is based on the property possessed by emulsin of causing the combination of glucose with the alcohol holding it in solution. Full details of the technique of extraction and purification of the plant product before submitting it to the action of the emulsin are given.—N. T. **Giung**: The botanical determination of foreign beans.—G. **Bioret**: The Graphideæ.—E. **Chatton**: False and true myogenesis in the pelagic Copepods. An error due to the non-recognition of cœlomic parasitic Peridinians.—C. **Pérez**: A supposed interstitial tissue in the testicle of lizards. A criticism of a recent communication on the same subject by M. Christian Champy.—H. **Bierry** and F. **Rathery**: Liver, blood plasma, and proteid sugar. The authors point out what they believe to be a function of the liver not

hitherto noted, a qualitative and quantitative change in the composition of the blood plasma after passing through the liver.—J. P. **Langlois**: A moving belt for the study of walking and of work. A modification and improvement of a similar apparatus set up by Benedict at Washington.—MM. H. **Vallée** and **Carré**: Anti-aphthous hæmo-prevention and hæmo-vaccination.—G. **Bourguignon**: Chronaxy in neuromuscular Wallerian degeneration in man.

NEW SOUTH WALES.

Linnean Society, April 27.—Mr. G. A. Waterhouse, president, in the chair.—G. I. **Playfair**: Australian fresh-water flagellates. An account of the forms known from collections made in the neighbourhood of Sydney and Lismore. Mention is made of 172 forms representing 39 genera, of which 96 forms and 1 genus are new.—Dr. R. **Greig-Smith**: Note upon the extraction of acids from cultures. In testing the products of fermentation of dextrose by a film yeast, succinic acid was obtained as the only fixed acid. The extraction of the fixed acids from bacterial or from yeast cultures is a monomolecular reaction. The preparation of salts by neutralising the acids until a pink colour is obtained in the presence of phenolphthalein may be faulty because the reaction is slower than is generally supposed.—Dr. A. B. **Walkom**: The occurrence of Ootzamites in Australia, with descriptions of specimens from Western Australia. Three species of Ootzamites and some obscure coniferous remains are described from near Mingenew. The rocks in which they occur consist of dark red ferruginous sandstone, which, with its wide distribution, constitutes an important stratigraphical horizon, and probably indicates a warm, moist climate for northern Australia in Jurassic time.

Books Received.

- Le Mouvement scientifique Contemporain en France. No. 1: Les sciences naturelles. By Dr. G. Matisse. Pp. 160. (Paris: Payot et Cie.) 4 francs.
Relations intellectuelles avec les Centraux? "Ecrasons l'Infâmie." By Maurice Lecat. Pp. viii+128. (Louvain, Ave. des Alliés 92; Bruxelles, Ave. bois Cambre, 16: The Author.)
Faune de France. By P. Paris. No. 2: Oiseaux. Pp. iv+473. (Paris: P. Lechevalier.) 40 francs.
Handbook of Chemistry and Physics: A Ready-Reference Pocket Book of Chemical and Physical Data. By Prof. C. D. Hodgman and others. Eighth edition. Pp. 711. (Cleveland, Ohio: Chemical Rubber Co.) 3 dollars.
Imperial Institute: Indian Trade Enquiry. Reports on Timbers and Paper Materials. Pp. ix+57. (London: J. Murray.) 4s. net.
Psychoanalysis, Sleep and Dreams. By André Tridon. Pp. xiii+161. (London: Kegan Paul and Co., Ltd.) 7s. 6d. net.
A Dictionary of Chemical Solubilities: Inorganic. By Dr. A. M. Comey. Second edition, enlarged and revised. Pp. xviii+1141. (New York: The Macmillan Co.; London: Macmillan and Co., Ltd.) 72s. net.
La Radiologie et la Guerre. By Prof. Mme. P. Curie. Pp. 144+xvi plates. (Paris: F. Alcan.) 8 francs.
British Mammals. Written and illustrated by A. Thorburn. (In 2 vols.) Vol. ii. Pp. vi+108+plates 26-50. (London: Longmans, Green and Co.) 10l. 10s. net the 2 vols.
Common Stones: Unconventional Essays in Geology. By Prof. G. A. J. Cole. Pp. 259. (Common

Things Series.) (London and New York: A. Melrose, Ltd.) 6s. net.

Human Embryology and Morphology. By Sir A. Keith. Fourth edition, revised and enlarged. Pp. viii+491. (London: E. Arnold.) 30s. net.

The National Physical Laboratory: Report for the Year 1920. Pp. 132. (London: H.M. Stationery Office.) 5s. net.

Espace, Temps et Gravitation: La Théorie de la Relativité généralisée dans ses Grandes Lignes. By Prof. A. S. Eddington. Ouvrage traduit de l'Anglais by J. Rossignol. Pp. xii+262+iv+149. (Paris: J. Hermann.) 28 francs.

Liverpool Marine Biology Committee. Memoirs on Typical British Marine Plants and Animals. No. xxiv.: *Aplysia*. By Nellie B. Eales. Pp. viii+84+7 plates. (Liverpool: University Press.) 4s. 6d.

Memoirs of the Geological Survey. Special Reports on the Mineral Resources of Great Britain. Vol. xviii.: Rock-Salt and Brine. By Dr. R. L. Sherlock. Pp. vi+123+2 plates. (London: E. Stanford, Ltd.; Southampton: Ordnance Survey Office.) 5s. net.

Some Wemba Words: Some Meanings and Explanations. By E. B. H. Goodall. Pp. 140. (London: Oxford University Press.) 7s. 6d. net.

The Treaty Settlement of Europe: Some Geographic and Ethnographic Aspects. By Prof. H. J. Fleure. (The World of To-Day.) Pp. 83. (London: Oxford University Press.) 2s. 6d.

Diary of Societies.

THURSDAY, JUNE 30.

INSTITUTION OF CIVIL ENGINEERS (Engineering Conference), at 10 a.m.—W. W. Grierson: The Use of Reinforced Concrete on Railways.—H. J. Fereday: Impact Tests and Allowances.—A. H. Hall: The Influence of the Automatic and Semi-automatic Machine on the Skill and Resourcefulness of the Mechanic and Operator.—A. Musker: Mechanical Appliances and Labour in Loading and Unloading Ship's Cargoes.—Prof. W. E. Dalby: The Elastic Limit.—Prof. E. G. Coker: The Effect of Scratches in Materials.—C. P. Sandberg: Damage to Tires and Rails caused by Brakes or Slipping wheels.—G. Hatton: The Existing Practice of Inspecting Work and Materials.—M. E. Denny: The Design of Fabricated Ships from the Labour-saving Point of View.—J. C. Telford: Economy of Labour on Shipbuilding as effected by Fabricated Ships, etc.—E. R. Mumford: Recent Tank Research in Screw Propellers.—E. H. Richards and M. G. Weekes: Straw Filters for Sewage-purification.—J. Haworth: Activated Sludge.—J. D. Watson: De-watering Sludge.—J. Dalziel: Battery Locomotives.

INSTITUTION OF MECHANICAL ENGINEERS, at 10.15 a.m.—Conference on the Means of Improving the Thermal Efficiency of Heat Power Plants.—H. E. Wimperley: Internal-combustion Engine Theory, with relation to Higher Economy.—F. Samuelson: High Steam-Pressure and other Means of increasing Economy of Steam-Engines.—E. V. Evans: Chemistry of Combustion.—A. Hutchinson and F. Bainbridge: Blast-Furnace Gases.—D. Wilson: Boiler-House Management (General Causes of Boiler Inefficiency).—Prof. W. A. Bone: Low Temperature Carbonisation.—H. Dunell: Engine-House Management (General Causes of Steam-Engine Inefficiency).—A. E. L. Chorlton: Super-Compression.

ROYAL SOCIETY, at 4.30.—Sir J. J. Dobbie and Dr. J. J. Fox: The Absorption of Light by Elements in a State of Vapour. The Halogens.—Prof. W. A. Bone and the late W. A. Haward: Gaseous Combustion at High Pressures. Part II. The Explosion of Hydrogen-Air and Carbon-monoxide-Air Mixtures.—Prof. A. E. H. Love and F. B. Piddock: Lagrange's Ballistic Problem.—J. Proudman: The Principles of Internal Ballistics.—R. H. Fowler: A Simple Extension of Fourier's Integral Theorem and Some Physical Applications in particular to the Theory of Quanta.—Capt. D. Brint: The Dynamics of Revolving Fluid on a Rotating Earth; and other papers.—The following papers will be read in title:—Takeo Shimizu: A Preliminary Note on Branched α -ray Tracks.—Takeo Shimizu: A Reciprocating Expansion Apparatus for detecting Ionising Rays.—Prof. R. W. Wood: The Time Interval between Absorption and Emission of Light in Fluorescence.

FRIDAY, JULY 1.

INSTITUTION OF CIVIL ENGINEERS (Engineering Conference), at 10 a.m.—R. G. H. Clements: Road Vehicles and their Relation to Road Surfaces.—A. Dryland: Advantages of Bituminous Macadam.—C. H. J. Clayton: The Conservancy and Maintenance of Rivers from the Point of View of Land Drainage.—R. F. Grantham: The Effect of Sluices and Barrages on the Discharge of Tidal Rivers.—G. E. W. Cruttwell: The Utility of Models for Estuarial Experiments.—H. C. Reid: The Relative Advantages of Dredging and Training-walls in Estuaries.—E. Latham: The

Use of Inertia Gauges in Pile Driving.—A. L. Bell: The Bearing Power of Soils.—Sir James McKechnie: Internal-combustion Engines with Large Cylinders.—Sir Vincent L. Raven: The Mechanical Advantages of Electric Locomotives compared with Steam.—T. Crook: The Effect of the War on Mineral Supplies.—M. Deacon: The Utilisation of Exhaust Steam in Turbines.—W. C. Mountain: Steam *versus* Electric Winding.—S. Copper-Coles: The Relative Values of Protective Metallic Coatings for Iron and Steel.—J. Richardson: Recent Progress in Large Diesel Engines for the Mercantile Marine.—R. J. Walker and S. S. Cook: Experience with Marine Turbine Reduction-gears.—E. Sandeman: Compensation Water.—F. W. Macaulay: Pipes for Pressure Conduits.—Dr. H. Lapworth: The Relation of Run-off to Rainfall.—Economic Limits of Distribution from Coal-fired Stations.—B. Welbourn: Low-voltage Overhead Distribution.

INSTITUTION OF MECHANICAL ENGINEERS, at 10.30 a.m.—Conference on the Means of Improving the Thermal Efficiency of Heat Power Plants.—R. Nelson: Waste-Heat Utilisation.—Sir Henry Fowler: Superheating.—Dr. W. R. Ormandy: Liquid, Colloidal, and Powdered Fuels.—H. Moore: Liquid Fuels (Internal-combustion Engines).—A. W. Bennis: Automatic Stokers.—W. H. Patchell: Air Heating for Boiler Furnaces.—C. E. Stromeyer: Feed-Heating and Economisers.—Prof. W. E. Dalby: The Indicator as an Aid to Economy.

GEOLOGISTS' ASSOCIATION (in Architectural Theatre, University College), at 7.30.—H. Bury: Some High-level Gravels of North-East Hampshire.

MONDAY, JULY 4.

ROYAL BOTANIC SOCIETY OF LONDON, at 3.—Prof. A. R. Bickerton: The Generic Simplicity and Great Importance of Basic Principles in all Scientific Work. (1) The General Graphics of Science.

ROYAL INSTITUTION OF GREAT BRITAIN, at 5.—General Meeting. ARISTOTELIAN SOCIETY (at University of London Club, 21 Gower Street), at 8.—Dr. F. C. S. Schiller: Arguing in a Circle.

WEDNESDAY, JULY 6.

ROYAL SOCIETY OF MEDICINE (Annual General Meeting), at 5.—Presentation of Gold Medal to Sir Almoth Wright.

THURSDAY JULY 7.

MEDICO-LEGAL SOCIETY (Annual General Meeting) (at 11 Chandos Street, W.1), at 8.30.—Prof. A. Louise McIlroy: Some Factors in the Control of the Birth-rate.

CONTENTS.

	PAGE
American and British Superannuation Systems	545
Lord Rayleigh's Scientific Papers	546
Studies of British Mammals	547
Forestry in France	548
Our Bookshelf	549
Letters to the Editor:—	
Co-operative Indexing of Periodical Literature.—	
Dr. F. A. Bather, F.R.S.; Prof W. M. Flinders Petrie, F.R.S.; Dr. John W. Evans, F.R.S.; Arthur Percival Newton; Stephen Gaselee, C.B.E	550
W. Warde Fowler: A Personal Appreciation.—	
H. E. A.	551
Ionisation Potential and the Size of the Atom.—Prof. A. S. Eve	552
A Novel Magneto-Optical Effect.—Sir Oliver Lodge, F.R.S.	553
Helicopters.—A. Mallock, F.R.S.	553
A Physical Interpretation of the Energy Quantum.—Ian Aucken	553
University Statistics of the United Kingdom, 1919-20	554
Protective Measures against X-rays and Radium Cosmogony and Stellar Evolution. I. (<i>Illustrated</i>) By J. H. Jeans, Sec.R.S.	557
Obituary:—	
Dr. A. M. Kellas	560
Notes	561
Our Astronomical Column:—	
Occultation of Venus	566
The Total Amount of Starlight	566
Periodicity of Variable Stars	566
Royal Sanitary Insitute: Folkestone Congress, June 20-25	567
The Importance of Research in the Development of the Mineral Industr.es. By Sir Richard Redmayne, K.C.B.	568
The Genetics of Sex. By Prof. R. Ruggles Gates	571
University and Educational Intelligence	572
Calendar of Scientific Pioneers	573
Societies and Academies	573
Books Received	575
Diary of Societies	576



THURSDAY, JULY 7, 1921.

Editorial and Publishing Offices:

MACMILLAN & CO., LTD.,

ST. MARTIN'S STREET, LONDON, W.C.2

Advertisements and business letters should be
addressed to the Publishers.

Editorial communications to the Editor.

Telegraphic Address: PHUSIS, LONDON.

Telephone Number: GERRARD 8830.]

Internationalism.

AT the outbreak of war in 1914 it was widely proclaimed that the Allies were fighting for the integrity of small nations. The war was fought and won to no small extent through appeal to the spirit of nationality. At the time of the Armistice small peoples sprang up here and there—as, for instance, in the Caucasus—clamouring for “the recognition of their national aspirations”; and the minor wars and disputes which have followed have arisen largely from the encouragement afforded to national ambitions by the attempt to fix boundaries or to allocate territory in those areas in which “ethnological affinities” are uncertain or the distribution of races is ill defined. Concomitantly with this quickened sense of nationality there grew up an idea which is necessarily, to some extent, in conflict with it. The desire to avert the recurrence of a catastrophe which rapidly assumed such proportions as to imperil the whole world turned the thoughts of men to the conception of an international union which should exercise such control over its members as to prevent precipitancy in action and in the ultimate resort be in a position to exert such force as to check an appeal to the arbitrament of war.

In a sense, the League of Nations represents a compromise between the two ideas. It aims at a comity of nations without undue interference with the sovereignty of the constituent States. Springing from a desire that the war should end war, to use the common phrase, the League has become

NO. 2697, VOL. 107]

an expression of a broader humanitarian ideal. The duties of the mandatory Powers are a “sacred trust,” and this spirit animates the whole conception. The more influential supporters of the League, in this country at least, have approached the problem in no doctrinaire spirit. They recognise that progress must be slow, and that the keystone of success lies in the education of the peoples of the several States, upon whom the continued existence of the League must ultimately depend. The fact that members of the League have transgressed both the spirit and the letter of the Covenant does not necessarily condemn the League. Its position is not yet sufficiently assured to resist the stress of abnormal conditions.

To Mr. H. G. Wells, however, the League of Nations merely represents a number of vague movements for a world-law, world-disarmament, and the like among intellectuals; and in his work, “The Salvaging of Civilization,” he proposes a different type of international unity. Holding that there cannot be any world-control without a merger of sovereignty, he plumps boldly for a world-State as the sole possible preventive of a series of wars which will come to an end only when knowledge has perished and we have sunk into a state of barbarism. To avoid this contingency, or rather certainty, Mr. Wells would arouse in mankind a recognition of the fact that the world has become one community, and as such should be regulated by a world-law. That such an attitude of mind is not an impossible ideal is indicated by the feeling which was aroused even in the remotest parts of the world by ex-President Wilson’s first proposal for a League of Nations. To attain this acceptance of a world-law Mr. Wells relies upon education, particularly of the young, in accordance with a scheme which he has sketched in outline.

While in many respects this scheme of education may be suitable for a highly civilised Western people, it ignores differences of outlook and culture. “Schooling,” says Mr. Wells, “is, in fact, . . . the expansion and development of the primitive savage mind, which is still all that we inherit, to adapt it to the needs of a larger community.” This statement is at best but a half-truth. The highly civilised races of Europe and America have centuries of development behind them, and notwithstanding the “speeding up” which has become possible with the development of modern conditions, the less advanced races, even of parts of Europe, such as the Balkan Peninsula, are not likely to assimilate these ideals for some time to

come, while in the case of the really backward races the premature application of modern culture and educational methods would spell disaster. Wise supporters of the League of Nations do, at any rate, recognise that part of the "sacred trust" of a mandatory Power is to provide for the education and training of the races under its tutelage on lines suitable to their stage of development.

Criticism of any scheme of internationalism is easy, and the difficulties which have to be overcome are enormous. The verdict of history on the whole is adverse. But against this must be set the fact that the world has never been faced with conditions similar to those of to-day, or with the possibility of a crisis such as would be involved in another war. Is the realisation of the danger which threatens civilisation strong enough to overcome the jealousies, the bickerings, and the rivalries of States which are loosely joined in a confederation, or even united under a "world-law"? Present conditions are not favourable to the probability of success. Although we may speak of nations as if they were individuals, one of the strongest of social forces which operate in the case of the majority of the individual members of a community is absent. Nations, like corporations, have no conscience, and the force of the moral judgment and the opinion of others is not operative. Whereas in a civil society public opinion largely determines conduct and force is the ultimate sanction, in a confederacy of nations force is the only sanction. The balance of power alone will influence any member or group of members who may wish to defy the body as a whole.

It is no answer to criticism to say that in a world-State, or in the conditions of international amity towards which the supporters of the League of Nations would wish to progress, such occasions for misunderstanding would not arise. Apart from the differences in degree of culture, there is among nations as they exist to-day a variety in outlook which is the outcome of history, tradition, education, and environment. The effect of this variety in outlook was patent to those who, during the war, took part in operations with the composite armies which fought on some of the Allied fronts. The outward semblance of unity of action was attained only by a constant smoothing away of difficulties and misunderstandings arising out of national differences of temperament and outlook.

Differences of temperament are easy to note, but difficult to reduce to a scientific formula.

Nor do we know how far they are fundamental and ineradicable. The comparative study of racial psychology on modern scientific lines is almost an unexplored field. National character, in so far as it is the product of tradition and education, may be susceptible of modification. Most nations to-day are the result of a fusion of races the members of which live more or less in amity, and this lends support to the view which holds to the ultimate possibility of a wider unity. Against this, however, must be set the view of some anthropologists who are inclined to attach increasing importance to race as a persisting element in character. In this country, for instance, notwithstanding common environment, common tradition, and common institutions, differences of occupation and of class feeling seem, in a general way, to go with differences of racial type. Should a more extended observation tend to confirm this view, it would suggest that any form of international confederation which aims at obliterating nationality and race would scarcely attain enduring success.

What Relativity in Science Implies.

The Reign of Relativity. By Viscount Haldane. Pp. xxiii + 430. (London: John Murray, 1921.) 21s. net.

THERE is no need to begin this notice of Lord Haldane's book with a general reference to its scope and purpose. It is well known that, though the book deals with many problems of science, it is not scientific in the technical meaning of the term; it is philosophy, and, as philosophy, it includes every realm of human experience, and, therefore, science, in its synopsis. It will be more interesting to readers of NATURE to select certain particular problems of science which are also problems of philosophy.

The first part of the book deals mainly with the principle of relativity, the metaphysical basis of which is brought out with wonderful clearness. Lord Haldane achieves this, not so much by his direct exposition, which is thorough, as by his delicate and subtle critical comparison of two methods of applying the principle in mathematics and physics, that of our English mathematician, Prof. Whitehead, and that of Einstein himself. His exposition of both these writers is masterly. The chapter on Einstein is the clearest account of his theory and method that has yet appeared; possibly it appears clearer than it otherwise would from the fact that it follows the account of Whitehead, which is certainly more difficult. This does

not mean that Lord Haldane's exposition has made either writer easy to understand, but it has made it possible for anyone who cares to give the necessary attention and concentration to understand them both. Those who have argued *a priori* that any exposition of the principle of relativity by Lord Haldane must be defective and inconclusive because he is not a mathematician and therefore does not use or know how to use the language which enables mathematicians to express their equations have only shown that they mistake both the purpose and the nature of the value of mathematical methods. It is just because mathematics is restricted to abstract quantitative measurements that its system of symbols is so effective an instrument. Mathematicians are the first to acknowledge this. They know it is they who are handicapped when it comes to laying bare the metaphysical concept, handicapped by the very ease with which they are able, by the manipulation of symbols, to simplify the most complex and complicated quantitative equations.

When we say of anything that it is relative, the question immediately follows: Relative to what? Absolute relativity is either a contradiction in terms, as if one should say a round square, or it is an expression for that extreme form of scepticism which professes to be a universal negation. Now, undoubtedly the first impression we receive of the general principle of relativity does dispose us to identify it with the principle of universal doubt. On this aspect of the great problem Lord Haldane is clear and pronounced from the first sentence of his preface to the end of his book. To the question, Relative to what? he replies, Relative to knowledge; and knowledge is not itself an abstract relation, but a concrete universal. In this he is following Hegel, who first brought to light, in its modern form, the dialectical nature of thought. "Knowledge," says Lord Haldane, "is dynamic. It is an effort to transcend the apparently given. It is always pointing beyond itself" (p. 140). It is from this point of view that the comparison of Whitehead and Einstein is instructive. Both are concerned, and concerned only, to present to us a science of Nature. Both reject the absolute: there is neither a space-time system nor a material, dependent or independent of the observers attached to it, which can serve as a norm by which to regulate the relations of different space-time systems. Both reject the principle of action at a distance: it is inconceivable as fact and useless as a principle. An interesting, though perhaps a minor, point in which Lord Haldane notes a

difference between them is that, while for Whitehead the element out of which our concept of Nature is constructed is the event, and the object is a derivative notion, for Einstein the event seems to depend on the notion of object. In this Lord Haldane thinks Whitehead is more faithful than Einstein to the fundamental principle of the four-dimensional space-time continuum. Apart from this, it is Einstein who has made the greater advance to the full philosophical concept. Whitehead halts. He cannot surrender the notion that Nature in its existence is self-contained, that it stands for a reality which in the last analysis is closed to mind. Is this concept of a reality closed to mind a necessity of mathematical and physical science? Some philosophers would agree with Whitehead in saying, Yes. They are the new realists, and are here criticised from that point of view. On the other hand, Einstein and Eddington seem very definitely to say, No, and to be able to prove it. Lord Haldane suggests that Whitehead's own persistent question, in regard to any and every specified point-event—the question, Whose space-time? or, What space-time system?—in its implications is the negation of his own conclusion. This brings out Lord Haldane's foundational fact. Knowledge is a universal within which all distinctions fall. It is not, and cannot be, conceived as an abstract relation between two self-subsistent and essentially exclusive realities, mind and Nature.

Let us now turn to another question, which is equally pressing as a scientific problem, and equally significant as a philosophical problem—the quantum theory. Lord Haldane makes only a brief reference to it (p. 106), but it is in a certain sense even more relevant to the concept which it is his main purpose to expound, the concept of degrees of reality, than the principle of relativity itself. For the quantum theory shows that in scientific explanation, however far we are able to pursue it, we are brought up finally against a fact which positively forces us to appeal to a character of knowledge in plain contradiction of our scientific principle of explanation.

On p. 114 there is a delightful account of the curious statue erected to Gauss and Weber in Göttingen. It is made the occasion of expounding the work of those mathematicians who, as Lord Haldane says, "nearly three-quarters of a century since, prepared the way for thinkers like Einstein and the interpreters of the doctrine of quantitative relativity." But it is also curious to remember that at the same time there was living in Leipzig another Weber, the philosopher and psychologist who has given his name to the famous law of

psycho-physics. Weber's law was the first definite discovery of the fact on which the quantum theory rests. He discovered that in sensible experience changes are not continuous—that is, do not correspond to the continuity of the changes of the physical stimulus, but occur in discrete quanta. He was a parallelist, and thought that changes in the physical environment were concomitant with changes in sensation. He never suspected, probably would have found it difficult to conceive, that changes in the physical world are discrete. Planck's quantum theory is the discovery that the same fact which Weber found to characterise the psychical world characterises the physical world; that energy is emitted, not continuously, but in discrete quanta; that, as Lord Haldane says, we may even have to regard space as a discrete manifold. This comparison is not a fanciful notion, nor purely imaginary. The whole problem was discussed by Henri Poincaré in "Science et Hypothèse" before Planck's discovery. Poincaré cites Weber's law as actual proof that the concept of mathematical continuity is only a postulate, declares that it is unverifiable, and suggests that it may be disproved or superseded. This is peculiarly significant in regard to Lord Haldane's concept of the concrete universal, the concept that reality is relative to the character of knowledge.

The practical gain in such a concept when we are dealing with biology and with the mental sciences is the topic of chap. vi. of the book. The most striking thing about the new scientific revolution is the havoc it is making of the once unchallengeable and universally accepted notions at the basis of the purely mathematical sciences. It is not, for example, Newton's law of inertia, primarily and mainly based on empirical observation, which is suspect. It is the much more fundamental law, the law of the equivalence of action and reaction, a purely rational principle, which seems now to be on its trial. The whole direction of scientific speculation in the nineteenth century was towards the conscious goal of mechanical interpretation. Scientific advance was practically identified with the confident anticipation that all the biological and mental sciences, even including such purely human interests as art and religion, would be mechanistically explained. The new spirit and the new direction in scientific speculation at least recognise that the abstract can never comprehend the concrete; and this recognition more than anything else is bringing about the *rapprochement* between science and philosophy, so long and so unreasonably estranged.

H. WILDON CARR.

NO. 2697, VOL. 107]

A New Book on Cactaceæ.

The Cactaceæ. By N. L. Britton and J. N. Rose. Vol. ii. (Publication No. 248.) Pp. vii + 239 + 40 plates. (Washington: The Carnegie Institution of Washington, 1920.)

ALL cultivators of cacti and all botanists who are interested in this remarkable family of plants will feel satisfaction in knowing that at last we have in the English language a standard up-to-date monograph of the natural order Cactaceæ, which is universally recognised as being the most difficult of all flowering plants to study. With the exception of a few scattered but excellent papers upon them by Drs. Britton and Rose, Dr. Engelman, and Berger, this is the first work in the English language that gives a complete account of the order as we know it to-day. This fine book is so excellently planned and so fully illustrated as to be a long way in advance of the very unsatisfactory German works that have hitherto held the field, and will be found to be a real boon to all who study these plants.

From the introduction to the first volume (a notice of which was published in *NATURE* for September 11, 1919) we learn that Drs. Britton and Rose at first intended to monograph only the Cactaceæ of North America, but, happily, upon a proposal made by Dr. D. T. MacDugal, the plan was extended to include the whole of the family. Extensive preparations were made and a large army of workers was enlisted to collect and photograph the species in their native habitats, the result being that the authors have had at their disposal a larger amount of living and other material, accompanied by field-notes, drawings, etc., than any other students of this group have ever been able to obtain. As the types (when existing) of the older as well as of modern species have also been consulted, the authors have been able to detect and correct many errors of determination that are found in existing monographs.

Vol. ii. is of quarto size, well printed and profusely illustrated with photographs, drawings, and coloured plates, which, it is a pleasure to note, are nearly all originals. There are good keys to the tribes, subtribes, genera, and species, so that, taking into account the aid afforded by the figures, there should be no great difficulty in naming cultivated specimens when in flower.

Each tribe, subtribe, and genus is separately characterised, and the type of each genus indicated. Under each species the synonymy, with the date of their publication, a description, men-

tion of the type locality, the general distribution, references to illustrations, and general notes are given. All the descriptions are in English, and written in a correct but very simplified style, so that anyone can easily understand them. Latin descriptions find no place in this admirable work, which is designed to be useful to the multitude rather than to the botanist alone.

In the first volume the Cactaceæ are divided into the three tribes Pereskieæ, Opuntieæ, and Cereæ. The tribe Pereskieæ contains only the single genus *Pereskia*, of which nineteen species are described. The Opuntieæ are divided into seven genera, of which *Opuntia* is the largest, containing 240 species; the other genera have only one or a few species in each. These two tribes fill the first volume, and the Cereæ, which comprise the bulk of the order, are being dealt with in the remaining volumes. The first portion of the Cereæ is accounted for in the present volume, where the plants that are commonly known by the generic title of *Cereus* are described and illustrated.

It has long been recognised that different species of *Cereus* produced different types of flower, and since, in other natural orders, differences in floral structure are recognised as being of generic value, some botanists have founded genera upon some of the different floral types found among Cerei. These genera have not hitherto found much favour among botanists or horticulturists, because the plants, when not in flower, often present a great similarity to one another. The authors of "The Cactaceæ," however, have accepted the view that a difference in floral characters should constitute a generic distinction; they have had this view constantly in mind, and carried it to a logical conclusion, so that they have divided the old genus *Cereus* into no fewer than forty-seven genera, containing 275 species. Twenty of the genera are proposed for the first time in this volume. Whilst there can be little doubt that the plants which have been placed in the genera *Heliocereus*, *Aporocactus*, *Cleistocactus*, etc., should be separated from *Cereus*, it may be questioned whether those placed in the genera *Dendrocereus*, *Harrisia*, *Acanthocereus*, etc., should be held to constitute more than sectional groups under *Cereus*. This, however, is a matter of opinion, and time alone will show if the numerous genera maintained in this work will be generally accepted. Whether they are accepted or not, their adoption in "The Cactaceæ" in no way invalidates the usefulness of that splendid work. The reviewer has had considerable experience in the use of existing monographs, and has found "The Cactaceæ" very far in advance of them;

it can be recommended with confidence to students.

The only noticeable fault in the work is the rather serious one that exceptions are always neglected in the keys. This, however, is a fault appertaining to most botanical works, and invariably leads the novice astray. For example, should a novice desire to find out, by means of the key given on p. 1 of vol. ii., the subtribe in which the authors place the globose, spineless plant cultivated under the name *Echinocactus* (and *Anhalonium*) *Williamsii*, no place for it will be found. The only spineless plants mentioned in that key belong to the subtribe *Epiphyllanæ*, which have flat, many-jointed stems. This fault is so easily remedied by including exceptions and variable characters again and again under the headings of different parts of the key that perhaps the authors will endeavour to correct this defect in the continuation of their work. They are to be congratulated heartily upon the manner in which they have so far carried out their very difficult task of evolving order out of the very confused synonymy found in other works upon this group of plants.

N. E. BROWN.

A Study in Geo-chemistry.

The Enrichment of Ore Deposits. By W. H. Emmons. (Bulletin 625. United States Geological Survey: Department of the Interior.) Pp. 530. (Washington: Government Printing Office, 1917.)

UNDER the above modest guise the United States Geological Survey has published a volume of the greatest value to the student of ore deposition, which may fairly claim to rank as one of the most interesting of recent contributions to this very difficult branch of economic geology. The author points out that two phases in the formation of economically important ore deposits require independent investigation, namely, the formation of the primary ore deposits and the subsequent modifications which the more superficial portions in many cases undergo.

The present work is devoted exclusively to a comprehensive investigation of the second of these phases, the genesis of the primary ore deposits being considered indirectly only. The author reviews successively the conditions that make for enrichment, such as amount of rainfall, surface contours, permeability of the rocks, the nature of the underground circulation of water, and in particular the oxidation of sulphide deposits. He lays very great stress upon the last-named, and ascribes the solution of the various minerals

affected almost exclusively to the action of sulphuric acid produced by the oxidation of sulphuretted ores. This thesis is developed in detail in a series of chapters devoted to the chemistry of enrichment, in which the conditions of solution and precipitation, so far as the more important metals are concerned, are worked out in full detail. This section is an admirable contribution to geochemistry, and will well repay careful study. It is perhaps possible that the author pins his faith somewhat too exclusively to the action of sulphuric acid and somewhat underrates the possible effect of other solvents. In part this may be due to the fact that he has confined his studies to the North American continent and to the chemical changes that characterise the temperate zones; thus it is significant that the word "lateritisation" is not even once mentioned, and that this phenomenon, which has played an important part in the secondary modification of certain ore deposits in tropical and sub-tropical regions, is here quite disregarded.

Each of the more important metals is then considered in detail; the principal ores of each, their solubilities and mode of occurrence, are discussed, and the influence of enrichment is illustrated by descriptions of a number of representative deposits of each metal; finally, the non-metallic or gangue minerals are treated in the same way. It will be obvious, even from this brief sketch, that the author has done his work with great thoroughness, and it is easy to foresee that this volume will remain for a long time the standard text-book (for such it really is) on the subject.

It need scarcely be said that there are a number of highly contentious points upon which it would be hopeless to expect any general agreement amongst geologists. Perhaps the phrase to which most will take exception is a statement on p. 15: "Many of the rich deposits of gold are primary." It is not too much to say that the exact opposite of this will be more in accord with the experience of most students of the subject, and that the statement, "None of the rich deposits of gold are primary," would meet with far more general acceptance. A gold deposit that has not undergone secondary enrichment is quite exceptional, and many examples where such enrichment has assumed a scale of great importance are familiar to all economic geologists, e.g. the Witwatersrand and in Western Australia.

Far more difficult and more debatable is the question whether the author has drawn rightly the line of demarcation between the phenomena that ought and those that ought not to be included in the list of secondary enrichment. There are

numerous cases where material too poor to be economically workable (which the author, following Ransome, designates as "protore") has been enriched until it is worth working and thus becomes a true ore. Few will object to the inclusion amongst cases of secondary enrichment of those protores that have been converted into ores by the addition of valuable mineral matter, as, for example, the monzonite copper ores of Bingham, Utah, Ely, Nevada, etc.; it is, however, far more doubtful whether the term can fairly be applied to deposits which have been enriched by the leaching out or dissolving away of gangue material. Thus the important deposits of brown hæmatite of Santander, Spain, have been derived from ferriferous dolomite, containing only some 3 per cent. of iron, by the solution of the carbonates of lime and magnesia. It would probably be more correct to designate these as primary deposits than to look upon them as enriched protore. Many writers classify them as "residual deposits." Obviously, if Mr. Emmons carried his method to its logical conclusion, he would include also clastic deposits, seeing that these are the result of the concentration or mechanical enrichment of mineral deposits that will in many cases have been protores.

It is interesting to note that the author has confined his attention to secondary enrichment, and makes no specific reference to secondary impoverishment as such; necessarily he discusses the phenomenon as antecedent to enrichment, but there are certain cases in which the subject deserves attention for its own sake.

Perhaps reference to such controversial points as the above will serve better than anything else to bring out the difficulties of the subject that Mr. Emmons has so ably dealt with in this volume, and both he and the United States Geological Survey are to be congratulated upon this important contribution to the study of the phenomena of ore deposition. H. LOUIS.

Our Bookshelf.

The Elements of Theoretical and Descriptive Astronomy. By C. J. White. Eighth edition, revised by P. P. Blackburn. Pp. xi+309+ix plates. (New York: John Wiley and Sons, Inc.; London: Chapman and Hall, Ltd., 1920.) 17s. 6d. net.

THIS book is something of a curiosity, if only because it has reached an eighth edition. The first edition was published in 1869 for the benefit of the students of the U.S. Naval Academy. It was an elementary primer giving the simple geometrical facts of astronomy. So far as can be

judged from its latest successor, the work was done neither better nor worse than usual. That the original author's effort has proved more enduring than Bismarck's may be accounted for by its privileged sale in a particular institution.

Had the book been confined to the permanent geometrical elements, and, after the introduction of more modern numerical data and the excision of all archaic matter, offered for sale at one-third of the price, it might have been worthy of attention. The new editor claims to "have endeavored to bring it up to date." The following quotation, giving the latest information on radial velocities, will afford a measure of the reviser's success:—"Mr. Huggins, using a spectroscope of large dispersive power, and carefully comparing the spectrum of Sirius with that of hydrogen, found that the line F in the spectrum of Sirius was displaced, by about 1/250th of an inch."

This from America in 1920! To a very fair account of the disappearance of Saturn's rings is appended the remark: "The last disappearance took place in 1907; the next will take place in 1922." Perhaps, on the whole, it is well that the price of the volume should be prohibitive.

Radioaktivität und die neueste Entwicklung der Lehre von den chemischen Elementen. By Prof. K. Fajans. Dritte Auflage. (Sammlung Vieweg; Tagesfragen aus den Gebieten der Naturwissenschaften und der Technik. Heft 45.) Pp. viii+124. (Braunschweig: Friedr. Vieweg und Sohn, 1921.) 6.50 marks.

IN this book Prof. Fajans gives a simple and clear account of the advances in chemical theory which have resulted from the study of radio-activity. A brief description of the radio-active bodies and their transformations is followed by an account of their chemical properties, leading to their classification in the periodic system, and the recognition of the existence of elements which, though differing in atomic weight, are identical in chemical behaviour. The author shows how Moseley arrived at a number which is a more fundamental characteristic of an element than its atomic weight, and, developing the Rutherford theory of atomic structure, identifies the Moseley number with the value of the charge on the nucleus of the atom. He is then able to give an explanation of the nature of isotopes and of the periodic classification. A description of Aston's mass spectrograph for the investigation of the isotopes of ordinary elements is given in an appendix.

The book is, on the whole, well written, and the matter has been carefully limited to the essential facts and their explanation on the nuclear theory. Full references are given to the original papers.

Relativitätstheorie und Erkenntnis Apriori. By H. Reichenbach. Pp. v+110. (Berlin: Julius Springer, 1920.) 14 marks.

THE author states that the theory of relativity contradicts the critical philosophy of Kant, in reference both to the concept of time and to the

relation of physical fact to Euclidean geometry. There are only two possibilities, he says: either the relativity theory is false, or the philosophy of Kant needs amending at the points at which it is in contradiction with Einstein. The first possibility seems ruled out after the brilliant success of the relativity theory, both in its double confirmation in experience and in its theoretical contribution to physical thought. Accordingly, the author sets out to analyse the exact point at which it is at variance with critical philosophy, and finally claims to carry through such a modification of the concept "a priori" that the conflict is resolved. His conclusion is: "We can no longer maintain that the idea of 'a priori' is independent of all experience, but we must hold that 'a priori' principles alone constitute the world of experience." This book will repay reading by those who are specially interested in the philosophical aspects of the relativity theory.

Les Etoiles Simples. By Dr. F. Henroteau. (Encyclopédie Scientifique: Bibliothèque d'Astronomie et de Physique Céleste.) Pp. xi+244. (Paris: Octave Doin, 1921.) 10 francs.

As a guide and index to the great advance in knowledge of the stellar system that has taken place in the last thirty years, this volume will be found extremely useful. Commencing with constellations and star-catalogues, the author proceeds to spectral types and schemes of evolution, notably the giant and dwarf hypothesis that holds the field at present.

The chapter on photometry contains a full description of the photo-electric cell, with instructions for its manufacture. Colour-indices are defined, and systems of colorimetry, both visual and photographic, are explained.

The great increase in the accuracy of stellar parallax determination due to the photographic method, with various refinements suggested by experience, is described in sufficient detail; indirect methods—the spectroscopic of Adams, the moving-cluster method of Boss and others, and the hypothetical-mass method applicable to binaries—are then explained. The remaining chapters deal with proper motions, radial velocities, and stellar distribution.

The book is wonderfully complete considering its small size. Each chapter is followed by a useful bibliography, which will enable students interested in special branches of the subject to carry their researches further.

A. C. D. CROMMELIN.

Psyche's Lamp: A Revaluation of Psychological Principles as Foundation of All Thought. By Robert Briffault. Pp. 240. (London: George Allen and Unwin, Ltd.; New York: The Macmillan Co., 1921.) 12s. 6d. net.

THERE is no doubt excellent matter in this book, but the author's method and dogmatic manner are likely to be very irritating to the inquiring student. As the title indicates, the appeal is rhetorical rather than scientific or logical.

Letters to the Editor.

[The Editor does not hold himself responsible for opinions expressed by his correspondents. Neither can he undertake to return, or to correspond with the writers of, rejected manuscripts intended for this or any other part of NATURE. No notice is taken of anonymous communications.]

Pathogenic Organisms in the Pollen of Flowers and Disease in Bees.

THE observations of Dr. Rennie and his co-workers have established an association between Acarine infection and Isle of Wight disease in bees. There still remains, however, the question of the part played by bacillary infection in this and other diseases which affect bees. In this communication I desire to direct attention to two aspects only of this complex problem.

(1) In the course of an inquiry during the last three years into an epidemic having many of the features of the so-called Isle of Wight disease, which has caused the loss of a number of my own hives and other stocks in the Midland area, an aerobic short spore-bearing and gram-negative bacillus resembling *B. pestif. apis*, as described by Dr. Malden in the *Journal of Agriculture*, vol. xv., No. 11, February, 1909, was obtained in large numbers from the faeces of affected bees from all the diseased stocks, and was readily grown, sometimes in pure culture, in broth, or on agar or serum agar.

In 1919 I also found that the same organism could be cultured from the sealed cells of the honey-combs from infected hives. A number of cells were opened by removing the cap with a sterilised instrument, and platinum loops of honey taken from these sealed cells were added to broth or smeared on an agar or serum agar slope and incubated at 37° C. for 36 hours. Numerous colonies of the spore-bearing, gram-negative bacillus were obtained from many of the cells. The organism seems to exist in the honey in the spore form only, no bacillary forms being detected before culture, and no cloudiness or discoloration of the honey being produced. In two cases it grew readily when obtained from infected honey cells which had remained sealed for more than twelve months.

The colonies grown from honey resemble those obtained by culture from the faeces of affected bees. They are smooth and white when small, but soon show a corrugated brain-like surface, and may become slightly yellow or pinkish at a later stage.

The fact that, as Dr. Malden showed, the same organism can be obtained from the intestinal contents of apparently healthy bees is important, and I have also grown it from sealed honey cells from apparently healthy hives. Under these conditions the colonies are generally much fewer in number.

This fact is of interest as bearing on the question of bacillary infection in bees, and also on the problem of the inhibitory effect of honey as a culture medium on the growth of organisms, and their persistence in the spore form.

The same organism has also been cultured on the same media from the compressed pollen removed from the thighs of the honey-bee and from several species of humble bee, and also in one case from honey taken from the nest of *Bombus lapidarius*.

(2) The second point has reference to the life-history of the organism outside the body of the bee and the honey cell.

In 1919 I commenced to investigate pollen from various kinds of flowers frequented and avoided by

bees, and in the case of frequented flowers both before and after the opening of the flower.

It is impossible here to describe in detail the large number of experiments carried out on different kinds of flowers. Speaking generally, the spore-bearing, gram-negative bacillus described above, together with other bacillary, and in some cases coccal, forms, were frequently grown from the pollen of flowers frequented by the honey-bee, various species of wild bee, and some other insects, while colonies were absent or were sparsely grown from unopened flowers and from flowers such as the edible and sweet pea and others which are not visited by bees to the same extent. Pollen from the pine and other wind-fertilised trees gave very few colonies. From the pollen at the bottom of the spathe of an arum (*Arum maculatum*), in which numerous flies were imprisoned, a small coccus grew freely, in addition to the bacillus form.

There can be no doubt that the anthers and pistils of flowers visited by bees and other insects provide the chief sites of implantation and dispersal grounds for organisms which pass a portion of their life-history in the alimentary canal of bees and in stored honey.

Further investigation is necessary to decide what effect, if any, exposure to atmospheric conditions and to pollen and to plant secretions exercise on the growth of these organisms.

It seems probable that many kinds of flowers, especially open flowers, frequented by bees and other insects harbour enormous numbers of organisms, some of which at any rate are pathogenic to bees under certain conditions, and that a further study of the bacterial flora of flowers would shed light on the diseases of bees and other insects, and possibly on some diseases which affect animals and even man.

C. J. BOND.

The Nature of the Electrical Conductivity of Glass.

IN the course of some work on the electrical conductivity of some dielectrics, which was recently described before the Royal Dublin Society and forms the subject of a forthcoming paper in the *Philosophical Magazine*, the question arose as to the possible electrolytic nature of the current in the case of materials such as glass. The following simple experiment, which is, I think, new, seems worthy of record as affording evidence against this view.

A thin glass bulb about 1.8 cm. in diameter was blown at the end of a piece of tubing, the whole being then filled with a dilute neutral solution of calcium chloride containing a little phenolphthalein. The bulb was immersed in a small beaker of tap-water placed on an insulating stand. Electrodes were placed in the upper part of the tube and in the beaker, one being connected to a source maintained at about -8000 volts with the aid of rectifying valves, and the other to earth through a sensitive galvanometer. Thus a known current could be passed through the glass wall of the bulb in either direction. Currents leaking along the exterior surface of the glass tube were prevented from passing through the galvanometer by an earthed strip of tinfoil gummed round the tube as a guard ring.

The bulb and tube were filled the day before the test was made, and in the interval a slight pink-colour had developed, indicating the solution of a little alkali from the glass. The central electrode was first used as anode, so that the glass of the bulb acted as cathode to the solution. If the bulb conducts like a metal, we should expect a red colour to develop on its surface owing to electrolysis of the solution. If, however, the current through the glass

is purely electrolytic, we should expect the alkalinity to be neutralised by the acid radicle ions driven into solution from the glass. The initial current was 8.5 micro-amperes, rising at the end of fifteen minutes to 13 micro-amperes. By this time the solution in contact with the thinner parts of the bulb was a deep pink. The current was then reversed, the initial value being now 16 micro-amperes. After six minutes the solution in contact with the glass was very nearly, if not quite, colourless. If the current in the glass were electrolytic, there can be little doubt that sodium ions would have been driven into solution, thus maintaining the pink colour. The large changes in the conduction current with time and reversal of direction are probably attributable to alteration and polarisation effects in the glass. The thin parts of the bulb carrying most of the current probably represented an area of only 2 or 3 sq. cm., so that the current density was comparatively large, and the potential gradient probably between 1 and 2 megavolts per cm. The evidence of the colour changes, which were repeated several times, is strongly in favour of the view that under such gradients and at air temperature the conduction current is largely, if not entirely, of a non-electrolytic nature.

HORACE H. POOLE.

Royal Dublin Society, June 20.

The Displacement of Spectral Lines by a Gravitational Field.

ACCORDING to the theory of relativity the paths of moving particles or light pulses are geodesics in a four-dimensional Riemann space defined by the metric

$$ds^2 = g_{\mu\nu} dx_\mu dx_\nu.$$

The resulting abstract kinematics is brought into relationship with the facts of experience by the identification of the Gaussian co-ordinates x with the observer's space-time co-ordinates in a Newtonian-Euclidean system. Since the spaces are Euclidean, and since the velocity of light is the same for each observer, it follows that the systems of two different observers are similar, but not necessarily on the same scale.

Consider the field of a single gravitating centre. The metric is given by

$$ds^2 = -\gamma^{-1} dr^2 - r^2 [d\theta^2 + \sin^2 \theta d\phi^2] + \gamma dt^2.$$

Taking the unit of ds as the fundamental unit, and measuring radial and transverse lengths and times at two different points of the Riemann space, we see that throughout the space the local scale is constant for transverse lengths, varies as $\gamma^{\frac{1}{2}}$ for radial lengths and as $\gamma^{-\frac{1}{2}}$ for times. Since the separated space-time systems of different observers are to be similar, it is clear that their scales cannot be obtained by carrying over the scales of the Riemann space at the observers' world-points. Assume that the observer's time-scale bears to the time-scale at his world-point in the Riemann space the ratio $1 : f(r)$. The scales of the Euclidean systems of two different observers then vary inversely as $\gamma^{\frac{1}{2}} f(r)$.

This variation of scale has no effect on the mercury problem or on the deflection of a beam, but it is of fundamental importance in the third crucial phenomenon, the displacement of the spectral lines.

The usual argument shows that

$$\gamma^{\frac{1}{2}}_s dt_s = \gamma^{\frac{1}{2}}_E dt_E,$$

where dt_s , dt_E are measured in the units of the Riemann space. If we transfer to the Euclidean spaces of local observers, the equation becomes

$$\gamma^{\frac{1}{2}}_s f_s dt_s = \gamma^{\frac{1}{2}}_E f_E dt_E.$$

Eddington's argument on p. 129 of "Space, Time, and Gravitation" shows that the time-period as measured in the units of any one observer is transmitted by the radiation. Hence dt_s can be compared with dt_E by observation. The measurement of the displacement of the spectral lines determines the function f .

No displacement is to be expected if $f = \gamma^{-\frac{1}{2}}$. In this case, if dt is a time-interval in the Riemann space, $\gamma^{\frac{1}{2}} dt$ is the corresponding observer's interval, and $\gamma^{\frac{1}{2}} dt$ or ds is propagated by the radiation as suggested in my letter of March 10. H. J. PRIESTLEY.

University of Queensland, Brisbane, May 11.

The Measurement of Single and Successive Short Time-Intervals.

THE following modification of the well-known method of determining small time-intervals by the discharge of an electrical condenser does not appear to be generally used, judging from some inquiries I have had. Though the modification possibly has been published somewhere—the man who can claim originality in these days is fortunate—this letter may be a help to some other workers.

The well-known method to which I refer consists in so arranging the circuit with a condenser and ballistic galvanometer that the former is charged or discharged during the interval. The potential of the condenser is measured before and as soon after the interval as possible by the galvanometer, and the duration of the interval is proportional to the difference of the logarithms of these quantities.

The modification I first used during 1915 in connection with the measurement of the velocity of detonation of explosives consists in connecting one side of the condenser to the string of a Laby string electrometer. The displacement of the string is proportional to the potential of the condenser, so that during an experiment the string falls from one position to another, and the logarithm of the ratio of these displacements from the zero position is proportional to the time. The accuracy of the method can be increased by using a moving plate and photographing the string's position; it can be increased up to the limit imposed by the accuracy within which the condenser capacity and discharging resistance are known by measuring the displacements on the plate with a microscope.

The advantages of this method as compared with the ballistic method are: (a) the procedure and circuit are much simplified, (b) small leakage is of no importance or embarrassment, (c) the whole process being self-recording, the result is available for measurement at any time, and, further, the inertia of the string or its natural period of vibration does not affect the result.

Its disadvantage in common with the ballistic method is the disturbing influence of the inductance of the circuit upon the rate of flow. It may be possible in some applications to calculate this, or to allow for it by calibration.

If a bicycle ball suspended by a long thin wire be allowed to impinge against, and rebound from, the vertical face of an anvil until it comes to rest, the resulting record with its gradually diminishing steps, corresponding to the several durations of contact, affords a pretty example of the application of this method to the measurement of rapidly successive short time-intervals.

ALAN POLLARD.

The Imperial College of Science and Technology, South Kensington, S.W.7, June 14.

Sex-change in the Native Oyster (*O. edulis*).

IT is well known that sex-change in the native oyster (*O. edulis*) occurs at some period of its life. This mollusc apparently always begins life as a male, and may change into a female at the age of one or two years. Very little is, however, known about the change of sex afterwards. In following up the indications given from a general study of breeding (see J. H. Orton, "Sea-temperature, Breeding, and Distribution in Marine Animals," Journal of the Marine Biological Association, vol. xii., July, 1920, pp. 339-66), it seemed certain that an oyster ought to continue breeding in the same season even after becoming white-sick, i.e. after extrusion of ova into the mantle cavity. Thus if a breeding oyster were marked and examined afterwards, it should be possible to find out something about a possible annual change of sex. Accordingly on July 30, 1920, two white-sick oysters were isolated in a tank at Plymouth, and one of them was cut open and examined on August 26, 1920. At the latter date the one examined¹ was found to have its gonad full of wholly ripe sperm-morulae, which disintegrated into separate active and apparently ripe sperm as soon as they were placed in sea-water. Thus a female-functioning oyster had changed into a male-functioning oyster within less than a month. An indication of this change had already been given on July 29, when the gonad of a white-sick oyster—examined at the moment when it contained embryos in the mantle cavity—showed developing sperm-morulae and some actively tailed sperm-morulae.

The occurrence of developing sperm-morulae in microscopic sections of "white-sick" or "black-sick" oysters has, indeed, been already observed by P. P. C. Hoek in a practically unknown and very valuable piece of work on the oyster ("Rapport over de Oorzaken van den achteruitgang in hoedanigheid van de Zeeuwsche oester," p. 175. Uitgegeven Door Het Ministerie van Waterstaat, Handel en Nijverheid, 's Gravenhage).

This year the observations on "white-sick" oysters have been repeated, and all the oysters examined have shown either some sperm-morulae with active tails which disintegrate into separate sperm in sea-water, or developing sperm-morulae. It is seen, therefore, that even at the time an oyster is carrying its own embryos it is changing into a male-functioning form, which will apparently function as a male within a very short time.

An endeavour is being made this summer to carry out on a larger scale the isolation in the sea of oysters of known sex at a particular moment with the view of determining the sex at a later date. It is hoped in this way to investigate also the possible change of an oyster which is male-functioning at the beginning of the breeding season into a female-functioning form at a later period in the same season.

J. H. ORTON.

Marine Biological Laboratory, Plymouth,
June 18.

A New Acoustical Phenomenon.

I HAVE read Dr. Erskine Murray's letter in NATURE of June 16, p. 490, with very great interest, but I think there are two difficulties in the explanation that he has there advanced:—

(1) It is hard to see how or why an aeroplane should emit a series of pairs of double sound impulses; and (2) even if they were emitted, the ear would find it difficult to observe any change in pitch as the distance from the ground was varied; for it is

¹ The other specimen kept for examination this year died at the end of May.

found by experiment that pairs of sound impulses cause a sensation of pitch which is sufficient for the identification of a note as being high or low, but is too indefinite for the appreciation of small differences of wave-length.

I should like to suggest instead that the phenomena observed by Dr. Erskine Murray are due to the presence of a series of stationary sound-waves of various wave-lengths lying parallel to the ground, analogous to the stationary waves of light employed in Lippmann's colour photography. These stationary sound-waves would be produced by reflection at the surface of the ground, the nodes occurring at a distance from the ground inversely proportional to the pitch.

This suggestion fits in with the observed facts (1) that the note heard varies inversely as the height of the observer's ear from the ground; (2) that the effects are best observed when the aeroplane is nearly overhead; (3) that the note heard at a given height varies with the angle of elevation of the aeroplane; and (4) that the surface of the ground must be smooth.

As to the source of these series of notes of different wave-length, it would seem that the turbulent air behind wings, framework, and propeller must be responsible, and the fact that wind passing through a tree can create similar phenomena would seem to confirm this view. With regard to the physiological aspect, it has long been known that double sound impulses do give a crude sensation of pitch, and both theories of hearing have offered suggestions to account for it.

H. HARTRIDGE.

King's College, Cambridge.

DURING the war and since I have often noticed how the apparent pitch of aeroplane noise changes suddenly as an aeroplane travels over the street in which one is standing. I had put this down to reflection, but not on the lines followed by Dr. Erskine Murray in his letter in NATURE of June 16, p. 490. As the problem is of practical importance to such bodies as the War Office and Admiralty, in, for example, recognising aircraft at night or in fogs, it seems worthy of discussion.

If the sound from an aeroplane were a pure tone no amount of reflection could give the sensation of the octave, for two harmonics of equal period combine into an harmonic of the same period. If the sound is impure and has overtones, combination of direct and reflected waves could have the effect only of altering the quality by suppressing some components and reinforcing others. I suggest that Dr. Murray heard the upper tones because of interference between the direct and reflected waves of the lower. That the noise from an aeroplane, though often of musical quality, is not a pure tone is clear. Exhaust noise, in spite of the approximately harmonic motion of the pistons and valves, is not a pure tone. Complications arise from the explosive emission of the gases. Moreover, in addition to the dominant exhaust noise, there are secondary noises from propeller, fuselage, etc.

H. S. ROWELL,

Director of Research, The Research Association of British Motor Manufacturers.
15 Bolton Road, Chiswick, W.4, June 20.

THE acoustical phenomenon described by Dr. Erskine Murray in NATURE of June 16, p. 490, is fully discussed by F. A. Schulze in a paper which appeared in the *Annalen der Physik* in 1916 (vol. xlix., p. 683). References to earlier work on the subject are

given in this paper, and it appears that the effect was observed and described by Savart as early as 1839.

W. B. MORTON.

Queen's University, Belfast, June 21.

An Algebraical Identity.

THE values of the coefficients of Y and Z are given in Prof. Mathew's "Theory of Numbers," p. 218, for the primes 3 to 31. I have calculated the values for the primes 37 to 61 by the method given by Prof. Mathews on p. 216 of his book. My result in the case of $p=37$ agrees with that given in NATURE of June 9, p. 456. The other results are as follows, the coefficients being given to the middle term inclusive when that exists, and in the other case to the first of the pair of terms at the middle:—

- $p=41$; Y, 2, 1, 11, 16, 14, 29, 30, 22, 36, 34, 20;
Z, 1, 1, 2, 4, 3, 4, 6, 4, 4, 6.
- $p=43$; Y, 2, 1, -10, 6, 16, -20, -4, 27, -15, -7, 17;
Z, 1, 0, -2, 2, 2, -4, 1, 3, -3, 1.
- $p=47$; Y, 2, 1, -11, -17, -9, 6, 29, 37, 20,
Z, 1, 1, -1, -3, -4, -3, 1, 4,
-2, -16, -11;
4, 2, -1.
- $p=53$; Y, 2, 1, 14, -6, 8, -14, -4, 19, -12,
Z, 1, 0, 2, -2, 0, 0, -1, 4,
24, -9, -11, 27, -25;
-2, 1, 1, -3, 5.
- $p=59$; Y, 2, 1, -14, 8, 7, -35, 22, 12, -33,
Z, 1, 0, -2, 3, -1, -4, 4, -1,
18, 23, -29, 14, 18, -29;
-4, 3, 1, -4, 4, -1.
- $p=61$; Y, 2, 1, 16, -7, 32, -20, 63, -33, 72,
Z, 1, 0, 3, -2, 6, -3, 9, -6,
-54, 83, -62, 88, -89, 95, -81;
10, -7, 12, -10, 11, -11, 13.

The first case where Legendre's rule fails is $p=41$.
H. C. POCKLINGTON.
5 Well Close Place, Leeds, June 12.

THE result for $p=37$ given in NATURE of June 9, p. 456, was found to conform to Legendre's rule; since this rule fails in the case of $p=61$, it is interesting, as noted by Prof. Mathews, to know if this is the lowest prime for which the rule fails.

I have worked out the case for $p=41$, and find the expression of the 20th degree in x for Y to have the following coefficients:—

$$2 + 1 + 11 + 16 + 14 - 12 - 11 - 19 - 5 - 7 + 20 - 7 - 5 - 19 - 11 - 12 + 14 + 16 + 11 + 1 + 2.$$

And since X is of the 40th degree in x , each coefficient being +1, I find $(Y^2-4X)/41$ of the 38th degree in x with the following coefficients:—

$$1 + 2 + 5 + 8 + 12 + 2 - 12 - 28 - 20 - 14 + 15 + 18 + 19 - 24 - 23 - 36 + 9 + 28 + 72 + 28 + 9 - 36 - 23 - 24 + 19 + 18 + 15 - 14 - 20 - 28 - 12 + 2 + 12 + 8 + 5 + 2 + 1.$$

Putting $x=1$, the sum of these coefficients equals -4, hence $(Y^2-4X)/41$ cannot be a square, so that the rule fails, 41 being the lowest prime for failure.

J. CULLEN, S.J.

Stonyhurst College, June 17.

NO. 2697, VOL. 107]

Artefacts and their Geological Age.

IN NATURE of June 9, p. 458, Mr. J. Reid Moir describes some flint implements found embedded in the surface of the ferruginous "pan" at the base of the cliff near Sheringham, and he bases certain conclusions upon this find. From his description of the occurrence of the flints it seems clear that in this case they may not be of the same age as the "pan," in the upper surface of which they were found embedded. A little while ago, on the beach at Flamborough, a small deposit of ferruginous conglomerate was found, in which there was embedded a typical Neolithic "scraper," as well as several pebbles, and the conglomerate proved to be formed upon a horse-shoe. But no one here assumed that the horse-shoe was Neolithic in date, or that the scraper was made during the past fifty years. More recently, on an excursion to South Ferriby, on the Humber shore, firmly embedded in a ferruginous "pan," immediately at the base of a cliff of Boulder Clay, was a trouser button. It had to be extracted with a hammer. But no Yorkshire geologist is likely to write to NATURE to try to prove that pre-Glacial man in the Humber district wore trousers.

T. SHEPPARD.

The Municipal Museum, Hull, June 27.

Iron Currency-Bars.

IN NATURE of May 19, p. 372, reference is made to iron currency-bars and "early British water-clocks." The discovery of the true nature of the currency-bars is not, as is implied, a recent one, but was made in 1905 by Mr. Reginald Smith (see his paper, Proceedings of the Society of Antiquaries, vol. xx., pp. 179-94). Similarly, the "early British water-clocks" were first authoritatively dealt with by Mr. Smith in 1907 (see his paper, *ibid.*, vol. xxi., pp. 319 sqq.). I understand that Dr. Newton Friend made this quite clear in the paper referred to, and gave his references.

It may be of interest to add that a hoard of currency-bars has recently been found near Winchester, and that the site is now being excavated by a band of volunteers under the direction of Mr. R. W. Hooley, hon. curator of the Winchester Museum. The currency-bars were exhibited at a recent meeting of the Society of Antiquaries.

June 20.

O. G. S. CRAWFORD.

History of the Churn.

IN No. 23 of the *Agricultural Ledger*, issued by the Government of India, and published in July, 1895, there is a *précis* of official correspondence on the Indian churn which begins: "In a letter addressed to the Government of India, Herr B. Martiny, of Berlin, asked for information regarding the Indian Churn. He there announces that he is engaged writing a history of the Churn, and is desirous of obtaining certain particulars regarding 'the old Indian Churn,' of which he furnished a drawing." Has this "History of the Churn" been published in book form, or in the journal or transactions of any society? May I ask readers of NATURE if they can afford any information on the subject? If Herr Martiny addressed similar communications about native or ancient forms of churns to European, American, and Far Eastern Governments, and had his inquiry as fully replied to as it was by the Government of India, there must be pigeon-holed somewhere a mass of interesting data.

R. HEDGER WALLACE.

June 17.

Cosmogony and Stellar Evolution.¹

By J. H. JEANS, SEC.R.S.

II.

The Evolution of Stellar and Planetary Systems.

IN the last lecture we followed up, so far as is permitted by modern theoretical and observational research, the train of ideas on which Laplace had based his nebular hypothesis. Theoretically we found that a shrinking mass of rotating gas ought in time to assume a lenticular shape, after which further shrinkage would result in the ejection of matter from the sharp edge of the lens. It is suggested that the spiral nebulae form instances of this process, the spiral arms being the ejected matter and the central nucleus the remnant of the original rotating mass of gas. The spiral arms are observed to break up into condensations, a process of which a theoretical explanation can readily be given. But on inserting approximate numerical values it is found that each condensation must have a mass comparable with that of a star. In the spiral nebulae we are watching, not the birth of planets, which Laplace attempted to explain by his nebular hypothesis, but the birth of the stars themselves. The process is, in its main outlines, identical with that imagined by Laplace, but is on a more stupendous scale.

The separate stars when set free from the parent nebula are themselves shrinking and rotating masses of gas; they may be thought of as small-scale models of the nebula which gave them birth. We naturally inquire whether the process of evolution of these small-scale models will be the same as in the parent nebulae. The answer is provided by a mere inspection of the physical dimensions of the formulæ which govern the dynamical processes of evolution. It is found that, as regards the central mass of lenticular shape, the small-scale model operates precisely like the bigger mass. Any rotating mass of gas, provided only that it is sufficiently great to hold together under its own gravitation, will in due course assume the lenticular shape and discharge matter from its equator. But as regards the ejected matter, the small-scale model does not work in the same way as the bigger mass. If the matter ejected from a big mass forms a million condensations, the matter yielded from a small mass of one-millionth part of the size will not form a million tiny condensations—it will form only one condensation, and will, moreover, form this one only if other physical conditions are favourable. In actual fact, when regard is had to numerical values, it is found that other physical conditions are not favourable. The matter will be ejected at so slow a rate that each small parcel of gas will simply dissipate into space without any gravitational cohesion at all. Some molecules will probably escape altogether from the gravitational field of the central star, while

the remainder will form merely a scattered atmosphere surrounding the star. For this reason, in addition to others, the conception of Laplace does not appear to be capable of providing an explanation of the genesis of planetary systems.

So far we have studied the way in which a mass of gas would break up under increasing rotation. As a matter of theoretical research it is found that a mass of homogeneous incompressible substance, such as water, would break up in an entirely different fashion. It is further found that there are only these two distinctive ways in which a break-up can occur, so that if a mass the rotation of which is continually increasing does not break up in one way it must break up in the other. As a star, from being a mass of gas of very low density, shrinks into a liquid or plastic mass of density perhaps comparable with that of iron, it passes through a critical point at which there is a sudden swing over from one type of break-up to the other. This critical point occurs when the density of the star has become such that the ordinary gas-laws are substantially departed from throughout the greater part of the star's interior. This density is, however, precisely that which marks the demarcation between giant and dwarf stars. Thus the general conclusion of abstract theory is that a giant star will break up under increasing rotation in the way we have already had under consideration, but that a dwarf star will break up in the same way as a homogeneous incompressible mass, such as a mass of water.

The discovery of the method of break-up in this second case forms one of the most difficult problems of applied mathematics. In spite of the labours of many eminent mathematicians, among whom may be mentioned Maclaurin, Jacobi, Kelvin, Poincaré, and G. H. Darwin, the problem is still far from complete solution. It is found that as the rotation of a homogeneous mass increases the boundary remains of exact spheroidal shape until an eccentricity of 0.8127 is reached, at which the axes are in the ratio of about 12 : 12 : 7. With a further increase of rotation the boundary ceases to be a figure of revolution; it becomes ellipsoidal and retains an exact ellipsoidal shape until the axes are in a ratio of about 23 : 10 : 8. Beyond this it is impossible for the mass to rotate in relative equilibrium at all, and dynamical motion of some kind must ensue. At first a furrow forms round the ellipsoid in a cross-section perpendicular to the longest axis, but the cross-section in which the furrow appears does not divide the figure symmetrically into equal halves. The furrow deepens, and at this stage the problem eludes exact mathematical treatment. It appears highly probable, although it cannot be rigorously proved, that the furrow will continue to deepen until it separates the figure into two unequal masses. On the assumption that this is what

¹ Lectures delivered at King's College on May 17 and 24. Continued from p. 560.

would actually happen we may conjecture that the process we have been describing is that of the fission of a single star into a binary of the familiar type, but the conjecture is beset by many difficulties. To mention one only: if we have truly described the history of a star before fission, the star ought during a moderate part of its life to possess an ellipsoidal figure, and as this rotated the light received from the star ought to vary to an extent which just before fission might amount to 0.9 magnitude. Yet I believe there are only three known stars whose variation of light is such as could possibly be accounted for by an ellipsoidal surface, and even in these cases the interpretation is doubtful. On the other hand, very considerable reassurance is provided by the researches of Russell on multiple stars. After a star has broken into two parts by fission both parts will continue to shrink, so that either or both may in turn again break up, and a triple or quadruple system be formed. Russell finds that in a multiple system which has been formed in this way the distance between the stars formed by subsequent fissions cannot be more than a small fraction, at most about one-fifth, of the distance between the pair generated by the original fission. A mere glance at a catalogue of multiple stars will show that this condition is fulfilled by the majority of observed systems. On account of foreshortening the apparent separations will not always appear to conform to the rule, but Russell has shown, as the result of a careful statistical discussion, that the exceptions agree, both in kind and in number, with what might be expected from foreshortening.

We have now traced out the life-history of a rotating and shrinking mass from beginning to end, from its start as a gaseous mass of very low density, through its assumption of a lenticular shape and its first break-up as a spiral nebula, through its subsequent condensation into separate stars, to their final fissions into binary and multiple systems. The picture has been distressingly incomplete, and it cannot be denied that the story is beset by many difficulties and uncertainties. The mathematical investigation is far from perfect; gaps in theory have frequently been bridged by nothing more substantial than conjecture; in many cases there has been room for grave doubt as to the identification of observed formations with those predicted by theory; in one instance at least a formation predicted by theory, the ellipsoidal star, is practically unknown to the observing astronomer. But, after allowing for all imperfections, we have a tolerably complete knowledge, so far as the main outlines are concerned, of the whole chain of configurations which will be assumed in turn by the rotating shrinking mass of Laplace, and on this chain there does not appear to be any room for the solar system.

Apart from this, there are weighty reasons for thinking that our system has not been formed as the result of a rotational break-up. The angular momentum of a system

remains constant during a process of breaking up, and, as was pointed out by Babinet in 1861, even if the whole angular momentum of the solar system were now concentrated in the sun it would still have less than a quarter of the angular momentum requisite for breaking up at its present density. Except in the improbable event of the solar system, since fission, having been robbed by a passing star of by far the greater part of its angular momentum, its rotation can never have been sufficient to cause a break-up. Clearly there is a case for examining whether some other agency cannot produce a system such as ours.

The sun and moon, as we know, raise tides on our earth the height of which forms only an inappreciable fraction of the earth's radius. If our earth were replaced by a mass of liquid or gas of low density the fraction would be greater, varying inversely as the density of the mass. If the sun and earth were placed much nearer to one another than now the tides would be increased in the ratio of the inverse cube of their distance apart. We can easily imagine conditions under which the heights of the tides would be comparable with the radius of the earth, and here the simple formulæ which the mathematician uses to calculate the heights of terrestrial tides become useless. The general investigation of the succession of shapes which will be assumed by a gaseous or plastic mass as the tidal forces on it continually increase presents a difficult but not altogether intractable problem for the mathematician.

It is found that the tides will be of the general type with which we are familiar on the earth until a certain critical height of tide is reached. This critical height is comparable with half the radius of the mass, being greater or smaller according as the mass is of more or less uniform density. After this critical height has been passed, there is no longer a configuration of equilibrium under the tidal forces. Dynamical motion ensues, and the general nature of this motion will consist in the ejection of two arms or jets of matter, one towards the attracting mass and one, which may be smaller, or may be absent altogether, in the exactly opposite direction. If the tide-generating forces should be suddenly removed at this stage the jets would, of course, fall back into the mass from which they emerged, and this would in time resume its spherical form. But if the tidal forces persist, the jets will continue to be thrown out, and it can be shown that a continuous distribution of density in these jets would be unstable, just in the same way, and for similar reasons, as in the case we previously discussed of the jets thrown out from a rotating mass of gas. Condensations would form in the jets, and ultimately the jet would break up into separate detached masses.

According to the tidal hypothesis of the origin of the solar system, the sun was at some past time subjected to intense tidal forces from a passing star, the sequence of processes we have just described took place, and the emitted jet broke

into fragments which are our present system of planets. From the mathematical investigation on which this hypothesis is based, it appears that the fragments would each be comparable in mass with the original sun if the matter of the sun had been of approximately uniform density, but would be very small by comparison if the sun had been gaseous with high central condensation. The smallness of the masses of the planets in comparison with that of the sun must, therefore, be taken as indicating that the sun was in a gaseous state with high central condensation when the planets were born. The jets of matter thrown out would also be gaseous, but would rapidly cool in the process of ejection, and might soon liquefy or even solidify. It can be shown that the planets which would be formed out of the middle portion of such a jet ought to be much more massive than those formed near the ends, and this may possibly provide an explanation of the comparatively great masses of Jupiter and Saturn. We imagine that the planets at first described orbits under the combined gravitational action of the sun and the passing star by which the cataclysm was caused, but as this star receded they were left revolving, as at present, around the sun. During their earlier motion they may themselves have been broken up by the tidal action of one or both of the big masses present, and such a process may explain the origin of the satellites of the planets.

Such, in its main outlines, is the tidal theory of the genesis of the solar system. So far as can be seen, a vast amount of further mathematical research is needed before it can be either definitely accepted or finally condemned. For myself, I find

it more acceptable than the rotational theory, or any other hypothesis so far offered, of the origin of the solar system. Time does not permit of a discussion of its difficulties, but I may perhaps conclude by stating what seem to me to be its main advantages over the rotational theory.

(i) It escapes the well-known criticism of the rotational theory that the present angular momentum of the solar system is too small to be compatible with a previous rotational break-up, and I do not know of any similar quantitative criticism which can be brought against the tidal theory.

(ii) The solar system is arranged with reference to two planes—the invariable plane of the system, which contains the orbits of the outer planets, and a second plane inclined at about 6° to the former plane, which contains the sun's equator and the orbit of Mercury. A system which had broken up by rotation alone ought to be arranged symmetrically about one plane—the original invariable plane of the system. On the tidal theory the two planes of the solar system are readily explained as being the plane in which the tide-raising star moved past the sun, and the original plane of the sun's rotation.

(iii) Theoretical investigations suggest that there is only one possible end for a rotating system, namely, a binary or multiple star of the type familiar to astronomers, and it is quite certain our system is not of this type. Similar investigations on tidal action suggest that the final end of a system broken up by a tidal cataclysm ought to show many of the features of our present solar system.

The Edinburgh Meeting of the British Association.

By PROF. J. H. ASHWORTH, F.R.S.

LOCAL ARRANGEMENTS.

THE British Association meeting to be held during the week September 7-14 is the fifth meeting of the Association to be held in Edinburgh, the previous meetings having been in 1834, 1850, 1871, and 1892. The last of these, under the presidency of a distinguished son of Edinburgh—Sir Archibald Geikie—was a memorable and successful meeting, and the citizens of Edinburgh are anxious to make the forthcoming meeting no less notable and successful.

As at the last Edinburgh meeting, the reception room, the headquarters of the Association, and the bureau of information will, by permission of H.M. Office of Works, be the Parliament Hall, in which the Scottish Parliament met until the Treaty of Union in 1707. One of the courts adjacent to the hall will be used for the meetings of council and of other administrative committees, and by permission of the Faculty of Advocates rooms in the advocates' library, which is adjacent to Parliament Hall, have been provided for the use of the president and general officers, and the advocates' writing-room has been placed at the disposal of members. The attention of members

is directed to the rule prohibiting smoking in any part of the library and in Parliament Hall; a smoking-room is provided near the reception room. The usual postal (including telegraphic) facilities will be provided in the post office at the entrance to the reception room.

The sectional meetings will be held in the lecture rooms of the University. Six of the sections will meet in the Old College, two in the adjacent departments of natural philosophy and engineering, three sections and the conference of delegates in the University New Buildings (the medical school of the University), and the remaining two in the department of agriculture and forestry, which is within four minutes' walk of the University New Buildings and of the Old College. In connection with several of the sectional meetings, laboratory accommodation will be available for apparatus and specimens which members may desire to exhibit to illustrate their communications to the sections.

Writing-rooms will be provided in the University and in the Unions. The University library in the Old College is to be open so that members may consult books and the principal literary and

scientific journals. The Upper Library contains many objects of literary and scientific interest, including Charles Darwin's class-cards for the lectures which he attended in the University in the years 1825-26, and will be available as a withdrawing-room and additional writing-room. At the Royal Society of Edinburgh, 22 George Street, members may see the principal scientific journals and consult books in the library.

The inaugural meeting and the evening discourses will take place in the Usher Hall, which is an ideal hall for the purpose and has excellent acoustic properties. The hall has spacious corridors, foyers, and cloak-rooms; its interior is well proportioned, and as the grand circle and the gallery above it are constructed on the cantilever principle there are no pillars to obstruct the view of any member of the audience. In this hall also will be given three of the public lectures to citizens. Sir Oliver Lodge will give the opening lecture on "Speech through the Ether, or the Scientific Principles Underlying Wireless Telephony"; Prof. Dendy will lecture on "The Stream of Life"; and Prof. H. J. Fleure on "Countries as Personalities." A special lecture, arranged in collaboration with Section M (Agriculture), for agriculturists will be given in the Natural History Theatre in the Old College of the University on the afternoon of market day (Wednesday, September 7) by Dr. E. J. Russell on "Science and Crop Production."

The Lord Provost, magistrates, and council of the city will give a reception in the Royal Scottish Museum on the Thursday evening; there will be a special graduation ceremonial in the M'Ewan Hall on the Tuesday afternoon, and a garden party immediately afterwards, which the local committee hopes to give in the Zoological Park.

The handbook is not quite on traditional lines; it is not an account of the history, topography, and organisation of the city—this information is accessible elsewhere—but will give an account of the place of Edinburgh in scientific progress. Owing to the present high cost of printing, the book must be kept within the modest limits of about 230 pages, but it is hoped that the authors who are collaborating in its production will be able to give within this compass an adequate account of the main lines in the advancement of science which have been especially associated with Edinburgh.

In order to give members an opportunity of visiting the more important places of historical and general interest round Edinburgh, arrangements are being made for excursions on the Saturday (a) to Loch Lomond, the Trossachs, and Stirling, (b) to Melrose Abbey and the Scott country, and (c) by river to Alloa and Stirling. Shorter excursions have been planned for other days. One of these is to H.M. Dockvard, Rosyth, by kind permission of Admiral Sir Herbert Heath; another is to Dunfermline, where the party will not only be able to inspect the historical abbey and church, but also those interested in sociology will have an opportunity of seeing the work of the Carnegie

trustees; and another is to Linlithgow, where, in addition to historical interests, the party will be able to comprehend, from a commanding point of view, the manner in which the Forth valley has been eroded. Other excursions will be arranged to Swanston (the former home of Robert Louis Stevenson) and Craigmillar Castle, and to the Castle and Chapel of Roslin and to Hawthornden. Those interested in the architecture and picture galleries of the noble houses of Scotland will enjoy the excursion to Dalkeith Palace, the residence of the Duke of Buccleuch, and to the Marquis of Lothian's seat at Newbattle Abbey.

Edinburgh itself has not been forgotten in these arrangements; small parties will be conducted over the "Old Town," especially the "Royal Mile" from the Castle to Holyrood, and the member who avails himself of this opportunity will visit, under the guidance of Prof. Baldwin Brown, Dr. John Harrison, and other experts, the scenes of many of the most moving events in Scottish history.

The city and the surrounding country present many features of interest to the geologist, the biologist, the engineer, the geographer, and the student of the growth of cities. Sectional excursions to the chief points have been planned.

It has often been stated that Edinburgh is not an industrial or commercial city, probably because the reputation which it has enjoyed in other respects has overshadowed this aspect of its activities. In point of fact, however, banking, insurance, and financial interests are strongly represented, and the city has important industries. It has long been celebrated for book and map production, and among other industries are brewing and distilling, shipbuilding, engineering, rubber and chemical works. Arrangements have been made for the sections concerned to visit works representative of these industries.

The first list of hotels and lodgings is now ready, and can be obtained either from the London office, or from the Local Secretaries, The University, Edinburgh. Members should bear in mind that September is a busy month for ordinary tourist traffic in Edinburgh, and that they should therefore make their arrangements early. Some accommodation in hostels, at moderate charges, has been placed at the disposal of the local executive committee. Ladies and gentlemen desiring such accommodation should address their applications to the local secretaries direct before the end of July, by which time it is expected that the available places will be allotted. Preference will be given to scientific workers.

Luncheon and tea will be obtainable at moderate charges in the University Union and the University Women's Union, both of which are adjacent to the sectional meeting-rooms. Gentlemen who are members of the Association will be honorary members of the Union for the week, and ladies who are members will be honorary members of the Women's Union. In each case the honorary members will have the usual privileges, and may introduce one or two guests—ladies or gentlemen.

For the convenience of members arriving on Wednesday evening, September 7, who will have only a short time at their disposal between the time of their arrival and the inaugural meeting, arrangements have been made with the station-masters at the Caledonian and Waverley Stations to establish inquiry offices of the Association at

which membership tickets will be issued. These offices will be opened at 5.30 p.m. for about an hour and a half, but members who anticipate arriving in Edinburgh after 5 p.m. would do well to obtain their tickets by post beforehand so as to avoid any congestion at these temporary offices.

Annual Visitation of the National Physical Laboratory.

THE annual visit to the National Physical Laboratory of the members of the General Board took place on June 28. A large number of guests were present, and were received by Prof. C. S. Sherrington, president of the Royal Society, the chairman of the General Board, and by the director of the laboratory, Sir Joseph Petavel.

An interesting ceremony preceded the visit, when a bas-relief in bronze of the late director, Sir Richard Glazebrook, was presented to the laboratory. The presentation was made by Sir Joseph Thomson, Master of Trinity College, Cambridge, and received on behalf of the laboratory by Prof. Sherrington. The bas-relief is the gift of a large number of friends of the late director, including many past and present members of the General Board.

It is now more than eighteen months since Sir Richard was succeeded by Sir Joseph Petavel, who has carried on very actively the work of his predecessor. Some buildings planned in 1918 are still in process of erection at Teddington, and the work of the laboratory continues to increase in magnitude and importance. The Admiralty has erected a research laboratory within the grounds of the National Physical Laboratory, so that much of its special work may be carried on in close co-operation with it.

As on previous occasions of this kind, the laboratory was thrown open to the visitors, who were given an opportunity of seeing the work that is at present being conducted in the various departments.

A wind tunnel of cross-sectional area 7 ft. by 14 ft. has been completed during the course of the current year, and affords a valuable addition to the equipment of the aerodynamics department. In it a new method for the measurement of rotary derivatives on an aeroplane was demonstrated. Demonstrations in the other tunnels included the measurement of the thrust and torque on an air-screw working in front of a streamline body with the simultaneous measurement of the drag on the body; pressure plotting on an airship hull which was carried out by means of a number of fine steel tubes run longitudinally along the hull in grooves and made flush with wax; and the measurement of lift, drag, and pitching moment on a model aerofoil supported on wires and hung from balances on the roof of the tunnel. Several complete models of aeroplanes were also exhibited.

The engineering department exhibited a machine presented to the laboratory by Mr. C. E. Stro-

meyer for the rapid determination of the fatigue ranges of materials under reversals of shear-stresses. Forced torsional vibrations are given to the specimen under test by means of a rocking arm and flywheel the mass of which can be adjusted. The specimen acts as an elastic constraint between the rocking arm and the flywheel. The usual method of finding the limiting range of stress by endurance tests requires six specimens, and, with the machine running continuously, occupies a week. By the new method the limiting range of stress can be found on a single specimen by two independent means at the same time, and the total time taken for the test varies from five minutes to a quarter of an hour.

In order to investigate the distribution of the air currents produced by the present system of ventilation in the debating chamber of the House of Commons, a wood model (one-eighth full size) has been constructed. Air is supplied to this through ducts of the existing pattern from a fan, the strength and direction of the air currents being investigated by air-speed meters and smoke bands.

An experimental range has been constructed for the study of the motion of 1-in. projectiles in flight. The range is being fitted to carry this out by a series of "jump" cards, and also photographically by the spark method of Prof. Boys.

Other exhibits in this department were the following: Apparatus for studying the effect of pressure and temperature on the production of detonation in a closed explosion vessel; apparatus by means of which the temperature of the lubricant, the load on the bearing, and the speed of the journal can be varied in order to obtain the coefficient of friction of lubricants under varying conditions; apparatus for determining the distribution of frictional resistance over thin plates; and machines for various tension and compression tests.

A new apparatus for the autographic determination of changes in the electrical resistance of alloys with varying temperatures up to and beyond the melting point was exhibited in the metallurgy department. A Morgan electric melting furnace, in which a clay-lined graphitic crucible acted simultaneously as the metal container and heating element, was shown in operation. Demonstrations were given in the experimental rolling-mill, illustrating the effect on the rolling properties of certain non-ferrous alloys of unsuitable mechanical and thermal treatment prior to the rolling operation.

There were also shown in this department exhibits illustrating the macro-structure of castings in various types of moulds, graphite moulds and ingots cast in them; specimens illustrating the behaviour of pure zinc under tensile tests at various temperatures, and new apparatus for the pressure casting of china clay pots for glass melting.

In the heat division of the physics department two novel forms of optical pyrometer were shown, one a precision laboratory standard, and the other a portable instrument suitable for workshop use. Both were of the disappearing filament type in which an image of the hot object is superimposed on the filament of the pyrometer lamp and the brightness matched by varying the current through the lamp. In the standard instrument two lamps are fitted which can be interchanged exactly in the field by a simple transverse motion, and each lamp is provided with fine adjustment in three mutually perpendicular planes. The portable instrument is a self-contained unit which can be carried in the pocket. The telescope, variable rheostat, and ammeter are integral parts of the instrument, and the ammeter is graduated to read temperatures direct.

A variety of hygrometers was shown, as were also appliances for the rapid calibration of these instruments. Considerable modifications have been made in the dew-point apparatus with the view of arranging it in a form suitable for use under cold storage conditions.

In the radiology division was shown a Bragg X-ray spectrometer for the investigation of the crystal structure of materials. The spectrometer is also designed to measure accurately the absorption of X-rays of definite wave-length in different substances. The whole of the high-tension circuit is enclosed in a box covered with lead, so that the measuring instruments are entirely protected from stray radiation. The apparatus employed to investigate the measurement of the intensity of a beam of X-rays with special reference to the barium platinocyanide pastille was shown, and an improved type of tintometer for comparing the tints of pastilles was also demonstrated.

The optical division showed a new method for determining loss of light in optical instruments such as range-finders, periscopes, etc. An optical pyrometer, adapted for use as a surface brightness photometer, is employed to measure the brightness of a suitable source of light and of its image formed by the optical instrument. Two precision methods of goniometry by substitution were demonstrated. In one of these an accuracy of about $1''$ of angle is readily obtained, and in the other, which is suitable only for very accurately worked prisms, it is hoped to attain an accuracy of a small fraction of a second. Among the other exhibits were an improved Lovibond colorimeter, various instruments for measurements of focal lengths and curvatures, and an interference test of the surface of glycerine showing that such a surface, even when left undisturbed for many weeks, does not become flat.

The metrology department demonstrated optical tests on the flat faces of end gauges for determining flatness, parallelism, and squareness to axis of gauge. An optical proof plane is held opposite one end of the gauge and rotated about two perpendicular axes lying in its own plane. The appearance of the interference fringes formed between the proof plane and the end face of the gauge gives an indication of the state of perfection of the flatness of the face. By observing any change in the interference pattern as the gauge rotates about its own axis, the test of squareness of the face to the axis is obtained. The method of testing the flatness of a large surface consists essentially of the comparison of the surface to be tested with the horizontal free surface of mercury.

Other exhibits in this department were a standard leading screw lathe, line standards, and a method of determining the length of an end gauge with reference to a standard scale.

In the William Froude national tank experiments were conducted in connection with the manoeuvring power of ships. The experiments may be divided into two main sections, the action of the water on the rudder of a ship, which will vary with ship form features, type of rudder, etc., and the action of the rudder forces on the ship as a whole. Measurements are taken of the water moments on the rudder stock and on a second axis of the rudder, with and without propeller working, and of the initial torque on the hull, with the rudder over to any angle.

The photometry division of the electricity department showed a method of determining the distribution of light from the lenses used in ships' navigation lights. Apparatus was also shown for the polar distribution of light. This is of the ordinary two-mirror form, but with special arrangements for the ready rotation of the mirror, the holders for which rotate on ball bearings. Another exhibit was the integrating sphere photometer. This is an Ulbricht sphere of 1 metre internal diameter, which has been designed for the measurement of lamps of ordinary commercial sizes.

The exhibits in the wireless division included closed-coil wireless direction-finding systems. The particular coil exhibited was designed and constructed at the laboratory, and is believed to be the first direction-finding coil system ever employed on aircraft, having been used for some experiments at Cranwell in 1916. A complete wireless direction-finding station was shown in operation, the set exhibited being identical with those installed by the Radio Research Board at various universities in the British Isles for experimental investigations.

There were other numerous interesting exhibits in this department, such as the Schuster magnetometer; transformers and ovens for experiments on cables at high temperature and high potential; and methods of measuring the heating of cables buried in the ground under various conditions.

Scientific Publications for Russia.

IT will be remembered that when Mr. H. G. Wells visited Petrograd in November last he found that the remnant of Russian literary and scientific workers who had survived the revolution had been brought together by the Soviet Government and housed in two institutions in Petrograd. There the scientific workers were carrying on their researches as best they could in the face of great privations owing to lack of food and clothing. What they felt even more keenly was that they were cut off from men of science outside Russia and were unable to obtain scientific literature or apparatus.

A committee was therefore formed in December under the title "The British Committee for Aiding Men of Letters and Science in Russia" to obtain some of the chief publications required. An appeal, which was published in NATURE of January 6, p. 598, was made for funds to help the project forward.

Prof. Oldenburg, permanent secretary of the Petrograd Academy of Sciences, was communicated with, and was able to provide the committee with a list of the works which were urgently required. This list contained a number of works issued by British and other publishers, together with the publications of many learned societies. The committee then communicated with the leading scientific societies which had sent their publications into Russia before the revolution, and several entrusted their publications to the com-

mittee for transmission to the House of Science in Petrograd. A number of British publishers presented volumes for the same purpose, and help was also given by universities and publishers in the United States. In addition the committee has acquired books by purchase and by gift from private individuals.

Naturally very careful inquiries were made from both the British and the Soviet authorities as to the prospect of the books reaching the men for whom they were intended. Every assurance was given that delivery would not be interfered with, and several cases of books were accordingly dispatched. It was feared that in spite of their assurances the Soviet authorities would confiscate the literature, and it is therefore gratifying to learn that an acknowledgment of their safe arrival has been received from Prof. Oldenburg. A book-list which was also dispatched has been returned signed by several notable Russian men of science, so there is now little doubt that the books were received by those for whom they were intended.

It is thought that fear of miscarriage of these books has prevented the co-operation of many well-wishers of the scheme. Now that this fear is allayed it is hoped that further subscriptions and donations will be forwarded to the treasurer of the committee, Dr. C. Hagberg Wright, the London Library, St. James's Square, S.W.1.

Friendship.

(To T. H. R.)

WERE life an empty bubble blown by chance
To glitter, mount, and burst beyond repair;
Were mind delusion, fancies rich and rare
Mere exhalations, firefly effluence;

Or should this mood be but the spirit's trance,
And one enduring Whole his Being share
By ordered gradients up the thronal stair
From atom fires to soulful radiance;

Be all philosophy beyond our ken
And nothing certain,—yet, as star draws star,
As bubbles meet and cling, electrons blend,
There sings a joy when friend meets parted
friend,

Time's limitations yield, and past the bar
Life's transcendental portals ope again.

WALTER GARSTANG.

June 19, 1921.

Conference of American and British Engineers.

THE four leading engineering societies of the United States of America recently combined to form the United Engineering Society, to promote the more general interests of the profession. Fifteen delegates from these societies have come to London, partly to bring a greeting and message of friendship to British societies, and partly to present the John Fritz medal, the greatest honour the American societies can confer, to Sir Robert A. Hadfield, Bart.

The chairman of the delegation is Mr. Ambrose Swasey, who is not only a constructor of the finest machine-tools, but also the builder of the

great telescopes at Mount Hamilton, at the Naval Observatory, Washington, and at the Yerkes Observatory, Wisconsin. He also built the 72-in. reflecting telescope of the Dominion Astronomical Society at Victoria (B.C.). Among the delegates are Col. A. S. Dwight (American Institute of Mining and Metallurgy), Mr. C. F. Rand (secretary of the board which awarded the medal), Dr. Ira N. Hollis (American Society of Mechanical Engineers and president of the Worcester (Mass.) Polytechnic Institute), Mr. C. T. Main (American Society of Mechanical Engineers), Dr. F. B. Jewett (American Society of Electrical

Engineers and chief engineer of the Western Electric Co., of Chicago), Mr. I. R. Freeman (American Society of Mechanical Engineers), and other distinguished engineers.

Advantage was taken of the opening of conferences at the Institution of Civil Engineers on June 29 to receive the delegates. Mr. John A. Brodie, president, welcomed the American engineers, and suggested the formation of an engineering committee to investigate the question of stoppages in production and methods for the judicial treatment of matters in dispute.

Dr. Ira N. Hollis then in an eloquent address conveyed the friendly wishes of American engineers. Those present, he said, belonged to a profession which had, through its inventions and its work, laid the foundations on which civilisation had been built. Engineers stood side by side on the battlefield, and American engineers took pride in the share of their British colleagues towards the victory for truth and justice when much that had been gained by centuries of struggle seemed likely to be lost and the freedom of the world was in danger. The great issue of the twentieth century was the right of every man to earn a living and develop his possibilities without being controlled by powerful combinations of any kind. No family and no line of families should find the door of opportunity shut. He looked forward to the day when not only American engineers, but all engineers would be banded together for the welfare of the world. He was sure that Darwin would turn in his grave if he could but know how evolution had been twisted by the Teutonic mind into glorifying war as a developer of the race. Dr. Hollis then read the address from the American societies. It expressed the feeling of brotherhood and a sense of the loss in the death of so many British colleagues on the battlefield. The American engineers rejoice to have been permitted to share with other engineers the victory over a war spirit dangerous to the rights and happiness of men.

The president of the Institution of Civil Engineers accepted the address, and Dr. W. C. Unwin, in reply to Dr. Hollis, said that the delegation which had come with so gracious a message were missionaries of kindness. British engineers recognised the great advances in engineering science in America, and admired immensely the great works of construction there carried out. In the war the United States had come to our assistance with its great manufacturing resources. The supplies of steel it sent were of immense value, and not less valuable were the remarkable machine-tools for which the United States was famous. We had been linked in war, and would not fail in trying to stabilise peace; so far as one generation could, we must endeavour to make such a war impossible in the future.

Lord Bryce laid stress on the international character of the engineering profession. Men of

science belonged to the world and worked for the world, and were welcomed by their colleagues wherever they went.

Mr. Ambrose Swasey then presented the John Fritz medal to Sir Robert Hadfield. Mr. Swasey said that the delegation represented the four American national societies of civil, mining and metallurgical, mechanical, and electrical engineers. The John Fritz gold medal was instituted by the friends of the great American engineer, John Fritz, for his achievements in industrial science, and was awarded annually. Lord Kelvin and Sir William White had both received the medal previously in honour of their achievements. The award this year had been made to another distinguished engineer in Great Britain, Sir Robert Hadfield, in recognition of his scientific attainments and his eminence in metallurgical research, and for the distinguished service he had rendered in the invention and perfection of manganese steel.

In his reply Sir Robert Hadfield said that he was deeply moved by the demonstration of goodwill shown by the great honour conferred upon him by the American engineering profession. In the official announcement of the award he had been told that the distinction should be accepted by him not only for himself personally, but also, through him, as an expression to the British nation, on the part of American engineers, of their high regard and appreciation of the work of the British engineer in the war for the preservation of civilisation. That message was indeed cheering, and was a harbinger of good for the future of the race. Sir Robert thanked the delegation for its courtesy in coming to this country, when he ought to have gone to America, but considered that his inability to do so was a blessing in disguise, as evidenced by the great gathering that day. It was a great pleasure to have present their American friends, because it was in America that manganese steel first received encouragement on a large scale. It was also appropriate that the award should be made in the hall of the Institution of Civil Engineers, since his first papers in 1888, giving account of the invention of manganese steel, had been presented in the hall of the old building of the institution.

Our readers will be interested to know that Sir Robert Hadfield has had printed an address of thanks. This address contains much interesting information respecting eminent engineers, with portraits, on both sides of the Atlantic, together with illustrated notes on the founding and work of the Royal Society.

The work of the conference was carried out in seven sections:—(1) Railways, roads, bridges, and tunnels. (2) Harbours, docks, rivers, and canals. (3) Machinery. (4) Mining and metallurgical processes. (5) Shipbuilding. (6) Waterworks, sewerage, and gasworks. (7) Electricity works and power transmission. Some fifty-five papers of notes were introduced and discussed. Reference to a few of these only can be made here.

Mr. Alexander Ross laid down as propositions for discussion that on our railways the 6-ft. space should be widened to 7 ft.; if there are more than two lines of rails, the space between the original pair of rails and additional rails should not be less than 11 ft. 6 in. No overhead structure should have less clear headway than 15 ft. 6 in. above the top surface of the rails. No structure higher than 2 ft. 6 in. above rail-level should be nearer to the edge of the nearest rail than 5 ft.

Mr. Oswald G. C. Drury described the use of the Ingersoll cement-gun in carrying out repairs on the Cliftonville tunnel. The next few months will show the value of this method of grouting, but Mr. Drury thinks that the method is a practical success from the point of view of stability and speed, although the commercial value has yet to be thoroughly tested.

Mr. William W. Grierson gave particulars of the now extensive use of reinforced concrete on British railways. The use of fence-posts of this material is largely on the increase. Various designs of reinforced concrete sleepers have been experimented with, but none are successful under heavy and frequent traffic at high speeds.

The important question of the best way of protecting reinforced concrete from marine deterioration was introduced by Mr. Francis E. Wentworth-Sheilds. Our experience of this material for maritime structures now extends over twenty years, and there have been several failures. These are owing to: (a) The concrete has become softened by the chemical action of the sea-water. (b) The concrete has scaled off owing to the action of frost. (c) The concrete has worn off by attrition by travelling shingle and stones. (d) The concrete has split and cracked by the rusting of the enclosed steel and its consequent increase in volume. The last is the most common type of failure.

Mr. George E. W. Cruttwell presented an interesting note on the use of a model for investigating the movements in the River Thames between Teddington and Shoeburyness. The first model of this kind was employed by Prof. Osborne Reynolds, and the present improved model gave very good results. Mr. Cruttwell suggests that the greater part of the model and the whole of the working apparatus could be adapted for experimenting with other estuaries at a trifling cost, and that it would be most advantageous to the engineering profession if the National Physical Laboratory or some similar institution could install the necessary apparatus, which could then be adapted to suit any particular case. The cost of the Thames model was about 300*l.*, and a moderate fee would cover the cost of the necessary adaptations and investigations.

In dealing with the bearing power of soils Mr.

Arthur L. Bell made reference to the various theories of earth-pressure. Advance in earthwork problems had been, in the main, due to individual experiment and speculation, and Mr. Bell considers that the best hope for the future lies in the encouragement and aid of individual inquiry. Engineers seek a sound and preferably simple theory which can be successfully applied, not to one only, but to all the multitudinous varieties and conditions of soil.

The influence of the automatic and semi-automatic machine on the skill and resourcefulness of the mechanic and operator was the subject of a note contributed by Mr. Arthur H. Hall. Such machines are set ready for work by a skilled mechanic and operated by another person. Mr. Hall considers that the designer has precluded the operator from the display of resource, but that a reasonable amount of skill is required. The mechanic must display great resource, the amount varying with the degree of responsibility allotted to him by the management in the matter of design and lay-out of tools. His skill in making these is of the kind usually expected of a highly trained workman, but in setting them up he may exhibit qualities not readily capable of comparison with those required in other work.

Sir Robert Hadfield presided in the mining and metallurgical section, and said that the world was literally hungering at the present time for a hundred million tons of iron and steel. Iron was the standard of all modern comfort, and to economise in its use meant to reduce our civilisation. Take away this metal, and the world would relapse into almost a state of barbarism.

Dr. John W. Evans introduced the subject of the employment of water-power in the development of the mineral industry. During the war there was a remarkable advance in Sweden, where the number of electric furnaces increased from eight in 1914 to twenty-eight in 1918, and the output of pig-iron obtained from them increased from 5786 tons in 1911 to 75,684 tons in 1918. The day is at hand when electrolytic methods will enable metals to be extracted with commercial success from ores which are too poor to be dealt with by smelting operations.

Fabricated ships were dealt with in notes by Mr. Maurice E. Denny and Mr. John C. Telford. These notes consider the problem from the labour-saving point of view. The premier requirements to make fabricated ship construction a success are several vessels all alike, standardised so as to make the detail reproduce itself many times over; also (a) careful work in the drawing office and template loft, (b) accurate workmanship in the shops, (c) close inspection, and (d) the provision of ample means for checking the several parts with jigs and templates as the work proceeds.

Obituary.

ABBOTT H. THAYER.

ALL naturalists, and especially those of the English-speaking world, will learn with great regret of the death of the distinguished and original artist-naturalist, Mr. Abbott H. Thayer, announced in *Science* for June 10. Many of us will lament the loss of a dear friend who sympathised with our sorrows and difficulties as if he had been one of us, and, long before his country joined the struggle on behalf of freedom and civilisation, came to England in the hope that he could induce the authorities to accept his help in the methods of "camouflage" by land and sea.

Thayer's great fundamental discovery was of course the interpretation of the white undersides of animals as the elimination of shadow by counter-shading. I once asked him how he came to think of it, and his answer showed that the discovery sprang from the artist side of his nature. He observed, he said, that animals in the wild state were elusive and ghost-like, and that when the artist wished to paint them so that they might be easily seen in the picture he had to employ an unnatural illumination or to represent them silhouetted against the sky. He was thus led to investigate, and finally to discover, the cause of

this great factor in protective resemblance. The artist in him first saw the well-nigh ever-present effects, and then found the cause, which, indeed, had been suggested some years earlier by one who failed to recognise its far-reaching importance and thus missed a great discovery.

Thayer's artistic temperament also led him to resent any limits to the application of his principles and to attempt to explain by them all examples of warning and mimetic coloration. When the review of the first edition of his work, "Concealing Coloration in the Animal Kingdom," appeared in NATURE (1910), it was many months

before he could bring himself to read it. Yet when at length he made the effort he was pleased, and wrote a kindly letter to the reviewer.

Science needs the help of such men whose approach is from a widely different point of view, and science owes much to Thayer and will gratefully preserve his memory. E. B. P.

THE death is announced, at eighty-three years of age, of PROF. VIKTOR VON LANG, formerly professor of physics at Vienna University and a past-president of the Austrian Academy of Sciences.

Notes.

At the meeting of the Royal Society of Edinburgh held on Monday, July 4, the following were elected honorary fellows:—*British Honorary Fellows*: William Henry Perkin, Sir Ronald Ross, Sir Ernest Rutherford, and Sir Jethro J. H. Teall. *Foreign Honorary Fellows*: Reginald Aldworth Daly (Cambridge, Mass.), Johan Hjort (Bergen), Charles Louis Alphonse Laveran (Paris), Heike Kamerlingh Onnes (Leyden), and Salvatore Pincherle (Bologna).

THROUGH the generosity of the Rev. Dr. Winifrith, of Hythe, a memorial tablet has just been placed on the house—31 High Street—in that town in which Sir Francis Pettit Smith was born. Of all the numerous inventors of screw propellers, Smith, perhaps, is the best known. Born in 1808, he began life as a farmer, but was always given to mechanical invention. His first patent for a screw propeller was dated May 31, 1836, and his screw was first fitted in the *Francis Smith*, and then in the epoch-making vessel s.s. *Archimedes*. Brunel was among the converts to Smith's ideas, and he discarded paddle wheels for the *Great Britain*, which, in 1845, was the first screw-driven vessel to steam across the Atlantic. The same year the screw sloop, H.M.S. *Rattler*, was added to the Navy List, and for some years afterwards Smith was employed by the Admiralty installing his screws in the converted line of battleships, many of which were in service in the Crimean War. He made little money out of his invention, but the shipbuilding and marine engineering world in 1858 raised a subscription of nearly 3000*l.* for him, and gave him the fine silver salver and jug which are in the Science Museum. During the latter part of his life—he died in 1874—Smith was curator of the Patent Office Museum.

GLASGOW UNIVERSITY, in accordance with the policy of establishing separate buildings for its scientific departments which was initiated by the erection of the Botanical Institute, has signed a contract for a zoological building, which has been planned by Prof. J. Graham Kerr and the architects, Messrs. John Burnet, Son, and Dick. The building will be near the new medical department on part of the former athletic ground. It will cover 3000 square yards, and include a lecture-room with accommodation for 260 students, an elementary laboratory with tables for

150 students, and special laboratories for advanced work, protozoology, research, and experimental zoology. There will be a large museum, to which will be transferred the zoological collections now in the Hunterian Museum, leaving space there for extensions of the departments of geology and archæology. Above the museum will be two large tank-rooms for living marine specimens, and land animals will be accommodated in a courtyard. A room will be provided for the departmental library and a suite of rooms for the staff. The building is estimated to cost 130,000*l.*, and it is hoped that the lecture-rooms and laboratories will be ready for the winter session of 1922-23. Under Prof. Graham Kerr the zoological department of Glasgow University has achieved great success, and it will now have a building worthy of its important work.

THE attention of French archæologists is now being devoted to an important series of discoveries in tombs at Martres-de-Veyre, Auvergne, which, according to M. Salomon Reinach, "are in an unprecedented state of preservation. In my experience there has never been found anywhere so many articles of leather, of wool, and of other stuffs in such good condition after being buried in graves for 1800 years." Near this necropolis is the famous fortress of Gergovia, where Vercingetorix won some temporary success against Cæsar, practically the last revolt against the Romans. The extraordinary state of preservation of the bodies found in the six tombs now brought to light calls for explanation. The body of a Gallo-Roman woman interred in a stone coffin lay as if life had only just departed, but on being exposed to the air it suddenly crumbled into dust. Ornaments and articles of the toilet were found in great abundance, while a jar of honey, vases, leather sandals, and linen and woollen fabrics were among the furniture of the graves. The articles discovered have been deposited in the museum at Clermont-Ferrand, the capital of the Department of Puy-de-Dôme, the Paris museums having wisely decided not to enter into competition with the local collections. It may be hoped that careful excavation in this district will lead to further important results.

IN the James Forrest lecture delivered on June 28 Sir George Beilby presented a review of the world's fuel situation. Coal, brown coal, peat, oil from wells

and from oil-shales, and alcohol are discussed, and the conclusion is reached that coal is likely to remain for a long time the world's chief source of fuel. Brown coal and peat are dismissed on account of the vast areas of land which are required in order to obtain adequate supplies and prepare them for use. Oil amounts to 7 per cent. of the fuel output of the world, and nearly nine-tenths of this quantity is controlled by the United States. The conclusion of the chief petroleum technologist of the U.S. Bureau of Mines, that after twenty years at the present rate of consumption the output will decline, is therefore of importance, though there is reason to expect production from oilfields in other parts of the world which have not as yet been tapped. The only method available in Great Britain for the commercial preparation of alcohol is by the fermentation of vegetable materials containing starch or sugar. Even this method, however, is not economically possible owing to the lack of available land for the cultivation of the crops required, the high cost of cultivation, harvesting, and manufacture, and the fact that the most suitable raw materials are also important foodstuffs. Some alcohol may be produced from molasses in countries where the sugarcane is grown, but it is unlikely that more than is required for local use can be made. Falling back on coal, it is suggested that more efficient use may be secured by careful sorting at the pitheads, by improvements in boiler-firing, and by preliminary carbonisation at high or low temperatures.

THE *Daily Chronicle* announces that Prof. Edouard Branly, of Paris; is to receive this year's Nobel prize for physics.

It is stated in the *Times* that the directors of the Nobel Foundation have submitted a proposal to the Swedish Government for increasing the value of the Nobel prizes by transferring a sum of about 100,000l. from their building fund.

WE learn from the *Times* that the French Société de Géographie is celebrating its centenary. There was a reception for delegates at the house of Prince Roland Bonaparte, president of the society, on Tuesday night, and in the afternoon M. Millerand, President of the French Republic, presided at the opening meeting of the celebration, a gathering at which explorers and geographers from various parts of the world were present.

THE sixty-sixth annual exhibition of the Royal Photographic Society of Great Britain will be held on September 19–October 29 at 35 Russell Square, W.C.1. There will be three sections, devoted respectively to pictorial photographs, to colour transparencies and colour prints, and to scientific and technical exhibits, natural history photographs, and lantern and stereoscopic slides.

A CIRCULAR has been issued by the Meteorological Office with reference to the summer service of forecasts of weather for agricultural purposes. Notification is given by telegraph of occasions when a spell of fair settled weather of several days' duration is anticipated. The progress of meteorological events and warning of the break-up of the fine spell are sent to the recipient as early as possible. The fee beyond the

telegraphic charge is extremely small. Notification is also given of special conditions, such as spells of frost, ground-frost, smooth sea, etc.

By invitation of Messrs. Sutton and Sons and of Prof. Percival, a field-meeting of the Association of Economic Biologists will be held at Reading on Thursday, July 14. Visits will be paid to the Royal Seed Establishment, the Trial Grounds, and the College Farm and Agricultural Botanic Gardens. It is requested that all who propose to attend the meeting will notify Mr. W. B. Brierley, the Rothamsted Experimental Station, Harpenden, not later than Monday, July 11.

BEGINNING on June 15, the wireless telegraph station at Poldhu is sending weather messages broadcast twice daily for the benefit of navigators. Each message will consist of a forecast for the western seaboard of the British Isles and the actual observations taken at Stornoway, Blacksod, Holyhead, Scilly, and Dungeness at 0700 G.M.T. (civil) and 1800 G.M.T. (civil) respectively. The messages will be sent out at 0930 G.M.T. (civil) and 2130 G.M.T. (civil). Details of the scheme are given on the Meteorological Chart of the North Atlantic Ocean for July.

A NORWEGIAN scientific expedition is leaving this summer for the island of Jan Mayen, in the Greenland Sea. According to *La Géographie* for May, the expedition will consist of six or seven persons, under the command of Mr. Ekerold. The main object is meteorological research, and it is hoped that the work of the party will lead to the foundation of a permanent observatory on Jan Mayen. A wireless telegraph station is to be erected. The last serious effort in meteorological research at Jan Mayen was in 1882–83, when an Austrian station, as part of the international scheme, was maintained on that island.

WE are glad to learn that Lyme Regis, a town classic in geology, is now provided with a public collection of local fossils. Three years ago a small museum building was bequeathed to the corporation by the late Mr. Philpot, and it is now occupied by the geological collection and library of Dr. Wyatt Wingrave, who has lately become a resident of the town, and has devoted much labour to making the museum of educational value. The fossils are arranged in stratigraphical order, with appropriate explanatory labels and diagrams, and Dr. Wingrave gives a weekly demonstration which is well attended and much appreciated.

H.R.H. THE PRINCE OF WALES has accepted the office of vice-patron of the Royal Society of Arts. The following medals have been awarded for papers read before the society during the past session:—Major-Gen. Lord Lovat, "Forestry"; Col. R. J. Sturdy, "The Breeding of Sheep, Llamas, and Alpacas in Peru, with a View to Supplying Improved Raw Material to the Textile Trades"; A. F. Baillie, "Oil-burning Methods in Various Parts of the World"; Dr. W. Cramp, "Pneumatic Elevators in Theory and Practice"; Sir Kenneth Weldon Goadby, "Immunity and Industrial Disease"; W. Raitt,

"Paper-pulp Supplies from India"; Sir George Curtis, "The Development of Bombay"; A. H. Ashbolt, "Industrial Development in Australia during and after the War"; and Sir Charles H. Bedford, "Industrial (including Power) Alcohol."

We have received a communication from Mr. W. J. Lewis Abbott in reference to a statement made in the course of the discussion on Mr. Reid Moir's paper on "An Early Chellean Palæolithic Workshop-site at Cromer," which took place at a meeting of the Royal Anthropological Institute (see NATURE of May 26, p. 406). In that discussion one of the speakers stated that the flints in question were "no more than a foreshore accumulation of flints which differed in no way from other flints found on the foreshore along the whole East and South Coast." Mr. Abbott directs attention to the distinctive coloration of the Cromer specimens, of which there are three types: (1) Those which are porcellanised or whitened; (2) those exhibiting the characteristic orange-red colour; and (3) specimens which have been changed from white to black, the white porcellanous condition being present under the black. He maintains that this peculiar feature cannot be due to beach action. In regard to the evidence for dating the finds, Mr. Abbott states that he has discovered specimens in association with remains of *Elephas (?) meridionalis*, in one case *in situ*. The question of the coloration of the Cromer flints is one of considerable difficulty, for which no satisfactory explanation has yet been offered, while in regard to the stratigraphical evidence, it is clear that a systematic investigation at the base of the Forest Bed series on this site, as suggested by Mr. Reid Moir himself, is extremely desirable.

"SUN-SPOTS and Weather" is the title of an article in the *Meteorological Magazine* for June, dealt with by Mr. C. E. P. Brooks. It is mentioned that the subject is again opened by the recent development of an unusually large sun-spot with associated electrical and magnetic phenomena. A bibliographical list is given of authorities on the subject, and the author states that although the literature is enormous, we are still far from definite conclusions. So long ago as 1651 Riccioli claimed that temperature rose with decreasing sun-spots and *vice versa*. The discovery in 1844 of an eleven-year periodicity in spots caused a renewal of the study, and in 1873 results of an investigation by Köppen were published showing that temperature reaches a maximum shortly before spot minimum and a minimum about spot maximum. A positive correlation of sun-spots with rainfall has been found in the tropics, and also with elements such as lake levels which depend on rainfall. A close parallelism has been demonstrated between sun-spots and tropical hurricanes, and the author states that the study of eleven years' wind data in the Falkland Islands suggests that at spot maximum the storminess is greatest.

POPOCATAPETL exhibited only slight activity in the way of fumaroles and solfataras in the two centuries that followed the eruption of 1720. In 1920, however, small eruption-clouds became visible from Mexico City, and Mr. Paul Waitz has described an ascent

made by him in October last (*Amer. Journ. Sci.*, vol. cci., p. 81, 1921). Considerable outbursts of steam were then taking place from the crater, accompanied by a small quantity of stones and ashes, and

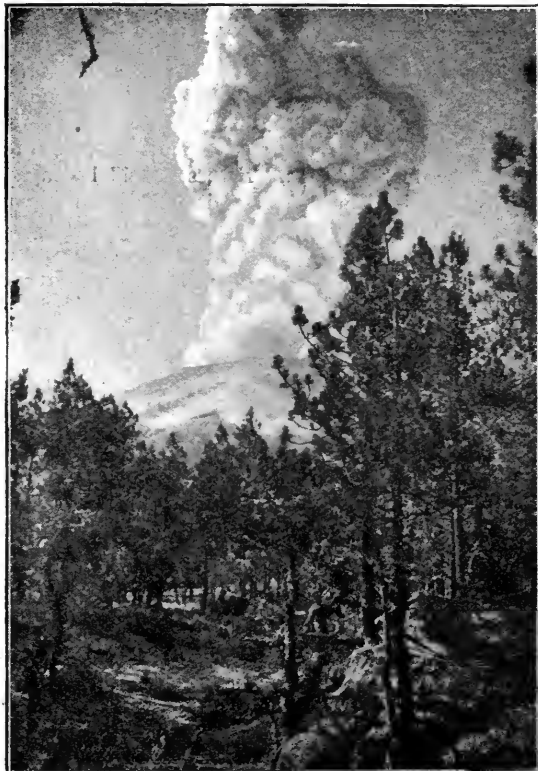

FIG. 1.—Cauliflower clouds of a steam eruption of Popocatepetl, October 12, 1920. From the *American Journal of Science*, January, 1921.

it appears that the old central plug of 1720, formerly concealed by a lakelet, is now being pushed upward in the crater-floor. Two fine photographs accompany the paper, one of which is here reproduced.

The current issue of the Journal of the Institute of Petroleum Technologists contains, among other papers, some interesting details by Capt. Paul H. Mangin on boring in Palestine in search of water during the progress of military operations from 1917 to 1919. Although both drilling *personnel* and equipment were initially somewhat crude, very creditable results were achieved, no less than a gross total of 5500 ft. being drilled in the putting down of forty-five wells, from which something like 1,500,000 gallons of water per day were obtained. The area in which the wells were sunk borders the coast between the Egyptian frontier (at Rafah) and Mount Carmel on the north. The chief difficulties encountered apart from those mentioned were the loose nature of the sands penetrated and the prevention of their caving in and blocking up the hole. Five types of drilling rig were used, but the best results were obtained by the hydraulic percussion system with mud flush. An important feature of the work was the excellent log kept of each well, which, together with samples of the formations met with, have been preserved for future reference. Although having no

direct bearing on oil, the results of this work are of great interest to petroleum technologists generally, and also presumably to those who are optimistic enough to believe in Palestine as a potential oilfield.

PART 2 of vol. xxii. of the Transactions of the Optical Society contains the address of the president, Mr. R. S. Whipple, which deals with the design and construction of scientific instruments. Such instruments must have as their principal characteristic the property of giving results of a constant prescribed accuracy, and all the important sources of inaccuracy in them should be known. Errors should be capable of elimination by adjustment of the instruments themselves, or if elimination is not possible, they should be measurable by the instruments. The design of an instrument involves the consideration of the magnitudes of the errors to which it may be liable, and it is this preliminary survey which prevents the cost of manufacture being increased by the removal of insignificant errors while others more serious are allowed to remain. Examples of well-designed slides, rotating parts, screws, and nuts are given, and it is clearly shown why they are good. A nut of unsound design used on gun clinometers which the authorities preferred to one designed on geometrical principles is also shown. The address will repay reading by all instrument-makers who wish to meet the new demand for scientific instruments in industry.

THE fourth report of the Conjoint Board of Scientific Societies shows that the board has received evidence that scientific investigation is being seriously hampered by the heavy cost involved in the publication of results. An exceptional number of papers is being communicated to the scientific societies, including many held up during the war, while the resources of the societies, which have not increased, are insufficient at present prices to publish even the normal pre-war number. The country is thus in danger of being seriously handicapped at a time when the rehabilitation of industry is in most serious need of scientific assistance. Much of the report is occupied with an abstract of the third report of the Committee on the Water-Power Resources of the Empire. It is shown that too little is being done to ascertain the total resources or to secure uniformity in investigation and record. It is urged that steps should be taken to convene an Imperial Water-Power Conference in London, at which the various Dominions and Dependencies of the Empire should be represented. The outcome of such a conference might well be the creation of an Imperial Water-Power Board, with extensive powers to carry out a comprehensive policy for stimulating, co-ordinating, and, where necessary, assisting development throughout the Empire. The board has also dealt with questions relating to the formation of national research committees in connection with the International Research Council formed in 1919, with the collection of scientific data in the former German colonies, and with instruction in technical optics. The research on glues and other adhesives initiated by the board as a war measure, at the instance of the Air Ministry, has now been taken over by the Department of Scientific and Industrial Research.

THE trials of the motor vessel *Yngaren* were run successfully off the Tyne on Tuesday, June 14, and an account appears in *Engineering* for June 24. The main engine of this vessel is of the opposed piston type, with four cylinders 22.8 in. diameter by twice 45.6 in. stroke. When running at its normal speed of 77 revs. per min. the engine develops 3000 indicated horse-power (2700 brake horse-power), or 675 brake horse-power per cylinder, and is therefore the highest-powered Diesel cylinder as yet installed in any ship. The ship is also notable on account of having but one propeller. In view of the large power per unit and of there being but one engine, the designers were conservative, and the metal and sections are more than ample for the working stresses, with a large factor of safety. The weight of the main engine is 375 tons, and of the whole installation 600 tons. Starting is exceptionally easy to accomplish, and contributory to this result are hot pistons and hot jackets. During the sea trials the outlet temperatures from the pistons and cylinder jackets were 140° to 160° F. The fuel injection into the main engine cylinders works on the solid injection principle, and is effected at pressures of 8000 to 10,000 lb. per sq. in. at full power and speed.

THE preparation of a compound which may contain univalent oxygen is announced by C. W. Porter and F. H. Thurber, of the University of California, in the April issue of the *Journal of the American Chemical Society*. The substance is obtained by the oxidation of mesitol (2 : 4 : 6-trimethylphenol) by silver oxide. A red crystalline product was obtained, the molecular weight of which indicated that it contained in combination equimolecular amounts of unoxidised mesitol and an oxidation product corresponding to one of the formulæ:

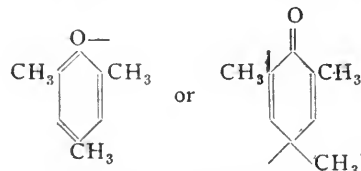

It may, therefore, contain either univalent oxygen or trivalent carbon. It is reduced to a saturated product by the addition of an uneven number of hydrogen atoms, indicating that it contains an odd electron, and has therefore the characteristic properties of a free radical.

In consequence of the greatly increased cost of production, the Association of Economic Biologists has issued an appeal for financial assistance towards the publication of the eighth volume of the *Annals of Applied Biology*. In order that the present standard of quality of the *Annals* may be maintained, it is necessary that the sum of 250l. should be raised. Workers in applied biology are therefore earnestly invited to contribute to the appeal fund. Any contribution, however small, will be acceptable, and should be sent to the honorary treasurer of the association, Dr. A. D. Imms, Institute of Plant Pathology, Rothamsted Experimental Station, Harpenden.

MESSRS. MACDONALD AND EVANS, 29 Essex Street, W.C.2, are about to begin, under the editorship of Mr. G. W. de Tunzelman, the publication of a new

series of manuals entitled "The Reconstructive Technical Series," the aim of which is to diffuse the new knowledge and enlarged technical skill gained during recent years, and so to make it available for to-day as a means towards greater all-round efficiency and increased competitive power in the world's markets. The first volume—"Engineering Steels: An Exposition of the Properties of Steel for Engineers and Users to Secure Economy in Working and Efficiency of Result," by Dr. L. Aitchison—will be published almost immediately.

In recent correspondence on the subject of picture-hanging wire, copper or brass wire has been recommended. Mr. N. M. Richardson now writes to condemn these materials for this purpose on account of the brittleness which develops in the course of a few years. He advises the use of galvanised iron wire, which can be painted a suitable colour if desired. Such wire has been found to be very trustworthy and permanent unless it is exposed to damp.

ADMIRERS of the late Sir William Abney will be interested to learn that the Abney memorial lecture by Mr. Chapman Jones (delivered before the Royal Photographic Society of Great Britain on April 26 last) is printed in full in the July issue of the *Photographic Journal*. Copies of the journal are obtainable from the publishers, Messrs. Harrison and Sons, Ltd., 45 St. Martin's Lane, W.C.2, or the Society, 35 Russell Square, W.C.1.

WE have received from Mr. R. S. Frampton, 37 Fonthill Road, N.4, a catalogue (No. 26, 1921) of second-hand books dealing with science—mainly natural history and gardening. Some 1056 works are listed, and the prices asked are low. The catalogue is obtainable upon application to the bookseller.

MESSRS. GEORGE BELL AND SONS, LTD., announce the publication by them in the autumn of a full report of the proceedings of the Congress of the Universities of the Empire now in progress.

Our Astronomical Column.

THE CAPE OBSERVATORY.—Expression is given by Sir Joseph Larmor, in a letter to the *Times* of July 4, to the apprehensions that are felt among astronomers as to the effect of the proposed transference of the Cape Observatory from the Admiralty to the South African Government. Judging by the condition of the Australian observatories, which at all stages of their existence, and never more than at present, have been greatly hampered through lack of funds, the change would not be to the advantage of astronomy. Further, the suggested transfer would greatly weaken the close bond of reciprocity that has from the first linked the Greenwich and Cape Observatories. It is greatly to be desired that the proposal, which would be little short of a disaster to astronomy, may yet be averted.

THE COMET PONS-WINNECKE.—This comet has now passed out of sight of northern observers, but ephemerides have been sent to southern observatories, where it may be observed for two or three months more. Mr. G. Merton has revised the orbit by using observations extending from April 12 to June 2. He finds

$$\begin{aligned}
 T &= 1921 \text{ June } 12^{\circ} 8985 \text{ G.M.T.} \\
 \omega &= 170^{\circ} 12' 34'' \\
 \Omega &= 98^{\circ} 12' 37'' \\
 i &= 19^{\circ} 1' 7''
 \end{aligned}
 \left. \vphantom{\begin{aligned} T \\ \omega \\ \Omega \\ i \end{aligned}} \right\} 1921^{\circ} 0$$

$$\begin{aligned}
 \log a &= 0.52957 \\
 e &= 0.69242 \\
 q &= 1.0411
 \end{aligned}$$

The most uncertain element is $\log a$, for which the above value is almost certainly too large. It gives a period of 6.23 years, whereas the true value is unlikely to exceed 5.93 years. But the other elements would not be greatly altered by this change.

Mr. Denning writes:—"On the night of June 28 I saw some bright meteors, several of which presumably belonged to the shower from Pons-Winnecke's comet. It is desirable to procure duplicate observations of these objects if possible, for the purpose of working out their real paths, and ascertaining whether or not their radiant points nearly coincide with that computed for the above comet.

"The following are the times and apparent paths of six of the more noteworthy meteors seen here, and

if any of them have been observed elsewhere I shall be very glad to receive such details as were recorded: It need only be said with reference to the objects that No. 4 in the list was a splendid fireball, and that No. 5 is included on account of its exceedingly slow motion. No. 2 was not accurately observed, owing to its flight being partly intercepted by a building. Nos. 1 and 4 were directed from radiants far distant from that of Pons-Winnecke.

Meteors recorded June 28, 1921.

No.	G.M.T. h. m.	Mag.	From	To	Notes.	Radiant
1	11 49	> 7	236 + 48½	212 + 45¼	Rapid, streak	303 + 24
2	11 56	> 1	318 - 1	327 - 7½	Slow, white	? P.-W.
3	12 22	1	293 + 15	298 + 5	Slowish	P.-W.
4	13 18	5 × 9	339 + 33	348 + 18	Slow	P.-W.
5	13 30	2	311 + 67	330 + 61	Very, very slow	P.-W.
6	13 34	7	319 + 19½	312 + 2	Rapid, white	70 + 66

THE FIGURE OF THE EARTH.—An article on this subject by Prof. T. J. J. See (*Astr. Nach.*, Nos. 5103-4) is interesting as an historical summary of the progress of knowledge on the subject. Sir Isaac Newton recognised that the compression was considerably less than 1/230, the figure for equilibrium with a homogeneous fluid earth. The three chief methods have been (1) the measurement of arcs of latitude, (2) lunar perturbations, and (3) pendulum observations. In 1751 La Condamine published the value 1/303.6, deduced from measurement of arcs of latitude in France and Peru. In 1802 Bürg found the value 1/305.05 from method (2). These two values were surprisingly good for that early period, but still not entitled to any weight compared with modern determinations, although Prof. See assigns some to them. The figure 1/293.465 was published by Clarke in 1878, and generally superseded Bessel's value of 1/299.1528, although the latter now appears to be closer to the truth. In recent years methods (1) and (3), in the hands of Helmert, Hayford, Bowie, and others, have given very consistent results, from which the weighted mean 1/298.3 is deduced. Prof. See gives a useful table for obtaining geocentric latitude and radius vector on this assumption, and notes that in his opinion the value 1/294, adopted in Brown's Lunar Tables, is decidedly too large.

Sir Ernest Shackleton's New Expedition.

SIR ERNEST SHACKLETON announces in the *Times* and *Daily Mail* a new Antarctic expedition to start under his leadership in August. The region to be explored is that missing part of the Antarctic coastline which lies between Drygalski's Wilhelm Land and Bruce's Coats Land. In this stretch the only land known with certainty is the bold headland of Cape Ann, or Enderby Land, discovered by J. Biscoe in 1831, but never visited. Cape Ann probably marks the edge of the continent. Kemp Land, a little further east and also on the Antarctic Circle, was reported in 1833, but its existence needs verification. Cook (1773), Biscoe (1831), Bellingshausen (1820), and Moore (1845) were each thwarted by pack in their attempts to push southwards to the west of Cape Ann. In lat. $68^{\circ} 5' S.$, long. $16^{\circ} 37' E.$, Bellingshausen was probably not far from land, but these early navigators took no deep soundings. A large bight in the coastline in this region is improbable, but glacier tongues may occur, and, by obstructing the free movements of the pack along the coast, make approach and landing difficult. Sir E. Shackleton hopes to avoid wintering in the south, and plans to sail northwards from Coats Land through the more open eastern part of the Weddell Sea to the South Sandwich group and South Georgia. After refitting he proposes to sail eastward *via* Bouvet and Heard Islands to New Zealand, taking deep-sea soundings on the way. It will prove no easy matter to sound in the stormiest seas in the world, but it is to be hoped he will be successful and so amplify the work of the *Faldivia* and *Scotia*, and further east that of the *Challenger* and *Gauss*. On the way home soundings are to be taken in high latitudes in the south-eastern Pacific.

In addition to his Antarctic work Sir E. Shackleton proposes to visit a number of isolated islands and to search for others the existence of which is doubtful. In the latter category is Dougherty or Keates Island, which was reported in lat. $59^{\circ} 40' S.$, long. $110^{\circ} 45' W.$, in 1841, and since has been sighted only once and several times searched for in vain. It probably has no existence. Search is also to be made for Tuanaki, a legendary island in lower latitudes in the South

Pacific. Of the other islands in the expedition's list, a few afford scope for exploration, but others are well known, even if seldom visited. St. Paul's rocks, near the Equator, have been explored by a number of scientific expeditions, from that of the *Beagle* (1832) to that of the *Scotia* (1902). Their geology, birds, and scanty plant-life are well known. South Trinidad achieved fame from Mr. E. F. Knight's cruise in the *Alert*, and was visited in 1902 by the *Discovery*; little new can be expected there. Gough Island, or, more correctly, Diego Alvarez, 280 miles south-east of Tristan da Cunha, promises more interest. The only scientific expedition that has ever visited that island was the *Scotia*, which in 1904 secured several new species of birds and plants. Heard Island was explored by the *Challenger*, but Bouvet Island, discovered in 1739, and sighted again and even photographed in 1898, is quite unknown. It appears to be ice-capped and is said to be inaccessible. Interesting work will be done in the South Sandwich group, which is imperfectly explored, even if known to sealers at one time. In South Georgia work remains to be done on the east and south coasts.

The expedition is to be equipped for oceanographical work, which will be conducted throughout the voyage. Meteorological research will be assisted by the use of a specially constructed seaplane and pilot balloons.

In the *Quest* the expedition has a first-rate ship for the work. She is a Norwegian wooden vessel of some 200 tons, built four years ago, and thoroughly tested in hunting and trading in the Barents Sea and Spitsbergen waters. The *Quest* has auxiliary engines, and will be rigged as a brigantine. Sir E. Shackleton will be accompanied by six members of his former expeditions, including Mr. F. Wild, Capt. F. Worsley and J. R. Stenhouse, Dr. A. H. Macklin, and Mr. L. Hussey, meteorologist. No other names of the staff are announced, but the *personnel*, which is to be small, is said to be complete. The expedition is financed by Mr. J. O. Rowett, and will be styled the Shackleton-Rowett Oceanographical and Antarctic Expedition. Mr. F. Becker has also given generous support.

R. N. R. B.

Milk Customs of Bunyoro, Central Africa.

ON June 21 the Rev. J. Roscoe read a paper on "The Milk Customs of Bunyoro" at a meeting of the Royal Anthropological Institute. Mr. Roscoe, after a brief account of the distribution of the main groups of peoples in Central Africa, described the chief social and religious ceremonies of the Bunyoro, of which the ritual of the milk formed a part. These ceremonies have become obsolete under the influence of Christianity, but they were revived and re-enacted so far as possible in order that Mr. Roscoe might have an opportunity of witnessing them.

The King of Bunyoro is expected to put an end to his own life as soon as he feels his powers failing through illness or old age. His death is announced by one of the milkmen of the sacred cows in the words, "The milk is spilled," pronounced from the roof of a hut and accompanied by the breaking of a pot of milk. This man and the boy whose duty it is to bring the cows to the royal enclosure to be milked are thereupon put to death in order that their spirits may serve the king in the next world.

The princes who lay claim to the throne now take to arms and fight until only one is left alive. This

survivor claims the body of the king, which lies in the royal enclosure unburied until he comes. Mourning then begins, and the dead king is buried in a pit filled up with barkcloths in a specially built hut. Two of his widows are buried alive with him. The country is then purified by the new king's sister, who sprinkles the people and cattle gathered in the royal enclosure with a mixture of water, white clay, and milk. A sham king is appointed for the purpose of removing sorrow and sickness. He is set on the throne, receives homage and gifts, and is then taken aside and strangled by the chief minister. The new king then moves to a new royal enclosure and begins his reign.

The king, as the chief priest for the people and cattle, has a constant succession of ceremonial duties to perform. His food is milk from nine sacred cows brought in from the royal herd and milked with much ceremony. While the king drinks everyone in the royal enclosure kneels down and hides his face; a cough or sneeze is punishable by death. Later in the day the king has a meal of four pieces of meat served by the royal cook, who has to place them in the

king's mouth with a fork; should the fork touch the king's teeth the cook is instantly put to death. All who have to do with the king's food, either milk or meat, are specially purified, and have their faces, chests, and arms whitened. Daily the king has to pass through a series of seven sacred huts for the purpose of herding three of the sacred cows in a special enclosure. The rest of the day he is occupied largely with royal duties, receiving and judging his people.

At every appearance of the new moon there are festivities which last nine days. The king, as soon as the new moon appears, pronounces a blessing on the people, and dancing and music begin, continuing day and night for a week. On the second day the king proceeds through the seven sacred huts to the place where he daily herds the sacred cows, and there he receives any member of the Sacred Guild who has offended. The mark of pardon is to be allowed to kiss the king's hands, and, however kindly the king may address the man, unless he holds out his hands to be kissed, the man knows that he has only a few days to live.

The admission of a new chief to the Sacred Guild is also a milk ceremony of importance, for the new chief has to drink some of the king's sacred milk in the presence of the king. The experience is so trying that men sometimes faint under the ordeal.

The king holds an annual celebration of his accession to the throne, when to defeat his enemies he shoots arrows to each quarter of the globe from a special bow strung with sinews cut from the shoulder of a living man. Once a year also the king calls for a blessing on the land by offering pieces of meat to each of the four quarters of the globe.

In reply to questions asked after the reading of the paper, Mr. Roscoe said that the reason for these ceremonies, as given by the natives themselves, was purely economic. The aim was to promote the well-being of the cattle and the crops.

Trees and Shrubs of Mexico.

THE first instalment of an account of the woody plants of Mexico, by Mr. Paul C. Standley, is issued as vol. xxiii., part 1, of the Contributions from the United States National Herbarium. The work is based upon the extensive series of Mexican plants in that institution. The botanical features of Mexico have attracted attention from the days of the earliest explorers, and many botanists have visited the country within the last hundred years, yet the flora is still but imperfectly known. The plant formations are remarkably diverse, including the wet tropical forests of the southern lowlands, the temperate deciduous and coniferous forests of the central plateau and of the ranges of the Sierra Madre, the alpine zones of the high peaks like Orizaba and Popocatepetl, and the great barren or cactus deserts in the northern States. For anything approaching a complete account of the flora of Mexico we have hitherto had to rely on Dr. Hemsley's list in the "Biologia Centrali-Americana," published nearly forty years ago; much botanical work has been done in the country since that time, and a descriptive flora which will give an account of present knowledge and serve as a starting-point for further work is a desideratum.

Mr. Standley deals only with the trees and shrubs, the larger number of which, especially those of economic importance, are probably already represented in herbaria. In his introduction he gives an interesting account of several of the earliest enterprises for the botanical exploration of Mexico, including that of Francisco Hernandez, 1570-77, and

that of Martin Sessi and Jose Mocino more than two centuries later. Large collections of plants and sketches were made in connection with both these expeditions, and extensive accounts prepared in manuscript, but the work of Hernandez was not published until long after his death, and then only in an abridged form; while Mocino's "Plantæ Novæ Hispaniæ" and "Flora Mexicana" were issued by the Sociedad Mexicana de Historia Natural in 1886 and 1888 respectively, by which time their interest had become merely sentimental.

The present instalment of Mr. Standley's work deals with the ferns, gymnosperms and monocotyledons, and a few families of dicotyledons. By an oversight no clue to the general systematic arrangement has been given; there is an elaborate key to the families, which should have been given numbers. Keys to the genera are supplied under each family and to the species under each genus; references to the original description of genus and species are given, the range of each species so far as it is known is indicated, and in some cases short descriptive notes are added; the native names and economic uses are also mentioned. The ferns (elaborated by Mr. W. R. Maxon) are nearly all tree-ferns; the conifers include twenty-six species of pine, and a few cypresses, junipers, ephedras, and others. There are a few grasses—bamboos, reeds, etc.—eighteen genera of palms, and, though strictly herbaceous, three genera of climbing aroids are included. Prof. Trelease has been largely responsible for the account of the liliaceous and amaryllidaceous plants, types characteristic of dry country, including the yuccas and agaves, species of the latter genus numbering 170. The dicotyledons include fifty-nine species of Piper, poplars, willows (sixteen species), walnut and hickory, and alders (six species).

University and Educational Intelligence.

BIRMINGHAM.—At a degree congregation held on July 2 the Chancellor (Lord Robert Cecil) conferred the following degrees:—*D.Sc.*: Fred Johnson; *M.D.*: John Shaw Dunn; *Ph.D.*: H. D. K. Drew, Abd el Rahman El Sawy; *M.Sc.*: F. Adcock, C. F. Allpress, H. Burgess, V. A. Collins, W. A. P. Challenor, J. G. H. Frew, C. V. Hackett, Lucy E. Hardcastle, W. J. Hickinbottom, T. L. Ibbs, D. H. Ingall, F. James, L. A. Jones, E. W. Pratt, E. A. F. Reeve, H. S. Rooke, F. G. Srawley, R. C. Watson, Dorothy Webster, and E. H. Wells.

In addition 134 candidates were admitted to the degree of B.Sc.

The Chancellor announced that the recent appeal had brought in 285,062*l.*, besides increased grants from education committees in the surrounding counties.

A generous donation of 5000*l.* from Mr. C. Hyde has enabled the University to acquire a house, to be converted into a hostel for about seventy men students.

CAMBRIDGE.—A travelling fellowship of 200*l.*, offered to past students of Girton College, and tenable at any foreign or colonial university, has been awarded to Miss M. G. Tomkinson, assistant lecturer in chemistry, Girton College. Miss Tomkinson proposes to work in the chemical laboratory of the University of Toulouse, under the direction of Prof. Sabatier.

DUBLIN.—Mr. D. Clark, lecturer in civil engineering and chief assistant to Prof. Moncur in the Royal Technical College, Glasgow, has been elected to the chair of civil engineering at Trinity College.

The honorary degree of LL.D. has been conferred

upon Sir R. A. Falconer, president of the University of Toronto, and that of D.Sc. upon Prof. E. Borel, of the University of Paris. The ordinary D.Sc. degree has been conferred upon Mr. J. H. J. Poole and Mr. G. de P. Cotter.

DURHAM.—The honorary degree of D.Sc. has been conferred upon Sir E. H. Tennyson-d'Eyncourt, director of naval construction, the Admiralty.

It is proposed to confer the following honorary degrees on the occasion of the forthcoming meeting of the British Medical Association at Newcastle-upon-Tyne:—*D.C.L.*: Sir William Macewen, Sir Thomas Oliver, and Sir Humphry Davy Rolleston. *D.Hy.*: Mr. T. E. Hill and Dr. J. W. Smith. *D.Sc.*: Sir Arthur Keith. *D.Litt.*: Sir Dawson Williams.

LEEDS.—The gas plant specially designed for experimental purposes which Mr. Henry Woodall is erecting as an adjunct to the Department of Coal Gas and Fuel Industries of the University of Leeds, and as a memorial to the late Sir Corbet Woodall, is now in process of construction. Mr. A. G. Glasgow, having expressed his desire to associate himself with this memorial, has made a donation of 500 guineas for the purpose.

OXFORD.—Mr. W. C. Burnett, Worcester College, has been appointed secretary of the Delegacy of Local Examinations in succession to the late Mr. H. T. Gerrans.

Mr. P. H. Martin, New College, has been elected to the Theodore Williams scholarship in anatomy, the annual value of which is 50*l.* and tenable for two years.

MR. A. W. SHEEN has been appointed professor of surgery in the Welsh National School of Medicine.

THE Joint Committee of the Royal Society and the University of Sheffield has appointed Dr. N. K. Adam to the Sorby research fellowship.

PROF. H. C. PLUMMER, Royal Astronomer of Ireland, and Andrews professor of astronomy in the University of Dublin, has been appointed professor of mathematics at the Ordnance College, Woolwich.

THE London County Council has adopted a recommendation of the Education Committee that the Board of Education and the Senate of the University of London be invited to explore the possibilities of the Holland Park site before further action is taken relating to the Bloomsbury site

ANNOUNCEMENT is made of the following gifts:—Bristol University has received from Mr. H. H. Wills the sum of 200,000*l.* to build and equip a new physics laboratory; and Glasgow University and the Royal Technical College, Glasgow, have received 10,000*l.* each under the will of the late W. J. Chrystal, chemical manufacturer.

AN election to the Ackroyd memorial research fellowship in the University of Leeds is to be made shortly. The selected candidate will be expected to carry out an approved scientific investigation of a biological, physical, or chemical nature bearing, directly or indirectly, upon the production or properties of wool or other textile materials, or upon the manufacture of textile fabrics. The fellowship is of the annual value of 300*l.* It is tenable for one year, and renewable for a second or third year. Applications must be made to the Registrar of the University by, at latest, July 28.

Calendar of Scientific Pioneers.

July 7, 1854. Georg Simon Ohm died.—The fame of Ohm rests mainly on the small pamphlet, "Die galvanische Kette mathematisch bearbeitet," published by him in 1827, when he was professor of mathematics at the Jesuit College, Cologne. His well-known law was first enunciated a year or two earlier.

July 8, 1784. Torbern Olof Bergmann died.—The contemporary of Scheele, Bergmann from 1767 held the chair of chemistry at Upsala. He made improvements in the methods of chemical analyses, and in 1775 published his essay on "Elective Attractions."

July 9, 1716. Joseph Sauveur died.—The great pioneer worker in acoustics, Sauveur was educated for the Church, but in 1686 became professor of mathematics in the Collège de France. His study of sound covered the last twenty years of his life.

July 9, 1856. Amedeo Avogadro, Conte di Quaregna, died.—Of noble parentage, Avogadro, from 1809 to 1821, was professor of physics and mathematics at Vercelli, where in 1811 and 1814 he published the memoirs containing the law which bears his name.

July 10, 1910. Johann Gottfried Galle died.—When assistant to Encke at Berlin, Galle and D'Arrest, at Leverrier's request, searched for Neptune with the aid of Bremiker's map. Galle first saw the planet on September 23, 1846. Afterwards he was for many years director of the Breslau observatory.

July 11, 1807. George Atwood died.—A distinguished Cambridge mathematician, Atwood first described his well-known machine in 1784 in his treatise on the rectilinear motion and rotation of bodies.

July 11, 1909. Simon Newcomb died.—One of the most distinguished astronomers of recent times, Newcomb, in 1857, at the age of twenty-two, entered the office of the American Nautical Almanac, of which from 1877 to 1897 he was director. Like his colleague Hill, he was a great master of dynamical astronomy.

July 12, 1682. Jean Picard died.—Picard has been called "the father of French astronomy." He was an assistant to Gassendi, visited Tycho Brahe at Hven, edited the "Connaissance des Temps," measured a degree of the meridian, and first used the telescope with the quadrant.

July 12, 1851. Louis Jacques Mandé Daguerre died.—One of the inventors of photography, Daguerre was a successful scene painter, and part owner of a diorama in Paris. Six years after the death of Niepce, with whom he had collaborated, Daguerre, in 1839, obtained sun pictures on silver plates covered with a film of iodide.

July 13, 1762. James Bradley died.—Recognised as one of the greatest astronomers of the first half of the eighteenth century, Bradley became Savilian professor of astronomy in 1721, and in 1742 succeeded Halley as Astronomer Royal. His discovery of aberration was made known in 1729; that of nutation in 1748. His Greenwich observations are of great importance, and were reduced first by Bessel and then by Auwers.

July 13, 1896. Friedrich August Kekulé von Stodonitz died.—The friend of Gerhardt and Williamson, Kekulé was especially known for his speculations on structural chemistry. His work on the benzene theory has been described as "the most brilliant piece of scientific prediction in the whole range of organic chemistry." His statue stands outside the fine chemical institute at Bonn.

Societies and Academies.

LONDON.

Zoological Society, June 7.—Prof. J. P. Hill, vice-president, in the chair.—Major S. S. Flower: Remarks upon *Testudo Lethii* and *T. ibera*.—Dr. P. Chalmers Mitchell: Remarks upon a photograph of the death-mask of a young gorilla.—Dr. F. M. Chapman: The distribution of bird-life in the Urubamba Valley, Peru.—S. Maulik: New Indian Drilid beetles.—Prof. J. P. Hill: Some marsupial embryos, especially the koala (*Phascolarctos*) and the wombat (*Phascolomys*).—R. I. Pocock: The external characters of the koala (*Phascolarctos*) and some related marsupials.—Dr. C. F. Sonntag: The comparative anatomy of the koala (*Phascolarctos*) and the vulpine phalanger (*Trichosurus vulpecula*).—C. T. Regan: The Cichlid fishes of Lake Nyassa.

Royal Meteorological Society, June 15.—Mr. R. H. Hooker, president, in the chair.—G. M. B. Dobson: The causes of errors in forecasting pressure gradients and upper winds. The usual method of checking the accuracy of forecasts by finding their absolute error is misleading, particularly when the weather is very settled. It would be better to find the improvement obtained by "forecasting," e.g. to compare the absolute error of the forecast, made for twenty-four hours ahead, with the actual change of direction in the twenty-four hours. Trial forecasts of the pressure gradient when checked thus showed but small improvement; the inaccuracy in estimating the future positions of centres of high and low pressure is a large factor, but a greater error is due to the small irregularities of pressure which are local and transitory, and which, therefore, seem almost impossible to forecast.—R. F. Granger: The physical structure of cloud form in the lower atmosphere. Beginning with a constructive criticism of the theory of cumulus formation, the behaviour of eddy-formed stratus sheets, the possibility of outward radiation at night, causing cloud formations, and the formation of sub-strata underneath various types of cloud sheet are discussed. The last part of the paper deals with cyclonic nimbus, and describes the cloud structure of a cyclone while rain is falling: that actual rain-producing cloud is formed by the ascent, *en masse*, of the eddy-formed damp layer. A cirrus-like cloud forms at low altitude during the passage of one air current over another if the movement set up by friction causes the elevation of a damp layer in the upper air current. The interpretation of cloud form in terms of physical structure will probably have a place in the weather forecasting of the future.—N. A. Comissopulos and J. Wadsworth: Variability of temperature over Europe and North America (1900-9). The variability of temperature is measured in this paper by standard deviations from the mean of ten values of the annual mean temperature from 1900 to 1909 for a large number of European and North American stations. The small number of years considered is an objection, but consistent results have been obtained. No correlation is found between altitude and temperature variability, but a fair connection is indicated between latitude and temperature variability. Charts of isopleths representing variability of temperature show generally an increased variability towards the north, but a decrease towards the coasts. Secondary maxima and minima occur, the positions of which follow the configuration of the land in Europe; maxima occur over N.E. Russia, W. Germany, France, and Spain, and minima over the Atlantic and Mediterranean. A chart of S.W. Europe

for 1890-99 showed the same general features as that for 1900-9, but with different absolute values for the various isopleths.

Royal Statistical Society, June 21.—Sir R. Henry Rew, president, in the chair.—Mrs. W. J. Barton: Women's minimum wages. The main sources of the figures given were the wage rates for unskilled women collected in the *Labour Gazette* and those settled by the Trade Boards. The rates quoted were all minima, and it was difficult to ascertain the proportion of workers earning more than the prescribed rates. The paper dealt with the groups of women workers affected by Trade Board legislation; e.g. the distributive trades, sewing trades, laundries, sugar, confectionery, and fruit-preserving trades, paper and printing trades, and the metal trades. Each trade was examined in detail; tables were submitted showing the Trade Board rates payable in different districts and the changes therein at different dates, and where possible the various wages paid by voluntary agreement between employers were given for comparison with the legal rates. Trade Boards had raised the wages of the lowest paid workers, and uncontrolled trades had been strongly influenced, while several trades possessing Trade Boards had agreed upon rates considerably above the legal minimum. A minimum standard wage for the unskilled work of women and girls had been created.

Mineralogical Society, June 21.—Dr. A. E. H. Tutton, past president, in the chair.—Dr. H. Hilton: A note on crystal measurement. Labour could be saved by measuring the angles between zones through two faces instead of the angles between zones through one face and the angles between this face and the rest.—A. Brammall: The trend of reconstitution processes in shales, slates, and phyllites. The author correlates microscopical data with data deduced from chemical analyses. The finely powdered rock is extracted with (a) 20 per cent. of hydrochloric acid, (b) 50 per cent. of hydrochloric acid, and the extracts are analysed and discussed with reference to the molecular proportions of the bases present. The residual slime is treated with dilute hydrofluoric acid, freed from silica gel, and thoroughly washed. Free carbon particles are floated off by the froth produced on vigorously shaking up the slime with water to which a few drops of amyl alcohol, paraffin, and sodium silicate have been added. Samples of coarse-grade and fine-grade sericite are separated by elutriation and analysed. Heavy or insoluble residues are obtained and examined. Data referring to Bolivian rocks and the Skiddaw Slate are discussed. The general trend is towards the establishment of a metastable ternary system of white mica, chlorite, and quartz by a process of molecular differentiation: (a) Monad-oxides, type R_2O , allied with alumina, silica, and water (mica); (b) diad-oxides, type RO, allied with alumina, ferric oxide, silica, and water (chloritic matter); and (c) free silica (quartz). In the early stages this differentiation is imperfect: the mica contains iron oxides, magnesia, etc., and the chloritic matter adsorbs alkalis. The identity of mineral species evolving from the chloritic matter depends partly upon the molecular ratio $R_2O:RO$, and this in turn depends partly upon the reduction of ferric oxide to ferrous oxide. The development of rutile, ilmenite, epidote, etc., is probably subordinate to the main trend.—W. A. Richardson: The micropetrography of the rock-gypsum of Nottinghamshire. A wide range of structural types, including many metamorphic types, are found. The evidence supports the view of B. Smith that the main series is of sedimentary origin, and that the nodular deposits are

segregations. The metamorphic effects appear to be due to pressure caused by the partial or complete hydration of the anhydrite.

EDINBURGH.

Royal Society, June 6.—Prof. F. O. Bower, president, in the chair.—By request of the council, Lt.-Col. W. Glen **Liston** gave an address on plague and rats. After a brief historical survey Lt.-Col. Liston traced the course of events by which after the discovery of the bacillus in 1898 the connection between rats and the disease was established. The link connecting the plague in rats with the plague in men had still, however, to be found. A curious experience of a friend who had been attacked by a swarm of cat fleas on entering a part of a house which had been disused for some time suggested the possibility that the rat flea might be the agent of transmission of the disease. Some little time later, in a certain tenement in Bombay, rats began to die from plague, and as the rats became scarce, rat fleas began to trouble the inhabitants, and cases of plague began to develop among them. Lt.-Col. Liston received a sample of thirty fleas caught in these circumstances. Of these fourteen were rat fleas. Previous experience had shown that out of 246 fleas caught on men, only one was a rat flea. Evidently the rat fleas, deprived of their normal host, had fastened on man. Another link in the chain of evidence was provided by an outbreak of plague among some guinea-pigs kept in Victoria Gardens. An examination proved that the guinea-pigs, which normally seldom harbour rat fleas, were infected with many of these, and that plague bacilli were found in the stomachs of some of them. Further experiments were made, and while these were in progress the Plague Research Commission was appointed by an advisory committee of members nominated by the Royal Society of London, the Lister Institute, and the India Office. The findings of this Commission, consisting of Major Lamb, Drs. Rowland and Petrie, and Lt.-Col. Liston, have been universally accepted, proving that rats are the chief cause of plague, and that the plague is transmitted from rat to rat, and from rats to men, through the agency of rat fleas.

June 20.—Prof. F. O. Bower, president, in the chair.—M. M'C. **Fairgrieve**: The annual incidence of intelligence and its measurement by the American Army tests. While many boys of high mental ability have their birthdays in the late spring months, there is a distinct risk that boys born in these months may prove to have intelligence rather below the normal. This result, previously indicated by an application of the Burt tests to a limited number of boys, has been confirmed by the application of an American Army test to as large a number of boys as was available. Norms suitable for the application of the Army tests to other schoolboys are also given, as well as some evidence that the average intelligence of public-school boys increases up to an age of twenty years rather than the earlier limit of eighteen or sixteen years given elsewhere.—J. M. **Wordie**: Shackleton Antarctic Expedition, 1914-17: Geological observations in the Weddell Sea area. (1) A description is given of the ice-bound nature of Coats Land, where there are 250 miles of barrier (shelf-ice) cliffs without bare rocks of any sort. (2) Elephant Island, South Shetlands, consists of metamorphic schists, striking N. 70° E. Mr. Tyrrell examined the rocks petrographically for comparison with other West Antarctic rocks, but found no resemblances; he considers them to have been in part volcanic ashes originally, but now much silicified and chloritised. (3) South Georgia is given a different interpretation from that of Mr. Ferguson. Exception is taken to his attempt at sub-

dividing the rocks and to his interpretation of the structure. Instead of monoclinical folds and block-faulting, one sees extremely complicated folds striking N.W.-S.E. An igneous complex was found at the south-east end of the island. Prof. J. W. Gregory's claim of Palæozoic rocks is not considered proved, a Mesozoic age for the whole series being regarded as much more likely on the fossil evidence. There is nothing to show that an arc comparable with the Antilles connected the islands of West Antarctica. The necessary link, however, between the geologically similar regions of Graham Land and Patagonia may perhaps be found, as Prof. Gregory first suggested, more to the west than South Georgia.—Dr. H. **Levy**: The criterion for stable flow of a fluid in a uniform channel. On experimental grounds O. Reynolds found that a simple critical relation exists between the velocity and the size of the channel and the viscosity of the fluid flowing along it, which corresponds to the passage from steady to turbulent eddying motion. Aero- and hydro-dynamical experiments during the past few years indicate the existence of such a critical relation in general. Many curious aerodynamic phenomena centre round the explanation of this critical state. In the present paper, where the question is regarded from a new point of view, it is shown on general grounds that if a distribution of vorticity is imposed on a viscous fluid, a critical relation should exist between the velocity and size of the boundaries and the strength of the vorticity, separating the stable from the unstable state. The case of a channel along which fluid is flowing with a parabolic distribution in velocity is considered in detail, and the critical relation due to the imposition of a symmetrical pair of vortices deduced and discussed.—Prof. P. **Macnair** and C. M. **Leitch**: The genus *Clisiophyllum*. The representatives of this genus of fossil corals are exceedingly abundant at certain horizons in the Carboniferous rocks of the West of Scotland, especially in that known as the Blackbyre Limestone. These corals were collected, sectioned, figured, and described by a Glasgow geologist, James Thomson, who created a very large number of new genera and species. The type-specimens were afterwards presented to the Kilmarnock Museum, and were involved in the fire that destroyed that institution. The materials studied by the authors include those specimens that were salvaged from the fire and other collections in which the different genera and species had been named by Thomson. These are now in the Kelvingrove Museum, Glasgow. After the examination of several thousand specimens, nine genera and something like eighty species have been included in the genus *Clisiophyllum*, four variations, of which have been suggested round which the genera may be grouped. Eight of these genera were founded on the axial column, and it is on this structure that the four types of variation depend for their significance. The authors hoped they had shown that these variants are linked together in an ontogenetic sequence, and that this is also a phylogenetic sequence. They believed that the elaboration of species and their supposed values as time-indices, as upheld by the late Dr. Vaughan and his disciples, had been carried to a length wholly unjustified by the available evidence, and urged a return to simpler and more natural methods of stratigraphical and palæontological classification.

PARIS.

Academy of Sciences, June 13.—M. Georges Lemoine in the chair.—G. **Bertrand**: Fredholm equations with principal integrals as used by Cauchy.—H. **Mineur**: Functions admitting a theorem of algebraic addition.—J. **Kampé de Fériet**: Hypercylindrical functions.—

J. Andrade: Rolling resistance and optical mirror method.—**J. Le Roux**: The law of gravitation and its consequences. A criticism of the theory of relativity.—**A. Foch**: The phenomena of resonance in aspiration turbines. An indication of the danger of resonance phenomena and of the modifications necessary to avoid them.—**M. Rateau**: Remarks on the preceding communication.—**R. Jarry-Desloges**: Contribution to the study of the bright Martian areas. The observations of G. Fournier at Sétif show that on April 25, 1920, when the white polar cap was at a minimum, the eccentricity was sufficient to leave the pole free from white, but in general the eccentricity is less marked.—**J. Popesco**: The value of the surface tension of mercury in various gases. In a vacuum the surface tension of mercury is constant, and the value found, 44.4 mgr. per mm., agrees with the earlier figure of M. Stöckle. In air, ammonia, and sulphur dioxide the surface tension falls rapidly during the first ten minutes, then more slowly, finally after twenty-four hours reaching a figure lower than in a vacuum. The phenomenon is reversible, since on removing the gas the surface tension recovers its original vacuum figure. The change in the surface tension is probably not due to a chemical action of the gas on the mercury.—**P. Lambert**: The use of polarised light for the examination of old pictures. By the use of polarised light the surface reflections can be suppressed, the colours become brighter and details clearer. The method gives an indication whether a picture can be improved by modifying its varnish.—**M. and Mme. E. Henriot**: The double refraction of compressed glass. It is usually admitted, on the basis of Wertheim's experiments, that the dispersion of the double refraction of compressed glass is negligible. The authors' experiments show that there is dispersion in crown glass, and agree with the values calculated by Havelock's law.—**L. Décombe**: The enunciation of the principle of equivalence in thermodynamics.—**G. Déjardin**: The production of the argon spectra by slow electrons.—**P. Loisel**: Rapid method of measuring natural leakage of an electroscope in view of the estimation of radium emanation.—**E. Darmois**: The molybdomalates of ammonium and sodium. The rotatory power is at a maximum when molybdic anhydride, malic acid, and ammonia are present in the molecular proportions 2 : 1 : 2. Sodium salts give the same ratio.—**L. Meunier and P. Caste**: The action of sodium carbonate on solutions of chrome alum.—**A. Portevin and P. Chevenard**: The retarded solution and premature precipitation of iron carbide in steels, and the influence of the initial state on these phenomena.—**Mlle. J. Apolit**: The dehydration of phenyldimethyl butanol and diphenyldimethyl propanol.—**M. Pariselle**: The composition of French essence of turpentine; α -pinene bromide. α - and β -Pinene have been isolated from 15 litres of French turpentine by long fractional distillation under reduced pressure; the physical constants have been redetermined, and the action of bromine on the hydrocarbons studied. Even when no hydrobromic acid is evolved, the action of bromine on pinene always gives a complex mixture of substitution and addition products, the hydrobromic acid produced being absorbed by the pinene.—**A. Brochet and R. Cornubert**: The tetrahydronaphthols.—**G. Tanret**: The influence of ammonium molybdate on the rotatory power of mannite. A complex compound has been isolated by crystallisation of mannite and ammonium molybdate, and this possesses rotatory power. It is unchanged by water, but immediately decomposed by dilute alkalis into ammonium molybdate and mannite, with loss of the rotatory power.—**H. de Pomereau**: The reduction of ethyl naphthoate and a case of reduction of an alcohol to hydrocarbon by

sodium and absolute alcohol. Ethyl naphthoate is reduced by sodium and ethyl alcohol, not to the corresponding alcohol, but to a dihydromethylnaphthalene. α -Naphthyl alcohol is reduced under the same conditions to the same hydrocarbon.—**J. F. Durand**: The decomposition of metallic alcoholates and phenates by heat. Sodium methylate on heating splits up nearly quantitatively into hydrogen, sodium acetylide, sodium carbonate, and carbon. Potassium methylate behaves similarly, and there is evidence that at one stage potassium vapour is present. Sodium ethylate and phenate follow a different reaction.—**M. François**: The stereoscopic photography of crystals.—**J. Bourcart and R. Abrard**: Some crystalline rocks of Albania.—**L. Lutaud**: Tectonic observations in the pre-Riffian zone of northern Rharb, Morocco.—**L. Cayeux**: The magnetic iron minerals of the Longwy-Briey basin.—**S. Stefanescu**: The correlation of the alveolar cavities, movements, and structure of the last molars of mastodons and elephants.—**A. Boutaric**: Actinometric and polarimetric measurements at high altitudes. The intensity of the solar radiation received at the surface of the soil, for equal thicknesses of atmosphere, varies in the same sense as the polarisations.—**P. Lesage**: Experimental cultures of *Fegatella conica* and some other Muscineæ.—**Mme. E. Bloch**: Modifications of roots and stems by mechanical action.—**L. Lapique**: The nutritive exchanges of animals as a function of their body weight.—**A. Thooris**: Contribution to the biological study of divers. A physiological study of two men capable of remaining under water several minutes.—**A. Polack**: The effects of chromatism of the eye in complex colour vision.—**L. Ronle**: A new deep-sea fish, *Scombrobrax heterolepis*, caught near Madeira. A detailed account of a new fish caught at a depth of between 800 and 900 metres.—**H. Hérissey**: The synthetic action of α -methyl-*d*-mannosidase.—**E. Kayser**: The influence of the nitrogenous material elaborated by the Azobacter on the alcohol ferment.—**C. Levaditi, A. Marie, and S. Nicolau**: The virulence for man of the spirochæta of the spontaneous spirillosis of the rabbit. This organism is not pathogenic for man.

MELBOURNE.

Royal Society of Victoria, April 14.—Prof. A. J. Ewart, president, in the chair.—**F. Chapman**: The age of the ironstone beds of the Mornington Peninsula. The author collates the previous evidence, based on the fossils, as to the age of the widespread ironstone beds, and by the recent discovery of certain restricted fossils, shows the beds at Landslip Point and Baxter to belong to the Janjukian stage, intermediate between the older, Balcombian, and the younger, Kalimnan. The fossiliferous ironstone from Baxter is a metasomatised polyzoal limestone, the calcareous portion being entirely replaced by limonite.

CAPE TOWN.

Royal Society of South Africa, May 18.—Dr. J. D. F. Gilchrist, president, in the chair.—**Sir T. Muir**: Note on the product of a new determinant and its bordered derivative.—**P. A. van der Bijl**: Some South African strems. South African fungi of the genus *Stereum* were described.—**P. A. van der Bijl**: A fungus, *Gibbelula Haygarthii*, sp.n., on a spider of the family Lycosidæ. A fungus belonging to the genus *Gibbelula*, Cava, found on a spider, belongs to a species hitherto undescribed, and the name *G. Haygarthii* is suggested.—**W. A. Norton**: Circumcision régiments as a native chronology. The Bechuana circumcision régiments show that a military organisation of native tribes based on the successive circumcision companies of the youth was very widespread in South Africa. In the case of the

Baralong and other tribes, the regiment lists, running back to 1750, indicate where the split between different branches occurred. It is sought to carry them far enough back to illustrate the fission of the tribes now distinct from one another, to which tradition points, but the rapid passing of the old people makes this increasingly difficult and urgent. These lists are of value to history and philology, for they aid in dating events.

Books Received.

Nedbørikttagelser i Norge utgitt av det Norske Meteorologiske Institutt. Middelveidier, Maksima og Minima. Pp. ix+61+17 plates. (Kristiania: H. Aschehoug and Co.) Kr. 6.00.

Valenzkräfte und Röntgenspektren zwei Aufsätze über das Elektronengebäude des Atoms. By Prof. W. Kossel. Pp. iv+70. (Berlin: J. Springer.) 12 marks.

Transactions of the Royal Society of Edinburgh. Vol. lii., part iv. (No. 31). Shackleton Antarctic Expedition, 1914-1917: The Natural History of Pack-Ice as Observed in the Weddell Sea. By J. M. Wordie. Pp. 795-829+4 plates. (Edinburgh: R. Grant and Son; London: Williams and Norgate.) 8s.

Tier und Pflanze in Intrazellulärer Symbiose. By Prof. P. Buchner. Pp. xi+462+2 Tafel. (Berlin: Gebrüder Borntraeger.) 114 marks.

Les Ressources du Travail Intellectuel en France. By E. Tassy and P. Lérés. Pp. xxi+711. (Paris: Gauthier-Villars et Cie.) 50 francs.

Prices and Wages: An Investigation of the Dynamic Forces in Social Economics. By P. Wallis and A. Wallis. Pp. xii+456. (London: P. S. King and Son, Ltd.) 25s. net.

Studies of the Development and Larval Forms of Echinoderms. By Dr. Th. Mortensen. Pp. iv+261+xxxiii plates. (Copenhagen: G. E. C. Gad.)

Royal Botanic Gardens, Kew. Bulletin of Miscellaneous Information, 1920. Pp. iv+384+41. 10s. net. Additional series XI.: General Index to the Volumes of the Kew Bulletin for the Years 1887-1918. Pp. 202. 7s. 6d. net. (London: H.M. Stationery Office.)

Technology of Cellulose Esters. By E. C. Worden. (In 10 vols.) Vol. i. Part i., Cellulose, Starch, Cotton. Pp. cxxv+664. Part ii., Nitric, Sulfuric, Mixed Acids. Pp. cxxvii+665-1566. Part iii., Nitro-cellulose: Theory, Practice. Pp. cxvii+1567-2376. Part iv., Historical Development. Pp. cxvii+2377-3086a. Part v., Index. Pp. 3087-3709. (London: E. and F. N. Spon, Ltd.) 10l. 10s. net (5 parts).

Manuel de Vannerie: Technologie Vannière. By E. Leroux and Prof. R. Duchesne. Pp. 376. (Paris: J. B. Baillièrre et Fils.) 10 francs.

The Journal of the Institute of Metals. Vol. xxv., No. 1, 1921. Edited by G. Shaw Scott. Pp. xiv+522+xxvii plates. (London: The Institute of Metals.) 31s. 6d. net.

University of Bristol. The Annual Report of the Agricultural and Horticultural Research Station (The National Fruit and Cider Institute), Long Ashton, Bristol, 1920. Pp. 102+4 plates. (Bristol.)

Primitive Society. By Dr. R. H. Lowie. Pp. viii+453. (London: G. Routledge and Sons, Ltd.) 21s. net.

Thermionic Tubes in Radio Telegraphy and Tele-

phony. By J. Scott Taggart. Pp. xxiii+424. (London: Wireless Press, Ltd.) 25s.

Geological Literature added to the Geological Society's Library during the Year ended December 31, 1913. Pp. 247. (London: Geological Society.) 5s.

Life of Alfred Newton, Professor of Comparative Anatomy, Cambridge University, 1866-1907. By A. F. R. Wollaston. Pp. xv+332. (London: J. Murray.) 18s. net.

The Physical Society of London: Proceedings. Vol. xxxiii., Part iv. Pp. 207-285. (London: Fleetway Press, Ltd.) 6s. net.

Diary of Societies.

THURSDAY, JULY 7.

MEDICO-LEGAL SOCIETY (Annual General Meeting) (at 11 Chandos Street, W.1), at 8.30.—Prof. A. Louise McIlroy: Some Factors in the Control of the Birth-rate.

MONDAY, JULY 11.

ROYAL BOTANIC SOCIETY OF LONDON, at 3.—Prof. A. R. Bickerton: The Generic Simplicity and Great Importance of Basic Principles in all Scientific Work. II. The Importance in Biological Science of a Clear Comprehension of the Orbit and Axial Inclination of the Earth.

CONTENTS.

	PAGE
Internationalism	577
What Relativity in Science Implies. By Prof. H. Wildon Carr	578
A New Book on Cactaceæ. By N. E. Brown	580
A Study in Geo-chemistry. By Prof. H. Louis	581
Our Bookshelf	582
Letters to the Editor:—	
Pathogenic Organisms in the Pollen of Flowers and Disease in Bees.—Hon. Col. C. J. Bond, C. M. G.	584
The Nature of the Electrical Conductivity of Glass.—Horace H. Poole	584
The Displacement of Spectral Lines by a Gravitational Field.—Prof. H. J. Priestley	585
The Measurement of Single and Successive Short Time-Intervals.—Prof. Alan Pollard	585
Sex-change in the Native Oyster (<i>O. adulis</i>).—Dr. J. H. Orton	586
A New Acoustical Phenomenon.—Dr. H. Hart-ridge; H. S. Rowell; Prof. W. B. Morton	586
An Algebraical Identity.—Dr. H. C. Pocklington, F.R.S.; Rev. J. Cullen, S.J.	587
Artelacts and their Geological Age.—T. Sheppard	587
Iron Currency-Bars.—O. G. S. Crawford	587
History of the Churn.—R. Hedger Wallace	587
Cosmogony and Stellar Evolution. II. By J. H. Jeans, Sec.R.S.	588
The Edinburgh Meeting of the British Association. By Prof. J. H. Ashworth, F.R.S.	590
Annual Visitation of the National Physical Laboratory	592
Scientific Publications for Russia	594
Friendship. (To T. H. R.) By Prof. Walter Garstang	594
Conference of American and British Engineers	594
Obituary:—	
Abbott H. Thayer. By E. B. P.	596
Notes	597
Our Astronomical Column:—	
The Cape Observatory	601
The Comet Pons-Winnecke	601
The Figure of the Earth	601
Sir Ernest Shackleton's New Expedition. By R. N. R. B.	602
Milk Customs of Bunyoro, Central Africa	602
Trees and Shrubs of Mexico	603
University and Educational Intelligence	603
Calendar of Scientific Pioneers	604
Societies and Academies	605
Books Received	608
Diary of Societies	608



THURSDAY, JULY 14, 1921.

Editorial and Publishing Offices:

MACMILLAN & CO., LTD.,

ST. MARTIN'S STREET, LONDON, W.C.2.

Advertisements and business letters should be
addressed to the Publishers.

Editorial communications to the Editor.

Telegraphic Address: PHUSIS, LONDON.

Telephone Number: GERRARD 8830.

The London Electricity Inquiry.

THE inquiry into the electric supply for London, which was opened by the Electricity Commissioners on June 14, is still proceeding. Owing to the many conflicting interests of the companies and the local authorities, the question is very complicated; but as there is practical agreement on the engineering side it is hoped that an agreed scheme will be evolved. The Commissioners have to consider six proposals, but only three of them both cover (or nearly cover) the whole area and consider the appointment of a Joint Authority as contemplated by the Electricity Act of 1919. These three proposals were submitted by (1) the London County Council; (2) the conference of local authorities owning electricity undertakings in Greater London; and (3) the London Electricity Joint Committee, 1920, Ltd., which comprises nine of the leading London supply companies. In addition there are also proposals by (4) the Metropolitan Borough Council of Poplar, which asks that the East London supply should be considered as one district; (5) the Great Eastern Railway Co.; and (6) the London, Brighton, and South Coast Railway Co.

The first three proposals have much in common from the engineering point of view. It is recognised that, owing to the financial conditions prevailing at present, the proposals suggested in 1914 for the immediate erection of capital stations would not now be advantageous, although the demand for electric power is much in excess of the supply. At present prices it does

not pay to shut down even antiquated stations and to replace them by others more efficient. The L.C.C. scheme (1) is based on the retention and development of certain of the existing stations in the area, whilst the other stations gradually cease to be generating stations. In the original scheme the building of capital stations before 1925 was contemplated, but it is now thought inadvisable to hamper the "Joint Electricity Authority" with a large capital outlay. It is proposed to organise on a sound basis the present facilities in the area. In the first stage of the scheme as now modified eighteen of the existing sixty-one generating stations will be gradually shut down, and in the second stage a further twenty-six will disappear, leaving only seventeen, of which twelve are owned by private companies. In the first stage thirty-one of the stations would be interlinked by high-pressure cables, working pressures of 33,000 and 11,000 volts being used for the interconnecting mains. Considerable economies could thus be effected by diminishing the capital plant required and having engines running only at their most economical load. It will be seen that the proposal is a direct reversal of the earlier electrical legislation, which always contemplated having two competing companies in each district.

After 1925 the L.C.C. contemplates the building of four new capital stations each of 250,000 kilowatt capacity. It also proposes to reconstruct the existing stations at Stepney and Deptford on a much larger scale. All the new stations would be situated on the Thames. The one at Chiswick would be capable of supplying the whole of Middlesex at 33,000 volts. The remaining stations would be east of the Blackwall tunnel at Blackwall, Beckton, and Greenwich respectively. It is calculated that by extending existing stations and interlinking them there will be a total plant capacity of 577,000 kw. available in 1925, and this could supply a demand for 500,000 kw. It is thus possible to postpone the erection of these super-stations in the hope that money and plant will be cheaper after 1925. The maximum power available by extending existing stations is 760,000 kw., but it is probable that in four years' time the gain in lower working costs effected by building these large stations will more than offset the higher capital charges that would have to be met.

The companies (3) desire to restrict the area—at least in the first instance—within a radius of ten miles from St. Paul's. In their opinion it

would not be economical to supply the outlying districts until the demand increases. They differ also from the L.C.C. and the local authorities in the constitution of the "Joint Authority" which they propose. They suggest that it should consist of sixty-two members. As most of the work would have to be delegated to technical committees, we think that a council of this size is much too big and would prove unworkable.

Very divergent opinions are held by some of the County and Borough Councils interested in the schemes. For example, the Middlesex County Council wants to be excluded, while the Surrey County Council, although only part of its territory is involved, wants to be included. The representative of the Poplar Borough Council, which has a scheme (4) of its own, objected to all the first three schemes.

It was pointed out, when the 1919 Electricity Act was passed, that it would be to the mutual advantage of the Joint Authority and the railways that the former should supply electricity to the latter. Some of the railway companies, including (5) and (6), think that they will be able to generate electricity more cheaply themselves, one of the reasons adduced being that the Joint Authority would not be able to borrow money more cheaply than the railway companies can, and would be hampered by having to provide a sinking fund on its capital, no such necessity arising in the case of the railway companies. We think that this is a very doubtful reason. It seems probable, however, that in any agreed scheme consideration of any railway load will be excluded, at least for the first few years.

The brief account given above of the first results of the inquiry will show that the great expectations which some engineers based on the 1919 Electricity Act have still to be realised. Financial considerations and vested interests have proved stumbling-blocks. But it is very satisfactory to note the conciliatory spirit in which the engineers immediately affected by the proposals have considered them.

Supply engineers recognise that fuel economy is the most important problem they have to study. Recent tests show that in the boiler-house it is possible by scientific management to employ usefully from 80 to 85 per cent. of the calorific value of the fuel. It is heart-breaking, therefore, for some engineers to have to use old-fashioned engines which consume 40 to 50 per cent. more steam per horse-power developed than the best modern engines. In the national interest it is

necessary that these engines should be scrapped at the earliest possible moment. The great increase in electric power consumption is well exemplified in the case of the city of Sheffield. The 1914 consumption was 20 million units. It is now 172 million units, the coal consumption being 5000 tons per week. In this connection we hope that the use of raw coal for steam-raising will soon be a relic of barbarism. There is no difficulty in designing furnaces for utilising coke, and several are in everyday use. The economies effected by using powdered fuel are also worth considering.

A hopeful sign of the times is the increasing co-operation between the electricity and the gas industries. At the inquiry Mr. G. W. Partridge, giving evidence in support of the companies' scheme (3), said that arrangements had been made with the Gas Light and Coke Co. with regard to leasing part of that company's site at Beckton for erecting a super-station which it was proposed to build in sections as the demand grew. Owing to the large quantity of coke and coke breeze on the site, much of which at present goes abroad, the cost of fuel would be very appreciably cheapened. The gas company would also be willing to let to the companies the use of the existing wharves, piers, railway sidings, etc. There would thus be a great saving in capital outlay. Any of the improvements, which are hopefully looked forward to, in the carbonisation of coal, the utilisation of waste heat, and new by-products would be to the mutual advantage of the two interests.

The history of electric supply in this country is largely one of legislative interference with a flourishing industry. We are glad that the industry is now so largely dependent on private initiative. Engineers have no delusions about receiving large Government grants, although the supply of cheap electric power, bringing new industries to life, is vital to the prosperity of the country. The inquiry has proved that the supply engineers are willing to accept the best and, consequently, the most economical solution, even if at first it affects their private interests adversely.

Congress of Universities.

AT Oxford last week the second congress of the Universities of the Empire was held under perfect conditions as to weather and public and private hospitality. The large and distinguished assembly which forgathered in the examination halls on four successive days was drawn from fifty-nine universities widely

separated geographically, but inspired by the same ideals and working for the same increasing purpose. This number, it may be observed, has not grown markedly since 1912, when the first congress was held in London; but those who were privileged to attend both congresses must have been impressed by the different conditions, moral and economic, which have arisen during the intervening nine years. Lord Rosebery, in his opening address to the first congress, spoke with eloquence and prevision on the throes of travail which the world was at that time undergoing to produce something new to history—"something, perhaps, better than anything we have yet known, which it may take long to perfect or to achieve, but which at any rate means a new evolution." Two years later the thunderclap of war burst over the world. Evolution ceded place to a process more catastrophic in both its physical and its spiritual workings. May it not be said that the universities, stunned and hesitating, are still groping their way in the new world which is in slow and tentative formation?

Assuredly the note of uncertainty was frequently sounded in the papers read at the congress. Prof. Desch, in an address on the place of the humanities in the education of men of science, asserted that scientific education to-day lacked the "synthetic view" which would harmonise the laws of human society and of the physical universe and life. "Science without sociology is imperfect, but with it the artificial division between scientific and humanistic studies disappears." The relation of the universities to secondary education would appear to be a subject upon which definite conclusions should by this time have been reached by those who have applied their minds to the problem. Prof. John Burnet, the distinguished classical scholar of St. Andrews, confessed that his chief qualification to act as spokesman on this question appeared to be that he had failed in rather a conspicuous manner to find a solution which commended itself to anyone in his own country. Universities have been engaged in the training of teachers from their origin, and have for centuries granted to their masters of arts the *jus ubique docendi*. But, as Prof. John Adams pointed out, the principle that all teachers should be trained in universities is not yet established, and there is indeed a dangerous tendency for local authorities to train directly their own teachers within their own areas.

The subject of adult education found eloquent exponents in Lord Haldane, Prof. G. H. Leonard,

Sir Michael Sadler, and other speakers; but how vast and inchoate the issues must appear to universities harassed, almost overwhelmed, in the discharge of their immediate obligations! If there is one lesson enforced by the war, it is the danger of neglecting the applications of science. We find ourselves, as Prof. Smithells pointed out in a singularly temperate and closely reasoned address on the universities and technological education, "a people far spent by the cost of victory over a nation of technologists, a nation which had carried to the highest point the training of its people in applying exact science to the mechanical arts of both peace and war." Nevertheless, he was constrained to raise his voice against the unbridled pursuit of applied science and to direct attention to the restraints under which it should be fostered. The Germans, he admitted, among their excesses of regimentation, had good cause to reconsider their educational plan of isolating seminaries of technology. Technological studies must be given their proper place in our universities as a necessary part of the educational organism.

This line of thought was developed also by Sir Robert Falconer, president of Toronto University, who denounced the conception of a university as a set of public utility schools bundled together by the tie of a common administration. A university should be an organism with an intellectual and moral spirit giving it unity and life. The discussion on the nationalisation of universities raised the temperature of the congress by a few degrees. It is noteworthy that the idea of nationalisation has greater terrors at home than in the overseas dominions, some of the representatives of which seem disposed to hug their chains.

We have referred to a few of the questions of university politics and organisation which were discussed at the congress. There are others not less pressing. The relations of the central and local education authorities to university education in this country are still, in a large measure, unsettled. Further, the question of the future supply of university students under existing economic conditions gives cause for grave anxiety. In NATURE for June 30 we published statistics of students receiving university education, which indicated a total full-time student population for the United Kingdom in 1919-20 of 52,600, of whom nearly 17,000 were ex-Service students. Is it not obvious that this *net* total, assuming it will be maintained, is entirely inadequate to meet the future needs of our great and extending Empire?

The question of the establishment of new universities—how many, in what districts, and with what special characteristics—has to be examined. There are also questions relating to the co-ordination of university work with the view of obtaining the maximum benefit from the minimum expenditure, a consideration which in future will be increasingly in the minds of public men and public authorities. We are reluctant to criticise a congress which has been the means of publishing so many useful contributions to educational thought; but it is impossible to overlook the need for a more systematic discussion of these questions of university organisation and for the formulation of guiding principles. As Lord Rosebery insisted at the first congress, every university must work out its own salvation in its own way, and a centralisation of the Universities of the Empire would be demoralising to them and fatal to their growth and development. Acceptance of this general idea should not inhibit an orderly study of various questions of university organisation, the decision of which is already long overdue. If the universities limit their contributions to these discussions to expressions of personal opinion, however adroit and enlightened, the task of finding solutions to these difficult questions will have to be undertaken by some other authority.

A Psychology of Logic.

Psychologie du Raisonnement. By Eugenio Rignano. (Bibliothèque de Philosophie Contemporaine.) Pp. xi+544. (Paris: Félix Alcan, 1920.) 18 francs.

THE distinguished editor of *Scientia* has given us in this volume a valuable and most useful study, which is likely to take its place as a recognised book of reference. It is original, both in its method and in its subject-matter, to a very high degree, and part of its originality is the way in which it brings together, and works into a complete scheme, the researches and theories based on the researches of experimenters and theorists in all the sciences. The main purpose is to present a psychology of reasoning. By reasoning is meant the higher logical processes of the mind which are distinctive of intellect, and by psychology a descriptive science which interprets a definite domain of reality by bringing it into relation with other domains.

The theory is given in the chapter entitled "Qu'est-ce que le raisonnement?" This appeared as the first of a series of articles, in *Scientia* eight

or nine years ago, and it forms now a kind of centre or nucleus around which the argument plays. The answer to the question is that reasoning is nothing but a consecutive series of actions or experiments carried out simply imaginatively in thought and not effected materially. The result of the imaginatively represented process is the demonstration or conclusion to which reasoning leads and at which it aims. Reasoning is experimenting internally, thoughts are merely imagined acts.

It will be seen, therefore, that Signor Rignano's psychology moves on the scientific plane and ignores the metaphysical problem. It accepts existence and is unconcerned with the genesis or with the ultimate nature of reality. Given the physical, biological, and physiological basis, psychology can define its data by relation to it. Memory, perception, and productive and reproductive imagination can be described and their function, scope, and limitations determined. The scheme of the work is then clear. A psychology of logic has to show, first, the evolution of reasoning from inferior forms of mind which do not attain to it; secondly, the evolution of reasoning itself into its higher forms; and, finally, the positive factors as they are revealed by the study of abnormality.

On the basis of the assumption that mentality is a phenomenon within the objective world of physical science and presupposes the independent existence of that world, it is undeniable that a great deal of practically useful science can be formulated. The author's numerous, excellently chosen illustrations of the reasoning process are very fascinating. They provide the kind of interest which used to thrill us in the old descriptive "natural histories." Certain doubts as to the soundness of the method, however, very soon invade us. There are extraordinary stories of animal intelligence—all standard illustrations and taken from recognised authorities (Romanes, Jennings, and others), and to be differentiated, therefore, from the tall stories which fill the correspondence columns of some newspapers; but, even so, it is questionable whether they do not darken rather than enlighten judgment as to the mode of working of the animal mind.

To understand the mentality of a dog or of an amœba, surely we ought to study the most ordinary responses and not single out some special case of anthropomorphic behaviour as peculiarly significant. This vice of method spoils a good deal of Signor Rignano's excellent work. For example, take his theory of intuition. In contrast with deductive reasoning, intuition is character-

ised by immediacy. But this immediacy, if we have understood the author correctly, is always relative: the reasoning has been so swift that we have not noticed the stages. Intuition is simply a telescoping of that imaginative experimenting in which all reasoning consists. No one, we venture to suggest, would adopt such a view had he studied instinctive behaviour directly and in its general aspect without attempting to base theories of genesis on specially induced experiments, whether on the infusoria or on the higher vertebrates. The theory may not be wrong, but the method is suspect.

One of the most penetrating and instructive sections is the critical review of the forms of mathematical reasoning. Algebra stands at the top of the scale, logistic at the bottom. The former never parts company completely with the concrete as the latter does. Moreover, logistic stands condemned in our author's view for its utter inability to advance by reasoning to any new fact. Creative imagination is the driving force of reasoning, and this is not only absent from, but also definitely eschewed by, logistic.

Where Signor Rignano will seem to some to fail is in what he denies rather than in what he affirms. The concept when detached from the sensible imagination is for him purely verbal. A concept, self-contained and self-subsistent, a concrete universal, has no place in his theory of reasoning, and in itself is unintelligible. The polemic against metaphysics seems to us the weakest part of his book, and as it is quite unnecessary to his argument its introduction is to be regretted. The metaphysical inquirer is described as one who is determined at all costs to save values. He is moved by affective, and not by intellectual, motives. The reply is simply that, as a matter of fact, it is notoriously untrue. The philosopher, as philosopher, is absolutely indifferent to values as values. What impels him to metaphysical inquiry is not desire, or emotion, or affective consideration of any kind; it is the pure need of intellectual satisfaction. Even the author protests that the most "positive" and least metaphysical of inquirers cannot be indifferent to values—why, then, is it presumed to vitiate the motive in one case and not in the other?

Regarded from the author's point of view, as it should be, the book is full of interest, clear and sustained in its argument, and maintained throughout at a high level. We hope there will be a good English translation, for it should prove an excellent text-book for advanced courses.

H. WILDON CARR.

Text-books on Theoretical Chemistry.

- (1) *Die chemische Literatur und die Organisation der Wissenschaft.* By W. Ostwald. (*Handbuch der allgemeinen Chemie.* Band 1.) Pp. iv+120. (Leipzig: Akademische Verlagsgesellschaft m.b.H.: Gustav Fock, 1919.)
- (2) *The Foundations of Chemical Theory.* By Prof. R. M. Caven. Pp. viii+266. (London: Blackie and Son, Ltd., 1920.) 12s. 6d. net.
- (3) *Inorganic Chemistry.* By E. I. Lewis. Third (revised and enlarged) edition. Pp. xv+443. (Cambridge: At the University Press, 1920.) 9s. net.

(1) **P**ROF. OSTWALD'S book constitutes vol. i. of the "Handbuch der allgemeinen Chemie" which he is editing in conjunction with a number of eminent collaborators—Kuenen, Drucker, Marc, Bruni, Dutoit, Cohen, Halban, Bredig, and others—all recognised authorities on the several sections of physical chemistry to which they contribute. This introductory volume is, in effect, a long and discursive essay on the methods of propaganda of science and on the gradual development of the means of disseminating scientific truth. It traces the spread of scientific knowledge through the agency of societies, general and specialised, by means of discussion and publication, by scientific journals, and lastly by treatises, monographs, and text-books. It contains nothing but what is generally known to those familiar with the history of science, but the story is put together with considerable skill, and constitutes an eminently philosophical disquisition on an aspect of that history which has hitherto had few expositors.

Towards the conclusion of his essay Ostwald gives a free rein to his imagination in seeking to forecast the lines upon which the dissemination of scientific knowledge must proceed in the future. He is thus naturally led to what is an obsession with him—the possibility of the universal language—and we are treated to a short *excursus* on the relative merits and disadvantages of Volapük, Esperanto, and Ido. Recent events, for which Prof. Ostwald's own countrymen are wholly responsible, have absolutely shattered whatever hopes he may have entertained of the speedy realisation of his ideals. But, as he says in his preface: "Die Schrift wurde bereits 1914 fertiggestellt und gesetzt: die Ausgabe ist durch den Weltkrieg bisher verzögert worden." To allow the concluding paragraphs to remain unaltered when the work appeared in 1919 is characteristic of German mentality. It requires a very robust faith in the future to believe in their appositeness in present circumstances. We fear that the

probability of the learned author being called upon again to preside over such a gathering in Paris as that which met there in 1907 to discuss the universal language is, to say the least, very remote. Nor have the prospects of German co-operation in the International Association of Chemical Societies, which Prof. Ostwald laboured to found when in Paris, and the Belgian manufacturer, Ernest Solvay, so generously endowed, been rendered any brighter by Prof. Ostwald's subsequent action in connection with the notorious *pronunciamiento* of German "intellectuals," directed against his quondam friends in France and England.

(2) Prof. Caven's book on "The Foundations of Chemical Theory" is an attempt to explain the fundamental conceptions which constitute the basis of the modern theory of chemistry. It is avowedly an introductory text-book, primarily intended for the young student with an elementary knowledge of the science; but it is also hoped that it may be within the compass of the general reader who, in the words of the preface, "wishes to know what modern chemistry really means." We fancy that the general reader who peruses the book will have a rude awakening in that respect. Recent occurrences have led him to believe that modern chemistry is mainly a matter of munitions—high explosives and poison-gases. He will find nothing relating to these subjects in the book, but he will be introduced to such eminently non-militant matters as the atomic and molecular theory, the periodic law, the doctrine of valency, reversible reactions, complex ions, and catalysis. The scope of the book is thus sufficiently indicated. In fourteen chapters distributed over 262 pages the author describes in simple and concise language the main principles and facts upon which theoretical chemistry rests.

The work is well written and forms interesting reading. The judgment of the author is, however, occasionally open to question. There are, for example, two opinions as to the expediency of the standard $O=16$ adopted, largely at the suggestion of the Germans, by the International Committee on Atomic Weights. At the recent conference in Rome it was proposed—and the proposition was favourably received—that the committee should revert to the old standard $H=1$. Prof. Caven expresses the hope that no such modification of the standard will be made. There is no question that any change will lead to confusion, but it is open to doubt whether the consequences will be so serious as Prof. Caven surmises. Even under a constant standard there have been numerous instances of changes in the value of an atomic

weight, due, not to the variable standard, but to improvements in the methods of determining the constant. The atomic weight of chlorine, which the author adduces as an instance of confusion due to a changing standard, has been referred to a constant standard for many years past; but the value has suffered a progressive diminution owing to more rigorous experimental inquiries. The same is true of several of the fiduciary values employed in atomic-weight determinations. At the same time, there is much to be said for the retention of the present standard. It is remarkable how many of the atomic-weight values approximate to whole numbers, and are thereby more easily remembered and more convenient in use. The contention of Stas has lost much of its force, since the ratio of $H:O$ is now known to a very high degree of accuracy. The question is certain to be discussed by the reorganised committee in the near future, and it will largely turn on the relative merits of rationalism and expediency, for which the recent re-issue of Lord Morley's "Compromise" may well prepare the members.

For an elementary text-book the work may be said to cover its subject-matter adequately, and it is put together with a due sense of proportion. It is reasonably up-to-date, and, so far as we have been able to discover, it is free from errors. We would, however, point out that Hofmann's name in the table of contents is wrongly spelled, and the mistake is repeated on pp. 27 and 29.

The student who works through this book carefully and intelligently will acquire a considerable stock of chemical facts, and gain a sound knowledge of the generalisations to which they have led.

(3) Mr. Lewis's book on inorganic chemistry, originally published in 1907, is now in its third edition. It is designed for school teaching, and in the preface to the first edition, which is reprinted, the author describes his methods and the plan of his course of lessons. No attempt is made to cover the whole ground of inorganic chemistry; this is not called for where the main object is to teach principles and illustrate them by relevant facts. The plan of the work is original and has evidently been well thought out; for advice concerning it Mr. Lewis was indebted to many Cambridge friends, among them the late Mr. Humphry Jones and the late Mr. F. H. Neville. Mr. Lewis is, indeed, very faithful to his *alma mater*, and he loses no opportunity of acknowledging his gratitude to her and her sons. The lessons are accompanied by carefully chosen experiments, the apparatus for which is illustrated by figures in line drawing.

Each section is followed by "problems," some of which, it must be admitted, are absurdly "academic." Thus, to give the weight of a crucible as 26.59625 grams is what the Germans call "Decimalspielerei," and is apt to convey a perfectly illusory impression of the degree of accuracy attained in an ordinary weighing. The problems should be not so much arithmetical exercises as examples of the principles involved, and to this end it is unnecessary and unwise to inflict upon the student an unwieldy row of decimals which, especially in the hurry of written examinations, may land him into arithmetical blunders and so defeat what should be the real object of the examiner. It is also desirable that foreign proper names should be correctly spelled. The colleague of Dulong in the formulation of the law connecting atomic weight with specific heat is not usually styled Pettit (p. 141), nor, although there are variants in the name, is Ingen Hous (p. 183) commonly so written. Oxygen was discovered by Priestley on August 1, 1774, and not in 1775, as stated on p. 249 and elsewhere. As a matter of fact, Priestley had prepared it from nitre in 1771 without actually recognising it. Scheele, as is now known, was an independent discoverer, and had probably obtained the gas some time prior to 1774; but his first announcement of its existence was made in his treatise on Air and Fire, published in 1777.

Every conscientious teacher, properly equipped with knowledge and experience, and gifted with sympathy and enthusiasm, evolves his own methods of instruction sooner or later; but he can always learn from other teachers, even if at times it is only the negative gain of "how not to do it." From Mr. Lewis his gain will be positive. He will find his system rational and well-ordered, his methods of exposition clear and direct, and his experimental illustrations carefully chosen and strictly to the point.

A Jungle Book.

The Diary of a Sportsman-Naturalist in India.
By E. P. Stebbing. Pp. xvi + 298. (London: John Lane; New York: John Lane Co., 1920.) 21s. net.

A GREAT part of Mr. Stebbing's book is devoted to the sport and natural history of the big-game jungles of India, and no reader will escape their fascination. They are so primitive, so wild, so full of the unexpected, so tragic in their hidden vestiges of remote civilisation, and withal so rich in possibilities of present-day pleasure—to the sportsman-naturalist especially.

"The log fire burning and crackling merrily outside, the subdued buzz of talk from the servants' lines, the whinnying of the picketed ponies or the shrill voices of the syces raised in execration when a biting or kicking match commences, the dull rumbling of the elephants engaged on their fodder, resembling distant thunder; the great columns of trees forming a background to the camp, on to which the camp-fires cast fitful shadows, whilst overhead the picture is closed in by the blue-black vault picked out with innumerable jewels and spangled with diamond dust. How pleasant it all is. . . ."

Mr. Stebbing tells of his first bull bison (*Bos gaurus*), his first sambhar stag, his first tiger, his first leopard, his first bear, his first boar, not to speak of creatures like pangolins and porcupines which the naturalist enjoyed and the sportsman spared. It is a sanguinary book, but it is very well written, and the tale is adorned with vivid thumbnail sketches by the author and with excellent photographs by Mrs. Stebbing, Mrs. E. M. Sparkes, and Sir John Prescott Hewett.

Mr. Stebbing's general impressions of the jungle are very interesting. One is the warning which the jungle folk pass on when danger is approaching. "This warning, though intended for the friends of the utterer, is understood by the whole community, even though among themselves they may be respectively the oppressor and oppressed." From the moment the tiger or leopard is descried,

"every animal in the jungle is put at once on its guard by the performance of the birds and monkeys. The deer know perfectly well what it portends, and remain on the alert till their enemy has left the neighbourhood. In fact, it is quite common for a tiger or leopard, once he has been discovered in a jungle, to be fairly mobbed out of it; for he knows that once all the jungle animals have been informed of his presence he has a poor chance of getting even a plump young doe to make his meal off."

Another impression is the great difficulty experienced in "picking up" the animals—from elephant to partridge—in their natural surroundings.

"Even a large animal like the tiger can move along in his surroundings in an almost invisible manner. His outline becomes merged in the general colour of the grass or scrub jungle, but there is nothing definite to pick up, and when he is motionless he is almost invisible, if not quite, to the untrained eye. . . . It is usually the eyes of the animal which are first perceived if it is facing the observer. . . . Whilst, therefore, in a new environment and with an untrained eye, the newcomer finds some difficulty in picking out any of the animals in his neighbourhood from their surroundings, the reverse is the case with the jungle

folk. They will hear, smell, and see him seconds, even minutes, before he has any chance of getting on terms with them."

Some people have spoken of the silence of the Indian jungles; but this is true only of the hotter part of the day, when most of the mammals and birds are taking their siesta. In the morning and evening, and at night, the jungles are full of sound.

The interrelations of living creatures are perennially interesting, and Mr. Stebbing gives some fine examples. Thus certain caterpillars, which he names, defoliate great blocks of teak forest, leaving them exposed to the hot sun and hot winds so that the undergrowth becomes scorched and withered. The deer and some other mammals have to quit these shelterless tracts.

"The termite has its uses in the Indian forest, for it rapidly disposes of the vast amount of refuse branches and dead fallen stems which without its aid would accumulate on the forest floor and greatly add to the risk of fires and increase their intensity when they took place, in addition to making progression impossible for man or beast."

The red ants are a source of great trouble to man, though he does make a paste of them which is eaten as a condiment with curry!

"The red ant lives in the trees and builds nests of the leaves. Such nests are a common sight in the *sál* forests. The nests are constructed in an ingenious manner, the edges of the green leaves being gummed together. The mature ant does not possess any material with which to perform this work. His gum bottle he finds in the immature ant, which has glands secreting a sticky substance. Several of the adult ants hold the leaves together, whilst another seizes a youngster between its mandibles and uses him as the brush of the gum bottle. It shows either a high form of civilisation or a low form of sweating to thus make the children share in the labour of house-building."

The second part of this interesting book deals with the means to be taken to preserve the forest game animals from poachers and unsportsmanlike sportsmen, and this in turn leads to the larger question of the preservation of the Indian land fauna as a whole. Some of the finest game animals are now within measurable distance of extinction, and the creation of game sanctuaries has been commenced with the view of affording protection to certain animals, such as the bison, rhinoceros, and deer. Apart from game, many components of the fauna are of economic value, and zoologically all are interesting. Mr. Stebbing pleads convincingly for large permanent sanctuaries, from which sportsmen, collectors, exploiters, and the like would be barred. One

almost feels as if Mr. Stebbing had seen St. Hubert's vision in the course of his book, for he becomes steadily less sanguinary and more of a naturalist. Nevertheless, it is very good reading through and through.

Elementary Pure Mathematics.

- (1) *The School Geometry: Matriculation Edition.* By W. P. Workman and A. G. Cracknell. Pp. xi + 348. (London: W. B. Clive, University Tutorial Press, Ltd., 1919.) 4s. 6d.
- (2) *Modern Geometry: The Straight Line and Circle.* By C. V. Durell. Pp. x + 145. (London: Macmillan and Co., Ltd., 1920.) 6s.
- (3) *The Elements of Analytical Conics.* By Dr. C. Davison. Pp. vii + 238. (Cambridge: At the University Press, 1919.) 10s. net.
- (4) *An Algebra for Engineering Students.* By G. S. Eastwood and J. R. Fielden. (With answers.) Pp. vii + 199 + xv. (London: Edward Arnold, 1919.) 7s. 6d. net.
- (5) *Elements of Vector Algebra.* By Dr. L. Silberstein. Pp. vii + 42. (London: Longmans, Green, and Co., 1919.) 5s. net.
- (6) *Graphical and Mechanical Computation.* By Dr. J. Lipka. Pp. ix + 264. (New York: J. Wiley and Sons, Inc.; London: Chapman and Hall, Ltd., 1918.) 18s. 6d. net.

(1) **T**HIS book is in reality sections i.-iv. of the authors' "Geometry: Theoretical and Practical," adapted to the requirements of students preparing for the matriculation and similar examinations. It combines the theoretical with the practical. After an introductory course of practical geometry based on intuition, there follows a series of propositions and theorems amounting, roughly, to "Euclid," Book I., Book III., Book II., and Book IV. The presentation and treatment call for no special comment; they are clear and concise, in the well-known style of the University Tutorial Series. There are many exercises of all kinds and of all grades of difficulty; many of the riders are provided with hints as to which theorems they are based on, and the student is thus led on to discover for himself the best methods for dealing with such exercises.

A few points deserve special mention. The definition of space on p. 34 is not likely to convey anything very clear or even intelligible to the average matriculation candidate. The theorem that the sum of the interior angles of a polygon of n sides is $(2n - 4)$ right angles is unnecessarily restricted to convex polygons. Another figure is required on p. 85. Some misprints and one or

two bad diagrams are but minor blemishes on this excellent guide for matriculation candidates.

(2) Mr. Durell's book on the modern geometry of the straight line and circle was intended as a new edition of his "Course of Plane Geometry for Advanced Students, Part I.," published in 1909. There have been, however, such considerable changes that the author has preferred to issue the book under a new name. It contains a pleasant and useful account of the geometry required by scholarship candidates at public and secondary schools, giving the usual work on rectilinear figures, similar figures, harmonic ranges, quadrilaterals and quadrangles, poles and polars, inversion, etc. There is a chapter on vector geometry with statical applications, while in dealing with inversion and coaxial circles the author very wisely makes use of analytical methods and notation. The treatment is sound, and the exercises are numerous.

(3) Many books exist dealing with analytical conics, and presumably every author of such a book aims at making the student interested in this eminently important branch of pure mathematics. Nevertheless, new books on the subject will continue to be scanned with anxiety by teachers of mathematics, because there can be no doubt that many students find the subject difficult, and the existing books scarcely afford them the help they need. One must say at once that Dr. Davison's book is no exception to the rule. It is a clear and sound investigation of the ordinary analytical theory of the straight line, circle, and conic sections, carried out on the orthodox principles and in the orthodox manner. The student who is desirous of learning the subject, and is intellectually and mathematically capable of following the argument, will no doubt study the book with profit, for there are very many examples, revision exercises, and a number of problem papers on the subject. The book is well produced and printed in the clear and interesting style that we have learnt to associate with the Cambridge University Press.

For a possible second edition we would recommend a few corrections and slight additions. In dealing with the distance of a point from a straight line, something should be said about the somewhat difficult question of the sign of the distance. There are *two* tangents to a circle, ellipse or hyperbola, having a given direction. The author assumes that the equation of a circle or conic is of the second degree; this assumption is not good pedagogics in a course of the kind he has produced. Is there any particular reason for putting the equation of an ellipse in the form $b^2x^2 + a^2y^2 = a^2b^2$? The classical form with a^2, b^2

in the denominators looks simpler and is easier to remember. The director circle of a hyperbola appears to be subject to various vicissitudes, depending upon whether the real axis is greater or less than the imaginary axis; this should be mentioned. There are several misprints; the worst occurs where the co-ordinates of a point on a circle are called $(a \cos \phi, b \sin \phi)$.

(4) "An Algebra for Engineering Students" aims at giving all the knowledge of algebraic principles and processes that engineers should possess before commencing the calculus as applied to engineering. As a particular class of student is catered for, theoretical proof is in places made to give way to illustration and verification, and no one who has any experience of teaching mathematics to engineers will quarrel with the authors on this account. The subject-matter is the ordinary elementary algebra up to and including quadratic equations, and, in addition, indices, surds, logarithms, arithmetical progressions, ratio and variation are dealt with. Graphs and graphical methods are discussed in a competent manner, and the elementary use of the slide rule is explained. A few nomograms are included, but not in such a way as to afford the reader any real insight into their construction or use. The examples are of a practical type, but one cannot help remarking that the worked example on p. 3 is as artificial as any to be found in the "dry" theoretical books.

(5) Dr. Silberstein is an acknowledged exponent of vectorial methods, and anything that he writes on vector algebra bears the stamp of authority. The present book, although intended for optical computers who wish to use vector methods in optical computation, is equally useful to all who wish to read a clear and easy account of the elements of the subject. The ordinary processes of addition and subtraction, and of scalar and vector multiplication, with extensions, are dealt with first; then follows an account of linear vector operators, leading up to dyads and dyadics. Hints on the differentiation of vectors complete a useful little volume. The division of the book into chapters, and the addition of some examples of a practical nature, would increase its value manifold.

(6) Computation and graphical methods of calculation are assuming an increasing importance in mathematical teaching, especially for such students as are preparing to use their mathematics in some industrial or vocational application. Several universities and university colleges have instituted mathematical laboratories, and a book like Dr. Lipka's "Graphical and Mechanical Com-

putation" should be welcome to both students and teachers in such places.

The author has put into book form the course of lectures he has been giving to engineering classes in the mathematical laboratory at the Massachusetts Institute of Technology. It is a comprehensive course, including a discussion of various kinds of scales and the slide rule, networks of scales for several variables, nomographic charts, empirical formulas (with the method of least squares), periodic curves, interpolation, and approximate integration and differentiation (with various kinds of planimeters, integrators, integragraphs, etc.). Each part of the subject is dealt with in some detail, with the result that the book is a mine of useful information on practically all the processes that occur in computational or graphical work. One may, perhaps, think that the subject-matter is too condensed both in treatment and in actual print, but as a foundation for a course in a mathematical laboratory the book can be recommended without hesitation; it should find a place in every mathematical and engineering or technical library, and serious students will find it a continual help in their industrial or research work.

A particularly exhaustive treatment from the practical point of view is given of nomography. Perhaps it would be better if the author had laid more stress upon explaining exactly how nomograms are to be constructed and used than upon the reproduction of so many nomograms. This is, however, a matter of taste, and what the author has put into this section of the book is on the same standard of excellence as the remainder. There are numerous examples, many of them worked out numerically in full. The book also contains accurate charts of uniform and logarithmic scales, as well as of square roots.

S. BRODETSKY.

Our Bookshelf.

Creative Chemistry: Descriptive of Recent Achievements in the Chemical Industries. By Dr. Edwin E. Slosson. (The Century Books of Useful Science.) Pp. xvi+311. (London: University of London Press, Ltd., 1921.) 12s. 6d. net.

THIS book is written by an American journalist with some knowledge of chemistry. It is intended for lay readers who wish to make themselves acquainted with some of the recent developments of applied chemistry, including nitrogen fixation, fertilisers, dyes, sugar, rubber, poison gas, and other subjects likely to be of interest to the average reader. The facts, which appear to be accurate and selected with care and discretion, are presented clearly and forcibly, with a certain

native humour. Gerhardt should not (p. 6) be described as a German chemist, while the account of the origin of Kekulé's theory of the benzene nucleus (p. 66) differs somewhat from that usually accepted. It is also interesting to know (p. 33) that "we might have expected that the fixation of nitrogen by passing an electrical spark through hot air would have been an American invention [it was discovered by the English chemist Cavendish], since it was Franklin who snatched the lightning from the heavens as well as our sceptre from the tyrant, and since our output of hot air is unequalled by any other nation."

A Little Book on Map Projection. By Mary Adams (Dr. William Garnett). New and revised edition. Pp. viii+112. (London: George Philip and Son, Ltd.; Liverpool: Philip, Son, and Nephew, Ltd., n.d.) 5s. 6d. net.

THE second edition of this useful book differs little from the first, which was published in 1914, but the author's identity is now revealed. Most books on map projection are either severely mathematical or, at the other end of the scale, so trivial as to have little value. Dr. Garnett strikes a happy mean, and contrives to give within a modest compass practically all that a student of geography requires to know of this difficult subject. He wisely takes nothing for granted, and as he develops his subject gives ample explanation at each step. About half the book is concerned with the principles involved, and the remainder with the consideration of the principal projections. The subject is treated with a freshness and lucidity which result in a most readable book. The treatment of Sanson-Flamsteed's, Mollweide's, and Mercator's projections may be specially noted. There are a number of clear diagrams and a short bibliography. The book should make a strong appeal to teachers and students.

Proceedings of the Aristotelian Society. New Series, vol. xx. Containing the papers read before the society during the forty-first session, 1919-20. Pp. iv+314. (London: Williams and Norgate, 1920.) 25s. net.

THE original papers included in this volume have already been noticed in the reports of society meetings. The present volume contains, in addition to the papers read at the ordinary meetings of the society, two of the symposia contributed to the Oxford Congress last September, in which the members of the French Philosophical Society took part. Of particular interest in this volume is Prof. J. A. Smith's sympathetic account of the philosophy of Giovanni Gentile, an Italian philosopher, the originality of whose speculation, already acknowledged in his own country, is beginning to be recognised universally. We may also mention as of special scientific interest Mr. A. F. Shand's article on "Impulse, Emotion, and Instinct," and Dr. Beatrice Edgell's article on "Memory and Conation." The volume is well up to the high level of the proceedings of previous years.

Letters to the Editor.

[The Editor does not hold himself responsible for opinions expressed by his correspondents. Neither can he undertake to return, or to correspond with the writers of, rejected manuscripts intended for this or any other part of NATURE. No notice is taken of anonymous communications.]

The Separation of the Isotopes of Chlorine.

THE method outlined in our letter of September 30, 1920 (NATURE, vol. cvi., p. 144), and used for the partial separation of the isotopes of mercury, has enabled us to accomplish a partial separation of the isotopes of chlorine. When about half of a strong solution of hydrochloric acid cooled down to about -50° C. was evaporated in a high vacuum, the mixture of water and hydrogen chloride being condensed on a surface cooled with liquid air, the condensed part of the hydrochloric acid was found richer, and the remaining part poorer, as regards the lighter constituent of chlorine than the ordinary HCl.

Starting from about 1 litre of 8.6 mol. solution, we obtained, by repeated separations, about 100 c.c. of the lightest, as well as of the heaviest, fraction, the difference of which was examined by two different methods after transforming the acid into sodium chloride. In the first method the density of the two saturated NaCl solutions was determined. The salts were precipitated several times by alcohol from their aqueous solutions, and density measurements carried out after each precipitation. We found uniformly a higher density of the solution prepared from the residual acid, the mean values at 20° C. being

$$\begin{aligned}d_d &= 1.20212 \\d_r &= 1.20235\end{aligned}$$

from distilled and residual acid respectively. On the assumption of equal atomic volume of the two isotopes these figures correspond to a difference of 0.024 unit in the atomic weight of chlorine, or 6.5 per cent. in the atomic ratio of the isotopes.

In the second method equal quantities (5.7500 g.) of the molten isotopic sodium chlorides were dissolved in water and each precipitated with accurately the same volume of 0.2 n. silver nitrate. The latter was added in a slight excess. After precipitation and dilution to 2000 c.c. the approximate concentration of the filtrate was determined by titration with potassium rhodanide, and the ratio of the silver concentrations of the two solutions measured by combining them to a concentration cell. From the concentration $c=0.00040$ n. and the electromotive force of the cell, 0.0011 volt at 18° , we calculated that the difference in the atomic weight of the two samples was 0.021 unit, in close agreement with the result of the first-mentioned method.

The hydrochloric acid used in these experiments was thoroughly purified with potassium permanganate in order to remove bromine contingently present. Moreover, the repeated precipitation of the sodium chloride by alcohol would have given decreasing values for the estimated separation of the isotopes if any bromine should have been present. We think ourselves justified, therefore, in regarding the above-mentioned results as conclusive.

J. N. BRÖNSTED.
G. HEVESY.

Physico-Chemical Laboratory of the Poly-
technic Institute of Copenhagen, June 29.

A Novel Magneto-Optical Effect.

PROF. ELIHU THOMSON'S explanation of the interesting magneto-optical effect which he describes in NATURE of June 23, p. 520, is supported by some

experiments we have made recently on various oxides dispersed in air. When the vapour of zinc ethyl diluted with carbonic acid gas is mixed rapidly with a large volume of air, a fine fume is produced the particles of which when examined with the ultra-microscope exhibit rapid Brownian motion. In a short time the motion becomes slower and the particles brighter, but fewer in number. This continues until the fume has aggregated into a number of loose complexes formed of irregular chains or strings of particles. These chains are flexible and whirl and twist about under molecular bombardment in a striking manner, but fall under gravity at a surprisingly slow rate. In an electrostatic field the complexes straighten out and arrange themselves parallel to the lines of force, and on reversal of the field rotate through 180° .

When caught on a slide and examined with a high-power objective the same structure is seen more clearly. The individual particles are not in contact, but appear to be held together by invisible threads, consisting probably of strings of molecules or fine molecular aggregates. The zinc oxide fume given off from a zinc arc in air behaves in a precisely similar way. When a dense cloud is produced initially the particles agglomerate to large and irregular masses. By transmitted light the connecting hairs are invisible, but by a strong beam of reflected light of short wave-length obtained by suitable screens the particles appear to be surrounded by a nebulous haze. That the particles in these large complexes are really linked together can be demonstrated in another way by allowing a drop of immersion oil to flow slowly across the slide on which the deposit has been caught; the particles as they are lifted up by surface tension are seen to be attached to constellations of others, and drag these with them from a considerable distance in front of the advancing oil. The individual particles are about 100μ in diameter, and the complexes about 30μ . Even after several hours these clouds always contain a number of single particles.

The particles in clouds obtained by the arc discharge between electrodes of other metals form complexes of varying structure. The tendency to aggregation seems weakest with the oxides of Pb, Cu, Mn, and Cr. It is slightly greater with Fe, whilst the oxides of Mg, Al, and Sb give similar results to zinc oxide. The particles of CdO show a great tendency to aggregate in strings of a remarkable length, which under the microscope look like beads strung on a thread. Clouds of this structure might be expected to show in a strong electrostatic field an optical effect analogous to that described by Prof. Thomson, but so far we have not observed it. The work is being continued.

R. WHYTLAW-GRAY.
J. B. SPEAKMAN.

Eton College, Windsor, July 4.

In the former account of this novel effect (NATURE, June 23, p. 520) it was pointed out that a microscopic examination of the iron arc smoke deposited on a glass surface gave evidence of the existence of fine particles of iron compound arranged in short chain sections of bead-like relation.

It is now thought that this peculiar formation may have its origin in the outer envelope of the arc flame where the particles are formed and where they are lined up around the arc stream by the circular magnetism surrounding the current conducted by the hot vapour stream of the arc. The particles, being magnetic, would tend to form chains or rings surrounding the arc. These would not be stable, however, but would float away as they became shattered by gas

currents, and remain only as short lengths of particles held together. To throw light on this possibility, a small vertical, hollow cylinder of plaster of Paris open above was arranged with iron electrodes (for forming an arc) passing through its sides and meeting in the centre. By passing the current of a storage battery giving about 50 volts through them in contact and separating them, an iron arc could be produced at will within the plaster cylinder. The dimensions of the cylinder were such that a microscope slide 3 in. by 1 in. could rest across the open upper end of the plaster cylinder, only partly closing it, the slide lying horizontally above the arc electrodes at a distance of about 3 cm. Such a slide could receive a layer of smoke on its under-surface when the arc was formed below it. The microscope in that case showed only a confused deposit.

When, however, there was placed above the slide a strongly excited electromagnet with its poles resting on the upper sides of the slide or close thereto, such poles being about 3 cm. apart, a smoke deposit of a remarkable character was produced. Even as examined by the unaided eye in diffused light there was decided evidence of a structure or striation. When the microscope was used, with even comparatively low powers of about 300-400 diameters, there was disclosed a decided striation seemingly composed of brownish particles in strings extending over the slide and following the direction of the field. There was noted a surprising regularity in the distribution or spacing of the striæ, as if the surface was covered with fibres laid on systematically side by side.

There were, however, curious objects composed of small spheres (evidently globules of iron) strung together in a line of two, three, four, or more, such spheres having no uniform size. Most of these iron globule groups lay, of course, in the field direction, and were very large relatively to the particles in the striation covering most of the surface of the slide. But each of these straight settings of globules possessed a singular appendage, generally at one end only, but sometimes at both ends. It consisted of a brush-like tail composed of the brown filamentous chains of particles like those covering the slide as noted above. They gave the appearance of tufts, suggesting a growth of fine beaded fibres from the end of the string of globules. By focussing, these tufts or tails could be seen as projecting outward (upward) in an inclined direction. This means that the tufts did not lie on the slide surface, but sprang outward from the globule which carried it. The globule at the other end of the short chain (generally the largest in the line) was often to be seen as having a convergence upon it of the usually parallel striæ of the other parts of the slide, indicating clearly that the globules strung together were acting as small magnets with poles at each end, towards and from which poles the convergence and divergence of the magnetic lines were indicated by the fine striæ of particles taking their direction.

The polariscope showed that the striated smoke layer caught on the slide has the same property of scattering or diffusing light (as plane polarised light) that the smoke oriented in the air by a magnetic field has, but, of course, the slide preserves the orientation, and needs, to produce the results, no magnetic field after its formation or deposition. The slide covered with the striated smoke film is, in fact, a polariser.

Examination between crossed Nicol prisms (dark field) discloses the fact that the tufts of fine fibres carried by the rows of globules show as luminous spots on the black field, clearly indicating that the groups or tufts have a polarising effect if they are in proper relation to the rays passing through.

As was to be expected, any hollow vessel or enclosure capable of retaining the smoke from an iron arc can be used in demonstrating the original luminous phenomenon. A glass flask of from 1 to 2 litres is readily sensitised, as it were, by holding its mouth over an iron arc for a short time, allowing smoke from the arc to enter, and then corking the flask. It may then be used to show the effects by allowing a beam of light to traverse it while held in the field of a current-carrying coil. While this was being done it was noticed by Dr. Hollnagel (of the laboratory) that when the coil was traversed by an alternating current of twenty cycles the flask, when near the coil, gave the usual effect of increased luminosity of the smoke in its interior. When, however, the flask was removed from the coil a distance of several feet the steady luminosity was replaced by a flickering which kept pace, not with the alternations of current in the coil, but with the cycles only. The flickering was, as it appeared, at the cyclic rate. This flickering was noted even at a distance of 12 ft. from the coil, although the coil was but 7 in. in diameter and about 2 in. in axial direction. The flickering is a curious effect, and it is difficult to explain, especially the fact that it appears to keep time with the cycles, and not with the alternations, of current. It points to some sort of magnetic retention or polarisation of the iron particles of the smoke. They may even rotate or oscillate in obedience to the field fluctuations, but there is needed much more work of investigation as to the cause of the peculiar behaviour. The experiment clearly shows that a very moderate field intensity suffices for lining up the particles in the air, and so producing the luminous effect.

Emphasis is again given to the fact of the extremely small amount of iron particles suspended in the air, capable of giving a decided effect.

ELIHU THOMSON.

Thomson Laboratory, Lynn, Mass., June 17.

The Japanese Artificially Induced Pearl.

THE subject of artificial pearl induction, I venture to suggest, affords an excellent example of comparative pathology. Dr. Lyster Jameson's diagram in *NATURE* of May 26, p. 396, might well pass as an illustration of "pearls" frequently found in the human body. Such "pearls" are commonly seen in papillomata of the skin and at muco-cutaneous areas, but they can also be demonstrated in the tonsils, brain-coverings, thymus and thyroid glands, etc. Those which are epidermal become keratinoid, but others of deeper origin are often calcified.

All "pearls," whether ostreal or human, start in columnar cells and undergo metaplastic changes. Those of a wart become horny; those of the oyster calcified. The histological changes in the oyster are simply a matter of degree, and not difference.

The diagram fully illustrates this. The "blister" if seen in horizontal (transverse) section would present the same features as seen in the "pearl"—a concentrically laminated core surrounded by a single layer of cubical cells, embedded in mesoblast if growing, but when growth stops the cubical layer would be no longer seen.

"Islands" or "rests" of epithelial elements are common in man. In the oyster such an inclusion may become the true pearl and grow like a wart. Artificial induction or grafting merely imitates the natural process, and its later history is simply a matter of slight change in degree. In either case the pearl must be viewed as a morbid structure due to focal irritation. It is held that a wart may become malignant. In

other words, it may grow too fast and eventually kill the host.

Do the pearl elements ever behave so in the induced variety?¹ Should any positive evidence of this be available, it would throw much valuable light upon the ontogeny of cancer.

The view that warts, and even cancers, are transplantable is strongly supported by the artificial induction of pearls.

WYATT WINGRAVE,

Consulting Pathologist, Central London
Throat and Ear Hospital.

Lyme Regis, Dorset, July 8.

I DIRECTED attention in my 1902 paper (Proc. Zool. Soc., March 4, 1902) to the resemblance between pearls and "the structures sometimes found in epidermoid tumours and atheroma cysts." A pearl might be compared to the concentrically deposited ball of desquamated epithelial cells characteristic, I believe, of the latter, except for the fact that the pearl (like the normal molluscan shell-substance, and unlike the outer layer of the skin, and the nails, horns, hair, etc.,

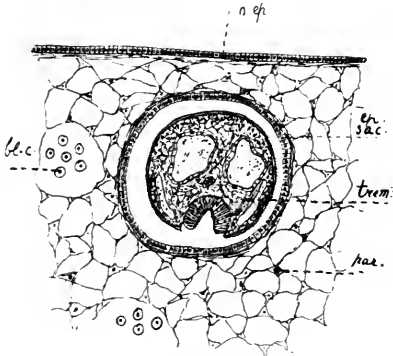

FIG. 1.—The pearl-inducing trematode *Gymnophallus dapsilis* or *G. bursicola* in the sub-epidermal connective tissue of *Mytilus*, surrounded by an epidermal sac which becomes the pearl-sac; *o. ch.*, outer shell-secreting epidermis; *ep. sac.*, epidermal pearl-sac; *par.*, parenchymatous connective tissue; *bl. c.*, blood-cells; *tr. em.*, trematode. The sac is usually about 0.4 to 0.5 mm. in diameter.

in mammals) is not composed of cells, but secreted at the surface of cells.

I cannot agree that the difference between a blister and a pearl is one of degree and not of kind, as Dr. Wingrave seems to suggest; in spite of the fact that the nature of the secreting cells, and of the substance they secrete, is identical. The blister is the normal response of the outer shell-secreting epidermis to the mechanical stimulation of any body that comes in contact with it. In this sense it resembles a corn on the human foot, or the thickenings of the skin on a navy's hands. On the other hand, recent evidence goes to show that the sac, or "island," of epidermis in which the pearl is formed arises only in certain quite specific circumstances. In the case of the edible mussel the "circumstance" is probably the specific stimulation (quite likely of a chemical nature) of the trematode *Gymnophallus dapsilis* or *G. bursicola*. These worms normally become surrounded by such a sac in *Mytilus* (Fig. 1), and when the worm dies, or leaves the sac, a pearl is formed in it. A smaller trematode, which I have not identified, also occurs in the sub-epidermal connective tissue

¹ The step from a "pearly" wart to a "pearly" or nested epithelioma is a very short one.

of the mussel; but this species, which is surrounded by a cyst, probably secreted by the worm itself (Fig. 2), and not by an epidermal sac, does not, in my experience, give rise to pearls. Similarly the cestode larva (*Tylocephalum ludificans*), which was wrongly identified by Herdman, Shipley, and Hornell as concerned with pearl formation in the Ceylon pearl oyster, is surrounded by the oyster with a fibrous con-

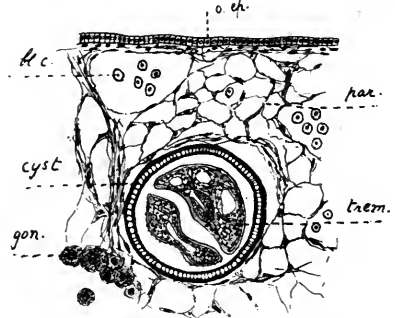

FIG. 2.—A smaller (unidentified) trematode in the sub-epidermal connective tissue of *Mytilus* which is surrounded by a cyst, probably secreted by the worm itself. The mollusc does not surround the worm with an epidermal sac, and there is no evidence that this species of trematode ever becomes the centre of a pearl; *gon.*, gonad. Other letters as in Fig. 1. The cyst is about 0.15 mm. in diameter.

nective tissue capsule (Fig. 3), and does not appear to possess the power of provoking the mollusc to produce the epidermal sac in which alone a pearl can be formed.

In the case of the Mikimoto pearls and of the pearls artificially produced by Alverdes, the special "circumstance" is the performance of a particular transplantation of tissue.

One of the facts which have favoured the survival

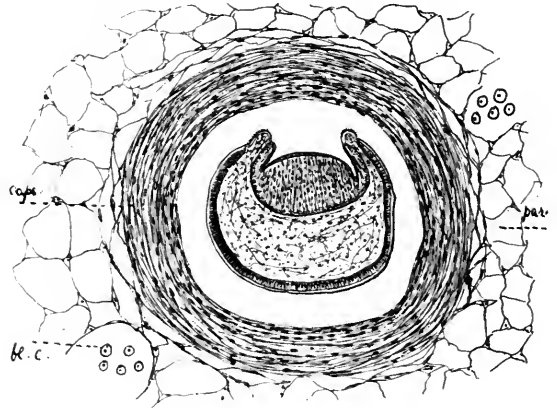

FIG. 3.—Solex of the cestode *Tylocephalum ludificans* in the connective tissue of the Ceylon pearl oyster. The mollusc surrounds this worm with a capsule (*caps.*) of fibrous connective tissue instead of with an epidermal sac. In spite of statements to the contrary, no satisfactory evidence has been adduced that this worm is associated with pearl formation. Letters as in Fig. 1. The entire capsule may measure as much as 2 or 3 mm. in diameter.

of the theory that the same kind of mechanical stimulation that produces a blister can produce a pearl-sac and a pearl is the occasional presence in fine pearls of grains of sand and other foreign bodies. I recorded and figured several such instances, from Ceylon pearls, in my 1912 paper (Proc. Zool. Soc., 1912, pl. xliii., Fig. 38; pl. xliiii., Figs. 44, 45; pl. xlvi., Figs. 54, 54a; pl. xlvi., Figs. 55, 56). I suggest the following possible explana-

tion of the presence of these bodies. One or two writers have recorded the occurrence of sacs with watery contents in different molluscs. The most notable instance known to me is that of *Modiola modiolus*, which, in the Barrow Channel, opposite the Lancashire and Western Sea Fisheries Laboratory at Piel, frequently contains leathery periostracum pearls in the mantle margin, and, associated with these, cysts lined with epidermis, containing watery or mucoid matter. In one of these cysts, some twenty years ago, I found what appeared to be the spores of a protozoon of some kind, but I have not been able to repeat this observation. If sacs of this kind, whether of parasitic origin or due to some pathological condition of the oyster not of parasitic origin, occurred in the Ceylon pearl oyster, and either occasionally burst or normally dehiscence to liberate a parasite or its spores, such bodies as small grains of sand, or (as in one of the pearls figured by me) a small quantity of mud containing diatoms, etc., might sometimes be swept into the sacs by the ciliary current and become the "nuclei" of pearls.

The distribution of pearl-producing examples of the various species of molluscs points to the conclusion that the presence of pearls—in other words, the development in the tissues of the mollusc of pearl-sacs—is associated either with parasites which are peculiar to certain localities, or with pathological conditions, following upon particular environmental conditions, which are strictly local in their occurrence. Thus the Ceylon pearl oyster, which produces pearls abundantly in the Gulf of Manar, rarely produces them in Trincomalee Harbour, while the distribution of pearl-producing beds of *Margaritifera maxima* and *M. margaritifera* is still more striking. We find the same local distribution of pearl-producing individuals in the fresh-water near mussel *Margaritana*, and more noticeably in *Anodonta*.

Personally I am inclined to anticipate that in many of these cases pearl formation will yet be shown to be associated with unicellular parasites. But, whether the pearl-sac is of parasitic origin, or due to some obscure response of the mollusc to a particular set of environmental conditions, it might well prove a highly profitable enterprise to transplant young examples, particularly of such species as *Margaritifera maxima* and *M. margaritifera* from beds where the percentage of pearl production is low, or where pearls are never produced, to some of those beds where almost every individual contains pearls. This process, if successful, would bring the production of pearls into line with the relaying of edible oysters on grounds where the conditions are such as to secure that they will fatten properly for market.

H. LYSTER JAMESON.

Sources and Sinks.

MR. DUFTON'S experiment (NATURE, June 23, p. 522) showing attraction between a source and an equal sink illustrates forcibly a remark by Mr. A. Mallock in the issue for August 19, 1920, p. 777: "In most problems relating to the actual phenomena exhibited by fluids in motion, the simple assumptions on which the hydrodynamical theory of text-books rests are insufficient, and experiments are required." At my suggestion Mr. R. Schlapp has recently been making some experiments on the forces between sources and sinks. The vertical limb (about 80 cm. in length) of a T-shaped glass tube dipped into a tank of water, and the horizontal portion rested on V supports. One end of this horizontal part was sealed, the other was connected by rubber tubing either to a high-pressure water supply or to a water pump, so that the end of the tube in the tank acted as either a source or a sink.

Three types of orifice were used: (a) the open end of the glass tube (internal diameter 0.4 cm.)—this worked well as a sink, but was unsatisfactory as a source; (b) a hollow brass sphere (diameter 2 cm.) with numerous perforations; (c) a short length of rubber tube having the lower end plugged and perforations over about 2 cm. On the whole the last arrangement proved the most convenient, but care had to be taken to ensure that no movement arising from lack of symmetry in the size and spacing of the perforations took place when using an isolated source.

When a single source was in the neighbourhood of a fixed vertical wall, attraction was observed. The attraction was very distinct at small distances, even with a small flow of water. At greater distances and with a stronger source the motion was irregular. Attraction was found also between a sink and a wall.

When two sources were employed it appeared as if they were under the influence of two forces, one attractive and the other repulsive, the former being predominant at distances less than about 2 cm. At such small distances the sources were drawn together and remained in contact as long as the water flowed. Additional evidence for the existence of a repulsive force was afforded by the observation that a fixed source repelled a second tube through which no water was flowing with a force which was greater or less according as the flow of water was large or small; but at small distances the action was attractive. Two sinks attracted one another, no repulsive tendency being observed.

Although Mr. Dufton's experiment showing apparent attraction between a source and a sink in a Winchester bottle was repeated successfully, experiments in an open tank, using the perforated rubber tube as a source and a similar arrangement or an open tube as a sink, showed strong repulsion between source and sink.

It is, of course, obvious that the conditions in such experiments differ in several respects from those assumed in the hydrodynamical theory of sources and sinks in an infinite mass of fluid. H. S. ALLEN.

The University, Edinburgh.

Helicopters.

MR. MALLOCK, in his letter in NATURE of June 30, p. 553, omits the chief reasons for the non-success of helicopters so far.

The first and, to the engineer, most obvious difficulty is the extra weight of moving as compared with fixed wings, and this applies to ornithopters equally.

The second, demonstrated conclusively by Riabouchinsky at the Koutchino laboratory in 1909, and recently rediscovered by ourselves, lies in the phenomenon of mutual and self-interference of the blades of an airscrew, now commonly called the cascade effect.

Each blade blows down the next following in the spiral path, then the other blades in turn, then again itself and the others, the effect becoming fainter as the axial distance from the "image" of itself and the others becomes greater.

In aeroplanes and helicopters, as in all structures which are kept geometrically similar, the weight increases as the cube and the lifting surface as the square of the typical dimension, and though some fining down of large structures can be made in comparison with small, this physical law limits the size alike of the vulture, the elephant, the whale, and the aeroplane. In helicopters the limit comes sooner than in the aeroplane, for the two reasons given above.

If this fundamental relation is ignored, the aeroplane or helicopter will be fortunate if it meets no

worse fate than the ostrich, and merely fails to leave the ground.

A. R. LOW.

The Library, Air Ministry,
Kingsway, W.C.2, July 1.

A Prehistoric Cooking-place in Norfolk.

COLLECTORS of Stone-age implements are well acquainted with the calcined flints known as pot-boilers, which are found sparsely strewn over the sites of most prehistoric settlements. As the sun-baked pottery of the kitchen utensil would not stand the fire, heated flints were thrown into the vessel to bring the water to the boil.

My attention having been directed by Mr. Baldry, of Cranwich, to a mound in Buckenham Tofts Park, Norfolk, where the moles were throwing out a remarkable number of these pot-boilers, with the kind permission of the owner, Mr. Underdown, I started excavations on the spot in May last with the view of discovering their origin.

Owing to numerous springs taking their rise at a somewhat high level in the park, the old chalk land surface has been carved out by water action into a series of large natural folds, which at first sight might appear artificial. On one of these, where the burnt stones are found in great profusion, we commenced operations, running a trench from the west side up the slope, a distance of 66 ft., and another near the starting-point at right angles to it. About 8 ft. from the base of the fold, and in close proximity to a stream, on removing about 3 in. of surface-grass and mould, we at once came upon a compact mass of pot-boilers. These continued to a depth of 2½ ft., resting upon blackened earth, which when dug through was found to be lying on the chalk. Tracing the calcined stones from the base of the mound upwards, many thousands came to light, ever decreasing in numbers as they approached the summit, as though thrown out from the spot on which they had been used.

The finding of remains of what appeared to be a great communal kitchen was extremely puzzling, and only when I got into communication with Mr. Cantrill, of the Jermyn Street Museum, did a possible clue present itself. Mr. Cantrill had published in *Arch. Cambrensis* accounts of his investigations of similar stone-boiling sites in Wales. His papers also refer to quite a number of these prehistoric cooking-places, known as "deer roasts" or "giants' cinders," in Ireland, and I am now informed by Mr. Crawford that they are not unknown in Scotland. In England, Mr. Cantrill tells me, they have never yet been examined.

These accumulations are supposed to have been the large cooking-hearths where the flesh of the red deer or other big game was boiled. The finding of hollowed tree-trunks in some of these mounds in Ireland suggests that a trough of this kind was sometimes used to contain the water. Mr. Cantrill suggests that another alternative would have been to dig a hole in the chalk and line it with a raw hide to serve as a cooking vessel. To boil such a great amount of water heated stones in large quantities would have been ladled into the vessel.

So far no satisfactory evidence as to the date of these places appears to have been forthcoming. A general opinion, however, seems to prevail that they are of Neolithic origin. This view may be substantiated by our finding among the pot-boilers quite a number of humanly struck flint flakes showing bulbs of percussion. Still more interesting was the discovery of what appears to have been a small circular pit dwelling within a few yards of the heap of pot-boilers. It measured 11 ft. in diameter. Opening this out, we came upon a hearth of quite normal

appearance—flints reddened by the fire, with a few pot-boilers strewn about, and an area of blackened earth. Here it was evident that some individual had sat and fashioned his flint tools, for flakes lay about in profusion, with spalls and a fine core. A scraper of unusual form, but strongly reminiscent of some of those found at Whitepark Bay, in Ireland, lay among flint knives and other small tools, while an arrow-point, worked on both sides and with one barb already punched out, may possibly by its workmanship give the required date to these mysterious sites. Further examination of the Buckenham Tofts mound will, it is hoped, be made in the near future under the auspices of the Percy Sladen Trust.

NINA F. LAYARD.

Science and Civilisation.

MAY I venture, as a citizen, to make an appeal to men of science and to urge that the time has come when they should no longer stand aside from the social and political questions that vex the world? Science is itself dependent upon favourable social conditions: that these conditions can abruptly cease has been clearly shown in the case of Russia. Scientific workers have therefore the strongest class interest in the social conditions under which they live. They have, however, more than a class interest. Science has made civilisation possible for mankind. It must now provide civilisation with that authority the lack of which is causing such waste of human energy to-day. Men of science alone have the power; they alone are above suspicion.

This is no place for details. An international amalgamation of existing scientific organisations would provide the world with an intellectual aristocracy, independent of the vote, which by the development of knowledge and the control of new weapons, lethal and industrial, would soon acquire the necessary influence.

B. J. MARDEN.

Stodham Park, Liss, Hampshire, June 30.

Measurement of Small Inductance.

THE method of suspending a loop of wire in a uniform alternating magnetic field, as used by Fleming and Elihu Thomson for the construction of A.C. galvanometers, can be applied with advantage to determine the self-inductance of loops in absolute measure, and it would seem that we can go considerably lower in this way than can conveniently be done otherwise. Low-frequency measurements are inaccurate, but with a triode at wireless frequencies I have measured inductances from 20 cm. to 50,000 cm. with an average error of 1½ per cent. without special precautions to obtain sensitiveness. The details of the experiment will appear shortly in the *Philosophical Magazine*.

F. B. PIDDUCK.

Queen's College, Oxford, July 2.

A New Acoustical Phenomenon.

THE phenomenon described by Dr. Erskine-Murray in a letter under the above heading in *NATURE* of June 16 (p. 490) is particularly well heard when one is standing near a cliff or rock-face and listening to the sound of a waterfall or of the waves breaking on the seashore. The phenomenon is, of course, familiar to physicists, but it may not be so well known that use can be, and indeed often is, made of this effect in avoiding obstacles when one is walking in the dark. No doubt blind men, consciously or unconsciously, use it in this way; and it must have been so used from remotest antiquity by man and any other animals which happened to have the necessary discriminating power in hearing.

G. A. SHAKESPEAR.

The University, Birmingham, July 8.

Large-scale Chemistry at the Imperial College of Science and Technology.

IT is now generally recognised that a student in chemistry who wishes to rise to any position of prominence in his profession, either in the industry or in academic life, must first obtain a thorough grounding in his subject by passing through a recognised honours school, and that he must then devote one or two years to training in the methods of research. It is usually during the third year of his honours course that the student first comes in contact with the realities of organic chemistry, and a considerable portion of his time during this period is devoted to a series of preparations in the organic laboratory. The organic laboratory is generally fitted with every type of glass and porcelain apparatus necessary for the student's needs, and he learns here the usual operations and requirements involved in the preparation of a number of typical organic substances. This training is undoubtedly of the greatest value, yet, because someone at some time ordained that there should be two kinds of chemistry, namely, that carried out in glass vessels and that effected in vessels of metal, the unfortunate student, who must needs satisfy a board of examiners who have passed through the same course as he, is instructed in the former kind of chemistry, and left either to imagine the fundamental conditions underlying the latter kind or to learn them in sorrow and tribulation under the more exacting conditions of the factory.

Owing possibly to his early training as an engineer, the present writer has always felt acutely the anomaly of this position, and has sought for an opportunity to erect a laboratory which should contain, like the ordinary small-scale laboratory, types of appliances suitable for all purposes—reduced replicas of those used on the industrial scale, but sufficiently large to render the usual industrial operations essential. This opportunity has now arisen owing to the generosity of an old student of the Imperial College of Science and Technology, Mr. W. G. Whiffen.

A laboratory of this kind will serve several purposes. It will, for example, enable the student, and especially the research student, to familiarise himself with operations carried out in vessels into which he cannot see and the contents of which he cannot transport by hand. He will become acquainted with factors, such as heat transference, cost of production, etc., fundamental in large-scale work, but which are of minor importance in ordinary laboratory practice and usually ignored.

He will learn, moreover, in the small fitting-shop attached to the laboratory how to make the necessary metal connections and to erect plant of metal in the same way as he is taught to build up apparatus of glass in the small-scale laboratory. Knowledge of this kind cannot fail to be of the greatest service both to students intending to enter industry and to those who have decided to follow an academic life. Indeed, the laboratory is not a "technical laboratory" in the strict sense of this much misused term, but rather the logical outcome of any adequate system of training in chemistry, and ought, therefore, to find a place in the equipment of every chemical school of university standing.

Again, the advantage to the research student will be very great, because he will be able to pre-



FIG. 1.—Staging showing filter presses and mixing tubs.

pare his initial material on the large scale, and it will be possible for him to carry out, if necessary, any new preparation which he may have discovered on a scale approaching that required for its commercial production.

Two questions have frequently been asked, namely: (1) How will it be possible to initiate a large number of students into operations such as those which it is proposed to carry out in this laboratory? and (2) How can the material prepared be disposed of? The answer to the first question is that the third-year students will work in batches of six or eight under the direction of one student as foreman, and, of course, under the general control of the demonstrator in charge of the laboratory. Each batch will carry through one complete preparation, say nitrobenzene—*aniline*—*acetanilide*—*p*-nitroacetanilide—*p*-nitrophenol, and will obtain the pure product. It will be possible,

if necessary, for five or six such batches to work at the same time, and it can be arranged that



FIG. 2.—View towards S.E. showing evaporating pans, centrifuges, and box filters. Research laboratory through screen.

students from the main laboratory will, during their organic course, pass for a week at a time into the larger-scale laboratory.

Regarding the second question, the operations carried out will lead to the production of material which can not only be used for further work on the intermediate scale, but will also be utilised in the small-scale laboratory for the ordinary students' preparations. It is more, however, in connection with the preparation of initial material for research that the new laboratory will be of the greatest service from both instructional and utilitarian points of view. No one who has conducted a school of research containing twenty or more research students can have failed to realise the waste of time entailed by having to go back to the beginning every time the supply of material is exhausted. It is evident that much time will be saved if large quantities of the initial material can be prepared as soon as the conditions for its preparation have been ascertained. The general design of the laboratory has been worked out in conjunction with the late Dr. J. C. Cain, after consultation with Mr. F. H. Carr, then in charge of Messrs. Boot's research laboratories at Nottingham. The general erection of the plant has been due to the skill and interest of Mr. James Robinson, of Messrs. Mather and Platt, Ltd.

Description of the Laboratory.

The laboratory occupies a floor-space 50 ft. by 47 ft., exclusive of the adjoining fitting-shop and research laboratory. It is 22 ft. high, and is covered by an asphalted ferro-concrete roof arranged for semi-indirect north lighting, the light being transmitted through safety (armoured) glass and reflected from the white ceilings and from the white glazed surface

of the walls. The advantages of this type of lighting are well known, and in the present instance the success of the arrangement is complete, a clear, steady light being obtained throughout the day. The floor is water-tight and acid-proof. It is paved with red tiles laid in such a way as to shed into the two main drains (Figs. 1 and 2), which run parallel to each other throughout the length of the room. With this arrangement—a most necessary one in a laboratory of this kind—it is a simple matter, to give the floor a wholesale wash-down with fire-hoses, six of which are situated at various convenient points.

The centre of the laboratory is occupied by a platform (Figs. 1 and 2), approximately 6 ft. by 40 ft., supported on stanchions 5 ft. above the floor. On and above this, fixed on suitable steel structures, are types of apparatus, such as open-top tubs, which, in general, are most conveniently emptied through a bottom run-off by gravity.

All fixed chemical apparatus, except that on the central platform, is set in concrete foundations carried to a height of 6 in. above the floor-level, whilst the motor, air compressor, and vacuum pumps are bedded in concrete blocks raised to 15-18 in. above the floor.

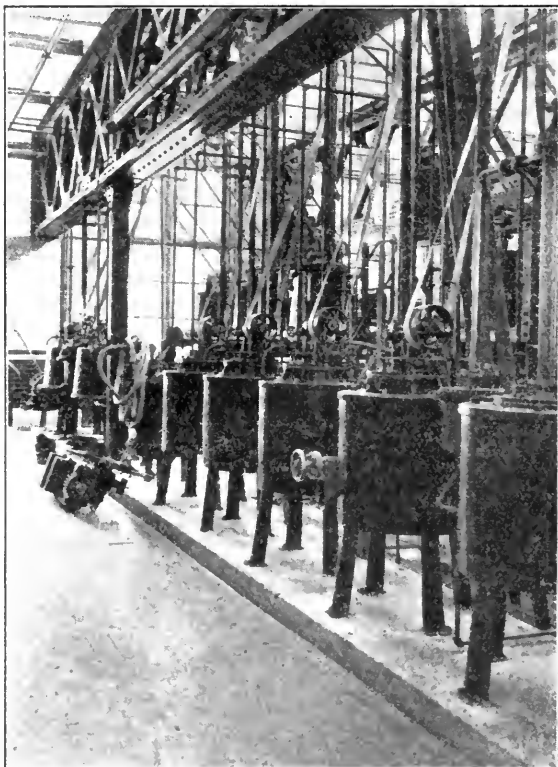

FIG. 3.—Series of general reaction pots.

The power for stirring, air compression, etc., is obtained from a 15-h.p. totally enclosed and ven-

tilated acid-proof motor, and is transmitted by two parallel lines of shafting hung in ball-bearings along the whole length of the laboratory and in the fitting-

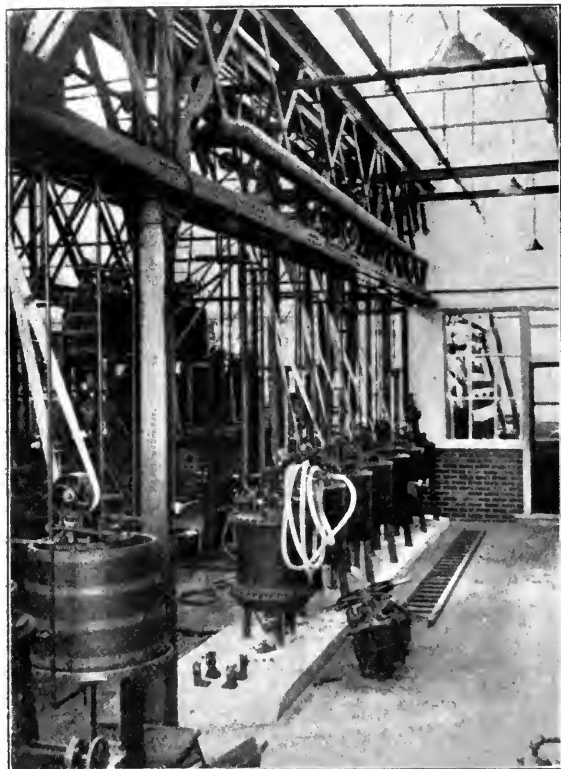

FIG. 4.—View showing distribution of high- and low-pressure air, hot and cold water, steam, vacuum, and gas services, with fitting-shop at back.

shop beyond. Resting on the shaft-brackets are the main pipes (showing through the lattice girder in Fig. 4) of the seven principal services:—Steam, 80-lb. air, 10-lb. air, vacuum, hot and cold water, and gas.

Both high- and low-pressure air are obtained from the same compressor (Fig. 5), which, by an appropriate arrangement of blow-off and reducing valves, delivers into two separate receivers at the required pressures. From these the air is led through high- and low-pressure mains to all parts of the laboratory, the former main being in permanent connection with the mild steel (lead lines) liquor receivers from which the filter-presses are charged, and the latter with most of the other apparatus in the laboratory; for it is the low-pressure air which is put to such general uses as blowing liquor from one vessel to another, stirring where mechanical stirring is inconvenient, blowpipe work, and so on.

The main vacuum pump (Fig. 5, at back), which exhausts a 40-gallon vacuum chamber to the vapour tension of water in about two minutes, is used not only for "sucking" the contents of open-top vessels into the liquor tanks, but also for vacuum distillation and for exhausting the

vacuum drying ovens, which, however, are connected in addition to a small pump capable of maintaining a vacuum, once established in the ovens, for any length of time.

Steam, gas, and cold water enter the laboratory from without. Hot water is obtained by passing water and steam through Mather and Platt unit heaters, which raise the water to the boiling point as quickly as the pressure in the mains is able to force it through the delivery pipes.

The types of apparatus permanently fixed in the laboratory are intended to render possible on the greater scale all ordinary chemical operations. The digestors, for example (Figs. 3 and 4), include vessels suitable for nitration, sulphonation, fusion with alkalis, acid and alkaline reduction, acid and alkaline hydrolysis, esterification—in fact, almost every operation which in an ordinary laboratory one associates with a flask on a sand-bath. Heating under pressure is performed in gas-fired heavy mild steel autoclaves. The stills include an apparatus for distillation in a current of saturated or superheated steam, a gas-fired still with a Young's column, a vacuum still with an arrangement of receivers equivalent in its use to the Perkin triangle, and a pan for vacuum evaporation. The redwood tubs on the platform are fitted with stirring gear, and arranged suitably for such operations as diazotisation and coupling and for washing solid precipitates and oils; they are the beakers and separating funnels of the laboratory. Apparatus for the three chief methods of filtration, under pressure by filter-presses (on platform, Fig. 1), by vacuum in box-filters (Fig. 1, left), and by centrifuging (one small and one larger machine appear on the left in Fig. 2), is installed, and the principal operations involved in the later treatment of a filter-press cake—for instance, squeezing in a hydraulic press (Fig. 2) or in a screw press (Fig. 4, lying on floor), drying in evacuated steam-ovens, and grinding in an edge-runner mill (not shown)—are all provided for.

A word should be said regarding the steps which have been taken to solve the problem of ventilation. General ventilation is provided by a 36-in. fan work-

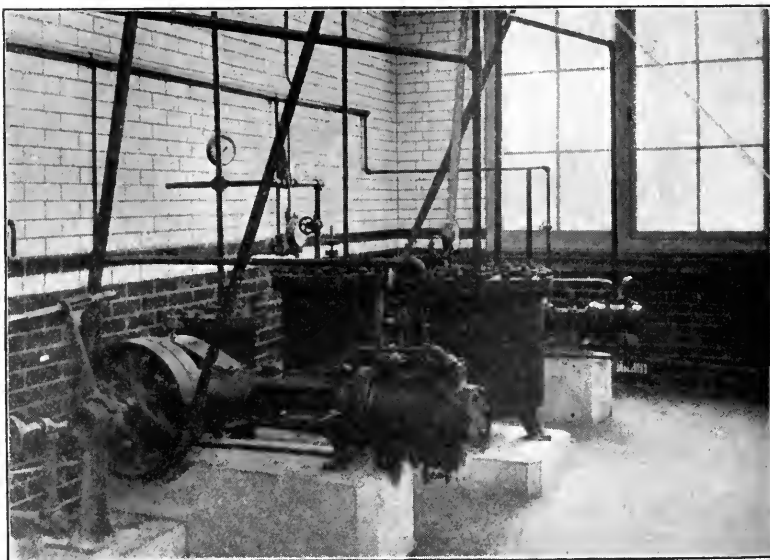

FIG. 5.—Vacuum and air-pressure services.

ing in an aperture in the wall. In addition, however, a main draught trunk, operated by a separate

fan, has been arranged to pick up vent-pipes and gas-flues from all digestors, as well as the exit pipes of the counterpoised draught-hoods which are pulled down over the evaporating pans when evaporations are in progress.

The surroundings of the laboratory are shown in some of the photographs. In Fig. 2 appears the adjoining research laboratory, whilst Fig. 4 shows a corner of the fitting-shop and engineering store. This invaluable adjunct contains a stock of pipes, fittings, and tools, some small power-driven machines, including a screw-cutting lathe, and working places for

carpentering, fitting, and soldering. The chemical store, which is arranged to contain casks, drums, and carboys, as well as Winchester's, does not appear in the photographs.

With regard to the question of slinging and heavy work generally, the numerous overhead principals provide so many points from which a lifting block may be hung that it was not considered necessary to install a travelling crane. Two rubber-tyred bogeys, one of which has been specially designed, suffice for the carriage of all the heavier objects which we are likely to have to handle.

J. F. T.

Great British Droughts.

By CHAS. HARDING.

IT is fortunately seldom that such persistent dry weather has to be chronicled as that which has now continued for several months. A more complete history of the drought will doubtless be written when all possible facts have been collected.

At Greenwich Observatory the records show that the rainfall has been less than the normal for nine consecutive months, from October, 1920, to June, 1921. The total measurement for the whole period is 9.78 in., which is 7.74 in. below the average for the 100 years ending 1915, and only 56 per cent. of the normal. This is the driest period from October to June in the last 105 years; the next driest corresponding period occurred in 1879-80, when the measurement was 10.50 in. There is only one longer period at Greenwich—November, 1846, to January, 1848, a period of fifteen consecutive months—with the rainfall below the normal. The controlling factors of the weather have commonly been a low barometer in the north of the British Isles, and a relatively higher barometer with anticyclonic conditions in the South of England.

In addition to the Greenwich observations, those at Eastbourne have been chosen to represent the more southern portion of the kingdom. The drought at Eastbourne is scarcely so severe, since the rainfall for each of the months December, 1920, and January, 1921, was in excess of the average for the period of thirty-five years ending 1915, chosen as the normal by the Meteorological Office. The total rainfall for the nine months from October, 1920, to June, 1921, inclusive, is 15.62 in., which is 7.95 in. in defect, and 66 per cent. of the average fall. This is 10 per cent. of the average more than at Greenwich.

Attempts have been made from time to time to detect a weather cycle, but so far these have not been very successful. The favourite cycle with meteorologists is that corresponding with the periodicity of solar activity; but, so far as the general weather is concerned, it does not yield satisfactory results. Prof. Brückner, of Berne, has discussed the subject of periodic variations and changes of climate in detail, and his discussion is conducted on lines which perhaps might well be followed by others. For the fluctuations of

rainfall he has made use of observations at 321 points on the earth's surface, and of these no fewer than 198 are in Europe. Prof. Brückner deals with averages for five years, and the period found for the cycle is thirty to thirty-five years. Continuing the cycle to the present time, a period of deficiency of rainfall is shown for the years 1921-25; the previous period of deficiency was 1891-95. The next period of excess should occur in 1936-40. The present deficiency of rain seems decidedly a fulfilment of Prof. Brückner's cycle.

An absolute drought is reckoned as more than fourteen consecutive days wholly without rain, and a partial drought is a period of more than twenty-eight consecutive days the aggregate rainfall of which does not exceed 0.01 in. per diem. No absolute drought has occurred at Greenwich this year, and the only partial drought was from February 1 to March 5, a period of thirty-three days during which the total rainfall was 0.24 in. The spring drought of 1893 is probably the most severe of recent years; the absolute drought continued for forty-four days, whilst the partial drought at Dungeness lasted for 127 days, and at North Ockenden, Romford, Essex, for 128 days. The abnormal summer of 1911 experienced three absolute droughts at Greenwich—April 11 to 24, fourteen days; July 1 to 23, twenty-three days; and August 2 to 18, seventeen days. There was an exceptionally long partial drought continuing for fifty days, from June 30 to August 18; the aggregate measurement of rain during the period was 0.33 in. As many as three absolute droughts occurred in London in the years 1868 and 1887, and four in the year 1858. In 1880 there was an absolute drought for twenty-eight days—from August 9 to September 5. In the year 1716 it is recorded that, in consequence of a long drought and a south-west wind, the River Thames became so low that thousands of persons passed across on foot under the arches of London Bridge.

There is a great diversity in the periodicity of rainfall, and two consecutive summers often differ widely from each other, as shown by the rains in 1920 and 1921. In 1903, a remarkably wet year, the aggregate measurement of rain at

Greenwich for the six months April to September was 22.21 in., whilst for the following summer, 1904, it was 8.69 in. "British Rainfall," dealing with observations from 1726 to 1891, shows that during the first forty years the rainfall in only nine years reached the average, and from 1738 to 1762, a period of twenty-five years, there is only one year above the average; this is a more persistent drought than has occurred in the nineteenth or twentieth century. There was a succession of wet years ending with 1882, and this was followed by a very dry period. In the twenty years 1883 to 1902 the Greenwich observations show an aggregate deficiency of rain amounting to more than 40 in. During this period there were sixteen years with a deficiency, one year

with the average fall, and three years with an excess. Each year from 1895 to 1902 had a deficient rainfall, the total deficiency in the eight years amounting to 25.5 in.

The question of interest is now: When will the exceptional heat and drought of the present year cease? The absence of rain is continuing well into July, and each week the drought is becoming more serious over the whole country. The increased interest in meteorology, brought about by the late war, has added much to the staff and efficiency of the Meteorological Office. Every effort is being made to improve our knowledge of the weather changes, and probably in a few years it will become possible to predict the chief characteristic features of a season.

The Scarcity of Swallows.

By DR. WALTER E. COLLINGE.

FOR some years past certain ornithologists have directed attention to the decreasing number of swallows seen in the British Isles during the months from April to September. This diminution was particularly marked in 1918 and 1919, less so in 1920, but is still more apparent in the present year. For a time the scarcity was denied by many, or stated to be only of local occurrence, but the condition of affairs during the present season is sufficiently well marked to convince the most sceptical.

The swallow economically is one of our most valuable birds, its food consisting practically entirely of insects, and any scarcity of these birds removes a most important factor in the destruction of injurious insects. The causes which have led to this scarcity are not at present all known, but there are some which have been operating for a considerable time past, and their effects are now making themselves felt.

First, there is the deplorable mortality of migrants which takes place around our coasts in connection with the lighthouses and lightships, and, as has previously been pointed out, a considerable percentage of these birds might be saved. Something towards minimising this danger has already been done, but the swallow is

a day-migrant, and so largely, if not entirely, escapes this danger.

The enormous increase of the house-sparrow during recent years has undoubtedly had much to do with the decrease of the swallow. Not only do the sparrows take up their abode in the swallows' nests, but they molest and persecute the birds during the whole period of incubation. In the United States there has of recent years been a very serious decrease in the number of house-martins due to this cause.

There are, however, other causes for the present scarcity which do not arise in this country. In 1918 and 1919 the continuous waves of June migrants were unobserved or of very short duration, and during the present season they have been still fewer, all of which clearly indicates a diminishing immigration. Moreover, in 1919 and 1920 the majority of the swallows commenced their southern migration early in August.

In view of the importance of the swallow economically, the question is one calling for immediate attention and investigation, and until we know more about the matter it might be well to place this bird and its eggs under stricter protection.

The King George V. Dock, London.

A FUNCTION of special interest and importance in the history of the Port of London was performed on Friday last, when the King visited North Woolwich for the purpose of opening and naming the new dock of the Port of London Authority which has been under construction since 1912.

The addition to the enclosed water area of the port amounts to 64 acres, and as the depth of the dock is 38 ft., the new accommodation will prove extremely useful for large ocean-going vessels of the present day. The dock is entered by a lock

800 ft. long and 100 ft. wide, having a depth of 45 ft. over its sill at high water, and 20 ft. less at low water. The capacity of the chamber can be increased to a maximum length of 910 ft. by placing a *caisson* in a special recess instead of using the innermost pair of gates. The dock averages 600 ft. in width, but tapers from east to west. On the north side there is a concrete quay wall of the ordinary type. On the south side a somewhat novel arrangement has been adopted. Projecting into the dock, and parallel with the quay line at a distance of 54 ft. there-

from, is a series of seven jetties, 22 ft. wide, leaving an intervening space of 32 ft. in width between them and the quay. The object of this is to enable barges to pass on the inner side of the jetties, so that vessels may simultaneously discharge their cargoes into barges on both sides and, at the same time, land goods on the quay. The jetties are equipped with cranes which are able to command the vessel's hold, the inner barges, and the quay. It should be pointed out that a high proportion of the goods brought into the docks at London is conveyed by barge or lighter to their ultimate destination.

The north quay is to be flanked by double-story

sheds, of which so far only one is constructed. These are designed in reinforced concrete, with brick panelling. On the south side seven single-story sheds of steel framing with corrugated-iron covering have already been provided.

At the western end of the new dock is a dry dock 750 ft. long with an entrance 100 ft. wide and a depth of water over sill of 35 ft.

Connection between the new dock and the adjoining Royal Albert and Victoria system is made by means of a passage 100 ft. in width.

The King graciously acceded to the request that the new dock should be called the King George V. Dock, and named it accordingly.

Notes.

THE Osiris prize of 100,000 francs has been awarded by the Academies of the Institute of France to Gen. Ferrié, C.M.G., Director-General of French Military Telegraphs, in recognition of his work in the development of wireless telegraphy for war purposes. Gen. Ferrié has been well known as an acknowledged authority on wireless matters for many years, and as the head of the French military wireless telegraph services it fell to him to initiate the whole organisation of the wireless arrangements in the fighting forces of France during a period when greater advances were being made than at any other time in its history. He was responsible for the equipment and working of the famous Eiffel Tower station and for the installation of the powerful station at Lyons in 1917, as well as for the completion of the still more powerful station near Bordeaux commenced during the war by the American Army. Gen. Ferrié had much to do with reducing the thermionic valve from a laboratory appliance to a piece of everyday wireless apparatus and in devising wireless equipment for aircraft, and in earlier days was one of the first successful experimenters with the electrolytic detector. In recognition of his work the honorary degree of D.Sc. has been conferred upon him by the University of Oxford.

SIR ROBERT HADFIELD has expanded his reply to the American deputation of engineers who attended in London to present him with the John Fritz medal into an address of thanks, which has just been printed in the form of a substantial pamphlet with numerous illustrations. The address sketches the services rendered by British and American engineers to the Allied cause during the war, outlines the record of the Institution of Civil Engineers, and gives an account of the members of the American deputation. The movement which has resulted in the establishment of the United Engineering Society of the United States is commended as having brought together a large number of distinct technical institutions, housed them in a common building, and provided a common library, so furnishing an excellent object-lesson in the organisation of scientific and technical effort. A description is then given of Sir Robert's own metallurgical research work, especially in regard to the invention of manganese steel, the alloy which pos-

sesses such an unusual combination of mechanical and magnetic properties, and of the alloy of iron and silicon, now so widely employed under the name of "low hysteresis steel" in the construction of transformers and other electrical appliances. The concluding sections of the address deal with the growth of science and the value of research to civilisation, the subject being illustrated by an account of the history of the Royal Society and of some of its more famous fellows. The present occasion is a good one for directing attention to the close bonds which unite men of science and technologists in our own country and in the United States, and to the advantages which are to be derived from an even closer co-operation in the future.

THE council of the Royal Society of Arts has decided that in future the Colonial section of the society shall be known as the "Dominions and Colonies Section."

MR. A. J. BALFOUR has been elected president of the British Academy in succession to Sir Frederic Kenyon. M. Henri Pirenne, past-president of the Belgian Academy, has been elected a corresponding fellow, and Bishop G. F. Browne, formerly Disney professor of archæology in the University of Cambridge, an honorary fellow of the academy.

THE following have been elected as officers and members of council of the North-East Coast Institution of Engineers and Shipbuilders for the session 1921-22:—*President*: Sir William J. Noble, Bart. *Vice-Presidents*: Mr. C. W. Cairns, Mr. A. Laing, Mr. C. D. Smith, and Mr. R. Wallis. *Members of Council*: Mr. B. C. Browne, Prof. C. J. Hawkes, Mr. R. Hinchliffe, Mr. H. Laing, and Dr. J. E. Stead. *Hon. Treasurer*: Mr. R. H. Winstanley.

IN accordance with the provisions of section 2 (6) of the Dyestuffs (Import Regulation) Act, 1920, the President of the Board of Trade has appointed a Committee to advise the Board with respect to the efficient and economical development of the dye-making industry. The members of the Committee are:—Mr. W. J. U. Woolcock, M.P. (chairman), Mr. Percy Ashley, C.B. (Board of Trade), Sir Henry

Birchenough, Mr. W. H. Dawson, Mr. G. Douglas, Mr. E. V. Evans, Dr. M. O. Forster, Mr. L. B. Holliday, Dr. Herbert Levisstein, Prof. G. T. Morgan, Mr. J. Morton, Mr. Max Muspratt, Mr. T. Taylor, Mr. N. Thomas (Admiralty), and Mr. G. S. Witham (War Office). An additional representative of dye-using interests is to be appointed shortly.

THE Royal Asiatic Society has decided to celebrate the centenary of the birth of the late Sir Richard F. Burton by the institution of an annual memorial lecture and a medal bearing his effigy. Burton was a pioneer and an explorer of the first rank who studied his fellow-men profoundly, and by his wonderful knowledge of the literature and life of the Arabs did much to bridge the gulf between East and West. His journeys to the forbidden cities of Mecca and Harer will long be remembered as exploits as full of daring as they were of scientific importance. A fund, to be known as the Burton Memorial Fund, has been opened and a national appeal for subscriptions is being made. The hon. secretaries of the memorial fund committee are Dr. F. Grenfell Baker and Mr. N. M. Penzer, and subscriptions should be dispatched to the Manager, the National Provincial Union Bank of England, Union Bank Branch, Oxford.

EMPHATIC corroboration of recent correspondence in our columns upon the supply and cost of German publications is provided by a letter addressed to the *Times* signed by the Vice-Chancellors of the Universities of Liverpool, Sheffield, and Manchester and the Principals of Armstrong College, Newcastle, and Birmingham University. At each of these institutions the librarians have found it impossible to obtain current German scientific literature by reason of the operation of the Reparations Act. There has been a complete stoppage of delivery through the Customs of books of German origin, while books which have been ordered direct from agents in Germany are delayed for an indefinite period. Even when it has been proved that the order was placed before the present Act came into operation and the 50 per cent. Customs charge has been paid under protest, books are still undelivered. The writers of the letter emphasise the fact that it cannot be regarded as patriotic to cut off from this country all knowledge of scientific progress in Germany; on the contrary, it is to the advantage of our trade and ultimate prosperity to know without delay every addition to knowledge made in Germany as in other countries. German journals of science and other publications devoted to the advance of knowledge cannot be regarded as entering into competition with British journals and books, and vigorous protest is made against the interpretation of the Act by the Board of Trade to include such articles.

THE University of Calcutta has published, as the first of its series of anthropological papers, an essay by Mr. Panchanan Mitra on the prehistoric arts and crafts of India. Beginning with stone implements, Mr. Mitra traces their development in the Palæolithic and Neolithic types. Then follows a chapter on cave paintings and carvings, containing much information which will be novel to English readers. These are

held to indicate an Indo-Australian culture-contact from the late Palæolithic up to Neolithic times. On the general question of prehistoric arts and crafts the author accepts the view of Dr. Coomarswamy that "to this Mykenean facies belong all the implements of wood-work, weaving, metal-work, pottery, etc., together with a group of designs, including many of a remarkably Mediterranean aspect, others more likely originating in western Asia. The wide extension and consistency of this culture throughout Asia in the second millennium B.C. throw important light on ancient trade intercourse at a time when the eastern Mediterranean formed the western boundary of the civilised world." Thus the veil which has hitherto concealed the origins of ancient Indian culture is being gradually lifted, and the University of Calcutta is to be congratulated on its efforts to extend this knowledge by the aid of native scholars like Mr. Panchanan Mitra.

THE second part of Mr. Rhys Jenkins's paper, read before the Newcomen Society, on "The Rise and Fall of the Sussex Iron Industry" deals at some length with the technical aspects of the subject, although the historical material available is somewhat scanty. The ore most commonly used was a clay ironstone occurring in nodules and thin beds towards the bottom of the Wadhurst Clay. It was worked mainly by means of bell pits about 6 ft. in diameter at the top, which widened towards the bottom and were generally shallow, being rarely more than 20 ft. deep. These beds have been worked from Roman times onwards. Mr. Jenkins quotes in full the description of the process of iron-making published by John Ray in 1674. From this it is clear that the ironmasters always mixed together different kinds of ore. The roasting process is first described, and afterwards the method of charging and operating the blast-furnace. The period of six days was called the "Founday," and about eight tons of iron were made in this time. The methods of working the iron at the forge or hammer in the Finery and Chafery are also described. Mr. Jenkins concludes that the industry began to decline during the Commonwealth period, and became extinct about the end of the eighteenth century. He discusses possible reasons for this decay, and concludes that it was due neither to the competition of mineral fuel nor to a failure in the supply of charcoal. He appears to think that it may have been connected with the question of power used for working the bellows of the blast-furnace and the hammer of the forge. Water-power was used for this purpose throughout the country, and the Weald was inferior to, for instance, Shropshire as regards both rainfall and the head of water which could be utilised. The author also considers that foreign competition was more acutely felt in the Weald than in the northern districts.

THE June issue of the *Decimal Educator*, a quarterly publication of the Decimal Association, contains much interesting information respecting the progress of the metric system. The introduction of metric weights on the Chinese railways, which is now an accomplished fact, was effected without trouble and has given rise

to no complaints. A notice issued recently by the Government of Malta announced that the metric system was to come into force on July 1. It has been made obligatory in dealings with the Customs Department as a preliminary to enforcing its use in general trade in the island. The unsatisfactory manner in which decimals are taught in the United Kingdom is the subject of an instructive article in which it is stated that, although teachers as a body are supporters of the metric system, the accepted methods of teaching arithmetic place the decimal fraction in an unfavourable light by giving unnecessary prominence to conversion sums, and in this way seriously handicap decimal reform. It is urged that so far as possible all reference to vulgar fractions should be omitted from the teaching of decimals, and that the examples necessary to explain the meaning of decimals should be drawn from the metric system and decimal coinage, with an occasional sum involving such British measures or coins as are connected by decimal relations. A useful chart illustrates the progress made in the adoption of the metric system during the last hundred years. The consistently upward trend of the curve and the particularly sharp rise during the past ten years are noteworthy, and indicate that as each new country joins in the competition of international trade its national weights and measures are abandoned and the metric system adopted in preference.

THE National Institute of Agricultural Botany, which was organised with the object of improving the seed supply in the United Kingdom, is now making arrangements to conduct a comprehensive series of yield and quality trials of wheat, oats, and barley, to commence during the season 1921-22. The trials will be carried out on a uniform and scientific system in several parts of the country, and final reports, on which the granting of certificates of merit will be based, will be issued after the harvest of 1924. The trials will be open to all who can show that they have in their exclusive possession new or improved varieties or strains of any of these cereals, and undertake to refrain from placing them on the market previous to the issuing of the final report on their merits, except with the institute's consent. The testing fee will be limited to the actual cost of the trial. Full particulars of the scheme can be obtained from the Secretary, National Institute of Agricultural Botany, 10 Whitehall Place, London, S.W.1.

Nos. 1-9 in vol. vi. (1920) of the Entomological Series published by the Agricultural Research Institute, Pusa, are devoted to a series of papers on the life-histories of Indian Microlepidoptera by Mr. T. B. Fletcher. It is mainly within the last fifteen years that any serious attempt has been made to acquire a knowledge of the species of the small moths which occur in India. In 1889 only 225 had been enumerated, while at the present time 2422 species contained in about 458 genera are known. In spite of this large number, Mr. Fletcher remarks that we are merely beginning to learn what kinds exist in the Indian Empire, where there are still enormous areas absolutely unknown so far as Microlepidoptera are concerned. In this series of papers a great deal of scat-

tered information is brought together in a convenient form, and short accounts are given of the life-histories of a very large number of species. Many of the latter, together with their larvæ and pupæ, are well figured in a series of sixty-eight plates which accompanies the letterpress.

DR. MARJORIE O'CONNELL (Bull. Amer. Museum Nat. Hist., vol. xlii., p. 643, 1920) describes Jurassic ammonites from Viñales, western Cuba, which prove the beds containing them to be of Oxfordian age. The author points out that in a recent paper by Dr. M. S. Roig previous descriptions of Mexican species have become included as though they came from Cuba. More may be expected, however, from Dr. Roig's extensive collections, and Dr. O'Connell will, no doubt, pursue her studies in this almost untouched field.

IN Bulletin 597 of the U.S. Geological Survey, with its large geological map on the scale of 1:250,000, Mr. B. K. Emerson provides a handbook to "The Geology of Massachusetts and Rhode Island," a region associated with Boston Bay, one of the most famous natural gateways of North America. Students at Harvard and citizens of Providence in the drowned valley of the Blackstone River, or of Pittsfield across the picturesque and dissected uplands of Berkshire, will welcome this record of the geological history of their States. Fascinating reproductions of the early Dinosaurs of Triassic times are given from models, including *Stegomus*, known from its armour only, and the bipedal *Anchisaurus*. The reader requires geological training, but this should not be lacking in the abundant secondary schools of Massachusetts.

SPECIAL interest attaches to a recently published Bulletin of the U.S. Geological Survey on "The Iron and Associated Industries of Lorraine, the Sarre District, Luxemburg, and Belgium," by Messrs. Alfred H. Brooks and Morris F. La Croix. The bulletin gives an exhaustive description of the position in these districts and of their future possibilities, and is full of valuable statistical information most carefully collected. At the moment the following passage, written with reference to the Sarre coalfield, is perhaps the most interesting for British readers:—"It has long been recognised in Germany that the Government mines were less efficiently operated than those in private hands. Evidence of this difference is found in the reported cost of production. The average cost per ton of coal mined in the years 1906 to 1910 was 11.54 francs for the private mines and 13.50 francs for the Government mines. This ratio of cost appears to have continued for 1913, when the average profit, as reported, was 2.50 francs per ton for private mines and 2.15 francs per ton for Government mines, in spite of the fact that the private operators sold their coal cheaper than the Government. . . . Further evidence of the better practice in the private mines is afforded by the annual coal recovery per miner, which in 1913 was 261 tons for private mines and 229 tons for Government mines."

PERTSHIRE has been fortunate in that on two occasions when there was a fall of meteorites specimens and data of a trustworthy nature have been obtained.

In the latest issue of the Transactions and Proceedings of the Perthshire Society of Natural Science (vol. vii., part 2, 1919-20) Mr. Henry Coates describes fully all the data regarding the occurrence of the meteoritic fall in December, 1917, and the paper contains appendices regarding the fall of 1830, records of distances contained in tabulated form, and a report by Mr. W. F. Denning on the path of the meteor. The author has added eleven illustrations from photographs taken at the time and some diagrams. This part of the number also contains a short paper on the occurrence of the horned pond-weed (*Zannichellia palustris*, Linn.) in Keltie Loch, near Dunning, by Mr. J. R. Matthews.

ACCORDING to an article in *La Nature* for June 25, the French Navy, during the recovery of materials from many of the vessels sunk during the war, has greatly improved the oxy-acetylene torch of Picard so that it can be used under water. The addition which has rendered this possible is a small bell-shaped vessel surrounding the oxy-acetylene flame, which is kept supplied with compressed air. After the flame is alight and the stream of compressed air established the torch may be plunged into water without being extinguished. If by any accident it was extinguished, it was necessary for the diver to ascend to the air to light it again. Under the auspices of the French Department of Scientific and Industrial Research, M. Corne has recently made a further addition to the torch which makes it unnecessary to ascend to relight it. A tube containing an alkaline metal and an oxidiser is attached to the torch and can be moved to the mouth of the bell. On removing the cap from the end of the tube the chemical action of the water on the mixture produces a flame which relights the torch. The addition has greatly increased the number of underwater uses to which the torch can be put.

THE Journal of the Washington Academy of Sciences for April 4 contains two communications which deal with the steps taken by the United States to acquire a better knowledge of the properties and behaviour of the oceans which wash its shores. Under the auspices of the National Research Council a conference of representatives of the nations around the Pacific Ocean was held in Honolulu in August, 1920, to consider what knowledge with regard to that ocean was available and in what directions there was most urgent need of its extension. As a result, it is expected that during the present year several volumes dealing with the scientific exploration of the Pacific will be published. The opportunity afforded by the Ice Patrol of the Atlantic in 1920 was utilised by Mr. A. L. Thuras, of the Bureau of Standards, to test the trustworthiness of the method of determining the salinity of sea-water on board ship by measuring its electrical conductivity. It was found both trustworthy and convenient, and it is proposed to set up a self-recording apparatus based on the method which will give the temperature, density, and salinity of the water.

In a paper read to the Physical Society on June 24 Mr. S. Butterworth discusses the errors due to capacity and eddy-current effects in inductometers.

At low frequencies these errors are negligible, but at telephonic frequencies they have to be considered, and in radio-telegraphy the corrections which have to be applied are of the same order as the quantities measured. Making the assumption that the capacity effects in two coils having one end in common can be represented by two condensers shunting each coil and by another condenser joining their free ends, the author obtains formulæ which are in good agreement with experiment. When the secondary e.m.f. induced in a secondary circuit is in exact quadrature with the current in the primary the mutual inductance is "pure." This assumption is made in the proof of the Heaviside and Carey-Foster inductance bridges. The author works out the theory of these bridges on the assumption that the mutual inductance is not pure, but varies with the frequency. Experimental verifications of the theory are given.

In the Journal of the Franklin Institute for May last L. W. Austin describes experiments made to determine the directions from which the atmospheric disturbances noticed in radio-telegraphy appear to come. The main observations were made in the West Indies, California, and Washington. The author concludes that on the Atlantic coast of the United States the disturbances come either from the direction of Mexico or from that of the Allegheny Mountains. On the Pacific coast the disturbances are much weaker and their direction is more variable. They seem to come from centres at much shorter distances, and generally in the direction of mountains. At Bremerton and Astoria most of the disturbances come from the direction of Mount Ranier, a lofty and isolated peak. In Porto Rico the disturbances were mainly of local origin and very diffuse. When they came from the sea there was generally land at no great distance in that direction. When the disturbances increase with increase of wave-length, as at Washington, they come from distant origins; when they vary little with wave-length, as at San Francisco and San Diego, the focus of the disturbance is near at hand. The origin of the disturbances seems to be in the upper atmosphere, probably between masses of air at different potentials. The results obtained indicate that a world-survey of these "static" disturbances would lead to important results.

In electroculture it is customary for the high potential wires to be placed horizontally and parallel to one another above the growing crop. As the number of wires is limited the question arises as to how far the electric force at the ground level is uniform. In a paper to the Physical Society read on June 24 Dr. Chree gives simple formulæ showing how the potential gradient at the surface of zero potential (generally the ground level) depends on the height and spacing of the wires. These formulæ will be of use in practical work. It is probable that a high potential gradient is injurious, and a low potential gradient beneficial in certain cases. It is important therefore to obtain uniformity of conditions, for this should at least make it easier to draw conclusions as to the merits of electroculture. An immediately useful deduction from the author's formulæ is that a very uniform set of conditions can be secured

at crop level if the distance between adjacent wires does not exceed the height of the wires above the crop. It has to be remembered, however, that when there is an appreciable excess of ions of one sign in the atmosphere the values of the electric forces will be affected.

It is well known that Hooke's law of proportionality of force applied and deformation produced holds for solids only so long as the deformation is not large. The same may be said with regard to the corresponding law for the deformation of viscous liquids. In order to discover some more satisfactory form of relation between deformation and force in either case, Dr. P. G. Nutting has made observations of the shear of various materials between parallel plates 5 cm. by 10 cm. in area and 0.2 cm. apart; his results are given in the May issue of the *Journal of the Franklin Institute*. He finds that in all cases the deformation at a given temperature is proportional to a power of the force which varies for different materials from 0.74 to 3.5. Further, it is proportional to a power of the time of application of the force, which varies for different materials from 0.2 to 0.91, the low value being characteristic of solids and the high one of liquids. Dr. Nutting finds that the new law is applicable in other than mechanical fields. In a dielectric, for example, the electrical displacement is proportional to a power of the applied electric field, which varies from 0.54 for paper to 1.16 for xylene, and also to a power of the time of application of the field, which varies from 0.74 for bakelite to -0.2 for mica. For the best technical insulating materials the power of the force is nearly 1.0 and the power of the time nearly zero.

ABOUT six months ago Lüppo-Cramer published his discovery that phenosafranin has the remarkable property of desensitising photographic plates without interfering with the developable image that has been impressed on them, as in the course of ordinary exposure. We have already referred to this and to the solution that Messrs. Ilford have put upon the market that enables the most sensitive plates to be developed with no more precaution as to the safety of the light than would be necessary if the plates were one two-hundredth, more or less, as sensitive as they are. In the *British Journal of Photography* for June 17 and 24 Messrs. A. and L. Lumière and A. Seyewetz give details of experiments they have made on this subject. They have examined the desensitising action of a large number of other safranines, and find that while several are comparable in this matter to phenosafranin, none show any appreciable advantage to it, except that cresosafraanine is more easy to wash out of a gelatine film. Many other organic bodies show a notable, and even useful, degree of desensitising effect, but for general purposes phenosafranin is superior to them all. There appears to be no well-defined relation between the constitution of dyes and their desensitising properties. Phenosafranin does not act merely as a light-filter, for it transmits

red and violet, for both of which it desensitises. But if the plate is washed after treatment with the desensitiser, as the dye disappears the original sensitiveness is restored. It is therefore assumed that the dye forms an adsorption complex of much lower sensitiveness than the original silver bromide, and that this complex is unstable enough to be gradually decomposed by water. The authors have also examined plates treated with various typical desensitisers by exposing them in a spectrograph and estimating the loss of sensitiveness to light of different wave-lengths.

THE summer meeting of the Association of Science Teachers was held at Cambridge on July 9. In the afternoon Dr. Aston gave a lecture at the Cavendish Laboratory on "Atoms and Isotopes." Early ideas of the structure of matter, leading up to the formulation by Dalton of the atomic theory, were reviewed, and it was shown that the progress made in chemistry during the nineteenth century, which depended on the exact work done in the determination of atomic weights, had been inspired by Dalton's postulates. In order to explain fractional atomic weights, Crookes had suggested that an element might be a mixture of atoms of varying weight, but this was regarded as unlikely until in 1910 Sir Ernest Rutherford's work on radio-activity showed that various forms of lead obtained by radio-active changes had slightly different atomic weights, though their chemical properties were identical. To these substances Prof. Soddy gave the name of "isotopes." The method of positive-ray analysis due to Sir J. J. Thomson was then utilised. By this means it was found that neon—atomic weight 20.2—was probably a mixture of two isotopes of atomic weights 20 and 22, and after much labour a gas was obtained differing in density by 0.7 per cent. from the original, the experimental error being 0.2 per cent. This was not conclusive, but more exact methods of positive-ray analysis have shown that neon is made up of two constituents of atomic weight 20 and 22 in the ratio of about 9 to 1. Similarly, chlorine has been shown to consist of at least two isotopes of weights 35 and 37, and quite recently they have been separated. The work done shows clearly that the important property of an element is the atomic number or the positive charge on the nucleus of the atom, and it is this alone which determines the chemical properties of the element.

THE *Journal of the British Science Guild* for June contains an article by Sir Richard A. S. Redmayne on the world-position in relation to coal. Great Britain has been unfortunate in her recent experiences. Prior to the war she exported about 73,000,000 tons of coal plus 21,500,000 tons shipped as bunker coal, making 94,500,000 tons, or 32 per cent. of her total output. But in 1919 this total was only 47.3 million tons, 20.6 per cent. of the production. In the present year the figures will doubtless be still more unsatisfactory. Other countries have also produced less coal. The entry of China as a competitor in the coal markets of the West is significant. Oil, it is stated,

cannot become a real menace to the coal trade, as the amount available is only one-sixteenth of that needed to displace coal, and much of this is required for other purposes. A summary of addresses delivered at the annual dinner of the Guild by Field-Marshal Sir William Robertson, Col. Sir Ronald Ross, the Very Rev. Dean Inge, the Right Hon. Lord Rayleigh, and the Right Hon. Lord Bledisloe is also included in this issue of the Journal. Sir William Robertson made some illuminating comparisons between military experience of the past and the scientific warfare of the present day. He remarked that the day of the amateur is past, and that those who aspire to exercise Ministerial control over the destinies of this country should attach greater importance to the value of science. The administrative activities of the Guild fill a considerable portion of the issue. Special importance attaches to the report of the Committee on the Utilisation of Science in Public Departments, attention being directed to the position of scientific research workers in regard to tenure of service, salary, super-

annuation, etc. The attitude adopted by the Scientific Research Department of the Admiralty towards the individual university worker whose researches bear on Admiralty requirements is spoken of with approval.

A FAVOURABLE opportunity of obtaining books in general literature and on scientific subjects in new condition at prices considerably below those at which they were published is presented by Messrs. W. Heffer and Sons, Ltd., Cambridge, in their "Remainder" catalogue (No. 201), which has just been issued. It contains 485 titles, and is worthy of perusal.

THE most recent catalogue of Mr. F. Edwards, 83 High Street, Marylebone, W.1, is No. 416, entitled "Australasia and the South Seas." It gives particulars of some 813 works relating to Australia, New Zealand, Tasmania, New Guinea, and the islands of the Pacific. Some very choice and rare volumes are included.

Our Astronomical Column.

RECENT METEORS.—Mr. Denning writes:—"On July 5 there were two showers in prominent activity, supplying large, slow-moving meteors. The radiants were at $243^{\circ}+65^{\circ}$ and $228^{\circ}+58^{\circ}$. These positions are some distance east of the radiant point computed for Pons-Winnecke's comet, but it is possible the comet and meteors may be associated, the discordances having been brought about by perturbations. Fireballs were observed at Bristol on July 5 11h. 40m. G.M.T. from radiant $243^{\circ}+65^{\circ}$, on July 9 11h. 54m. from radiant $238^{\circ}+18^{\circ}$, and 12h. 47m. from radiant $343^{\circ}+12^{\circ}$. A well-defined shower of swift, streaking meteors was observed from the latter position on the night of July 9."

ANOTHER PLAN OF CALENDAR REFORM.—Prof. René Baire (Dijon) contributes an article to *Revue Scientifique*, 1921, No. 9, in which he points out several drawbacks (chiefly from a statistical point of view) attaching to the proposal to place certain days in each year outside the weekly and monthly reckoning. His plan of evading the difficulty is bold and novel, and consists in shortening the greater number of weeks to six days. A Saturday would occur only on the thirty-first day of the month—that is, five times in the year or six times in leap-year. The months are left nearly as at present, but the missing days of February are supplied. The following is the suggested table:—January 30, February 30, March 31, April 30, May 31, June 30, July 30, August 31, September 30, October 31, November 30, December 31. In leap-year July has 31 days.

The 1st, 7th, 13th, 19th, and 25th days of each month would be Sundays; there would thus be sixty Sundays in the year instead of the present fifty-two or fifty-three. The author seeks to disarm ecclesiastical criticism by pointing to this increased number; he also notes that the feasts of January 1, November 1, and December 25 would always occur on Sunday, while if Easter were fixed to the date April 1 it would be preceded by a Saturday. It is proposed that the additional Sundays should take the place of the present Bank Holidays, thus making the number of working days in the year much the same as at present.

While the scheme has some obvious advantages, it is doubtful whether public opinion could be brought to sanction such a revolutionary change.

THE VARIABLE NEBULA IN CORONA AUSTRALIS.—Bulletin 20 of the Helwan Observatory contains a photographic research by the director, H. Knox Shaw, of the variability of this nebula and the neighbouring star R Coronæ Australis. The star magnitudes were deduced by comparison with standard fields at the same altitude, the incidental result being derived that the graph connecting magnitude with diameter of image shows decided curvature in the direction of enlargement of the image of the fainter stars. There are five variables in the field besides R Coronæ, viz. S and T Coronæ, C.P.D. -37.8450° (shown by Mr. Innes to be an Algol variable with period just under twenty-six days; a minimum of this star was observed at Helwan in 1915 August 9) and two other stars. Except for the Innes star, the variations appear to be irregular, and Mr. Knox Shaw conjectures that they may be due, wholly or in part, to the absorbing medium which he assumes to cover the whole region, as its star density is distinctly less than that of the neighbouring sky. The variability of the nebula is next discussed. Its structure is shown to be made up of a series of rings and knots, which apparently remain *in situ*, but alter in relative brightness. This is analogous to the behaviour of the nebulosity round Nova Persei, and Mr. Knox Shaw has examined the results to see if there is any connection between the changes of the star R Coronæ and those of the nebula. There is suspicion that the nebular changes follow those of the star at a ten-day interval, but the interruptions of the series of photographs by moonlight render it difficult to confirm this. If correct, and if it be due to an emanation travelling from the star with the velocity of light, the distance of the object would be about 100 light-years. It is pointed out that Hind's and Hubble's variable nebulæ are also near variable stars, and in regions of the sky that give evidence of the intervention of absorbing matter.

An Interferometer for Testing Camera Lenses.¹

INTERFEROMETERS for the testing and correction of prisms and of lenses (for axial pencils) have been described in the *Philosophical Magazine* (vol. xxxv., January, 1918, p. 49). In its simplest

Fig. 1, and a side elevation in Fig. 2. Light from a suitable source is reflected by a mirror 10 into the interferometer. A convex spherical mirror 001 is so disposed that its centre of curvature coincides with the focus of the lens 14 which is under test. In these circumstances, a beam the wave-front of which is a plane perpendicular to the axis of the lens will, after passage through the lens, be reflected back on its own path by the convex mirror, and if the lens be free from spherical aberration the reflected beam will, after passage through the lens, once more have a plane wave-front. If it has not, then the departure from planeness will produce interference bands which form a contour map of the corrections which will have to be applied to the lens to make its performance perfect.

An apparatus which will test for axial pencils only is, of course, of little use for testing camera lenses. The modifications essential for the latter purpose are (1) means of rotating the lens about a line at right angles to the axis and passing through the second principal point, and (2) mechanism whereby, simultaneously with the above rotation of the lens, the convex back-reflecting mirror is automatically moved away from the lens in such a way that its centre of curvature always falls on the plane, perpendicular to the axis of the lens, on which the lens is desired to form its image.

The rotation of the lens carriage is effected by means of a bar 105 parallel to the axis of the lens and extending to the outer edge of the interferometer. The second requirement is fulfilled by a flexible connection being led from the carriage on which the mirror is adjustably mounted

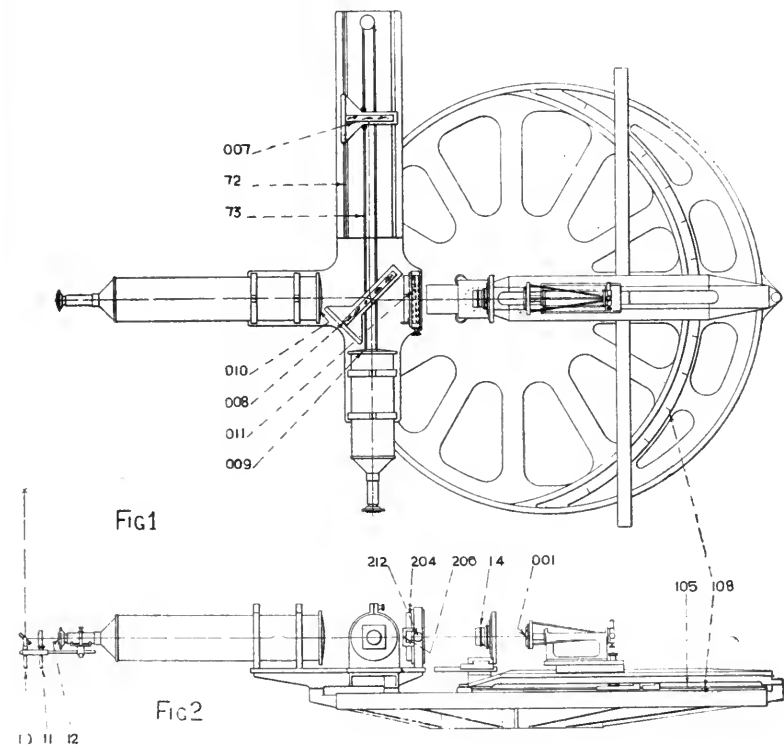

FIGS. 1 and 2.—Plan and side-elevation of lens interferometer.

form the instrument resembles the well-known Michelson interferometer, the essential optical difference being that the two interfering beams of light are brought to a focus at the eye of the observer. The principles of the prism interferometer have been applied to

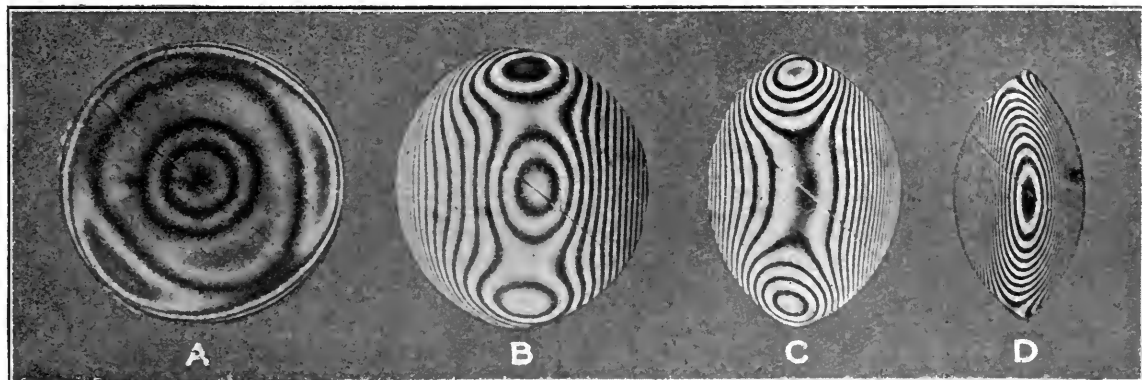

FIG. 3.—Interferograms of a photographic lens for axial and oblique beams.

photographic lens testing in the camera lens interferometer recently constructed by Messrs. Adam Hilger, Ltd. A plan of the instrument is shown in

¹ Abstract of a paper read before the Optical Society on April 14 by T. Twyman.

and over a pulley to a weight, and by there being upon the carriage a roller which by the action of the weight is retained in contact with a cross-bar mounted on the axial bar 105 and at right angles to it.

Adjustments are provided for bringing the second principal point of the lens under test on to the axis about which it is rotated by the bar, and also for bringing the centre of curvature of the mirror exactly on the axis of the roller above-mentioned and on the optical axis of the lens. The distance from the centre of the roller in the axial position to the axis of rotation of the lens is measured by a vernier. When all adjustments have been made, this vernier gives the focal length of the lens to an accuracy of about 0.001 in.

The apparatus measures the degree to which the wave-front, impressed by the lens on light from a distant point source, differs from a spherical wave-front. The indications are given in aberrations of wave-front to a scale of wave-lengths, the aberration shown being in every case twice that present in the once transmitted beam which normally forms the image of a distant point. The form in which the indications are presented is that of a series of inter-

ference fringes which are lines of equal aberration of wave-front. These interferometer pictures can be translated into terms of geometric optics by an observer who has had a little practice with the instrument. The various types of aberration and their chromatic variations produce characteristic interference patterns, and thus they can be readily differentiated and measured in terms of wave-length. By means of the pair of deflectors on a measurement of the distortion can also be obtained.

With a suitable source of light and a suitable camera the interference patterns can be photographed, and a complete photographic record can be obtained of the performance of any camera lens. Fig. 3 is a photographic reproduction of the interferograms of a well-known lens of high repute for the green mercury radiation ($546\mu\mu$) for the axial beam and for obliquities of 5° , 10° and 15° . It will be seen that even the best photographic lenses—of which this is a fair example—are very far indeed from perfection.

Mutations and Evolution.

IN the series of articles by Dr. Ruggles Gates appearing under the above title in a *New Phytologist* Reprint (No. 12), published by Messrs. Wheldon and Wesley, Ltd., we have the most recent attempt to present a reasoned and comprehensive statement of the problem of evolution. As the author tells us, his aim has been to show that though germinal (by which apparently we may understand chromosomal) changes are of importance in the evolutionary process, they cannot be considered as all-sufficing; that only from the Neo-Lamarckian point of view is it possible to explain a large class of organic phenomena. From this point he sets out to show how the Darwinian doctrine and Mendelian conceptions in combination may furnish us with a solution. To this end, however, it scarcely seems necessary to maintain, as the author is at pains to reiterate, that in the application of Mendelian principles we are merely putting into use a refinement of the theory of natural selection. Nor does any point appear to be gained by this insistence on accord, since, by the author's own showing, the underlying difference between Darwinism and Mendelism—the difference, namely, between the idea of continuity and discontinuity—is profound enough to have divided biologists into two opposite camps. One feels that what is common ground might more easily be made apparent if an attempt were made to define more strictly, or else to abandon, terms which are used to cover an ever-increasing complex of ideas. It will be obvious, for example, that a fresh analysis of evolutionary processes should be couched in terms which clearly differentiate the causes (= true factors) to which variation is presumably due from the mechanism by which variations, once having appeared, are perpetuated, and from conditions which permit or limit the occurrence of variation. That the author evidently has in mind the necessity for precision in this connection appears from the fact that he is careful to point out that isolation due to geographical barriers must be regarded as a *condition*, and not as a *factor*, yet he fails to draw this distinction when dealing with natural selection.

The important point which Dr. Gates seeks to establish is that a new character may arise in *two* different ways: (1) as the result of what we have still to term *spontaneous* nuclear (=karyogenetic) mutations; (2) from a so-called organismal change, *i.e.* a change due either to environmental effects on the cyto-

plasm or to the morphological principle known as orthogenesis. In the first case the mutation is perpetuated through the *whole* cell-lineage, and the associated character is inherited as a unit. In the second a *localised region or a particular stage in the life-cycle* only is usually affected. Perpetuation of an organismal modification connotes the inheritance of acquired characters.

Mutations.—The more striking observations of Morgan and other American workers on *Drosophila* and of de Vries, the author, and others on *Oenothera*, which indicate a direct relation between chromosomal behaviour and somatic appearance, are set forth. Definite zygote characters are shown to be constantly associated with definite irregularities in the meiotic division, as, *e.g.*, the *lata* habit in *Oenothera* with the presence of an extra chromosome. The author brings forward evidence of independent sporadic appearances of this form, and a parallel mutation has been obtained in cultures of other *Oenothera* species. In every case the number of chromosomes was found to be 15 instead of the typical complement 14. The occasional occurrence of an 8-6 instead of a 7-7 separation of the chromosomes in another mutant form supplied the clue to the mode of origin of these 15-chromosome forms. In another instance a particular strain of *Drosophila*, indistinguishable in general from the normal but showing an aberrant type of inheritance, led Bridges to infer the duplication of a sex-chromosome—a prediction which later investigation proved to be correct. These forms with an extra chromosome are found seldom, if ever, to breed true. Their importance, according to the author, lies in the support which they give to the conception of the origin of a zygotic character from a nuclear mutation rather than in their significance in evolution. It is held to be otherwise, however, when the whole chromosomal equipment is duplicated (tetraploidy) and associated with a characteristic giant habit as in *Primula* and *Oenothera*.

The separate class of Mendelian mutations is regarded as due also to a nuclear change (in this case possibly chemical) which is presumed, however, to affect only a particular locus or element in the chromosome. It is clear, however, from Bridges's observation cited above, and from Heribert-Nilsson's work on *Salix* (which the author does not discuss), that, on one hand, duplication of chromosomes *need not* be accompanied by any gross change in the organism, and, on

the other, that a Mendelian mutation *may* produce an alteration in habit as marked as that which characterises the *Oenothera* forms with an extra chromosome. This being so, what becomes of the author's scheme of classification?

Organismal Characters.—The conception of organismal characters has been developed primarily, apparently, to account for the phenomenon known as recapitulation, *i.e.* the appearance in the individual of ancestral structures in a reduced or functionless form. In his treatment of this part of the subject the author is not easy to follow. Much of the argument advanced appears, and is admitted, to be inconclusive. The reader is left wondering why the "species cell" concept which has sufficed as a basis of explanation for karyogenetic mutations is here abandoned, and why physiological considerations are ignored. The essence of the conception of the "species cell" is, we are told, that when a new form arises it does so in consequence of some antecedent change in a (germ) cell unit. The individual derived from such a mutated germ-cell will exhibit the associated character in all its parts. The reasoning from this point onwards seems to be as follows:—If organisms were entirely composed of such cell units, then germinal mutations might supply the whole basis for evolution. But regions or structures occur in the organism in which the cell unit is ill-defined or non-existent, therefore some other type of evolution must take place [!]. It does not appear, however, that it is in these regions or structures that the postulated environmental effect is felt. In fact, the line of argument now seems to lose touch with the cell altogether, and to work backwards from the other end, thus:—Recapitulation occurs, therefore at some point a lengthening of the life-cycle must have taken place. This can have come about only through additional cell-divisions taking place either at the end or in the course of the original cycle. Having laid it down that a *germinal* mutation is required to produce a new character, the author is driven to conclude that this extension of the life-cycle cannot be due to a change in a cell unit, "but must rather be the result of the organism, as it were, overcoming its cell-shackles and by its own energy [not, be it noted, through an environmental effect, as by the definition we are led to expect] producing new developments, though such novel additions are themselves cellular in structure." Somewhat earlier in his argument the author chides those who "desert science for obscurantism," but what are we to call this?

Though it may be that the reader will not feel that the author's conceptions of evolutionary processes materially advance the position, he will, nevertheless, find in these articles a useful collection of pertinent data.

University and Educational Intelligence.

LIVERPOOL.—Following the recent transfer of the Port Erin Biological Station to the University (Department of Oceanography), Mr. Herbert C. Chadwick, who has been curator under the Liverpool Marine Biology Committee for the last twenty-four years, has now resigned, but remains on the staff of the institution as research assistant. Mr. J. Ronald Bruce has been appointed naturalist-in-charge, and official letters should be sent to him.

ST. ANDREWS.—The following honorary degrees were conferred at the annual graduation ceremony on July 12:—*LL.D.*: Prof. W. M. Bayliss, professor of general physiology in University College, London; Sir William Henderson, chairman of Dundee Tech-

nical College; Emeritus Prof. D. MacEwen, Dundee; and Prof. A. N. Whitehead, professor of applied mathematics in the Imperial College of Science and Technology.

AMONG the bequests of the late Dr. H. Barnes, vice-president and a former president of the British Medical Association, are his medical books to the Royal Society of Medicine, and, conditionally, 2500*l.* to Edinburgh University for a scholarship for clinical medicine and 1500*l.* to Epsom College for a similar scholarship.

THE Paton-Figgis scholarship, value 50*l.* for a year and renewable, is being offered by the South-Eastern Agricultural College, Wye, Kent. Candidates must be reading for the B.Sc. (Agric.) degree, and reside outside the counties of Kent, Surrey, and Sussex. The latest date for applications to reach the Principal of the college is August 14.

THE following appointments have been made at the University College of Swansea:—Mr. F. A. Cavenagh to the chair of education; Dr. Florence A. Mockeridge, lecturer in botany and head of the department of biology; Mr. L. B. Pfeil, assistant lecturer in metallurgy; Mr. A. Stuart, assistant lecturer in geology; and Mr. J. S. Caswell, demonstrator in engineering for one year.

THE Ellen Richards research prize of 1000 dollars (200*l.*) is being offered by the Association to Aid Scientific Research by Women. Theses by women, based on independent laboratory research, are eligible for competition if received by the committee before February 25, 1922. Further information and application forms are obtainable from Dr. Lilian Welsh, Goucher College, Baltimore, Maryland, U.S.A.

Two Royal School of Mines Frecheville research fellowships, in aid of research in connection with mining, mining geology, metallurgy, or the technology of oil, are being offered by the Imperial College of Science and Technology, South Kensington, S.W.7. The fellowships are of the annual value of 300*l.*, tenable for one year, with a possible renewal for a second year. Applications, giving particulars of the candidate's proposed investigation, his qualifications and references, must be sent to the Secretary of the college before September 1 next.

We have received from Mr. G. D. Dunkerley, hon. secretary of the Secondary School Teachers' War Relief Fund, the report of the last year's working. The object of the fund is to supplement the pensions and allowances of soldiers, sailors, nurses, and their dependents, and to secure that the families of the fallen and disabled secondary-school teachers shall suffer to the least possible extent in material circumstances. A total of 9874*l.* has been collected, and allowances are now being made to the extent of 481*l.* per annum. Thus the present capital fully safeguards the present allowances, and leaves a margin for additional help. The committee has therefore decided to maintain the payments from capital and interest combined without appealing for further funds, the capital diminishing as the necessity for the allowances ceases. Every opportunity will be taken of helping the children of fallen teachers at future stages in their careers, and although it has been decided to close the subscription list in its present form, the committee will gratefully accept legacies or donations for this special purpose. The chairman of the committee is Mr. A. A. Somerville, of Eton College; the hon. treasurer is Mr. J. Hart-Smith, of the County Secondary School, Battersea, and donations should be sent to him, c/o Barclay's Bank, 835 Wandsworth Road, S.W.8.

Calendar of Scientific Pioneers.

July 14, 1827. Augustin Jean Fresnel died.—An officer in the Corps des Ponts et Chaussées, Fresnel during the last twelve years of his life devoted himself to experimental and mathematical researches in optics. Like Young, he did much to establish the undulatory theory of light.

July 14, 1879. Sir Thomas Maclear died.—Trained as a doctor, through Admiral Smyth Maclear took up astronomy, and from 1833 to 1870 was Royal Astronomer at the Cape of Good Hope. Among other work was his extension of Lacaille's arc of meridian.

July 14, 1907. Sir William Henry Perkin died.—The discoverer in 1856 of the first of the aniline dyes, aniline purple or mauve, Perkin established a factory for its manufacture, and thus became the founder of the great coal-tar colour industry. His success, especially with the manufacture of alizarin, enabled him in 1874 to retire, after which he made important investigations of questions of chemical constitution. He was knighted at the jubilee of his great discovery.

July 17, 1878. Thomas Oldham died.—After holding the chair of geology at Trinity College, Dublin, Oldham in 1850 was appointed by the East India Company the first Superintendent of the Geological Survey of India.

July 17, 1899. Charles Graves died.—The successor of McCullagh in the chair of mathematics in Trinity College, Dublin, Graves contributed mathematical memoirs to *Crelle's Journal*, and served as president of the Royal Irish Academy.

July 17, 1912. Jules Henri Poincaré died.—Born in Nancy in 1854, Poincaré in 1908 was elected president of the Academy of Sciences of Paris, by which time he had written 1300 books and memoirs relating to pure mathematics, mathematical physics, astronomy, and philosophy.

July 18, 1650. Christoph Scheiner died.—A member of the Society of Jesus and an opponent of the views of Copernicus and Galileo, Scheiner was one of the earliest observers of sun-spots. He taught at Freiburg (Baden), Rome, and Ingolstadt, and was rector of a Jesuit college in Silesia.

July 18, 1819. Barthélemy Faujas de Saint-Fond died.—Attracted to natural history by Buffon, Faujas de Saint-Fond became professor of geology in the Jardin des Plantes. He travelled much, wrote a valuable work on extinct volcanoes, and was the first scientific writer to direct attention to the basalt pillars of the Isle of Staffa.

July 19, 1814. Matthew Flinders died.—Known for his important survey of the Australian coast, Flinders made observations on the compass, and to him we owe the "Flinders bar" for neutralising a ship's magnetism.

July 19, 1838. Pierre Louis Dulong died.—Dulong was director of studies at the Ecole Polytechnique, and in 1832 became one of the secretaries of the Paris Academy of Sciences. In 1819 with Petit he enunciated the law connecting the atomic weight of a substance with its specific heat.

July 19, 1882. Francis Maitland Balfour died.—Killed at the age of thirty-one when climbing Mont Blanc, Balfour had just been appointed to a newly created chair of animal morphology at Cambridge. His "Comparative Embryology" appeared in 1880-81.

July 20, 1819. John Playfair died.—An Edinburgh professor, Playfair's principal contribution to science was his "Illustrations of the Huttonian Theory of the Earth."

July 20, 1866. Georg Friedrich Bernhard Riemann died.—Successor of Dirichlet in the chair of mathematics at Göttingen, Riemann was one of the most profound mathematicians of his time. E. C. S.

Societies and Academies.

LONDON.

Geological Society, June 22.—Mr. R. D. Oldham, president, in the chair.—Dr. C. T. Trechmann and L. F. Spath: The Jurassic of New Zealand. The Jurassic beds of New Zealand comprise an important set of sediments, probably 10,000 ft. in thickness, exposed at certain points extending over the length of the North and South Islands. They follow the Trias with apparently perfect conformity. The affinities of the fossils from the Lower Lias to the Upper Jurassic formations are with those occurring in the Jurassic of the Argentine Andes, Western Australia, the Sula Islands, the Spiti Shales of the Himalayas, and the Jurassic deposits of Kutch. Descriptions of New Zealand ammonites from the British Museum collections, notably a small fauna of typically Mediterranean aspect, which is referred to the Middle Lias, were given.—F. Dixey: The norite of Sierra Leone. The norite of Sierra Leone constitutes a complex of which the oldest and most important member is an olivine-norite. The complex forms the mountainous mass which, with a narrow coastal plane of Pleistocene sediments, makes up the Sierra Leone peninsula. The norite was intruded in the form of a huge stock; it has no marginal or basic modifications, while its junction with older rocks is obscured by the Pleistocene sediments. The complex is probably somewhat later than Pre-Cambrian in age. The main intrusion of norite was invaded in succession by minor intrusions of younger norites, norite-pegmatite, beerbachite, norite-aplite, and dolerite. Features of the older norite are well-developed flow-banding, a series of binary and ternary intergrowths of the common minerals, and metamorphism due to the minor intrusions. Iron-ores occur in the norite as small masses, narrow schlieren, and disseminated grains; they are highly titaniferous. Sulphides and other economic minerals are rare or absent.

EDINBURGH.

Royal Society, July 4.—Prof. F. O. Bower, president, in the chair.—C. T. R. Wilson: Recent work on lightning and thunderstorms. A thundercloud may be regarded as a great electrical machine, and suggests such questions as the electromotive force developed by the machine, the current which passes through it, and the external distribution of the current. It is at present mainly from a study of the electric force at the ground during thunderstorms that we obtain information on these points. Records were shown of the changes in the electric field due to thunderstorms at a distance, and of the sudden changes produced by lightning discharges. From the results of automatic records of this kind it is concluded that in an average lightning flash a quantity of electricity amounting to about 20 coulombs passes, and that the potential difference required to cause the discharges is of the order of one thousand million volts. In addition to lightning discharges there may be considerable continuous currents maintained by the thundercloud. The electrical energy going to waste in a thunderstorm may amount to a million horse-power. A large part of the current maintained by the thundercloud may pass through the cloud from the ground to the conducting upper atmosphere, or from the upper atmosphere to the ground, and produce effects which are of importance in connection with the atmospheric electricity of fine weather, and possibly with terrestrial magnetism.—Prof. H. Briggs: The adsorption of gas under pressure. The author describes a series of experiments

with different gases and with different adsorptive substances to ascertain the volume of gas adsorbed at pressures up to 100 atmospheres. The tests show that it is possible to increase the gas capacity of a cylinder, holding the gas under compression, if the cylinder be completely filled with coconut charcoal before the gas is pumped in. The reason for certain sudden outbursts of fire-damp in coal mines is stated to be due to the adsorption of that gas under pressure by the coal. In some cases millions of cubic feet of fire-damp have been suddenly discharged in mines when the equilibrium was disturbed.—Miss Elizabeth **Gilchrist**: The utilisation of solid caustic soda and the absorption of carbon dioxide. The experiments aimed at ascertaining the optimum condition for the absorption of carbon dioxide by solid caustic soda granules, especially with the object of improving that action in mine rescue apparatus. The absorption diminishes at temperatures approaching 0° C. and at temperatures exceeding 100° C. The behaviour of a caustic granule at or near the optimum condition is described, it being shown how the granule swells gradually, eventually becoming a shell of carbonate hollow within.—Miss Augusta **Lamont**: The development of the feathers of the duck during the incubation period. The external appearance and the internal structure of the feather-papillæ are figured and described, and special stress is laid on the distinction between pennaceous and plumaceous feathers during their earliest stages. The work is preliminary to further researches.—A. G. **Ramage**: Note on the conditions for mirage on the Queensferry Road. The surface of the road was remade in the spring of 1919 with road metal and liberal supplies of bitumen, and small pieces of quartz scattered on the top of the bitumen, the whole being rolled by a steam-roller. After this had been done no signs of the mirage, so common on this road the previous summer, made their appearance until August, and then but faintly. During the summers of 1920 and 1921, on bright days, mirage was again much in evidence, showing that a newly made road is not conducive to the appearance of the mirage phenomenon.

DUBLIN.

Royal Dublin Society, June 28.—Dr. F. E. Hackett in the chair.—Prof. T. **Johnson** and Jane G. **Gilmore**: The occurrence of a Sequoia at Washing Bay, Co. Tyrone. The conifer was found in the core of the coal-bore, especially in the zone between 890–930 ft. It is represented by wood, by shoots showing dimorphic foliage, by cones and pollen-grains. The authors find it to agree in all respects with *S. Couttsiae*, Heer, from the upper Oligocene of Bovey Tracey, Devonshire. They have also examined Baily's type material of *S. du Noyeri*, and refer it to *S. Couttsiae* as a possible variety. They describe one specimen showing the two types of foliage on the same shoot. The paper also contains an account of the distribution and characters of the stomata in Sequoias, recent and fossil.—P. A. **Murphy**: The sources of infection of potato tubers with the blight fungus, *Phytophthora infestans*. The results of field experiments in Canada and Ireland on the decay caused by the blight fungus in potato tubers, with particular reference to the rot which sets in after digging, are detailed. When blight rot is found in quantity in the pits in winter it does not owe its origin to the spreading of the disease from a few initially infected tubers. Many tubers not visibly diseased carry the infection with them to the pits. The source of infection has been traced to contact of the tubers at digging time with

blighted, but partially living, foliage, and with contaminated surface soil. The conidia live in the soil for at least two weeks after the death of the tops, and such soil may be a dangerous source of infection.

PARIS.

Academy of Sciences, June 20.—M. Georges Lemoine in the chair.—H. **Andoyer**: The direct demonstration of a theorem of Tisserand relating to the development of the perturbation function.—E. **Houg**: The tectonic of the coast region between Saint-Cyr and Hyères.—C. **Richet**, Mlle. Eudonie **Bachrach**, and H. **Cardot**: The alternations between tolerance and anaphylaxy. Studies on the lactic ferment. Successive generations of the bacillus show at first a decrease in activity by small proportions of mercuric chloride in the culture media, then get accustomed and increase in activity (measured by the lactic acid formed), but lose this tolerance later, become sensitive, and are killed. With smaller doses of the poison there is at first an acceleration, then an anaphylactic phase, and finally death of the organism.—C. **Depéret** and M. **Solignac**: The Sahalian of northern Tunis.—M. **de Sparre**: The yield of turbines working with a variable head.—W. **Kilian** and F. **Blanchet**: The presence of a sub-alluvial sheet of thermal or mineralised water in the bed of the Durance, at Serre-Ponçon. These hot springs were discovered in the course of work carried out in connection with the construction of a hydro-electric power station. The water was saline, temperature 47° to 49° C.—B. **Gambier**: The deformation of surfaces and the Laplace equation.—L. **Dunoyer**: The complete chronophotographic determination of trajectories. The method is based on the simultaneous photography from two determined positions of the path of a luminous projectile.—A. **Sanfourche**: The absorption of the oxides of nitrogen by sulphuric and nitric acids.—L. **Guillet** and M. **Ballay**: Critical points due to hardening caused by wire-drawing. The hardened wire has a part annealed, and the electrical resistances of the annealed and unannealed portions are compared at various temperatures; the results are recorded on a differential curve. This electrical method is superior to the dilatometric and other methods in use.—A. C. **Vournazos**: A new magnesian hydraulic cement. A description of the preparation and properties of some cements produced from magnesia (magnesite calcined at a low temperature) and powdered pumice or silica.—M. **Baille-Barrelle**: Contribution to the study of the coking of Saar coals.—A. **Mailhe**: The catalytic decomposition of the polyhalogen derivatives of the paraffins. A study of the reduction of tetrachloroacetylene, tetrabromoacetylene, chlorodibromopropane, dichlorodibromoacetylene, and trichlorodibromoacetylene by hydrogen in presence of reduced nickel and barium chloride as catalysts. The product is always a halogen-substituted ethylene. When there are different halogens the bromine is first removed by the hydrogen.—J. B. **Senderens** and J. **Aboulenc**: The catalytic decomposition of the bromoacetic acids and of mixtures of bromine and acetic acid.—J. **Savornin**: Observations on the Palæozoic of Rabat, Morocco.—P. **Bonnet**: Mesozoic volcanic eruptions and their relations with the distribution of the facies in the Caucasian geosynclinals.—J. **Cvijić**: River platforms and erosion steps.—Mlle. Y. **Boisse de Black**: The "frane" of the Cère Valley.—A. **Treuthardt**: Some new measurements of the density of the air at Geneva. Some results of measurements carried out in 1917. The deviations observed are larger than the experimental error, and the values below the average (1.29269) were obtained when the barometric pressure was above the

mean pressure for Geneva.—E. Moles, T. Batuccas, and M. Payà: The density of the air at Madrid and its small variations. The results of thirty series of measurements are given, each series comprising two or three observations. The mean is 1.29303, and the deviations are regarded as being outside the experimental error. In agreement with the Loomis-Morley hypothesis, the minima of density correspond with the maximum of atmospheric pressure and conversely.—L. Blaringhem: The pollen of flax and the degenerescence of the varieties cultivated for the fibre. The study of the quality of the pollen of isolated pedigrees, followed during several generations, is recommended for the selection of flax grown for the fibre.—C. Porcher and A. Chevallier: The distribution of the saline substances and the mineral elements in milk.—W. Mestrezat and Mlle. S. Ledebt: The compensating rôle of chlorides in its relations with the chemical composition of the body fluids.—P. Chailley-Bert, R. Faillie, and J. P. Langlois: The "second wind" of runners. Experiments are given showing that the "second wind" is brought about by a diminution in the respiratory exchanges, and that this diminution, the work remaining constant, is the result of a better adaptation of the subject, an improvement in the yield of the human machine.—H. Piéron: The importance of the peripheral phase in the margin of the variation of the times of sensorial latency as a function of the intensities of stimulation.—A. Vandel: The question of cellular specificity in *Polycelis cornuta*.—F. Picard: The determination of egg-production in *Pimpla instigator*. Experiments proving that the sight plays no part in the act of depositing the egg.—P. Remy: The action of the vapours of chloropicrin on *Argas reflexus*. This parasite of the pigeon has proved to be extremely difficult to destroy by the ordinary insecticides; it is now proved to be destroyed by the vapours of chloropicrin, the amounts required being small enough for practical use.—A. Goris and A. Liot: Observations on the culture of the pyocyanic bacillus on artificially defined media.—E. Sergent and M. Béguet: The mycotic nature of a new disease of the date-palm threatening the Morocco oases.

SYDNEY.

Linnean Society of New South Wales, May 25.—Mr. G. A. Waterhouse, president, in the chair.—T. G. Sloane: Revisional notes on Australian Carabidæ, pt. vi. The tribe Bembidiini is reviewed so far as the Australian fauna is concerned. The synonymy is given, and seven species of Tachys are described as new. The tribe, as represented in Australia, consists of five genera, of which only *Illaphanus* is peculiar to Australia; the five genera comprise fifty-eight species.—Dr. A. J. Turner: Revision of Australian Lepidoptera—Hypsidæ, Anthelidæ. Six genera, one of which is new, and fourteen species of Hypsidæ and seven genera and forty-seven species (twelve new) of Anthelidæ are described.—T. Steel: Ulmite, a constituent of black sandstone. A black friable sandstone which outcrops frequently on the coast of New South Wales consists of sand grains with a thin, dark-coloured coating. This coating is identical with humus extracted from soil.—W. P. Hiern: A new species and a new variety of *Diospyros*. A new species is described from New Caledonia, and a new variety of *D. samoënsis* from Apia, Samoa.

Books Received.

Power House Design. By Sir J. F. C. Snell. Second edition. Pp. xi+535. (London: Longmans, Green and Co.) 42s. net.

The Garden of Earth. By A. Giberne. Pp. xiv+178. (London: S.P.C.K.) 6s. 6d. net.

NO. 2698, VOL. 107]

Mountain and Moorland. By Prof. J. A. Thomson. (Nature Lover's Series.) Pp. 176. (London: S.P.C.K.) 6s. net.

Engineering Steels. By Dr. L. Aitchison. (Reconstructive Technical Series.) Pp. xxxi+348+48 plates. (London: Macdonald and Evans.) 25s. net.

The Beloved Ego. By Dr. W. Stekel. Authorised translation by R. Gabler. Pp. xv+238. (London: Kegan Paul and Co., Ltd.) 6s. 6d. net.

Whitherward? Hell or Eutopia. By V. Branford. Pp. xv+116. (London: Williams and Norgate.) 2s. 6d. net.

Air Ministry: Meteorological Office. Professional Notes No. 19. Cracker Balloons for Signalling Temperature. By L. F. Richardson. (M.O. 240i.) Pp. 95-115. (London: H.M. Stationery Office.) 1s. net.

Diary of Societies.

THURSDAY, JULY 14.

ROYAL SOCIETY OF ARTS, at 8.—Prof. H. E. Armstrong and A. C. Klein: Paints, Painting, and Painters, with Reference to Technical Problems, Public Interests, and Health. (To be followed by a discussion.)

FRIDAY, JULY 15.

INSTITUTION OF PRODUCTION ENGINEERS (at Institution of Mechanical Engineers), at 7.30.—M. Lawrence: Production and the Engineer.

MONDAY, JULY 18.

ROYAL BOTANIC SOCIETY OF LONDON, at 3.—Prof. A. R. Bickerton: The Generic Simplicity and Great Importance of Basic Principles in all Scientific Work. III. The Importance of the Cosmic Theory of the Third Body.

CONTENTS.

	PAGE
The London Electricity Inquiry	609
Congress of Universities	610
A Psychology of Logic. By Prof. H. Wildon Carr	612
Text-books on Theoretical Chemistry	613
A Jungle Book	615
Elementary Pure Mathematics. By Dr. S. Brodetsky	616
Our Bookshelf	618
Letters to the Editor:—	
The Separation of the Isotopes of Chlorine.—Prof. J. N. Brönsted and Prof. G. Heve-y	619
A Novel Magneto-Optical Effect.—Dr. R. Whytlaw-Gray and J. B. Speakman; Prof. Elihu Thomson	619
The Japanese Artificially Induced Pearl. (Illustrated).—Dr. Wyatt Wingrave; Dr. H. Lyster Jameson	620
Sources and Sinks.—Dr. H. S. Allen	622
Helicopters.—A. R. Low	622
A Prehistoric Cooking-place in Norfolk.—Nina F. Layard	623
Science and Civilisation.—Capt. B. J. Marden	623
Measurement of Small Inductance.—F. B. Pidduck	623
A New Acoustical Phenomenon.—Dr. G. A. Shakespear	623
Large-scale Chemistry at the Imperial College of Science and Technology. (Illustrated) By J. F. T.	624
Great British Droughts. By Chas. Harding	627
The Scarcity of Swallows. By Dr. Walter E. Collinge	628
The King George V. Dock, London	628
Notes	629
Our Astronomical Column:—	
Recent Meteors	634
Another Plan of Calendar Reform	634
The Variable Nebula in Corona Australis	634
An Interferometer for Testing Camera Lenses. (Illustrated)	635
Mutations and Evolution	636
University and Educational Intelligence	637
Calendar of Scientific Pioneers	638
Societies and Academies	638
Books Received	640
Diary of Societies	640



THURSDAY, JULY 21, 1921.

Editorial and Publishing Offices:

MACMILLAN & CO., LTD.,

ST. MARTIN'S STREET, LONDON, W.C.2.

Advertisements and business letters should be
addressed to the Publishers.

Editorial communications to the Editor.

Telegraphic Address: PHUSIS, LONDON.

Telephone Number: GERRARD 8830.†

The Tuberculosis Problem.

THE forthcoming international conference on tuberculosis, which is to be held in London on July 26-28, is likely to provide some considerable additions to our knowledge of this chief of diseases, and may, it is hoped, serve also to give heart to those engaged in the preventive and curative work which has stood the test of trial. The president of the International Union against Tuberculosis is the eminent French jurist and statesman, M. Léon Bourgeois, and it is significant of the double rôle of the conference that Prof. A. Calmette, of Lille, will open a discussion on the modes of diffusion of tuberculosis throughout the races of the world, while an English physician, Sir H. Rolleston, will open another discussion on the duty—too much neglected—of the medical profession in the prevention of tuberculosis.

On the first subject much additional light has been thrown by the investigations of Metchnikoff and of Prof. Calmette himself, and by the further evidence marshalled, a few months ago, in an interesting contribution by Prof. Cumming, of the University of Wales, to the *International Journal of Hygiene*. In a recent volume on "The Epidemiology of Pulmonary Tuberculosis," Col. Bushnell, of the U.S. Army Medical Service, who will take part in the London conference, has collected a mass of evidence on the racial incidence of tuberculosis, which enables us to approach to a definite understanding of the remarkable differences in the death-rate from

tuberculosis in different races. Briefly and, therefore, imperfectly summarised, the general trend of facts indicates that the differences displayed between different races are largely, if not entirely, explicable by consideration of the age at which exposure to infection by tubercle bacilli first occurs, by the dosage of infection which is received, and by the social and sanitary circumstances in which populations are infected. There may be—and it is not improbable that there are—true racial differences in susceptibility to infection, due to the fact that certain races have not experienced the selective effect of exposure during many generations to infection. Nevertheless, although this factor cannot be excluded by any directly available evidence, it is scarcely consistent with its operation on a large scale that there exist remarkable differences in respect of mortality from tuberculosis between persons in various social strata and industrial occupations and between communities the members of which have all been exposed for many generations to the ravages of this disease.

Whatever view is taken of the selective influence of exposure to tuberculosis in successive generations, epidemiological facts show clearly that the amount of tuberculosis in adult negroes, for instance, is determined in large measure by their past individual experience in respect of exposure to the infection of this disease. In Army experience, negroes who have previously lived under urban conditions have had little more tuberculosis than white men under similar conditions. In the past much error has arisen from not comparing white and coloured populations of corresponding social status. Negroes commonly live in overcrowded houses, are badly fed, and are extremely dirty in their habits; comparison should therefore be between them and the occupants of common lodging-houses, rather than between them and the average white population.

When, however, negroes who have previously lived in remote parts where tuberculosis is not prevalent are exposed to infection, they suffer to an extraordinary extent. The same remarks apply to Red Indians and other races having a similar antecedent experience. This difference between persons not exposed in early life to infection and others who have been so exposed holds good, as is well known in Army experience, for measles. Adults, whether coloured or white, who have not previously been exposed to measles suffer much more severely from this disease than the average adult. In this instance, also, the

operation of natural selection is conceivable, but it may be that the *differentia* between the two classes lies in the acquired immunity due to attacks in early life, or to the vaccinal influence of small repeated doses of the specific contagium. There is little doubt, however, that at the forthcoming conference Prof. Calmette and others will marshal the evidence bearing on this and allied disputed points.

It is too little known that, even in a country like England, in which tuberculosis has long been endemic, the highest death-rate from this disease occurs during the first five years of life. In the first year after birth one death out of every twenty-six from all causes is certified to be due to tuberculosis; the real proportion is much higher, many deaths returned as due to pneumonia or bronchitis being cases of acute tuberculosis. Landouzy has stated that 27 per cent. of the deaths in the first two years of life are caused by tuberculosis. The practical lesson from these facts is that in childhood in every race there is but little resistance to the infection of this disease. If, therefore, the total human death-roll at all ages from tuberculosis is to be lowered, it is of supreme importance to prevent children from being exposed to infection during the first five years, and especially during the first two of these years.

The heavy child mortality from tuberculosis is followed by a lull in the incidence of the disease. Then there occurs a second peak of heavy mortality from tuberculosis in its pulmonary form, which in some communities is as high as, or even higher than, that in childhood. Dr. Brownlee has made some ingenious suggestions as to the reasons for the different ages at which this second peak reaches its maximum in various sections of the country, and it is to be hoped that this subject will receive adequate discussion at the forthcoming conference. Dr. Brownlee's suggestion that male adult-tuberculosis has a different origin, according to the shape of the curve, must be tested by the construction of similar curves of female mortality. Moreover, it remains to be shown that the varying age-incidence of maximum mortality from tuberculosis in different areas is not the result of varying exposure to infection and to circumstances calling latent tuberculosis into activity, rather than of a different etiology.

The double age curve of tuberculosis mortality in civilised urban communities throws light on the excessive mortality from tuberculosis among native races. In this country children who have

received (and possibly continue to receive) small doses of infection not competent to produce active disease acquire a relative immunity, which is overcome only when irritating dust, excessive fatigue, alcoholism, or an acute illness lowers personal resistance to a dangerous point. There was ample experience of these causes of excessive tuberculosis during the Great War. If native races are not thus "salted" in early life, they suffer excessively when exposed to tuberculosis in later life. Hence, as already indicated, the importance of safeguarding young children against protracted exposure to infection, and in later life of the segregation of bedridden cases of tuberculosis and of other patients living in unhygienic circumstances. In addition there are general measures of hygiene and improved nutrition the value of which in reducing tuberculosis is beyond question.

The practical aspect of special tuberculosis work will doubtless be discussed from many points of view at the London conference. It is common ground that the notification of tuberculosis to the Medical Officer of Health is an indispensable link in the chain of preventive measures. Unfortunately, it is well known that notification is imperfectly carried out by a large proportion of medical practitioners, who often do not notify cases for several months after they have come under their care. Thus the possibility of the more active preventive measures necessary is delayed.

The general relationship of the private practitioner to the prevention of disease is of fundamental importance if rapid progress is to be made. How to harness him to public health work is perhaps the most difficult, as well as the most important, problem of State medicine. At present he is often a hinderer of progress, though in other instances he is the most valuable of State servants. This subject also will doubtless be discussed at the forthcoming conference.

It cannot be said that the medical machinery of the National Health Insurance Act has helped. When we recall the fact that, even in present circumstances, a panel doctor may sometimes have as many as 3000 insured persons on his list, for whom he receives the annual payment of 165*ol.*, while he is also allowed to take other private patients, it cannot be expected that the adequate examination of all suspected cases of tuberculosis and their early treatment can be satisfactorily undertaken.

The essential point to be realised in practice—

and we are far from this at present—is that we cannot expect complete success in anti-tuberculosis work until we are in a position to say that “we are exercising complete supervision over, and making provision for, the whole of the sick life of the consumptive, whether he is trending towards complete recovery or towards death.” There is not a single community in Great Britain concerning which that statement can be affirmed. The nearest approach to it is what is known as the Framingham experiment, which has been going on for four or five years in a small town in Massachusetts, and of which a valuable account has been published by the American Tuberculosis Association. It is to be hoped that a full account of this experiment, and the results which have been obtained, will form part of the proceedings of the forthcoming conference in London.

The Foundations of Physics.

Physics: The Elements. By Dr. Norman R. Campbell. Pp. ix+565. (Cambridge: At the University Press, 1920.) 40s. net.

DR. CAMPBELL has attempted with great courage a very ambitious task—that of discussing critically the fundamental conceptions, propositions, and methods of the science of physics. A rough idea of the nature of his work may be given by saying that he attempts to do for the foundations of physics what Peano, Whitehead, Russell, and others of the modern critical school have done for the central principles of mathematics. The spirit, however, rather than the exact method of these mathematical philosophers is what he emulates, for, apparently, one of the factors which determined him to write this book was a lively dissatisfaction caused by the fact that hitherto all inquiry of this nature in physics has been carried out by mathematicians rather than by experimenters. Mach, of course, in spite of Dr. Campbell's implication, was an experimenter of note, as well as a mathematician and philosopher, but our author aspires to a somewhat more complete and general discussion than that carried out by Mach for certain branches of physics, and wishes to include recent developments. Again, he is more anxious to win the confidence of the man in the laboratory (who, as he says, is often “not merely uninterested in fundamental criticism, but positively hostile to it”), while at the same time desiring to meet the logicians on their own ground, if not with their own weapons. From a window in his study he looks down with sympathy upon the laboratory,

and writes with one eye on the bust of Mr. Bertrand Russell, serene above the conflict, and with the other on the working physicist, who is cursing alternately his electrometer and the theory of errors.

Dr. Campbell realises clearly that the physicist is not necessarily either logical or consistent when he is most efficient. This realisation is an important feature of the book, and distinguishes the author from his predecessors. “It is undoubted,” he says, “that we can study science with perfect satisfaction to ourselves . . . although we commit the heinous offence of using ambiguous terms. And this fact is simply an indication that we do not use in the course of our study any processes which require words to be unambiguous.” “Illogical is not synonymous with erroneous.” Again, he insists more strongly upon the fundamental importance of analogy than do most writers on the principles of science, contending that analogies are not so much aids to the establishment of theories—the usual view—as essential parts of the theories. The theories are systematic expressions of analogies. Here, we think, he will not only interest all physicists, but also carry them with him. On the other hand, his discussion of such points as how we can define, say, silver, and his conclusion that all logical difficulties can be avoided by stating “silver exists,” will not, possibly, appeal to the experimenter. The experimenter has never felt the need of a formal definition of his materials; Dr. Campbell agrees, but labours the point at considerable length, whereas the question of modern conceptions of isomers and isotopes, which will bear much discussion, receives little attention.

The book before us (the preface informs us that further volumes have been contemplated) is divided into two parts, one dealing with the propositions of science, and the other with measurement. The first consists in the main of a discussion of the nature of laws, hypotheses, and theories, of what is meant in physics by these terms, and of the possibility of obtaining more or less formal definitions of them. Dr. Campbell's debating often tends to show the difficulty of arriving at conclusions rather than to lead us to convincing conclusions—a fact attributable to the difficulty of the subject. For instance, he suggests that the decision as to whether a given proposition is or is not a law has to be left to the judgment of serious students of science—which is sound, but not sensational. Throughout the book the word “important” plays a large part, and obviously to reduce a question to terms of relative importance is to raise fresh points. The discussion of

theories, comparing as it does, in particular, the services of mechanical and mathematical theories, is of great interest. The aspect of a theory brought out so strongly by Mendeléeff's words, "By a theory I mean a conclusion drawn from the accumulated facts we now possess which enables us to foresee new facts which we do not yet know," might, perhaps, have been more emphasised.

Of Mill's canons of induction our author disposes in a very workmanlike manner. The chapter on chance and probability seems to us to contain some very sound and valuable remarks on the fundamental assumptions of this difficult study. An example in this chapter has already drawn down the wrath of an eminent mathematician; this example, which deals with the drawing of a given ace from a piquet and a whist pack side by side, at first sight appears to be made the ground of a somewhat perverse comment on ordinary reasoning, since it is admitted that the ordinary estimate of the probability is "right"; but actually it leads up to a point of some importance. The usual assumption is that the choice of either pack in the first instance is equally probable; but this does not follow from first principles unless further conditions as to blindfolding, and so on, are introduced. Actually, the chooser might well be considerably influenced in his choice by the relative size of the packs; and what is really the probability of drawing a given ace is a matter for experiment under conditions rigorously specified. The point brought out, though perhaps not that on which most stress is laid, is that the given conditions are often not stated precisely enough in problems of this nature.

The discussion on probability is continued in the second part, where the subject of errors of measurement is investigated. The criticism here is searching, but is not likely to be accepted in its entirety without debate: the suggestion that the physicist will more frequently find distributions in his notebooks which give a curve like the letter "A" with its top removed than a Gaussian curve will scarcely be accepted. No doubt his arguments will receive more detailed consideration from the experts than is possible here.

The chapter on units and dimensions deserves particular attention. It contains valuable observations on no-dimensional magnitudes and formal constants, as well as some startling suggestions, including what seems to be an implication that the arrangement of the terms in a dimensional equation is of importance.

Dr. Campbell writes with enthusiasm and seeks the combat where it is thickest. The chief fault of his style arises from a desire to deal with

every possible comment that might be raised and hence to labour points which are sufficiently obvious. There is a certain lack of co-ordination, which he acknowledges; in fact, one of the things which render it an ungracious task to criticise is that the author is keenly alive to deficiencies in the book, and is always anxious to point them out himself. The work gives the impression of brilliant and informed table-talk on the basis of physics carried on evening after evening, the amount of thought devoted to any particular point depending largely on the mood of the moment. There is little doubt that most readers will find Dr. Campbell provocative in parts, but, whatever else he may provoke, he provokes thought. Finally, it is a great feat to have assembled so much interesting matter, and to have put together a book containing so much fresh thought on a subject of fundamental interest. It is to be hoped that the interest taken in this book will prove amply sufficient to encourage the author to bring out the contemplated remainder of the treatise.

E. N. DA C. ANDRADE.

Mind and Brain.

In Search of the Soul and the Mechanism of Thought, Emotion, and Conduct. By Dr. B. Hollander. Vol. i.: *The History of Philosophy and Science from Ancient Times to the Present Day.* Pp. x+516. Vol. ii.: *The Origin of the Mental Capacities and Dispositions of Man and their Normal, Abnormal, and Supernormal Manifestations.* Pp. vii+361. (London: Kegan Paul, Trench, Trubner, and Co., Ltd.; New York: E. P. Dutton and Co., n.d.) 2l. 2s. net two vols.

THAT the psychological phenomena loosely grouped together under the term "mind" are in some way correlated with the physiological activities of the brain is a proposition which may be regarded as having been generally accepted for more than a century past; the question, however, as to what is the nature of that correlation still remains unsolved. The fact that this particular question must be allowed to lie in abeyance does not militate against the very legitimate attempt to locate differentiated mental functions in relation to the various structural parts of the brain, and as a matter of course many observers have sought to produce a psycho-physiology of the brain.

The human brain is chiefly remarkable, from the point of view of comparative anatomy, for the extraordinary development of the cerebral hemispheres, which conceal practically all the other portions of the brain. They constitute virtually a great pall consisting of a grey surface or cortex, composed of many layers of innumerable nerve-

cells, and a white medulla or stalk, composed of millions of nerve-fibres which connect the cortical cells with one another, with other structures in the brain, and with the body tissues generally. Conceive this mantle with a surface divided up by a very constant pattern of grooves and elevations the marvellously complex and unique structure of which had just come to light; then, bearing in mind the "faculty" psychology which was generally held a century ago, it is easy to comprehend the high hopes entertained and the attempts that were made to parcel out the faculties on to the surface so naturally prepared. From these attempts to localise the higher mental functions before the nature of cerebral physiology was at all understood arose the cult of phrenology and all the charlatanism to which it gave rise.

To the serious student, phrenology, the lore of telling the character from the prominences of the skull, became quickly discredited because it was obvious that, as the thickness of the skull bones varied irregularly, the external configuration of the skull bore no definite relation to the surface of the brain underneath. This circumstance did not interfere with the followers of the mental localisation theory, but they themselves soon began to experience difficulties of their own. To obtain any agreement on the matter of localisation, it was first of all necessary that each observer should hold precisely the same views as to the division of the mind into faculties, and this essential preliminary gave rise to much difficulty, because very few persons were agreed on the subject. Many schemes were propounded and much argument took place until it was seen that, from the purely psychological point of view, the "faculty" conception of psychology was untenable. From regarding, for instance, the quality of aggressiveness as a separate entity, the opinion was formed that it was a trend of the personality as a whole. Moreover, the independent experiments of the physiologists and the observations of the neurologists began to take definite shape, quite apart from the speculations of the philosophical psychologists.

A great deal of knowledge has now accumulated, and modern opinion, which is supported by the vast amount of detail derived from the many cases of head injury in the war, is very definitely against any possible cortical localisation of separate mental faculties. The modern theory is embraced by the broad statement that the cortex is to be considered as a vast associational mechanism functioning as a whole, the chief purpose of which is one of inhibition of the lower activities of the nervous system; in other words, it is the mechanism whereby a considered intellectual activity is

substituted for an emotional reflexive type of reaction to environment. The cortex contains the termini of the various sensory streams of nerve-fibres arising in all parts of the body, and also the origin of the motor nerve-fibres going out to the muscles of the body. Apart from these connections, which have now been mapped with fair accuracy and are termed the sensory and motor areas respectively, there is no question of there being any real mental localisation. If the cortex be injured outside one of these areas, the individual becomes generally irritable or lacks control, and at the same time loses to a certain extent the capacity for intellectual thought.

Dr. Hollander, so one gathers from his book, does not agree with modern opinions. He prefers to stand by the old "faculty" psychology and the corresponding physiological ideas, and he has produced a monumental work in support of his views. In the very interesting first volume of his book he takes the reader right from the beginning of recorded philosophical speculation up to present-day knowledge of the mind and brain, extracts being given from and personal references made to practically every writer on the subjects under discussion. This mass of information, collated with a care that the reader will appreciate, must have involved a tremendous literary research and labour. It is only marred by the fact that the author stresses or belittles the facts to so great an extent in the effort to establish his point. His defence of the physiologist Gall, who was one of the first to take up the matter of cerebral localisation, is masterly; so much so that one sighs that such energy, ingenuity, and thought should have been expended in the resuscitation of a bygone stage of knowledge when there is so much new ground to be explored.

The second volume is disappointing. Here we have Dr. Hollander's views on many things; too many things really to be included within the same cover. A considerable portion of this volume is devoted to the development of his argument on behalf of the cerebral localisation of mental function, and to this end he lays down his psychology, which is of the faculty type and singularly lacking in reference to the most recent developments; e.g. there is no mention of such illuminating conceptions as that of the defence mechanisms or of the influence of the sympathetic and endocrine systems upon the mind. His treatment of the question of insanity is in the style of a very commonplace abridged text-book, not at all what one would have expected in a book of this kind; while some of his statements, though they may safely be left to the judgment of the

professional reader, require a little criticism for the benefit of the layman in these matters.

Dr. Hollander, like all enthusiasts, is inclined to lay the onus of failure of vision on those who do not agree with him. He disposes of his opponents on the ground that they do not follow out his system; but he must realise that some of the greatest intellects in science have been busy on these problems, and that they cannot all be wrong and only he be right. He must give a little credit to the labours of such men as Sir Frederick Mott, Sir Victor Horsley, and many others one might mention. Again, the difficulty the physicians of our mental hospitals have to face is not the fact that they are not allowed to fulfil their duty—they have every opportunity to do that in the very efficient and well-equipped modern mental hospital—but the attitude of the friends and relatives of the mental patient who, for sentimental reasons, oppose any effort to place the patient under proper care in the early stages of the disorder. As regards the question of treatment, of course everyone is entitled to whatever opinion he chooses, but it may be as well to point out that the consensus of modern opinion is that the day has not yet dawned when mental disorder can be treated by the surgeon. In a few cases of very definite brain injury an operation might be considered, but, even so, it is often found that the patient's last state is no better than the first.

Space does not permit of any detailed criticism of the remaining chapters of the book; it must suffice to say that the author passes on from criminology to thought reading and allied subjects, and ends upon a metaphysical note. The book is well written and well arranged; every credit must be given for the truly immense labour involved in its compilation; but it is to be feared that it is too much out of joint with the times to exercise much effect on the opinion of the day on these matters.

Mineralogy for Students.

- (1) *Economic Mineralogy: A Practical Guide to the Study of Useful Minerals.* By T. Crook. Pp. xi+492. (London: Longmans, Green, and Co., 1921.) 25s. net.
- (2) *Mineralogy: An Introduction to the Study of Minerals and Crystals.* By Prof. E. H. Kraus and Dr. W. F. Hunt. Pp. xiv+561. (New York and London: McGraw-Hill Book Co., Inc., 1920.) 27s.

EACH of these books is intended both as a text-book for students and as a work of reference for practical men.

NO. 2699, VOL. 107]

(1) In Mr. Crook's case the reader has the advantage of his life-long employment on the economic investigation of minerals, while his experience as a lecturer enables him to appreciate the difficulties of the beginner. He carefully avoids unnecessary excursions into theoretical considerations, but his explanations, so far as they extend, are exceptionally clear and simple. He gives considerable attention to the optical examination of crystals, on account of its value in recognising minerals; and there is a helpful chapter on the use of the blowpipe and chemical methods generally. Another chapter is concerned with the physical analysis of crushed rocks and loose detrital sediments, a subject that the author has made peculiarly his own; and the short account of the geology of mineral deposits should be of use to the prospector.

The greater portion of the book is, however, devoted to a detailed description of the minerals of practical importance. The arrangement and treatment are frankly based on economic considerations, which should be a recommendation to all who are engaged in the commercial development of mineral resources. Moreover, Mr. Crook does not confine his attention to minerals in the strictly scientific meaning of the word, but includes all that is covered by the legal and technical definition of the term—everything which is mined for its economic value—so that coal, asphalt, and petroleum find their place in his survey. He also deals briefly with building materials and road metal. The volume concludes with some useful determinative tables, which are set out in such a manner that it is possible to glance rapidly through them in search of the information required. The text is illustrated by clear diagrams, and by excellent photographs of minerals taken by the author himself.

(2) Prof. Kraus and Dr. Hunt present us with a treatise of a somewhat more elaborate character, largely compiled from previous publications of one or both of the authors. Considerable attention is devoted to crystallography, and there are detailed tables for determining minerals. In the general description of the commoner minerals they are arranged according to the usual chemical classification, but there is a separate chapter on gem-stones, and another in which the minerals are classified according to the elements to which they owe their economic value. Monazite, however, appears in this section under cerium, which, although present in considerable amount, is of little commercial importance, instead of under thorium, for which it is almost exclusively worked. The use of tetra- (instead of tetarto-) in referring to a quarter-pyramid in the triclinic

system should be corrected in another edition, as should also a few misprints (especially on p. 319). These are, however, matters of minor importance.

Taken as a whole, the book appears to be carefully and attractively written, and is illustrated by photographs of both minerals and crystal models, though it is doubtful whether the latter are really more effective than the line drawings that accompany them. There are also photographs of distinguished mineralogists, past and present, but a *caveat* must be entered to the claim that Werner was the first to place mineralogy on a scientific basis. The credit of the foundation of the science must be shared by some of his predecessors, such as Cronstedt, as well as by contemporaries like Kirwan.

JOHN W. EVANS.

Our Bookshelf.

Elements of the Mathematical Theory of Electricity and Magnetism. By Sir J. J. Thomson. Fifth edition. Pp. viii+410. (Cambridge: At the University Press, 1921.) 30s. net.

EARLIER editions of this book were fully reviewed in NATURE, but the alterations and improvements in the present edition deserve special notice. One change—that in the treatment of hysteresis—makes the subject of energy dissipated in the magnetic field much clearer to the student. A piece of iron is put through a magnetic cycle and it is imagined as being displaced from one position in the field to another. The thing emphasised is the work done in effecting a displacement of a magnetic element in the field, which is $laI\delta H$, where H is the field intensity, I the intensity of magnetisation, and la the volume of the element. The former way of putting the matter puzzled the thoughtful student, while the thoughtless person accepted it without analysis of its meaning. It was said that “the diminution in the potential energy when the magnet moves into the stronger field is $laI\delta H$.” The change in potential energy was not this, but $la(I\delta H + H\delta I)$, and the thinker naturally wondered what had become of the term $laH\delta I$.

The most natural and convincing method of considering this matter is that due to the late Dr. John Hopkinson, and given when an attempt was made (not in this book) to demonstrate the hysteresis formula by juggling with the terms of the variation of a perfect differential. This method of Hopkinson's is to be found on p. 339. It considers the work thrown into the field from the battery when the magnetisation is changed by a magnetising current.

An interesting discussion of a gas the molecules of which are small magnets has also been added.

On the whole this edition of a sound and popular book is brought well up to date. All the alterations will be thoroughly appreciated by the

student except that in the price, which has made a prodigious leap. It is a difficult time, as everyone knows, but many a student who would have willingly added this book to his own little stock of standard works will have to content himself with borrowing it.

A. GRAY.

Metabolism and Growth from Birth to Puberty.

By F. G. Benedict and F. B. Talbot. (Publication No. 302.) Pp. vi+213. (Washington: The Carnegie Institution of Washington, 1921.)

BENEDICT and Talbot's work on the “Metabolism and Growth from Birth to Puberty” of children of both sexes aged from one week up to fifteen years is a continuation of that on new-born infants published six years ago. The children were all physiologically normal, and some of the data are from the same children at different ages. Measurements of the weight, height, pulse-rate, and body-temperature are recorded, as well as the basal metabolism figures—*i.e.* the heat evolved in twenty-four hours in the subject at quiet repose and in the post-absorptive condition. These conditions were not easy to attain in the case of infants; there was not usually quiet repose unless some food was in the alimentary tract, but occasionally measurements were made as long as nine hours after a meal. The data are thus rather above the real basal figures than below. The basal metabolism is referred to age, weight, height, and body surface in a series of curves. The body surface was calculated by the Du Bois formula from actual measurements. Weight and height run parallel with age, and the basal metabolism increased from approximately 150 to 1100 Calories. In comparison with body surface the basal metabolism rose rapidly during the first year; after this age there was a continual decrease. There was no marked difference between the sexes, but after reaching the weight of 11 kilograms boys had a slightly higher metabolism than girls. All the data for basal metabolism are lower than those recorded by previous investigators. The publication is a valuable contribution to physiological literature.

Chemistry. By G. H. J. Adlam. (“Science for All” Series.) Pp. x+238. (London: John Murray, 1921.) 3s. 6d. net.

THE book under notice is intended for a beginner who is “guided and inspired by a competent teacher.” Many recent discoveries are included and the material is, on the whole, presented in an accurate and readable form. Several minor errors are, however, noticeable. Glaziers' “diamonds” are not “splinters” (p. 110); oxygen is not used in determining the flash-point of an oil (p. 119); the experiment described on p. 157 seems unlikely to succeed; the recovery of sulphur from alkali-waste is not without value (p. 170); and the carbon arc is not used in the fixation of nitrogen (p. 184). The atomic theory is explained only at the end of the book, although the method of counting the α -particles expelled from radium is referred to on p. 10.

Letters to the Editor.

[The Editor does not hold himself responsible for opinions expressed by his correspondents. Neither can he undertake to return, or to correspond with the writers of, rejected manuscripts intended for this or any other part of NATURE. No notice is taken of anonymous communications.]

Radiation from the Carbon Arc.

AN application of Merton and Nicholson's form of the wedge method has been made to the study of the intensity distribution in typical stellar spectra. In the late type spectra (including the sun), which are sufficiently bright at the red end, the energy curves give a marked depression from $0.50\text{--}0.67\mu$ —a result not obtained by other observers. As the spectrum of the carbon arc, assumed to radiate as a black body at a temperature of 3750° Abs., is used to remove the colour curve of the plate, a possible cause of this depression, which is common to all stellar spectra that have been observed in the red, would lie in an intensity distribution in the carbon arc differing from that assumed.

In order to determine the intensity distribution in the spectrum of the positive crater of the carbon arc,

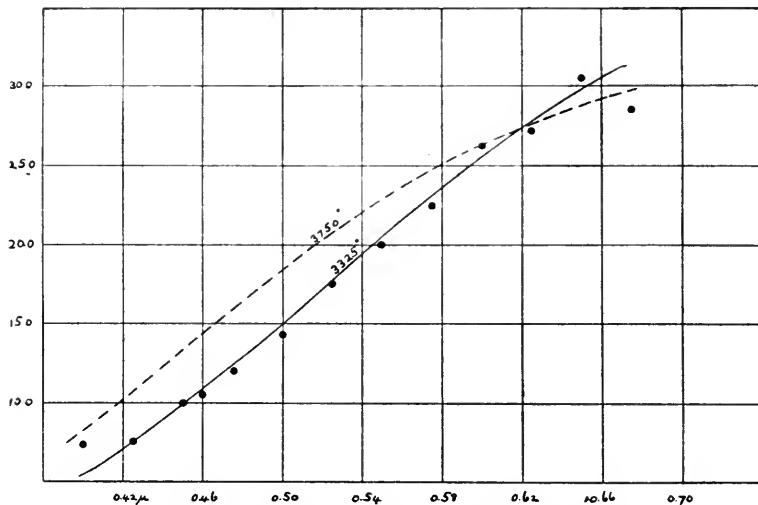

FIG. 1.—Intensity distribution in spectrum of positive crater carbon arc.

the acetylene flame was used as a standard. The intensity distribution in a cylindrical flame of specified dimensions burning acetylene generated from commercial calcium carbide has been carefully determined by Coblenz with the bolometer (Bureau of Standards, Scientific Papers No. 279, 1916, and No. 362, 1920). To reproduce as closely as possible the conditions employed by Coblenz, a burner was used giving a cylindrical flame of the specified dimensions, and the acetylene used was obtained from three different sources: two cylinders containing acetylene compressed in acetone and a simple gasometer which generated gas from commercial calcium carbide. From $0.40\text{--}0.60\mu$ the intensity distributions in the flames from these three sources were in good agreement. From $0.60\text{--}0.675\mu$ there were systematic differences with a range of 8 per cent., due probably to the varying quality of the acetylene. In this part of the spectrum mean intensities were used as giving the closest approximation to Coblenz's conditions. Some initial experimental difficulties were encountered owing to non-uniform illumination of the wedge by the flame which could not be detected by the usual methods. It was found that reversal of the wedge

on the slit furnished a very sensitive test of uniformity, and by the use of this method an arrangement of apparatus was secured which gave uniformity of illumination within the limits of the accidental errors of the wedge method.

When the initial difficulties had been overcome a series of eight spectra of the acetylene flame was obtained on Ilford panchromatic plates. At the same time five spectra of the positive crater of the carbon arc were secured, cored carbons being used with a current of 5.7 amperes. The heights of these wedge spectra were measured to two different densities at various wave-lengths by means of a simple form of microphotometer devised for that purpose. The two series of measures differed by less than 2 per cent. The final mean absolute intensities of the carbon arc for various wave-lengths are shown in Fig. 1 by black circles. The mean probable error of these intensities is 1.7 per cent., the mean probable error of a single plate being 5.7 per cent. These mean probable errors would be considerably reduced if the intensity at 0.675μ were not used, the intensity at this point being subject to large accidental errors on account of the rapidly changing colour-curve of the plate.

It will be noticed that the observed intensities depart considerably from the intensities computed on the assumption of black-body radiation at a temperature of 3750° Abs. (shown by the dotted curve). The use of the observed values of the intensity distribution gives results for stellar spectra more in accord with those obtained by previous observers. There is still outstanding, however, in the case of the sun a depression requiring further investigation.

Two hypotheses may be advanced to account for the observed intensity distribution:—

(1) The carbon arc radiates as a black body at a temperature of 3750° Abs., but there is an absorption band with its centre at 0.50μ , due possibly to the incandescent carbon particles in the arc flame. Coblenz has shown that at 2360° Abs. these carbon particles have an absorption band with centre at 0.60μ (Bureau of Standards, Scientific Paper No. 156, 1911). At the temperature of the arc flame this

absorption band would suffer a shift to the violet, bringing its centre approximately in the observed place. The advantage of this hypothesis is that it is in accord with previous determinations of the arc temperature by such various methods as (a) the calorimetric method used by Violle, (b) the wave-length of maximum energy used by Lummer and Pringsheim, (c) Féry's determination from the total radiation, and (d) various determinations by optical pyrometers using an approximately monochromatic band in the red. This hypothesis is represented graphically in Fig. 1 by the dotted curve showing the intensity distribution of a black body at 3750° Abs. computed from Wien's law, so as to bring it into approximate agreement with the observed values from $0.600\text{--}0.675\mu$.

(2) The carbon arc radiates as a black body at a temperature of 3325° Abs. This hypothesis is represented by the full curve in Fig. 1, which fits the observed values fairly well. It can be brought into accord with previous work only by supposing that the commercial cored carbons used burned at a lower temperature than those carbons used by other investigators. Wanner has found differences of 200° depending upon the carbons used.

It is evident, if the carbon arc is to be used as a standard of intensity distribution for photographic spectrophotometry—and it is a very convenient standard—that its intensity distribution should be very carefully determined against a laboratory black body.

H. H. PLASKETT.

Dominion Astrophysical Observatory,
Victoria, B.C., June 18.

The Discovery of Large Quartzite Implements of Rostro-carinate and Early Palæolithic Types in Uganda.

THROUGH the kindness of Mr. E. J. Wayland, of the Geological Department, Entebbe, Uganda, I have become acquainted with an important discovery, made

he puts forward. From the numerous drawings of implements which have been sent to me, I have selected five which, while being representative of the majority of the implements figured, will, I think, enable me to fulfil Mr. Wayland's request that I should demonstrate the relationship of the Uganda specimens to the sub-Crag rostro-carinates of East Anglia.

The implement illustrated in Figs. 2 and 2A is, without any question, similar to many which have been found in the sub-Crag detritus-bed, and exhibits the characteristics of a broad, low rostro-carinate of primitive form, in which the keel, or carina, does not extend far back towards the posterior region of the specimen (Fig. 2A), and the dorsal surface (Fig. 2)—is composed of unflaked "cortex." Figs. 3 and 3A illus-

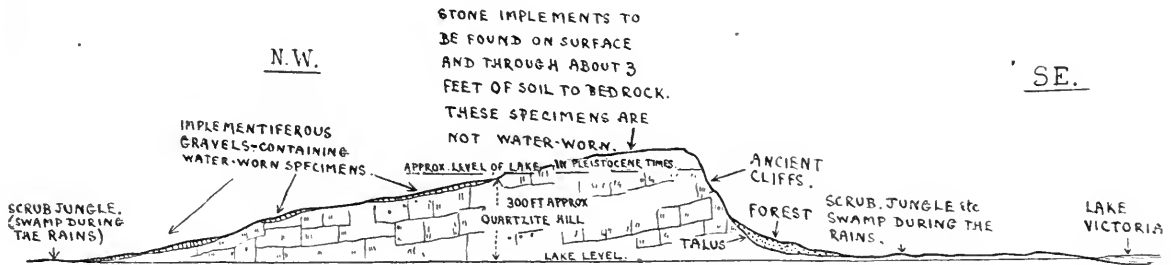
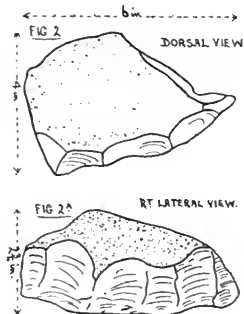

FIG. 1.—Rough diagrammatic sections (not drawn to scale) through Msozi Hill, Sango Bay, Buddu, Uganja.

by him in Uganda, of a considerable number of large quartzite implements of rostro-carinate and Early Palæolithic types. Mr. Wayland has asked me to publish my opinion of the cultural relationship of the specimens, of which he sends me drawings, to the beak-shaped implements found beneath the Red Crag of East Anglia, and I may say at once that there would seem to be little doubt that the latter, though possibly more ancient, are clearly "related" to the East African artefacts.

The exact localities where these new discoveries have been made are: (a) on the slopes and upon the summit of Msozi Hill, Sango Bay, Buddu, Uganda, and (b) at Kisiba, Tanganyika Territory. The accompanying diagrammatic cross-section (Fig. 1), copied from the drawing sent to me by Mr. Wayland, will make clear the positions in which the quartzite implements of Msozi Hill are found, and explain their discoverer's views as to the geological age of the specimens. As will be seen from an examination of Fig. 1, there are deposits of gravel on the slopes of Msozi Hill ("Quartzite Hill" of diagram) containing water-worn implements. On the summit of the hill, however, no gravel occurs, but Mr. Wayland finds upon the surface, and scattered through about 3 ft., of the soil, which there covers the bedrock, a number of specimens (of the same types as those found in the gravel) which are not water-worn. He observes, further, that the surface of Lake Victoria (shown to the right in Fig. 1) now rests at, approximately, 300 ft. lower than the level at which the unrolled implements occur, and he draws the conclusion that, when the people lived who fashioned the implements he has found, "Lake Victoria was 300 ft. above its present altitude, a state of things which, according to my showing, obtained during the Pleistocene Glacial period." It is thus clear that Mr. Wayland regards the quartzite specimens with which this letter deals as of considerable geological antiquity, a conclusion which, in my judgment, appears to be sound and in accord with the evidence

trate a massive specimen—weighing approximately 7 3/4 lb.—which is somewhat similar in form to the



FIGS. 2 and 2A.—Rostro-carinate implement in quartzite, from Uganda.

implement just described. As will be noticed, the more or less flat ventral surface, together with the

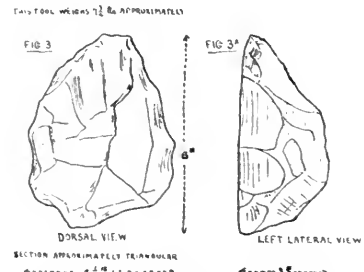

FIGS. 3 and 3A.—Massive quartzite implement from Uganda, of a form transitional between the rostro-carinate and the "batiform" Palæolithic specimens.

profile of the rostro-carinate form (Fig. 3A), is retained, but the dorsal surface (Fig. 3) is composed

almost entirely of flake-scars, while the keel, or carina, is not a very marked feature.

The implement illustrated in Figs. 4 and 4A is quite comparable, in its general outline and form, with that shown in Figs. 3 and 3A. Both these specimens, made from "chunks" of quartzite struck from still larger masses, are of great interest and importance as showing a transitional stage between the typical rostro-carinate form, with its prominent and functional keel, and the "batiform" Palæolithic implement, in which, while the simple triangular section is retained, the keel has become "depressed" and almost obliterated, thus ceasing to have any functional purpose. I have already described how, by the gradual "depression" of the carina, the rostro-

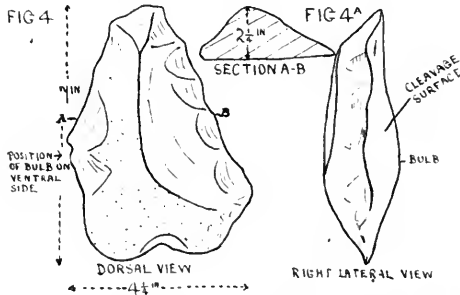

FIGS. 4 and 4A.—Massive quartzite implement from Uganda, of a form transitional between the rostro-carinate and the "batiform" Palæolithic specimens.

carinate developed into the "batiform" implement of Early Palæolithic times (Phil. Trans., series B, vol. ccix., 1920).

The specimen illustrated in Figs. 5 and 5A represents another form of the rostro-carinate, in which the keel extends continuously, and approximately, in the middle line, from the anterior to the posterior region of the dorsal surface. I have suggested in my Phil. Trans. paper that such specimens might have been used as "side-choppers," the more or less flat ventral area resting against the palm of the hand, while the prepared keel would be utilised as a cutting edge. It is, of course, possible that, in addition to such use, implements of the type shown in Figs. 5 and 5A might be used as picks. Figs. 6, 6A, and 6B illus-

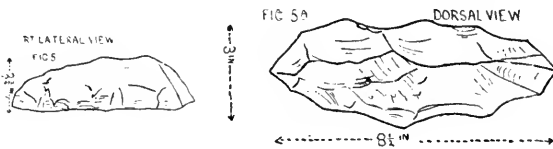

FIGS. 5 and 5A.—Quartzite implement of rostro-carinate form from Uganda, in which the keel extends over the whole length of the dorsal surface.

trate a specimen of well-known Early Palæolithic type, to which, at the suggestion of Sir Ray Lankester, I have given the descriptive name "plattiform." In this form of implement, in which the keel of the rostro-carinate becomes one of the cutting edges, while the more or less flat ventral surface is flaked away to form another cutting edge opposite to the keel (Phil. Trans., series B, vol. ccix., 1920), the method of manufacture is entirely different from that adopted in the making of a "batiform" implement. In the former the specimen is, as was pointed out by Sir Ray Lankester, so to speak, compressed from side to side, and the keel retained as a leading feature in its development, while in the latter the implement is, as it were, depressed—from above downwards—and the keel be-

comes functionless. The specimen illustrated (Figs. 6, 6A, and 6B) is of interest as showing, as do so many Early Chellean implements of similar form found in this country, the retention of portions of the original striking platforms (C and D in Figs. 6A and 6B), the dorsal and ventral surfaces of the ancestral rostro-carinate form.

From the above description it will be seen that I am of opinion that the specimens found by Mr. Wayland in Uganda are "related" to the rostro-carinate implements found beneath the Red Crag of East Anglia. It is clear, also, that the method of manufacture adopted in the case of these Uganda specimens is the same as was followed by the Early Chellean people living in this part of the world, and described by me in the Phil. Trans. paper quoted above.

The large collection made by Mr. Wayland in Uganda comprises certain well-made hand-axes, scrapers, and other forms of implements, of which, no doubt, a detailed description will appear in due course. But the majority of the relics found are, it seems, massive examples of Early Palæolithic artefacts, which appear to me to be very similar, in their forms, size, and technique, to those recently found by me at Cromer (NATURE, February 10, 1921). Mr. Wayland is to be warmly congratulated upon the

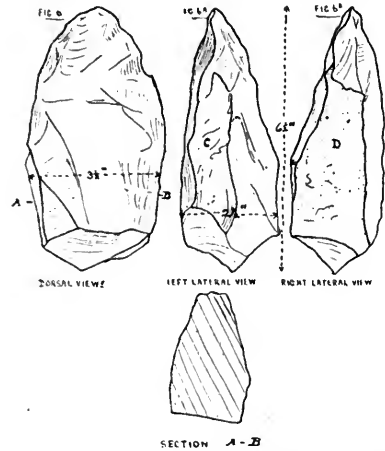

FIGS. 6, 6A, and 6B.—Quartzite implement of Early Palæolithic "plattiform" type from Uganda, showing portions of the original striking platforms retained (C and D in Figs. 6A and 6B).

important discovery he has made, which throws a new and welcome light upon the antiquity of man in Uganda. The outlines of the implements figured are not drawn to any special scale, but the approximate dimensions are indicated by the side of each drawing.

J. REID MOIR.

One House, Ipswich.

Measuring with High Powers of the Microscope.

UNDER a high power it is extremely troublesome to move the object so that one of its boundaries coincides exactly with a division of the micrometer-scale. But when the object is small this very greatly increases the accuracy; otherwise two estimated fractions of a division may constitute the greater part of the length measured.

Coincidence may be effected easily and with great exactness by gentle lateral pressure from the tip of the finger on the tube of the microscope; in this way the boundary of a well-defined image can easily be made to bisect a black line on the micrometer. If a

micrometer with lines 60μ apart be used over a 2-mm. objective with No. 8 eyepiece, each division represents 0.7μ , and a fifth part of a division corresponds to only $1/175,000$ th of an inch on the slide, which is therefore at the tube's centre the extent of the necessary distortion for bracket and bearing. The original position is recovered completely when pressure is removed. Probably everyone who uses high powers of wide angle has acquired the habit of effecting similarly extremely fine adjustments of focus by pressure on the stage.

With a lower power it is often helpful to press slightly on the nosepiece instead of moving the slide. For quick, rough measurements in the course of other work Prof. Dixon's "ghost micrometer" is very valuable (my friend Dr. W. R. G. Atkins introduced me to it). When the light is taken from a window the image of a piece of wire-gauze leaning against the pane can be brought on the object by a turn of the mirror, and removed again without losing sight of the object.

It may be worth adding that in measuring a distance in the line of sight (thickness) by the scale on the fine adjustment, one notch of the milling on the fine-adjustment head corresponds in my Zeiss to $1/10$ th of a division, or to 1μ (1.5μ with a dry objective). The notches can be read opposite the pointer through a lens, with a probable total error of 0.4μ for the single measurement of thickness.

In measuring the width or thickness of a calcite spicule the optic axis of which is parallel to the plane of the slide, or in examining an object above or below the spicule, greater accuracy can be obtained by placing on the ocular a Nicol with the plane of polarisation at right angles to the optic axis of the spicule, so that the high refraction of the ordinary ray is abolished. Ebner (*S. B. Ak. Wiss.*, Vienna, vol. xcv., p. 73) recommended to spongologists the use of the single Nicol for determining the direction of the optic axis of spicules.

Interference-colours between Nicols.—The measurement of thickness in these sponge-spicules is very difficult, and I hope to substitute for it the mere reading of the spicule's colour between Nicols. Empirically, the colour of all but the two "limbs" of the cylinder appears to be closely that of a calcite plate of equal thickness, and to be irrespective of the angular aperture of the objective (0.20 to 1.40) and of the presence or absence of an Abbe condenser between the polariser and the object. These are, to me, unexpected results in view of the much longer path in the spicule taken by the ordinary ray as compared with the almost unrefracted extraordinary ray. As it is difficult to exclude a 5 per cent. error from determinations of either the thickness or the retardation, and as it has been disputed whether the carbonate of lime in a spicule be wholly calcite, I shall be very grateful if a physicist will supply the theory of the colour of a cylinder (elliptical or circular) of calcite in Canada balsam. The diameter of the cylinder ranges upwards from a wavelength of light to 10μ or so; the lowest Δ I have determined accurately is $134 \pm 4\mu$ for the middle band of a spicule, which is a right cylinder since its optic axis is parallel to its length, and the width of which is $830 \pm 40\mu$.

GEO. P. BIDDER.

Cambridge, July 10.

Ocean Tides.

IN the letter in NATURE of May 26 (p. 393) under the above heading, by Mr. H. A. Marmer, of the U.S. Coast and Geodetic Survey, it is pointed out that tidal observations would be greatly enhanced in value if permanent bench-marks were established in connection

with them, not only for the correlation of any future tidal observations at the same places, but also for the determination of the rate of elevation or subsidence of the land relatively to the sea.

It may be of interest to note that this question was taken up some fifteen years ago by the Academy of Sciences of Paris, when a prize was offered for the best determinations of mean sea-level from tidal observations in any country bordering on the North Atlantic as a basis for such relative change in elevation on its coast-line. This prize was awarded to the present writer as superintendent of the Survey of Tides and Currents in Canada, as it was found that we had already tidal data available for this purpose, because referred to permanent bench-marks, on an extent of eight degrees of latitude from southern Nova Scotia to Belle Isle Strait.

Although this survey was primarily organised in the interests of navigation, its practice of establishing local bench-marks from the outset in 1894 is also bearing fruit in other directions. It has afforded to the Geodetic Survey of Canada, more recently organised, determinations of mean sea-level on both Atlantic and Pacific coasts as a basis ready to hand for extended levelling throughout Canada. Our Geological Survey also refers its contoured maps to mean sea-level, and in several regions it has been possible to give that survey an independent starting-point for these contours from tidal observations already obtained at a locality in the region, as they were referred to a local bench-mark.

As it is not often that the same superintendent remains in charge of a survey for so long as twenty-seven years, it may be allowable to give these examples in our experience of the advantages of the practice recommended by Mr. Marmer, which may accrue years afterwards.

W. BELL DAWSON.

Ottawa, Canada, June 22.

American and British Superannuation Systems.

THE writer of the leading article on this subject in NATURE of June 30 may have misled your readers by the last paragraph but one in his article, because:—

(1) No money can go into the pockets of shareholders of mutual insurance companies; there are no shareholders.

(2) If an endowment assurance is taken under the Federated System the benefits are increased by the share of profits, which, in the case of a mutual company, means a full share of all profits made.

(3) The expenses of the selected insurance companies are probably little more than those necessitated by a separate "association" when we bear in mind that the premiums charged under the Federated System allow for the saving of "commission to agents" by those offices that usually employ agents.

(4) The Federated System obtains the advantage of the experience of insurance companies in investing money expeditiously on a large scale.

The objection quoted as having been made by Mr. Fisher on the second reading of the School Teachers (Superannuation) Bill, 1918, to the effect that public money would go in "dividends to the shareholders" is met by (1) and (2) above. The real difficulty of placing his pension arrangements in the hands of insurance companies is that they cannot assess the invalidity risk or the future salaries on which the pensions in the Bill depend. The invalidity risk, the future salary scale, and the longevity of pensioners have necessitated far heavier contributions to pension funds than had been expected when the funds were started, and the difficulty of keeping private pension funds in a solvent condition is so well known

to actuaries who have practical experience of them that the writer of the article may have thought it too obvious for reference. It is, however, an important aspect of the problem of providing pensions which ought not to be overlooked.

W. PALIN ELDERTON.

Mansion House Street, E.C.2, July 4.

[THE insurance companies selected by the council of the Federated Superannuation System are not all mutual companies, and, in consequence, there are shareholders and dividends to be taken into account. Apart from this, even among mutual companies such matters as directors' fees, palatial buildings, and highly paid officials are not unknown, not to speak of expenses, often heavy, of advertising. If Mr. Elderton wishes to maintain the position that insurance companies are purely philanthropic institutions, we fear he has taken on an impossible task.—ED.]

Cup and Ring Markings.

MAY I query Mr. Carus-Wilson's opinions in his letter in NATURE of June 23 (p. 523)? I have, alas! seen only one case (at Ilkley) of these markings, but have long been interested in the peculiar weathering of mortar which is common on the north side of old buildings near the sea. My view is that it is quite distinct from the cup and rings. The change in mortar is, I suspect, one of adsorptive precipitation, so well explained by Mr. S. C. Bradford in NATURE of March 23, 1916, and elsewhere.

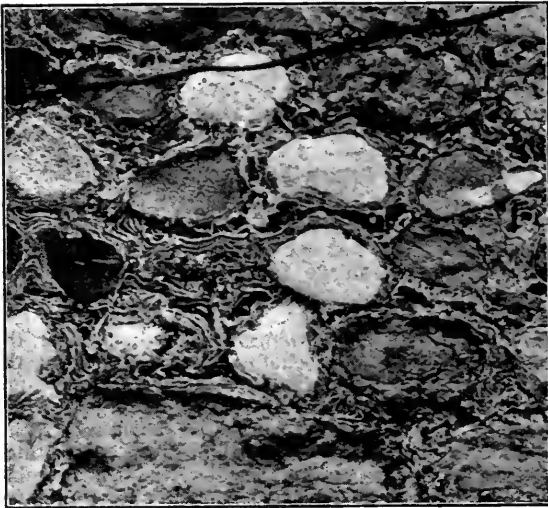

FIG. 1.

After saturation by rain, when drying takes place the lime forms into parallel lines with intermediate spaces, and those sand-grains which are thus robbed of their cement are speedily removed by the wind. The accompanying photograph (Fig. 1) is of an old stable wall built of local sandstones and limestones at the Military Arms Inn, The Nothe, Weymouth, and was taken in 1904. The scale is 1/10. I presume the cracks, etc., in old oil paintings are also quite unlike either of the above.

GEORGE ABBOTT.

June 26.

A New Acoustical Phenomenon.

WITH regard to Dr. Erskine-Murray's observation of the behaviour of aeroplane sounds (NATURE, June 16, p. 490), attention may be directed to the

NO. 2699, VOL. 107]

fact that any combination of confused noises will behave in the same manner, such, for example, as the noise of rustling leaves, escaping steam, a shower of rain on trees or tin roofs, or of a distant train in motion. If one stoops towards the road or approaches a reflecting wall while any of these noises are going on, the pitch of the sound rises, and when one is in the act of standing up, or of withdrawing from the wall, it descends. The grating of carriage-wheels on the road, or rather the noises reflected downwards from the body of the carriage, have a like effect when the observer is standing perfectly still. In this case, however, for some reason not clear to the writer, careful listening shows that the pitch falls as the vehicle nears the observer, and rises as it recedes from him. If the sound is a single continuous note, such as that of a whistle blown by a bicyclist riding past the observer, beats are heard as the whistle advances and also as it recedes, these being due to interference between the direct sound-waves and those reflected from the road. The occurrence of beats in such circumstances is perhaps not generally recognised.

F. M. WEST.

11 Downshire Square, Reading, July 12.

Magnetism and Atomic Structure.

ON the cubical atom theory developed by Lewis and Langmuir it appears that the molecules of CO_2 and N_2O have almost identical electron configurations. A. O. Rankine has shown from viscosity data that each electron system is equivalent to that of three adjoining neon atoms in line. The writer is not aware that attention has been directed to the fact that the specific susceptibilities of gaseous CO_2 and N_2O are -0.423×10^{-6} and -0.429×10^{-6} (Také Soné, Science Reports, Tôhoku, vol. viii., p. 162, 1919, and Proc. Phys. and Math. Soc. Japan, vol. ii., p. 84, 1920) and their molecular susceptibilities -18.6×10^{-6} and -18.8×10^{-6} respectively.

The electron systems of the two molecules are apparently identical, but the net positive charges on the atomic nuclei are 8-6-8 for CO_2 and 7-8-7 for N_2O . If, therefore, atomic nuclei possess rotations and are a source of magnetic moment, it must be assumed that the redistribution of the positive charges in the manner indicated involves no change of angular momentum.

A. E. OXLEY.

Shirley Institute, Didsbury, Manchester,
July 14.

An Algebraical Identity.

WITH reference to the letters in NATURE of June 9 and July 7 by Dr. G. B. Mathews, Dr. H. C. Pocklington, and the Rev. J. Cullen on the polynomials $Y(x)$, $Z(x)$ satisfying the identity

$$Y(x)^2 - (-1)^{p-1} Z(x)^2 = 4(x^p - 1)/(x - 1),$$

may I point out that $Y(x)$, $Z(x)$ are tabulated as far as $p=101$ in Dr. Hermann Teege's inaugural dissertation, "Ueber die $\frac{1}{2}(p-1)$ gliedrigen Gaussischen Perioden" (Kiel, Peters, 1900)? Connected with these polynomials there is a further point which, so far as I am aware, has not yet been settled. When $x=1$ and $p \equiv 1 \pmod{4}$, $Y(x)=py$, $Z(x)=z$, and $py^2 - z^2 = 4$.

I have verified from Dr. Teege's results that (y, z) is the primitive solution of $pu^2 - v^2 = 4$, and consequently $\frac{1}{2}(z+y\sqrt{p})$ the primitive unit of the quadratic field $[\sqrt{p}]$ as far as $p=101$; but the question whether this unit is always primitive needs further investigation.

W. E. H. BERWICK.

The University, Leeds.

The Air and its Ways.¹

By SIR NAPIER SHAW, F.R.S.

THE physical problems of the weather map have not been solved, for the subject is inherently difficult. In the first place, the atmosphere is on such an immense scale that its behaviour is not to be brought under the principles of physics without much trouble, and, I may add, many mistakes. The most confident theories of the past are flatly contradicted by facts which have come to light since the investigation of the atmosphere was extended to the upper air by balloons, kites, kite-balloons, and more recently by airships and aeroplanes. We have now many facts about the atmosphere up to 20 kilometres at our disposal. They are, of course, not necessary for the formation of a correct theory, because no new principles are involved, but they are invaluable for the purpose of the verification or contradiction by which hypotheses get moulded into consistent theory.

The behaviour of air in bulk is so entirely different from that of the laboratory sample that the ways of the air are, indeed, as peculiar as those of "the heathen Chinese." The air as we know it in the laboratory is a very mobile fluid, yet in the atmosphere it manages to take on a sufficiency of the character of an elastic solid. It does not go in the way it is pushed; pushed north it goes east, and pushed east it goes south. The condition for getting it to go north is that it should be pushed west. If you blow a jet of air straight upward you may find that part of the effect is a vortex whirling around you. In front of its fire—the sun—the air will very likely get colder instead of warmer; losing heat by exposure to the clear sky on a cold night, it may get warmer. In spite of all that is taught in the laboratory about the levitating effect of warmth, cold air floats above us with warmer air beneath. If you tell the air that warm air rises, it winks an eye and interjects an "if" and a "when." If the Olympian gods felt cold and thought to make themselves warmer by stirring up their chilly air with the warmer air enjoyed by mortals down below them, they would be disappointed. Stirring would make them colder and us warmer. Shake air up violently, water falls out of it; and if the shaking went on long enough the air would become intolerably dry, very cold at the top and very warm at the bottom. Not only has the air the innate capacity for these conjuring tricks, but it never, or scarcely ever, fails to use them.

The General Problem of the Science of Meteorology.

Yet, underlying the work that is done in meteorology officially or unofficially, there is, and has been all the time, a definite purpose to bring our knowledge of the air into relation with the laws of physics as established in the laboratory,

and, therefore, particularly with the laws of energy.

The Fundamental Facts.

There are two sides to the study of the air and its ways which can be pursued by different people who may never meet each other. One is the observation and collection of the facts about the weather from every part of the world; the other is the interpretation of facts by dynamical and physical reasoning. Nothing—at least nothing useful—can be done without real facts; but real facts do not, as a rule, explain themselves. The composition of air at different levels has been computed, and the results for one hundred kilometres are different according to Humphreys, Wegener, and Chapman. Below the level of 20 km. we are not troubled with changes of composition except those in the amount of water-vapour. The meteorological facts may be expressed by maps showing coast lines and orographic features, surface-temperature in January and July and its discontinuities at the coast lines, water-vapour at the surface in July, cloud, rainfall over the land, winds over the sea, and pressure over the globe in the same month.

Winds and temperatures in the upper air can be illustrated by models in cardboard. That for temperature shows the general run of the isothermal surfaces and the modifications caused by the introduction of local cyclones and anticyclones.

The Atmosphere a Great Steam Engine.

We are all agreed that the atmosphere is in reality a great engine, partly an air engine, but more effectively a steam engine, or at least a moist-air engine. Now the essential parts of a steam engine are a boiler to supply it with heat, a condenser at a lower temperature to absorb the surplus heat, and a fly-wheel to maintain the continuity and uniformity of its action. We describe the action of the engine as taking a supply of heat from the boiler, giving out heat to the condenser, and converting into work, useful or otherwise, the difference between the heat taken in and that given out.

Can we rightly use such language about the atmosphere and usefully contemplate the ways of the air from that point of view? I think we can, though the analysis of the phenomena from that point of view is difficult. The boiler is certainly there; I have shown it to you in the distribution of temperature with the great warmth of the equatorial regions. In the map of the distribution of water-vapour I have shown you where the steam is raised. The condenser is there also, partly in the shape of the vast cooling surfaces of the high lands of the arctic and antarctic regions, and of snow-covered mountains generally; but perhaps more effectively in the upper air, particularly in the stratosphere, which at a temperature of

¹ Abridged from the Rede Lecture at Cambridge on June 9.

190a. to 240a. (*i.e.* from 60 to 150 Fahrenheit degrees below freezing point) is certainly cold enough for the purpose, and, for certain reasons which I will not now expound, must be regarded as an effective means of getting rid of heat by radiating it into space.

The Fly-wheel of the Atmospheric Engine.

And what of the fly-wheel and the work done by the engine? Surely the winds, whether of the general circulation or of the local circulation of cyclonic depressions, are a fair representation of the fly-wheel. At the risk of laying myself open to the unpardonable sin of punning, I will point out that the fly-wheel is of enormous importance to flying, because the flyer can either attach himself to it and be carried along with it, or he may have to labour to make headway against it. The choice of these alternatives depends upon the airman's knowledge of its habits and behaviour—of its ways, in fact. The constituent parts of the fly-wheel at any time are the natural air-ways of the world. It was by hanging on to one part of the fly-wheel in the fifteenth century that Columbus discovered America, and by the aid of another portion, just two years ago (June 14, 1919), Sir John Alcock crossed the Atlantic in 16½ hours, and on July 13 of the same year Air Commodore Maitland landed R.34 at Pulham after a journey from New York in 3 days and 3 hours. Its total energy is tremendous, of the order of 100 billion horse-power-hours.

The Polar and Equatorial Circulations in the Upper Air as Parts of the Fly-wheel.

One of the immediate results of the thermal operations is to maintain the great fly-wheel or to start new sections of it in the form of local cyclonic circulations. Omitting these for the moment, I want to put before you some information about that part of the fly-wheel which is expressed by the general circulation. We can do so by distinguishing and ultimately isolating those portions of the atmosphere which represent permanent parts of the general circulation. Our best method of procedure is by way of pressure. We can compute the distribution of pressure for successive levels and verify the computation by the occasional observations of pressure at the various points of observation. We can thence calculate winds to correspond therewith in accordance with the general principle of the relation of pressure to wind, to which reference has already been made, and which finds partial expression in Buys Ballot's law.

A glass model expresses the results most clearly. It is made to show simultaneously on concentric hemispherical glass shades maps of pressure for 2000, 6000, and 10,000 metres. They disclose an enormous body of air extending at the higher levels from the pole or thereabout to latitude 40°, with a protuberance to the equator in the lower levels of the monsoon region. The air circulates about the polar axis in curves not

exactly coincident with circles of latitude, but not very different therefrom. This mass of moving air constitutes a very considerable fly-wheel.

The maps also disclose a collection of anti-cyclonic circulations in the intertropical region lying between a stream of westward-moving air at the equator and a stream of eastward-moving air at about latitude 35°. Thus the margins of the anticyclones form a sort of chain-drive pulling the air from east to west on the equatorial side and pushing the polar circulation eastward. These vast local areas of high pressure are interesting in relation to the tracks of hurricanes, the normal path of which for this part of the year is marked thereon. The lines which separate the high-pressure areas are at the coast lines, and emphasise the meteorological importance of those lines; with one of them the hurricane track is evidently associated.

Local Cyclonic Circulations as Parts of the Fly-wheel.

Among the products of the working of the aerial engine we have included the energy of the circulation of local cyclonic depressions, whether they take the form of the hurricanes of tropical countries or of the milder depressions of our own latitudes. I anticipate no objection to the suggestion that these phenomena are part of the working of the general atmospheric engine; but there is so far no general agreement as to the precise way in which the engine operates to produce these results.

I have recently suggested that the development of a vortex of revolving fluid may be due to the "injector-effect," or, as I prefer to call it, the "eviction-effect," of rising air or falling rain or both combined, and I have put together an apparatus designed to test the effect of the various possible causes in producing a cyclonic vortex when the conditions of relative motion are favourable. I have come to the conclusion that the air is much more easily moved to take up cyclonic circulation than has hitherto been supposed, and, in fact, cyclonic circulation is the natural expression of a part of the kinetic energy of rising air or falling rain, requiring only favourable local conditions for its obvious manifestation. Perhaps I may add that on that ground a volcano in explosive eruption ought naturally to cause a local tornado. The energy of cyclonic motion can therefore be added to the other parts of the atmosphere's fly-wheel with some confidence that it is in accordance with natural fact.

An Indicator Diagram for the Atmospheric Engine.

If this view of the atmosphere is a reasonable one, then we ought to be able to refer the operations of the air to what Maxwell calls an *indicator diagram*, expressing by the area of a closed figure the work done by the air in the course of a cycle of operations represented by the outline of the figure. During the past forty years I have been

trying to get that diagram in continuation of the work that I used to do with a class at the Cavendish Laboratory, and now I believe I have succeeded, with the assistance of Mr. E. V. Newnham, of the Meteorological Office. The result is not exactly in the form which is familiar to readers of Maxwell, but in the form of an entropy-temperature diagram such as Sir Alfred Ewing uses in his work on the steam engine. With the diagram it ought to be possible to make a reasonable diagnosis of the ways by which air can ascend from the surface, and descend again to be prepared for a repetition of its cycle. We should then replace by reason the guesswork which has

hitherto done duty for it. Further, according to the diagram, the best which you can expect from the steam-laden air of the equatorial region, working between the surface and the stratosphere under favourable conditions, is a "brake-horse-power efficiency of 25 per cent." Operations conducted elsewhere will have less efficiency than that. On the whole, it is not very high, but the energy available as indicated by the equivalent of the amount of rain which falls is so enormous that there is no reason to doubt the capacity of the air as a steam engine to develop and maintain the effects which are included in all our varied experience of the air and its ways.

Congress of the Universities of the Empire.

THE second Congress of the Universities of the Empire, which met in Oxford on July 5-8, was as successful as the Congress of 1912. Higher tribute could not be paid to the skill of those who were responsible for its organisation. Thirty-seven overseas universities were represented by ninety-four delegates and twenty-two "representatives," of whom the very large majority had come to England for the express purpose of attending the Congress. The total number of members, including Oxford residents, was about 600. In the printed list we find amongst the delegates the chancellor of New Zealand, the ex-vice-chancellor of Calcutta; the presidents of Alberta, British Columbia, Dalhousie, McGill, Queen's, Kingston, Saskatchewan, and Toronto; the vice-presidents of Montreal and St. Francis Xavier; and the principals of the University Colleges of Pretoria and Johannesburg and of several Indian colleges. When the present cost of ocean travel is taken into consideration, these figures bear eloquent testimony to the belief of the universities of the Empire in their essential unity and to their faith in their common mission.

In one respect the Congress of 1921 far surpassed that of 1912 in attractiveness, and probably in value also. With the greatest generosity the members of the University of Oxford offered the hospitality of their colleges and their homes to all members of the Congress. The meeting together in common rooms and in the houses of their hosts gave great pleasure to the men and women who had come from the most distant parts of the King's Dominions. The opportunities thus afforded of intercourse and of informal discussion are likely to produce results more important in their bearing upon the practice of teaching and administration than the speeches made in the South Hall of the Examination Schools.

Opportunities of consultation and of the comparison of experience are being further enlarged by the application of a scheme of visits which was tried on a smaller scale and in a somewhat tentative way in 1912. For a month all delegates from overseas are the guests of the home

universities. Before Congress met they were given the choice of visiting Reading, Bristol and Cardiff, or Dublin and Belfast. Returning to London, as the guests of the University, they visited its schools and colleges on June 30 and July 1 and 2. On July 4 the Government entertained them, together with the delegates of the home universities, at a luncheon over which Mr. A. J. Balfour presided. On the following morning they travelled by special train to Oxford, where the congress was opened by the chancellor of the University, Lord Curzon. From Oxford the delegates from overseas proceeded to Cambridge and thence to either Edinburgh and St. Andrews, or Glasgow and Aberdeen. They will return in three parties *via* Durham, Newcastle, or Sheffield to Manchester or Liverpool, and will end their tour either in Birmingham or in Leeds.

As the proceedings of Congress have been reported in the daily Press, it will suffice here to mention only some points of special interest to men of science. As was fitting at a meeting in Oxford, the first session was devoted to the consideration of the balance of studies—the place of the humanities in the education of men of science, and of the physical and natural sciences in general education. Many wise things were said by the champions of a literary education. Prof. Desch and Prof. Whitehead spoke for those concerned with the education of students of science. Prof. Desch urged the necessity of including a large measure of humanistic instruction and study in the training of men of science, but proposed that it should take a novel form. In place of balancing the specialised courses in science by a certain number of equally specialised courses in the humanities, he would endeavour to bring the two into closer relationship by making the teaching of science historical, literary, and sociological. If scientifically trained men are to take their proper position in the community they must have "a vision of knowledge in its true proportions and perspective." "The most important safeguard against a limited vision is to be found in the historical spirit." Teachers should show to their students how their sciences grew, should

interest them in the lives of their founders and chief exponents, and, in favourable cases, in their original writings. In pure science the student should be shown how each discovery was related to the state of intellectual development at the time when it arose; in technology the opportunity should be taken of bringing discoveries and inventions into relation with the events of history and with the condition of society at different periods. The training of a scientific man could not, as a rule, include the study of dead languages; but modern scientific thought has its roots in ancient Greece.

Prof. Whitehead dealt with the preparation of schoolboys for scientific study at the university. "The main structure of successful education is formed out of the accurate accomplishment of a succession of detailed tasks." This must be ever kept in mind, since the enthusiasm of reformers so naturally dwells on "the rhetoric of education." The cynic is apt to proclaim that it does not make much difference what the detailed tasks may be; the one important thing is to get children into the habit of concentrating their thoughts and of doing what they are told. On the contrary, the wise selection of the detailed tasks is of prime importance. "Every subject in the preliminary training must be so conceived and shaped as yielding, during that period, general aptitude, general ideas, and knowledge of special facts, which, taken in conjunction, form a body of acquirement essential to educated people. Furthermore, it must be shown that the valuable part of that body of acquirement could not be more easily and quickly gained in some other way by some other combination of subjects." The hard element in a scientific curriculum consists in the attainment of exact knowledge based on first-hand observation. The soft element comprises two factors, of which the more important is browsing, with the very slightest external direction, and mainly dependent on the wayward impulses of a student's inward springs of interest. The second factor should consist of descriptive lectures, designed for the purpose of exciting general interest in the various sciences.

The afternoon session on July 6 was devoted to the consideration of "The Universities and Technological Education." Lord Crewe, the chairman, sounded the keynote of the discussion. No longer is it a question as to whether the universities should or should not provide training of the type defined as technological, but as to how far they should go in promoting studies which lead men and women on to employment in the fields of industry and commerce, or engage them in continued scientific research. "The universities exist because they satisfy the needs of the country—moral, intellectual, and practical—and the nature of the teaching they supply is conditioned by those needs. When, therefore, the conductors of an increasing number of industries assert that their methods depend for development and practical success upon scientific knowledge, and that it is only from the appropriate departments of different

universities that such knowledge is forthcoming at its best, the universities have no choice." Lord Crewe directed attention to the outstanding success of the schools of agriculture of the two ancient universities.

Sir Arthur Currie gave an account of the highly organised courses for engineers at McGill. These courses extend over four sessions, and include economics, finance, and industrial law. During the three intervening summers students obtain practical experience in works. In virtue of their superior education, they are fitted, when they go into the active practice of their profession, to rise to positions in which they will lead and direct. Advanced courses in which students are taught how to conduct investigations are also arranged, the Canadian Government providing forty-five scholarships for graduates who show aptitude for research.

In the course of an able paper Prof. Smithells said: "I have always thought that our difficulties with technology have arisen chiefly from the belated and stunted cultivation of natural science in the ancient universities." "If natural science as it arose had been gathered to the older studies and had flowed in its natural courses, the mechanical arts and those who follow them would surely have been brought long since into a very different relation with the academic world." "It would be excusable, perhaps, to make this the occasion to preach the urgency of technology. But that is not my intention; I am far more anxious to raise my voice against its unbridled pursuit, to direct attention to the restraints under which it should be fostered, and to plead for what seems indispensable to its worth." Of the Department of Scientific and Industrial Research his experience led him to say: "I hope I exhibit some capability of seeing what is good in this new State Department. Of what appears not good I will only say this, that there seems most room for anxiety in the creation of isolated institutes for technological research, which may detach from universities a most valuable type of studies and of men that will themselves suffer from their isolation."

Mr. J. C. Maxwell Garnett contended that "the provision of the highest technological education by universities, instead of by separate institutions, tends also to benefit the industries by harmonising the ideals and purposes of leaders of the people in many different walks of life, by widening the interests of the future captains of industry, and by accustoming them to an atmosphere of scientific inquiry, so that in due course they will encourage research, well understanding that research is something more than experimental tests—more even than attempts to discover immediate industrial applications of established facts."

Prof. W. W. Watts, after sketching the purpose of technological education and the aims of the universities and other institutions which set themselves to prepare men for industrial life, said: "The scheme of education that will be evolved . . . will not greatly differ in its method from the older

forms of literary or scientific learning, nor will its value be less as an instrument for equipping the intellect and training the mind." On the subject of touch with industry, he continued: "Until the student knows some of the features of the industry in which he will be engaged, he finds it difficult to realise the significance of many parts of his training. . . . In my opinion, the advantages of early touch outweigh its disadvantages." "The type of men which it should be the aim of the universities to turn out . . . must be willing to study all the conditions of their problems before they are sufficiently satisfied with their solutions to carry them into effect. These conditions require, not a solution, but the solution which can be brought into operation with the least possible disturbance of the things that are, without needless change of raw material, machinery, or *personnel*, but with the advantage of diminished cost, enlarged production, and increased value or efficiency."

Presiding over the morning session on July 8, which was devoted to the consideration of "The Universities and Research," Lord Robert Cecil spoke of his friendship with Lord Rayleigh and of his astonishment at the freshness with which he retained until the last days of his life his interest in the advance of knowledge.

After a paper by Sir Frederic Kenyon on humanistic research, and one by Prof. Firth on historical research and university teaching, Prof. Joly spoke on scientific research. He recalled

the fact that it was in Oxford that the Royal Society, the greatest of research societies, had its origin in the endeavours of such diverse spirits as Wilkins, Boyle, Wren, Seth Ward, and Wallis. "The argument for research in universities rests upon the broad basis of the value of the intellectual progress of mankind. I think I am correct in saying that most men who have adopted a life of research, or have made research the object of their special interest, have acquired their intellectual ideals in the days of their college life." If his teachers are without interest in research, the enthusiasm to create new knowledge is not implanted in the student. "Perhaps the most striking feature of American universities, as viewed by the British visitor, is the prevalence of research, and the lavish provision made for its prosecution. It extends into every branch of university work." "The American recognises to the full the value of the mental attitude induced by research, and this recognition is not confined to the university professor, from whom it may be expected, but extends, so far as I could gather, everywhere throughout the States."

The discussions of the Congress, which were carried on with great vigour, are likely to prove fruitful in the minds of those who heard them. The permanent, and perhaps more important, outcome will be the full Report of the Proceedings of the Congress, which will be published by Messrs. G. Bell and Sons in the autumn.

Gold Medal of the Royal Society of Medicine.

AWARD TO SIR ALMROTH WRIGHT.

AT the recent annual meeting of the fellows of the Royal Society of Medicine the president, Sir John Bland-Sutton, announced that the recently founded gold medal of the society had been awarded to Sir Almroth Wright in recognition of the value of his important contributions to medical science, and particularly of those made during the war. Unfortunately, Sir Almroth Wright, who had been compelled to go abroad, was unable to be present, but had written very cordially thanking the council of the society and expressing his great appreciation of the honour bestowed upon him. In his absence, the medal was handed to his brother, Dr. Hagberg Wright.

The council of the society was enabled to institute the gold medal by the generosity of the late Dr. Robert Murray Leslie, who transferred to the society investments in perpetual trust for the purpose. The trust deed provides that the medal is to be awarded every three years, and is hereafter to be presented on St. Luke's Day

(October 18) to a scientific worker, man or woman, who has made valuable contributions to the science and art of medicine. It was specially provided that the first award should, if possible, be made for original or other work in connection with military medicine and surgery



which had proved of value during the Great War.

The council of the society felt that for such an award an effort should be made to produce a medal which, in art and symbolism, should be worthy of the occasion, and upon the advice of Mr. G. F.

Hill, keeper of the medals in the British Museum, the work was entrusted to Mr. Carter Preston, who has produced the beautiful design shown in the accompanying reproductions of photographs.

The obverse shows Hygieia, daughter of

Æsculapius, placing a wreath upon a figure kneeling before her holding a lamp, signifying Research. The reverse shows the centaur Chiron instructing the young Æsculapius in the elements of medicine.

Obituary.

HENRY RONDEL LE SUEUR.

HENRY RONDEL LE SUEUR was born on January 1, 1872, the son of F. C. Le Sueur, of Trinity, Jersey. He attended a private school until 1887, and then for two years was in the laboratory of a Jersey analyst, Mr. F. W. Thoms. Thence in 1889 he proceeded to University College, London, taking the B.Sc. degree of the University of London (Honours in Chemistry) in 1893, and the D.Sc. degree in 1901.

Le Sueur's teaching experience was entirely connected with one institution—namely, the Medical School of St. Thomas's Hospital, where he was appointed demonstrator in 1894, and lecturer in 1904, a post which he was holding at the time of his death on July 9. There was but one break in his connection with the hospital—namely, that caused by the war. In July, 1915, he was commissioned major in the Royal Engineers, and ordered to Gallipoli to advise on chemical warfare problems, and the complaint which he contracted there was probably in no small degree responsible for his final illness. On his return to England he was one of those originally appointed to the Gas Warfare Experimental Station at Porton, Wilts., where he remained until the end of 1917, when he was ordered to the United States to assist in the preparation of the American Gas Warfare Experimental Station.

Le Sueur was one of the secretaries of the Chemical Society, and most of his original papers are to be found in the society's journal. He was a most capable experimenter, who found it necessary to satisfy himself on the minutest detail. This probably accounts for the fact that the number of his communications (twenty-four) was not large, but they are characterised by a thoroughness which can be rightly appreciated only by those who knew his methods of work. It was, however, as a teacher that Le Sueur shone as a particularly bright star. His capacity for imparting knowledge to others was most pronounced and quite exceptional, and among his students in the laboratory he was at his best.

Le Sueur's most marked characteristic as a man was his unfailing loyalty, whether the science of his adoption, to his colleagues and students, or to his friends. Certainly the island of Jersey never possessed a more loyal or truer son. His efforts to mask a natural shyness and reserve of manner did not always meet with the success which would allow strangers to recognise the true qualities of the man himself, but those who knew him intimately realise that by his untimely death

the science of chemistry has lost a devoted servant, and they have lost a true and loving friend.

A. C.

WE notice with much regret the announcement in the *British Medical Journal* for July 16 of the death of SIR GEORGE SAVAGE on July 5 at the age of seventy-eight years. Sir George was educated at Brighton and Guy's Hospital, where he won the treasurer's gold medal. He received the degree of M.D. (Lond.) in 1867, and in 1878 he was elected to a fellowship of the Royal College of Physicians. For seventeen years—from 1872 to 1889—he was connected with the Bethlem Royal Hospital, and it was during this period that his reputation as a psychiatrist was established. In 1886 he was president of the Medico-Psychological Association, and in succeeding years he presided over the Neurological Society and the section of psychiatry of the Royal Society of Medicine when this section was founded in 1912. In the same year he received his knighthood. For a number of years he was co-editor with Dr. D. Hack Tuke of the *Journal of Mental Science*. In 1907 he was elected Lumleian lecturer of the Royal College of Physicians, and two years later he became Harveian orator, taking as his subject experimental psychology and hypnotism. Sir George published one text-book, "Insanity and Allied Neuroses," which has become a standard work, in addition to numerous papers contributed to both English and American medical journals.

WE record with regret the death of SIR HERBERT BABINGTON ROWELL, which occurred suddenly on June 23. Sir Herbert, we learn from *Engineering* for July 1, was born in 1860, and finished his professional education at Glasgow University, where he studied naval architecture under Profs. Elgar and Jenkins. After experience with various shipbuilding firms, he became manager of the Hebburn shipyard of Messrs. R. and W. Hawthorn, Leslie, and Co., Ltd., and in 1916 became managing director of this firm. Sir Herbert was the first lecturer in naval architecture at Armstrong College, Newcastle. He was also a member of the council of the Institution of Naval Architects, and a member of the Institution of Civil Engineers. From 1912 to 1914 he was president of the Shipbuilding Employers' Federation, and from 1915 to 1917 president of the North-East Coast Institution of Engineers and Shipbuilders. In addition he was a member of Lloyd's Tech-

nical Committee, and filled many other public appointments. He received the honour of knighthood in 1918.

It is with great regret that we learn of the death of PROF. GABRIEL LIPPMANN, Foreign Member of the Royal Society, on July 14 on board the liner *La France* while on his way from Canada, where he had formed part of the French Mission under Marshal Fayolle. Prof. Lippmann was born in 1845 and educated in Paris. His work there was concerned mainly with the relation between electrical and capillary phenomena, the outcome of which was his capillary electrometer and other instruments. His process of colour photography, announced in 1891, is widely

known. In 1908 he was awarded the Nobel prize for physics, and in 1912 became president of the Paris Academy of Sciences.

WE announce with much regret the death, on June 1, at the age of seventy-nine years, of MR. CHARLES PICKERING BOWDITCH, associate of the Peabody Museum of American Archaeology and Ethnology, Cambridge, Mass. Mr. Bowditch was well known for his work on Mexican and Maya codices and inscriptions.

WE regret to announce the death of PROF. J. A. MENZIES, professor of physiology at Durham University School of Medicine, Newcastle-upon-Tyne.

Notes.

THE Civil List pensions granted during the year ended March 31, 1921, amounted to 1200*l.*, and include the following:—Mrs. Frederick Enock, in recognition of her husband's services to natural science and entomology (September 7, 1920), 100*l.*; Mr. Edward Greenly, in recognition of his services in the geological survey of Anglesey (September 7, 1920), 80*l.*; Mrs. J. A. McClelland, in recognition of her husband's distinguished services as an investigator in physical science (September 7, 1920), 100*l.*; Mrs. and Miss Sharman, in recognition of Mr. George Sharman's valuable services in palæontological science (September 7, 1920), 80*l.*; Mr. John Nugent Fitch, in recognition of his long services to the cause of botany, horticulture, and natural history (September 15, 1920), 75*l.*; Mr. W. R. Hodgkinson, in recognition of his valuable scientific work in the public service (March 24, 1921), 100*l.*; and Mr. Herbert Tomlinson, in recognition of his services as a teacher, and of his valuable and distinguished contributions to physical science (March 24, 1921), 100*l.*

THE popular fallacy that explosions can precipitate rainfall found expression in the question asked by Major Morrison-Bell in the House of Commons on July 13 as to whether the Government would be prepared to initiate experiments which might possibly have the result of precipitating a downpour of rain. The answer given was to the effect that from past experiments meteorologists were of opinion that explosions would not induce a fall of rain, and rightly so; for experiments were conducted on a vast scale, not, it is true, with that particular end in view, on the Western Front during the Great War. The collation of statistics of rainfall with the gunfire failed to show any certain connection. The only way in which the water-vapour in the atmosphere can be condensed into rainclouds is by cooling. Unless an explosion can produce a cold current, or cause to any appreciable extent such a disturbance in the atmosphere as will bring about the mixture of a stratum bearing a cold current with that carrying a warmer current, it cannot produce rain. The compression in the air produced by a bursting shell is propagated as

a sound-wave. The amplitude of the motion, therefore, diminishes as the square of the distance from the origin, so that at the distance of a quarter of a mile it would probably be no greater than 1/10,000th of an inch. In 1917 M. Angot, Director of the French Meteorological Office, showed that in the extreme case of two equal masses of saturated air, one at 0° C. and the other at 20° C., it would be necessary, in order to produce rain of even so small an amount as 1 mm. (0.04 in.), for the two masses rapidly and thoroughly to mix throughout an atmospheric layer of 6850 metres (about 4 miles) in thickness. Nor are dust particles and ions, which form the nuclei of raindrops, sufficient of themselves to cause precipitation unless there be a concomitant reduction of temperature.

By a resolution of the Swedish Riksdag passed on May 18 last, it has been decided to establish an institute for the investigation of the problems of racial biology. To Sweden, therefore, falls the honour of being the first country to establish a State-supported institute of this kind. The history of the movement which led up to this decision is related in a pamphlet, written in English, entitled "The Swedish State Institute for Race Biological Investigation," which has just been published by Dr. Hjalmar Anderson. The success of the movement has been due largely to the indefatigable exertions of one man, Dr. Herman Lundborg, who was the first to direct attention in Sweden to the national importance of the study of eugenics in a lecture which he delivered to the Upsala Physicians' Society in 1904. After much strenuous advocacy on the part of Dr. Lundborg and other prominent men of science, the question was brought to the notice of the Riksdag, and a report was called for. As a result of the opinions then expressed, the Government took up the matter, and Dr. B. Bergvist, the Minister of Education, drew up a recommendation, which received the Royal sanction, in which it was proposed to found an institute with an annual appropriation of 80,000 crowns. In the meantime Dr. Lundborg, with a self-sacrifice worthy of all praise, had rejected an alternative proposal to establish a

chair for him in Upsala University, on the ground that a subsidy granted to an individual gave no assurance for the continued study of the subject in the future. The Riksdag, therefore, although unable to adopt the full recommendation as to the appropriation in view of the present financial situation, decided, as already stated, to establish a State institute, of which Dr. Lundborg will be the director.

In a letter referring to the leading article on "Internationalism" in *NATURE* for July 7, p. 577, a correspondent writes to urge the necessity for a deeper and wider investigation of this complex question. In this connection attention may be directed to a little book recently published by Prof. H. J. Fleure, entitled "The Treaty Settlement of Europe" (Oxford University Press, 2s. 6d.), in which the author examines the provisions of the settlement from the ethnographic and geographical aspects. In his introductory chapter, after an admirable survey of the historical development of the conditions of life in Europe, Prof. Fleure points out that the treaties, using a framework which is largely linguistic, have attempted to apply to Europe the idea of the sovereign nation-State as it has arisen in the West; whereas, he holds, the coincidence of nation and State has been by no means close east of the Rhine. His chief and most weighty criticism of the treaties is that they tend to perpetuate conditions, and in particular the linear frontier, which have too often led to hostilities and disputes. He maintains that frontiers are really broad zones, and, further, that our politicians have failed to realise fully and to work out the implications of the fact that "in Europe we can only have unity in diversity." Prof. Fleure is perhaps inclined to attach too little weight to racial and nationalist feelings in the peoples of eastern Europe. The racial spirit of the Serb and the nationalism of the Greek are intense and deep-rooted, while in the more stolid Bulgar both sentiments are strong, if less demonstrative. Further east, in the Caucasus, which is beyond Prof. Fleure's province, in the case of the three republics which resulted from the Treaty of Brest-Litovsk, two, namely, Georgia and Erivan (Armenia), were the expression of a popular desire for a national existence which lent support to the political ambitions of their leaders.

In a letter to the *Times* of July 12 Mr. Robert Donald suggests that a corporation organised on commercial lines should be formed to conduct a general inter-Empire scheme for radio communication, the shareholders being the Governments of the States of the Empire, each represented in proportion to the capital it subscribes. The corporation should be directed by a small executive committee consisting of business men and engineers. The chain of radio stations could be built under contract, the corporation retaining ownership. The working of the system, however, should be leased to a company on attractive terms. In addition to directors appointed by the Governments, the British Radio Corporation should have on its board representatives of the Admiralty, War Office, Air Ministry, and Post Office. The advantages of this scheme are State ownership of an indispensable public service and private enterprise without mono-

polistic control. A company can also enter into international trade much more readily than can a union of States. The capital required for a few high-power stations with a working range of 6000 miles and low-power stations with a continuous working range of 2000 miles would not be great. The Compagnie Radio France has been constituted on somewhat similar lines. As the scheme is commercially feasible we hope that the Government will seriously consider it.

An interesting ceremony took place a few days ago at Lacock Abbey, near Bath, when, on behalf of Miss M. Talbot, a granddaughter of the late W. H. Fox Talbot and the present owner of Lacock Abbey, a large and historical collection of photographic apparatus was formally handed to Dr. G. H. Rodman, president of the Royal Photographic Society, for preservation in the society's museum at 35 Russell Square, W.C. It was Miss Talbot's desire that the collection should be placed in the care of the Royal Photographic Society, where it will be fittingly conserved with the important Hurter and Driffield collection and other photographic apparatus of national interest. The debt which modern photography owes to Fox Talbot, the brilliant scientific investigator, is not acknowledged so universally as it deserves, and although the credit for the discovery of photography may justly be attributed to the French pioneers, Niepce and Daguerre, Fox Talbot's discovery a short time afterwards revolutionised their process and made photography as it is practised to-day possible. The French process was completely different, and practically died out when wet plates were introduced. Fox Talbot was the first to produce positives from negatives, and as the inventor of the "Calotype" process he earned a title to undying fame. The collection of historical photographic apparatus which has now been entrusted to the care of the Royal Photographic Society includes a camera lucida, a sketching camera, and other scientific instruments which Fox Talbot used in his experiments, and will be specially shown during the approaching annual exhibition of the society, which will be opened to the public on September 19 next.

SOME urgent appeals on behalf of Russian men of science have been received recently in Finland, and the University of Helsingfors has appointed a committee, which is endeavouring to give much-needed assistance. The frontier between Finland and Russia having been partially reopened, some Finns have been able to visit Petrograd and verify the accounts received. Already several wagon-loads of foodstuffs have been dispatched for distribution in Petrograd among men of science and their families, but it is feared that the present grave food shortage in Russian towns will become more acute in the immediate future. Supplies will therefore be required for some months, and the committee fears that the resources of Finland may not be equal to the task. In consequence, an appeal for help in this work is made to men of science throughout the world, and the committee has offered to act as an intermediary in conveying supplies to their destination. Gifts of food, clothing, and books are urgently needed, and the com-

mittee at Helsingfors guarantees that all packages entrusted to its care, which should be addressed to Prof. Mikkola, University of Helsingfors, will be delivered to the men for whom they are intended.

A DISPATCH from Col. Howard-Bury, leader of the Mount Everest Expedition, published in the *Times*, describes the course of the party from Kampa Dzong to Tingri Dzong, where they arrived on June 23. The illness of Mr. H. Raeburn, following on the death of Dr. A. M. Kellas, is a blow to the expedition. Mr. Raeburn was sent back to Lachen, in Sikkim, where his speedy recovery is anticipated. The march westward from Kampa Dzong does not appear to have been difficult except at times for transport troubles. The inhabitants were generally helpful. Col. Bury describes the ascent of the easy Tinki Pass leading to the wide valley of the Yaru, a tributary of the Arun. After fording the Yaru some difficulty was experienced in crossing an area of quicksands during a violent sandstorm, but no accident occurred. At Tingri Dzong the expedition was within 50 miles of Mount Everest and on the verge of the real work of exploration.

At the annual autumn meeting of the Institute of Metals to be held in Birmingham on September 21-23, a number of papers dealing with the constitution and properties of metals and their alloys will be presented. The morning sessions will be devoted to the reading and discussion of papers, and the afternoon sessions will be spent in visits to works and factories of interest in the neighbourhood. The coming meeting will be the first visit paid by the institute to its old home, and the present membership of more than 1300 is significant of the great progress made by the institute since its foundation thirteen years ago, when its membership was 200. A ballot for the election of members desirous of attending the Birmingham meeting is being arranged, and full particulars can be obtained from the Secretary, 36 Victoria Street, London, S.W.1.

We have received from the National Council of Public Morals (Rhondda House, 60 Gower Street, W.C.1) a pamphlet entitled "To Save the British Race," in which an outline of the activities of the council is given. The Birth-Rate Commission, a Special Committee on Venereal Diseases, an Adolescent Inquiry, and an Education Committee in relation to the cinematograph are some of the inquiries undertaken by the council, and valuable reports have already been published respecting some of these.

An advisory body, the Scientific Research Committee, has recently been instituted by the Sudan Government for the collection and distribution of scientific information of local interest, which will be published in *Sudan Notes and Records*. In vol. iv., No. 1, of this publication Mr. R. E. Massey has a note on the maintenance of quality of cotton grown in the Sudan, showing that there has been no deterioration over a period of years; while Mr. H. H. King discusses means for the control of the Spanish sparrow, which has become a pest in Dongola Province.

M. V. GALIPPE, who is well known for his papers on micro-organisms, recently claimed (*Comptes rendus*, vol. clxxi., p. 754, October 18, 1920) that "microzymas et bacilles ovoïdes," endowed with movement, could be found in powdered fossils, even after treatment of the fragment used with a Bunsen flame and sterilised liquid reagents. No movement, however, was observed in ferruginous fossils. In co-operation with Mme. G. Souffland, M. Galippe now finds (*Comptes rendus*, vol. clxxii., p. 1252, May 17, 1921) that the same results may be obtained from meteorites and from a variety of igneous rocks, including those erupted by Mont Pelé. The authors are, of course, aware of the difficulties imported into their observations by the phenomenon of Brownian movement; but they state that their ovoid organisms move, while mineral particles of finer grain remain at rest. They believe that organic tissue and water are lost during fossilisation of the organisms, but that these are recovered during the experiments. The processes adopted will seem to most workers distinctly adverse to resurrection. The authors conclude that, if all living things were swept away from the surface of the earth, life would revive, thanks to the existence of the organisms entombed in every kind of rock. It is to be feared that few workers with the microscope will trouble to repeat these experiments, remembering Dr. Hann's observations on the structure of meteorites, and Mr. R. Kirkpatrick's more recent essay on "The Nummulosphere" (*NATURE*, vol. xci., p. 92, 1913); yet it is possible that the work of M. Galippe may lead to further study of Brownian movement among mineral particles.

THE results of investigations on the froghopper-blight of sugar-cane in Trinidad are given in a memoir of the Department of Agriculture of Trinidad and Tobago by Mr. C. B. Williams. The causative insect, *Tomaspis saccharina*, its life-history, and the nature of the damage done are described, and a section is devoted to the relation of the froghopper to its natural enemies. The sugar-cane is the second important agricultural crop in the island, and during 1917-18 it suffered a loss owing to blight of 300,000*l*. The causes accounting for the heavy outbreak of blight are due to a complicated interworking of many factors. The introduction of the mongoose to the island would not appear to be an important contributory cause. The preliminary conclusions arrived at open up a wide field of fundamental research on the relation between the outbreak of blight and rainfall, the geological contour of certain districts, soil conditions, temperature, rainfall, drainage, manurial treatment, tillage methods, and the relative resistance of varieties of sugar-canes. Direct control is also discussed. The author is to be congratulated on the way in which the results of his investigations are presented. It is highly desirable that sections of the report should be extended by further experimental research.

MEMOIR 122 of the Canadian Geological Survey has recently reached us, and it contains a comprehensive account of the Sheep River gas- and oil-field of Alberta, situated about 50 miles south of Calgary. Prior to 1915 a great deal of development work had

already been carried out by several companies, but owing to a variety of circumstances, largely influenced by the war, operations practically ceased in that year, though production has since been maintained intermittently by a few companies. The geology of the area is essentially Cretaceous, and the structures are typical of the eastern foothill ranges of the Rocky Mountains, consisting of sharp folds broken by powerful faulting consequent on long-continued earth stress. The main tectonic feature is that of the Turner Valley anticline, from which the bulk of the oil and gas has been obtained; this involves the Kootenay-Dakota, Benton, and Belly River series (in ascending order); petroliferous horizons are principally confined to the older rocks, four distinct oil-sands being recognised. Water-bearing beds were not penetrated by any of the wells put down, although two of these reached a depth of 3000 ft. The yield of gas is as much as 5,000,000 cub. ft. per day in some cases, while the best oil well (South Alberta Oil Co., No. 1) produces 30 barrels per day. The gas has an average composition of 70 per cent. of methane, the rest being ethane and nitrogen; the oil has a specific gravity of 0.736 (example from the second oil-sand), and is described as a high-grade oil; the yield of petrol, however, varies considerably. As a technical publication this memoir maintains the high standard of excellence characteristic of Canadian official literature.

METEOROLOGICAL results for 1920 at the Falmouth Observatory, a station which is financially assisted by the Meteorological Office, show that bright sunshine was registered for 1508 hours, or 245 hours fewer than the average for the past forty years. A deficiency of sunshine occurred in each month except December. Bright sunshine was registered on 308 days, a figure which is four days above the mean. The mean temperature for the year was 51.4° F., or 0.7° above the average. The absolute maximum for the year was 70.1° F. in August, which is the lowest annual maximum since observations were started fifty years ago. Rainfall was 2.08 in. above the average for the last fifty years. The relative distribution of the wind was in good agreement with the normal. A fifty years' average, 1871-1920, is given for atmospheric pressure, air temperature, rainfall, humidity, and direction of wind for each month and for the year; these add much to the valuable work which is being done at the station.

In the July issue of the *Philosophical Magazine* Mr. E. C. Kemble, of Harvard University, reviews the evidence now available for testing the various suggestions which have been made as to the constitution of the helium atom. Bohr's hypothesis that it contains two electrons revolving in a common circular orbit is not in keeping with the known value of the ionisation potential. The models of Landé and of Franck and Reiche involve an outer and an inner electron each with its own orbit. Such an outer electron would, on the theories of Langmuir and of Sir Joseph Thomson, determine the chemical behaviour of the atom, and it would be difficult to reconcile the chemical properties of helium with those of the alkali metals. These models also give wrong values for the ionisation potential, and

do not harmonise with the spectroscopic observations of Fricke and Lyman. In all the models the average angular momentum of an electron is taken to be an integral multiple of the unit, and, according to Bohr's principle, an electron on changing its orbit emits one or more units of radiation. Mr. Kemble shows that the principle cannot be applied in all cases without leading to inconsistencies, and comes to the conclusion that it must be abandoned.

In *Science* for May 20 Dr. S. J. Barnett, of the Terrestrial Magnetism Department of the Carnegie Institution, Washington, reviews recent progress in the theory of magnetism and its simplest applications. He shows how the Weber-Langevin theory, according to which the magnetic element contains a permanent whirl of electricity with a definite magnetic moment, is incapable of explaining the known facts of dia-, para-, and ferro-magnetism, and that the magnetic element, or magneton, must be taken as having an angular velocity of its own about some axis which may or may not be an axis of figure. In these circumstances the magneton will behave as a gyrostat, and a rotation impressed on the body of which the magneton forms part will tend to make the magneton set its axis more in the direction of that of rotation of the body, and thus impart to it a magnetisation along the axis of rotation. The gyrostatic magneton in the hands of Ganz and of Honda and Okuba has yielded results which follow very closely the experimental facts, the theory of Ganz covering a wide range of cases, and in particular reproducing accurately the behaviour of dense paramagnetic bodies at low temperatures.

SIR WILLIAM ABNEY'S career as a scientific photographer forms the subject of a memorial lecture delivered by Mr. Chapman Jones before the Royal Photographic Society, and published in the *Photographic Journal* for July. From his youth Sir William Abney had more than a liking for scientific subjects, but photography was his first choice. At that time the spectroscope was beginning to take its proper place as an instrument of investigation, and he was one of the first to enter this new field and to apply the spectroscope to the elucidation of photographic problems. He took advantage of the fact that the exposure effect in a chromated gelatine film, if merely started by light, will continue to grow, and showed how the bugbear of the carbon printers could be turned to useful account. In 1871, if not earlier, Abney devoted his attention to the preparation of photographic emulsions and sensitive films, and later on obtained results from which the modern P.O.P. originated. During about twenty-four years he investigated the nature of the developable image and the course of development. By 1880 he had worked out various methods for printing by development. He made a series of experiments on developing agents, and introduced the use of hydroquinone and the ferrous-citroxalate developer, which need no restrainer. One of Abney's most important discoveries he called "the failure of a photographic law." He proved that the time of exposure did not vary exactly inversely to the

intensity of light. It was not until 1893, after the subject had been considered for twenty-two years, that he gave details of his investigation of it. He made many successful experiments on photography in natural colours, but his greatest self-contained achievement was his photography of the infra-red. The normal spectrum as photographed on his plates was more than five times the length of the visible spectrum, for they were sensitive to the ultra-violet right away through the visible spectrum to a wave-length of 2200μ . Abney was accustomed to quantitative work from the first, and perhaps the most important service he rendered was the introduction of methods of measurement into scientific photography.

THE *Comptes rendus* of the Paris Academy of Sciences for June 20 contains a note by M. Baille-Barrelle on the production of coke from Sarre coal. By the usual method of coking, this coal is well known to give a poor coke, but M. Baille-Barrelle shows that, by a special mode of heating, Sarre coal can be made to yield a coke comparable with the finest cokes from Ruhr coal. The experiments were made on a semi-industrial scale (charge of 500 kg.), and preliminary work on the extension to a full commercial scale has been commenced. The coal is first maintained at a temperature of 320° C. for some time; then the tem-

perature is slowly raised uniformly to a final temperature of 750° C., or about 200° C. below the usual coking temperature. Figures for the resistance to crushing and shaking are given. It is also claimed that the by-products obtained are superior to those given by the ordinary coke oven, and an investigation into their nature is in progress. The yield of ammonia was unexpectedly high, about double that obtained when the coal is coked in the ordinary way; owing to the lower temperature a reduced quantity of ammonia was anticipated. It is probable that the actual quantity of ammonia produced was less, and that the increased yield was due to the lessened amount decomposed into nitrogen and hydrogen. If the process is successful on the large scale, the Lorraine iron industry will be freed from the necessity of using Ruhr coke.

THE National Physical Laboratory has issued a pamphlet dealing with "Tests on Volumetric Glassware Used in Dairy Chemistry," single copies of which may be obtained free of charge on application to the Director, Metrology (Glass Testing) Department, National Physical Laboratory, Teddington. The pamphlet contains specifications as to size and construction of butyrometers, test-bottles, and pipettes which can be accepted for test by the Laboratory.

Our Astronomical Column.

AURORÆ AT A HEIGHT OF 500 KM.—The careful auroral observations made in Norway and Sweden have established the remarkable fact that some of the streamers extend to the height of 500 km. above the earth's surface. This presumably implies that there is a certain amount of atmosphere at that height, which is a conclusion of cosmical importance.

Geofysiske Publikationer, vol. ii., No. 2, contains an investigation by Dr. Carl Størmer of the height of streamers during the brilliant aurora of March 22-23, 1920. There were seven photographic stations at work in Norway on this occasion, and telephonic communication enabled simultaneous exposures to be made, the cameras being directed to the same stars. The investigation is based on simultaneous photographs taken at Christiania and Kongsberg, which are 65.7 km. apart. The streamers photographed had well-defined edges, and crossed the constellation Cassiopeia, the brighter stars being visible on the plates. The heights of seven points in the streamers are determined as 597, 550, 607, 562, 528, 485, and 519 km. respectively. Two pairs of plates are reproduced, on which the streamers and the stars are clearly visible. The author notes that it is only the extremities of the long rays that attain these great heights. The bases may be as low as 85 to 90 km.

THE MINOR PLANET EROS.—This planet will make one of its near approaches to the earth early in 1931, when there will doubtless be another solar parallax campaign. A parallax still more accurate, however, than that obtained by direct measures will probably be determined by the very large perturbations produced by the earth on the planet's motion. For this purpose it is desirable to obtain accurate observations at every opposition. The planet will next be in opposition in mid-September in N. decl. 14° , magnitude about $10\frac{1}{2}$. Mr. F. E. Seagrave has computed an ephemeris for Greenwich midnight, a portion of which is given below. Corrections, due to G. Stracke,

of $-22s.$ and $-2' 7''$ have been applied to the right ascension and declination:—

		R.A.	N. Decl.	Log r	Log Δ
		h. m. s.			
July	23	23 41 24	6 58.1	0.23754	9.98409
	27	23 41 23	7 50.6	0.23600	9.96672
	31	23 40 42	8 41.8	0.23438	9.94938
Aug.	4	23 39 17	9 31.1	0.23266	9.93211
	8	23 37 6	10 18.1	0.23088	9.91512
	12	23 34 8	11 2.1	0.22900	9.89861
	16	23 30 22	11 43.0	0.22700	9.88265
	20	23 25 49	12 19.8	0.22494	9.86759

JUPITER'S FOUR GREAT SATELLITES.—The Annals of Leyden Observatory (vol. xii., parts 1 and 2) consist of researches on these satellites by Prof. W. de Sitter and Dr. A. J. Leekie respectively. These parts were published in 1918 and 1919; they are therefore quite independent of Prof. Sampson's theory, which only appeared in print in 1921. One point of Prof. de Sitter's method is the use of a new intermediary orbit; instead of using the Keplerian ellipse, he substitutes for the eccentricity the great periodic inequalities. This is analogous to the use by Drs. Hill and Brown of the variation oval as intermediary orbit in the lunar theory instead of the Keplerian ellipse.

Prof. de Sitter finds for the masses of the satellites in terms of that of Jupiter 3796, 2541, 8201, and 4523 (units of the 8th decimal). In terms of the moon's mass these are 0.985, 0.659, 2.128, and 1.173. Using the diameters of the satellites found by the interferometer (mean of Hamy's and Michelson's results), viz. $1.00''$, $0.905''$, $1.325''$, and $1.31''$ at distance 5 units, the densities become 0.853, 0.788, 0.811, and 0.462 in terms of that of the moon.

Prof. de Sitter's final values of the mean daily motions of I., II., and III. referred to First Point of Aries are 203.48899280° , 101.37476180° , and 50.31764630° . These have been adjusted to fit the relation $n_1 - 3n_2 + 2n_3 = 0$.

Quality of Protein in Nutrition.¹

By DR. R. H. A. PLIMMER.

THE normal diet of man and animals contains certain nutritional elements every one of which is essential for the maintenance of life and health. These elements are:

(1) Proteins, complex nitrogenous substances found in meat, milk, eggs, cereals, and plant tissues.

(2) Carbohydrates, such as starch in cereals, sugars in fruits, milk, etc.

(3) Fats, such as butter, lard, suet, and vegetable oils.

(4) Salts, or the mineral constituents in meat, milk, cereals, vegetables, etc.

(5) Vitamin A, contained in butter, cod-liver oil, eggs, green vegetables, etc.

(6) Vitamin B, contained in yeast, germ of cereals, meat, eggs, etc.

(7) Vitamin C, contained in some fruits and some vegetables.

(8) Water.

If we examine these food elements in fuller detail we find that in whatever form the carbohydrate is taken in the food it is converted during digestion in the body into a simple sugar, such as grape-sugar; so that for nutritional purposes all carbohydrates can be considered the same. They are burnt up like coal to supply the body with heat and energy.

Fat of almost every source consists mainly of three triglycerides, palmitin, olein, and stearin. The consistency of fats depends simply on the relative proportions of these substances. Certain fats are the vehicles of the A vitamin, but, leaving the vitamin out of consideration, fats are of equal value in nutrition, and, like carbohydrates, they supply fuel for heat and energy. Fats can be built up in the body from the carbohydrate in the food. Some very recent feeding experiments by Osborne and Mendel indicate that fat, as such, can be omitted from the diet if the vitamin A is supplied in a specially prepared form. The special value of fat in nutrition thus depends on the A vitamin associated with it, and not on its chemical constitution.

The mineral salts in an ordinary mixed diet do not need to be supplemented, but generally some sodium chloride is added. Animals on cereal diets must be supplied with this common salt.

Whatever is the source of the three vitamins, so far as we know the A vitamin is the same whether it be in butter or cod-liver oil, B vitamin is the same in yeast and cereal germ, and C vitamin the same in orange-juice or cabbage.

Thus, since each of these elements of the diet is reduced to a simple common basis during digestion, we cannot speak of quality of carbohydrate, fat, or vitamins.

The protein constituent differs from all the others by its endless variety. This is obvious to the naked eye. For instance, the protein in white of egg is in solution, and sets to a hard mass on boiling. Meat protein is already in a solid form. Milk contains two kinds of protein, the casein which is used to make cheese and an albumin like egg-albumin in the whey. The presence of protein in cereals is scarcely recognised, as it is obscured by the large amount of starch, yet about one-tenth of flour is protein; in fact, two very special proteins are present, the one soluble in alcohol, the other insoluble but soluble in dilute alkali.

¹ From a discourse delivered at the Royal Institution on Friday, April 8.

Our usual classification of proteins already indicates their differences, but the variety is really far greater. We need only refer to their chemical analysis. Fischer, Kossel, and their pupils have shown that proteins on hydrolysis break down into some eighteen or twenty amino-acids. These numerous units can be arranged for convenience into eight groups:

(1) *Simple Mono-amino-Acids*: Glycine, alanine, valine, leucine, and isoleucine

(2) *Mono-amino-Dibasic Acids*: Aspartic acid and glutamic acid.

(3) *Hydroxy-amino-Acids*: Serine and hydroxy-glutamic acid.

(4) *Heterocyclic Acids*: Proline and hydroxyproline.

(5) *Mono-amino-Acids with Aromatic Nucleus*: Phenylalanine and tyrosine.

(6) *Mono-amino-Acid with Indole Nucleus*: Tryptophan.

(7) *Hexone Bases or Diamino-Acids*: Lysine, arginine, and histidine.

(8) *Thio-amino-Acid*: Cystine.

The chemical analysis of the proteins shows that the various proteins yield different amounts of the amino-acids. Some of the data are shown in Table I. The peculiarities of each protein are indicated by the figures in heavy type.

TABLE I.

	Ox muscle.	Casein.	Lact-albumin.	Gelatin.	Wheat gliadin.	Wheat glutenin.	Maize zein.	Maize glutenin.	Edestin.	Sturin.
Glycine	2.1	0	0	19.3	0	0.9	0	0.3	3.8	
Alanine	3.7	1.5	2.5	3.0	2.0	4.7	9.8		3.6	
Valine	0.8	7.2	0.9		3.4	0.2	1.9			
Leucine	11.7	9.4	19.4	6.8	6.6	6.0	19.6	6.2	20.9	
Phenylalanine... ..	3.2	2.2	2.4	1.0	2.4	2.0	6.6		3.1	
Tyrosine	2.2	4.5	0.9	0	1.2	4.3	3.6	3.8	2.1	
Serine		0.5		0.4	0.2	0.7	1.0		0.3	
Cystine				0	0.5	0.02			0.3	
Proline	5.8	6.7	4.0	10.4	13.2	4.2	9.0	5.0	4.1	
Hydroxyproline		0.3		6.4					2.0	
Aspartic acid ...	4.5	1.4	1.0	1.2	0.6	0.9	1.7	0.7	4.5	
Glutamic acid... ..	15.5	15.6	10.1	1.8	43.7	23.4	26.2	12.7	18.7	
Tryptophan		1.5		0	1.0		0		+	
Arginine	7.5	3.8	3.2	9.3	3.2	4.7	1.6	7.1	15.4	58.2
Lysine	7.6	6.0	9.2	5.0	0.2	1.9	0	3.0	1.7	12.0
Histidine... ..	1.8	2.5	2.1	0.4	0.6	1.8	0.8	3.0	2.4	12.9
Ammonia	1.1	1.6	1.3	0.4	5.2	4.0	3.6	2.1		
Total	67.5	66.5	57.0	65.4	83.0	59.7	85.4	45.7	81.9	83.1

In general, the albumin group of proteins contains all the amino-acids, except glycine, in various proportions. The globulin group is similar, but contains glycine, and has, in addition, a higher amount of glutamic acid, especially those globulins of vegetable origin. The phospho-proteins resemble the albumins, with no striking preponderance of any single amino-acid. The gliadin group of cereal proteins is peculiar in its high content of glutamic acid and proline. The members of the sclero-protein group (horn, hair, and gelatin) are heterogeneous, and here we may note that silk-fibroin is composed mainly of three mono-amino-acids, and is the very antithesis of sturin (the protein of fish sperm), which is made up of the three hexone bases with no, or very little,

mono-amino-acids. Gelatin lacks cystine, tyrosine, and tryptophan. Hair is richest in cystine. These are simply some of the most obvious differences. Proteins thus differ markedly in quality.

Our analytical data are far from complete; in no case do the totals of the amino-acids add up to 100. The incompleteness is chiefly due to the great difficulty of separating and estimating the individual amino-acids. There may be still some unknown amino-acids in small quantities; e.g. hydroxyglutamic acid has been discovered recently by Dakin by a new extraction method. This method may yet lead to new results; once again it has proved that every new process in connection with the chemistry of the proteins has given a valuable result.

Rather too great stress has been laid upon the analytical figures. The methods scarcely give exactness as far as the decimal figure, and it would have been better if the data had been returned to the nearest whole number. Many workers still give their data to two places of decimals, so that an entirely wrong impression is given of the accuracy of the method. Fischer pointed out that his method was not quantitative, but others have neglected this important statement.

The figures for the hexone bases are more accurate, but it is still not sufficient to express results to two decimal places. Kossel considers that the hexone bases form a special nucleus on account of their presence in all proteins. We might value a protein by its content of hexone bases, but it is not sufficient, because their total only tells us about a third or less of the whole molecule.

Tryptophan, discovered by Hopkins and Cole, is perhaps the most important unit in the protein molecule. It is not estimated except by direct isolation—a method which is laborious and requires considerable skill. Its amount is not known except in casein and a few other proteins. By its distinctive colour reaction with glyoxylic and sulphuric acids it can readily be proved to be a constituent of most proteins.

The amount of cystine in proteins is known only in a few cases, but its amount can be gauged by the sulphur content of the protein. It is the one unit known which contains sulphur, but there are indications that there is another sulphur-containing unit.

The differences in proteins are not confined to such quantitative data; they are still more involved. Fischer's synthetical work with the amino-acids has proved that the amino-acids are combined together in a polypeptide form, i.e. the amino-group of one amino-acid is combined with the carboxyl group of another, the amino-group of this acid being united with the carboxyl group of still another. We therefore consider a protein molecule to be a chain of amino-acids, thus:

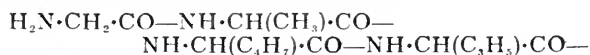

This method of combination allows theoretically of endless variation. If we take three amino-acids we can arrange them in six different ways: Glycyl-alanyltyrosine, glycylyltyrosylalanine, alanyl-glycyltyrosine, alanyltyrosylglycine, tyrosylglycylalanine, and tyrosylalanyltyrosine. With eighteen or twenty amino-acids the number of arrangements is almost infinite.

Differences in arrangement may be the cause of differences in proteins. Two proteins may perhaps have exactly similar amounts of amino-acids and yet be different; a difference could be expressed by the interchange of one amino-acid. We may imagine the proteins of the blood or milk of different species to differ thus: one may have the arrangement *a, b, c, d, e, f*, the other *d, a, b, f, e, c*.

Another important difference may exist in the so-

called tautomerism of the amino-acids and polypeptides. With the same arrangement of the amino-acids we may have several formulæ representing the polypeptide structure. Certain of the properties of the polypeptides can be explained on this basis.

Fischer and Kossel have revolutionised our conception of protein nutrition. We no longer think, like Liebig and others, that the protein of the food becomes directly the protein of the body, for it has been demonstrated by the physiologists that the protein of the food undergoes hydrolysis during digestion to amino-acids, that the amino-acids circulate in the blood, and that the tissues receive amino-acids from which they build up their protein. Proteins must be regarded as a mixture of amino-acids.

We can look upon a protein as we look upon the contents of a box of assorted biscuits, arranged in rows and layers of various kinds. Each biscuit should be connected to its neighbour so that we have a continuous chain. The general appearance of the contents of two boxes is different; in one case we may find sugary biscuits on the top, in another plain ones. In the process of digestion the protein is acted upon by acid in the stomach with the formation of metaprotein. No great chemical change occurs, but we can imagine that the change consists in a tautomeric re-arrangement in preparation for the action of pepsin. Pepsin hydrolyses the protein at certain junctions, forming proteoses and peptones. Their formation can be compared with the separation of the layers of the biscuits. Pancreatic and the further digestion which follow in the intestine separate the individual amino-acids or biscuits entirely. The separate parts circulate to the tissues; the tissues select the ones they require, and form another arrangement of the units or simply replace those which have been used in their metabolism. Digestion and metabolism are a sort of re-shuffling of the units. In the absence of any particular unit the tissue can no longer rebuild its substance, and consequently suffers. The old example of the inadequacy of gelatin is now explained; the tissues require tryptophan, tyrosine, and cystine, and gelatin cannot provide them.

In nutrition there are essentially two problems to study: the formation of new tissue, as in the growth of young animals, and the maintenance of tissue, which undergoes so-called wear-and-tear, in adult animals. In the latter case we have ultimately to ascertain if every unit of the molecule breaks down or certain selected units only. If these are in the middle of a chain it would follow that the whole molecule would undergo metabolism, and not units at the ends alone. The problem resolves itself into ascertaining the function of each amino-acid.

Since the practical difficulties of feeding animals with a mixture of pure amino-acids are far too great, advantage may be taken of feeding incomplete proteins and adding to them the missing unit or units.

Wilcock and Hopkins made the first experiment of this kind in 1906. They selected zein as protein and fed it to mice, in one set alone and in another set with the addition of 2 per cent. of its amount of tryptophan. Young mice on zein alone immediately began to lose weight and generally died in sixteen days; decline in weight also occurred in the other set, but with the added tryptophan death did not occur until the thirtieth day. Adult mice lived twenty-seven days without tryptophan, and forty-nine days with tryptophan. Tryptophan had thus an appreciable effect on the survival period of the animals. Zein is incomplete in respect of other units, and death was probably on this account.

The experiment was repeated in 1916 by Ackroyd and Hopkins under different, but better, conditions.

The animals were first given a mixture of amino-acids from casein (*i.e.* without tryptophan, which is destroyed in hydrolysis by acid) to which tryptophan was added; on the twelfth day the tryptophan was omitted, and included once more on the thirty-fifth day. There was growth during the first period, decline in weight during the second period, followed by growth on inclusion once more of the tryptophan. This is shown by the continuous lines in Fig. 1. The upper dotted line shows continuous growth on com-

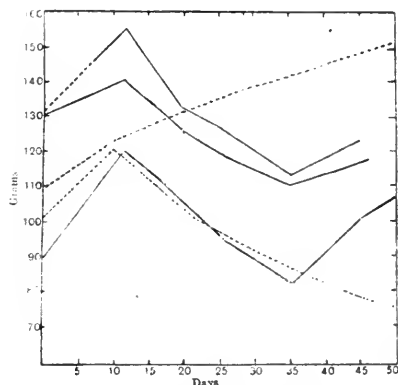

FIG. 1.—After Ackroyd and Hopkins.

plete mixture. The lower dotted line shows loss of weight in absence of tryptophan.

Similar experiments have been made by Osborne and Mendel in America. They used the gliadin of wheat as protein. This protein is a complete one, but it contains very little of certain amino-acids, especially lysine. Adult rats were maintained for quite long periods, so long as 500 days, but young rats capable of growth, though maintained for long periods, failed to grow.

We may here notice that though the growth of the animal may be suppressed and it reaches maturity in age, the capacity to grow is not lost. Osborne and Mendel illustrated this by a photograph of a rat which had failed to grow for 273 days, but resumed growth on being given a suitable diet.

The small amount of lysine in gliadin led the authors to regard this unit as essential for growth. In a later experiment they added lysine at intervals; growth took place with the lysine, but not without it. Fig. 2 shows the upward curve of growth with lysine, but no growth without it, in four sets of rats.

The function of the whole group of mono-amino-acids has yet to be determined. Are they all necessary? Of glycine we can say that it is not essential, for it is the only amino-acid which the animal can synthesise.

These results remind us of the well-known experiments on the need by plants of all the inorganic elements. Sir Daniel Hall in his "Fertilisers and Manures" gave a striking picture of barley-grains grown on a full food and on foods lacking one constituent. We may thus correlate the amino-acid con-

plete mixture. The lower dotted line shows loss of weight in absence of tryptophan.

Similar experiments have been made by Osborne and Mendel in America. They used the gliadin of wheat as protein. This protein is a complete one, but it contains very little of certain amino-acids, especially lysine. Adult rats were maintained for quite long periods, so long as 500 days, but young rats capable of growth, though maintained for long periods, failed to grow.

We may here notice that though the growth of the animal may be suppressed and it reaches maturity in age, the capacity to grow is not lost. Osborne and Mendel illustrated this by a photograph of a rat which had failed to grow for 273 days, but resumed growth on being given a suitable diet.

The small amount of lysine in gliadin led the authors to regard this unit as essential for growth. In a later experiment they added lysine at intervals; growth took place with the lysine, but not without it. Fig. 2 shows the upward curve of growth with lysine, but no growth without it, in four sets of rats.

The effect of lysine on growth was again demonstrated by Buckner, Nollau, and Kastle in the case of chickens living under the natural conditions of a poultry farm. The birds were fed upon grain mixtures of high and low lysine content; growth was more rapid on the mixture of high lysine content.

The element sulphur is present in proteins in the form of cystine, though it is possible that another sulphur-containing unit is present. Little or no cystine in a protein has also an effect upon the growth of rats. This has been most clearly demonstrated in

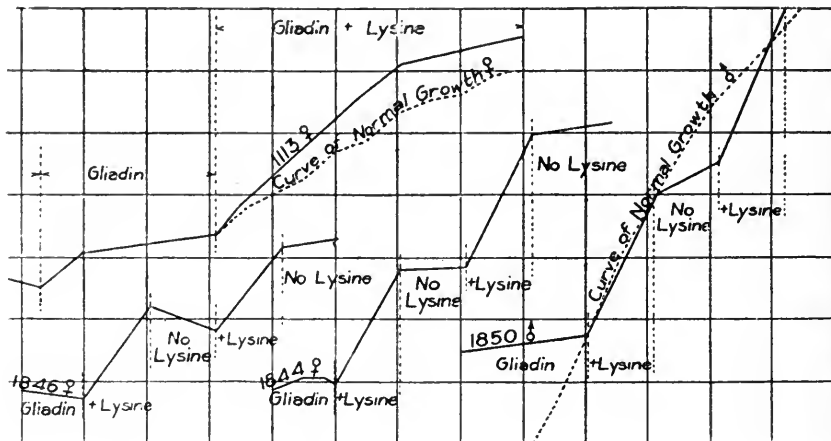

FIG. 2.—After Osborne and Mendel.

tent of proteins for the growth of animals with the set of inorganic elements needed for the growth of plants.

The relative value of various proteins in nutrition has been studied by Osborne and Mendel. In their experience lactalbumin is superior to casein, and casein to edestin. They found that 50 per cent. more casein and 90 per cent. more edestin were required to produce the same gain in weight; in other terms, a food containing 8 per cent. of lactalbumin was equal to one with 12 per cent. of casein and 15 per

cent. of edestin. Fig. 3 shows that the same amount of growth resulted in the same time with these quantities of proteins.

Suitable mixtures of proteins have also been tested, and attempts are being made to find out the most convenient addenda for making the proteins of cereals more adequate for the growth of animals, *i.e.* adding what we may call "good" protein to "bad" protein to make the latter efficient as food. Leaf and seed proteins are good as a mixture. Fig. 4 shows that if zein $\frac{1}{4}$ be supplemented with lactalbumin $\frac{3}{4}$, normal growth results.

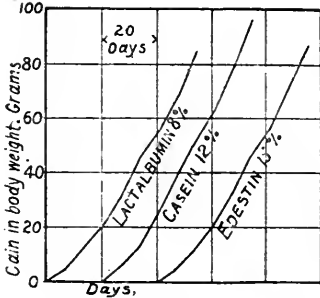

FIG. 3.—After Osborne and Mendel.

Economically, it may be better to use an expensive protein as food for animals and produce rapid growth than to feed for longer periods on poor proteins and get slower growth. A simple calculation brings out the problem to be solved. We may wish to build up the casein of milk with 16 per cent. of glutamic acid, and we are provided with wheat gliadin with more than 40 per cent. of this unit. There is waste of glutamic acid. Gliadin further contains 0.2 per cent. of lysine, whilst casein contains 6 per cent. To produce this

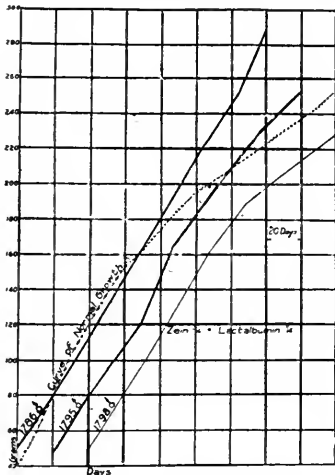

FIG. 4.—After Osborne and Mendel.

amount we require thirty times as much gliadin, and, consequently, the waste of glutamic acid is further increased.

Cannibalism is the most economical method of protein nutrition, as the amino-acids of the food are in the exact proportion required by the tissues. The nearest parallel to this is the nursing of the young animal by its mother; the child actually gets the proteins of the mammary glands.

Recent work shows that quality of protein is most probably the primary cause of the disease pellagra, although there are some indications that general in-

sufficiency of protein together with improper salt supply are contributory factors.

Pellagra is a peculiar disease characterised by severe disturbance of the whole digestive tract, by skin lesions, usually bilaterally symmetrical, and often mistaken at first for sunburn or chapping of the hands, face, neck, and other exposed areas. The nervous system is also affected. There is no definite record of pellagra in Europe before maize was introduced into Spain by Columbus. From Spain the disease spread to France, Lombardy, and eastwards, wherever maize was extensively used for food in the poorer agricultural districts. The relation of maize to the disease puzzled the medical profession for nearly two hundred years, for the disease also occurred where maize was not used, while in some districts maize was used but there was no pellagra. Roussel in 1866 showed that it could be cured by good food, and Lorentz (1914) and Willets (1915) successfully treated advanced cases with a generous diet. Goldberger also cured and prevented the seasonal appearance of pellagra in lunatic asylums and orphanages by increasing the quantity of meat and milk; previously the diet had been deficient in these respects. Goldberger, by the offer of a free pardon from the Governor of Mississippi, was enabled to obtain eleven convicts as volunteers for a feeding experiment to determine if pellagra could be produced by an unbalanced diet in healthy white men. The "pellagra squad," as they were called, were fed on white wheat flour, various maize preparations, polished rice, sugar, sweet potatoes, pork fat, cabbage, and turnip-tops. The food had an energy value of 2950 Calories, and was amply sufficient in this respect, but after the second month on this diet the men complained of weakness, headache, abdominal pain, and other minor discomforts. After five months six of them developed a rash which was pronounced by experts to be identical with that seen in pellagra, and during the last four weeks all the prisoners had shown marked loss of weight and were much out of health. Pellagra would probably have developed in the remainder, but the experiment had to be abandoned owing to the refusal of the men to continue. A control was carried out at the same time; their diet contained some meat, eggs, and buttermilk; there was not a single case of pellagra and no progressive loss of body-weight.

These and other facts clearly point to the diet as the controlling factor in the cause and prevention of the disease. The determining factor seems to be the quality of the protein. Good evidence on this point has been furnished by Wilson, of Cairo. In 1916 pellagra broke out in a camp for Armenian refugees at Port Said. Wilson showed that the diet at first supplied was inadequate both in energy supply (2200 Calories) and in protein supply; indeed, 92 per cent. of the protein was of vegetable origin—three-quarters from wheat and one-quarter from maize.

By determining the least daily amount of a protein required to keep a man from loss of body protein, Thomas was able to assign a series of values to proteins representing their biological efficiency. The comparative values according to the quantity required to maintain a man without loss of nitrogen and body-weight were:

Ox-meat	... 104	Rice	... 88
Cows' milk	... 100	Potato	... 79
Fish	... 95	Peas	... 56
Casein	... 70	Wheat-flour	... 40
		Maize-meal	... 30

The biological value of meat is therefore three times that of maize. Wilson calculated that the diet as given to the refugees was equal to 22 gm. of

casein. On improvement to a casein equivalent of 41 gm. no more cases of pellagra occurred.

Chick and Hume (1920) succeeded in producing in three monkeys symptoms very like those of human pellagra. The diet was very carefully selected, and was deficient only in respect that it contained no animal protein. One monkey refused the food after a short time; he lost weight and showed signs of incipient pellagra. The second monkey also lost weight, but the loss was lessened by adding tryptophan, though the addition of other amino-acids lacking in maize had no appreciable effect. This monkey

had signs of pellagra, and was cured by giving a normal diet. The third monkey had its loss of weight arrested by including tryptophan and hexone bases. This monkey showed some of the characteristic symptoms of pellagra, such as the symmetrical bilateral rash.

It appears thus that pellagra is caused by a continuous shortage in the supply of certain amino-acids in the food. A diet containing animal protein in small quantities will supply the needful amino-acids, but a large supply of vegetable protein may not be equally efficient.

The Cawthron Institute, Nelson, N.Z.

THE building and grounds in which the staff of the Cawthron Institute of Scientific Research has commenced its work were formally opened on Saturday evening, April 2, by his Excellency Lord Jellicoe, Governor-General of the Dominion of New Zealand. The building is a fourteen-roomed house, formerly the residence of the late Mr. John Sharp, and has been fitted up with chemical and biological laboratories, a library, a museum, and offices. The grounds provide room for a considerable amount of investigational work, but an experimental orchard and a site for an arboretum have been secured elsewhere. After being shown over the building by the trustees and staff, Lord and Lady Jellicoe adjourned to the School of Music, where a very enthusiastic gathering of citizens awaited them.

In opening the proceedings the chairman of the Trust, the Lord Bishop of Nelson, gave a short *résumé* of the events which led to the founding of the institute under the will of the late Mr. Thomas Cawthron, and explained the nature of the difficulties which had been met in attempting to carry into effect the provisions of the will. He also stated that the trustees had been fortunate in securing the unique entomological library of Dr. David Sharp, the editor of the *Zoological Record*.

Lord Jellicoe, in declaring the institute open, emphasised the importance of the co-operation of the workers in pure science with those engaged in industry. He had seen sufficient of the Cawthron Institute and its staff to convince him that the work carried out in the institute would be of very great value indeed.

An account of the work of the staff was then given by the director, Prof. T. H. Easterfield, who stated

that the staff had been working steadily for about eight months. In the chemical laboratory Mr. Rigg, the soil chemist, had obtained sufficient data for the preparation of a preliminary soil-map of the Waimea district, and this was already being eagerly examined by the farmers and fruit-growers of the district. A careful comparison of the chemical constituents of New Zealand mineral oils from various sources had been made by Mr. McClelland. Dr. R. J. Tillyard, the chief biologist, had paid much attention to the question of the control of plant diseases both by inoculation and by the use of natural enemies of insect pests. He had been successful in establishing *Aphelinus mali*, one of the enemies of the woolly aphis. Several entomological papers by Dr. Tillyard and Mr. Alfred Philpott, the assistant entomologist, were already in the press. The relation of hawthorn hedges to the spread of fire-blight and other plant diseases had also been the subject of close inquiry. Dr. Kathleen Curtis, mycologist to the institute, was working out the life-history of several fungoid diseases under New Zealand conditions, and the work was being followed with great interest by the fruit- and tomato-growers. The rapidity with which the building had been converted into a convenient research institute was very largely due to the energy and effectiveness of the curator, Mr. W. C. Davies, whose arrangement of the museum was admirable.

The director announced that during the week following the official opening the institute would be thrown open for four afternoons and one evening, and that the staff would explain the various activities to the public. More than a thousand visitors took advantage of the opportunity to visit the institute.

Institute of Historical Research in London.

THE opening of the new Institute of Historical Research of the University of London in Malet Street, close to the British Museum, on July 8 is a notable event on which warm congratulations may be tendered to the University and to Prof. Pollard. London University has always led the van in the recognition of research, and the new institute is to be devoted to the extension of knowledge. The inauguration of the building has been happily made the occasion of an Anglo-American Conference of Professors of History. London University, a pioneer in so many directions, created in 1920 the first post in England for the history of medicine. We have already referred to the systematic courses in the history of science that are being developed at University College, and it was in harmony with this London tradition that a sectional meeting of the congress was

held on Wednesday, July 13, to discuss "Anglo-American Co-operation in the Publication of Documents and Results of Research on Medieval Science and Thought." The meeting was well attended, and the chair was taken by Mr. A. G. Little, who spoke of the immense amount of important medieval material by English writers still waiting to be edited. He emphasised the need of scholars keeping in touch with one another's work.

Dr. Singer spoke of the educational value of the history of science and of the advantages accruing both to professor and student when to specialised research in a purely scientific field is added a general training as a qualification for a degree. Mr. Charles Johnson, of the Public Record Office, suggested that the editing of a text formed an excellent training for historical research, and suggested that such work, carried

out for incorporation in the publication of a more experienced scholar, should qualify for a degree. Prof. Tout, of Manchester, while a keen advocate of degrees by research and of the organisation of such research, warned the meeting of the dangers of over-centralisation swamping the student's individuality and power of initiative. Dr. G. G. Coulton, though agreeing that this would be a calamity, pointed out that in Cambridge the thesis was a successful part of the curriculum, and expressed the opinion that with due care the organisation of research was wholly advantageous.

Mrs. Singer briefly described the method of her Catalogue of the Early Scientific Manuscripts in the British Isles, and the assistance it gave to researchers in the history of science, especially to those living far from great libraries. She mentioned that a group of American professors was anxious to utilise the mathematical section for a complete *catalogue raisonné* of the mathematical texts, but that they had so far failed to raise from their universities the sum necessary for transcriptions from the manuscripts. She suggested that if other American universities cared to join in this work it would facilitate the raising of funds. After further discussion a resolution was proposed by Mrs. Singer, seconded by Prof. Tout, and unanimously carried, expressing the hope that the Institute of Historical Research would establish a bureau of texts needing to be edited and of students anxious to undertake such work.

University and Educational Intelligence.

ABERDEEN.—The summer graduation ceremony of the University was held on July 14 in the Mitchell Hall of Marischal College. Degrees to the number of 4 honorary and 145 ordinary were conferred by his Grace the Duke of Richmond and Gordon, Chancellor of the University. Sir George Carmichael, Chief Secretary to the Government of Bombay, and Prof. W. M. Bayliss received the Doctorate of Laws.

EDINBURGH.—At the graduation ceremonial on July 14 the following degrees were conferred:—*Honorary Doctor of Laws*: Mr. John Alison, Headmaster of George Watson's College; his Grace the Duke of Atholl; the Lady Frances Balfour; Mr. Ernest Barker, Principal of King's College, London; Sir John Cowan, Edinburgh; Sir A. W. Currie, Principal and Vice-Chancellor of McGill University; the Right Hon. Sir G. E. Foster, Minister of Trade and Commerce, Canada; Dr. J. S. Haldane; the Right Hon. Sir R. S. Horne, Chancellor of the Exchequer; the Right Hon. T. B. Morison, Lord Advocate; Sir Nil Ratan Sircar, lately Vice-Chancellor of the University of Calcutta; and the Right Hon. Sir Robert Stout, Chancellor of the University of New Zealand. *Doctor of Science*: F. A. E. Crew—thesis, "Contributions to the Study of Sex-determination in the Anura"; E. S. Edie—thesis, "Biochemical Researches"; R. J. S. McDowall—thesis, "A Study of the Pulmonary Circulation"; V. E. Parke—thesis, "Specific Heat of Constant Pressure of Hydrogen, Nitrogen, etc."; B. B. Sarkar (Calcutta)—thesis, "Relation between Thyroid and Bone-marrow"; J. Waterston—thesis, "Contributions to Medical and Economic Entomology"; and D. Clouston—thesis, "The Improvement of Cotton Crop in Central Provinces and Berar, and Documents relating thereto" (*in absentia*). *Doctor of Philosophy in the Faculty of Science*: Dr. H. Briggs (Birmingham)—thesis,

"Mine Rescue Apparatus and Certain Problems bearing thereon"; Mabel Carmichael (St. Andrews)—thesis, "Electro-synthesis in the Series of Dibasic Acids"; A. R. Normand—thesis, "The Boiling Points of Solutions in Methyl Alcohol under Reduced Pressure"; H. M. Steven—thesis, "The Biology of the Chermes of Spruce and Larch, and their Relation to Forestry"; and Margaret P. White—thesis, "Characteristic Frequencies in Elements of Low Atomic Weight (J Series)."

GLASGOW.—At a recent meeting of the University Court it was announced that the Bellahouston Trustees of Glasgow had made a grant of 500*l.* to the University for the purchase of apparatus required for the department of physiology.

An ordinance for the establishment of the ordinary, as well as the honours, degree of B.Sc. in pure science, under new regulations, has been approved by his Majesty in Council, and will come into operation at the beginning of next session.

Mr. A. Stevens, interim lecturer in geography during the absence of Dr. Falconer, has been appointed lecturer in place of the latter, who has now resigned office.

Prof. F. O. Bower, president of the Royal Society of Edinburgh, has been appointed by the Court a Governor of the West of Scotland Agricultural College.

The building operations for the erection of the new Institute of Zoology, adjoining the Natural Philosophy Institute, have been begun. The estimated cost of the structure is 110,000*l.*

The School of Pharmacy established by the Royal Technical College has been recognised under the affiliation scheme for the purposes of the ordinance for the degree of B.Sc. in pharmacy.

MANCHESTER.—The following appointments have been made:—Senior lecturer in physics, Dr. E. C. S. Dickson; senior lecturer in engineering, Mr. C. M. Mason; lecturer in engineering, Mr. Eric Jones; lecturer in systematic surgery and assistant to professor of systematic surgery, Mr. W. H. Hey; lecturer in clinical surgery and assistant to professor of clinical surgery, Mr. Charles Roberts; lecturer in pathology, Dr. Arnold Renshaw; lecturer in bacteriology, Mr. J. H. Dible; lecturer in morbid anatomy and histology, Mr. B. J. Ryrie; and lecturer in psychology, Mr. R. H. Thouless.

It is announced that Mr. R. A. Bartram has given the sum of 10,500*l.* to Sunderland Technical College. Of this sum 4500*l.* goes to the building fund for the erection of a drawing office for naval architecture at the college and 400*l.* for its equipment; the remainder, 5600*l.*, will be used to establish an endowment fund for four scholarships in naval architecture.

It has been pointed out to us with reference to the statistics given on p. 555 of our issue of June 30 in the article on "University Statistics of the United Kingdom, 1919-20," that the University of Bristol draws a considerable number of students from countries outside the British Empire. The number of such students shown in the official returns is fourteen, including three from foreign countries, but to these may be added the corresponding figures thirty and twelve relating to the Merchant Venturers' Technical College, as these are all members of the Faculty of Engineering of the University.

Calendar of Scientific Pioneers.

July 21, 1575. Francesco Maurolico died.—The first of the mathematicians of the Renaissance to study optics, Maurolico was born at Messina and became Abbot of Sta Maria del Porto, in Sicily. His chief work was one on conic sections.

July 21, 1888. Henry Garvill Lewis died.—Known for his glacial studies in the United States and Great Britain, Lewis held the chair of geology in Haverford College, U.S.A.

July 21, 1901. Henri de Lacaze-Duthiers died.—The founder and editor of the *Archives de Zoologie*, Lacaze-Duthiers was the originator of the Marine Zoological Laboratories at Roscoff and Banyuls-sur-Mer, and was known for his important studies of marine invertebrates.

July 22, 1802. Marie François Xavier Bichat died.—One of the greatest of anatomists and physiologists, Bichat was only thirty years of age when he died. Trained under Desault, he became physician to the Hôtel Dieu, where Napoleon caused a memorial to Desault and Bichat to be placed. Bichat's most important works were his "Recherches Physiologiques sur la vie et la mort" (1800) and "Anatomie Générale" (1801).

July 22, 1826. Giuseppe Piazzi died.—Piazzi was the first director of the Palermo Observatory, where on the first day of the nineteenth century he discovered the first of the minor planets called by him Ceres, in allusion to the titular goddess of Sicily. In 1814 he published an important catalogue of 7646 stars.

July 23, 1773. George Edwards died.—Edwards made valuable contributions to the ornithology of his day, and in 1750 received the Copley medal for his book entitled "A Natural History of Birds."

July 23, 1916. Sir William Ramsay died.—Born at Glasgow on October 2, 1852, and educated at Glasgow and Tübingen, Ramsay from 1881 to 1887 was Principal of University College, Bristol, and then succeeded Williamson as professor of chemistry in University College, London. He did important work in many branches of physical chemistry, and became famous the world over for his researches on argon and other rare gases of the atmosphere, the discovery of terrestrial helium, and his investigation of radium emanation. He was knighted in 1902.

July 25, 1903. Mathieu Prosper Henri died.—Prosper Henri and his brother Paul (1845–1905) were from 1868 onwards assistant astronomers at the Paris Observatory, where they had an important share in the development of the great International Photographic Chart of the Heavens inaugurated by Gill and Mouchez.

July 27, 1759. Pierre Louis Moreau de Maupertuis died.—A native of St. Malo and a member of the Paris Academy of Sciences, Maupertuis, who visited London in 1727, the same year as Voltaire, was the first in France publicly to support the views of Newton. With Clairaut he assisted in the measurement of a degree of meridian in Lapland, and afterwards, on the invitation of Frederick the Great, became president of the Berlin Academy of Sciences.

July 27, 1844. John Dalton died.—Born in Cumberland in 1766, Dalton from boyhood was engaged in teaching, and for the last fifty years of his life was connected with the Manchester Literary and Philosophical Society. His meteorological studies and his investigation of gases and vapours led to his discovery of the law of thermal expansion of gases and to the enunciation of the atomic theory. In 1808 he published his "System of Chemical Philosophy." After the death of Davy he was elected one of the eight foreign associates of the Paris Academy of Sciences.

E. C. S.

Societies and Academies.

LONDON.

Aristotelian Society, July 4.—Prof. G. Dawes Hicks, vice-president, in the chair.—Dr. F. C. S. Schiller: Arguing in a circle. A scientific system is essentially *partial*. Being constructed by selections and exclusions and relative to a purpose, it contains no warrant for the postulation of any all-embracing system. Objections to a system cannot be met by arguing within it. To meet a challenge it must obtain outside support. If it is to give satisfaction it must not close itself, but remain open to correction. The sciences are such systems, and so escape the charge of circularity. An all-embracing system is not a valid ideal, because inability to select would reduce it to chaos, while if logically complete it could be rejected as a whole. Also it is self-contradictory, for either it can be enlarged to satisfy objections, and then it is not all-embracing, or it cannot be enlarged, and then it argues in a circle. If it presupposes relativity to purpose, it cannot reach absoluteness. The attempt to base inference on implication within an ideal system is no improvement on formal logic, but merely a half-way house to a complete surrender of the notion of "formal validity."

PARIS.

Academy of Sciences, June 27.—M. Georges Lemoine in the chair.—M. Riquier: The complete families of integral figures of a system of partial differential equations of the first order.—J. Kampé de Fériet: Systems of partial differential equations of the most general hypergeometrical functions.—M. Hadamard: Systems of partial differentials, comprising as many equations as unknown functions.—T. Varopoulos: A class of transcendental functions.—M. d'Ocagne: Lines of curvature of quadrics.—J. Andrade: The problem of starting (a chronometer), and sustained pendular movements.—A. Thuloup: The equilibrium and stability of elastic apparatus.—F. Quénesset: Photographs of the planet Venus. On February 23, 1921, an observation with the 24-cm. equatorial showed a marked grey spot on the edge of the planet near the centre. Seventeen photographs were immediately taken with varying exposures, and a diagram is shown giving the appearance of the planet as taken from these negatives.—M. Juvet: The formulæ of Frenet for a Weyl space.—L. de Broglie and A. Dauvillier: The electronic structure of the heavy atoms. A comparison of the physico-chemical indications concerning the electronic structure of the elements with those furnished by a study of their X-ray spectra.—G. Ranque: A new mercury pump. A circulating mercury pump, requiring only 400 grams of mercury, worked with an auxiliary water pump.—M. Chevenard: Relation between the anomalous expansion and thermal variation of magnetisation of ferromagnetic bodies.—R. Dubrisay: The action of boric acid on glycerol and the polyvalent alcohols. The application of a new physico-chemical volumetric method.—E. L. Dupuy: The influence of welding on the resistivity of iron. The presence of ferric oxide in the metal causes an increase in the electrical resistance.—MM. Dervin and Ollmer: Ammoniacal silver carbonate. This is formed by the action of atmospheric carbon dioxide upon an ammoniacal solution of silver oxide. It forms colourless hexagonal crystals, and has the composition $\text{Ag}_2\text{CO}_3 \cdot 4\text{NH}_3 \cdot \text{H}_2\text{O}$.—E. Decarrière: The rôle of the gaseous impurities in the catalytic oxidation of ammonia. Details of a study of the effects of hydrogen sulphide as impurity in the ammonia.—L. Lutaud: General remarks on the tectonics of the pre-Riffian zone of northern R'arb,

Morocco.—S. **Stefanescu**: The phylogenetic and evolutive value of the lamellar formulæ of the last molars, M_1^3 , M_2^3 , M_3^3 , of mastodons and elephants.—C. **Störmer**: The aurora borealis of May 13, 1920. Simultaneous photographs from pairs of stations formed a basis for calculating the heights of various points of the aurora. The distances from the earth were between 192 and 470 kilometres.—E. **Delcambre** and Ph. **Schereschewsky**: A new method for predicting barometric variations.—A. **Guilliermond**: The microsomes and the lipid formations of the plant cell. The microsomes appear to be simple products of cell metabolism. They are usually constituted by lipoids, sometimes with neutral fats. Hence the terms microsome and spherome are unsuitable, and should be replaced by lipid granulations.—E. **Couvreur** and P. **Chossion**: The mode of action of plant rennets.—S. **Tchahotine**: The microscopic radiopuncture of mobile cells.—J. **Lopez-Lomba** and P. **Portier**: The physiological mechanism of the resistance of the rabbit to avitaminosis. Adult rabbits resist indefinitely a diet sterilised at a high temperature; this appears to be due to the bacteria which normally develop in the lymphoid tissue, these providing the vitamins missing from the food.—A. **Dehorne**: The mechanism of somatic metaphase and anaphase, and its consequences in *Corethra plumicornis*.—A. **Weber**: Grafts of the eggs of tritons in the peritoneal cavity of salamanders.—A. **Labbé**: The evolutive cycle of *Dunaliella salina*.—Mlle. Lucienne **Dehorne**: Conditions of the development of the durable egg in Phyllopod. —A. Ch. **Hollande**: The presence of a new Spirochaetoid, *Cristispirella caviae*, with well-developed undulating membrane, in the intestine of the guinea-pig.—P. **Courmont**, A. **Rochain**, and F. **Laupin**: The purification from bacteria and the coli bacillus in the course of treatment of sewage by the activated sludge method.

ROME.

Reale Accademia nazionale dei Lincei, April 17.—F. D'Ovidio, president, in the chair.—Papers by fellows:—C. **Segre**: Principal lines of a surface of S_5 and a characteristic property of Veronese's surfaces, ii. In S_{2k+1} , when k is even the infinitesimal order of contiguity of two Sk 's is always odd.—F. **Severi**: Theory of simple integrals of first species belonging to an algebraic surface, iii. Every Abelian function of the body "omega" is a holomorphic or meromorphic function of γ about every value which is neither singular nor critical.—A. **Abetti**: Applications of vectorial calculus to astronomy. Two formulæ are obtained agreeing with those of Chauvenet for the annual precession in longitude.—A. **Angeli** (fellow) and A. **Pieroni**: A work by Prof. E. Salkowski on melanin.—Papers communicated through a fellow:—O. **Lazzarino**: Limiting motions of a semi-rigid body about a fixed point under no forces. A continuation of previous work on motion of a solid with cavities containing viscous liquid. The ultimate motion is what one would necessarily expect.—M. **Pascal**: Superficial circulation, iii. Expressions for the force of sustentation in the case of a fluid current in space. The expressions for the force components of sustentation represent a generalisation of the ordinary hydrodynamical problem from two- to three-dimensional motions.—E. G. **Togliatti**: Three-dimensional varieties of fourth order which are loci of at least "infinity squared" straight lines, i.—L. **Pieragnoli**: Pathology of Pliocene and post-Pliocene mammals of Tuscany. Specimens in the museum at Florence of *Equus stenonis*, *E. caballus*, *Cervus* (sp.), *Rhinoceros etruscus*, and *Bison priseus* show various lesions, but without traces of tuberculosis except in one bone of *Cervus*. The

specimens in question mostly came from Valdarno. The author compares these results with the remains from Equi, in which tuberculosis was prevalent in *Ursus spelaeus*, while the lesions of the Florentine remains were there lacking.

May 2.—V. Volterra, vice-president, in the chair.—Papers by fellows:—A. **Angeli**: "Various observations" (action of pyridin on nitric ethers, coagulation of solutions of nitro-cellulose, production of certain sparks, experiments to show explosive properties of certain nitro-derivatives).—C. **De Stefani**: Ligurian fossil sponges, vi.: Internal strata of the western crystalline zone (Costa di Sant' Alberto, Voltri Station, Mele, Campo Ligure).—L. **De Marchi**: Vertical temperature gradient in the atmosphere. A modification of the usual thermodynamic formula in order to meet certain objections.—G. **Fubini**: Projective theory of congruences W.—F. **Severi**: Integrals of first species, iv.—G. **Bruni**: A new process for the cold vulcanisation of rubber. The specification refers to the process of generating the thiocarbanilide or other accelerator by a chemical reaction within the mass of rubber to be vulcanised instead of adding it in its final form. The author also cites an analogous process described in America by Scott and Bedford, who, however, use another accelerator.—In the next paper, communicated by Bruni, E. **Romani** shows that bisulphide of thiouramine is capable of vulcanising rubber even without the addition of free sulphur, a result not recorded by the American writers.—Prof. Volterra announced the death on April 16 of Prof. Gino Galeotti.

LAHORE.

Philosophical Society, October 15, 1920.—Dr. B. Sahni, president, in the chair.—G. S. D. **Ahluwalia**: The prevention and cure of plant diseases.

November 24, 1920.—Dr. B. Sahni, president, in the chair.—C. V. **Raman**: Ripples.

December 13, 1920.—Dr. B. Sahni, president, in the chair.—M. L. **Bhatia**: Some observations on the Lahore centipedes.

March 14, 1921.—Dr. B. Sahni, president, in the chair.—N. A. **Yajnik** and D. R. **Sarma**: Some investigations on indigo textile hydrosulphite vat-dyeing. As a result of careful investigations it was found that indigo can be best reduced by hydrosulphite NF in alkaline medium ranging from 0.1 per cent. to 5 per cent. NaOH in the ratio of 1:1.5 by weight. Unfavourable influence of the slight excess of free alkali in the vat can be to a great extent controlled by the addition of acetic acid, boracic acid, etc., and it was found that very small quantities (up to about 1 per cent.) of these gave greater absorption coefficient and better shades. The nature of the action is not yet clearly understood, but the effect of these additions is likely to be of great technical importance.

March 21.—Dr. B. Sahni, president, in the chair.—A. **Chandra**: Chemical constitution and optical activity, with special reference to camphor-amide derivatives.—B. K. **Singh** and M. **Singh**: 1:4-Naphthylene bisiminocamphor. This substance possesses the highest rotatory power hitherto observed.—B. **Sahni**: The cuticular structure of *Glossopteris angustifolia*, Brongn. From the form and venation alone it is so difficult to distinguish *G. indica*, Schimp., and *G. angustifolia*, Brongn., that the specific distinctness of the two has been doubted. The structure of the cuticle of *G. indica* was described by Zeiller in 1896; that of *G. angustifolia* now investigated shows well-marked differences which help to establish the two forms as distinct species.

May 19.—Dr. B. Sahni, president, in the chair.—B. I. **Das**: Sideliights on modern science from the

ancient sastras.—N. A. **Yajnik** and H. C. **Mahajan**: Hydrolysis of some Indian oils by vegetable lipase. The following oils were tried: (1) Linseed oil, (2) soapnut oil (from the seeds of *Sapindus trifoliatus*), (3) sukh-chain oil (from the seeds of *Pongamia glabra*), (4) neem oil (from the seeds of *Melia azadirachta*), and (5) sesamum oil. Of these sukh-chain oil and soapnut oil were not pressed so far from their seeds, but were specially extracted for the purpose of investigation, and they were found to be of particular interest on account of the extent to which they can easily be hydrolysed.

Books Received.

Air Ministry: Meteorological Office. Professional Notes No. 18. Lizard Balloons for Signalling the Ratio of Pressure to Temperature. By L. F. Richardson. (M.O. 240h.) Pp. 73-93. (London: H.M. Stationery Office.) 1s. net.

Memoirs of the Geological Survey: England and Wales. A Short Account of the Geology of the Isle of Wight. By H. J. Osborne White. Pp. v+219. (London: E. Stanford, Ltd.; Southampton: Ordnance Survey Office.) 10s. net.

Die Prinzipien der Physikalischen Optik. By Ernst Mach. Pp. x+444. (Leipzig: J. A. Barth.) 48 marks.

An Elementary Handbook of Commercial Geography. By J. W. T. Harris. Pp. 32. (Edinburgh: W. and A. K. Johnston, Ltd.; London: Macmillan and Co., Ltd.) 10d.

A Treatise on the Integral Calculus, with Applications, Examples, and Problems. By J. Edwards. Vol. i. Pp. xxi+907. (London: Macmillan and Co., Ltd.) 50s. net.

Optical Theories. Based on Lectures delivered before the Calcutta University by Prof. D. N. Mallik. Second edition, revised. Pp. vii+202. (Cambridge: At the University Press.) 16s. net.

Bureau of Education, India. Indian Education in 1919-20. Pp. iii+89+18 plates. (Calcutta: Government Printing Office.) 2.2 rupees.

Icones Plantarum Formosanarum. By Bunzō Hayata. Vol. x. Pp. iv+335. (Taihoku: Bureau of Productive Industries.)

New Alt-Azimuth Tables, 65° N. to 65° S. Pp. xvii+154. (Tokyo: Hydrographic Department.)

Mécanismes Communs aux Phénomènes Disparates. By Prof. M. Petrovitch. (Nouvelle Collection scientifique.) Pp. v+279. (Paris: F. Alcan.) 8 francs.

Botanical Memoirs. No. 4: Elementary Notes on Structural Botany. By A. H. Church. Pp. 27. 2s. net. No. 5: Elementary Notes on the Reproduction of Angiosperms. By A. H. Church. Pp. 24. 2s. net. No. 6: On the Interpretation of Phenomena of Phylloaxis. By A. H. Church. Pp. 58+xvi plates. 3s. 6d. net. No. 7: Elementary Notes on the Morphology of Fungi. By A. H. Church. Pp. 29. 2s. net. No. 8: Elementary Notes on Conifers. By A. H. Church. Pp. 32. 2s. net. No. 9: Form Factors in Coniferæ. By A. H. Church. Pp. 28. 2s. net. (London: Oxford University Press.)

Field Mapping for the Oil Geologist. By C. A. Warner. Pp. x+145. (New York: J. Wiley and Sons, Inc.; London: Chapman and Hall, Ltd.) 13s. 6d. net.

Elements of Engineering Geology. By Prof. H. Ries and Prof. T. L. Watson. Pp. v+365. (New

York: J. Wiley and Sons, Inc.; London: Chapman and Hall, Ltd.) 22s. net.

Lichens. By A. L. Smith. (Cambridge Botanical Handbooks.) Pp. xxviii+464. (Cambridge: At the University Press.) 55s. net.

The Theory of the Induction Coil. By Prof. E. Taylor-Jones. Pp. xi+217. (London: Sir I. Pitman and Sons, Ltd.) 12s. 6d. net.

A New System of Scientific Procedure: Being an Attempt to Ascertain, Develop, and Systematise the General Methods Employed in Modern Enquiries at their Best. By G. Spiller. Pp. ix+441. (London: Chatto and Windus.) 10s. 6d. net.

Diary of Societies.

THURSDAY, JULY 21.

INCORPORATED MUNICIPAL ELECTRICAL ASSOCIATION (at Institution of Electrical Engineers), at 10 a.m.—D. Wilson: Steam Raising: Yesterday, To-Day, and To-Morrow.—W. H. Miles: Modern Boiler House Practice.—At 2.30.—E. Cross: Present-Day and Commercial Problems in Electricity Supply.

FRIDAY, JULY 22.

INCORPORATED MUNICIPAL ELECTRICAL ASSOCIATION (at Institution of Electrical Engineers), at 10.15 a.m.—Annual General Meeting.

MONDAY, JULY 25.

ROYAL SOCIETY OF MEDICINE, at 5.30.—Dr. M. Diamond: Some New Phases of Old Problems in Dental Reconstruction.

CONTENTS.

	PAGE
The Tuberculosis Problem	641
The Foundations of Physics. By Dr. E. N. da C. Andrade	643
Mind and Brain	644
Mineralogy for Students. By Dr. John W. Evans, F.R.S.	646
Our Bookshelf	647
Letters to the Editor:—	
Radiation from the Carbon Arc. (With Diagram.)—Dr. H. H. Plaskett	648
The Discovery of Large Quartzite Implements of Rostro-carinate and Early Palæolithic Types in Uganda. (Illustrated.)—J. Reid Moir	649
Measuring with High Powers of the Microscope.—Dr. Geo. P. Bidder	650
Ocean Tides.—Dr. W. Bell Dawson	651
American and British Superannuation Systems.—W. Palin Elderton, C.B.E.	651
Cup and Ring Markings. (Illustrated.)—George Abbott	652
A New Acoustical Phenomenon.—F. M. West	652
Magnetism and Atomic Structure.—Dr. A. E. Oxley	652
An Algebraical Identity.—W. E. H. Berwick	652
The Air and its Ways. By Sir Napier Shaw, F.R.S.	653
Congress of the Universities of the Empire	655
Gold Medal of the Royal Society of Medicine. (Illustrated)	657
Obituary:—	
Henry Rondel Le Sueur. By A. C.	658
Notes	659
Our Astronomical Column:—	
Auroræ at a Height of 500 km.	663
The Minor Planet Eros	663
Jupiter's Four Great Satellites	663
Quality of Protein in Nutrition. (With Diagrams.) By Dr. R. H. A. Plimmer	664
The Cawthron Institute, Nelson, N.Z.	668
Institute of Historical Research in London	668
University and Educational Intelligence	669
Calendar of Scientific Pioneers	670
Societies and Academies	670
Books Received	672
Diary of Societies	672



THURSDAY, JULY 28, 1921.

Editorial and Publishing Offices:

MACMILLAN & CO., LTD.,

ST. MARTIN'S STREET, LONDON, W.C.2.

Advertisements and business letters should be
addressed to the Publishers.

Editorial communications to the Editor.

Telegraphic Address: PHUSIS, LONDON.

Telephone Number: GERRARD 8830.;

British Dyes and Dyestuffs.

THE Sub-committee appointed on December 2, 1919, by the Standing Committee on Trusts to "ascertain to what extent supplies, prices, and costs of dyes and dyestuffs in this country, and profits thereon, are affected by any trade combination" has now reported under date May 18, 1921. The Report (Cmd. 1370, 4d. net) comprises fifty-five clauses, from which are drawn twenty conclusions, these being widely traversed in a minority report presented by Major Harry Barnes, M.P.

The first fourteen clauses reveal nothing which is not already familiar to those who have given more than superficial attention to the subject. A synopsis of the factors which had placed this country in a position of such complete inferiority to Germany as that which existed prior to the war brings out from their stable the two familiar stalking-horses, patent law and industrial alcohol.

"Further to these it has been said that in the early days there was a certain slackness and a lack of organisation on the part of the British manufacturers, who were content, for instance, to send out circulars whilst the Germans sent out travellers who were not only salesmen but skilled chemists; and it is asserted that the whole course of the development of synthetic dyes in this country subsequent to the initial discovery exhibits a lack of properly directed scientific research. But whether these were contributory causes of the passing of the dyes industry out of

this country, or whether they were accompaniments or results of the heavy handicap of unfair patent arrangements and unintelligent prevision as regards the use of industrial alcohol, is a matter on which there are differences of opinion" (clause 3).

This lengthy passage has been quoted because it offers an example of the confused thinking which it appears to be the fate of the dye-making industry to receive. Moreover, it is characteristic of the whole Report, which studiously avoids arriving at a conclusion that is not open to contradiction elsewhere in its pages; Major Barnes is more direct. Thus the Sub-committee is unable or unwilling to determine the relative value of the contributions to the industry made by duty-free alcohol on one hand, and by "properly directed scientific research" on the other. Perhaps it was not represented to the Committee that if the textile manufacturers of the sixties of last century had possessed imagination enough to set aside only 1 per cent. of their profits to develop what might then have been regarded as a branch of their own industry, Hofmann, Brunck, Caro, Martius, and Böttinger need never have left this country to build up the chemical industry of Germany, and a brisk demand for young chemists might have led Oxford and Cambridge then to weigh their responsibility towards that branch of knowledge which underlies all modern industry and all forms of life.

This nice reluctance to face an issue characterises also the treatment accorded by the thirteen agreed members to the main question upon which their deliberation was invited—namely, the extent to which the supply and cost of dyes have been affected by "any trade combination," otherwise the British Dyestuffs Corporation. Rightly declaring that "If the Corporation is over-capitalised its ability to sell at a reasonable price, while making a reasonable profit, will be in so far diminished" (clause 17), the Committee proceeds to analyse the financial basis of the amalgamation between British Dyes, Ltd., and Messrs. Levinstein which followed from the rejection in August, 1918, by the shareholders in the former company, of the alternative scheme proposed by the board of directors. The analysis recalls the fact that, the nominal capital of Messrs. Levinstein having been divided into 3000 preference shares (10l.) and 6000 ordinary shares (10l.), the preference shareholders received in exchange preference shares in the Corporation of an equal nominal amount, or cash at their option.

The holders of ordinary shares were more fortunate. The valuation of the net assets available for distribution to them showed a total of 348,000*l.*, and for this they received 174,000*l.* of 7 per cent. preference, 174,000*l.* of 8 per cent. preferred ordinary, and 450,000*l.* of 8 per cent. deferred ordinary shares, the last-named representing "goodwill, patent and other rights." Evidently the Sub-committee felt that such generosity requires an explanation, particularly as "It has been alleged that for fifteen years before the war Messrs. Levinstein's had not paid a dividend"; but the members were satisfied with the reflection that "the policy of the company had in general been not to pay out profits in dividends, but to put the profits back into the business" (clause 21). Fifteen years' abnegation of all dividends would certainly appear to merit recompense, but the fact that the present market valuation of the 798,000*l.* scarcely exceeds 100,000*l.* is a curious comment on the propriety of the original allocation. "The net value of the assets of British Dyes, Ltd., showed a total of 1,143,580*l.* available for distribution to the ordinary shareholders, and this was satisfied as to one-half by the issue of preference shares and as to the other half by the issue of preferred ordinary shares in the Corporation. In addition, the shareholders in British Dyes, Ltd., were entitled to an issue of 550,000 deferred ordinary shares in respect of goodwill, patent and other rights" (clause 20). Thus 1,000,000*l.* of deferred ordinary shares were created, adding 80,000*l.* per annum to the interest charges.

The Report is not so clear as to the allocation made to the Government. The statement that "The Government subscribed for 850,000 preference and 850,000 preferred ordinary shares in substitution for the loan on debentures to British Dyes, Ltd., of 1,700,000*l.* to which they were committed" (clause 10), does not reveal the proportion of the 1,700,000*l.* which had been loaned to British Dyes, Ltd.; the sum mentioned is that "to which they were committed," and it has not been publicly stated that the amount actually loaned was in excess of 1,200,000*l.* Remembering that the Government debenture was at 4 per cent., and that the average nominal rate of the preference and preferred ordinary shares is $7\frac{1}{2}$ per cent., it will be recognised that this allocation represented an additional interest charge of at least 60,000*l.* per annum on the earning capacity of the Corporation.

Conclusion (7), nevertheless, states that the thirteen agreed members "do not consider that

the Corporation is under the handicap of over-capitalisation, except in so far as the buildings, plant, etc., of the British Dyestuffs Corporation, Ltd., were erected at a time of high prices and feverish conditions," whilst Major Barnes's conviction is that "the Corporation is over-capitalised, and the Government, before investing public monies in same, should have insisted on the buildings and plant provided out of the abnormal war profits being written down to pre-war costs." Those who have difficulty in deciding between these conflicting opinions may be assisted by the recollection that the German companies, with which the Corporation must ultimately find itself in competition, have consistently practised the policy of under-capitalisation by returning a large proportion of their profits to the business in the form of expenditure on development and research. The Sub-committee is silent on this point. One of the inducements to potential subscribers offered by the prospectus of the British Dyestuffs Corporation in 1919 was a synopsis of the profits earned by the German "Big Four" during 1913, showing 2,499,592*l.* to have been the fruit of share capital and reserves aggregating 9,886,318*l.*; owing to the prudent policy indicated above, however, the nominal ten millions were notoriously nearer twenty millions in actual value, thus reducing the profit to the neighbourhood of 12 per cent., which is not an excessive figure for an industry which was virtually a world-monopoly.

In addition to the capital inflation indicated above, one most regrettable feature of the amalgamation was the destruction of the co-operative character of British Dyes, Ltd. Shareholders in that company were confined to dye-users, and the rate of interest was limited to 6 per cent. so long as the Government debenture remained unredeemed. Consequently, there was no inducement to charge prices higher than would pay this modest interest and provide funds for the prosecution of research and the development of new processes. "The influence of the amalgamation on prices is submerged by the other influences at work, and our attempts to single it out for separate examination have proved fruitless" (clause 39). Nevertheless, the schedule of prices for dyes is a startling contribution to the Report, showing percentage increases in March, 1921, over July, 1914, which are seldom less than 500, and often exceed 1000; but there is no evidence to show that they are in any way due to the combination. That is really the conclusion of the whole matter, and whilst the sessions of the Sub-

committee were doubtless full of interest and information to the members, it unfortunately happens that the Report will not contribute anything substantial towards a solution of the desperate problem with which the country remains confronted.

A War Memorial.

The Scientific Papers of Bertram Hopkinson.

Collected and arranged by Sir J. Alfred Ewing and Sir Joseph Larmor. Pp. xxvii+480+plates. (Cambridge: At the University Press, 1921.) 63s. net.

BERTRAM HOPKINSON'S scientific friends, including his Cambridge staff, decided well when they determined that no memorial could be more suitable or permanent than a collected edition of his writings on mathematical and engineering science. The editors and the syndics of the Cambridge University Press alike have earned our thanks by the manner in which their shares of the publication have been carried out.

There is no need to tell at length the tragic story of his life. Called home from Aden in 1898 by the death of his father, brother, and two sisters on the Dents de Veisivi, he took up his father's work as a consulting engineer with the aid of his uncle Charles, and carried out various important undertakings. Five years later he became professor of mechanism at Cambridge, and in the same year he married. For the next eleven years he was fully occupied in the development of the work of his chair. The papers in the volume under review form his contributions to science during that time, but they do not constitute by any means the whole of the debt we owe to him. To quote from Prof. A. V. Hill's appreciation in the *Alpine Journal*, at Cambridge

"a professor of mechanism can hope to make a school essentially in touch with the traditions of the place only on condition that his interests are largely, if not mainly, scientific. In Hopkinson Cambridge had an ideal professor, and the pupils trained in his school have already, especially during the war, raised a memorial to him by their work."

The war, when it came, claimed him at once, at first as a teacher at Chatham, then at the Admiralty, where he conducted some most important experiments which led to the modern methods of protection of large ships against torpedoes. Finally he joined the Royal Air Force as an officer in charge of experimental work of all kinds, becoming in June, 1918, Deputy Con-

troller of the Technical Department; on August 26 of that year he was killed in a flying accident.

The papers in the volume fall naturally into three main groups, dealing respectively with electrical engineering, with certain metallurgical questions, and with the problems of the internal-combustion engine. In addition, the first paper of the series, one on sources and vortices, which was contributed to the London Mathematical Society in 1898, deserves mention as indicating the width of his knowledge and interests. He was an electrical engineer by profession; his father had placed the construction of electrical machinery on a scientific basis by the paper on dynamo-electric machines written in conjunction with his uncle Edward, and published in the *Phil. Trans.*, and it was not unnatural that the son's early work as professor should deal with similar problems.

His first paper in the Proceedings of the Royal Society on the shunting of alternate-current machines gave a satisfactory explanation of the phenomenon, and seems to have been inspired in part by the behaviour of a small machine in the Wimbledon Power House near his home.

Electrotechnics did not for long retain his main attention. Papers on the elastic properties of steel at high temperatures, brittleness and ductility, and the endurance of metals under alternating stresses of high frequency, followed during the next few years, and each served to bring out his versatility and his power of getting at the heart of a subject and of explaining in clear and concise language the results of his investigations.

Two remarkable papers on the magnetic properties of iron and its alloys in strong magnetic fields, and on manganese steels, were published with Sir Robert Hadfield in 1911 and 1914, and have added greatly to our knowledge of magnetism. Hopkinson was able to show that the magnetism of saturation might, in the case of the carbon steels, be predicted from the composition by treating each steel as a mixture of iron and of less magnetisable carbide. With manganese, however, no such simple relation was found to follow.

The work, however, by which Hopkinson will probably be best remembered is that on the internal-combustion engine. It began with a British Association paper in 1904, which led in 1907 to an investigation into the efficiency of the gas engine; in the course of this research the well-known Hopkinson indicator was developed, and it was shown that indicator diagrams, properly drawn, could be used satisfactorily for the measurement of efficiency. In 1906 a most im-

portant paper on the distribution of temperature in an explosion cylinder was communicated to the Royal Society, and the discussion aroused on these matters led to the formation of the Gaseous Explosions Committee of the British Association, of which Sir Dugald Clerk was chairman, and Hopkinson secretary. Much, probably most, of our recent knowledge of the theory of the internal-combustion engine has sprung from the labours of that committee, and to the advance made Hopkinson was a most important contributor. It is sufficient, perhaps, to mention his last paper on the subject, "On Radiation in a Gaseous Explosion," communicated to the Royal Society in 1910; the work thus begun has recently been brought to a most satisfactory conclusion by his pupil and assistant, Mr. W. F. David. In conclusion, reference should be made to a lecture at the Royal Institution, 1912, on "The Pressure of a Blow," and to the Royal Society paper on "A Method of Measuring the Pressure due to the Detonation of High Explosives," which led in a simple way to results of marked interest.

Enough has probably been written to show the high value of the work Hopkinson did, and the magnitude of the loss to engineering science caused by his early death. To quote the words of Sir J. J. Thomson, speaking as Master of Trinity in a commemorative address, "our roll of honour contains the name of no one who has rendered greater services to his country."

The New Medicine.

The Principles of Preventive Medicine. By Prof. R. T. Hewlett and Dr. A. T. Nankivell. Pp. viii+536. (London: J. and A. Churchill, 1921.) 21s. net.

THE object of Prof. Hewlett and Dr. Nankivell in writing this book was to give an outline of the principles and practice of preventive medicine "so far as it seems to concern the medical student and the general practitioner of medicine." That there was need for such a book there is no doubt. All who are concerned in any way with the teaching or practice of public health and preventive medicine certainly must agree that such a book was required, just as they must agree that this volume by Prof. Hewlett and Dr. Nankivell goes some distance towards supplying the need. The preparation of the book, the authors admit, gave considerable trouble, the extent of the field to be covered rendering it difficult to decide what to include and what to omit. In all book-making this is always a difficult thing, but in this case the authors have chosen wisely, and in the twenty-one chapters and three

appendices they appear to have made reference to all the more important matters in respect of which the medical student and the practitioner—who, after all, are expected to play a great part in the preventive medicine of the future—need information.

As might be expected in a book prepared by two practical men like Prof. Hewlett and Dr. Nankivell, one a distinguished bacteriologist, and the other a Medical Officer of Health of some years' standing, the information given is trustworthy. Here and there in the writing, however, there is shown a tendency to leave the lines followed in the ordinary medical books, and to indulge in what may almost be called "flights of fancy." In a number of places the authors appear unable to avoid the temptation to drop into poetry, and to provide word-pictures in which they use much more colour than appears to be essential in a book intended for such dispassionate readers as medical students and practitioners are, or should be. The chapters in which the fancifulness and the over-drawing are most frequently to be met are, curiously enough, those in which serious writing and strict accuracy of expression are most called for—viz. those dealing with housing, infancy, motherhood, and school children—and though there may be some who will appreciate the picturesque and exaggerated phrasing at its true value and find it helpful, it seems not unlikely that more will regard it as objectionable and out of place. In any case, it seems unfortunate that in one of the first books on preventive medicine the line here chosen should have been taken, and the impression given that the subject is one which is most suitably dealt with in a style more popular than scientific.

In the chapters dealing with infectious diseases the authors have exercised greater restraint and provided an amount of interesting, useful, and sound information. These chapters are amongst the most valuable in the book, and are particularly noteworthy for a declaration against the tendency to search out and find specific germs of disease, and more or less in favour of the view that, since they can be shown to change their shape and even their virulence on occasion, there is no such thing as constancy among micro-organisms. It is not, therefore, too much to suppose them capable of undergoing such transformations as will allow them to produce one type of disease at one time and another of an associated type at some other time. Another excellent chapter—although by the medical student and practitioner it may be regarded as rather more full of arithmetic and mathematics than is absolutely essential—is that on vital statistics. Amongst readers

who will appreciate it are medical men in practice as Medical Officers of Health, many of whom find guidance in this connection necessary occasionally.

"Hewlett and Nankivell," as the book will inevitably be called, is certain of a great welcome, and equally certain to be classed as good. The feeling cannot, however, be escaped that it would have been better if the authors had avoided the faults in style to which reference has been made. In the second edition, which, no doubt, will soon be required, an opportunity for dropping some of the more lurid of the descriptive matter will occur, and it is to be hoped that the space thus released may be utilised for the presentation of some illustrations in addition to, or even in place of, a number of the charts and diagrams which alone adorn the present edition.

Non-Ferrous Metallurgy.

Handbook of Metallurgy. By Prof. C. Schnabel. Translated by Prof. H. Louis. Third edition, revised by the translator. Vol. i., *Copper—Lead—Silver—Gold*. Pp. xxi + 1171. (London: Macmillan and Co., Ltd., 1921.) 40s. net.

THIS well-known work on the metallurgy of the non-ferrous metals was first made available to the English metallurgist in 1898 by Prof. H. Louis. At that time there was not, in the English language, a complete treatise on this branch of the subject, and it was at once recognised that the book was an addition to our literature. The fact that Prof. Louis had rendered metallurgists a valuable service receives confirmation in the demand for a third edition. In preparing this new edition, Prof. Louis wisely decided to bring the work up to date himself, and not to wait for the publication of the third German edition, for, as he states in the preface, "all the important modern improvements in metallurgical practices are to be found in English-speaking countries."

A work of this kind, which covers such a wide field, takes considerable time to revise, and the war, having intervened during its preparation, has prevented some of the more recent developments from being recorded; but, in spite of this, the book will be found to be most useful and to have distinct value.

The volume which is now published deals with the metallurgy of copper, lead, silver, and gold. The original form of the work is still maintained, but the previous edition has been increased by about forty-five pages. The actual addition of new matter is greater than is represented by this increase, for obsolete processes have been deleted.

Considering the progress made in recent years, it is evident that Prof. Louis has had a difficult task in including the descriptions of modern methods without seriously increasing the size of the volume. For this reason the cutting down of the older processes might perhaps have been somewhat more drastic. Some of the processes described under silver, and also the "chlorination process" for the extraction of gold, have not a wide application at the present time, and are scarcely worthy of the space they have been allowed.

Besides the general revision, the section on calcination furnaces in the part on copper has been extended, the chief furnaces being described; also a concise description of the blast-roasting of copper ores is given, and the section on the Bessemer process of copper extraction has been enlarged. Among the additions made under lead are: The Savelsberg process, blast-roasting without lime, pot-roasting, and down-draught sintering processes. The part devoted to gold has received much attention, and has been improved by a clear and, in the space available, complete account of the cyanidation process—fine-grinding, various methods of classification, and the "all-slime process" being included.

There are two points open to criticism. In regard to the original matter, no indication is given that any of it has become of less practical value; consequently, students may receive the impression that some of the older processes are as important as, or even more important than, some of the chief modern methods. Moreover, the retention of a statement such as "the more recent form of" made in connection with the description of a plant which was given in the first edition twenty-three years ago is liable to be misleading.

The volume, as a whole, is comprehensive and accurate, and can be recommended with confidence. Prof. Louis is to be congratulated on having prepared this new edition and brought the book up to date. It is a pity that most readers will not be able to determine which is really the translator's work and so to judge of its excellence.

E. C.

The Confidences of Men of Science.

The Purple Sapphire, and other Posthumous Papers. Selected from the Unofficial Records of the University of Cosmopoli by Christopher Blayre. Pp. x + 210. (London: Philip Allan and Co., 1921.) 7s. 6d. net.

THE author—or, to be more accurate, the editor—of this fascinating but blazingly indiscreet volume refers to NATURE as "that

admirable journal"—a compliment which ought perhaps to secure a benevolent review, but needless to say we shall not let it induce us to depart from our habitual detachment.

Mr. Blayre was for many years Registrar in a well-known university, and had certain manuscripts confided to him by more or less scientific members of the staff on the understanding that they should remain *in retentis*, as who should say, unless events occurred which rendered their publication desirable. In no case, however, were they to be published in the lifetime of the depositors, to whom the documentation served as a sort of Freudian relief. Now there is no doubt that the publication clears up many puzzling events, such as the ghastly damage that followed the acceptance of the so-called "purple sapphire" by the Mineralogical Museum, the mystery of Prof. Markwand's death, and the tragic case of Austin Black, who, if anyone, must be credited with laying the foundations of psychobiology.

To clear up these and other obscurities, more familiar to the older than to the younger readers of NATURE, has seemed to Mr. Blayre sufficient warrant for publishing the deposited documents. He does not seem to be aware, however, that the Professor of Biology, the present reviewer, is still alive, and by no means so sure as he once was of Mr. Blayre's fiducial discretion. His feeling of relief when he found that his own document had been suppressed by the publishers enables him to sympathise at least with the relatives of the deceased gentlemen whose confidences are now blazoned abroad. It is true that names are sometimes suppressed or modified in the book, but in these days, when the study of the history of science is rife, it seems a cruelly thin disguise to refer to a professor by a pseudonym and then proceed to mention one of his well-known discoveries.

Apart from our own survival, which rather condemns the book, apart, also, from the editor's hurry to disclose the confidences of well-known men of science, we would protest against the somewhat amateurish editing. "Science" was never Mr. Blayre's *métier*, and we see that in his editing. When, for example, was Prof. Tyndall knighted, and how could there possibly be a monkey, even a small monkey, inside a bunch of bananas? Even the date of the preface is wrong; and *Lingulella* figuring as a *Lamellibranch* (!) is a very dead fly in the ointment. Would it not have been wiser to have submitted the papers for editorial purposes to the present heads of the various departments concerned, and to have

issued them as a volume of "University Studies"?

At the same time, many will be grateful to Mr. Blayre for publishing these papers with their poignant personalities and astonishing intimacies. They have made many obscure things clear, and they show us how human men of science are after all. But it is strange to read nowadays of the timidity with which the Professors of Botany and Zoology regarded the development of the cosmic dust, which is now a common item in the cinematographic repertory.

THE PROFESSOR OF BIOLOGY.

Our Bookshelf.

The Breeding and Feeding of Farm Stock.
By J. Wilson. Pp. vii+152. (London: Methuen and Co., Ltd., 1921.) 6s. net.

THIS work attempts to treat of a vast subject within a hundred and fifty pages of medium size and type, and there is no preface or preliminary word denoting that the talented author asks for that indulgence which may be claimed by a purely elementary treatise. So ambitious an endeavour courts criticism, and, in this case, no student of the subject could say that it is undeserved. Even in such a hurried summary a few words might have been spared to warn the tyro when the text was meant to be dogmatic and when the author was merely drawing upon a well-trained imagination. Perhaps the best example of such a caution being needed is to be found on p. 26. Here a truly skilful flight of fancy reads as if there were some scientific evidence to support the writer's faith in his own imagery. The harmful effect of the lack of necessary explanations may be found in sentences which can be described, read as they stand, only as the travesty of truth: e.g. we read on p. 65: "Sometimes a breed is recommended because it can live on little food, but, if a breed or an individual cow lives upon little food, then neither the breed nor the cow is a good milker."

Besides such inexactitudes, there are many omissions of reference to work throwing light on problems discussed. Nevertheless the book contains much that is interesting and instructive, and some matter that is inspiring. While it cannot be wished that the present work may be republished in its present epitomised form, it is to be hoped that the author will become more ambitious and give his readers, in a larger volume, or in several, the elaborated results of his study of this very important subject. K. J. J. M.

John Dalton. By L. J. Neville-Polley. (Pioneers of Progress. Men of Science.) Pp. 63. (London: S.P.C.K.; New York: The Macmillan Co., 1920.) 2s.

WITHIN the last ten years chemistry has completely emancipated itself from a type of metaphysical obscurantism which seems to be invading

physics in another disguise. Although a scientific atomic theory, as distinguished from the merely poetic efforts of the Greeks, appeared early in the seventeenth century, the chemical atomic theory on which the science is based is unquestionably the work of John Dalton. The story of Dalton has been told before, but the present small memoir may be welcomed as an interesting account which should find favour with students and the general reader.

Very few slips have been noticed. Garnett was Davy's predecessor at the Royal Institution; "Cruikshanks" (p. 28) should be "Cruikshank"; Thenard wrote his own name both as "Thenard" and as "Thénard"—the first was used by his contemporaries, but the second form, used by Mr. Neville-Polley, seems to be common now. It is scarcely correct to describe Thomas Thomson as the "great friend" of Dalton, for at the time of his visit to Manchester to get the account of the origin of the atomic theory accepted prior to Roscoe and Harden's investigations, Thomson was not personally acquainted with its author. The statement that Higgins "assigned the same weight to all atoms" was refuted by Meldrum, whose work should have been mentioned.

Geological Survey of Nigeria. Bulletin No. 1. The Geology of the Plateau Tin Fields. By Dr. J. D. Falconer. Pp. 55+x plates. (Nigeria: Geological Survey of Nigeria, 1921.) 10s. net.

In the first Bulletin of the Nigerian Geological Survey Dr. Falconer has given a useful account of the tin-bearing region of the Protectorate. Ancient schists and gneissose granites have been invaded by newer granites, followed by emanations rich in tin and fluorine but not in boron. Long afterwards, when the country had been worn down by atmospheric agencies, it was covered by the "Fluvio-marine Series"—volcanic rocks, and river gravels often rich in tin. Still later these were succeeded by younger volcanic rocks which have in some cases capped and preserved the older sediments. The alluvial beds that are still in process of formation are, however, the chief source of tin. Their investigation not only furnishes information on the occurrence of alluvial tin, but throws light on the problems of river erosion and deposition. The publication under notice, which is illustrated by excellent photographs of scenery and micro-sections as well as by maps, will be welcomed both by geologists and by mining engineers, though some analyses of the chief rock-types would have been a useful addition.

It is worth consideration whether it would not be possible to supplement a scientific publication like this by a non-technical pamphlet, clearly but simply written without assuming any previous knowledge of the subject. It should be provided with a general geological map, typical views, and large-scale maps and sections, and the meaning

of these should be carefully explained. Such publications would go far to promote a more general interest in the study of the rocks and the minerals they contain.

J. W. EVANS.

The Land of Goshen and the Exodus. By Sir Hanbury Brown. Third edition. Pp. 189. (London: Edward Stanford, Ltd., 1919.) 7s. 6d. net.

THIS extraordinarily interesting account of the bondage of Israel in Egypt and their exodus therefrom, written with the erudition of the scholar and the charm of the non-professional, is issued a third time. Sir Hanbury Brown advocates the view that the land of Goshen lay immediately west of the present Suez Ship Canal, that the western arm of the Red Sea extended at the time of the exodus over the Bitter Lakes and Lake Timsah, almost as far as Tel el Maskhûta (Pithom of the Bible), and that the crossing of the Red Sea took place between Lake Timsah and the Bitter Lakes, below Tussum, near Serapeum. In the new edition he contends that the term "Yam Sûph" refers to the expanse of water now called the Red Sea, in opposition to Sayce's view which limits the term to the Gulf of Akabah, namely, the arm to the east of the Sinai peninsula. The author also identifies the present Ayûn Musa as the Elim of the exodus: this, like many other views advanced by him, is rendered eminently reasonable by his advocacy. The last chapter, entitled "Modern Events in Goshen," contains illuminating parallels from modern history to the events associated with the sojourn of Israel in Egypt, including an interesting reference to the attack on the Suez Canal during the recent war.

A Farmer's Handbook: A Manual for Students and Beginners. By R. C. Andrew. Pp. xvi+126+xliv plates. (London: G. Bell and Sons, Ltd., 1920.) 6s. net.

TEACHERS of agriculture would do well to take notice of this little book. It is written by a man who has had practical experience both of teaching and of farming and knows the difficulties that beset the student entering on a new subject. It is confined to the arable side of farming, and deals with the implements and processes necessary for ordinary root and cereal crops. Many common important processes are included which often miss the text-book writer's attention, such as methods of tying corn, sharpening a scythe, making a potato clamp, etc., and there is much information that is usually obtained only after painful and sometimes costly experience. The little book may be commended to the growing body of men and women interested in the cultivation of a patch of land who find themselves more and more called upon to do for themselves what was formerly done by the skilled odd man.

E. J. R.

Letters to the Editor.

[The Editor does not hold himself responsible for opinions expressed by his correspondents. Neither can he undertake to return, or to correspond with the writers of, rejected manuscripts intended for this or any other part of NATURE. No notice is taken of anonymous communications.]

Biological Terminology.

DR. BATHER insists (NATURE, June 16, p. 489) that systematic zoology and botany are not wholly based on description, and gives some interesting interpretations of his own. Of course he is right—as right as if I had said that Africa is a land mass, and he had retorted that there were lakes in it. Driven by necessity, we all, even systematic zoologists and botanists, and even from infancy, practise inference and seek to make sure. We employ crucial testing when we desire to ascertain whether an explanation is true. We neglect it (e.g. in favour of rhetoric) when we wish merely to convince ourselves or others that it is true—as in the case of politicians, theologians, and those 262 biologists who propounded 262 explanations of sex and did not attempt to test even one. But all serious scientific interpretation is governed by very stringent rules: we must found our suppositions on verifiable facts; we must try to think of all alternative explanations of those facts; and, lastly, we must seek fresh and unlike groups of facts which shall eliminate, one after another, all the erroneous explanations. Then, and not until then, shall we have finished with mere guessing. As Überweg puts it: "One single circumstance which admits of one explanation only is more decisive than a hundred others which agree in all points with one's own hypothesis, but are equally well explained on an opposite hypothesis."

Now, can Dr. Bather tell us of any modern sect of biologists which employs this method? It became fashionable among physicists and astronomers before Newton, and is still the very breath of their nostrils. Next it invaded chemistry—hence the rout of the alchemists. Then it captured physiology—hence the modern science. Darwin and some of his contemporaries tried to introduce it into biology. But with the passing of Darwin the impulse ceased. The new men proceeded, *unquestioned* (that is the damning point), to break every rule of scientific procedure. They coined multitudes of words that sounded tremendously scientific, but actually had no meanings in their mouths, e.g. germinal, blastogenic, plasmogenetic, somatic, and the like. They formulated hundreds of hypotheses, and argued about them strenuously, but—because of the vagueness of their principal terms (e.g. innate, acquired, inherit); because they rarely tested hypotheses and never as a body accepted a test; and because lack of crucial testing prevented the utilisation of oceans of unlike, but perfectly authentic and relevant, evidence that waited unexplored in a host of subsidiary sciences—their controversies were unending. Lastly, there happened the strangest event in the history of science. Groups of biologists, disgusted with the unceasing babble, declared that they were done with controversy, and founded the "exact" and "modern" schools. That is to say, each group, believing that a particular way of observing facts was especially modern and exact, proceeded to restrict its evidence to facts observed in that way. But, as we shall see presently, there is no especially accurate way of observing, and it is a fundamental axiom that all

facts, no matter how observed, are equal before science. Again, if the area whence facts are derived be reduced, there is a corresponding reduction of evidence—of the power to discover crucial tests. Again, while controversy is unnecessary, there must be discussion, or the truth can never be established. There is a distinction between the two which implies a difference in temper. In controversy men try to belittle the facts and inferences of opponents; in discussion they candidly examine them with a view to ultimate agreement. Yet, again, "exact" and "modern" are rhetorical misnomers. This method of restricting evidence is very ancient. It has always fomented controversy, prevented discussion, and led, not to agreement, but only to the foundation and perpetuation of sects. Thus, Mohammedans have always used only Mohammedan evidence.

I am told that biologists think that I have wasted ink and paper on a subject—the method of science—which was thrashed out long ago. Certainly it has often been thrashed out; hence modern science. But never has it been thrashed out among biologists; hence the chaos in biology. As every biologist knows, his opponents, usually the majority, lack the right method; hence their incapacity to perceive the truth which to him is so plain. Anciently the scholastic thinkers founded their assumptions on unverified data and neglected to test them by fresh appeals to reality; hence the dark ages of Europe. Francis Bacon and his successors insisted that hypotheses must be both founded on, and tested by, verifiable data; hence modern thought and civilisation. But biology is still in the pre-Baconian stage. It is founded mainly on the unverified assumptions that some characters are more acquired, or innate, or inheritable than others, and, as I say, biologists rarely test their suppositions, and never as a body accept tests; hence the persistence, in great measure, of the dark ages in modern society. To-day no obscurantist dares to meddle with the established truths of astronomy, geology, or any interpretative science save biology. But he is still supreme in all that pertains to life. For example, he controls education, and, having rendered men unintelligent and trained them to unreason and passion, has recently drenched the world in blood. In England a million people, many of them innocent in every sense, are poisoned annually by means of easily preventable venereal disease, because ferocious, but ostensibly saintly, savages desire to punish sin. Yet man is a living being, and after all these years biologists should be able to tell us, with the full force of established truth, what may be achieved by education and how to achieve it. At present, notwithstanding the work of Lankester and others, biologists are impotent. However, it will not always be so. Sooner or later they are sure to fall into line with other scientific workers, and found one of the greatest and most potent of sciences.

I daresay biologists will think I am vapouring, for most of them are zoologists and botanists, and do not, almost as a point of honour, look outside their special sciences; and, while all biologists will agree that their opponents (usually, as I say, the majority) employ wrong methods of inquiry, none will believe that biologists as a class are ignorant or neglectful of the right method. Well, consider the following. Scores of similar instances may be found in literature. Once I read a book in which the author formulated suppositions of no very great importance, but which he, apparently using all the available evidence, tested carefully and established successfully. I may have been wrong in my opinion, and the author may have been superficial; but later I read a review of the

book by a very distinguished biologist. He controverted not a fact or an inference; all he had to say was: "The trail of the deductive thinker is over all." But how on earth can any supposition be established except by deduction? Crucial testing is deduction. All interpretative science has been created by it. "If my hypothesis be true and all others wrong, then this thing, and that, and that other must be true also. Let me see if it is so." Again, I once argued with another distinguished biologist. "But isn't the evidence true?" said I. "It may be," said he; "but it's not the sort of evidence we accept nowadays!" I found that his opinions corresponded with those of the writer of the following passage, another very distinguished biologist:—

"The recognition that only by experimental methods can we hope to place the study of zoology on a footing with the sciences of chemistry and physics is a comparatively new conception, and one that is by no means admitted as yet by all zoologists. I do not wish to disparage those studies that deal with the descriptive and the historical problems of biology. . . . It is undoubtedly true that many zoologists who have spent their lives in acquiring a broad knowledge of the facts of their science fail to make use of their information by testing the very problems that their work suggests. This is owing, no doubt, to their exclusive interest in the observational and descriptive sides of biology, but also in part, I think, to the fact that the experimental method has not been recognised by zoologists as the most important tool that scientists employ . . . the essence of the experimental method consists in requiring that every suggestion (or hypothesis) be put to the test of experiment before it is admitted to a scientific status. From this point of view the value of a hypothesis is to be judged, not by its plausibility, but by whether it meets the test of experiment. . . . It is sometimes said that Nature has already carried out innumerable and wonderful experiments. . . . Let us not be blinded by rhetorical questions of this kind." And so on, and so forth.

I wonder if anyone can tell us of a passage in any sort of literature which contains more misunderstanding than the one I have quoted. "Rhetorical" indeed! *Of course*, the essence of the experimental method is *not* that every suggestion shall be put to the test of experiment. Experiment is a mode of observing, not of thinking. It is used only when the desired facts cannot be directly observed, and only for the purpose of removing the conditions which obscure them. *Of course*, physics and chemistry are advanced and accurate, not because of difficulties in observing, but only because their workers have verified both their facts and their thinking, because they have accepted all tested suppositions readily, and because they have been in a position to measure and weigh accurately. They are experimental only because, from the nature of things, most of the desired facts were obscured and could not be revealed except by some device. Physicists and chemists would not be so silly as to experiment if they could observe at sight. As a fact, nearly all their established truths started with suppositions founded on patent facts, and were tested experimentally only because of the paucity of such evidence. There is nothing sacrosanct about a fact discovered experimentally, or about a hypothesis so tested. If you twist a dog's tail experimentally, the howl you elicit is not in the least more valuable intrinsically than the tail which you observe directly. You prove a man a thief just as surely by observing the spoons sticking out of his pockets as by turning them out. *Of course*, experiment is valuable; but we

need not assign it wrong values. It enables us to penetrate below the surface. But a diving dress is not the only wear. There are things worth knowing on the surface—so many things, nearly all the facts of zoology, botany, and most other biological sciences, that if they be ignored, crucial testing is impossible. *Of course*, hypotheses, founded on or even confirmed by experiment, are, like all other untested hypotheses, mere guesses; whereas all tested hypotheses, whether proved experimentally or otherwise, are in a different category: for a real test is crucial; it not only confirms the truth, but also eliminates the untruth. If literature be examined I think it will be found that when anyone insists that all suppositions must be put to the test of experiment, he really asks that we shall ignore all evidence except that revealed by experiment, and all suppositions except those founded on experiment—that, in fact, we shall grant his facts the same status and his opinions the same immunity from criticism that other sectarians (*e.g.* Mohammedans) claim for their evidence and opinions. Compare Newton, who when he found that the moon's orbit (a thing which must be directly observed) did not, as then calculated, fit into his theory of gravitation, laid aside his supposition for many years, and published it only when a fresh inquiry demonstrated an error in the first calculation. Consider the glaring truism that "Variation is the sole cause of non-inheritance; apart from variations, like exactly begets like when parent and offspring develop under like conditions." No biologist will venture to dispute that truism. Is it necessary to test it experimentally? If it be true, what becomes of the Lamarckian and Neo-Darwinian suppositions, and much besides that biologists have unendingly "tested" experimentally and unendingly disputed about?

When such freakish, partisan stuff as I have quoted can be published and applauded, is it not evident that biology must remain a tumbling ground for whimsies unless its workers discuss and agree on its rules of procedure? The rules under which other interpretative sciences have been created—that language must be precise and significant, that all verifiable facts are equal before science, that all suppositions must be crucially tested before admittance to a scientific status, and that all fully tested suppositions must be candidly accepted—are so few and simple that were they rigorously applied, then, since the evidence is so abundant, it is certain that biology would soon rank among the greatest, best established, and most useful of sciences. It is generally thought that the multiplicity and diversity of biological phenomena, derived, as they are, or should be, from so many sciences, make the task of the inquirer peculiarly difficult. Actually the reverse is the case; for, when evidence is abundant and diverse, opportunities for testing are correspondingly frequent and established truth, rightly sought, should soon cover a wide area. Other sciences halt while evidence is painfully collected; biology halts because the methods of its students are such that they are unable to use the abundant evidence already available.

Dr. Bather says *à propos* of recapitulation: "At the moment when his letter was published some of us were discussing that very question at the Linnean Society, and Sir Archdall Reid, had he been present, would have seen that the issue was far from being the simple one that he imagines." As readers of NATURE know, I am very modest and retiring. Nevertheless, if Dr. Bather will indicate his difficulties I believe I can help him. The truth is, I have, on one hand, great faith in ordinary scientific procedure, and on the other, amid vast ignorance, a knowledge

of some facts which appear to have escaped the notice of biologists; for example, the truism I have mentioned, that, apart from variations, offspring tend to recapitulate the development of their parents.

G. ARCHDALL REID.

9 Victoria Road South, Southsea.

Solar Eclipse Results and the Principle of Relativity.

ON a recent occasion I read a paper before the Manchester Literary and Philosophical Society on the nature of dimensions, in which, admitting the possibility and even probability of space and time having secondary characteristics, like those suggested by Lorentz and Einstein, reasons were given for doubting whether the methods employed for finding them could be relied on, and experimental evidence, before it could be accepted, would have to be subjected to searching adverse criticism. Prof. Eddington's solar eclipse results were therefore submitted to a process essentially the reverse of his, which had for object not the confirmation of a theory, but the discovery of an empirical relation. During this process it soon became evident that the astigmatism of the cœlostast mirrors, which had given much trouble during the eclipse by distorting the star images, had also affected the field and altered the star positions. The stopping down of the objectives aggravated this evil in a double sense: first, the reduction of the star-image astigmatism makes it impossible to construct a picture of what might be called the field astigmatism of the mirrors; and, secondly, the smaller the diameter of the pencil of light rays for each star, the further apart would be the regions on the mirror from which these pencils were reflected. Therefore, if the various regions of the mirror had semi-independent tilts, the places of the stars on the plates would be affected by these tilts. If for some of the existing plates these pencils should be found to overlap, and if the star-image astigmatism is sufficiently marked, then these plates might still be used for the object for which they were taken.

Wishing, first of all, to redetermine the positions of the stars as they appeared before scale corrections had been applied in order to trace the wandering of the images, it was found that for the outermost stars 10 and 11 these negative corrections would amount to 0.45". This in itself was a most disconcerting discovery, for the difference of displacement on which the eclipse conclusions were based is only 0.75". It is, of course, quite impossible for the telescope tube to have altered sufficiently in four and a half minutes to produce this result, and a change of focus of the objective would have had no effect; therefore the mirror must have warped even during this short time. At Principle the passage of clouds would produce an irregular warping effect, and this would account for the unsatisfactory photographs obtained there. In order to form some idea about the nature of the field astigmatism it was now decided to estimate the tangential displacements of the stars, for these would not be influenced either by the scale corrections or by the radial displacements, but only by the mirror warpings. It was then found that stars 3, 4, and 6, which lie almost in a straight line between 5 and 10, had moved about 0.45" across the connecting line of these outer stars. On averaging the uncorrected radial displacements it was found that a slight scale correction of about +0.0002" had to be made, as was done by Prof. Eddington, in order to harmonise them with the Einstein estimates, the excuse in my case being that the mirror may have acquired a slight temporary concavity. If, however, there was a temporary convexity, necessitating a scale

correction of, say, -0.0003", the displacements would appear to conform to the empirical formula $1.09'' - 0.00022''$. It will thus be seen that the use of cœlostast mirrors is not advisable where, as under eclipse conditions, rapid changes of temperature are unavoidable.

C. E. STROMEYER.

"Lancefield," West Didsbury, July 21.

MR. C. E. STROMEYER greatly exaggerates the possible effects of astigmatism of the cœlostast mirrors on the positions of the star images. He appears to consider that the pencils forming the different images are reflected from entirely different portions of the cœlostast surface. As a matter of fact, with the 4-in. lens the pencil producing the extreme star image was reflected from a portion of the mirror which had 85 per cent. of its area common to that producing the central pencil, and with the 13-in. lens (stopped down to 8 in.) the common portion was even greater.

That there was a slight astigmatism of the mirrors is not denied. Its presence was indicated by small differences in the scale and orientation constants of the plates determined in two different ways: from the right ascensions or declinations. These differences gave a measure of the amount of the astigmatism, and showed it to be very small and of very slight effect on the gravitational displacement. The question has been fully discussed by Prof. H. N. Russell (Monthly Notices, R.A.S., vol. lxxxii., No. 2, December, 1920), with the result that the conclusions deduced from the original reductions of the eclipse plates were fully substantiated and the Einstein displacement confirmed.

F. W. DYSON.

The Atomic Radius and the Ionisation Potential.

PROF. EVE'S interesting contribution to NATURE of June 30, p. 552, on the relation between the ionisation potential and the atomic radius induces me to publish certain similar ideas of mine on the same subject to which I referred some time ago before the Royal Society in some remarks on Prof. Rankine's paper "On the Proximity of Atoms in Gaseous Molecules" (Proc. Roy. Soc., February, 1921). I did not publish the results, because I desired to wait for further data. These ideas may be stated as follows:—

According to the Rutherford-Bohr model of the atom, by the radius of the atom is meant the distance from the nucleus of the outermost electron, *i.e.* the electron the quantum vibrations of which cause the radiation of the arc lines of the atom. Sommerfeld has shown that in the normal (unexcited) state the orbit is characterised by the azimuthal quantum-number unity and the radial quantum-number zero. This orbit is circular, but to calculate its radius we must know what is the field of force exerted by the central nucleus and the remaining $(n-1)$ electrons upon the vibrating electron. This is at present an insoluble problem, but Mr. S. N. Basu (*Phil. Mag.*, November, 1920) has shown that we can at least arrive at a qualitative explanation of Rydberg's laws of spectral regularity by assuming the attracting system to be equivalent to a net central charge unity, with a doublet of strength L . On the bases of this theory, if a_x is the radius of the monoquantic orbit, it is easy to show that

$$\begin{aligned} \frac{e^2}{2a_x} &= -\text{energy of the vibrating electron.} \\ &= h(1s) \text{ where } (1s) = \text{convergence frequency of the} \\ &\quad \text{principal series of the element in absolute} \\ &\quad \text{measure.} \\ &= eV_x, \quad V_x = \text{ionisation potential in } e.s. \text{ units.} \end{aligned}$$

For the H-atom we have, according to Bohr's theory,

$$a_H = \frac{h^3}{4\pi^2 e^2 m} (a_H = \text{radius of the electron in the normal state}).$$

$$= 0.532 \times 10^{-8} \text{ cm.}$$

and $\frac{e^2}{2a_H} = e(13.54 \text{ volts})$. Therefore for an element x with an ionisation potential of V_x we have

$$a_x = \frac{(0.532 \times 13.56)}{V_x} \times 10^{-8} \text{ cm.}$$

Thus the atomic radius varies inversely as the ionisation potential.

The atomic radii calculated according to this formula are, in general, smaller than the atomic radii calculated either from crystal data (Bragg) or from the kinetic theory of gases (Rankine and others). They are shown in the appended table for the sake of comparison:—

Atomic Radius.

Element	I.P.	From I.P. $a \times 10^8$	Crystal measures $b \times 10^8$	Viscosity data
H	13.54	0.530	—	—
He	25.40	0.28	—	1.08
Ne	22.80	0.33	0.65	1.01
(Horton, <i>Phil. Mag.</i> , May, 1921)				
Li	5.40	1.34	1.50	—
Na	5.11	1.41	1.77	—
K	4.32	1.67	2.07	—
Rb	4.16	1.73	2.25	—
Cs	3.88	1.86	2.37	—
<hr/>				
Cu	7.63	0.94	1.37	—
Ag	7.50	0.95	1.77	—
Au	8.63	0.83	—	—
<hr/>				
Mg	7.61	0.95	1.42	—
Ca	6.09	1.18	1.70	—
Sr	5.67	1.27	1.95	—
Ba	5.19	1.39	2.10	—
<hr/>				
Zn	9.35	0.77	1.32	—
Cd	8.95	0.81	1.60	—
Hg	10.38	0.69	—	—
<hr/>				
Tl	7.30	0.99	2.25	—
Mn	7.38	0.98	1.47	—

The values of V_x for copper, silver, and gold have been calculated from Hicks's value of the (1S) term for these elements. That for manganese has been similarly calculated from Mr. Catalan's value of (1S) for manganese (not yet published). For these data I wish here to record my indebtedness to Prof. Fowler and Mr. Catalan. The sources for the other values are quite well known.

MEGH NAD SAHA.

21 Cromwell Road, London, July 13.

American and British Superannuation Systems.

I READ with great interest the article in NATURE of June 30 on the American and British superannuation systems. The selection of a satisfactory scheme of superannuation is a matter of great importance in the organisation of a public service. On the one hand, an age limit can be effectively enforced only when suitable provision is made for those who are forced to retire, and on the other the provision of a pension conditional on the completion of a full term of service is objectionable, because a public servant who retires before that period is completed is penalised by the loss of a portion of the consideration for which he has given his labour. The result is that although a man may feel that he would do better work in another sphere, and has an opportunity of doing so, he cannot bring himself to forgo the pension towards

which he has already contributed some years of service.

The recent Committee of the British Science Guild on the Utilisation of Science in Public Departments considered this question, and came to the conclusion (*Journ. Br. Sci. Gd.*, June, 1921, p. 37) that the best solution appeared to be to award at the end of every year's service a pension (or alternatively an endowment insurance) accruing at the age fixed for superannuation (or in the case of the insurance at that age or previous death), independently of whether the officer had remained in the service or not. The advantages accruing in respect of a single year's service would, of course, be comparatively small, but those for successive years would, when added together, furnish an adequate provision for the old age of officials who had served the full term, while they would be a welcome addition to the resources of those whose later careers had followed other directions.

It is essential that these benefits should be secured by public funds, and based on actuarial calculations at current rates of interest. The amounts now quoted by insurance companies are apparently calculated on pre-war rates, and are far too low.

This scheme could be adopted whether the basis of the superannuation were contributory or not.

July 19. JOHN W. EVANS.

MAY I point out, in connection with the note appended to my letter printed in NATURE of July 21, p. 651, that if only one mutual life assurance company were available the argument quoted in the leading article of June 30 would be answered, for that argument implied that dividends necessarily go to shareholders? The remark about expenses in the note leaves the point of paragraph (3) of my letter untouched, and the final sentence of the note makes me wonder whether the two-year-old American "Teachers' Insurance and Annuity Association" will grow up and prove itself to be more "philanthropic" than the selected assurance companies in England.

I am afraid that, quite unintentionally, my former letter must have seemed offensive to have justified your note to it. The hot, dry weather has been, and still is, trying to us all, *et tout comprendre c'est tout pardonner!*

W. PALIN ELDERTON.

July 22.

A Novel Magneto-Optical Effect.

IN connection with the very interesting observations communicated by Dr. R. Whytlaw-Gray and Mr. J. B. Speakman (*NATURE*, July 14, p. 619), I should like to point out the close similarity of the phenomena which they have observed with those observed in the case of soap solutions (*Proc. Roy. Soc.*, A, 1921, vol. xcviii., p. 395; and *Journ. Chem. Soc.*, 1920, vol. cxvii., p. 1506).

Gray and Speakman describe the formation of flexible strings or fibres in clouds of various metallic oxides, these fibres being made up of particles of colloidal dimensions which still retain their individuality. Miss Laing, in her study of gelatinisation, was led to the conclusion that such conjunction or orientation of colloidal particles forms the mechanism of gelatinisation. For instance, in a soap solution the individual colloidal particles are otherwise the same in the liquid sol as they are in the elastic jelly. In the letter referred to it is pointed out that the particles in a cloud of cadmium oxide have an exceptional tendency to form such strings, and this agrees with the striking behaviour of Svedberg's sols of the same substance in alcohol, which on standing gelatinise, but on slight shaking revert to the fluid condition, an alternation which can be indefinitely repeated.

Gray and Speakman's results are of special interest because they occur in a particularly simple system, and thus afford opportunity for studying the mechanism of this effect, which, if Miss Laing's hypothesis is correct, must account for gelatinisation, even in the most complicated systems. J. W. McBAIN.

University of Bristol, July 19.

Science and Civilisation.

CAPT. B. J. MARDEN's letter in NATURE of July 14 (p. 623) raises a question which must be exercising the minds of many of the readers of NATURE to-day. That question is: How can scientific workers collectively obtain such control of the product of their work—new knowledge—as to secure that it shall be used for the development of a better order of society out of the existing chaos? Science—knowledge—alone can create this new order and save Europe from relapsing into barbarism. If this be accepted as a true statement of fact, we are led naturally to inquire: What are the best methods to pursue to secure that science shall be so applied?

The time is now ripe for scientific workers to set to work to devise a practicable scheme which will give to science its proper place in shaping the future destinies of the world. This is one of the chief purposes for which the National Union of Scientific Workers exists. Capt. Marden's idea seems to involve a sort of international Syndicalism applied to scientific workers and to scientific work. (Those readers who know about Syndicalism only from the daily Press will find a clear exposition of the Syndicalist position in Mr. Bertrand Russell's "Roads to Freedom," chap. iii., Geo. Allen and Unwin, 3s. 6d.) Such an organisation would offer no adequate security against the tyranny of a group over the rest of the community; and a dictatorship of scientific workers might be almost as great an evil as a dictatorship of miners, or of food producers, or of financiers. We should like to urge Capt. Marden and others who may have thought out schemes for the proper utilisation of science for the salvaging of what is worth preserving in our civilisation, and particularly those who have thought them out in the light of the large and growing volume of literature on the problem of the rôle of the producer (whether a producer of knowledge or of other essentials) in the future society, to publish their ideas in detail.

J. HENDERSON SMITH,
Chairman of Executive.

A. G. CHURCH,
Secretary.

National Union of Scientific Workers,
25 Victoria Street, Westminster,
S.W.1, July 19.

Bees and Scarlet-Runner Beans.

IN NATURE of August 12, 1920 (vol. cv., p. 742), a letter was published from me on the behaviour of bees visiting the flowers of the runner bean, *Phaseolus multiflorus*, to the effect that almost invariably the nectar was obtained from the flower by penetrating the calyx and corolla close to the position of the nectaries, the humble bees with their stronger mandibles biting through the sepals, while the honey bees took advantage of this pioneer work of their stronger relatives.

To my surprise, this year I find no such depredations made on the blossoms, but all the numerous humble bees are getting the nectar in a legitimate way, that apparently indicated by Nature, viz. by clinging to the more open left side of the flower and intruding the proboscis beside the pistil and stamens down to the nectar at the base of the petals. No

honey bees have yet been seen on the flowers, but whether because of their scarcity or by reason of their being now unable to reach the honey is not clear.

As the jasmine flower is still bitten by the humble bees, it would appear that the hot and dry season has caused the change in the behaviour of the bees towards the bean flower, probably by hardening the calyx and making it more difficult to penetrate, while causing the bloom to be less in size and depth, so that the nectar can be more easily reached from a frontal approach.

HARFORD J. LOWE.

Torquay.

A New Theorem on the Double Pendulum.

THE following interesting relation is believed to be new:—

Let M and m be the masses of the bobs of a double pendulum, and let A and B be their respective amplitudes with suffixes 1 and 2 to denote the modes. Then

$$\frac{A_1 A_2}{B_1 B_2} = \frac{-m}{M}.$$

The negative sign merely indicates that in one mode the bobs are opposed, and it may therefore be ignored if the absolute values of the amplitudes are considered.

It is noteworthy that the product of the amplitude ratios is inversely as the mass ratio—that is, directly as the respective distances of the bobs from their centre of gravity. It is striking that the product of the amplitude ratios is independent of the lengths of the pendulums, i.e. independent of the relative position of the bobs and the point of support.

When the bobs are of equal mass it follows from the foregoing that the lower pendulum is divided by the vertical through the point of support into segments the ratio of which in one mode is the reciprocal of the ratio in the other mode, i.e. if one point of section be overturned or swung about the middle of the lower pendulum through 180° , the two bobs and the two points of section then form a harmonic range which has many well-known properties.

H. S. ROWELL.

15 Bolton Road, Chiswick, W.4, July 18.

Ochreous Flint Artefacts from Sheringham.

I HAVE recently paid another visit to Sheringham, and have again devoted my attention to the ferruginous "pan" which, for a distance of more than a quarter of a mile, is exposed in places in the base of the cliff forming Beeston Hill. From different areas of this "pan" I have taken fifteen more examples of the ochreous flints such as occur upon the foreshore exposed at low water. The specimens, as would have been clear to anyone examining the deposit intelligently, were, without question, *in situ*, and were embedded prior to the deposition of the great masses of glacial and other strata of which the cliff is composed.

J. REID MOIR.

One House, Ipswich, July 22.

The Drought and Underground Water.

THE present drought affords an excellent opportunity for studying natural underground drainage in limestone (including chalk) districts. In many streams part of the flow takes place underground, but the fact cannot readily be ascertained while a surface flow continues. The flow of small streams is now so much reduced that the whole stream may be swallowed in the limestone and may reappear lower down. It is to be hoped that geologists in limestone districts will seize this opportunity to make observations.

BERNARD HOBSON.

Thornton, Hallamgate Road, Sheffield,
July 22.

The Application of Interference Methods to Astronomy.

By H. SPENCER JONES, Chief Assistant, The Royal Observatory, Greenwich.

THE recent measurement at the Mount Wilson Observatory, California, with the aid of an interferometer, of the angular diameter of the star Betelgeuse has attracted much attention, and has incidentally illustrated the advantages to be derived from the application of interference methods to astronomical measurement. In view of the striking success of this application, it is somewhat surprising that the possibilities of the method have been generally overlooked by astronomers, for the principles underlying the methods are by no means new, and their application to the determination of the angular diameters of the stars was indicated by Fizeau so long ago as 1868. It is of interest to recall the exact words used by Fizeau, the suggestion being thrown out by him incidentally in a report on the Bordin prize of the Académie des Sciences:—

“Il existe, pour la plupart des phénomènes d'interférence, tels que les franges d'Young, celles des miroirs de Fresnel, et celles qui donnent lieu à la scintillation d'après Arago, une relation remarquable et nécessaire entre la dimension des franges et celles de la source lumineuse; en sorte que les franges, d'une ténuité extrême, ne peuvent prendre naissance que lorsque la source lumineuse n'a plus que des dimensions angulaires presque insensibles; d'où, pour le dire en passant, il est peut-être d'espérer qu'en s'appuyant sur ce principe et en formant, par exemple, au moyen de deux larges fentes très écartées, des franges d'interférence au foyer des grands instruments destinés à observer les étoiles, il deviendra possible d'obtenir quelques données nouvelles sur les diamètres angulaires de ces astres.”

Stéphan was the first to attempt the determination of the angular diameters of stars in this way. He worked out an approximate theory, based upon elementary considerations, of the interference phenomena obtained in the focal plane of an objective when a uniformly illuminated circular disc, of small angular diameter α , is viewed through it, the objective being covered by an opaque screen in which are two parallel narrow rectangular apertures. The conclusion was arrived at that, in general, a series of parallel and equidistant interference fringes would be obtained, but that the fringes would disappear if the distance apart of the slits l satisfied the relationship $\alpha = \lambda/l$,¹ λ being the mean wave-length of the light. A determination of the distance apart of the slits for which the interference fringes disappeared is therefore sufficient to enable the angular diameter of the object to be deduced. The practical difficulty arises that in attempting to determine in this way the angular diameter of a star, the loss of light due to the restriction of the aperture to two narrow slits is so great that the fringes would in general be very faint. Stéphan removed this difficulty by showing that extended apertures could be used without serious error provided that they were equal and possessed

¹ A rigid mathematical investigation replaces this by the relationship $\alpha = 1.22 \lambda/l$.

two axes of symmetry at right angles to each other, one of these axes passing through the centres of the two apertures, and that their width was small compared with their distance apart.

With the 80-cm. Foucault refractor of the Marseilles Observatory, Stéphan, in 1874, examined Sirius and other stars. The fringes were obtained, but they did not vanish even with the maximum possible separation of the slits. The least diameter measurable by this method with this instrument was $0''.16$, but from the appearance of the fringes Stéphan was able to conclude that “les expériences citées ne prouvent pas seulement que le diamètre apparent des étoiles examinées est inférieur à $0''.16$, elles montrent encore que ce diamètre est une très faible fraction du nombre précédent.”

The subject was taken up again by Michelson, who, in 1890, gave a more rigid theoretical discussion of the method than Stéphan had done. Three cases of interest were examined, and the principal results obtained may be summarised thus:—

(i) If the object is a circular disc of uniform brightness, of apparent angular diameter α , the series of interference fringes produced in the focal plane of the objective when the aperture is limited to two narrow rectangular and parallel slits will vanish when the distance apart of the slits l is given by $l = 1.22 \lambda/\alpha$.

(ii) If the object is not of uniform brightness this relationship is modified. The precise modification for any given law of variation of brightness can be easily determined. If, for instance, the illumination falls off towards the limb according to the law of darkening observed for the sun, the relationship becomes $l = 1.33 \lambda/\alpha$.

(iii) If the object is a double source, with an angular separation of the components of amount α , the fringes vanish for a distance apart of the slits given by $\frac{1}{2} \lambda/\alpha$, provided that the two components are of equal brightness, that their distance apart is large compared with their separate diameters, and that the length of the slits is perpendicular to the line joining the centres of the two sources.

The method has practical application in the measurement of the angular diameters of small bodies such as planetary satellites and asteroids, and more recently of the angular diameters of stars, and also in the measurement of the separations and position-angles of close double stars or spectroscopic binaries.

The angular diameters of small bodies such as satellites are usually measured with a filar micrometer. The measurement is possible only under conditions of the best atmospheric definition, and even then the probable error of observation is relatively large, since the width of the finest spider web is comparable with the linear dimensions of the image in the focal plane of the telescope. Using the interference method, it is found

that the fringes can be well observed even under conditions of poor atmospheric definition, when the use of a filar micrometer would be impossible. The method has the further advantage that as the distance apart of the slits is varied, the separation which causes the fringes to vanish can be very precisely determined, so that the error of observation is greatly reduced. With small, faint objects, on the other hand, the loss of light arising from the use of narrow slits is serious. At the Paris Observatory an attempt was made to determine by this method the angular diameter of the major satellites of Jupiter, but the light was not sufficient to render the fringes visible. Hamy, therefore, extended the theory to the case in which the slits are of a width which is comparable with their distance apart. If the slits are rectangular, of width a and distance between their centres l , the formula obtained by Michelson for the distance corresponding to the vanishing of the fringes must be replaced by

$$l = 1.22 \lambda / a \{1 + 0.765 (a/l)^2\}.$$

Michelson and Hamy used the method for the measurement of the angular diameters of the major satellites of Jupiter. Michelson, in 1891, observing with the 12-in. equatorial at the Lick Observatory, used adjustable narrow slits. Hamy, in 1899, used the large equatorial *coudé* of the Paris Observatory, and prepared a series of screens of such dimensions that their width was one-third of their distance apart ($a = \frac{1}{3}l$), the widths being calculated so that the angular diameters, α , deduced from the above formula decreased by $0''.1$ with successive screens. The screens for which the fringes became least distinct were found, and by interpolation the angular diameters of the satellites were estimated to $0''.01$. The angular diameters so obtained, reduced to a distance of five units for Jupiter, were as follows:—

	I.	II.	III.	IV.
Hamy	0.98	0.87	1.28	1.31
Michelson	1.02	0.94	1.37	1.31

The agreement between the two series is very much better than would be obtained with micrometer observations.

The method does not appear to have been further employed until the past year, when, at Michelson's suggestion, it was tried with the 100-in. Hooker telescope at Mount Wilson. In view of the advantages of the method, this seems somewhat surprising; possibly it is due to an exaggerated idea of the difficulty of the observation. Besides the application to satellites and asteroids, the method might be employed for the measurement of the oblateness of such bodies as Mercury, which have no satellites from a study of the motion of which the oblateness might be theoretically deduced, and for which micrometrical observations are not sufficiently accurate. It can easily be shown that by rotating the slits into different orientations the corresponding angular diameters are determined.

At Mount Wilson the method has been applied to the measurement of the angular diameters of stars. Theoretical considerations have indicated that the stars of largest angular diameter are to be sought amongst the giant red, or M-type, stars, such as Betelgeuse, Arcturus, etc., but that for no star is the diameter likely to exceed $0''.05$, a quantity scarcely within reach even of the 100-in.

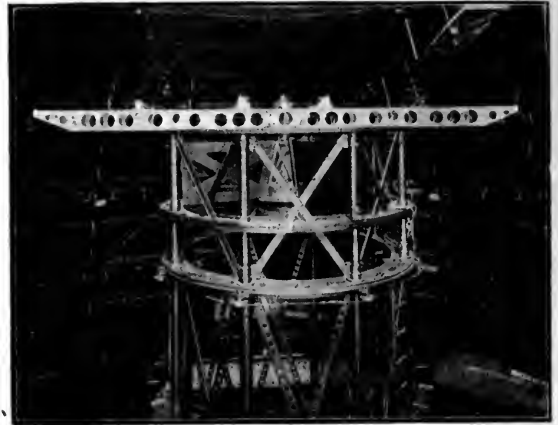

FIG. 1.—Stellar interferometer attached to end of tube of 100-in. telescope at the Mount Wilson Observatory.

reflector at Mount Wilson. Michelson, in 1890, had, however, indicated the possibility of employing the method in conjunction with an interferometer, thereby enabling the original separation of the two beams to be increased very considerably. The arrangement used at Mount Wilson is shown in Fig. 1, and diagrammatically in Fig. 2. A steel girder, L.L., 20 ft. in length is fixed across the upper end of the tube of the 100-in. telescope. Two adjustable plane mirrors, AA,

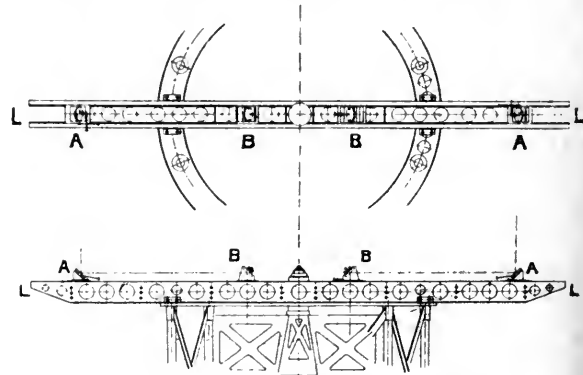

FIG. 2.—Plan and elevation of stellar interferometer.

reflect the light from a star along the girder to two other mirrors, BB, 4 ft. apart, which in turn reflect the light down the telescope tube to the mirror, the two pencils finally uniting, as shown in Fig. 3, and producing interference fringes in the focus of the eyepiece. To obtain the equality in the path of the two beams (which, for interference in white light to be observed, must be of an accuracy of $1/10,000$ in.), an adjustable double wedge of glass is placed in the path of one of

the beams, compensated by a plane parallel plate in the other beam. The girder is capable of rotation, so as to test whether the fringes vanish in all position-angles, thus excluding the possibility of the vanishing being due to a double source. The observation calls for a high degree of experimental skill, as all who have used an interferometer will realise, and after shifting the mirrors it is a matter of considerable difficulty to find the fringes again.

With a base line of 20 ft. it should be possible to observe the disappearance of the fringes in the case of stars the angular diameters of which exceed about $0''.02$. When the telescope was pointed on Vega the fringes did not disappear even when the two adjustable mirrors were at their maximum separation, indicating that the angular diameter of Vega is less than this amount. In the case of Betelgeuse the fringes disappeared when the separation of the mirrors was 10 ft. Adopting as the mean wave-length of

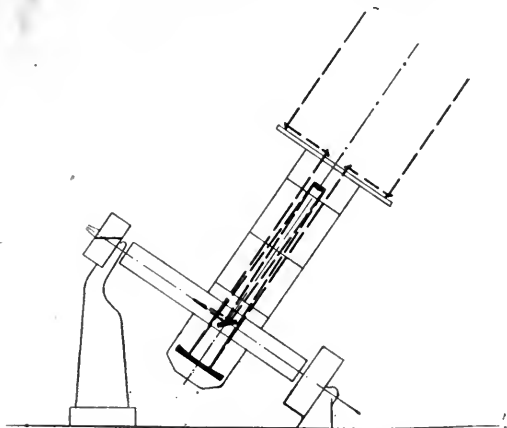

FIG. 3.—Diagram illustrating the paths of the two interfering beams.

the light 5500 angstroms, the value of λ/l is $0''.037$. Assuming that there is no darkening towards the limb, the angular diameter of Betelgeuse will be $1.22 \times 0''.037$ or $0''.046$. It is probable that the supposition of darkening according to the same law as for the sun would be nearer to the truth, and the angular diameter would then be $1.33 \times 0''.037$ or $0''.049$. To this extent the deduced angular diameter is uncertain. More recently the fringes were found to vanish in the case of Arcturus when the mirrors were 19 ft. apart, corresponding to an angular diameter of $0''.024$. This is almost the limiting angular diameter which can be measured with the present apparatus.

The number of stars the angular diameters of which exceed $0''.02$ is probably not very great; according to Eddington's estimate they are to be found amongst K-type stars of zero visual magnitude, or M-type stars of zero to third magnitude. The appearance of the fringes in the case of Vega with the maximum separation of the mirrors was so distinct, however, that it is con-

sidered that interference would be obtained with a base line of 100 ft. or more; if the mechanical difficulties can be overcome, the application of the method will no doubt be extended to base lines greater than 20 ft.

The determination of the angular diameters of stars is possible only with the aid of a very large instrument. For the measurement of the separations and position-angles of close double stars, the method can be employed with comparatively small instruments, and it is in this field that the method possesses the greatest possibilities. Its advantages as compared with the use of a filar micrometer are considerable. Adopting the late Lord Rayleigh's criterion for resolving power, a double star will appear just separated in a telescope if the central image of one component falls on the first diffraction ring of the other; since with a telescope of aperture d the distance between the central image and first diffraction ring is $1.22\lambda/d$, it follows that this is the smallest angular separation of the components of a double star for which the star will appear double. But with the interference method, as has already been stated, the fringes disappear provided that the distance apart of the slits is $\lambda/2\alpha$, α being the angular separation of the components, the fringes due to one star then falling exactly between those due to the other. The least separation which can be observed by this method, corresponding to a distance apart of the slits equal to the aperture, d , is therefore $\lambda/2d$, and it will be seen that the method increases the resolving power of a telescope in the ratio of about 2.44 to 1. Expressing d in inches, the normal angular limit of resolution is approximately $5''/d$; with the 100-in. telescope a separation of $0''.05$ should be just observable with normal methods of observation, the interference method reducing this to $0''.02$. That this increase in resolving power is actually obtained is proved by the observations of Capella at Mount Wilson. This star was known to be a spectroscopic binary, but visual methods had failed to separate the components, though it was established that their separation could not exceed $0''.06$; it therefore provided an interesting test object. The disappearance of the fringes was easily observed with the 100-in. telescope; the distance apart of the slits when this occurs determines the separation, and their orientation the position angle of the binary. Observations secured on six nights enabled an orbit to be computed. The observed distances and position-angles, together with the residuals from the values deduced from the computed orbit, are as follows:—

Date	Distance	Residual	Position-angle	Residual
1919 Dec. 30	0.0418	0.00000	—	—
1920 Feb. 13	0.0458	-0.00003	5.0	+0.4
" 14	0.0451	+0.00004	1.0	0.0
" 15	0.0443	0.00000	356.4	-0.9
Mar. 15	0.0505	0.00000	242.0	-0.4
April 23	—	—	(not stated)	-0.2

These figures emphasise the remarkable accuracy of the method (the largest residual in distance is only four ten-thousandths of a second of arc!). It is stated that with care both angular separation and position-angle can be measured with an accuracy of about 1 per cent. This accuracy is much greater than is possible with a filar micrometer. The method possesses the further advantage that the percentage accuracy in both distance and position-angle does not decrease with decreasing separation; with the filar micrometer, on the other hand, the error of observation increases considerably with decreasing separation. For the successful use of the interference method good "seeing" is not essential, whereas for the observation of close double stars with a filar micrometer very good seeing is necessary. In explanation of this unexpected result it is suggested by Hale that "in bad seeing, when using the whole aperture of the objective, there is an integrated effect of the light-waves meeting in all possible phases, which tends to obliterate the details of the diffraction pattern of the star-image, but that when two light pencils are selected at opposite ends of a diameter the result is not an integration, but a mere displacement of the diffraction-pattern, sufficiently small for the eye to follow."

If the distance between the slits is greater than the value $l = \frac{1}{2}\lambda/\alpha$, which gives a unique position for which the fringes disappear, there will be four position-angles for the slits in which this occurs, these positions being symmetrical with reference to the line joining the two components, viz. $p \pm \theta$ and $p + \pi \pm \theta$, where p is the required position-angle. The most accurate method of observation is to adjust the distance apart of the slits so that θ is about 30° to 50° , and to measure the four positions in which the fringes vanish, so determining θ and p ; if the separation of the slits is l , the value to use for the computation of the separation of the components of the binary is $l \cos \theta$, the separation therefore being $\lambda/2l \cos \theta$. If three different values of l are used and the corresponding values of θ are determined, the accuracy of the observation

is increased. We have heretofore supposed that the components are equal in brightness and separated by a distance large compared with their diameters. If they are of unequal brightness the fringes do not completely disappear in any orientation of the slits, but instead the positions of minimum visibility (when the fringes of one star fall between those of the other) are observed. The variation in contrast is greater the more nearly equal the components are in brightness. The method is therefore suitable for the observation of close doubles which do not differ too greatly in brightness and are beyond the limit of resolution of, or observable only with difficulty and under the most favourable conditions with the telescope available, in conjunction with a filar micrometer. The time required for a single observation is longer, but this is more than compensated by the great increase in accuracy of the observation, by the possibility of observing under poor atmospheric conditions, and by the smaller number of observations required for the determination of an orbit. Prof. Hale expresses the hope that through a co-operative plan of observation, in which several observatories will take part, a large number of close binaries may be measured in this way.

An attempt is to be made at Mount Wilson to extend the method to the measurement of stars several minutes of arc apart. Until this is tried it cannot be asserted whether or not the difference of atmospheric disturbances along the optical paths of the two stars would prevent the fringes from being observed. If it proves feasible to observe them in this case it may become possible to measure the displacement of a star by the gravitational field of Jupiter, and thereby provide a further test of Einstein's theory, scarcely possible in any other manner. The method might then also be employed for the determination of stellar parallaxes and proper motions (which depend upon the differential displacements of adjacent stars) with a smaller probable error and in a shorter time than by existing methods. The further investigation of these possibilities of the method will be awaited with great interest.

The Paris Conference of the Museums Association.

FOR an association which, during the first thirty years of its existence, has confined its meetings to cities in the British Isles, the proposal to hold this year's conference in Paris seemed somewhat hazardous. Whatever objections may have presented themselves to some members, there can be no doubt that the experiment proved a greater success than any anticipated. During the week July 11-17 the seventy delegates from national, municipal, and semi-private museums, with their president, who, by good fortune, happened to be a man of such distinction as Sir Frederic Kenyon, were received

in the most cordial manner by the heads of the State Museums of Art and of Science, by the Conseil Municipal and by the directors of its museums, and by the authorities of Les Invalides, the Bibliothèque Nationale, and similar institutions. Receptions at the Louvre, the Musée d'Histoire Naturelle, the Hôtel de Ville, and the club "Autour du Monde" enabled members to become personally acquainted with many French colleagues; and visits to the numerous and rich collections of Paris, Versailles, St. Germain, and Malmaison, under the guidance of distinguished authorities, with privileges accorded only to heads

of State among the lay public, enlarged the ideas of the British visitors almost beyond the limits of receptivity.

The inspiration and the actual knowledge of material and methods thus acquired cannot fail to benefit the museums and the municipalities which were wise enough to send their representatives across the Channel. On the other side of the account our French friends were good enough to admit some profit to themselves. The conservators of provincial museums in the recently formed French association were particularly pleased to see so many councillors of important cities, like Glasgow, Manchester, Hull, Carlisle, and Exeter, taking a keen interest in the proceedings and setting an example to their French brethren. Not only did the French museum officials observe with a pleased surprise that men of science and of art could co-operate to their mutual advantage, but the two camps in Paris were also (for the first time, one gathered) brought into friendly personal communication, so that the association may have begun the building of a new bridge across the Seine, from the Jardin des Plantes to the Louvre.

Among museums of interest to readers of NATURE, special mention should be made of the Musée National d'Histoire Naturelle, round the various departments of which the visitors were guided by Dr. Louis Mangin and members of his staff. It was pleasing to see how large had been the exchange of casts between this museum and our own Natural History Museum, and to recognise excellent specimens of British provenance. At the Musée Cluny Mr. De Montrémy explained the difficulties of arranging collections in a mediæval mansion, and the curators noted how successfully he had overcome them. At the Louvre the recently introduced system of guide-lecturers attracted the attention of museum administrators. Demonstrations are given in French, English, Italian, and Spanish; there are from twelve to fourteen a week at the Louvre, and a few in the other art museums of the State. To restrict numbers and defray expenses, admission is by ticket, costing 3 francs each lecture. Some of the members listened to an admirable exposition of the work of David by Mr. Rey, who is the organiser of the lectures. The wonderful collections of prehistoric archaeology at St. Germain, excellently displayed, and most kindly demonstrated to the party by Dr. Salomon Reinach, were among the greatest scientific treasures, and professional curators also appreciated the visit to the workshops.

To allow for the numerous outside attractions, the proceedings in the conference room were wisely limited. Dr. Hoyle's account of the system of registration employed at the National Museum of Wales provoked a lively discussion on the contrasted merits of books, loose-leaf ledgers, and card indexes. But here the chief feature was undoubtedly Sir Frederic Kenyon's presidential address, which, while dealing with the arrangement of museums of art and archaeology from a

general point of view, in reference to space and design, sketched out the lines on which, in the opinion of its director, the British Museum might most advantageously be modified. The congestion to which Sir Hercules Read has of late directed public attention has to be met. Experience shows that the growth of the collections cannot be overtaken by the mere addition of buildings. Recourse must be had to the storage in accessible cases of a large part of the collections, after the example set by the departments of natural history, of prints and drawings, of printed books, of manuscripts, and of coins. For the collection of Greek vases a division into three parts will be adopted, after the plan suggested by a former president of the association eighteen years ago—namely, a public gallery instructively and beautifully arranged; a series for study by amateurs; and a stored collection accessible to specialists. This method will save much room in many departments. More room, however, must be given to ethnography, since each distinct civilisation in time or space needs a distinct room for its display. A lecture room is required; the plans are prepared, and only await the funds to carry them out. A gallery should also be devoted to temporary exhibitions. The library ought to remain as the centre, with a ring of exhibition galleries round it, and an outer rectangle of storage and working rooms. Sir Frederic Kenyon concluded by enumerating some ways in which the British Museum could help local museums, and intimated that other ways would gladly be entered on if the curators of the local museums would make their needs known.

At the receptions in the Louvre and the Hôtel de Ville, as also at the association dinner, to which many of the French hosts were invited, Sir Frederic Kenyon emphasised the international importance of the gathering. The delegates from the national and municipal museums of Great Britain might, he said, be regarded as ambassadors preaching the gospel of peaceful civilisation and cementing the ties contracted by the two allied nations in war. This meeting might prove the first step towards an international association of museums, such as had long been in the minds of some members, and was again set up as an ideal by Dr. Loir, secretary of the Association of French Museums.

It was the enthusiasm with which Dr. Loir welcomed the suggestion of a Paris meeting, first publicly made at the Havre congress of the Association Française pour l'Avancement des Sciences (1914), that enabled the idea to be realised at last. It was the work of Prof. Roule and Drs. Bruyère and Lemoine, of the Musée d'Histoire Naturelle, that facilitated the execution of the plan. But the especial thanks of the association were accorded to its secretary, Dr. Tattersall, and to Mrs. Tattersall for their strenuous labours in seeing that the most audacious and the most far-reaching enterprise of the Museums Association was carried through most happily to a successful end.

Congress on the History of Medicine.

THE Second International Congress on the History of Medicine has just been held in Paris. The meetings were well attended, and the papers were of a high level of interest, and provoked some stimulating and fruitful discussions.

The members of the congress, who numbered several hundreds, were welcomed by the Chief Officer for the Organisation of Advanced Studies in France, representing the Minister of Public Instruction, who was at the last moment prevented from attending and delivering the inaugural address owing to an important Cabinet meeting. The Chief Officer emphasised the growing recognition of the importance of the study of the history of science, and especially of the history of biological science and medicine, as a method of enlarging the horizon both of the scientific worker and of the specialised scholar. The membership of the congress, which included the deans of all the great French medical schools, bore eloquent witness to this growing interest, and it was impressive to see not only that almost every country (except our own) has established university chairs in the subject, but also that excellent work is being done throughout Europe.

In Paris, as in Vienna, an extensive museum illustrating the history of medicine has been attached to the university. The interesting museum in Paris was formally opened at the medical faculty on the opening day of the congress.

It is possible to mention only a few of the papers that occupied a week's crowded programme. Both France and Belgium were strongly represented. Dr. Singer took the chair at the first session, when Prof. Jeanselme gave an account of diets in Byzantine hospitals and convents, deduced with great skill and ingenuity from contemporary non-medical documents. Prof. Jeanselme also gave an interesting paper drawing biological deductions from the records of medieval astrological lore. Prof. Ménétrier spoke of Eutrapel and sixteenth-century medicine.

M. Polain, of the Bibliothèque Nationale, pleaded for international co-operation in the bibliography of ancient medicine. In this matter substantial British contributions are available. The publication is eagerly awaited of the very complete and trustworthy "Bibliography of Medical Incunabula" up to the year 1485, compiled by the late Sir William Osler; while Mrs. Singer's "Catalogue of Early Scientific Manuscripts in the British Isles" provides a guide, available to students, though not yet all published, to the manuscript material of this country. Dr. Wickersheimer, the scholarly librarian of Strasbourg University, contributed two most illuminating papers on fourteenth-century medicine.

Dr. Tricot Royer, the president of the first congress, which met last year in Antwerp, gave an account of the hospitals of Antwerp from the year 1000 to the present day. The publication of his volume on this subject is eagerly awaited by

scholars. Switzerland was represented by Prof. Cumston, of Geneva, and by Dr. Sigerist, the newly appointed lecturer in the history of medicine at Zurich, who gave a scholarly account of Conrad Heingarter and the astrological medicine of the fifteenth century. The professor of the history of medicine from the Jugo-Slav University of Prague spoke on Czech medicine in the fourteenth century, while another member from Prague gave an account of the rich store of material for medical history provided by the surviving graduation theses of the ancient university, extending over a period of many centuries.

From this country came an interesting paper on Harvey by Sir D'Arcy Power, and an account of pomanders by Mr. Thompson, of the Wellcome Museum. Dr. J. D. Rolleston joined in the discussions. Dr. Singer contributed a fourteenth-century text of the lost work of Guy de Chauliac on astrology, and Mrs. Singer gave an account of medieval plague tractates, and produced a Catalan hymn to St. Sebastian for preservation against the plague which she and Dr. Singer had discovered still in use in the Pyrenean village of Planès.

Lack of space prevents an account of the valuable papers from Armenian members of the congress, from Venice, Madrid, Lisbon, Copenhagen, Gorinchem and The Hague, Rio de Janeiro, and many other places.

Nor was the programme confined to papers and discussions. The courteous and indefatigable secretaries, Dr. Laignel-Lavastine and Dr. Fosseyeux, had organised a series of entertainments. The congress visited the Bibliothèque Nationale, St. Germain, the Louvre, and other museums, besides a number of the more ancient hospitals, and in each case the visitors had the privilege of an address from the heads of the institutions, who showed them the chief treasures. Baron Henri de Rothschild invited them to a performance of "Caducée," the remarkable medical play now enjoying great popularity in Paris, and the week was further enlivened by an admirable concert by an orchestra of medical men at the Cercle Volney, and by a reception given by the Municipality of Paris.

All members of the congress were struck by the number and high level of the papers contributed to the congress from both France and Belgium. It is indeed remarkable that these countries, the greatest sufferers from the war, have led the way in the establishment of the Congress on the History of Medicine, and have made so conspicuous a success of the first two meetings.

Dr. Singer gave a cordial invitation for the congress to meet next year at the Royal Society of Medicine in London, and the proposal was accepted with enthusiasm.

Will next year's congress see the establishment of a chair in this subject, and the opening of a museum attached to the University?

Notes.

THE Dean and Chapter of Westminster Abbey have given consent for a memorial tablet to the late Sir William Ramsay to be placed in Westminster Abbey as part of the Ramsay memorial. The tablet will be placed immediately below the tablet erected to the memory of Hooker, the botanist. The Ramsay Memorial Committee has commissioned Mr. Charles L. Hartwell to prepare the tablet with a portrait medallion of Sir William Ramsay, and Mr. Hartwell is now at work upon the tablet.

THE council of the Royal Photographic Society has opened a fund by means of which some permanent memorial may be set up at Lacock to W. H. Fox Talbot, upon whose researches the present-day practice of photography and of photo-engraving has been built up. As president of the society, Dr. G. H. Rodman appeals to all who are interested in photography to contribute to the fund. Donations, large or small, to the memorial will be gratefully accepted and acknowledged by Mr. W. L. F. Wastell, vice-president, Royal Photographic Society, 35 Russell Square, London, W.C.1.

It is announced that a medal, to be known as the Meldola medal, will be presented annually by the Society of Maccabæans for the most noteworthy chemical work of the year carried out by a British subject who is not more than thirty years of age on completing the work. The award will be made by the council of the Institute of Chemistry acting with one member of the Society of Maccabæans, and power to vary the conditions of award is vested in the committee of the society and the council of the institute acting jointly. The object of instituting the medal is to recognise merit among the younger generation of chemists and to perpetuate the memory of Prof. Raphael Meldola, the distinguished chemist who served as president both of the society presenting the medal and of the Institute of Chemistry. It is hoped that the first presentation will be made at the annual general meeting of the Institute of Chemistry on March 1, 1922.

THE ever-increasing demands for information regarding the vegetable resources of South Africa, its plant poisons and plant pests, have given considerable stimulus to botanical research in that country. One result has been the establishment of the National Herbarium at Pretoria, which now includes all the more important private collections in the country. It has also been decided to issue from time to time a publication, which has been named *Bothalia* in honour of the first Union Premier and Minister of Agriculture, the late General Botha, consisting of contributions from the National Herbarium. It will include descriptions of new or little-known plants, cryptogamic and phanerogamic. Workers in systematic botany will find this publication of considerable interest and value, and intending subscribers should communicate with the Chief, Division of Botany, P.O. Box 994, Pretoria. The first part is now ready for issue, and may be obtained from the above address, price 7s. 6d. post free.

At the meeting of the Royal Society of New South Wales held on June 1 Mr. R. T. Baker, curator and economic botanist of the Technological Museum, Sydney, was presented with the Mueller medal by the president, Mr. E. C. Andrews. This medal was awarded to Mr. Baker by the Australasian Association for the Advancement of Science at the annual congress held in Melbourne last January for his eminent services to botany, particularly in regard to the Eucalypts. In addition to his work on the Eucalypts, Mr. Baker is the author of more than 100 original papers on the Australian flora, as well as of several monographs, such as "The Cabinet Timbers of Australia" and his *magnum opus*, "The Hardwoods of Australia," recently published. On the art side he has published a work on "The Australian Flora in Applied Art," a book just now in request by art designers in England and America. Mr. Baker is also the author of several monographs in conjunction with Mr. H. G. Smith, assistant curator of the museum. These, like those mentioned above, are all written for the express purpose of developing the natural resources of Australia, and so lead to extended industrial enterprise for the good of the community. The two most important of this collaboration are "The Pines of Australia" and "The Eucalypts and their Essential Oils," both of which have opened new fields for the development of the valuable assets amongst Australia's natural resources. Although Australian botany was specially mentioned by the Australasian Association for the Advancement of Science, yet Mr. Baker's work has extended into other branches of technology covered by the various sections of the Sydney Technological Museum, which, besides being a museum, is a bureau of scientific information for the commercial world around it.

PROF. ARTHUR DENDY discusses in a recent number of the *Eugenics Review* the perennial problem of human evolution. He believes that "the evidence of progress in conformity with a great general principle or law of Nature is conclusive." But evolution tends to take place in a wave-like manner, and not in a continuous straight line. There is apt to be a setback after each climax. The reason for this is partly because available stores of energy become exhausted, and the race may not be plastic enough to adjust itself to new conditions or skilful enough to tap new supplies. The line of racial persistence is one of re-adjustment in the light of education. "The great principle of evolution . . . consists in sacrifice and re-birth at more or less frequent intervals—sacrifice of all those accretions which have become effete or developed beyond the limits of usefulness, and re-birth by making a fresh start with a clean sheet." Man has a unique capacity for this task, since he has the gift of foresight and the power of deliberate control. But this is as yet inadequately developed. It must be developed by education—an education which will on one hand seek to utilise the available results of scientific investigation—on which are based, as Huxley said, the rules of the life-and-death game—

and on the other will recognise that the lasting and satisfying values are those of truth, love, and beauty. The address is a notable one—a wise, scientific sermon by a leading biologist.

AN account has been published (G. P. Putnam's Sons, Ltd.) of a meeting convened by Dr. Marie Stopes on May 31, in the Queen's Hall, London, for the discussion of constructive birth control. The chairman, the Rt. Hon. G. H. Roberts, M.P., spoke of the desirability of letting in daylight and securing trustworthy information; Dr. Jane L. Hawthorne urged the necessity of instructing those who sacrifice health and happiness through a rapid succession of child-births; Dr. E. Killick Milard laid emphasis on the eugenic aspect of birth-control, not only in promoting the welfare of a sound family, but also in preventing the appearance of a bad one, and submitted that the experience of vast numbers of intelligent people who have used contraceptives has demonstrated that they are, on the whole, effective and harmless. Dr. Marie Stopes directed attention to the opening of the first birth control clinic in this country, and emphasised the far-reaching racial importance of positive, as well as negative, control. The advance of science, she said, has made it possible to present a material scientific basis with which to embody spiritual ideals. Instead of attempting the ascetic repression of mutual love, what should be aimed at is a culture of a love associated with a utilisation of available knowledge. "Married lovers should play the part of parents *only* when they can add individuals of value to the race." The interesting booklet contains a series of impressions of the meeting by the Rt. Hon. J. H. Clynes, M.P., and others. The whole forms a restrained, but urgent, presentation of the case for birth-control linked to a sound idea of marital relations.

MANY interesting suggestions for further research into the methods of fish preservation are made by Mr. H. F. Taylor in a paper contained in the Proceedings of the American Fisheries Society for the year 1920. The paper deals with "The Principles Involved in the Preservation of Fish by Salt," and it contains the results of a series of experiments made by the author and others. The purest salt obtainable is recommended for ordinary methods of salting, for the impurities contained in crude products are of much significance. Calcium and magnesium salts retard penetration and harden and whiten the flesh, accentuating the "saltiness" of dried fish. Pure sodium chloride gives a "mild and sweet" cure, but the flesh is yellowish and soft. Dry salting leads to a more efficient and rapid preservation than does the use of a strong brine. Reddening of the flesh in dried salt fish is due either to a bacillus or to a spirochæte, which organisms can be traced to "solar," but not to mined, sea salt. "Rusting" in fatty fish is due to oxidation of fatty acids split off from the fats by enzyme action. Indeed, most of the defects of fish preserved in any way appear to be due to autolysis. Saltpetre, which is sometimes used as an accessory preservative, helps in the retention of a slight pinkness of the flesh by forming a nitroso-compound with the hæmoglobin of the blood. These are some of the

very important matters now being investigated in America—privately, it should be noted, for the author despairs of any helpful research by Government institutions, and looks to the fishing industry for adequate attention to problems of industrial fishery importance.

THE problem of sex-determination in amphibia has for a long time been known to present special complexities. The evidence of R. Hertwig and others must be accepted as proving that external influences have an effect on the proportions of the sexes, and consequently, whatever be the true interpretation of this evidence, the simple rule of genetic predetermination cannot be held to apply without qualification to these animals. Intersexes have also often been observed, especially in the frog (see a recent summary by F. A. E. Crew, Proc. Roy. Phys. Soc. Edin., 1921, vol. xx., p. 236). M. Ch. Champy has lately made an interesting contribution to this subject (*Comptes rendus Ac. Sci.*, May 9, 1921). He found that by starving male newts (*Triton alpestris*) severely at the time when spermatogenesis should be active, the development of the secondary sexual characters is arrested, and the animal remains in a more or less neuter state, as in winter. In the following spring the testes of these animals are found to be replaced by bands of fatty tissue, and the secondary sexual characters do not reappear. Two such males, after being fed up in winter, were observed to undergo a peculiar transformation, assuming somewhat the coloration of the female. One was dissected on January 11, and showed only the fatty bands replacing the testes. The other was kept until April 8, and became entirely female in appearance. On dissection each fatty band was found to contain an ovary with young oocytes, much as in newly metamorphosed females, together with an oviduct. The specimen in question had at the time of capture been an undoubted male, and reason is given for believing that it had fathered the fertile eggs of a female with which it had been paired in captivity before the treatment began.

In the Transactions of the Royal Society of Edinburgh (vol. lli., part iv., No. 30) Mr. J. M. Wordie publishes a paper on the soundings and deep-sea deposits of the Shackleton Expedition in the Weddell Sea. The soundings were 152 in number, and were made while the *Endurance* was a free agent and during her drift in the pack until she was crushed in October, 1915. This important series of soundings amplifies the only previous work in the Weddell Sea by the *Scotia* and the *Deutschland*, and was the principal scientific outcome of Shackleton's venture. No map accompanies the paper, but Mr. Wordie points out how the soundings remove all probability of Morrell's reported landfall or Ross's "strong appearance of land" in the north-west of the Weddell Sea. However, an island is still possible, even if unlikely. The continental shelf off Coats Land, discovered by the *Scotia*, has been proved to be narrow and irregular in contour. On the west of the Weddell Sea the *Endurance* took 103 soundings in depths under 275 fathoms, and proved the existence

of a series of stepped terraces with boundaries running north-east and south-west. These terraces run parallel with the eastern shore of the Weddell Sea, but at right angles to the presumed west coast. This terraced structure suggests that the Antarctic continental shelf is the result of earth-movements. The soundings of the *Endurance* were taken far west to touch the supposed deep in the Biscoe Sea, and they throw no further light on the problem of the connection of Antarctica with other southern continents. The rock-fragments obtained in the dredge, which on account of the movements of ice in the Weddell Sea probably all came from the east, tend to confirm the idea previously held that Coats Land belongs to the plateau type of Antarctica. Their evidence, however, is inconclusive.

THE Royal Geographical Society has recently issued two lists of place-names giving the spelling decided on by its permanent committee on geographical names for British official use. The first of these contains about 300 European names, and the second some 200 Asiatic names. Other lists are to follow. The aim has been to adopt so far as possible the native spelling, but in a number of cases the conventional form in use in this country has wisely been retained. The difficulty is to find a dividing line between the two systems. It is advocated, for instance, that the terminal "s" should be dropped in Marseilles, but retained in Lyons. Norwegian names beginning with a "K," like Kristiania, are spelt with a "Ch" in this list, for no apparent reason except usage. On the other hand, Gothenburg, the anglicised version of Göteborg, is discarded, and Helsingör is given in place of Elsinore. It is not clear why Arkhangel should be spelt with "c" instead of "k"; the latter may not be the more usual practice, but has the advantage of expressing with least chance of ambiguity the sound of the Russian letter. Similarly Harbin, the form advocated in the list, gives the sound less truly than Kharbin. According to the Royal Geographical Society's own system of transliteration (*Geographical Journal*, January, 1921), the sound is equivalent to "kh." The correct transliteration is used in Sakhalin. It may be correct, but it will prove difficult in usage, to substitute such forms as Bosphorus or Bukhara for the more usual Bosphorus or Bokhara.

THE Geological Survey has just issued the latest volume of its Special Reports on the Mineral Resources of Great Britain, dealing with rock-salt and brine, by Dr. R. L. Sherlock. The report is clearly written and very complete, reference being made to many even of the smaller brine springs existing in the country. It must be borne in mind that salt is one of the most important minerals produced in Britain, and that it forms the basis of an extremely important section of our heavy chemical trade; on this account information as to the occurrence and distribution of salt is of the greatest importance, and the Survey has done a valuable piece of work in collecting the information which has here been brought together.

DR. H. S. WASHINGTON contributes a paper of general interest on "The Chemistry of the Earth's Crust" to the *Journal of the Franklin Institute*, vol. cxc., p. 757, December, 1920, in which he correlates the regions of mass-defect and mass-excess, as shown by gravity-observations, with what is known of the chemical composition of the underlying rocks throughout the globe. He uses the analyses collected in the monumental Professional Paper 99 of the U.S. Geological Survey, and he finds that the rock-densities calculated from these analyses correspond well with the theory of isostasy. There is "a complete harmony between average specific gravity and average elevation everywhere," the rocks being less dense under the areas of higher land. In *Science* for March 4 C. K. Leith discusses the nature of the movements by rock-fracture or rock-flowage that occur in lower regions of the crust, and concludes that these are much like those that take place in the zone accessible to observation. Hence we need not postulate any single zone of flowage, such as Barrell's asthenosphere, and we are led towards "the Chamberlin conception of a heterogeneous structural behaviour of the earth."

DIURNAL variation in wind velocity and direction at different heights is dealt with by Mr. J. Durward in Professional Notes No. 15, published by the Meteorological Office. An attempt is made to discuss the results of pilot-balloon ascents made on the British Front in France at intervals of four hours. It is shown that winds up to a height of 3000 ft. have a minimum velocity at about noon, and the higher one goes the later does this minimum occur. At 4000 to 6000 ft. observations are generally insufficient, but there is evidence that west winds decrease by day and east winds increase. In general, a decrease in velocity is accompanied by a backing which may amount to as much as 20°. Results obtained on the same subject from pilot-balloons in Italy and in Batavia are referred to, and are said to be in close agreement.

CLOUDINESS in the United States is the subject of an article in the *Geographical Review* for April-June, 1920, by Prof. R. de C. Ward, of Harvard University. As a climatic element the amount of cloudiness is recorded by eye on a scale 0 to 10, and from observations made two or three times a day the mean annual and mean monthly amounts are calculated. In addition to this information the average number of clear, partly cloudy, and cloudy days in each month should be given. Maps of monthly and annual cloudiness for the United States have been available for the last thirty years or more, but the new maps drawn by the author have the advantage of more complete data collected and supplied by the Weather Bureau of the United States. In all, 190 stations are employed, and of these 65 had more than forty years of observations. The mean annual maps show that there are two districts of maximum cloudiness, both more than 60 per cent., one lying over most of the Great Lakes region and extending northward over the St. Lawrence Valley and northern New England, and the other on the extreme north-western Pacific coast. Both these

regions are said to be under marked cyclonic control. The northern States are more cloudy than the southern, and the Pacific coast as a whole is less cloudy than the Atlantic. July and August are the least cloudy months, whilst in the southern States the minimum cloudiness is in autumn. In Florida the cloudiest season occurs during the summer months.

THE report of the National Physical Laboratory for 1920 (the first year of the directorship of Sir J. E. Petavel) records an unusually large number of staff changes. Sir A. Schuster has become chairman of the executive committee; Mr. F. E. Smith has left to become Director of Research at the Admiralty; and Messrs. C. C. Paterson, A. Campbell, A. Kinnes, B. P. Dudding, E. A. Coad-Pryor, and Dr. N. Campbell have resigned, and some of these posts have not been filled. Mr. R. V. Southwell has been appointed superintendent of the aerodynamics department. The fees for tests have been increased, and the number of instruments sent for test has decreased as compared with 1913, notably in the case of optical and electrical instruments. A large amount of work has been done for industrial research associations and for Government Departments, but in future Admiralty

work will be independent of the Laboratory. The programme of work for the present year includes the measurement of physical constants required in industry and in the medical profession, the improvement of the tests for photographic lenses, the study of the characteristics of three-electrode valves for wireless telegraphy, the manufacture of length standards of high accuracy, investigations on lubrication, tests of models of aeroplanes with air-screws running, light alloys research, and investigation of the interaction of ships.

THE Bureau of Standards, Washington, has issued a pamphlet on "The Spectrophotoelectrical Sensitivity of Proustite," by W. W. Coblenz, which is now ready for distribution, and may be obtained by anyone interested by addressing his request to the Bureau. This investigation is a continuation of previous work on various substances. At 20° C. the spectrophotoelectrical sensitivity curve of proustite has a wide maximum in the ultra-violet, with a weak, ill-defined band at 0.6 μ . By cooling with liquid air the intrinsic sensitiveness is greatly increased, and there is a very large development of this band, which now shows a maximum at 0.578 μ .

Our Astronomical Column.

THE AUGUST METEORS.—Mr. W. F. Denning writes:—"This annual shower returns to a maximum on about August 11, and the circumstances are rather favourable this year, the moon being near her first quarter and setting at 11h. 10m. G.M.T. There is no reason to expect an unusually abundant display, but it will be sure to provide an interesting shower of bright, streaking meteors. The larger objects should be carefully recorded, so that their real paths may be computed. The position of the radiant point and its change of place ought to be determined on each night when the atmosphere is clear enough for the purpose, for the shower is already fairly rich at the end of July, and is well maintained until the middle of August. This date, however, does not limit its duration, for occasional meteors are seen towards the end of the month. The morning hours are usually best, for the radiant is at a greater altitude after midnight than at an earlier period. Though this system of meteors has been sedulously observed during a great number of years, there is still much to be learnt concerning its annual variations, date of maximum, changes in the position and character of the radiant point, and in the relative strength of the numerous contemporary showers which are visible."

SEARCH FOR METEORS FROM THE PONS-WINNECKE RADIANT.—Prof. Barnard reports that he watched for meteors all night on June 24, 25, 26, and 27; although the search was fruitless it has considerable negative value as showing that the dense part of the meteor swarm did not intersect the orbit of the earth, so that it would appear probable that the shower of June, 1916, will remain the sole example of a shower from the Pons-Winnecke radiant.

Mr. R. G. Chandra, of Jessore, India, also reports a fruitless search for meteors on the night of June 25. He states that Prof. Ray, of Bolpore, saw two meteors radiating from the neighbourhood of θ Boötis.

Prof. Barnard mentions a telephonic report of a shower lasting ten minutes on the night of June 27. No further particulars were available.

STATISTICS OF PROPER MOTIONS.—No. 30 of the Publications of the Astronomical Laboratory at Groningen, by Prof. J. C. Kapteyn and Dr. P. J. Van Rhijn, is a continuation of the valuable studies in stellar statistics that have appeared in this series. It commences with a *résumé* of recent catalogues and other sources of our knowledge of proper motions, such as Mr. Innes's researches with the blink microscope. The question of the effective area of the sky covered in each research is considered—that is, if a catalogue is not exhaustive down to some assigned magnitude, it is considered to be exhaustive for a smaller area of the sky, determined by the number of stars contained in the catalogue.

One of the most interesting questions dealt with is the number of stars in the whole sky with motion between certain limits. The following table has been formed from data in Tables 6 and 7 of the book. For these large proper motions the distribution is shown to be independent of galactic latitude.

Limits of Proper Motion.

Mag.	Limits of Proper Motion													
	0.2"	0.3"	0.4"	0.5"	0.6"	0.7"	0.8"	0.9"	1.00"	1.50"	2.00"			
6	169	71	30	26	16	7	5	3	14	1	5			
7	304	120	56	61	40	23	12	6	13	3	3			
8	520	216	76	124	36	21	21	11	18	6	12			
9	1125	410	103	38	47	25	34	13	51	21	9			
10	1425	261	166	133	48	29	24	10	33	10	19			
11	1770	342	200	135	63	117	45	36	90	9	0			
12	1770	450	450	68	45	23	23	90	113	45	0			
13	1620	690	400	225	135	23	113	45	23	23	28			
14	1490	800	350	158	68	113	45	0	0	0	0			

The 169 in the first line means that there are 169 stars in the whole sky with annual proper motion between 0.2" and 0.3" and magnitude between 6.0 and 6.9. Similarly in other cases. The figures for the faint stars are rough, since they are deduced from the examination of very limited areas.

The Universities and Technological Education.¹

By PROF. A. SMITHELLS, F.R.S.

NEARLY three centuries ago Robert Boyle came to Oxford aglow with zeal for the pursuit of chemistry, a study which he was the first to establish as a science and to endow with the title of a philosophy. His work, it appears, aroused bitter animosity; he was attacked in the University pulpit for his theories and their corrupting influence; above all, indignation was felt that he, a gentleman by birth and position, should concern himself with low mechanical arts.²

If times had not greatly changed, the prospect of those coming here to-day to proclaim the University rights, not of pure science, but of technology, would indeed be cheerless. But times have greatly changed, and whilst, as the centuries have passed, the best of the ancient ideals that dominate this illustrious seat of learning have become more precious and inviolate, and whilst the chief glory of the University still lies, I suppose, in the realm of ancient studies, there has been so wide an expansion of intellectual sympathy that to-day natural science is in brilliant display, and technology itself is not only condoned, but in a measure also practised here.

It is no part of my purpose to urge upon Oxford an extension of this latest province of her work. It would be an impertinence, even if I felt eager, as I do not, to suggest it. But I hope it will not be an impertinence to make into something of a text the historical facts just recalled. I have always thought that our difficulties with technology have arisen chiefly from the belated and stunted cultivation of natural science in the ancient universities. For it is they that have to so large a degree given the law intellectual and set the currents of our education. If natural science as it arose had been gathered to the older studies and had flowed in its natural courses, the mechanical arts and those who follow them would surely have been brought long since into a very different relation with the academic world.

Those arts which are first in importance to hungry, naked, and pedestrian man were the last which man learned to imbue with rationality. The succeeding arts, which regulate communal life, gave birth to professions that soon became learned; the economy and safety of communal life gave leisure for the disport of fancy; and so it happened that when the range and achievements of man's intellect in the pursuits that relate to human intercourse and to the imagination had already reached such magnificence as to send illumination down the ages, the science that intellectualises the mechanical arts was only just emerging from the close concealment of its material garb. The early promise soon was blighted, and natural knowledge languished through the Middle Ages, leaving industry to make its progress in the light of art, but in the gloom of empiricism.

When at last science took on rapid growth, when the stir of invention quickened the pace of humanity and we entered upon the riot of the industrial age, there ensued a period lasting until now when industry has been struggling, consciously and unconsciously, for its intellectual rights, lacking most grievously the sympathy, the prevision, and the leadership that should have been forthcoming from the established centres of educational influence, the universities. And so we find ourselves in a land that has been forced

to provide for itself as it could its bread-and-butter studies, its rations of useful knowledge dealt out to the toiler when his day's work is done, its technical schools, commercial academies, colleges of science, and I know not what else, standing outside and in the shade—improper still, I think, in many minds to what is education proper. We are not to blame those who have been busy in this work. "Necessity has no law, and expedience is often one form of necessity. It is no principle with sensible men of whatever cast of opinion to do always what is abstractedly best. Where no direct duty forbids we may be obliged to do, as being best under circumstances, what we murmur and rise against as we do it. We see that to attempt more is to effect less; that we must accept so much or gain nothing; and so perforce we reconcile ourselves to what we would have far otherwise if we could . . . it may be the least of evils . . . it may be professedly a temporary arrangement; it may be under a process of improvement; its disadvantages may be neutralised by the persons by whom or the provisions under which it is administered."

But we live in a time when we are forced as never before to consider our ways, to look beneath the surface of things, and to take thought for the future. It is a time when we must go back to principles and consider what, in Newman's words that I have just quoted, is "abstractedly best," a time when we may be excused for aggressiveness in asserting the fundamental principles of our faith.

Speaking in terms of our subject to-day, we may say that we find ourselves a people far spent by the cost of victory over a nation of technologists, a nation which had carried to the highest point the training of its people in applying exact knowledge to the mechanical arts of both peace and war, the knowledge that enabled it under stress to make gun-cotton from wood and air, to conserve its fats for food by making glycerine from starch, to fire a shell seventy-five miles, and to do a great many other marvellous things in the mastery of matter. I have not heard of any direction in which our late enemies could be charged with faults attributable to a neglect of technology. On the other hand, there is abounding evidence that without it they would have been defeated in a year. The tale of the forced march of our own technology in this war of chemists and engineers has not yet been fully told, and perhaps its triumphs are only dimly understood.

In the face of all this it would be excusable perhaps to make this the occasion to preach the urgency of technology. But that is not my intention; I am far more anxious to raise my voice against its unbridled pursuit, to direct attention to the restraints under which it should be fostered, and to plead for what seems indispensable to its worth.

Whatever may have been the ultimate source of German decadence, it has proceeded step by step with changes of outlook, of aim, and of organisation in education that were of melancholy significance to those who had any knowledge of the Germany of old. The reproach was not in their becoming a race of technologists, but in their education from beginning to end yielding to the domination of a spirit which set above all else the worship of power and material efficiency. Surely the supreme educational lesson of the war is that we teachers should stand shoulder to shoulder against all the forces that tend to the vitiation of the atmosphere of education and to the desecration of our temples of learning.

¹ From a paper read before the Congress of the Universities of the Empire at Oxford on July 6.

² Prof. H. B. Dixon, Address to Section B, British Association Reports, 1894 (Oxford), p. 596.

Unaltered as is my eagerness for the promotion of technological studies and undiminished my belief in their university rights, I can therefore, and do at the present time, listen at least with patience to alarmist voices more than hinting at the elimination of technologies from our universities. It is more grateful to the ears than some other prescriptions coming from advisers who would act on the precept that it is lawful to learn from the enemy, but would, it seems, have us learn just the wrong thing.

But we must be careful not to be thrown off our balance by a laudable emotion. It is perfectly certain that our national circumstances require, and will require in an increasing degree, the application of the highest knowledge to the industrial arts. An increasing proportion of those endowed by Nature with the best brains and the strongest elements of character will be absorbed by industry, simply because the maintenance of industry is a condition of existence, and its maintenance becomes more and more exacting of both mind and character.

The tendency of those who are so susceptible to anything that seems to threaten a depreciation of university life to say, "Let industry have the brains it wants, get them trained how it wants, and where it chooses—*anywhere but here*," seems to me a fatal closing of the eyes to what is written in blood on the pages of recent history.

Not less wrong, in my opinion, are those who still maintain that the universities have done their whole duty when they have provided the unspecialised studies that are fundamental to industrial science. We know, indeed, that these are all-important, and that men well trained in them, if properly used, will learn elsewhere in the end effectively to apply them. But that there exist ranges of special knowledge, essentially high science, lying between the abstract sciences and the mechanical arts, and that a training in this knowledge may be organised to great advantage in teaching institutions, will not be disputed by anyone who has regarded the evidence at hand. Certain it is that these so-called technologies will be taught somewhere, just as the specialised high studies of theology, law, and medicine are taught, and where they are taught well, there will they be sought. They will be sought now as never before, and what appears to be the matter most needing consideration in our discussion to-day, the point on which I wish to focus attention, is this: that unless the universities collectively embody enough high technology to meet adequately the prospective demand, we shall inevitably cast a large section of our best industrial manhood into institutions wholly devoted to one type of studies and dominated by aims which, however worthy, are directed to the object of immediate material utility.

I cannot believe that any thoughtful Englishman can now regard such a prospect with equanimity. He has surely realised too well the functions of a true university, and what we must exact from it for the education of our race: that it must be, above all, a centre of life in which we secure the influences that will regard and tend the idealism of youth, that will bring into good fellowship and sympathy young men coming from all quarters, cherishing every kind of healthy interest and going out into the world to every kind of legitimate pursuit. It must be a community where traditions of honour and high aims are created and impressed, and where no study is at home that is not fraught with a continually disinterested exercise of the mind.

"It is pledged to admit," says Newman, "without fear, without prejudice, without compromise, all comers, if they come in the name of Truth; to adjust views, and experiences, and habits of mind the most independent and dissimilar; and to give full play to

thought and erudition in their most original forms, in their most intense expressions, and in their most ample circuit. Thus to draw many things into one is its special function."

It must be, in short, the place that Milton conceived as giving the "compleat and generous education that fits a man to perform justly, skilfully, and magnanimously all the offices both private and publick of Peace and War."

It is in such an environment surely that we must educate as many as we can of those who are to be the guiding spirits of the working world.

It has, I believe, seemed to many of us here, and certainly to some in the country itself, that the technological universities of Germany, the much-vaunted "*Technische Hochschulen*," have, in the field of education, been strikingly symbolic of a change of spirit in that nation. True it is that they have not usurped the very name of "university," but they made pretensions and acquired prestige and powers that in effect gave them an equal place, or even a prior one, in the esteem of their country. The German, it is true, has never abandoned his formal homage to the older university ideal, just as he has maintained in external form, over much of his educational system, the discipline of what are called "humanities." We have found the modern German still in a way informed in things intellectual, moral, and aesthetic, but we have felt that this equipment was becoming more and more a conventional outer garment, according less and less with the spirit it enveloped.

Nothing has happened that can rightly lead the Germans to relax their cultivation of technology, but among the signs of their regeneration we shall surely look for the return of a true allegiance to their older ideals of universities and all they must stand for in the scheme of a truer civilisation. They must acknowledge that there is something in university life transcending in importance the achievement of efficiency, and that the first care of the nation should be to see that its education proceeds where influences prevail that will touch the spirit of youth to right ambitions and ideals of life. Among the excesses of regimentation the Germans have, I think, good cause to reconsider their educational plan of isolating seminaries of technology.

If thus, in the light of recent history, I am brought to plead more earnestly than ever for the ranging of this set of studies for their own sake within the university, it is in no spirit of condescension or without a strong conviction that they have much to give as well as to gain. It has been my own fortune to live in a university which, perhaps more than any other, has made ventures in the domain of technology and has sought to bring into an articulated and harmonious whole, without preference or priority, without caste social or intellectual, on equal terms and with equal rights, the studies, teachers, and students concerned with both professional and industrial occupations. I do not know that there is one among our teachers who would not acknowledge advantage from this association and bespeak from it, when rightly achieved, a broadening rather than a narrowing influence on the best elements of university life.

I hope I am not insensible to the safeguards that must be observed. A tendency to extravagance lies in every new movement, and in relation to technology it is most important that there should be restraint of ill-considered plans. These safeguards I endeavoured to outline when speaking on this theme at the congress nine years ago. It is perhaps permissible again to urge that the universities should observe a due proportion and economy by differentiation in their technologies according to the natural homes of these, that they should study co-operation

in policy and encourage interchange of students. More important still as an actual need of the day seems to be this: that universities which associate themselves with technological institutions of originally independent growth shall bring the studies, teachers, and students effectively into the precincts and life of the university. Equally important does it seem that this should be done so far, and only so far, as these studies, teachers, and students can be rightly regarded as conforming to the standards of a university. It is to be feared that there lie here practical problems of grave difficulty, and that we may be entering upon a troubled time. The difficulties for the universities lie mainly in the suspicion, which they so easily incur, of possessing all those failings that are apt to beset aristocracies, and when they are prescribing restrictions in the light of experience and with a disinterested desire for the common good; they may easily enough be regarded as acting merely in a disdainful spirit of exclusiveness. Another danger, of course, lies in an eager spirit of accommodation, a disposition to please the multitude, and a love of peace, amid which essentials may be sacrificed to gain the mere semblance of success.

In the restlessness of our present world it is difficult to gauge the currents of opinion that will mould or

remould the institutions of our country. But so far as education is concerned it seems clear that, if we are to accept their spokesmen, the rank and file of the teeming world of labour have set their heart in something like clear purpose to the ends that shall be sought. They will not have it that their new and increased education shall be permeated and dominated by a sordid or material aim. They begin to suspect the agencies that make their chief promise a clever performance of the daily task or the earning of a larger wage. In their revulsion from such an object they threaten to repudiate what in truth in its proper place, among other things, will lighten and enlighten their labours.

There is no sign of the times that to me seems more hopeful, for I see in it the promise of an end to the far-reaching and incalculable mischief that has come of a false distinction between useful and useless knowledge. But there are opposing forces to contend with.

It seems to me that there is no service of universities more needed now than to exhibit in the centres of highest education, which can so easily lead the way, the true intellectual nurture of industrial life—the embodiment of technology in full and fruitful fellowship and interplay with accepted liberal studies.

New Apparatus for Showing the Tracks of α -, β -, and X-rays.

IT will be remembered that Mr. C. T. R. Wilson described his original cloud expansion apparatus as used for showing the tracks of α - and β -rays and of X-rays before the Royal Society in April, 1911, and at that time the Cambridge Scientific Instrument Co., Ltd. (now the Cambridge and Paul Instrument Co., Ltd.), took up the manufacture of this apparatus. The manufacture of apparatus of this class was, however, entirely stopped by the war.

Lately Mr. Takeo Shimizu, of Japan, working at the Cavendish Laboratory, Cambridge, has considerably modified Mr. Wilson's original apparatus, and the Cambridge and Paul Instrument Co., Ltd., is now putting the improved design upon the market. In Mr. Wilson's original apparatus only a single expansion was obtained. It was thought to be necessary to give a comparatively rapid expansion in the working chamber, and this was obtained by connecting the space under the moving piston to another space which was previously evacuated. The moving piston was, in consequence, suddenly sucked down against a rubber stop. Mr. Shimizu has found that the sudden expansion is not necessary, and has, therefore, arranged for a reciprocating piston, and he obtains cloud tracks of the rays at each expansion, which may be timed to occur at rates from about 50 to 200 per minute. The instrument thus designed is extremely simple, but there are several important points to which attention must be given for successful operation.

The apparatus is shown in Fig. 1. The crank (not seen in the illustration), which is driven either from the hand-wheel B or by means of a small motor, drives an upright connecting rod, which in turn drives a horizontal connecting rod D. The far end

of D slides in a sleeve E, which is free to rock in the piece F. The piece F can be adjusted in a horizontal direction by means of the screw G. The piston-rod H is connected near the middle of this latter connecting-rod. Since the crank is of constant length, the horizontal adjustment of the piece F alters the length of the stroke given to the piston-rod H. By this means the expansion ratio at each stroke in the working

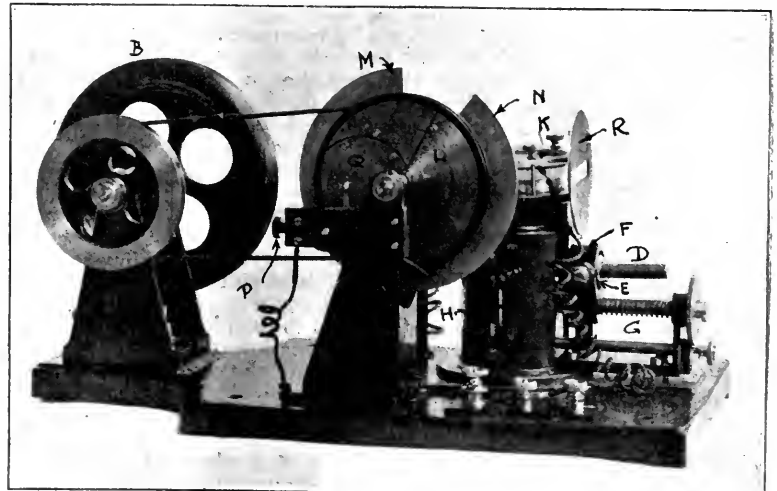

FIG. 1.—Shimizu expansion apparatus.

chamber K can be adjusted while the instrument is in operation.

In order to obtain a good picture of the rays which become visible at each expansion by the formation of linear clouds on the ionised particles in the ray tracks, it is necessary that these clouds be dissipated during the compression stroke. This is done by forming a vertical electrostatic field in the expansion

chamber. The upper glass plate of the expansion chamber, through which the tracks are observed or photographed, is covered on the inside with a gelatine film, which is made conducting. This film is charged negatively with reference to the metal piston, but by means of the commutator L, which rotates with the driving crank, the plate is discharged just before the occurrence of the cloud formation. In the same way as the expansion ratio can be adjusted while the instrument is running, so the length of the period during which the electric field is cut off can also be adjusted while the instrument is running by means of the screw P, which traverses the contact brush along the commutator L, which is shaped, as will clearly be seen in the illustration, in the manner required to give this adjustment. Also rotating with the crank are two adjustable lead segments, M and N, which can be used as shutters for admitting X-rays to the expansion chamber at the proper intervals. It is on the back of the disc carrying these segments that the commutator L, above described, is fitted.

The expansion chamber is fitted with a small tube, by means of which radio-active matter can be introduced into the chamber for the production of α - or β -rays. The present chamber is made 55 mm. in diameter, which is, of course, less than the length of the tracks of some of the α -rays in air, but the

velocity of the α -rays can be reduced by passing them through a mica screen. A small screen can also be placed on the piston to cut off the α -rays, except at the moment of greatest expansion. The expansion chamber must be perfectly airtight, as the minutest lag produces eddy currents, which at once destroy the tracks. The instrument is very quickly set up and easily operated, as a few expansions serve to filter out any dust originally in the air. The piston forming the floor of the expansion chamber is covered with a comparatively thick layer of gelatine containing about 10 per cent. of Indian ink. This gives a good black background, against which the tracks show up brilliantly. For demonstration purposes a Pointolite lamp gives excellent results, but for photography a rather more brilliant lamp is desirable. The apparatus is illuminated by means of a parallel beam of light coming in on the left-hand side. The screen R cuts off all light, except a small rectangular pencil passing through the middle of the expansion chamber.

Mr. Shimizu has taken some stereoscopic pictures on kinematograph film with his original apparatus, and by means of these stereoscopic pictures the exact paths of the particles in space can be calculated. The Cambridge and Paul Instrument Co., Ltd., hopes shortly to bring out a suitable stereoscopic camera as an accessory to the expansion apparatus.

Scientific and other Aspects of Beer.

ADRIAN BROWN, the first professor of the first established university school of brewing in this country, died nearly two years ago, and no one more suitable than Prof. Armstrong could have been chosen to pay a tribute to his memory.¹ Prof. Armstrong's enthusiasm for the application of chemistry to biology is undimmed by age; his memories and friendships reach back further than most men's, and (may it be added in a scientific journal?) he has a fine appreciation of the glories of beer. He feels he has observed what would have been Adrian Brown's wish, in making his eulogy be "less of the man than of the yeast-cell," more of the school than of the teacher. After some biographical details and personal reminiscences going back to the 'sixties, he discusses Adrian Brown's scientific work, placing that on the barley-corn first. There is a variety with a blue layer of cells underlying the thin outer skin of the corn; the blue colouring matter behaves like litmus, and is turned red by acids; yet when the grains are soaked in dilute acid they remain blue, for only water enters. This discovery enabled Adrian Brown to study a semi-permeable membrane in a living object and to examine the behaviour of a large number of substances towards it. Water is absorbed from a saturated salt solution, but the more dilute the solution the more rapidly is water taken up. Sugar, strong acids, and strong alkalis also give up the water in which they are dissolved without entering themselves. On the other hand, weak acids, also weak bases, such as ammonia, and chemically neutral substances, like alcohol and chloroform, readily pass through the membrane. Prof. Armstrong suggests that only the simple "hydrone" molecules of water, which alone are considered by him to have the formula H_2O , penetrate the membrane; complexes like H_2O_2 and H_2O_3 are held back. Cane-sugar is held back by the membrane of the barley-corn, yet it passes through the walls of the yeast-cell!

¹ Adrian Brown Memorial Lecture, "The Particulate Nature of Enzymic and Zymic Change." By Henry E. Armstrong. Delivered at Birmingham University on February 18. (Journ. Inst. of Brewing, 1921, vol. xxvii, pp. 197-250.)

Brown's investigation of the oxidative action of *Mycoderma aceti* and *B. xylinum* leads Prof. Armstrong to an account of Bertrand's work on the bacterial oxidation of sugars; similarly his researches on enzymes lead to a review of older and newer work on heterogeneous catalysis, the kinetics of enzyme action, and the mechanism of alcoholic fermentation.

But chemists who know the lecturer and are already more or less acquainted with the ground he covers will turn with the greatest interest to the section on "Beer as a Dietetic." Fortified by quotations from Calverley and from Prof. Saintsbury's recent "Notes on a Cellar-Book," he inveighs against State regulation of the brewing industry and against prohibitionists. It may have been stern necessity, but Government control has rendered beer "little short of worthless as a drink." Lord D'Abernon's committee does not escape, and is accused of verbal quibbling in its report. "The most malign of the attempts to influence opinion is probably that of the Board of Education, in the form of the syllabus of 'Lessons on the Hygiene of Food and Drink for Use in Schools and Notes for the Assistance of Teachers,' issued over the name of Sir George Newman." Later Prof. Armstrong calls out: "Is all æsthetic pleasure to be taken out of life? Are we to treat our food with the contempt we show to the coal we cast upon the fire? Are the views of an entirely selfish, unthinking minority to prevail?" And then comes his answer: "No, I believe our philosophy to be summed up in the familiar lines:—

Man wants but little here below,
But likes that little good."

After this we go back once more to science, to a historical review of the science of brewing. The debt we owe to Pasteur is sympathetically explained to a general audience, but those who are already acquainted with the work of the great Frenchman will perhaps learn most from the survey of the "Burton period" and the author's reminiscences of Henry Böttinger, Horace and Adrian Brown, Peter Griess, and O'Sullivan. This chapter in the history of English chemis-

try, or rather of chemistry in England—for the Browns are the only Englishmen in it—should be read by the younger generation of to-day. Two photographs show us the now unfamiliar features of Griess and of O'Sullivan.

Finally, Prof. Armstrong gives us his views on the best methods for promoting biological inquiry and on the research scheme of the Institute of Breeding. Much of what he says about this is of wider application, and bears on scientific research in general. His

views, expressed with great conviction, should be especially considered at the present time, when all kinds of new research schemes are being started. Some of us cannot always agree with Prof. Armstrong, but we must all recognise that, if provocative, he is stimulating; if a fighter, he is sincere. And he is also picturesque; he does not bore us. Hence this memorial lecture derives a personal interest from the author no less than from his subject, and thereby its value has been increased.

The Ancient and Modern Inhabitants of Malta.

AT a meeting of the Royal Anthropological Institute held on June 28, Mr. L. H. Dudley Buxton read a paper on "The Ancient and Modern Inhabitants of Malta." The paper was a summary of the results of a small anthropological expedition from Oxford which visited Malta in the winter of 1920-21. The expedition was made possible by the generosity of Sir Alfred Mond and by a grant from the Mary Ewart Trust. The work in the island was offered every facility by the Governor, Field-Marshal Lord Plumer, and his staff, and Prof. Zammit, the Rector of the University, put his unrivalled knowledge of all things Maltese at the service of the expedition.

The history of Malta is bound up with its geographical position, lying as it does on a buttress of the old land bridge between Africa and Sicily. The cave of Ghar Dalam, which is being explored by Mr. Despott, may throw considerable light on man's early history in the island. At present, however, the earliest large collection of human remains belongs to the Neolithic, or more probably *Æneolithic*, age of the great Maltese megalith builders. Although this culture is, to a certain extent, unique, it offers possible comparison with the *allées couvertes* of Western Europe. The site of Bahria, which has not yet been properly excavated, may provide a link between the Neolithic and the Bronze ages, remains of which have been discovered actually on top of the Neolithic remains at Hal Tarxien. The following periods, the so-called Phœnician or Punic, show a close connection with North Africa—a connection which was not broken until the Roman occupation. At the division of the Empire in A.D. 395 Malta was allotted to Byzantium, to which it belonged ethnologically. It was held successively by the Arabs and by the various occupants of the throne of Sicily until handed over by Charles

Quint to the Knights of St. John of Jerusalem in 1530. The Knights held it until 1798, when they were dispossessed by Napoleon. It was occupied by the British in 1800, and formally annexed in 1814.

The megalith builders appear to belong to what is generally known as the Mediterranean race. They show close affinities to the inhabitants of North Africa and Sicily. Probably at the close of the Bronze age—but the exact line is as yet uncertain—a crucial change came over the population and a new type of folk appeared, the contour of whose cranial vault suggests Armenoid characters. In spite of the constant infusion probably of North African blood in Punic times and of Italian during later periods, this type has survived in the islands of Malta and Gozo until to-day.

A study of the modern people shows several remarkable facts: first, that though there are significant differences between the Maltese and the inhabitants of Gozo, there is practically no difference between the inhabitants of the urban and rural districts taken as a whole. The inhabitants of Valetta and the suburbs, contrary to expectation, do not show more variation than the country districts. Two villages, Zurrico and Siggewi, each taken singly, showed as great, if different, variations from the urban districts as did the men of Gozo from those of Malta, but here again the people of tiny and, to a large extent, endogamous villages were only slightly less variable than those of a cosmopolitan port.

It may be said then that, generally speaking, and subject to certain reservations, the Maltese present a well-marked racial type—unlike their nearest neighbours except in Neolithic times, and much more alien to the Cretans and the inhabitants of the "Islands of the Sea."

The Rothamsted Experimental Station.

VISIT OF COUNTY AGRICULTURAL COMMITTEES.

ON Friday, July 15, representatives of the county agricultural committees and directors and principals of the agricultural colleges visited the Rothamsted Experimental Station at the invitation of Lord Bledisloe, chairman of the Lawes Agricultural Trust Committee, and Dr. E. J. Russell, director of the station. They were met by Sir David Prain, Prof. H. E. Armstrong, of the committee of management, and Messrs. T. H. Riches, Leonard Sutton, and other members of the Council of the Society for Extending the Rothamsted Experiments. No more representative party has visited Rothamsted since the great jubilee celebrations of 1893, after fifty years of work had been accomplished. The visitors inspected the plots and the laboratories, and saw practically the whole of the work which is being carried out.

The Rothamsted Experimental Station has expanded considerably during and after the war, and it now has

a permanent scientific staff of twenty-six members, in addition to skilled assistants for records, library, and office, and an outdoor staff for the farm and experimental plots. The scope of the work has expanded, and now includes the soil and the growing plant in health and disease. In the main the work falls into two great divisions, carried out respectively in the laboratories and in the fields, with the pot-culture house serving as a close link between them.

In welcoming the visitors Lord Bledisloe stated that this gathering was typical of many which it was hoped to arrange in future years, and its purpose was to make the work of Rothamsted known to those most intimately associated with the development of British agriculture. The most hopeful method of helping the farmer was to furnish him with knowledge about the crops and soils with which he has to deal, and to carry out tests which he could not possibly do for himself. Lord Bledisloe referred

particularly to some of the recent Rothamsted experiments, showing that the addition of chalk to the soil caused so marked a disintegration that the drawbar pull on the tractor was reduced from 1500 lb. to 1300 lb. for the three-furrow plough, thereby reducing the consumption of fuel and the wear-and-tear.

Sir Daniel Hall described the relationships between research stations and the college and farm institutes on the one hand, and the county advisers on the other. He impressed upon his hearers the fact that much of the work of an experimental station could have no immediate practical application, and yet it was absolutely essential for the development of agricultural science and for further advances in agricultural practice. He described the great changes that had taken place in the past fifteen years in the attitude of Government departments towards research work, and to the broader and more enlightened outlook on the part of the general public.

Dr. Russell described the work of the station, and emphasised the fact that its purpose is first to obtain trustworthy information about the soils and growing plants, and then to put this information into such a form that teachers and experts can use it. Among recent developments to which Dr. Russell referred are the statistical department, where elaborate and extensive Rothamsted data are examined by modern statistical methods, and the work on cultivation which is now being carried out by the physical department and the farm.

University and Educational Intelligence.

DURHAM.—The following honorary degrees were conferred upon members of the British Medical Association on July 21:—*Doctor of Civil Laws*: Sir William MacEwen, Sir Thomas Oliver, and Sir Humphry D. Rolleston. *Doctor of Hygiene*: Dr. T. E. Hill and Dr. J. W. Smith. *Doctor of Science*: Sir Arthur Keith. *Doctor of Literature*: Sir Dawson Williams, editor of the *British Medical Journal*. M.A.: Dr. Alfred Cox, medical secretary of the British Medical Association.

LONDON.—Mr. M. T. M. Ormsby has been appointed as from August 1, 1921, to the Chadwick chair of municipal engineering tenable at University College. Mr. Ormsby was appointed assistant to Prof. Osbert Chadwick at the college in 1898, and since 1914 has been University reader in surveying.

Dr. F. S. Langmead has been appointed as from August 31, 1921, to the University chair of medicine tenable at St. Mary's Hospital Medical School. Dr. Langmead has held a number of posts at St. Mary's Hospital since 1902, also at the Hospital for Sick Children and at the Seamen's Hospital, Greenwich.

The Rogers Prize of 100l. for 1921 has been awarded to Mr. Lambert Rogers for an essay entitled "The Surgical Treatment of Hyperthyroidism."

The following doctorates have been conferred:—*D.Sc. in Physics*: Mr. Lewis Simons, an internal student, of King's College, for a thesis entitled "Contributions to the Study of Energy Transformations when X-radiation is absorbed by, or emitted from, a Substance." *D.Sc. (Engineering)*: Mr. K. C. Chalko, an internal student, of University College, for a thesis entitled "Stresses in Chain Links." *D.Sc. in Botany*: Mr. Birbal Sahni, an external student, for a thesis entitled "The Structures and Affinities of *Acomphyle Pancheri*, Pilger." *D.Sc. in Chemistry*: Mr. W. C. Reynolds, an external student, for a thesis entitled "On Interfacial Tension." *D.Sc. in Geology*: Mr. L. F. Spath, an external student,

for a thesis entitled "On Cretaceous Cephalopoda from Zululand," and other papers; and Mr. L. D. Stamp, an external student, for two theses entitled "On the Beds at the Base of the Ypresian (London Clay) in the Anglo-Franco-Belgian Basin," and "On Cycles of Sedimentation in the Eocene Strata of the Anglo-Franco-Belgian Basin."

THE Trustees of the Beit Fellowships for Scientific Research, which were founded and endowed in 1913 by Sir Otto Beit in order to promote the advancement of science by means of research, have recently elected to fellowships Messrs. H. L. Riley and W. A. P. Challenor. Mr. Riley was educated at the Keighley Trade and Grammar School, 1910-17, and has been a student at the Imperial College of Science and Technology from 1919 to date. Mr. Challenor was educated at Whitchurch Grammar School, 1911-17, and has been a student at the Birmingham University from 1917 to date. Both will carry out research at the Imperial College of Science and Technology at South Kensington.

It was announced in NATURE of July 7, p. 604, that Mr. H. H. Wills had presented the University of Bristol with the sum of 200,000l. for the provision of a new physics laboratory. Further particulars have now been received. Two gifts totalling 200,000l. were received, and the Council of the University has now approved plans and signed a contract for the erection of a building. It is estimated that the work will absorb the whole of the original gifts, together with the interest on the fund, amounting to 21,000l., which has since accrued. The Council has further decided to associate the name of Mr. Henry Wills permanently and for all time with the department by naming the building "The Henry Herbert Wills Physical Laboratory." In this Bristol is following the precedent of other universities in associating the name of the donor with a laboratory erected by him for a particular subject. The building, which is Early Renaissance in style, will be a four-floor structure in the shape of the letter "L," to be erected on the north-east side of the Royal Fort Estate. The architects have been most successful in securing both architectural beauty and all the facilities of light and other special requirements demanded by a science department. When it is erected Bristol will possess the best building for teaching and research work in physics in the world. The total amount contributed to the University of Bristol by various members of the Wills family now exceeds 900,000l.

SIR MICHAEL SADLER, Vice-Chancellor of the University of Leeds, in the course of an address after opening the new buildings of the Community of the Resurrection at Mirfield on July 16, said that modern civilisation was one of the colossal facts in the world's history. It had been achieved by the courage and labour of Western men during four centuries. Its essence was power. Its phases had been the power of the individual pioneer, the power of the State, the power of the sea, the power of the machine, the power of coal, and the power of high explosives. Through this stupendous outburst of power Providence had permitted a great change in the lives of men and in the outlook of their minds. It had quickened invention; it had flowered in great literature; it had multiplied opportunity; it had created wealth beyond even the dreams of avarice. Of the six most brilliant epochs in human history modern Western civilisation had been one. But now in its heart and conscience there is foreboding. Power, which is the essence of modern civilisation, threatens to destroy it. Three men so typical as Viscount Grey, Mr. H. G. Wells, and the Dean of St. Paul's

warn us that modern civilisation is at the cross-roads of its destiny. Unless, by some deflection of its recent purpose, power can be concentrated upon the constructive works of peace, it will destroy civilisation by war. At this moment the Middle Ages seem to whisper once more the message of an ideal which in modern times most men have discarded or have tried, however wistfully, to forget. In industry men begin to think of the medieval guilds. In art the naive sincerity of the primitive painters inspires some of those moderns whose pictures are religious. In politics men speculate as to the possibility of a Council of the Peoples which may recognise nationhood, but allay its rivalries. We cannot go back to the Middle Ages and become medieval in all our thought and way of life. But it is possible that the future may blend some medieval ideas with those derived from the age of power, and that what is perilous in some modern tendencies may be transmuted by a rediscovery of some aspects of truth better known to the medieval than to the modern mind. To the medieval thinker three mysterious powers sustained, by their harmonious working, the life of Christendom. They were called the priesthood, the Empire, and the university: Sacerdotium, Imperium, and Studium. For all three in a form adapted to modern needs the modern world may find a place.

THE recent annual meeting of the council of the Association of University Teachers was held at Bedford College, London, and was well attended by delegates from the various university institutions of England and Wales. The president, Prof. John Strong, of the University of Leeds, in his retiring address indicated the general aims of the association, the lines on which it has been working, the progress made, and some of the more important problems opening up. The primary aims were the advancement of knowledge and the furtherance of the interests of the universities. So long as the universities were in difficulties regarding finance, so long would their work suffer. Such questions as teachers' salaries and superannuation were, under present conditions, insistent. The superannuation question had not been settled by the recent grant from the Treasury, nor was the problem of salaries yet solved, although progress towards a solution was apparent. Apart from these, other and equally serious questions were arising. The relation of the universities to the State and to the local authorities would demand more and more serious consideration. While greater financial support from the Government was imperative, the matter of similar and more uniform support from the local education authorities was urgent. The suggestion of a uniform local rate being levied upon all the local education authorities had much to be said in its favour, but, among other things, it would mean increased local representation. Consideration of these points gave rise to the question of the possible infringement of the present autonomy of the universities—a matter of vital importance to the teaching body. Any such possibilities would have to be watched carefully by the universities. The officers and executive committee for the coming year were elected as follows:—*President*: Prof. John Strong (Leeds). *Vice-Presidents*: Prof. McBain (Bristol) and Mr. F. Boulden (Sheffield). *Treasurer*: Asst. Prof. Tabor (Imperial College). *Hon. General Secretary*: Mr. R. D. Laurie (Aberystwyth). *Executive Committee*: Prof. Calder (Manchester), Prof. Dame Helen Gwynne-Vaughan (Birkbeck College), Mr. Haigh (Reading), Miss Halket (Bedford College), Prof. Lea (Birmingham), Prof. Mair (Liverpool), Mr. Monahan (Leeds), Prof. Orton (Bangor), Asst. Prof. Philpot (University College, London), and Prof. Truscott (Imperial College).

Calendar of Scientific Pioneers.

July 28, 1818. Gaspard Monge, Comte de Péluse, died.—The creator of descriptive geometry, Monge was a prominent figure through the whole of the Revolutionary period. He had a great share in founding the Ecole Polytechnique, and, like Berthollet, was a favourite of Napoleon. At the Restoration he was expelled from the Institute on account of his having voted for the death of Louis XVI.

July 29, 1751. Benjamin Robins died.—A mathematician of distinction, Robins invented the ballistic pendulum and carried out a series of experiments which marks an era in the history of gunnery. He died at Madras as chief engineer to the East India Company.

July 29, 1869. Joseph Beete Jukes died.—A favourite pupil of Sedgwick, Jukes became naturalist to H.M.S. *Fly* in Australia (1842-46), and from 1850 was director of the Geological Survey of Ireland.

July 29, 1885. Henri Milne-Edwards died.—Milne-Edwards filled the chairs of entomology, zoology, and physiology at the Jardin des Plantes, studied the natural history of the coasts of France and Sicily, and wrote valuable works on the Crustacea, on the corals, and on physiology and comparative anatomy.

July 29, 1898. John Alexander Renia Newlands died.—One of the first to indicate that the properties of the elements are related to their atomic weights, Newlands practised in London as an analytical chemist.

July 30, 1832. Jean Antoine Chaptal, Comte de Chanteloup, died.—A member of a wealthy family, Chaptal engaged in practical chemistry, and during the Revolution superintended the manufacture of gunpowder. Under Napoleon he served as Minister of Instruction, and did much to further the industrial arts and manufactures of France.

July 30, 1913. John Milne died.—For twenty years professor of geology and mining at the Imperial College of Engineering, Tokyo, Milne made an exhaustive study of earthquakes. He founded the Seismological Society of Japan, invented various instruments, and contributed numerous papers on seismology to the British Association and other bodies.

July 31, 1839. Gaspard Clair François Marie Riche, Baron de Prony, died.—A famous member of the Corps des Ponts et Chaussées, Prony during the Revolution directed the compilation of extensive logarithmic tables. He became a professor at the Ecole Polytechnique, and was employed on many civil engineering works of importance. The Prony friction dynamometer was his invention.

August 1, 1769. Jean Chappe d'Auteroche died.—An assistant astronomer of the Paris Academy of Sciences, the Abbé Chappe d'Auteroche observed the transit of Venus of 1761 at Tobolsk, Siberia, and that of 1769 at St. Joseph, California, where he died of fever brought on by his exertions in the interest of science.

August 2, 1823. Lazare Nicholas Marguerite Carnot died.—Carnot began life as a military engineer. He helped to found the Ecole Polytechnique, and was one of the first members of the Institut de France. His work of 1803, "Géométrie de position," gives him a place beside Monge and Poncelet as one of the founders of modern geometry, and as a military engineer he is remembered for his great work on fortifications.

August 3, 1770. Guillaume François Rouelle died.—As professor of chemistry in the Jardin du Roi, Rouelle attracted much attention by his lectures and his new ideas. Lavoisier and Proust were among his pupils.

Societies and Academies.

LONDON.

Faraday Society, June 22.—Prof. A. W. Porter, president, in the chair.—C. J. **Smithells** (for the Research Staff of the General Electric Co.): High-temperature phenomena of tungsten filaments. Part i. Two types of tungsten wire are in general use for lamp filaments. One is composed of pure tungsten, and the other of tungsten containing up to 1 per cent. of a refractory oxide such as thoria. The crystal growth during burning has been investigated for both types. It is shown that the deformation of the filament which occurs during life is a function of the crystal growth. Crystal growth, which is suppressed in thoriated filaments, occurs when the thoria is reduced. Thoria and other refractory oxides can be reduced by phosphorus vapour at a high temperature. Part ii. deals with the chemical reactions which occur in gas-filled tungsten filament lamps when traces of the common gases are present in the filling gas.—E. **Hatschek**: A simple apparatus for determining the coagulation velocity of gold sols. The percentage of blue formed in coagulation of red gold sol is taken as a measure of the degree of coagulation. The percentage is determined by comparing the original red sol with a double wedge, one half consisting of the original sol, and the other of the completely coagulated blue sol. It is necessary that the latter should be coagulated by the same electrolyte as that used in the sol under examination, as the blues obtained with different electrolytes are not exactly alike. A number of determinations have been compared with V. Smoluchowski's formula for the coagulation velocity, and show good agreement for complete and fairly rapid coagulation.—Prof. A. W. **Porter**: The variation of surface tension and surface energy with temperature. Any satisfactory formula must correspond with the vanishing of both the surface tension σ and the surface energy u at the critical point. The connection is $u = \sigma - T \frac{\partial \sigma}{\partial T}$; hence $\frac{\partial \sigma}{\partial T}$ must also vanish at the critical point. These conditions are all satisfied by the formula put forward by van der Waals, and afterwards by Allan Ferguson, viz.

$$\sigma = \text{constant } (T_c - T)^n,$$

where n is a constant between 1.2 and 1.3. Whittaker has shown that u is proportional to $T \times$ internal latent heat. The author shows that if the reduced temperature be taken as the factor (instead of T), the numeric values show that for many substances u and the internal latent heat of evaporation tend to equality (on the C.G.S. system) as the temperature is approached. He also directed attention to the connection between van der Waals's equation for σ and Thiesen's equation for the latent heat, $\sigma = \text{constant } (T_c - T)^m$, where m is about 0.3.—S. M. **Neale**: The influence of solvent upon ionisation and the accompanying heat effect. A determination by electrical conductivity methods of the ionisation of picric and *paranitrobenzoic* acids in mixtures of acetone and water. From the values obtained at 25° and 35° C. the heats of ionisation are calculated. In the case of picric acid the heat of ionisation varies largely with the nature of the solvent, passing through a minimum at about 70 per cent. acetone. In the case of *paranitrobenzoic* acid the heat of ionisation is sensibly zero both in water and in 44 per cent. acetone, although in the latter solvent the ionisation constant has fallen to 1/20th of its value in pure water as solvent.—A. **McKeown**: The potential of the iodine electrode and the activity of the iodide ion at 25° C. The potential of the saturated

iodine electrode in combination with the normal calomel electrode has been measured for various values of the concentration of the iodide ion. The results have been compared with those of other investigators, making use of the concept of activity coefficient; the activities of the iodide and of the tri-iodide ion in the various solutions have been estimated and compared with the values of the concentration of these ions. It is found that the activities of both ions increase less rapidly than their concentrations. From the results the normal potential of the iodine electrode is calculated to be +0.2454 volt, the normal calomel being taken as zero.

PARIS.

Academy of Sciences, July 4.—M. Georges Lemoine in the chair.—The president announced the death through a motor-car accident of Jules Carpentier, free member.—G. **Lemoine**: The mutual reaction of oxalic acid and iodic acid. The influence of different catalysts. As catalysts, platinum sponge, platinum black, wood charcoal, and sugar carbon were used. In general, for the same reaction velocity a higher temperature was necessary in the absence of a catalyst. Increasing the weight of catalyst increased the reaction velocity, but this was proportional neither to the weight nor to the surface. The activity of the platinum black was very great in proportion to the other substances.—A. **de Gramont**: Spectra of quantitative sensibility of silicon in fused salts and in steels. Working with fused salts, two characteristic lines of silicon persist down to a content of 0.005 per cent. of silicon. With steel, the sensibility is less on account of the brightness and number of the iron lines.—P. **Sabatier** and B. **Kubota**: The action of heat on allyl alcohol in presence of various catalysts. There are two main reactions, dehydrogenation and dehydration; copper and manganous oxide especially effect the first of these, and tungstic acid, thoria, and alumina the second. With zirconia and uranic oxide both reactions occur together. Owing to secondary changes the final product is very complex, and contains water, acrolein, propyl aldehyde, higher aldehydes formed by condensation, and hydrocarbons (mesitylene). The gases include propylene, hydrogen, carbon monoxide, and dioxide, but neither acetylene, allene, nor allylene could be detected.—B. **Gambier**: Imaginary surfaces applicable to a surface of revolution; real corresponding cyclic systems.—D. **Riabouchinski**: The cyclic movement of a liquid round a solid which moves parallel to a rectilinear wall.—J. **Mascart**: Observation of the occultation of Venus of July 1, 1921, made at the Observatory of Lyons. Observations were made under good atmospheric conditions by six observers with different types of instrument.—E. **Belot**: The law of rotation of the sun explained by evolution and flattening of the proto-sun.—M. **Brillouin**: Bohr's atom. The circumnuclear Lagrange function.—A. **Lafay**: The figures of M. de Heen and the electric discharge.—M. **Solomon**: A radiological ionometric arrangement. A description of an apparatus for the measurement of ionisation in medical radiology. It is standardised by a known quantity of radium.—A. **Dauvillier**: The principle of combination and the absorption lines in the X-ray spectra.—A. **Marcelin**: Surface tension of the mono-molecular layers.—A. de G. **Rocasolano**: Variations of catalytic power in the electroplatinosols.—G. **Tanret**: An ammonium molybdo-quinat. Quinic acid is known to show a marked increase in rotatory power when mixed with solutions of molybdates. This is due to the formation of a definite complex compound, ammonium molybdo-quinat, the isolation and analysis of which are described.—J. **Cvijić**: The correspondence

of the fluvial steps and river-banks.—R. **Souèges**: The embryogeny of the Labiates. Development of the embryo in *Glechoma hederacea* and in *Lamium purpureum*.—P. E. **Pinoy**: The germination of the spores, the nutrition, and the sexuality of the Myxomycetes.—Mme. Z. **Gruzewska**: The mucilaginous substances of *Laminaria flexicaulis*. Nitrogen does not appear to be an essential constituent of the mucilage; hydrolysis is slow, the sugar formed being glucose or galactose.—G. **Bertrand** and R. **Vladesco**: The variation in the proportion of zinc in the organism of the rabbit during growth. The proportion of zinc contained in the entire body of the rabbit is a maximum at birth, diminishes during the period of lactation, and then, after the twenty-fifth day, on weaning, the zinc increases rapidly.—H. **Bierry**, F. **Rathery**, and Mlle. **Levina**: The proteid sugar in cancerous subjects. The amounts of free sugar and proteid sugar in the blood-plasma of ten cancerous subjects have been determined. The proteid sugar is from twice to four times the normal amount.—M. **Aron**: The existence and rôle of an endocrinian tissue in the testicle of some Batrachians.—C. **Pérez**: A new Cepenian, *Onychocepon harpax*, a branchial parasite of Pinnotheres.—H. **Faès** and M. **Stæhelin**: The resistance of the adult cockchafer to low and high temperatures. The adult cockchafer can be submitted to a temperature down to -8°C . and recover its activity on warming; at lower temperatures it is killed. This insect is more susceptible to high temperatures, since at 45°C . it is killed.

BRUSSELS.

Royal Academy of Belgium, January 8.—M. A. **Gravis** in the chair.—A. **Demonlin**: The equations of Moutard with quadratic solutions.

February 5.—M. G. **Cesàro**, president, in the chair.—C. **Julin**: Report of the decisions taken at the meeting of the section of biological oceanography of the International Union of the Biological Sciences.—J. **Massart**: The four steps of sexual conjugation.—P. **Stroobant**: Complementary note on the nature of the temporary stars.—C. **Servais**: A group of three tetrahedra.—P. **Nolf**: The action of chloroform on the coagulation of the blood plasma of birds. Antithrombosine is generally considered the physiological antagonist of thrombine, its function being to neutralise this substance wherever it is in excess. This is not found to be in accord with the experiments described. It would appear that antithrombosine, instead of neutralising thrombine, contributes to its formation.—Th. **de Donder**: The gravific field.—L. **Godeaux**: Researches on the cubic involutions belonging to an algebraic surface.—F. **Carpentier**: The prothoracic endo-skeleton of *Gryllotalpa vulgaris*.

March 5.—M. G. **Cesàro**, president, in the chair.—A. **de Hemptinne**: The law of Faraday, and the action of the silent electric discharge on the metallic oxides. An account of experiments in which the oxides of lead, copper, nickel, and mercury are exposed to the silent discharge in an atmosphere of hydrogen under reduced pressures (10 to 30 mm.).—É. **van Aubel**: (1) The atomic heat of the elements. According to a recent communication by M. Félix Michaud, the atomic heat should have the value $3\cdot5$ for a temperature corresponding to a maximum of the quotient CA/T (where C is the specific heat, A the atomic mass, and T the absolute temperature). An examination of the values for silicon, boron, rhombic sulphur, thallium, magnesium, and chromium shows that these substances are not in accordance with M. Michaud's rule. (2) The density and refractive index of mixtures of aldehyde with water or ethyl alcohol.—C. **Servais**: Quadrics of revolution conjugated to a tetrahedron.—

E. **Henriot**: The variation of the refractive index of liquids with density.

April 9.—M. G. **Cesàro**, president, in the chair.—G. **Cesàro**: Some new forms of orpiment from Balìa, Asia Minor.—C. **Servais**: A curve of the third order associated with a triangle.—P. **Stroobant**: Observation of a shooting star at Brussels.

May 3.—M. G. **Cesàro**, president, in the chair.—M. **Stuyvaert**: An element analogous with a curvature at a point external to a plane algebraic curve.—L. **Godeaux**: Some linear congruences of skew cubics considered by M. Stuyvaert.—P. **Bruylants**: The action of the organo-magnesium compounds on glutaric nitrile. This nitrile behaves as a pseudo-acid, and on acidifying the reaction product nearly the whole of the nitrile is recovered. There is a secondary reaction producing a very small quantity of a ketone, probably $\text{C}_2\text{H}_5\cdot\text{CO}\cdot(\text{CH}_2)_2\cdot\text{CN}$.—H. **Vanderlinden**: The gravific field of an electrified sphere.

ROME.

Reale Accademia nazionale dei Lincei, May 8.—F. D'Ovidio, president, in the chair.—Papers by fellows:—C. **Somigliana**: Depth of glaciers, i. The equations of motion are found for a glacier, and are identical in form with those of a viscous liquid moving slowly in a tube inclined to the horizon. This very natural conclusion is justified by the property that the velocity of the glacier is considerably less than the critical velocity at which fluid motion becomes turbulent. It might be suggested, however, to Prof. Somigliana that the cracking of the ice substitutes another effect limiting the applicability of the equations in this case.—F. **Severi**: Integrals of first species, v.—O. M. **Corbino**: Thermal analogue of Oersted-Ampère effect, ii.—Papers communicated through a fellow:—G. **Abetti**: Astronomical determinations of latitudes and longitudes in Central Asia. These were carried out in De Filippi's expedition in 1913-14 by the author and Comdr. A. Alessio, the longitudes being referred to the meridian of the transit circle of Dehra Dun by wireless signals from the Trigonometrical Survey of India. The observations were made at the following stations: In Baltistan at Tolti, Wazul Hadur, Scardu, and Carghil; in Ladak at Lamairu and Leh; in Caracorum at Depsang and the front of the Rimu glacier (altitude 4912 metres); and in Turkestan at Sughèt Carol, Jarcand, and Cashgar.—C. **Perrier**: Presence of zinc in the malachite of Chessy. A comparison of malachite and the new mineral rosasite is given.—C. **Gorini**: Proteolytic activity of lactic ferments, v. Phenomena of rapid physiological mutation.—D. **Maestrini**: Enzymes, vi. Protective power of starches and other substances on phtalin in acid media.—J. **Pérés**: "Transformations qui conservent la composition." A sequel to the author's previous contributions in the *Annales de l'École normale supérieure* and *Bulletin de la Société mathématique de France*, published in 1919.

SYDNEY.

Royal Society of New South Wales, June 1.—Mr. E. C. Andrews, president, in the chair.—A. R. **Penfold**: The occurrence of a new phenol in the essential oils of the Leptospermum. In the course of the examination of the essential oils obtained from *Leptospermum flavescens* growing in various parts of New South Wales, a phenolic body was found to occur in amounts varying from 0.75 to 8 per cent., the latter being obtained from material growing in the Lane Cove (Sydney) district. It has been named "Leptospermol."

Books Received.

Sitzungsberichte der Königl. Böhmischen Gesellschaft der Wissenschaften. Mathematisch-Naturwissenschaftliche Classe. Jahrgang 1915, 1916, 1917. (Prag: Fr. Rivnáč.)

Mémoires de la Société Royale des Sciences de Bohême. Classe des Sciences. Année 1918: Année 1919. (Prag: Fr. Rivnáč.)

Ladislav Pračka. Untersuchungen über den Lichtwechsel Älterer Veränderlicher Sterne. By Prof. Dr. Vojtěch Šafařík. Vol. ii. Sterne des A.G. Kataloges von 5' 21^m bis 24' A.R. Pp. iii+180. (Prag: Fr. Rivnáč.)

North England: An Economic Geography. By L. Rodwell Jones. Pp. viii+256. (London: G. Routledge and Sons, Ltd.) 6s. net.

Textile Design and Colour: Elementary Weaves and Figured Fabrics. By W. Watson. Second edition. Pp. xi+436. (London: Longmans, Green and Co.) 21s. net.

Ministry of the Interior, Egypt: Department of Public Health. Reports and Notes of the Public Health Laboratories, Cairo: No. 4. Nutritive Value and Characters of Rations Issued to Officials and Others in Different Administrations of the Egyptian Government. Pp. v+57. (Cairo: Government Publications Office.) P.T.20.

The Statesman's Year-Book, 1921. Edited by Sir J. Scott Keltie and Dr. M. Epstein. Fifty-eighth annual publication. Pp. xlv+1544. (London: Macmillan and Co., Ltd.) 20s. net.

The Joy of Mountains. By William Platt. Pp. 80. (London: G. Bell and Sons, Ltd.) 1s. 9d.

Fundamental Principles of Organic Chemistry. By Prof. Charles Moureu. Authorised translation from the sixth French edition by W. T. K. Braunholtz. Pp. xviii+399. (London: G. Bell and Sons, Ltd.) 12s. 6d. net.

The Flora of the Nilgiri and Pulney Hill-Tops. By Prof. P. F. Fyson. Vol. iii. Pp. xviii+581. (Madras: Government Press.) 15.6 rupees.

Forestry Commission. First Annual Report of the Forestry Commissioners: Year ending September 30, 1920. Pp. 60. (London: H.M. Stationery Office.) 9d. net.

Air Ministry: Meteorological Office. British Meteorological and Magnetic Year Book, 1910. Part vi.: Réseau Mondial, 1910. Charts showing the Deviation of the Pressure and Temperature from Normal Values for each Month and for the Year. (London: H.M. Stationery Office.) 8s. 6d. net.

Camping and Woodcraft: A Handbook for Vacation Campers and for Travelers in the Wilderness. By H. Kephart. New edition (two volumes in one). Pp. 405+479. (New York: The Macmillan Co.; London: Macmillan and Co., Ltd.) 16s. net.

The Electric Furnace. By Dr. J. N. Pring. (Monographs on Industrial Chemistry.) Pp. xii+485+xix. (London: Longmans, Green and Co.) 32s. net.

Principles of Radio-Communication. By Prof. J. H. Morecraft. Pp. x+935. (New York: J. Wiley and Sons, Inc.; London: Chapman and Hall, Ltd.) 45s. net.

The Silviculture of Indian Trees. By Prof. R. S. Troup. Vol. i.: Dilleniaceæ to Leguminosæ (Papilionaceæ). Pp. lviii+336+iii. Vol. ii.: Leguminosæ (Cesalpinieæ) to Verbenaceæ. Pp. xi+337-783+iv. Vol. iii.: Lauraceæ to Coniferæ. Pp. xii+785-1195. (Oxford: Clarendon Press.) 3 vols., 5l. 5s. net.

The Development of the Atomic Theory. By A. N. Meldrum. Pp. ii+13. (London: Oxford University Press.) 1s. 6d. net.

Brown Bast: An Investigation into its Causes and Methods of Treatment. By A. R. Sanderson and H. Sutcliffe. Pp. 71+26 plates. (London: Rubber Growers' Association, Inc.) 7s. 6d. net.

Growth in Trees. By W. T. MacDougal. Pp. 41. (Washington: Carnegie Institution.)

The Microtometist's Vade-Mecum: A Handbook of the Methods of Microscopic Anatomy. By A. B. Lees. Eighth edition, edited by Dr. J. B. Gatenby. Pp. x+594. (London: J. and A. Churchill.) 28s. net.

A Practical Handbook of British Birds. Part xi. Pp. 177-256. (London: H. F. and G. Witherby.) 4s. 6d. net.

Berichte der Naturforschenden Gesellschaft zu Freiburg i Br. Dreiundzwanzigster Band, Erstes Heft: Erschienen zur Feier des 100 Jährigen Bestehens der Gesellschaft. (Freiburg i Br.: Speyer und Kaerner.)

Insect Pests of Farm, Garden, and Orchard. By E. Dwight Sanderson. Second edition, revised and enlarged by Prof. L. M. Peairs. Pp. vi+707. (New York: J. Wiley and Sons, Inc.; London: Chapman and Hall, Ltd.) 26s. net.

ERRATUM.—The publishers of G. Spiller's "A New System of Scientific Procedure," included in last week's list, are Messrs. Watts and Co., and not Messrs. Chatto and Windus as stated.

CONTENTS.

	PAGE
British Dyes and Dyestuffs	673
A War Memorial	675
The New Medicine	676
Non-Ferrous Metallurgy. By E. C.	677
The Confidences of Men of Science. By The Professor of Biology	677
Our Bookshelf	678
Letters to the Editor:—	
Biological Terminology.—Sir G. Archdall Reid, K.B.E.	680
Solar Eclipse Results and the Principle of Relativity.—C. E. Stromeyer; Sir. F. W. Dyson, F.R.S.	682
The Atomic Radius and the Ionisation Potential.—Prof. Megh Nad Saha	682
American and British Superannuation Systems.—Dr. John W. Evans, F.R.S.; W. Palin Elderton	683
A Novel Magneto-Optical Effect.—Prof. J. W. McBain	683
Science and Civilisation.—J. Henderson Smith and Major A. G. Church	684
Bees and Scarlet-Runner Beans.—Harford J. Lowe	684
A New Theorem on the Double Pendulum.—H. S. Rowell	684
Ochreous Flint Artefacts from Sheringham.—J. Reid Moir	684
The Drought and Underground Water.—Bernard Hobson	684
The Application of Interference Methods to Astronomy. (Illustrated.) By H. Spencer Jones	685
The Paris Conference of the Museums Association	688
Congress on the History of Medicine	690
Notes	691
Our Astronomical Column:—	
The August Meteors	694
Search for Meteors from the Pons-Winnecke Radiant	694
Statistics of Proper Motions	694
The Universities and Technological Education. By Prof. A. Smithells, F.R.S.	695
New Apparatus for Showing the Tracks of α -, β -, and X-rays. (Illustrated)	697
Scientific and other Aspects of Beer	698
The Ancient and Modern Inhabitants of Malta	699
The Rothamsted Experimental Station	699
University and Educational Intelligence	700
Calendar of Scientific Pioneers	701
Societies and Academies	702
Books Received	704



THURSDAY, AUGUST 4, 1921.

Editorial and Publishing Offices:

MACMILLAN & CO., LTD.,

ST. MARTIN'S STREET, LONDON, W.C.2.

Advertisements and business letters should be
addressed to the Publishers.

Editorial communications to the Editor.

Telegraphic Address: PHUSIS, LONDON.

Telephone Number: GERRARD 8830.

Modern Credulity.

DURING the last ten or twelve years there has been a remarkable recrudescence of the amulet, or mascot. Nowadays there must be few collections of jewelry which do not contain at least one piece for luck, whether it be a four-leaved shamrock, an effigy of a pig, cat, or other animal in one of the precious metals, a holed coin inset with a turquoise or other stone, real or imitation, or some similar object to which protective properties are attributed in some degree. It must afford a peculiar joy to Sir William Ridgeway to see his theory of the magical element in primitive jewelry translated into actual practice in civilised conditions. The more grotesque or bizarre the object, the greater the attachment of the owner. Hence the remarkable forms taken by ornaments in china and other material. Nor need the mascot be an inanimate object. Dogs, cats, monkeys, and other animals are pressed into service. In Paris hunchbacks have a regular *clientèle* among stockbrokers, who make a point of touching the deformity before an important deal; while one French actor is said always to have a hunchback in his dressing-room during a first night.

The mascot appeals in particular to those whose pursuits expose them to risk or to the effects of chance. It is quite in keeping that their use

should be particularly prevalent among those addicted to betting and card-playing, among members of the theatrical profession, and among motorists. In the case of the last-named the practice is perhaps more common in France and the United States; but even in this country, at one time, quite a considerable proportion of cars carried a "Teddy" bear, a black cat, a golliwog, or a policeman on the bonnet. The fact that applications have been entered for patent rights in special types of improved mascots and luck-charms suggests a sense of humour not without cynicism in the would-be patentees.

During the war the belief in the efficacy of mascots was both extended and intensified. The Army has always had a certain inclination towards some form of luck-bringer, which, more often than not, is the regimental pet. The goat of the Royal Welsh Fusiliers is perhaps the best-known example. The recognised use of the mascot in the Army, however, is collective rather than personal; and it was the personal use which became so prominent during the war. It extended to the whole community, and not merely to those on active service. There were few into whose lives the elements of luck and chance did not seem to have entered with a tragic significance which was absent before the war.

The mascot is not the only form taken by an interest in the occult. Apart from the serious study of telepathy and other forms of psychic manifestation, as well as the more or less religious belief in faith-healing, there was, before the war, a great deal of half-frivolous and wholly superstitious belief in crystal-gazing, palmistry, and other means of foretelling the future which afforded an opportunity to innumerable charlatans to prey upon a credulous public. During the last few years, for reasons which are obvious, this interest has assumed a more serious character, and a desire, perhaps not consciously realised, to mitigate the loss of an intimate association has intensified the wish to know something of the life after death and to communicate with those who have "passed beyond." As a result, a mass of evidence has been brought forward which, it is maintained, establishes the possibility of communication with the spirits of the departed, and affords some indication of the character and conditions of existence after death. Investigations have been carried a step further. The evidence is no longer confined to the existence of spirits once embodied in human form. To earth-spirits, elementals, poltergeists, and other influences

which are said to have manifested themselves by various means are now added fairies. Not only have fairies appeared visibly to a certain number of individuals, as reported by Sir A. Conan Doyle, but photographs of them have been taken and published in a popular magazine. The truly wonderful similarity between the real fairy or gnome, as photographed, and the conventional fairy of art is a remarkable tribute to the imaginative genius and insight of such artists as Mr. Arthur Rackham. Sir A. Conan Doyle, whom this resemblance has not escaped, would account for it by a tradition of a previous revelation.

It is clear that these beliefs cannot be treated as being all upon the same level. Mascots are undoubtedly largely a result of fashion, and in a number of cases—probably the majority—the owners would deny any faith in their efficacy. They are “just for luck.” The spiritualist, however, holds his convictions with something of the fervour of a religious zealot, yet taking the beliefs as a whole they have one element in common. They represent a reversion to a very primitive point of view.

The revival of the mascot and other forms of the occult has been confined to the upper and well-to-do classes. Among the lower and less educated classes of Europe belief in certain forms of magic has never died out; it goes back to prehistoric times. In the Mediterranean the belief in the evil-eye retains all its old vitality; at Naples, during the current year, an old woman was harried as a witch; and a sheep's head, wrapped in human hair fastened with forty-three large nails, found in her possession, was seized by the police and burned in a church at the request of the excited populace. In the recent elections in Italy a political party of gamblers was formed, also at Naples, of which the chosen representatives were noted for the magical powers which they placed at the service of their clients. In this country the belief in the witch has not died out—in 1906, at Thames Police Court, a reputed witch was convicted of obtaining money by means of a trick, and other cases have occurred since that date. Love-charms and amulets against sickness and misfortune are common. A potato (against rheumatism), an oddly shaped bone, a fossil, a thread of red silk, even a modified phallus in glass or other material worn as a pendant, are objects familiar to the collector. These charms and amulets of the “folk,” in both town and country, are more closely akin to primitive belief and less sophisti-

cated than the mascot; but in both cases the psychological basis is identical.

To the anthropologist it is a commonplace that the belief in the efficacy of charms and amulets, like other forms of magic, rests upon ignorance of the operation of cause and effect. In the primitive mind this arises from an imperfect knowledge of natural forces. The owner of a mascot, though not unaware of the relation of cause and effect, ignores it and hopes to influence favourably antecedent conditions which are beyond his personal control. The desire to learn what conditions will prevail in the future, either from mere curiosity or in order that they may be controlled or utilised, as in a stock-exchange gamble or a bet, is responsible for the clairvoyant, the crystal-gazer, and other forms of fortune-teller. A further point of contact with primitive belief is that the use of the mascot implies faith in its efficacy; it has occult powers, a belief which differs in no way from that of the primitive mind that certain individuals and certain objects have *mana*. In the use of the figure of a policeman as a motor mascot we may even see a form of sympathetic magic; by its means the owner may hope to escape the attentions of the real policeman and the snare of the police trap.

A similar parallel can be drawn in the case of the whole-hearted believer in spiritualism. It requires little more than a superficial acquaintance with primitive animistic beliefs and practices to find their counterpart in the mental attitude and outlook of the modern spiritualist, while the medicine-man, especially when, as is often the case, he is endowed with an abnormal mental constitution and associated with a particular spirit or group of spirits, is the prototype of the medium and his “control.”

To the sociologist this phase of modern credulity is of the greatest moment. Religion, with the attendant moral codes, has, on the whole, proved one of the strongest factors in the preservation of the social structure. Magic, when once it has served its purpose in the development of human society, has usually been antisocial, while spiritualism, at any rate in some of its recent manifestations, contravenes the generally accepted conceptions of religious belief. A certain amount of intellectual scepticism may be regarded as a healthy and necessary element in any society; but should the place of religion be taken by a reversion on any extended scale to a wholly primitive mode of thought, the prospect affords faint hope of social security and progress.

Education and World Citizenship.

The Salvaging of Civilisation. By H. G. Wells.
Pp. 202. (London: Cassell and Co., Ltd.)
7s. 6d. net.

A BOOK by Mr. Wells, and especially a book on education, is always important. "The Salvaging of Civilisation" is no exception. Part of the book has already been published as a separate essay, part of it consists of lectures to an American audience, and a third part was doubtless prepared for the present volume; but it all fits together, because it all belongs to Mr. Wells's remarkably clear and orderly thought.

In his "Outline of History" Mr. Wells has sketched, in amazingly firm lines, the uncertain origins of our race. In the present book he presents, with the same firm touch, our equally uncertain future. It would be tempting to compare Mr. Wells as historian with Mr. Wells as prophet, for this is a prophetic book. It is concerned with the purpose and future of mankind, but with the distant, rather than with the immediate, future. Mr. Wells has gone scouting far ahead of those whose principal concern is with the next step towards international co-operation and world citizenship. In this volume he tells us what he has seen of the distant goal, but he has little to say of the first practical steps towards it. One thing, however, he is sure about. If the goal is ever to be reached, it is education that will get us there. "The task . . . is not primarily one for the diplomatists and lawyers and politicians at all. It is an educational one."

It is true that thought tends always to end in action, and it follows that deeds are the ultimate (and ideas only the intermediate) product of a system of education. The universities, for example, because of their increasing concern with applied science, especially during the war, are realising that their business is not only to discover and to disseminate knowledge, but also to see that practical effect is given to it. The practical effect here in question is no less than the political reconstruction of the world, so that, as Mr. Wells acknowledges, politicians, as well as educators, have a part to play; but "world-wide educational development and reform are the necessary preparations for and the necessary accompaniments of a political reconstruction of the world. The two are the right and left hands of the same thing. Neither can effect much without the other." But in the beginning, and for most of the way, it is the educator rather than the politician that plays the title-*rôle* in Mr. Wells's outline of history yet to be.

If, then, the end of education, like the end of

thought itself, is action, we are not to be educated passively to imagine, but actively to seek, the ideal future for mankind; and our immediate purpose must be "to find release from the contentious loyalties and hostilities of the past which make collective world-wide action impossible at the present time, in a world-wide common vision of the history and destinies of the race." This purpose is to be central and dominant in the outlook that is to result from Mr. Wells's scheme of education. (We remark parenthetically that Mr. Wells's recognition of the supreme importance of purpose in the make-up of character might illustrate, if further examples were needed, how closely many of Mr. Wells's views accord with much that is best in modern thought on education. But there are some of Mr. Wells's opinions that would not obtain assent from those who are most competent to judge. Thus residence and tutorial superintendence were considered by Newman to be of the first importance in university education, but Mr. Wells thinks that an undergraduate of Trinity College, Cambridge, has "no very marked advantage" over an evening student in a northern industrial town.)

Mr. Wells further recognises that, to get things done, there must be unity of purpose among large numbers of men and women, as well as strong purposes dominating each of them individually. "It is manifest that unless some unity of purpose can be achieved in the world . . . the history of humanity must presently culminate in some sort of disaster." But the unity which Mr. Wells rightly demands for the central purposes of men and women the world over, he would also have for a large part of their outlook on the universe. Unity of outlook upon natural science, upon history, and upon literature, as well as upon the aim and purpose of human progress, he would secure by means of common text-books—"The Bible of Civilisation"—always being revised, but always and everywhere in use. Many of his readers will find this suggestion revolting; but they would be ill-advised to reject it without the most careful scrutiny. From many points of view it is far in advance of modern practice. Middle-aged students of mathematics will gratefully remember what Clerk Maxwell called

Hard truths made pleasant
By Routh and Besant
For one who hasn't
Got too much sense.

The codification of elementary applied mathematics by these great Cambridge coaches enormously facilitated the progress of most students who would otherwise have had to depend upon comparatively incompetent teachers and "over-

much tedious lecturing," as Mr. Wells has it. It created, among Cambridge mathematicians, a school of thought that was probably advantageous to their subject as well as to themselves.

But Mr. Wells's scheme of world-wide education, like the national system of education foreshadowed for England in Mr. Fisher's great Act of 1918, depends for its realisation upon the money being available. Mr. Wells has no doubt where the money is to come from; and, in truth, there can be little doubt about the matter. According to a recent American book, the United States spent last year no less than 93 per cent. of the national revenues upon wars old and new: that is, on war loan charges, on war pensions, and on maintaining military and naval forces. Great Britain, not being made up of forty-eight States with separate incomes, naturally spent a smaller proportion of her national income on war charges; but last year, and again in the Estimates for this year, the proportion of the national revenues that this country is spending on wars old and new is no less than 64 per cent.—more than twelve shillings in every pound of taxes. When we remember that a simple agreement between a few great naval Powers is all that is needed to abolish battleships, and that a battleship costs, in capital, some 8,000,000*l.* sterling, or, in income (for interest, depreciation, and repairs, but not including *personnel*), 1,000,000*l.* a year—more than ten times the British contribution to the League of Nations—we wonder that this money is not diverted to remunerative expenditure. The whole contribution of the British Government to university education is only 2,000,000*l.* (of which half a million pounds is a special grant for superannuation purposes) this year, and used to be much less. It is thus equal to the cost of maintaining the structure and equipment of two battleships. Mr. Wells says that we need to press "for a ruthless subordination of naval, military, and Court expenditure to educational needs." At all events, we need to come to an agreement with the other nations of the world, most of whose incomes are at present insufficient to meet their expenditure, for a general limitation of armaments, that would enormously reduce the burdens of taxation and set free far more than sufficient money to expand and improve our educational organisations as rapidly as is humanly possible.

Mr. Wells's book is marred by minor defects, which are only minor because of the greatness of the whole. Thus he would apparently have his readers believe that the world commonwealth, which he regards as the ultimate goal, should be

attained by the immediate absorption of the existing seventy or eighty independent sovereign States of the world into a single super-State. Such a first step would certainly be a false step, even if it were in any way practicable. How would it, for example, be possible to persuade Japan to place the control of her destinies in the hands of a Parliament, Congress, or Assembly most of the members of which would be of European race? The first step towards increasing the political unity of the nations is surely their co-operation in multifarious works for the benefit of mankind, and especially in the abolition of world-war. This is what is being done by the "quite inadequate League of Nations at Geneva," which consists, after all, of forty-eight sovereign States representing three-quarters of the population of the earth.

Moreover, Mr. Wells is surely mistaken in supposing that we must get rid of patriotism if we are to have an adequate sense of world citizenship. Loyalty to a smaller group is not necessarily inconsistent with higher loyalty to a larger group that includes the smaller. An undergraduate who is asked to play for his university and for his college on the same day will play for his university, and not for his college; but he is not on that account less loyal to his college. The Yorkshireman or the Cornishman who loves his county is not on that account an inferior Englishman; nor is one who loves England likely to be a less loyal member of the British Commonwealth of nations than one who has no feeling for his own people; nor, again, has it ever been suggested that loyal members of the British Commonwealth are on that account feebler supporters of the League of Nations.

J. C. M. G.

Practical Chemistry.

- (1) *Introduction to Qualitative Chemical Analysis.* By Th. W. Fresenius. Seventeenth edition. Translated by C. Ainsworth Mitchell. Pp. xx+954. (London: J. and A. Churchill, 1921.) 36*s.* net.
 - (2) *A Text-book of Practical Chemistry.* By G. F. Hood and Major J. A. Carpenter. Pp. xii+527. (London: J. and A. Churchill, 1921.) 21*s.* net.
 - (3) *Public Health Chemical Analysis.* By R. C. Frederick and Dr. A. Forster. Pp. viii+305. (London: Constable and Co., Ltd., 1920.) 21*s.* net.
- (1) **T**HE treatises on chemical analysis—qualitative and quantitative—planned so far back as 1840 by C. Remigius Fresenius,

the original proprietor and director of the well-known Wiesbaden laboratory, have enjoyed an almost unchallenged position in Germany as standard works for more than three-quarters of a century. During that period they have been frequently revised and reprinted. English editions of these works have been published by the firm of J. and A. Churchill at various times, and are, of course, well known in this country and in America, but have never acquired the same popularity as in Germany. Manuals of chemical analysis written by English and American authors have been found more suitable for class and laboratory instruction. Chemical analysis is, of course, an art which can be acquired only by practice, and a book on the subject should be substantially a *vade-mecum*, which is defined to be anything, especially a book or manual, a person carries with him for daily use. Now this is precisely what the works of Fresenius are not. They have grown so unwieldy that it is impossible to use them as manuals or as the constant companion of the student on the laboratory bench. They are to be regarded rather as works of reference to be consulted in the college library, in which the learner may hope to find an account, more or less detailed, of everything connected with the subject, arranged systematically, and with bibliographical references to the original sources of information.

Mr. Mitchell's book is a translation of the seventeenth edition of the original work brought up to date and made to conform with modern conceptions by Dr. Th. Wilhelm Fresenius. In its English dress it is a portly octavo volume of nearly 1000 pages, and is, in effect, a text-book on general chemistry with special reference to qualitative analysis. Presumably, in its present form, it is primarily intended to supplement the course of lectures given in the Wiesbaden school. It has been translated into English with meticulous care, and so preserves certain blemishes which are characteristic of the original. Practically all the bibliographical references are to German periodicals, and largely to Fresenius's *Zeitschrift für analytische Chemie*. German names, of course, preponderate. English, French, and American chemists have made notable contributions to analytical chemistry, but their names are conspicuous by their absence. Mr. Mitchell is the editor of the *Analyst*, and he must have been struck by the entire omission of any reference to that journal, which now extends to forty-six volumes. Surely in this mass of analytical literature there must be an occasional grain of wheat that might have been allowed to germinate in a

foreign soil. We do not know if the English editor was in any way restricted, but in preparing the translation for English-speaking peoples it was, we think, desirable that he should conform to generally accepted English nomenclature and terminology. When the International Committee on Atomic Weights was created, one of its earliest duties was to unify the nomenclature of the elements. Not only were the atomic weights to be made uniform throughout the various nations which were represented on the Committee, but also the names and symbols of corresponding elements. The general principle suggested was that the original name should be retained. This recommendation, although adopted by the American, French, and English representatives, was systematically ignored by their German colleagues. Glucinum, which was discovered by Vauquelin, was still called beryllium, apparently for no other reason than that Klaproth had so termed it. Columbium was first detected and so named by Hatchett in 1801, but this element is invariably called niobium by the Germans, because Rose in 1844 had inferred the presence of a new element, which he had thus named, in the columbite of Bodenmais. It was afterwards found that Rose's supposed new element had no existence; but, as the name "niobium" had been introduced into German chemical literature, it was applied to Hatchett's columbium, discovered more than forty years previously. We think, therefore, in the light of these facts, Mr. Mitchell would have been well advised to conform to English, French, and American procedure.

The book is free from typographical errors, and has evidently been carefully read. There are, however, a few errata which are duly noted; but that the atomic weight of titanium should be 48.1 instead of 40.1 (p. 197) is not one of them.

(2) Messrs. Hood and Carpenter's "Text-book of Practical Chemistry" is claimed by its authors to be "a whole-hearted attempt . . . to indicate the *best methods* of doing everything." Whatever may be thought of the claim, the book, in plan and execution, is in striking contrast with that just noticed. Whereas that work is specially, and almost exclusively, directed to the subject of qualitative analysis, the present authors seek to cover the whole domain of practical chemistry—inorganic and organic preparations, inorganic and organic qualitative and quantitative analysis by gravimetric, electrolytic, and volumetric methods, including gas analysis—within the compass of half the number of pages to which the work of Fresenius extends.

Although the book and its arrangement are,

apparently, largely based upon the experience of the authors as science teachers in schools, it is presumably intended for a higher grade of instruction than that usually given to schoolboys. Indeed, the authors, at times, think it unnecessary to mention certain elementary matters, for the reason that they are probably already known to beginners. They have, however, not been very consistent in this respect. Very elementary things are occasionally treated at considerable length, and space is thereby sacrificed to comparatively unimportant subjects which might well have been devoted to fuller details of more advanced or more difficult matters. The work, in fact, suffers from a lack of a sense of proportion; it bears marks of haste in preparation, as if the authors had not thought out with sufficient care the details of their scheme. The general plan of the work is excellent, but it would be quite impossible for any student, however hard-working, to overtake the whole within the period usually allotted to his training. The time given to the preparation of substances, if he is expected to make any considerable proportion of those enumerated, would alone consume a large fraction of it.

Under the direction of a capable teacher the book is calculated to be of service, if judiciously used, as a laboratory manual. Anyone who had worked through it, with due attention to its directions, would be well equipped with a knowledge and experience of operative chemistry.

(3) The little work on "Public Health Chemical Analysis," by Mr. R. C. Frederick and Dr. Aquila Forster, is apparently designed for the use of the Medical Officer of Health who may be called upon to make analytical inquiries, or may desire to inform himself of the methods employed by the Public Analyst in connection with matters with which he is directly concerned. After a somewhat bald introduction on the general principles of gravimetric and volumetric analysis, the book deals with such subjects as the chemical examination of air, water, sewage, trade waste, and effluents; the analysis of ordinary foods, such as milk and milk-products, flour, bread, sugars, jams, confectionery, proprietary foods, alcoholic liquors, tea, coffee, cocoa, and condiments; the detection of metallic poisons in foodstuffs; disinfectants; soap; rag flock, etc. The methods described are those in common use by analysts, and present no features of novelty. They may be accepted as trustworthy, and well within the competence of an officer who may only occasionally be required to undertake them. The book is well printed, adequately illustrated, and provided with a good index.

NO. 2701, VOL. 107]

The Nature of Man.

The Origin of Man and of his Superstitions. By Carveth Read. Pp. xii+350. (Cambridge: At the University Press, 1920.) 18s. net.

ONE of the legacies left by the Darwinian controversy has been an intense interest in the highly speculative questions centring round the transition that took place from our semi-human to our human ancestry. The subject has an intense fascination for many, and they will find ample room for the exercise of their imagination while reading the mass of material brought together by the author in support of his hypothesis. He assumes that our early ancestors were large anthropoid apes which took to hunting and a more carnivorous diet, and thus changed profoundly their "former, peaceable, frugivorous habit." Thus there was a selection of those qualities most effective for hunting game. Some of the Primates used unwrought weapons, co-operated in defence, and could communicate with each other—*e.g.* the early hunters went in packs, and thus resembled wolves; indeed, man "became at first a sort of wolf-ape."

In the course of his reflections upon the nature of man the author concludes that "man, in character, is more like a wolf or dog than he is like any other animal." Hence "the Nordic sub-race [of the Mediterranean, we may suppose], with its fair hair, . . . has the appearance of an Arctic beast of prey, like the polar bear." The adoption of a hunting life had many consequences: each pack had its own hunting ground; hence the idea of property; co-operative hunting increased intelligence. The "constructive impulse" thereby became an "absorbing passion," and the use of language was stimulated. The first wars, probably, were waged for hunting grounds; thus the more "virile" and compact of the "wolf-ape" packs predominated, and presumably led to that triumph of Nature, the "Arctic beast of prey"—the Nordic sub-race. Sports and games have been stimulated by the hunting life. Further, "I offer the suggestion that the origin of laughter and the enjoyment of broad humour . . . may be traced to . . . occasions of riotous exhilaration and licence" following on a successful hunt. Hunting life does not explain, says the author, the origin of magnanimity, friendliness, etc.

Mr. Read then turns to the origins of beliefs.

"Savages of the lowest culture have few beliefs that can be called positively injurious. . . . Taboos do more good by protecting person, property, and custom than they do harm by restricting the use of foods. . . . Many rites and observances are sanitary. Totemism rarely does any harm, and

may once have symbolised usefully the unity of social groups. Totemic and magical dances give excellent physical training, promote the spirit of co-operation, are a sort of drill . . ."

The hunting pack fell to pieces owing to a variety of causes, but the situation was saved by the rise of magic—due to a "belief in mysterious forces and from confusing coincidence with causation"—and the magician or wizard, who kept the group together by his power to "make the boldest tribesmen quail." This process of consolidation was helped on by the growth of animism—"a confusion between dreams and objective experience"—and the strengthening of the power of ruling families. The rest of the book is occupied with a discussion on more or less conventional lines of the origins of belief. The author examines the various theories of Frazer, Tylor, Lang, and others, but it is not easy to see where lies the real connection between this and the opening parts of the book.

It is difficult to express an opinion in a few words on an argument which deals with matters mainly beyond our ken. Discussions can scarcely be termed "scientific" that begin with wholly hypothetical stages of society such as the hunting pack of "wolf-apes." The author evidently has not studied the actual facts concerning hunters, or he would have seen that his theory breaks down for the reason that existing hunting peoples approximate more closely to the higher anthropoid apes than to his hypothetical wolf-apes. Moreover, what evidence has he that early man was warlike, or that he went about in packs?

The book has several misprints: p. v., 1805 for 1905; p. 296, Puranas for Punan, Boschmans for Bushmen; p. 61, Battus, ? Battas of Sumatra. The author is also given to repetition—e.g. on pp. 2, 28, and 32 he tells us that anthropoids "occasionally eat birds' eggs and young birds; the gorilla has been said to eat small mammals."

W. J. PERRY.

Principles and Practice of Psychotherapy.

Psychology and Psychotherapy. By Dr. W. Brown. With a Foreword by Dr. W. A. Turner. Pp. xi + 196. (London: Edward Arnold, 1921.) 8s. 6d. net.

INTO this small book Dr. W. Brown has succeeded in packing a great deal of information on a subject which is now attracting widespread attention. In his preface he enters a timely warning, which is supported by Dr. W. A. Turner in his foreword, that an essential pre-requisite for the practice of psychotherapy is a sound know-

ledge of general medicine, and particularly of neurology and psychiatry.

Dr. Brown has attempted to crowd so much into such a small compass that rather abrupt changes of theme somewhat interfere with the progressive development of a guiding line of thought. The early chapters discuss in a lucid manner the mechanism of dissociation and repression, which introduces us to the conception of the unconscious and the interpretation of dreams. Much consideration is devoted to the views of Freud, and Dr. Brown indicates clearly where and why he cannot altogether accept them. The section dealing with emotions is rather scanty for so important a subject, and here, perhaps, Freud's views are too summarily dismissed. A special section is allotted to the psychoneuroses of war; the great value of this contribution lies in the fact that Dr. Brown had unsurpassed opportunities for studying both the very early cases immediately behind the line in France, and later the more chronic cases which were met with in the special neurological hospitals at home. This twofold experience enables him to point out certain differences in type and to emphasise the great importance of early treatment in mental disturbances.

Dr. Brown has already published, in various medical journals, many articles dealing with his views on the principles underlying psychotherapy, and in this volume he seeks to crystallise them. He considers that there are four relatively independent factors at work, namely, psychocatharsis or abreaction, psychosynthesis or reassociation, autognosis or self-knowledge, and finally the personal influence of the physician. On the first of these factors he lays great stress, but indicates that the essential aim of them all is self-knowledge. He seems to have coined the term "autognosis" to designate a therapeutic process consisting of a small amount of mental exploration combined with a great deal of explanation and persuasion. Certainly no Freudian would allow that it is in any way comparable to a psychoanalysis.

The last section of the book is a most interesting little discourse on that bugbear of philosophy, the interrelationship of body and mind. Though he does not definitely commit himself, it would appear that Dr. Brown leans more to the theory of Bergson as unfolded in "Matter and Memory" than to any of the alternatives. He makes no mention of the more recent thoroughly monistic system of Kempf.

It is, however, not a little surprising to find that Dr. Brown refers to telepathy in terms which would imply that it is no longer a debatable

theme, and uses it conveniently as a possible explanation of certain obscure phenomena which require a great deal of further investigation.

Apart from the few criticisms which we have made, the book gives an admirable elementary presentation of its subject-matter, and may confidently be recommended to every student of psychology.

ALFRED CARVER.

Torres Strait and its Echinoderms.

Department of Marine Biology of the Carnegie Institution of Washington. Vol. x., The Echinoderm Fauna of Torres Strait. By Hubert Lyman Clark. (Publication No. 214.) Pp. viii + 223 + 38 plates. (Washington, D.C.: The Carnegie Institution of Washington, 1921.) 15.50 dollars.

ONE result of an expedition to Torres Strait organised by the Carnegie Institution of Washington in 1913 has been that the department of marine biology of that institution has published an admirable memoir on the Echinoderm fauna by Dr. H. Lyman Clark. The 240 species there found are critically examined, as well as fifty species from adjacent regions. Notes on the habitat and habits are furnished in many cases. Forty-one new species were discovered, and some are here described for the first time; many of these and others are illustrated by photographs, and a number are represented in their natural colours from drawings by Mr. E. M. Grosse, of Sydney, on nineteen exquisite plates lithographed by Mr. H. S. Burton at the Government Printing Office of New South Wales. The technical and artistic skill here displayed do justice to the extreme beauty of the objects.

The chief interest of the memoir lies in the light that Dr. Clark's careful analysis of the Echinoderm assemblage sheds on the geographical changes which led to the formation of Torres Strait. C. Hedley's hypothesis of a Queensland gulf in Mesozoic times receives no support from the echinoderms. What may be called the original echinoderm fauna was, in Dr. Clark's opinion, on the north-west side of the present continent, and was of East Indian origin and Indo-Pacific composition. On the other hand, confirmation is afforded for Hedley's view that, as land areas east of New Guinea subsided, the Coral sea became connected with the Pacific; its western shores also receded until the Great Barrier Reef was formed. This sea was invaded by echinoderms from the Pacific, and these now compose the distinctive fauna of the Barrier Reef and the Murray Islands, and to some extent that of southern Queensland and New South Wales.

Continued subsidence on both sides led at last to the formation of Torres Strait, and the East Indian echinoderms then migrated eastward and southward to the Queensland coast and Barrier Reef, where they mingled with the Pacific immigrants. The latter, however, have not passed westwards through the Strait.

The echinoderms on which these conclusions are based, though representing all the living classes, are confined to those from shore-waters, and the argument postulates that their migration must follow the shifting of the coasts, and cannot be greatly affected by the dispersal of pelagic larvæ through currents. The actual facts of the distribution are certainly more consistent with this assumption than with the opposite opinion of Mr. Jeffrey Bell. Dr. Clark has used, and used with masterly skill, the facts at his disposal; but over and over again he has to deplore the incompleteness of our knowledge. Some areas are still untouched by the collector; for instance, the Gulf of Carpentaria, in the very heart of the region under discussion, and the southern coast of New Guinea just to the north of it. From other important areas we have but the chance dredgings of a few cruises, and even where a more careful search has been made it has been restricted to a brief period; of the seasonal changes nothing is known beyond the fact of their occurrence. What rich harvest may follow from more extended exploration and more intensive study of selected areas is abundantly indicated by Dr. Clark's learned and suggestive survey.

F. A. B.

Our Bookshelf.

From the Unconscious to the Conscious. By Gustave Geley. Translated by Stanley de Brath. Pp. xxviii + 328. (London: William Collins, Sons, and Co., Ltd., 1920.) 17s. 6d. net.

THERE is a well-known fact of biology called the histolysis of the insect, which was first investigated by Weissmann in 1864. When the insect has completed its larval stage and enters into the pupal stage, its tissues disappear, leaving none of their former cellular elements; all are converted into an apparently homogeneous mass, out of which the imago is generated *de novo*.

There is a lady, known in mediumistic circles as "Eva," of rather unprepossessing appearance, to judge by her photographs, who possesses a power of what is called materialisation. She is by no means unique in the possession of this faculty, but she has been trained, we are told, to give the most perfect exhibition of it which has yet been known. At great personal discomfort, often apparently involving actual pain, under the

conditions of hypnotic trance and in a specially contrived darkened cabinet, she is said to exude, chiefly from the natural orifices of her body, a plastic, amorphous substance which assumes (as Hamlet said of his father's ghost) a questionable shape, usually a face or a hand. The shape is three-dimensional, and the author of this book, who has studied the case at first hand and under his own conditions in his own laboratory, tells us that he has himself touched it and even felt the bones beneath its skin. The exuded substance, notwithstanding its assumption of this solid shape, is invariably, and generally expeditiously, re-absorbed by the lady, and the suggestion is that it could not be detached or amputated without serious, if not fatal, injury to the lady.

The theory expounded in this book is that these two phenomena, the histolysis of the insect and the materialisation of the lady, are fundamentally and essentially identical, and the study of them has led the author to formulate a new principle, which he names dynamo-psychism. This, he claims, is a scientific principle which finally solves all the problems of life and evolution. As a philosophy it has had, he tells us, its forerunners in Schopenhauer's theory of will and in von Hartmann's theory of the unconscious; but the great merit which is claimed for the new formulation is its overcoming of the pessimism inherent in those theories. H. W. C.

(1) *The Copernicus of Antiquity (Aristarchus of Samos)*. By Sir Thomas Heath. (Pioneers of Progress. Men of Science.) Pp. v+59. (London: S.P.C.K.; New York: The Macmillan Co., 1920.) 2s. 6d. net.

(2) *Kepler*. By W. W. Bryant. (Pioneers of Progress. Men of Science.) Pp. 62. (London: S.P.C.K.; New York: The Macmillan Co., 1920.) 2s.

(1) THE first of these two little books is the work of a master-hand. Sir Thomas Heath published in 1913 a valuable edition of the only extant writing of Aristarchus, preceded by an introduction of more than 300 pages, in which he gave a critical history of Greek cosmology up to the time of Aristarchus. In the present little book he also begins by giving a rapid sketch of the various systems of the world proposed by Greek philosophers. The statements of ancient writers are next quoted, proving beyond dispute that Aristarchus really put forward the heliocentric hypothesis. We could have wished that it had been shown in more detail how Aristarchus may have been led to propose this way of "saving the phenomena." Lastly, there is an account of the contents of the treatise of Aristarchus on the sizes and distances of the sun and moon, which is of considerable mathematical interest.

(2) Mr. Bryant's account of Kepler's life and work, though very readable, is not altogether satisfactory. The description of how the first two laws of Kepler were found is not clearly expressed and is incorrect in many details. When allud-

ing to Kepler's ideas on gravity it should have been pointed out that his force was tangential to the orbit and not directed to the sun. Of the work on the harmony of the world we are told that "the fifth book contains a great deal of nonsense." That Kepler distinctly states that the harmony is only a mathematical conception, and that there is not really any music of the spheres, is not mentioned. The portrait given as a frontispiece is not of Kepler.

Cocoa and Chocolate: Their Chemistry and Manufacture. By R. Whymper. Second edition, revised and enlarged. Pp. xxi+568+xv plates. (London: J. and A. Churchill, 1921.) 42s. net.

THE first edition of this book appeared in 1912, and quickly established for itself a reputation as a useful book of reference, especially in connection with the problems of cocoa and chocolate manufacture, as distinct from those of cacao cultivation and preparation. The second edition has been largely rewritten and brought up to date—a considerable task in view of the important changes which have taken place in cacao production and chocolate manufacture since 1912.

The book is divided into three parts: (1) the history, botany, and agriculture of cacao; (2) the manufacture of chocolates and cocoa powders; and (3) the chemistry of cacao and its products. The few defects of the first edition were nearly all in part 1, and have been remedied, so that the book is now a reasonably complete account of the whole industry. It is well produced, and is provided with a good index and numerous carefully selected illustrations. Presenting, as it does, a broad survey of the whole subject, it should be particularly useful at the present time, when chocolate manufacture, at any rate in this country, is at a somewhat critical period in its history.

Mathematical Papers for Admission into the Royal Military Academy and the Royal Military College and Papers in Elementary Engineering for Naval Cadetships and Royal Air Force for the Years 1911-1920. Edited by R. M. Milne. (London: Macmillan and Co., Ltd., 1921.) 10s. 6d.

ALL the papers described in the title which have been set during the last ten years are here collected in a single convenient volume. The answers to the questions, where necessary, have been provided by the editor at the end of the book. To those who are engaged in preparing candidates for Army examinations this publication will be extremely useful.

Scurvy: Past and Present. By Prof. Alfred F. Hess. Pp. vii+279. (Philadelphia and London: J. B. Lippincott Co., 1920.) 18s. net.

PROF. HESS gives in this work the results of an exhaustive study of scurvy in all its aspects—its history, pathology, causation, symptomatology, diagnosis, and treatment. The bibliography is most complete. The work is very convincing.

Letters to the Editor.

[The Editor does not hold himself responsible for opinions expressed by his correspondents. Neither can he undertake to return, or to correspond with the writers of, rejected manuscripts intended for this or any other part of NATURE. No notice is taken of anonymous communications.]

The "Flight" of Flying-fish.

HAVING read with interest the letters by Prof. Wood-Jones and Mr. Julian S. Huxley in NATURE for April 21 and 28 respectively, I send some observations of my own which seem to have a bearing on this subject. In the early 'nineties I was engaged in the development of the meteorological kite of the Hargrave pattern, which was adopted at the Blue Hill Observatory for lifting self-recording apparatus in the air, and later adopted by the various bureaus of the world for aerological research. This work brought me in contact with the early pioneer workers on the problem of flight in the United States—Langley, Chanute, the Wrights, Cabbot, Means, Millet, and others—and I occasionally co-operated in experiments on the lifting and driving powers of various devices. One of these was a device in which a stiff rod had attached to one end a flexible rod of bamboo, one end of the bamboo strip being tied near the end of the rigid rod and the other about one-fourth of the way down, so that the bamboo rod formed a loop, over which was drawn a covering of cloth. Now, if one took the free end of the rigid rod and waved the end containing the bamboo loop up and down, he was immediately turned round by a forward motion of the outer end of the rigid rod. The reason of this clearly was that when he lifted the rigid rod upward the flexible loop bent downward, and there was a component of air pressure forward, while when he moved the rigid rod downward the flexible loop bent upward, and there was still a component of air pressure forward. When vibrating the rod up and down there was a persistent forward thrust, and this thrust was so great when the vibration was rapid that the operator was turned completely around in his tracks as on a pivot.

In 1905 I was in charge of the Tieserenc de Bort and Rotch Expedition for exploring the atmosphere with balloons and kites over the tropical part of the Atlantic. The *Otaria*, on which we travelled, was a small boat not much more than 100 ft. in length, with the decks near the water, so that I had an excellent opportunity of studying the movements of flying-fish, which we saw in great numbers.

As these fish left the water the powerful lateral strokes of the tail which lifted them into the air could be plainly seen. As they rose into the air the pectoral fins vibrated with great rapidity, and my earlier experiments with the rod and flexible web led me to believe that exactly this same principle was used by the flying-fish to drive itself forward. The forward part of the pectoral fin is rigid and the rear flexible, so that its rapid vibration gives a strong propelling force. When the fish had gained velocity and the rising impulse given by the tail had culminated, the fins ceased to vibrate and were used as aeroplanes, on which it glided forward, slowly sinking until its tail touched the water, when another lateral stroke lifted it into the air and the process was repeated. In this way the fish could remain in the air for long flights when necessary. The only way in which the motion differs from the flight of birds is that the vibration of the fins probably gives no lifting force, but only a forward driving force, and the fish needs to depend on the tail-strokes for the lift. Had the

fish developed a concave under-surface of the fin it could probably have obtained both lifting and propelling force from the fins. H. H. CLAYTON,

Oficina Meteorologica, Buenos Aires,
June 20.

The Colours of Breathed-on Plates.

THE phenomena of breath-figures on glass are of considerable interest, and have been written upon in the columns of NATURE by the late Lord Rayleigh, Dr. John Aitken, and others. One specially interesting aspect of the subject to which I have recently devoted some attention is the explanation of the beautiful optical effects exhibited by breathed-on plates of glass. If a clean, cold plate of glass is lightly breathed on and then held in front of the eye, and if a small distant source of light is viewed through it, coloured haloes will be seen surrounding the source. The characteristic feature of the halo exhibited by a moderately heavy (but not too heavy) deposit is that the outermost ring in it is achromatic, with a reddish or brown inner margin, followed inside by a succession of rings of various colours. As the film of moisture evaporates, the halo contracts and the coloured rings move inwards, ultimately disappearing at the centre of the halo. The entire halo presents a radiating fibrous structure.

The explanation of these phenomena presents some difficulties. One is tempted to suppose (as, indeed, Donlé and Exner have already) either that the minute droplets of water condensed on the plate which diffract the light are of approximately equal size or that they are arranged at more or less constant distances from each other. A microscopic examination of the condensed film shows, however, that neither of these suppositions is anywhere near the truth. The size of the individual droplets shows a variation of several hundred per cent., and their arrangement in the film is entirely irregular, being determined presumably by the presence of invisible condensation nuclei on the surface of the plate—a view that is strongly supported by the fact that successive deposits on the plate are seen under the microscope to preserve the same configuration with a surprising degree of accuracy. Further, if the size of the droplets were the determining factor in the production of the diffraction haloes, it would be difficult to understand why as they evaporate the rings in the halo should contract in size.

These facts necessitate an entirely different supposition regarding the element of regularity in the film which enables it to give rise to a recognisable system of coloured diffraction haloes. Measurements I have made seem to show that the droplets in the film—whether large or small—have practically all the same angle of contact with the surface of the plate, this angle of contact diminishing as the film evaporates. The formation of the coloured haloes is, on this view, due to the passage of the light through the minute lens-shaped droplets; the maximum deviation of the light determined by the common angle of contact fixes the position of the outermost achromatic halo, and the colour-sequence following within it would be practically the same for all the droplets irrespective of their size. This would also furnish a satisfactory explanation of the contraction of the halo as the film evaporates.

C. V. RAMAN.

22 Oxford Road, Putney, S.W.15, July 26.

Mutations and Evolution.

THE article on my recent little book on "Mutations and Evolution" in NATURE of July 14, p. 636, shows such insight in the exposition of some of the views

there set forth that it may seem ungrateful of me to venture to reply to anything the reviewer has written. Nevertheless, there is one important point in which I feel that my argument has been missed. My conceptions of the relation between recapitulatory and mutational characters are not easy to state clearly in a brief space, and I am willing to admit obscurity in certain passages, as evidenced by your reviewer's failure to grasp my meaning, but I am not willing to plead guilty to the more serious charge of obscurantism.

The argument was not that mutations are limited in their scope by the existence of non-cellular structures in organisms, but rather that embryonic characters which show recapitulation, and at the same time imply re-adaptation of the organism, cannot have arisen by chance mutations in the germ-plasm, but must have arisen as environmentally induced responses which could become germinal only according to the principle of the inheritance of acquired characters.

By general agreement mutations arise as such in the germ-plasm, *i.e.* probably in the chromosomes. But there is another possible route into the germ-plasm, namely, *via* a modified soma (probably in its beginning a modified cytoplasm), ultimately affecting the germ-nuclei.

Orthogenetic changes I placed in a third category as showing recapitulation and yet arising in the germ-plasm, since they are non-adaptational, and hence probably not environmentally impressed on the organism. The relations between these three types of characters are admittedly obscure, but it does not follow that they are non-existent or that the conceptions regarding them are obscurantist. I wished particularly to contrast mutations and embryonic recapitulatory characters from the point of view of organic structure, indicating that the principles which will explain the one cannot adequately explain the other.

R. RUGGLES GATES.

King's College, Strand.

PROF. GATES'S restatement of certain points in his original argument, if more explicit, nevertheless meets but one of the issues raised in my article. In answer to the doubt therein expressed as to whether he himself can be held blameless of the offence with which he charges others, he pleads "not guilty." But if "obscurantism" (the author's word, not mine) be judged too harsh a verdict on the passage cited, *obscurum per obscurius* in respect of this particular statement—and others—is not to be gainsaid. And shall we even then acquit the author on the more serious count? Or will the general reader desirous of comprehending the relation of Mendelian to Darwinian theory uphold the charge after perusal of the author's introduction? If he do not, he will unquestionably deserve the encomium which the author, so disarmingly, bestows upon myself.

THE WRITER OF THE ARTICLE.

Molluscan Fauna of Scottish Lakes, and a *Pisidium* New to the British Isles.

MAY I through the columns of NATURE invite the assistance of naturalists who may be visiting Scottish lakes and tarns on their holidays in making known the molluscan contents?

Whilst Mr. R. A. Phillips and Mr. Stelfox have investigated the mollusca of the Irish lakes, and Mr. C. Oldham those of much of Wales and England, our knowledge of the Scottish fauna is lamentably deficient. If living specimens are unobtainable, dead shells from the shores will be acceptable as showing what species are present. In either case, for purposes of identification, no special method of preservation is

necessary—the specimens will travel perfectly if packed in sand or sawdust; but if spirit is procurable fresh specimens would be more useful if placed in that medium. In all cases, of course, locality and date are essential.

As instancing the interest attaching to the investigation, and the possibility of further important discoveries, I may mention that Dr. Nils Hj. Odhner, of the Rijksmuseum, Stockholm, has just identified some specimens from Loch Ness, in my collection, as being *Pisidium clessini*, Surbeck, a deep, cold-water species known also from Sweden and Switzerland, which he has also recognised from two other British localities.

B. B. WOODWARD.

4 Longfield Road, Ealing, London, W.5.

Cup and Ring Markings.

IN reply to Mr. Abbott's letter in NATURE of July 21, p. 652, I regret that he did not see the photographs to which I referred; had he done so he would have appreciated the difference between these and his own. As there is no tangible evidence that such reconstructed surfaces are due either to gelic selection or adsorptive precipitation, I submit that, pending the proving of the gel theory, it is safer to describe the process as "concretionary," for this term covers much ignorance, and is, at least, non-committal.

May I say that the ridged mortar, as shown in Mr. Abbott's interesting photograph, is not found only on the northern sides of buildings near the sea; I have excellent examples from Corfe Castle and other buildings in the district, from old field-walls at Kirkby Lonsdale, and from many other places inland?

There is a coign of calcareous sandstone in the wall of an old barn a few miles from Kirkby Lonsdale with the whole surface naturally ridged and ringed, while the mortar surrounding it is unaltered.

I have never suggested that similar patterns were not carved on some rock surfaces by prehistoric man, but that, if they were, these mystic markings were copied from Nature long before the days of mortar!

I regret I am now unable to find the photographs of 1896, but when I do Mr. Abbott shall see them.

C. CARUS-WILSON.

Science and Civilisation.

THE letter of Mr. Henderson Smith and Major A. G. Church in NATURE of July 28, p. 684, is most welcome as showing that scientific workers are at last beginning to realise that it is time for science to make itself felt, not only for the acquisition of knowledge and the improvement of machinery and production, but also for the establishment of a national and harmonious social order.

May I say that a scheme has already been evolved which should appeal to all truly scientific sociologists? It is based essentially on economic and eugenic principles, and is termed Neo-Malthusianism. It aims at eliminating poverty and other social evils by proportioning population to the means of subsistence, and at securing race improvement by maintaining the selective struggle of Darwin, substituting humane voluntary abstention from reproduction for brutal elimination by disease and starvation. It aims also at the elimination of class and international warfare through the diminution of the pressure of population, and at the reduction of vice and disease by promoting universal early marriage.

Anyone interested in this subject is invited to write to the hon. secretary of the Malthusian League, 124 Victoria Street, S.W.1.

C. V. DRYSDALE.

Remarks on Simple Relativity and the Relative Velocity of Light.

By SIR OLIVER LODGE, F.R.S.

I.

IN continuation of my article in the Relativity Number of NATURE (vol. cvi., p. 795, February 17, 1921), I propose to discuss more fully, and to express as clearly and simply as possible, some of the points on which philosophic disciples or expounders of Einstein have written, so as perhaps to remove a certain amount of misapprehension, and incidentally to set my own views before other physicists, in order that they may be controverted where necessary. On some other points of more general interest I have written in the *Fortnightly Review* for next September, especially on the foundation which had been laid by Einstein's predecessors before the philosophic doctrine of relativity was made definite and erected into a comprehensive physical theory.

The Fundamental Relativity Hypothesis.

Einstein's first fundamental assumption is that direct observation of our absolute motion through space is not only unachieved, but also in the nature of things impossible; wherefore it can be held that such motion has no intelligible meaning. Those who admit an æther prefer not to shut the door on inquiry, but meanwhile express their provisional agreement by saying that its various functions and properties are so uniform, so universal, and so interrelated, that observation of any suspected effect of motion through the æther is liable to be frustrated or negated by some—so to say—in-avoidable opposite effect; and that the compensation, at any rate over a wide range, is complete.

Einstein's second fundamental assumption is that the one absolute quantity which can be observed, namely, the velocity of light—if it be a velocity—is unique and so fundamental that every observer must necessarily measure the same result if he make his measurements correctly, no matter what his own motion may be; which, after all, is only another way of saying that his own motion through the æther is pragmatically a meaningless expression.

It is not claimed that these assumptions, which are certainly consistent with the Larmor-Lorentz transformation equations—at least, when they include the factor β , expressive of the FitzGerald-Lorentz contraction—are really established by them. That would be reasoning in a circle. Nor do the equations necessarily substantiate any metaphysical assertions about time or space or æther; but they do lead to algebraic and legitimate deductions.

The Time and Space Transformation.

The importance of those transformations—correlating the states of the same material system travelling at different speeds—can scarcely be exaggerated. They have been arrived at in many ways, usually by aid of ideal and hypothetical and apparently impossible experiments, sometimes by

considering that an event does not effectively happen until we have seen it happen, thus entailing relative delay; and they have been variously interpreted. The original gist of the equations was that a moving observer must not only take his distances as variable; he must consider his times variable too. He must have a local and fictitious time peculiar to himself, if he is to ignore his own motion and treat his direct measurements as conclusive.

Einstein's step was equivalent to dispensing with any overt fiction about this subjective or local measure of time, to claiming that it was as real as any other, though peculiar to each observer, and to seeing what emerged.

Now if we agree to waive any question of experimental practicability, and proceed in an ideal fashion, it is easy enough to obtain notions about the required transformation; and as I have not seen the equations obtained so directly or naively, I proceed to deduce them thus:—

A stationary observer, supposed able to time the passage of light from a source at a distance x , may be expected to get the result

$$\frac{x}{t} = c.$$

If he be moving towards the source with speed u , he will be relieving the light of some of the journey by doing that bit himself. The light need now only travel a smaller distance x' to meet him, and the observer will have travelled the remainder, namely, $x - x'$. So if the time taken on the jointly performed journey be t' , and if he finds it possible to measure the distance x' at the instant the light reaches him, which is evidently the right moment, he will get

$$\frac{x'}{t'} = c \quad \text{as the speed of the light,}$$

and

$$\frac{x - x'}{t'} = u \quad \text{as his own speed.}$$

Given these three equations, we get by mechanical algebra without further reasoning

$$t = t' + \frac{ux'}{c^2},$$

as well as the more obvious

$$x = x' + ut',$$

without mentioning relativity at all.

If all these measurements could be really made, we should have

$$c + u = \frac{x}{t'},$$

and u could be determined in terms of c . But the measurements are impracticable as they stand, for how is an observer to know the instant at which a particular portion of light left the source? In other words, how is he to time an event on the source when he is dependent on the light itself for information of its occurrence? He might have the event telegraphed, but that information also is transmitted by the æther at the same pace. So the foiled inquirer will naturally try to get some additional data by reversing his motion and starting back again from

his present position at distance x' , so as to be moving away from the light instead of towards it. The light will now have to catch him up; and he may think, at first, that the ray which left the source at the instant he began his return journey will take the original time t to reach him, since it now has to travel the full distance x . But he will have to travel a little further than the original position, and take a little longer time, before he is overtaken; and he cannot write the reciprocal equations

$$t' = t - \frac{ux}{c^2}$$

and

$$x' = x - ut,$$

because they are inconsistent with the previous ones.

To make the two pairs of equations agree (as relativity demands), either x must equal x' , which frustrates the whole experiment, or a common factor must be introduced, say β , such that

$$t' = \beta \left(t - \frac{ux}{c^2} \right), \text{ or } \beta t \left(1 - \frac{u}{c} \right);$$

and

$$t = \beta \left(t' + \frac{ux'}{c^2} \right), \text{ or } \beta t' \left(1 + \frac{u}{c} \right).$$

This will render them harmonious, and a suitable value (the only right value) of β is easily reckoned—again mechanically, without further hypothesis—namely,

$$\beta^2 \left(1 - \frac{u^2}{c^2} \right) = 1.$$

If that is satisfied, the reversal of the journey will not give any different result; there is perfect reciprocity. You cannot by an experiment of reversing your motion with regard to light, or reflecting back the light with regard to the observer, discriminate between $c-u$ and $c+u$; nor can you discriminate either from c .

Now this β factor is the FitzGerald-Lorentz contraction; the experiment thus neutralised is the Michelson-Morley experiment; and the direct supposition that an observer must find $c-u$, and c , and $c+u$ all the same, or at least indistinguishable by observation, and that there is nothing more to be said, is the point of view of Einstein.

These names must suffice to suggest a flood of ideas to those who have read about the subject.

To sum up compactly:—

Assume that you cannot help measuring the same speed of light whether you be moving or stationary, so that x/t and x'/t' both equal c (the accented letters referring to the measurements made when you were moving with speed u to meet the light), then allow that x/t' is not equal to $c+u$, as you would expect, nor x'/t equal to $c-u$ (for in that case xx'/tt' would equal c^2-u^2 instead of c^2), but that, instead,

$$\frac{x}{t'} = \beta(c+u) \text{ and } \frac{x'}{t} = \beta(c-u),$$

which, together, require that

$$\beta^2 = \frac{c^2}{c^2 - u^2};$$

then all the rest follows.

The Contraction.

A customary and older interpretation of the introduction of the factor β —to complete and make accurate what then became the Larmor-Lorentz transformation—is that the measuring rod with which you are hypothetically supposed to measure x or x' shrinks to $1/\beta$ of its normal

length if the experimenter is moving either to or fro with speed u , so that all distances in the direction of motion measure out a little bigger than they otherwise would; more steps of the yard measure having to be taken. Note that space or æther does not shrink, but only the matter in space. The distance x has not changed, but only the instrument with which you hypothetically measure it. That having shrunk, the fixed distance measures out longer. The same thing happens with the instrument whereby you are supposed to measure time. Both distance and time of journey are abbreviated by approach, but, to measurement, not so much as an unchanged measurer would give. They are both lengthened by recession, and the measurements give rather more increment than might have been expected.

The ratio between measurements made during uniform approach, and the same made during relative rest, is

$$\frac{x'}{x} = \frac{t'}{t} = \beta \left(1 - \frac{u}{c} \right) = \sqrt{\left(\frac{c-u}{c+u} \right)}.$$

This line, with the definition $c=x/t$, is the briefest possible summary of the transformation equations.

A short and easy way of getting, or at least of recording, the essence of the transformation is to allow for the contraction of the hypothetical measuring rod by multiplying any distance across space supposed to be measured by a flying observer—flying towards or away from a distant event which really occurred at the instant he started to fly—by an undefined numerical coefficient β , and omitting this factor from any distance which he could have measured at rest before starting.

Thus let an event occur at the origin, and let an observer at x and t immediately begin travelling towards it, so as to meet the light at a place which appears to him to be x' and t' , the combined velocity over the original distance being $c+u$, he can correct his x' measurement, which has been traversed by the light alone, and write

$$\frac{x}{c+u} = \frac{\beta x'}{c};$$

while if he started from the leisurely measured x' and t' position, directly the event occurred at the origin, and receded so that the light overtook him at what appears to him to be a place x and t , coming with the relative velocity $c-u$, he can correct his x measurement for the whole distance traversed by the light, and write

$$\frac{x'}{c-u} = \frac{\beta x}{c};$$

saying, if he likes, that it is just the same as if he had stood still and the light had come to him with diminished speed. (Or he might time his own journey as $\frac{\beta x - x'}{u}$, and equate that to $\frac{\beta x}{c}$). Combining these equations with the definition

$$\frac{x'}{t'} = \frac{x}{t} = c,$$

and not troubling about the y and z co-ordinates, which remain unchanged and need no attention, we get the Lorentz transformation complete (and incidentally we see that the usual differential invariant $ds^2 = dx^2 + dy^2 + dz^2 - c^2 dt^2$ is always zero for light).

Once the transformations

$$\begin{cases} x' = \beta(x - ut) \\ t' = \beta\left(t - \frac{ux}{c^2}\right) \end{cases} \text{ with their correlative } \begin{cases} x = \beta(x' + ut') \\ t = \beta\left(t' + \frac{ux'}{c^2}\right) \end{cases}$$

are introduced, the coefficient β is self-defined as $\beta^2(c^2 - u^2) = c^2$, and results flow in thick and fast. Thus if we seek to superpose a velocity dx'/dt' , or v , on the speed u , and reckon the result as dx/dt , or w , working mechanically on the above two equations, we do not find, as we might expect, $w = u + v$, but

$$w = \frac{u+v}{1 + \frac{uv}{c^2}}$$

This *appears* to have nothing to do with the β factor, but to depend only on the second term in the expression for t . We must remember, however, that without the β factor we could not write the reciprocal equations, which permit simple reversal of sign in v if it is opposed to u . The consequences of this law of composition of velocities are astonishing, and include among them the uniqueness and maximal character of the velocity c .

Confirmation.

The Einstein assumptions have never been directly ascertained by experiment. They are not the result of experiment at all; they are a reasoned type of hypothesis, and any provisional confirmation must be derived from the legitimacy of the conclusions which, from them and their extensions, the far-reaching genius of Einstein has shown to be attainable. Briefly we may cite the general type of confirmations, including those of his completer theory, thus:—

The velocity of light inside transparent matter, being less than its value in free space, is affected by its motion in the way Fresnel predicted and Fizeau confirmed. The equations give this result without the need of Fresnel's theory.

Even outside great masses of matter the velocity is now discovered to be slightly affected (still diminished, never increased) in a second-order way that Einstein predicted and astronomers confirmed. Starlight is deflected by this gravitational refractivity.

Not only so. The neighbourhood of a very large mass of matter introduces secondary higher-order effects into the æther in such a way as to affect not its luminiferous properties only, but its gravitational structure too; and the consequence is that the orbit of a planet sufficiently near the sun behaves, not exactly in accordance with the laws of particle dynamics in empty space, but with a slight modification, depending on the squares of small quantities, such as the general principle of relativity enabled Einstein to calculate. And, as everyone knows, an outstanding discrepancy—though one detected only through the extreme refinement of astronomy—was thus triumphantly removed from the planet Mercury, the only planet near enough to the sun to be sensibly affected.

Thus, then, the general mathematical trend of ideas on which the principle was founded may be claimed as confirmed in this *ex post facto* manner; but many varieties of expression, and attempts to interpret the principle philosophically, are far from establishment still.

Alternative Modes of Statement.

If we take up an agnostic position, we cannot say—and Prof. Einstein seems to agree—that, as a deduction from experiment, any philosophic or metaphysical position is really proven. What we can definitely say is that certain statements are consistent with all the experiments hitherto made, but we cannot say that every other mode of statement is ruled out. In nearly every case—probably in every case—the result of experiment can be expressed otherwise. Thus, for instance, my experiment with the rotating discs (Phil. Trans., vol. clxxxiv., 1893) showed that their motion neither added nor subtracted anything, nor affected the velocity of light in their immediate neighbourhood, although their circumference was travelling at a speed almost sufficient to tear the steel asunder, and although an exceedingly minute alteration in the speed of light could have been observed; but this negative result can be expounded, and indeed was expounded, by saying that the æther—the vehicle of light—is not carried forward or perturbed at all by the adjacent moving matter. And that is part of an entirely rational æther theory of the atomic structure of matter.

The famous Michelson-Morley experiment, again, wherein no result is found, although the apparatus *must* be immersed in a relative æther stream, can be, and was, explained by saying that every solid body suffers a FitzGerald-Lorentz deformation due to its motion relative to that stream.

Again, the most important Fizeau experiment, one which did yield a positive result, because here light was travelling through and inside transparent moving matter, and so was accelerated and retarded by a measurable amount—not, indeed, beyond the velocity c , but beyond the velocity c/n , where n is the index of refraction—this result was explained, and by Fresnel anticipated, by assuming (crudely) that a given proportion of the æther clung to moving matter and was transported with it, or (less crudely) that the presence of matter so modified or loaded the æther as not only to retard the light considerably in any case, but to retard it differently when in motion than when at rest. Electrically, this comes out with complete clarity, because the loading property—the matter-caused modification of the æther constants μ and K —really does belong to the matter, and travels with it.

So in every instance which had been already explored an explanation was forthcoming, and had been accepted as sufficiently plausible and satisfactory; but it was a different explanation in each case. Not differing so as to be inconsistent—they were all consistent with a certain view of

the æther, and were all in agreement with the electrical theory of matter—but still, when Einstein showed that the law of composition of velocities appropriate to his principle of relativity accounted for them all as an immediate corollary, without effort and without any assumption beyond

what was embodied in that principle—this feature of directness naturally aroused the keen attention of physicists.

(Discussion of the relative velocity of light is deferred to next week.)

(To be continued.)

Endowment of Scientific Research in the United States.¹

IN NATURE for May 29, 1919, an account was given of the organisation of the National Research Council of the United States of America. Supported during the war largely by the Government, but now entirely by private bodies and firms (it has lately received a grant of 5,000,000 dollars from the Carnegie Corporation), this body owes its existence to a trend of opinion by no means confined to the capitalist classes which maintain it. The American Federation of Labour explicitly and emphatically professed its belief in the fundamental importance and beneficent results of scientific research—more especially research in pure science—in a manifesto quoted in the Report for 1918-19 of our own Department of Scientific and Industrial Research. This unanimity on the part of employer and employed in their recognition of the importance for the development of American industries of the promotion of research gives additional weight to the imposing array of facts and figures assembled by the National Research Council in the bulletin under notice, which deals with funds, other than Federal and State funds, available in 1920 for this purpose.

In the preparation of the following summary it has been assumed that where the total endowment, but not the amount annually available, is given in the bulletin, 5 per cent. of this total was available. In some cases no information is given as to the amount of the fund—either capital or interest—and these were necessarily omitted in compiling the money totals. The columns A, F, U give the number and aggregate annual value in *thousands of dollars* of the funds provided by, or in connection with:—A: academies, associations, societies, and museums; F: foundations, hospitals, and research institutes; U: universities and colleges.

to agencies which it creates for carrying out specific programmes, and partly to other existing organisations to enable them to carry out specific programmes.” Several other important annual appropriations are detailed below.

Source	Amount (1000 dols.)
Rockefeller Institute for Medical Research	1,100
Carnegie Institution of Washington—for research in astronomy, 221; physics, 329; botany, 65; biology, 131; nutrition, 52; eugenics, 31; embryology, 43	872
Carnegie Institution, minor grants	117
American Museum of Natural History—for promotion of research, exploration, etc.	278
Harvard Fund for medical research	363
J. De Lamar Funds for study and teaching of dietetics and of the origin, etc., of disease	377
John McCormick Institute for Infectious Diseases Research Fund	100
National Research Council fellowships for research in physics and chemistry	100
Massachusetts Institute of Technology, general budget appropriation for research	100

Thus, of the aggregate amount of the sums specified in the bulletin—20,778,000 dollars—more than 82 per cent. is attributable to Rockefeller and Carnegie benefactions, and more than 88 per cent. to these and the six other sources specified.

At the recent congress at Oxford of representatives of the universities of the British Empire much emphasis was laid on the fundamental importance of scientific research and on the necessity for providing material aids and training for it. The figures given above constitute a striking commentary on the following observations made by Prof. Joly at the congress: “Perhaps the most striking feature of American universities, as viewed by the British visitor, is the prevalence of research, and the lavish provision made for its prosecution. . . . There is research in everything. The American recognises to the full the value of the mental attitude induced by research, and this recognition is not confined to the university professor, from whom it may be expected, but extends, so far as I could gather, everywhere throughout the States.” At some future date the National Research Council will perhaps take stock of the results of the application of these vast sums of money, and may possibly have a tale to tell of misdirected or unfruitful effort; but it can scarcely be doubted that the net results will affect substantially the welfare of mankind—perhaps so

	A		F		U	
	No.	1000 dols.	No.	1000 dols.	No.	1000 dols.
I. Medals and prizes	65	19	1	—	24	20
II. Grants	40	361	8	15,143	66	96
III. Institutional funds	14	255	30	2,322	176	2,056
IV. Fellowships and scholarships	6	34	6	120	263	352
Total	125	669	45	17,585	529	2,524

The most conspicuous figure in this table is the amount of the grants by foundations, etc., and this is almost entirely composed of appropriations (amounting to 15,000,000 dollars) made by the Rockefeller Foundation, New York City, “partly

¹ “Funds available in 1920 in the United States of America for the Encouragement of Scientific Research.” Bulletin No. 9 of the National Research Council, 1701 Massachusetts Avenue, Washington, D.C., March, 1921. 1 dollar.

substantially as to give a new significance to the phrase "Almighty Dollar," and to affect the sociologist's estimate of the social order which has made possible the accumulation of multi-millionaire fortunes.

In a "Subject Index" the bulletin lists all the funds known to be available for the support or encouragement of research in the biological, mathematical, and physical sciences and their applications, and from this index has been prepared the following table, which, though not exhaustive, serves to indicate the subjects more generally favoured by founders and administrators of funds:—

Subjects	No of Funds
Agriculture	12
Anthropology	24
Astronomy	33
Biology	36
Botany	13
Chemistry	57
Engineering	32
Geography	16
Geology, etc.	18
Industrial research	47
Medicine	147
Mineralogy	13
Pharmacology	14
Physics	49
Science, unrestricted (including appropriations of the Rockefeller Foundation)	120
Zoology	14

In the list of nine large endowments already given above, the ample provision for medical research is noticeable. Columbia University has a fund for cancer research producing 70,000 dollars per annum, and four other funds produce 291,000 dollars per annum for medical research. Cornell has 45,000 dollars per annum for research in veterinary medicine. Pennsylvania has lately received 500,000 dollars towards a tuberculosis research institute, and Iowa has a Welfare Research Station Fund for investigating "scientific methods of conserving and developing the normal child," for which it appropriates 25,000 dollars per annum.

A few other noteworthy funds may be particularised:—

Anthropology and Natural History.—Bishop Museum of Polynesian Ethnology, etc.: Research funds, 75,000 dollars per annum.

Bio-chemistry.—Leland Stanford Junior Food Research Institute: 700,000 dollars provided by the Carnegie Corporation for its support for ten years.

Engineering and Industrial Research.—United Engineering Societies' Fund, 500,000 dollars (capital). American Society of Heating and Ventilating Engineers: 21,000 dollars per annum for five years. Du Pont de Nemours Company Fellowships for Research in Chemistry in twenty-one universities: 750 dollars each.

Science, unrestricted.—Smithsonian Institution, Washington: Founded 1846, present fund 975,000 dollars. Brooklyn Institute of Arts and Sciences: Fund for research purposes of the museum, 600,000 dollars.

Mention may also be made of two foundations having an international character:—The American Field Service Fellowships for research in French universities: 30,000 dollars per annum; and the American Scandinavian Foundation, providing twenty travelling fellowships of 1000 dollars each.

The publication of this interesting bulletin provokes the question, What similar lists have been published in other countries? Particulars of scholarships, etc., open to graduates are to be found in the "British Empire Universities' Yearbook," and it is understood that in the next edition information regarding other funds available for the encouragement of scientific research will be given; but in the meantime the only published lists comparable with those given in the bulletin are, it is believed, the lists of "Encouragements et Aides Financiers" included in a recently published work by MM. Tassy and Léris called "Les Ressources du Travail Intellectuel en France." The annual value of prizes distributed in France by the national academies and by societies dependent on private initiative is stated to exceed 1,500,000 francs, and an almost equal amount is said to be devoted to subscriptions to missions, travelling fellowships, and other aids to research.

Obituary.

LORD REAY, formerly Governor of Bombay, and an active worker for intellectual interests in many directions, died on August 1 in his eighty-second year. From a detailed notice in the *Times* we extract the following particulars of his career: Born on December 22, 1839, Lord Reay was educated at the Gymnasium at The Hague and at the University of Leyden, where he graduated in laws. In 1866 he made a tour through the

United States for the purpose of studying the social and political condition of the country at a particularly interesting period of reconstruction. On his return to Holland he was elected president of a Society for the Promotion of Manufactures and Handicrafts, and in that capacity he organised the first industrial exhibition which was ever attempted in Holland. In 1871 he was returned to the Chamber of Representatives of the States-

General as Liberal member for Tiel, and again in 1875, the year in which his father succeeded to the Scottish title of Reay, on the death of the ninth baron. In 1877 he resigned his seat in the Dutch Chamber of Representatives, and became naturalised as a British subject. He was created a baron in the peerage of the United Kingdom in 1881, and in 1884 was elected rector of St. Andrews University.

In 1885 Lord Reay was appointed Governor of Bombay, where he brought about an amelioration of the Forest Laws, which gave universal satisfaction to the natives. Foremost among other questions which arose for solution was that of education, a subject which was always of the greatest interest to Lord Reay. His policy was to substitute local control for direct governmental supervision, to establish grants in aid in place of payment by results, and to develop a modern side in secondary schools. Technical education received a great impetus, and a permanent memorial of its development is the Victoria Jubilee Technical Institute for Mechanical Industries at Bombay. His Governorship ended in 1890, and his services to the Presidency were commemorated by the erection of a marble statue in Bombay.

Afterwards, as president of University College, London, of the Institute of International Law, and of the Franco-Scottish Society, and as member of the Senate of London University, Lord Reay found full scope for his energies. He became the first president of the British Academy in 1901, and was president also of the Royal Asiatic Society. On the resignation of the late Lord Londonderry in 1897 Lord Reay was unanimously elected chairman of the London School Board, a post which he retained until the abolition of the Board in 1904.

MR. WILLIAM TAYLOR, of Lhanbryd, who died recently at Elgin, aged seventy-two, was a most active zoologist and geologist, and made many contributions to science. Trained as a pharmaceutical chemist, he emigrated early in the 'seventies to Texas, where in the intervals of business he devoted much attention to the reptiles and small mammals. He corresponded with the British Museum, to which he sent many valuable specimens, accompanied by notes on their mode of life. In 1892 Mr. Taylor returned to Scotland, and henceforth lived in retirement in his native village of Lhanbryd. Here again he studied the mammals, especially the cetaceans stranded on the coast; but his most important work was the collection of fossil reptiles from the Triassic sandstone of Morayshire, and of fossil fishes from the Old Red Sandstone of the same county. Some of his fossils were sent to the Royal Scottish Museum, Edinburgh, where they were described by Dr. Traquair, but the greater part of his collection was acquired by the British Museum, where much of it was described by Dr.

G. A. Boulenger and Dr. Smith Woodward. Several new species were named after him. Until 1914 Mr. Taylor made an annual tour to the south as far as London, thus keeping in touch with those who were interested in his researches, and he often attended the meetings of the British Association. He did not write much himself, but was always a keen observer, and gave valuable help to those who published technical accounts of his discoveries. He also did much to spread an interest in natural science in the district in which he lived.

THE death is announced of DR. J. E. BLOMFIELD at Sevenoaks on July 8. Dr. Blomfield was educated at Winchester, and later at the University of Oxford, where he obtained a demyship at Magdalen College in natural science. He afterwards entered the medical course, was elected Radcliffe travelling fellow, and worked at Jena, Vienna, and Paris. His clinical studies were pursued at University College Hospital, where he became house physician. On the advice of friends Dr. Blomfield decided to enter general practice, and from 1889 onwards practised at Sevenoaks. He was an accomplished microscopist, at an early date in his career published a paper on spermatogenesis, which attracted the attention of Charles Darwin, and later made a number of notes on, and preparations of, new growths in trees.

THE death is announced, at the age of sixty-one, of PROF. FRANCIS BACON CROCKER, professor of electrical engineering at Columbia University from 1893 to 1914, and president of the American Institute of Electrical Engineers in 1897. Prof. Crocker's work in the standardisation of electrical equipment throughout the world won him high praise from Lord Kelvin. He was the author of books on electric lighting, electric motors, the management of electrical machinery, and related subjects.

DR. W. E. STONE, whom a cablegram in the daily Press reports to have lost his life in the Assiniboine Mountains while trying to carry his wife up a cliff from which she had fallen, had been president of Purdue University, Indiana, since 1900. He had previously been professor of chemistry in the same institution, and earlier still had been officially employed as a chemist by the States of Massachusetts and Tennessee. He had published reports of numerous researches upon the carbohydrates. Dr. Stone was in his sixtieth year.

WE regret to see in the *Times* of August 2 the announcement of the death of PROF. EDMOND PERRIER, member of the Paris Academy of Sciences and of the Academy of Medicine, and honorary director of the Paris Museum of Natural History.

Notes.

THE French Association for the Advancement of Science is meeting this week at Rouen under the presidency of M. Rateau. The scientific proceedings of the association will be carried on in twenty-two sections and sub-sections. There will be two lectures—one on the synthesis of ammonia by M. G. Claude, and the other on aviation of to-day and in the future by M. Bréguet.

THE council of the Museums Association has elected Mr. T. Sheppard, of the Municipal Museums, Hull, as president of the association for 1922-23.

DR. D. SEGALLER, who has been with the British Dyestuffs Corporation, Ltd., since the firm of Messrs. Read Holliday and Sons was acquired by British Dyes, Ltd., is severing his connection with the Corporation. As head of the technical department he has been in charge of a staff of chemists engaged on research on various problems connected with the activities of the Corporation.

A DESCRIPTION of ball lightning seen in the sky at St. John's Wood during a thunderstorm in the early morning of June 26 has recently been received at the Meteorological Office. The phenomenon, a large incandescent mass floating in the air below the clouds and apparently stationary for some minutes, is of great rarity, and the Director of the Meteorological Office, London, S.W.7, would be greatly obliged if persons who observed it on this occasion would communicate with him. Prof. I. Galli has brought together a number of observations of globular lightning recorded in classical literature, as well as many from modern scientific publications, and has described them in several papers issued by the *Portificia Accademia dei Nuovi Lincei* of Rome.

IN consequence of the retirement of Sir Hercules Read, the department of the British Museum hitherto known as the Department of British and Medieval Antiquities and Ethnography has been divided, and the following appointments have been made by the principal trustees:—Mr. O. M. Dalton to be Keeper of the Department of British and Medieval Antiquities; Mr. R. L. Hobson to be Keeper of the Department of Ceramics and Ethnography; Mr. T. A. Joyce to be Deputy-Keeper in the Department of Ceramics and Ethnography. Mr. Reginald Smith, hitherto Deputy-Keeper in the undivided department, becomes Deputy-Keeper in the Department of British and Medieval Antiquities. The prehistoric collections fall into the Department of British and Medieval Antiquities, and the Oriental collections into that of Ceramics and Ethnography.

ON Thursday, July 21, a memorial was unveiled in the public gardens at Dartmouth to the memory of Thomas Newcomen, the great pioneer of the steam engine. Newcomen was born in Dartmouth in 1663; he followed the trade of blacksmith there, and was also a Baptist preacher. He appears to have been associated with Thomas Savery in his work on the use of steam, but to Newcomen belongs

the credit of developing the cylinder and piston steam engine, the first one being erected near Dudley Castle in 1712. By 1716 similar engines were at work in Staffordshire, Warwickshire, Cornwall, and Flintshire, and the engine had no rival until the time of Watt. One or two Newcomen engines were at work until the beginning of the present century. During the latter part of his life Newcomen lived in London, and he died there on August 5, 1729. He was buried in the Bunhill Fields burying-ground. The memorial at Dartmouth consists of two engraved brass tablets mounted on a large rough granite block. After the memorial had been unveiled by the Mayoress, Mrs. C. Peek, a wreath was placed upon it as a tribute from the Newcomen Society, which was formed last year to further the study of the history of engineering and technology.

COL. HOWARD BURY's latest dispatch from the Mount Everest expedition to the *Times* is dated from Tingri Dzong on June 26. It describes the fortunes of the expedition during the march from the Arun Valley up the valley of the Bhong. On the way a visit was paid to Shekai Dzong, an important administrative centre and the site of a large monastery. Major Morshead and his surveyors have already mapped some 25,000 square miles of new country along the route of the expedition. Rinderpest in the Bhong Valley necessitated the use of donkeys only for transport, but they proved quite satisfactory. Tingri Dzong, which is to be the main base of the expedition, is forty-four miles in a direct line from Mount Everest, which rises gradually from the plain of Tingri Maidan without any intervening ridges. Some six weeks will be spent at Tingri and its neighbourhood in reconnoitring the slopes, and the expedition will then move to Kharta to spend another six weeks examining the valleys on the east and north-east of Mount Everest. Mr. A. F. R. Wollaston has rejoined the expedition after accompanying Mr. Raeburn back to Sikkim, and later will visit the neighbourhood of Gosainthan for botanical researches. Col. Bury says that the western slopes of Mount Everest appear to be very much steeper than had been anticipated, but he believes that the east and north-east slopes present the fewest difficulties. The weather was cloudy, and the expedition was getting few distant views.

THE first technical session of the International Commission on Illumination, the successor of the International Photometric Commission, was held in Paris on July 4-8. Those interested in illumination problems in Belgium, France, Great Britain, Italy, Spain, Switzerland, and the United States of America were represented at the session, which was opened by the Minister of Public Works, who welcomed the delegates in the name of the French Republic. The British delegates, nominated by the National Illumination Committee of Great Britain, were:—Major K. Edgcombe (Institution of Electrical Engineers, chairman of the National Committee), Mr. C. C. Paterson

(hon. secretary and treasurer of the International Commission), Mr. A. P. Trotter (Illuminating Engineering Society), Dr. E. H. Rayner (National Physical Laboratory), Mr. L. Gaster (Illuminating Engineering Society), Mr. R. Watson (Institution of Gas Engineers), and Mr. J. W. T. Walsh (National Physical Laboratory, assistant secretary of the International Commission). The subjects dealt with by the Commission were as follows:—(1) The unit of candle-power at present in use in this country and in France and the United States was adopted for international purposes, and is to be known as the "international candle." It is maintained by means of electric incandescent lamps at the National Laboratories of the three countries named. (2) The definitions of the terms "luminous flux," "luminous intensity," and "illumination," and the units of these quantities, viz. the lumen, the candle, and the lux (metre-candle), were agreed upon. (3) The subjects of heterochromatic photometry (including physical photometry and the characteristics of the "normal eye"), factory lighting, and automobile head-lighting were also discussed at the meetings, and sub-committees were appointed to study the questions from the international point of view during the next three years. The new president of the Commission is Dr. E. P. Hyde, director of the Nela Research Laboratories of America, and Major Edgcumbe is one of the three vice-presidents. The next meeting of the Commission was provisionally arranged to be held in New York in 1924.

CORRESPONDENCE has recently appeared in the *Times* on the subject of State awards for medical discovery. Sir Ronald Ross urges (July 13) that a system of small pensions, somewhat on the lines of Civil List pensions, ought to be established in order to compensate medical men and others for work which has been of advantage to the public without being remunerative to themselves, the medical profession rightly objecting to medical discoveries or inventions being kept secret or monopolised by those who make them. Sir Ronald Ross mentions an example:—Dr. H. made during the war valuable additions to our methods of diagnosis by X-rays, particularly by the use of a cardboard scale. He appealed to the Royal Commission on Awards to Inventors, but was refused an award on the ground that the chairman had "such a high esteem of the noble ideals which the medical profession had adopted in forgoing personal advantage, giving their services free, and so on, that he was in favour of maintaining this spirit, and altogether against the idea that the Royal Commission could be persuaded to give an award to a member of the medical profession." This means, as Sir Ronald Ross pertinently remarks, that while the inventors of life-destroying devices may be rewarded by the State, those of life-saving devices are to be rigorously excluded! To this Mr. Tindal-Robertson, Secretary of the Royal Commission on Awards, replied (July 15), quoting the general practice of the Commission, and stating that in the particular case of Dr. H. the ordinary principle was held to apply, that the sale of any article, whether patented or copy-

righted or not, necessarily includes the right to use the article. Sir Ronald Ross replied to this letter (July 28), admitting that the Royal Commission, on the grounds laid down, could not help, but urging that the powers of the Royal Commission should be enlarged so as to enable it to deal with the claims in question. He quoted the precedent of Edward Jenner, who received a grant of 30,000*l.* from the State. It is noteworthy that the British Science Guild and the British Medical Association last year advocated the payment of pensions on the lines suggested by Sir Ronald Ross, and that the latter body reaffirmed the principle at its annual meeting in July.

RECENT excavations at Pompeii, which have been in progress since 1911, have disclosed what may one day prove to be the most interesting part of the city, but the results are still jealously concealed from the visitor. A correspondent of the *Times* of July 26 is, however, in a position to supply some information regarding them. Passing through the well-known Strada dell' Abondanza, a comitum or crossing of two streets is reached, where there is a large sacred picture. Such places were held sacred, and were generally marked with sacred pictures and an altar, where propitiatory sacrifices were made to the Lares, who had houses and street-crossings under their special protection. The fresco now unearthed is divided into three sections, the first representing the twelve Penates or city guardians, beginning with Jupiter and Juno and ending with Diana. To the right of this painting, which is probably more interesting than any other found at Pompeii except that of the Villa Dionysius, is a sacrificial scene in which a large-winged demon serpent, the emblem of the Lares, is seen approaching the altar with two eggs and a pine cone as a bribe to it to avert the Evil Eye. Beneath is a real altar of masonry, on which are still preserved the ashes of the last sacrifice that was offered before the fatal August 24, A.D. 79. Archaeologists will await with much interest the publication of these important discoveries.

IN a communication to the Ipswich and District Field Club Mr. Reid Moir describes the excavation of several barrows (sepulchral mounds) on Brightwell Heath, near Ipswich. Within a radius of 8 ft. in the middle of one, on the original ground-level, were found fragments of a pottery beaker dating from the early Bronze age and a number of flint scrapers and other implements, which the author claims to be able to distinguish from Stone-age specimens by an examination of their flaked areas. The study has hitherto been complicated by the habit of collecting *all* the worked flints from a barrow, whether belonging to a burial or scattered at random in the soil thrown up to form the mound, and possibly of much earlier date. Full-size drawings are given, with side-views and an analytical table of the 152 scrapers and 106 flakes found. Another barrow contained a burial of the earliest Anglian period, about A.D. 460, with a thin bronze bowl containing the cremated bones and originally covered with linen secured by a cord under the rim; also a bone comb and ornamented bone disc-

closely resembling those found at Felixstowe, and now in the British Museum. The bronze bowl further contained part of an ivory armlet, two glass beads, and a clay draughtsman. Altogether an exceptional find that opens up a prospect of further successes on the Suffolk heaths.

MR. E. E. GREEN contributes to the July issue of the *Entomologist's Monthly Magazine* part vi. of his "Observations on British Coccidæ." In the present article three species of *Eriococcus* are described as new to science. *E. glyceriae* is based upon specimens obtained from *Glyceria maritima* growing at Blakeney Point, Norfolk; *E. placidus* was obtained from a species of grass (? *Festuca*) at Thurnham, Kent; and the third new species, *E. pseudinsignis*, occurred on a similar food-plant in the same locality. Mr. Green has added much to our knowledge of British scale-insects during the past few years as the result of painstaking field observations. Although the family includes some of the most destructive of all insects, the British forms, excepting the common mussel scale and a few other kinds, are seldom observed unless by the trained specialist. In the same periodical Mr. J. E. Collin continues his descriptive keys of Anthomyid flies of the genus *Limnophora*, Desv., inhabiting our islands.

AN interesting article on the biology and genetics of the very common ladybird beetle, *Adalia bipunctata*, is contributed by Mrs. O. A. M. Hawkes to the Proceedings of the Zoological Society for December, 1920. It is found that, although this beneficial insect will devour many species of aphids, it will not, for example, eat the common bean aphid except under stress of circumstances. Difficulties were experienced in the rearing of this and other species of ladybirds in captivity owing to their cannibalistic habit of devouring their eggs, larvæ, and pupæ. *A. bipunctata* has many colour forms, and these varieties offer suitable material for the study of inheritance of normally occurring variations. There is no evidence of dominance in crosses between its two chief forms, the red and the black, but matings of red with red produced only red with two exceptions. In matings of black with black both red and black forms resulted, but it was not possible to guarantee that the females had not had partners prior to the experimental tests.

AMONG the many activities of the late Mr. W. Denison Roebuck, of Leeds, none was pursued with greater determination than the collection of records of the distribution of land and fresh-water mollusca in the British Isles. Beginning in 1877, he was still adding fresh data up to his death in 1919, and the summary results of the 59,000 entries in his books are published in the last issue of the *Journal of Conchology* (vol. xvi., No. 6). No record was admitted to his "census" unless specimens had been seen and verified by referees appointed by the Conchological Society. The distributions ascertained by this accurate and painstaking work are set out in tables under 153 topographical divisions based on those devised by H. C. Watson, and are also shown for more than 150 species in five plates of small, but clear, maps. The whole forms an account which should be of sub-

stantial value not only to conchologists, but also to students of geographical distribution. It is to be hoped that its publication will stimulate naturalists to deal with other groups in the same way, and by collaboration render the enormous mass of data which must exist in individual collections of more general service. British entomology suggests itself particularly as a field in which important results might readily be obtained by systematised effort. Copies of Mr. Roebuck's work may be had from Mr. J. W. Jackson, University Museum, Manchester, at 5s. each.

A MEMORANDUM to the Government of India regarding the probable amount of monsoon rainfall in 1921 was issued by Dr. Gilbert T. Walker, Director-General of Observatories in India, dated June 7, 1921. The monsoon rainfall is affected by previous conditions over different parts of the earth, and these conditions have been on the present occasion unusually divergent. In India the development of the monsoon on the western side of the Peninsula had up to date been less vigorous than usual. Examining one of the features of interest, it is shown that scarcely any snow fell during the preceding winter in Baluchistan and very little on most of the hills of the North-West Frontier Province. The total winter precipitation over these areas is said to be the lowest for at least twenty years. Dr. Walker summarises the conclusions to be drawn from the controlling features with a statement that it would be unjustifiable to attach any importance to indications so feebly marked as those of the present year, and he adds that when their resultant effect is so trifling nothing is gained by attempting to reach a conclusion, and he does not consider the controlling factors decided enough to enable a trustworthy forecast to be prepared.

So far as efficiency and durability are concerned, there does not seem much to choose between the electrical and the mechanical methods of connecting the propellers of a ship with the steam turbines. Excellent results have been obtained by both methods. The electrical method, however, has much greater flexibility. There is no necessity to have the turbines near the shaft, and its direction of rotation can be reversed with the greatest ease. In *La Nature* for July 16 L. Jauch, the chief mechanician of the French Navy, compares the two methods, and concludes that the electrical drive will be much the more popular in the future. He points out that five battle-cruisers each requiring 180,000 h.p. and using electrical methods of driving the propeller are being built in America. The author calculates that at maximum power the efficiency of the mechanical type of gearing would be 2 per cent. higher. But this is offset by a 2 per cent. gain in favour of the electric drive at mean speeds and a 20 per cent. gain at low speeds. He points out that with the electric drive there is no fixed relation between the speed of the propeller and the speed of the steam turbine. Hence the latter can always be run near the speed at which its efficiency is a maximum.

THE Department of Commerce, Bureau of Standards, Washington, has just issued Circular Paper No. 100 on "Nickel" (20 cents). This is one of a

series describing the physical properties of metals, together with a discussion of the relation of these properties to the composition and treatment of the materials. In it are described the properties of nickel and of its commercially important alloys: nickel-steel, ferro-nickel, copper-nickel, and nickel-chromium alloys. The pamphlet is illustrated by numerous photomicrographs and curves, and provided with a very complete bibliography. The collection of data will be valuable to metallurgists.

THE Wireless Press, Ltd., announces for early publication a volume by Prof. J. A. Fleming, who was recently awarded the Albert medal of the Royal Society of Arts in recognition of his many valuable contributions to electrical science. Under the title "Fifty Years of Electricity: The Memories of an Electrical Engineer," the work will record the pro-

gress of electrical engineering since 1870, the year in which Prof. Fleming attained his majority.

THE catalogue of optical instruments recently issued by Messrs. Adam Hilger, Ltd., 75A Camden Road, London, N.W.1, contains details of a number of instruments not previously obtainable in this country. Amongst them may be noted a monochromatic illuminator, an infra-red spectrometer, a vacuum spectrograph, a linear thermopile, a spectrophotometer, and several refractometers. Messrs. Hilger are offering a limited number of their instruments at a special reduction of 20 per cent. off their current prices.

ERRATUM.—We regret that the price of the fifth edition of Sir J. J. Thomson's "Elements of the Mathematical Theory of Electricity and Magnetism" was incorrectly given in NATURE of July 21, p. 647, as 30s. net instead of 25s. net.

Our Astronomical Column.

DISPLACEMENT OF LINES IN THE SPECTRUM OF VENUS.—The *Astrophys. Journ.* for June contains a paper by Dr. Chas. E. St. John and Mr. Seth B. Nicholson, in which they test the result announced by Mr. Evershed that his Venus spectrograms supported the view that the earth exerts a repulsive effect on the solar gases, analogous to that which the sun appears to exert on comets' tails. The authors took two series of Venus spectrograms: in 1919 with Venus east of the sun, and in 1919-20 with Venus west of the sun. Their analysis of the results leads them to conclude that the effect can be correlated with the altitude and the angular diameter of Venus; hence they conjecture that it is due to atmospheric dispersion, the centre of the visual image which was adjusted on the slit differing from the centre of the photographic image. They propose in future to take some further plates viewing the image through a blue screen, which should eliminate the above source of error. They have incidentally examined the measures to see if they afford any evidence of a rapid rotation of the planet, but conclude that "the difference between the morning and evening series . . . is not of an order that would indicate . . . a rate of rotation higher than that found by Slipher." In all the plates of the series, whether on Venus, the sky, or the sun, an iron-arc spectrum was photographed simultaneously.

PLANETARY PHOTOGRAPHY.—Pubns. Ast. Soc. Pacific, June, 1921, contains a lecture by Mr. E. C. Slipher on this subject, illustrated by numerous reproductions of photographs of Venus, Mars, Jupiter, and Saturn. Those of Venus failed to record any surface markings, but illustrate the changes of diameter and phase that occur in the synodic period. The photographs of Mars taken at Flagstaff are stated to number 100,000. Numerous exposures are made on each plate, in the hope that some will catch the moments of best definition. Mr. Slipher gives a long list of features that he claims can be verified from the plates. It must, however, be admitted that not all of these can be seen on the reproductions, though they may be visible on the original negatives. The polar cap is shown with great clearness, and it would seem to be worth while to make measures of its position angle in order to obtain an independent determination of the position of the axis.

The photographs of Saturn yield much interesting

information. The great excess of luminosity of ring B over ring A, and the semi-transparency of the latter, permitting the outline of the ball to be seen through it, are well brought out; also the faintness of the ring when the sun is near its plane. There are reproductions of two exposures on April 28 last, when the earth and sun were on opposite sides of the ring-plane. There is a dark stripe across the centre of the disc, formed by the dark side of the ring and its shadow; it is narrowest in the middle, the two edges being curved in opposite directions. One feature shown in all the photographs is the extreme regularity of the fivefold belt in Saturn's southern hemisphere. The edges appear to be exactly parallel to the equator. One is inclined to mistrust this regularity on drawings, but the photographs are free from bias.

MEASUREMENT OF THE DIAMETER OF ARCTURUS.—Mr. F. G. Pease (Pubns. Ast. Soc. Pacific, June, 1921) gives an account of the work with the interferometer on the 100-in. Hooker telescope at Mount Wilson since the successful measurement of the diameter of Betelgeuse. Observations on Arcturus in February and March, with poor seeing, showed some diminution of the visibility of the fringes with increasing distance between mirrors. At length on April 15 the seeing was perfect, and the fringes were found to disappear when the mirrors were separated by 19.5 ft. As the maximum separation at present is 20 ft., it was not possible to proceed to the next point of greatest visibility of fringes; but the value 19.5 is considered to be correct within 0.5. Assuming an effective wavelength for type K α as 5600, the angular diameter of Arcturus is 0.0237", very near the mean of the values estimated by Eddington, Russell, and Hertzsprung. The parallax is taken as 0.116" from the mean of the best recent measures, giving a linear diameter of 19,000,000 miles, or twenty-two times that of the sun.

Observations of Aldebaran on nights of poor definition give grounds for thinking that its angular diameter is somewhat greater than that of Arcturus; Polux and α Ceti give indications of weakened fringes, but probably a longer beam than 20 ft. would be needed to make them disappear. The mirrors have hitherto been moved by hand, which has taken much time. Two screws driven by a single motor are now being mounted, which should greatly facilitate the measures.

The Universities and Technological Education.¹

By PROF. W. W. WATTS, F.R.S.

TECHNOLOGICAL education may be defined as the development of those sides of learning which will enable us to extract the highest possible good from the resources of the world, and in the process to make life at least endurable and, if possible, pleasant to the maximum number of people; to avoid waste and extravagance in both production and use; to keep and leave the world beautiful and peaceful; and to do all this with such a margin of economy as to deplete as little as possible our children's heritage in the earth of which we are but tenants for life.

In the use of every kind of resource, animal, vegetable, or mineral, man has been woefully extravagant, partly through thoughtlessness, but mainly through ignorance. To take their share in improving this state of things is a task not unworthy of the greatest and most ancient universities, as well as of those of newer growth, and of those other institutions which, because of their heart-whole and deliberate devotion to this end, are not yet deemed worthy to be reckoned as universities.

Among the functions of these universities and institutions should be the training of men who are to lead the industries forward in the direction of higher efficiency, smoother and more salutary working, and increased production; men who shall know sufficient of the laws of Nature to extract through their operation all the energy and material to which we are entitled, and who never forget that Time the Avenger, tardy but sure, will exact from them the penalty for any thoughtlessness or neglect.

The Student.

It is fair to demand that the technological student should come from school with a really good general education and the culture which such an education should give. He should have such a knowledge of languages that he can not only use those he knows, but will also be able without great difficulty to acquire any other which may prove essential to him; such an acquaintance with literature that he really understands how to read and extract from the printed word what it is able to give him; facility in writing clearly and intelligently; so much knowledge of geography and history as will enable him to get hold of any information he may require; and a thorough grounding in mathematics and elementary science.

In the study of the group of sciences and arts germane to the professional training, the best that can be done is to pick out in each subject those matters which are common to a number of technological subjects, to teach them to mixed classes of convenient size, and to supplement them where necessary by special additional instruction or direction. The amount of common matter is much greater than is generally supposed, and such courses, if thoughtfully designed, will go a great part of the way. Here the strength of broad-based institutions is manifest, for in them it is possible, without undue expense, to make use of all existing departments. There must necessarily be either incompleteness or waste of effort and overlapping in the case of institutions devoted to a single branch of technology; and such institutions should never be founded unless it has been proved impossible for bodies of university rank to undertake the work.

¹ From a paper read before the Congress of the Universities of the Empire at Oxford on July 6.

Curricula.

It is as well to insist that technology must be based on a thorough knowledge, practical and theoretical, of the relevant sciences treated as pure sciences. In the past most industries have advanced by means of a cumbrous and exclusive course of trial and error. It is only in the more recent developments that advantage has been taken of the principles and general laws worked out by the scientific man in his laboratory, the royal roads in both the pursuit and the applications of science. In future the technologist must be a scientific man, not only in his knowledge, but also in his attitude and outlook. In his life-work he will not be really successful if he is satisfied with things that are. He is to be the introducer of new things in a régime which may fallaciously appear to have reached finality. This he can be only if his knowledge is wide and so ingrained in him that he can make full and practical use of it.

In every science the great aim should be to bring out the principles and the general laws which have been established, the lines of thought and experiment on which they rest, the means by which they can be and have been tested, and the consequences which flow from them. The teaching scheme is thus made easier as well as more efficient, for such principles are common ground, equally necessary to each branch of technological instruction. It is in the illustration of them that the teacher must bring out their contact with the technical practice of industry.

While holding fast to the principles of science, it is essential that the scheme at this stage should be exceedingly elastic and capable of rapid variation to meet the advance of industrial applications. What is at once the hardest task and the severest test of the successful teacher is not how much he can teach, but how much he dare leave out. In any case, he must be firm in meeting the question which few of us escape: "What use is this to me?" He can see farther than his students, farther even, perhaps, than his technical advisers, and he should be able to show that such apparent superfluities are like the hidden strands in concrete, without which the material would fail under some of the stresses it is designed to meet. It is his duty to remember that, whatever may be a student's intentions as to his future, he cannot be sure of controlling that future.

The guidance of technical advisory committees is of inestimable advantage, not only in the later year or years when purely scientific work is merging into the technical applications of it, but also to some extent while pure science is being studied. In both cases, however, their function should remain advisory and never become mandatory. The last word must rest either with the director or principal teacher, or with the faculty of which he is a member.

In the later year or years of the course the instruction will naturally become more highly specialised, and if the previous scientific training has been thorough and sound and the student has learnt how to make practical use of his knowledge, progress will usually be rapid.

It is essential, too, that at this stage, but preferably earlier as well, the student should be trained in writing of what he has learnt, or in summarising the results obtained by his own practical work, in clear and concise and, if possible, non-technical language which can be easily understood by the type of man under

whom his professional work will be carried on. By this he will be able to display most clearly how much of his work he has really grasped and how far he sees into its consequences, while he will, at the same time, be acquiring a gift of great service to him in his career.

Touch with Industry.

It is a vital question at what stage contact with industry should be initiated. Until a student knows some of the features of the industry in which he will be engaged, he finds it difficult to realise the significance of many parts of his training. On the other hand, if he goes into the shops, the works, or the mine too soon, he is not possessed of enough knowledge to profit fully by his experience. The advantage of early touch outweighs its disadvantages, and contact should begin early, and be renewed at several stages of the course. The student may at first gain little actual knowledge in the mine or workshop, but in working there for a period by the side of the men whom he will afterwards direct he will gain a most valuable knowledge of their customs and limitations, their predilections and weaknesses; and he will be laying down a foundation of experience which will usefully guide him when he comes to the difficult task of handling men himself. At the same time, while watching the technical skill of the expert workman, he will acquire respect for accuracy and delicacy of workmanship and for that astonishing proficiency which prolonged practice alone can give. What is of scarcely less importance is that at this stage he will hear a whole gamut of technical nomenclature which has before been mere jargon to him, if he has met with it at all. No one is more intolerant of the phraseology of the expert than the "practical man," but no one is more tenacious of his own terminology. It is well that the student should learn the latter while he is still in the position of the under-dog, so that it may not trip him up later. As his course proceeds it is natural that workshop and field experience will become of greater educative value. He will be entrusted with higher work and so gain new experience.

Directors and Teachers.

One of the greatest difficulties in the future, as it has been in the past, will be the staffing of technological departments. Such departments must be directed by the right kind of men—men not only of good intention, but also of wide industrial knowledge, capable of dealing with students and of organising their staffs; men of ideas and energy, devoted to their own research and that of others; and, above all, men of achieved success. There seem to be but three ways of securing such men: (1) To pick the right man whenever and wherever found, pay him his price, and leave him to teach as and what he thinks best and to select his *personnel* and material, as well as his methods and lines of research; (2) to take from the industrial side men who have made their mark and a competence, but, from interest in their subject and love of the work, are willing to continue in harness in what is one of the pleasantest, if not the least exacting, of professions; or (3) to select competent and trustworthy men who have found touch with industry from the academic side, and to allow them to supplement their pay by private professional work conducted under proper restrictions. Under present conditions the universities will have to fill their posts from the last two classes.

Subordinate staffs have also to be considered. Here again the pay is generally inadequate to secure the services for long periods of the most desirable men, and it is arguable that it is well this should be

so. There are many inducements to attract men to the staffs of applied science departments: the continuation of their technological education and the possibility of obtaining higher degrees, the developing of their teaching ability, the opportunity of increasing their proficiency in research and improving their status and reputation thereby, the earning of additional pay by carrying out industrial work of research character or otherwise, and the introduction to, and contact with, industrial men who will eventually have research work to dispose of or employment to offer. It is essential, however, that means should be provided to retain some, and those not the least promising, for longer periods in order to give stability to the department and to the head of it the responsible support which he is entitled to look for.

It will also be to the advantage of every department that it should be sufficiently strong to allow one or other of its members to take an occasional period of time for the purpose of study, research, or even business work. This would react not only on the value of the teaching, but also in spreading the reputation and increasing the efficiency of the department by maintaining closer touch between it and the business world. If well managed, it need not involve heavy additional cost. It is chiefly a question of organisation and of a liberal outlook.

Research.

It is essential that research should form part of the curriculum of every technological student. Whatever his future career, in addition to routine work, it is certain that he will come across new conditions and new difficulties, something for which he may have met no precedent—problems, in other words, which need to be investigated on scientific lines before they can be solved. It is not essential that the research should be other than of a purely scientific nature. What is essential is that he should get to realise that the easiest and quickest way may often be to obtain facts and inferences at first hand, that he should learn how to question Nature, and acquire confidence that, if he can put his questions skilfully, he will usually obtain, after Nature's way, an answer which will contain, though it may conceal, the solution to his problem.

It is still more necessary that the teachers should engage in research, and naturally this in most cases would have some more or less direct bearing on industrial problems. Apart from the fact that only a man engaged in the production of new knowledge can be a really first-class teacher, in no other way can he establish contact with the highest development of the industry in which he is interested and thus secure the confidence and respect of those engaged in it. An active research school is the best symptom of a live and active technological, as it is of a scientific, department; it tends to attract the right kind of student, trains the best kind of staff, and is a legitimate way of keeping the department before the eyes of business men.

If it is possible to pass the best students on to the staff for a short period before they take up outside appointments, and to afford them reasonable leisure to embark upon research, the school will be much strengthened and the worth of the students considerably enhanced. A certain amount of teaching work is by no means a drawback, for it will enable them to consolidate their knowledge and render it more accessible when wanted. A larger staff than otherwise may be thus maintained, and the department will be more stabilised in the event of having to face the possible loss of one or more of its senior members.

Another consequence of a strong research school will be to attract from outside those engaged in industry who have special problems of their own to solve which cannot be so well dealt with in the laboratories to which they have access in works or elsewhere. This should, of course, receive encouragement. The introduction of outsiders of the right kind to the laboratories is of service in several ways. It "spreads the light" by keeping industrials informed as to the progress of science and the improvements of methods of investigation, and as to the precise nature, cost, and limitations of scientific inquiry. It impresses upon them the necessity for experimental accuracy, and shows how closely the sciences are now interwoven, and how results obtained in one science or branch may be imported to assist progress in another. Better relations are established between the institution and the industries surrounding it, mutual confidence is engendered, and personal acquaintance is encouraged to the advantage, on one hand, of the industries, and, on the other, of the students who may find eventual employment therein.

A corollary is that in certain cases research by staff or students may be in part carried on in works laboratories outside the university, and the considerations just set out apply as well to this case. Care is requisite that industrial research should not degenerate into anything of the nature of routine or testing work. This should be excluded, and the universities should not in any way compete with firms which specialise in this direction. Only where this class of work involves problems which are new or exceptionally difficult, or need the employment, or even formulation, of new principles, should it be undertaken by university departments.

The Product.

The type of man which it should be the aim of the universities to turn out should possess those qualities which distinguish the best type of scientific man—not merely knowledge of his subject and technical ability to use that knowledge, but capability to introduce the scientific method into his conduct of everyday life and into his dealings with his colleagues and subordinates. He must be willing to study *all* the conditions of his problems before he is sufficiently satisfied with their solution to carry them into effect. These conditions require, not *a* solution, but *the* solution which can be brought into operation with the least possible disturbance of the things that are, without needless change of raw material, machinery, or *personnel*, but with the advantage of diminished cost, enlarged production, and increased value or efficiency.

If this is the aim, the product will be the best type of technologist. He will not necessarily be the type of man suited to occupy immediately the highest position in his business. But the work given him to

perform will be so well done that it will be impossible for his character, competence, and ability long to escape the watchful attention of his chiefs. It will not be long before he is chosen for more and more responsible work until he attains high rank in his profession. I do not believe it is possible that men of managerial type, captains of industry, will ever be technically trained as such. The universities should endeavour to produce such a type of man that his superiors will take him by force, and almost against his will, from his technological work to direct the bigger issues.

Conclusions.

(1) As much as in any other walk of life, the education of the business man must be a liberal one. His mind must be as agile, and he must be as well provided with intellectual weapons, as any other well-educated man.

(2) A course of technological education thoughtfully laid out is, as an instrument for mind-training and in the nature of the product turned out, in no way inferior to the higher branches of language, literature, history, or philosophy. The work is as hard, the problems to be solved as difficult, the reasoning as acute, the intellectual joy in success as great; while its urgency to the nation and to mankind is one of the most pressing matters that educationists have to face.

(3) In the multiplicity and complexity of subjects there is no longer time for the most liberal of educations to be as broad as heretofore. Some universities are even specialising in a single dead language as an honours subject, holding, perhaps rightly, that a thorough knowledge of one is better than what can be attained, in the time available, of two. Technological education has anticipated this specialisation only by a few years.

(4) There is no less worthiness and dignity in the newer education than in the old. All higher education is, and always has been, technological. The learning of the older universities has been used, and has even been moulded for the purpose, to equip the parson, the poet, and the politician; and both the peer and the proletarian can gain from the study of classical literature some facts or theories to guide them in their respective vocations.

(5) The business man has good right to demand that institutions of university rank shall supply his demands as well as they have dealt with education for the professions. The polytechnic system has not had the success that was expected in educating his foremen and workmen. He must not be again disappointed when he seeks higher education for himself. He expects, and has a right to expect, that the type of education he needs shall be, not a by-play or a by-product, but a worthy aim in itself; and if the universities will not give it to him, he will take his own steps in the matter.

The Exploitation of Irish Peat.¹

By PROF. HUGH RYAN.

THERE are about 6,000,000 tons of turf used every year in Ireland, but this quantity is almost insignificant in comparison with the total amount, about 4,000,000,000 tons, which can be won from the bogs of the country. The Irish Peat Inquiry Committee, of which the present writer was a member, was appointed

to suggest what means should be taken to ascertain the conditions under which the peat could be profitably won, prepared, and used in the most favourably situated localities. The main report of the Committee, which is contained in the publications under notice, recommended the purchase by the State of a large bog in which hand and mechanical methods of winning peat could be tried side by side. These tests would require to be continued over a long period if

¹ "The Winning, Preparation, and Use of Peat in Ireland." Reports and other Documents. (Fuel Research Board. Department of Scientific and Industrial Research, 1921.) 35.

they were to give trustworthy data, and they would have resulted in the winning of large amounts of peat, for which there would be little prospective market. With the view of decreasing the net expense of the experiments and at the same time of testing, on an adequately large scale, the commercial possibility of utilising peat for the generation of electric power, the Committee suggested the installation of an electric power station on a suitable area of the Bog of Allen, within 25 to 40 miles from Dublin. A portion of this power could be used locally to drive the peat-winning machines or agricultural machinery, in chemical industries, such as the manufacture of calcium cyanamide, and for lighting and power purposes in the neighbouring towns. The excess of electric power could be transmitted in bulk to the power station at Dublin.

As a result of a conference with the Fuel Research Board the Irish Committee submitted a much less ambitious, if less satisfactory, scheme, which con-

A serious obstacle which confronts everyone who attempts to devise a scheme for winning peat on a large scale is the labour difficulty. The peat-fuel season, depending on air-drying as it must do for commercial reasons, lasts only about four to six months of an average year. It is not easy, therefore, for the peat industry to attract the labourers required by it from other industries which offer them constant employment throughout the year. This applies especially to the men required for cutting and spreading the peat. Much of the work of the drying operations can be done by women and boys, who are in general available during the late summer months in any more or less thickly populated district. One of the chief problems which the Peat Committee had to consider was, therefore, how to limit so far as possible the number of men necessary for the winning of a definite quantity, say 250 tons, of turf each day of the cutting season (120 days). The same difficulty was experienced abroad, and was, to some extent, met there by the

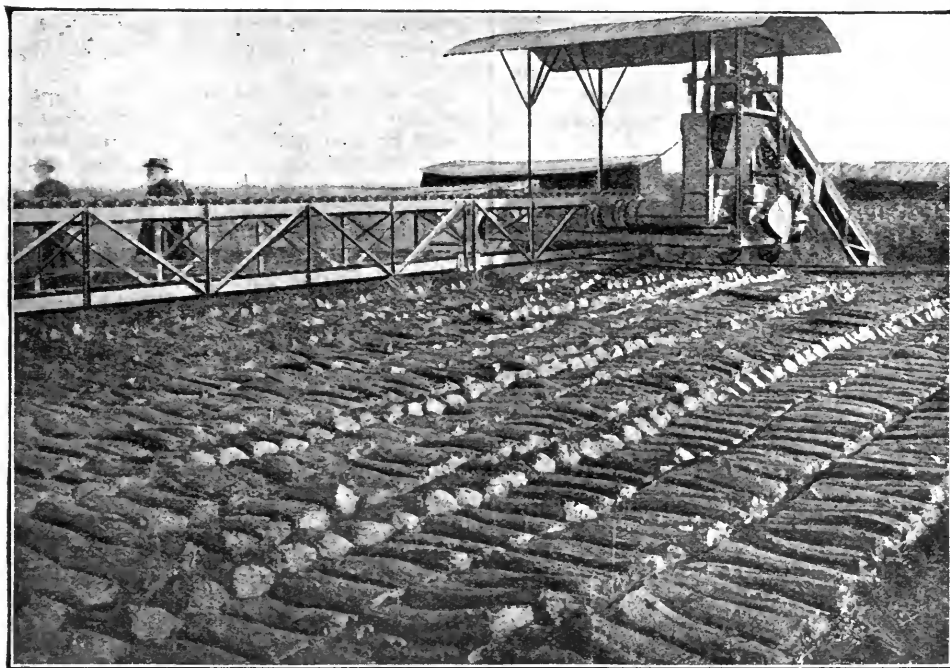

FIG. 1.—Baumann's automatic peat machine.

sisted briefly of the purchase of a bog of about 10,000 acres at a price of about 2*l.* an acre, and the establishment in it of an experimental station to test the various methods proposed for winning peat. Even on this scale a considerable number of labourers would be required, and in order to encourage these to settle in the district the Committee proposed to have experiments conducted by the Department of Agriculture for Ireland on the reclamation of cutaway and virgin bog. The Fuel Research Board approved in general of this scheme in 1918, but the agricultural portion of the scheme was referred to the Irish Department of Agriculture about two years after the Peat Committee had submitted its report. The present publications contain also the report of the Sub-Committee on agricultural matters appointed by the Department of Agriculture. Owing to this unfavourable, and to a large extent unjustifiable, report of the Sub-Committee, it is not proposed to carry into effect the recommendations of the Irish Peat Inquiry Committee with regard to the winning of peat.

introduction of labour-saving devices such as the automatic machines of the Baumann and Wielandt types.

The Baumann machine consists of a ladder dredger which scrapes the peat off the inclined face of the bank and conveys it to the hopper of the cylindrical mixer and macerator, shown on the right-hand side of Fig. 1. The peat is pressed through the mouth-piece of the macerator as a rectangular band which is automatically cut into sods. The latter are caught on plates moving in a lattice girder, extending about 120 metres over the adjacent drying ground. When the lower half of the continuous chain of plates is completely filled with sods, these are tipped on the drying ground and the emptied plates return to the macerator over the upper portion of the latticed girder. One of these machines in Raubling Bog, Bavaria, attended by a gang of five men, had a daily output of spread sods corresponding to 55 tons of air-dry turf. Its dredger was driven by a 20-h.p. electro-motor, its macerator by a similar motor of 40 h.p., and the cost of the complete machine was 1500*l.*

The Wielandt machine is similar in principle to the Baumann, but lighter in construction, largely owing to the adoption in it of a different spreading mechanism. The machine can be driven by a 25-h.p. electromotor, and its total cost, including motor and cables, was 1000l. four or five years ago, but is now much higher. During the war it was found at Elisabethfehn, in Oldenburg, that one of these machines, attended by one man and three or four youths, had an output in the season of 7000 tons of air-dry turf.

If the statements made abroad with regard to the efficiency of automatic machines are correct, four of these machines, attended by sixteen men in all, can dredge, form into sods, and spread in a day enough

peat to yield, when air-dry, about 250 tons of turf. The same output of peat, cut and spread, by the method ordinarily practised in Ireland requires about 160 men. It is therefore a matter of great importance for the winning of peat on a large scale in Ireland that these claims should be subjected to a prolonged test under the conditions obtaining here. In conclusion the writer must again express his regret that the recommendations of the Peat Inquiry Committee were ultimately set aside for reasons which are in part due to misinterpretation of the Peat Committee's report, and in part to statements which were made by the Agricultural Sub-Committee, and are in sharp disagreement with the actual facts, in regard to the extent and the purchase price of Irish bogs.

Geophysical Problems.

A SURVEY of research problems in geophysics has recently been published by the American Geophysical Union, a body which acts as the Committee on Geophysics of the National Research Council, and as the United States National Committee of the International Geodetic and Geophysical Union. The survey consists of a series of seven essays by the chairmen of the several sections of the union, dealing respectively with geodesy, seismology, meteorology, terrestrial magnetism and electricity, physical oceanography, volcanology, and geological physics and chemistry. It is interesting to observe that the two latter subjects, so little studied in this country, are in America found sufficiently important to occupy separate sections of the union.

Advance in nearly all these branches of geophysics seems to depend on much the same method of attack, involving on the one hand an enormous amount of organised, co-ordinated labour of observation and measurement, and on the other individual theoretical study, necessarily of a freelance character, by a comparatively few people with scientific training, insight, and wide knowledge, at research institutes or universities. The first half of the task is being executed with increasing skill and success by the national scientific organisations of the leading countries, but the complementary half lags behind. Dr. C. F. Marvin, for instance, after describing the present achievements and future tasks of meteorological organisations, concludes that "seemingly the greatest need in meteorology is that of a master mind to direct itself comprehendingly and intensively to the great problems which the science still presents." The recency of the beginning made by meteorologists in the study of the upper air, now recognised to be fundamental for the upbuilding of a dynamical science of meteorology, suggests that perhaps also in other geophysical sciences progress may be obstructed by failure to perceive vitally important directions which observation and research must take.

The outstanding task of geodesy at the present time is described by Prof. Bowie as being that of co-ordinating the geodetic triangulations of the various countries by reducing them to a single datum, defined as the adopted latitude and longitude of some one station, the azimuth of a line radiating from that station, and the dimensions of the reference spheroid on which the triangulation is computed. This involves a herculean work of re-computation and readjustment of the triangulation networks, especially in Europe; in America much progress in this direction has already been made. Gravity surveys must be extended over the land surfaces, and a satisfactory method of observation evolved for the ocean areas of

the globe; this will afford information as to the variations of density in the earth's crust, enable the theory of isostasy to be further developed, and thereby lead to ever closer approximations to the figure of the earth.

In seismology the most important world-wide problem is the accurate determination of the time taken by earthquake waves to travel from their origin to other points on the earth's surface; this information is necessary in order that the origin of earthquakes arising in inaccessible (land or oceanic) regions may be determined, and that the velocity and path of the waves within the earth may be deduced, thus throwing light on the earth's internal constitution. Prof. Reid expresses the opinion that the most useful means to this end lies in the improvement of the equipment of existing seismological observatories rather than in multiplication of the present number. The desirability also of methodical studies of limited areas where small shocks are frequent and strong ones occasional is also mentioned, with the view of determining the sequence of events leading up to the rupture producing a strong shock, and possibly of forecasting the region and time of such occurrences.

Dr. Bauer's article on terrestrial magnetism contains some interesting remarks on the progress of the analysis of the earth's magnetic field which is now being made in the department of the Carnegie Institution which he controls. It has been concluded that for many purposes the theoretical formula proceeding in series of spherical harmonics may be restricted to the few most important terms, leaving the residual field, representing continental and more local irregularities, for special study and treatment in accordance with their extent and character. Reference is also made to the important problems afforded by the magnetic variations, both those connected with auroræ and earth-currents, and the rarer ones occurring at times of solar eclipse. The baffling fundamental problems of the origin of the earth's main magnetic field and the cause of its secular variation are also touched upon.

Prof. Littlehales points out the influence which the ocean, being so large an expanse of the substance having the highest known capacity for heat, must exercise as a factor governing the distribution of terrestrial temperature, and the consequent importance of oceanography to geophysics in general. A *résumé* is given of the efforts so far made, by voyages of exploration and by investigations in marine laboratories, towards the study of the oceans in their many aspects; the system according to which progress is now being sought is the study, in detail, of definite oceanic stations periodically revisited every three

months, for the purpose of making synoptic charts of temperature, salinity, gas content, currents, and so on, which it is hoped will prove amenable as material for mathematical investigation of the related phenomena.

In his essay on volcanology Dr. H. S. Washington describes the information which requires to be collected for the systematic study of the subject, and

the programme of a volcanic observing station, such as those which have been established for some years at Vesuvius and Kilauea. The article on geophysico-chemical problems, by Dr. R. B. Sosman, of the Carnegie Institution Geophysical Laboratory, concludes the report, and deals with the investigation of the physical properties and chemical reactions of the substances and aggregates which make up the earth.

Agricultural Research.

“THE Present Position of Research in Agriculture” formed the subject of a lecture delivered by Sir Daniel Hall at the Royal Society of Arts, and reported in the society’s Journal for April 1 (No. 3567, vol. lxix.). Up to the time of the formation of the Development Commission in 1909, agricultural research was entirely unrecognised by the State. A considerable amount of information had been gained from the researches at the Rothamsted Experimental Station, which was started in 1843, and was entirely dependent on the endowment provided by its originator, Sir John Lawes; valuable researches were also being carried on at the Woburn Station of the Royal Agricultural Society, while from 1890 onwards the various agricultural colleges were commencing investigations along many different lines. To work of this kind the State granted not more than a few hundred pounds a year, and the Development Commission was expressly charged with the object of formulating some scheme for the promotion of research. The scheme adopted is now in working order, and by it the field is divided up into a number of subjects, one of which is allocated to each university or institute. By this means research is removed from immediate State control, concentration of effort ensured, and overlapping avoided, and each institute is able to carry out a continuous scheme of work. The question of the State control of research is one which is hotly debated. On one hand it is argued that the State pays, and therefore should control the expenditure; on the other, when the nature of research work is considered, it is obvious that the looser system of control prevailing in a university is much more productive of good work than the rigid methods of a Government department, while the type of man wanted for research is much more attracted to the former than to the latter. Moreover, if research came directly under Government control, then the programme of work would have to be submitted annually to the judgment and criticism of administrative bodies possessing no expert knowledge. That such a procedure is disastrous has been proved many times in other countries.

Another advantage arising out of the association of the research institutes with the universities lies in the co-operation thereby ensured with other workers in all fields of science, so that no matter in what direction the particular research may extend, the advice of men with expert knowledge is always available. It is also of the utmost importance to keep agricultural research in contact with the business of farming, and this is attained most easily through association with a university which teaches agriculture and is in touch with the surrounding farmers.

At present there are under the scheme eight institutes, each dealing with some particular branch of agricultural research, such as plant pathology, fruit-growing, dairying, etc. A research council, consisting of the directors of the various institutes, together with a few independent scientific men and the officials of the Government departments concerned, has been

set up to ensure the co-ordination necessary between the different research centres. To this body also the Ministry is able to submit plans for any large-scale investigations requiring the co-operation of a number of the institutes. An important feature of the scheme has been the provision of a number of advisory officers who are attached to the various agricultural colleges. These men are free from most teaching duties, and are able to give advice and help to the farmers and horticulturists in their area while keeping in close touch with the directors of the related institutes and the officers of the Ministry’s staff. In this way a systematic service is secured capable of dealing with plant pathology, etc., all over the country.

The total funds set aside in the current Estimates for this research scheme amount to 105,000*l.*, against 38,250*l.* for the year 1913–14. This ensures for each institute a definite number of salaried posts with reasonable prospects of promotion, so that agricultural research is no longer an absolute blind-alley employment.

The immensely important subject of animal disease has been very inadequately dealt with, but the many difficult questions involved are being investigated. The Ministry is now supporting a research laboratory at Adlestree, and grants are made to the Royal Veterinary College and the London School of Tropical Medicine for the pursuance of researches in animal diseases.

Having dealt with the organisation of research, the lecturer gave a short account of some of the most important practical results obtained recently from the various institutes. At Rothamsted a valuable investigation has been carried out on the method of the decomposition of farmyard manure. A cellulose fermenting organism was discovered which attacks straw in the presence of active nitrogen. At the same time there is considerable loss of nitrogen, so that it is most essential to protect the ordinary dung-heap from washing by rain, and also, in the case of rich cake-fed dung, it must be got on to the land early if heavy losses of nitrogen are to be avoided. Some of the principles emerging from this work have been very successfully applied to the treatment of sewage. At present the valuable nitrogenous compounds in sewage are mostly wasted, but by passing it through a straw filter bed under certain conditions some 60 per cent. of the nitrogen is removed by the organisms decomposing the straw, which thereby becomes a good manure, and, moreover, the effluent is harmless. Further trials are in progress with the object of making farmyard manure on a large scale without animals.

At Aberystwyth plant-breeding methods are being applied to grasses and clovers, while at Cambridge the scientific breeding of farm crops has given most valuable results; wheats have been produced which add 10 per cent. to the yield of the farm, while some of them combine the strength of the Canadian with the cropping power of the English varieties.

In connection with animal nutrition the Cambridge station is trying to obtain growth-curves showing the relation between the food consumed, the live and dead weight, and the useful meat, fat, and offal for each stage of the animal's development, while the station at Aberdeen is paying particular attention to the importance of vitamins in the nutrition of farm animals.

At Long Ashton and East Malling researches are being made in fruit growing and preserving, so that some quick method of storing fruit for future use may be available whenever a glut occurs in the market. Research on plant disease is being conducted more with the object of producing immune varieties than of finding curative methods. That this is the right line to take is shown by the fact that whereas all attempts to free a soil from wart-disease infection have been unsuccessful, there are certain immune potatoes which will grow without blemish in the most heavily infected soils.

The lecturer remarked that although our organisation for agricultural research is young, and we cannot compare with America or with Germany before the war, either in the number of workers engaged or in expenditure, yet "it is not too much to claim that the majority of really fruitful ideas and conceptions that have recently been current in agricultural science have sprung from English laboratories."

Meteorology of the Philippines.¹

THIS work is rightly claimed in the preface by the director of the Philippine census to be of "great practical value." Observations from sixty official stations and fifty-three voluntary stations have been dealt with, and the maps and plates aid much in the simplification of the large amount of data contributed to the world's meteorology. The elements dealt with are temperatures, rainfall, humidity, cloudiness, wind direction and force, and typhoons.

Temperature is treated, as to both exposure and method of obtaining averages, in a manner quite comparable with the most approved European system. The mean annual temperature for the whole archipelago obtained from stations near the sea level is 26.9° C. (80.4° F.). The seven warmest months are April to October, and the five coldest November to March. May is the warmest, and January the coldest. Tables are given showing in great detail the mean, extreme, and range of temperature at all stations.

Rainfall distribution throughout the year forms the most interesting feature of the weather of the Philippines. The exposure to the prevailing winds occasions great differences in the amount of rain, in spite of the relatively small extent of the archipelago. The winter rains come direct from the Pacific and cause large falls over the eastern part of the archipelago; these are called the north-east monsoon rains. The summer and autumn rains are due chiefly to the influence of typhoons; these rains are most abundant in Luzon and the Visayas. The thunderstorm rains which occur in spring are of little importance compared with the other rains.

The annual means of seventy stations give 2366.1 mm. (93.18 in.) as the annual average rainfall for the Philippines. The annual averages at the several stations range from 4597.6 mm. (181.05 in.) to 989.8 mm. (38.98 in.). The greatest fall is at Baguio, due to its elevation and the local topographical features; the least at Zamboanga. The annual ex-

tremes are very divergent. The heaviest annual fall at Baguio is 9038.3 mm. (355.91 in.) in 1911.

A feature of some interest is the summary of the weather of official holidays in Manila for the sixteen years. This is a step in advance of European official discussions.

C. H.

University and Educational Intelligence.

LEEDS.—The James Edmondson Ackroyd memorial fellowship has been awarded to Mr. F. W. Dry, who will undertake a research on the comparative anatomy, histology, and pigmentation of mammalian hair as a basis for breeding and other experiments. The value of the fellowship is 300l. per annum, renewable for a period of three years.

MANCHESTER.—Mr. J. M. Nuttall, senior lecturer in physics, has been appointed assistant director of the physical laboratories, and Mr. D. C. Henry lecturer in chemistry.

Mr. A. J. Hailwood has been awarded the Moseley memorial prize in physics.

THE Berlin correspondent of the *Times* announces that Prof. Walter Nernst has been elected Rector of the Berlin University.

DR. LIVINGSTON FARRAND has accepted election to the presidency of Cornell University in succession to Dr. J. G. Schurman, recently appointed American Minister to China. After graduating at Princeton in 1888 and at the Columbia College of Physicians and Surgeons in 1891, Dr. Farrand spent two years in study at Cambridge and Berlin. From 1893 to 1914 he was connected with Columbia University, first as instructor in psychology and later as professor of anthropology. He was president of Colorado University from 1914 until after the armistice, when he joined the American Red Cross. In 1917 and 1918 he directed the anti-tuberculosis work of the International Health Board in France. Dr. Farrand was at one time editor of the *American Journal of Public Health*, and has contributed largely to psychological and anthropological publications. In 1904 he published a study of the Indian population and physical geography of North America entitled "Basis of American History."

THE Roll of War Service of the University of London Officers Training Corps has been published by the Military Education Committee of the University. The first section, devoted to the roll of the fallen, contains the names and other particulars of 665 officers who were members or former members of the contingent. Section ii. records 1726 honours and distinctions awarded to 1068 officers. The roll of war service forming the third section gives particulars of 4276 officers and former officers and cadets of the contingent who served as officers in the war. The appendices contain statistical and historical information. Of the 4218 former cadets who served as officers during the war 1579 were first enrolled in the contingent before the war, the remainder (2639) during the war, but only 202 obtained their commissions before the war. The colleges of the University contributing the largest number of cadets are University College, 558; King's College, 484; Imperial College, 471; Guy's Hospital, 235; and St. Bartholomew's Hospital, 230. The illustrations include portraits of the late Lt.-Col. A. G. E. Egerton, Coldstream Guards, first Adjutant 1909-13, and the five former cadets who were awarded the V.C. The volume is published by the Military Education Committee of the University of London at 46 Russell Square, London,

¹ "The Climate and Weather of the Philippines, 1903 to 1918." By the Rev. José Coronas, S.J., Chief of the Meteorological Division, Philippine Weather Bureau. Pp. 195+29 plates and 3 illustrated maps.

W.C.1, at 1 guinea, packing and postage 1s. extra; half leather binding 1½ guineas, postage extra; and full leather binding 2 guineas, postage extra.

PROF. EINSTEIN'S main object in recently visiting America was to meet the Jewish community of the United States in order to enlist its support for the proposed University of Jerusalem. The foundation-stones of this University were laid in 1918, and preparations are being made to erect an institution worthy of the noblest ideals of modern knowledge. It is proposed to commence with physical and chemical departments, a medical faculty, an arts faculty, departments of law and commerce, and a Jewish faculty. The object of the promoters is to make the institution serve the interests of the Palestinian population as well as those of general culture. The University will be up to date in equipment and representative of the highest scholarship in each department: the association with the institution of men like Einstein, Wassermann, Bergson, Alexander, Lord Rothschild, etc., makes this perfectly clear. The University will be in no sense exclusive. So far as possible, Hebrew will be the medium of instruction, this being the language spoken by the Jews of Palestine, but it need scarcely be said that religious and racial tests will be unknown. Mr. C. Crossland, Director of the Fishery Service, Sudan Government, writes to us to express the fear that the University will be Jewish in a clerical sense, but we believe this need not be entertained for a moment, because Jews all over the world, and especially in Palestine, are absolutely opposed to any form of clericalism in social, political, or cultural life. The University of Jerusalem will be the only real university for a considerable section of the Orient, and it is to be hoped that it will become a great centre of culture for the Near East, acting as a link between the East and West, and thus helping to encourage feelings of friendship and co-operation between the representatives of the great civilisations of the past and of the modern world. Of course, as regards methods of teaching and research the University will be modelled entirely on European and American standards. The outcome of Prof. Einstein's visit is that the medical faculty of the University is now assured, and we can expect in the near future to have this faculty established in a country where the combating of disease is of particular importance. Other faculties and departments will follow as the means are obtained for them.

THE RIGHT HON. VISCOUNT HALDANE delivered an address on November 9 last before the Old Students' Association of the Royal College of Science, South Kensington, dealing with the subject of the nationalisation of the universities. The address has recently been issued in pamphlet form by H.M. Stationery Office. The title, as Lord Haldane observes, "is somewhat of a paradox, so far as I am concerned," since he proceeds to declare his unrelenting opposition to any suggestion that the universities of the United Kingdom should come under the control of any State Department. He submits that the most vital element in a university is that of an atmosphere "which in itself is the most excellent of things, and would be as difficult as it is rare were it not for that divine spark in the human soul which means that those who are gifted need but little to bring them to devote their whole energies to concentration on the highest ideas." That atmosphere no State Department can produce. Nevertheless, the State as representing the nation must have a care for the abiding well-being of the people. The highest education, that offered by the universities, touches, after all, but a fraction of the people. Not one in ten

of the population get any education at all after they leave school at the age of fourteen, and not one in a thousand get the advantage of the higher education of the universities. The problem is how to bring higher education to bear upon the democracy. One crucial difficulty is the cost, only a fraction of which, about 28 per cent., is met by the fees which well-to-do parents vainly imagine represent the real cost of the education which their sons and daughters receive. Apart from the endowments of past benefactors, the balance must be found by the gifts of the benevolent, which represents in the United Kingdom less than half a million sterling annually against the five millions contributed in the United States. The rest of the expenditure must be met from public sources, either from the rates or from the Exchequer, but the universities must be left free as to the means and methods which they employ in order to realise their obligations to the community, which are not only to train duly prepared students for their various faculties, humanistic and scientific, but also to undertake extramural work such as the Workers' Educational Association demands.

THE University of Bristol has issued a striking and beautifully illustrated appeal with the view of raising, under the novel form of "a group scheme," a five-year million fund, the participants in which may spread their contributions over a period of five years. The appeal is headed "The First Line of National Defence," as, indeed, rightly considered, a university significantly is. Already more than one million pounds sterling has been contributed in money, land, and buildings, chiefly by the inhabitants of Bristol, and notably by the Wills family, and now the University owns 19 acres of land within the city area, upon which its various fine buildings have been erected or are in course of erection. The University obtained its charter in 1909, and its course of instruction for degrees includes the customary faculties of arts, science, medicine, and engineering, inclusive also of agriculture and theology, together with many forms of extramural activities dealing with adult education. It is specially devoted to research in the various faculties. More endowed chairs and an increased staff of lecturers are needed, together with money for the establishment of fellowships, for departmental libraries, for equipment, and for research. One thousand two hundred full-time students and more than 1000 part-time students are in attendance, and the demand will grow as facilities for secondary education are increased and developed. The area embraced within the operations of this "University of the West" extends from the Cotswolds throughout the four south-western counties to Land's End. It is confidently to be hoped that within this area there may be found, not only on the part of private benefactors, but also on that of the local authorities, an eager willingness to support the efforts which the Council of the University is making to bring within the reach of the inhabitants of the four counties the highest possible facilities of learning and research in all departments of knowledge. The Treasury grant is to be raised in 1922 from one million to a million and a half sterling, and the University of Bristol can participate in it in proportion to the amount publicly subscribed. All the universities of the kingdom are in like straits for means of development, and it is worth while in this connection to direct attention to the munificence displayed in the United States by private persons, who gave in one year, 1917-18, in support of the universities and colleges of that country, nearly 5,500,000l., whilst benefactions to such institutions in the United Kingdom amounted in the three years, 1916-19, to only 1,192,000l.

Calendar of Scientific Pioneers.

August 5, 1872. Charles Eugène Delaunay died.—Known principally for his work on the theory of the moon, Delaunay in 1867 succeeded Poncelet in the chair of experimental physics in the Sorbonne, and in 1870 was made director of the Paris Observatory. He met his death by drowning off Cherbourg.

August 6, 1879. Johann von Lamont died.—Though a native of Scotland, Lamont spent his life in Germany. Like Gauss, Hansteen, and Sabine, he was a pioneer worker in terrestrial magnetism, and in 1851 discovered a decennial period in the daily range of magnetical declination and earth currents. He directed the Bogenhausen Observatory, near Munich, and catalogued 34,674 stars.

August 7, 1848. Jöns Jakob Berzelius died.—The contemporary of Dalton, Davy, and Gay-Lussac, Berzelius occupied a pre-eminent position among chemists. He discovered cerium, selenium, and thorium, isolated silicon, zirconium, and tantalum, was a founder of electro-chemistry, and by his work on atomic weights furnished chemists with a set of exact constants of great importance. He was secretary and president of the Swedish Academy of Sciences.

August 7, 1898. James Hall died.—One of the most distinguished of American geologists, Hall for sixty-two years was connected with the Geological Survey of New York, and made valuable researches of the palæozoic invertebrata of that State.

August 7, 1912. François Alphonse Forel died.—Professor of anatomy and physiology at Lausanne, Forel was best known for his researches in limnology, and especially for his study of the seiches of Lake Geneva.

August 8, 1897. Victor Meyer died.—From Göttingen Meyer in 1889 went to Heidelberg as successor to Bunsen. He discovered thiophen, introduced a new method of determining vapour densities at high temperatures, and made investigations in stereochemistry.

August 8, 1919. Ernst Heinrich Haeckel died.—Professor of zoology at Jena for more than forty years, Haeckel was the first German biologist to make evolution the leading conception of biology. A prolific writer, his "Natural History of Creation" appeared in 1868, and his "Riddle of the Universe," containing his well-known monistic views, in 1899.

August 9, 1899. Sir Edward Frankland died.—The first professor of chemistry in Owens College, Manchester, Frankland afterwards succeeded Hofmann at the Royal School of Mines. His investigation of the laws of the formation of chemical compounds led to the theory of valency, and in applied chemistry he did very important work in connection with water-supply and the pollution of rivers. He received the Copley medal in 1894, and in 1897 was knighted.

August 10, 1802. Franz Maria Ulric Theodore Aepinus died.—Aepinus was born in 1724, and became mathematical tutor to the Russian Royal Family. Among physicists he is known as the author of "Tentamen Theoriæ Electricitatis et Magnetismi," 1759, the first systematic attempt to apply mathematics to these subjects.

August 10, 1915. Henry Gwyn Jeffreys Moseley died.—A graduate of Trinity College, Oxford, Moseley by a systematic determination of the X-ray spectra of many of the elements was led to the discovery that the properties of an element are defined by its atomic number, giving rise to "Moseley's numbers," which are recognised to be of fundamental importance. He was killed in action at Suvla, on the Gallipoli Peninsula, at the age of twenty-seven. E. C. S.

Societies and Academies.

PARIS.

Academy of Sciences, July 11.—M. Georges Lemoine in the chair.—C. Moureu: The second conference of the International Union of Pure and Applied Chemistry.—S. Carrus: Research on triply orthogonal systems.—M. Alayrac: The movement of a solid in a resistant medium. Some of the results in a recent communication by the author had been anticipated by M. Dulac.—MM. C. Nordmann and Le Morvan: The determination of the effective temperatures of some stars and their colour index. The value of the "colour index" of stars can be determined by the authors' method of colour photometry. This method results from two homogeneous measurements, and avoids all the causes of error and uncertainty due to the comparison of a magnitude determined separately by sight and by photography.—A. Lafay: The direct measurement of the mobilities of electrified particles in gases.—D. Coster: The fine structure of the series of X-rays.—A. Marcelin: The superficial extension of soluble or volatile bodies. Studies on the displacement of particles floating on water by the changes in surface tension caused by the introduction of a piece of camphor, menthol, and isobutylcamphol.—M. Fric: Contribution to the study of the stability of nitrocellulose powders. The changes in composition caused by ultra-violet light in solutions of the powders in acetone were followed by the resulting changes in the viscosity of the solutions.—P. Lebeau and M. Picon: The action of sodammonium on diphenylmethane, fluorene, and indene. Dimethylfluorene. Sodammonium reacts with indene and fluorene, giving substituted sodium derivatives, and at the same time hydrogen is added to a certain proportion of the hydrocarbon. Indene gave 50 per cent. of the dihydride.—MM. Pariselle and Simon: Syntheses of tertiary alcohols, starting with methyl-ethylketone.—L. Longchambon: Rotatory power in crystallised media.—P. Fallot and H. Termier: The vertical extension of the marl facies containing prytic Cephalopods in the Island of Ibiza.—J. Mascart: The method of working out averages in meteorology. A discussion of some of the difficulties underlying the problem of taking true meteorological averages.—P. Schereschewsky: The foundations of the rational classification of clouds.—J. Politis: The rôle of the chondriome in the formation of essential oils in plants.—M. Mollard: The function of potassium in the chemical actions and the reproductive functions of the fungi.—MM. Cluzet and Bonnamour: The electrocardiographic study of the arrest of the heart in electrocution.—H. Marcellet: The hydrogenation of some marine animal oils. The oils from eight species of fish were treated with hydrogen in presence of nickel carbonate as catalyst at a temperature of 250° C. The changes in the iodine figure and melting point are given in each case; all the oils lost their disagreeable smell under the treatment.—Mme. A. Drzewina and G. Bohn: The phenomena of autoprotection and autodestruction in aquatic animals.—A. Trillat and R. Kaneko: Activity of infection by the air. Studies on the infection of mice by the Danysz paratyphoid organism and by pneumococcus. Of the various methods compared, the infection by bacterial fogs proved to be the most delicate, positive results being obtained by much smaller weights of bacterial emulsion when carried by air than when introduced by subcutaneous injection, with food, etc.—H. Frossard: The action of the orbiculo-costo-diaphragmatic reflex on the sympathetic and parasympathetic systems.

July 18.—M. Georges Lemoine in the chair.—The president announced the death of M. Gabriel Lippmann.—A. Haller and Mme. Ramart-Lucas: The two dextrorotatory methylallylcamphocarbonates, the three propanol-2-camphocarbonolides, and the 2-camphopropanol derived from them.—P. A. Dangeard: The structure of the plant-cell in its relations with the theory of the chondriome. A summary of the author's work on this subject since 1918, and an account of his system of nomenclature.—M. Janet: The characteristics of certain partial differential systems comprising as many equations as unknown functions.—A. Denjoy: A mode of progressive integration and the corresponding characters of integrability.—J. Andrade: Possibilities of new types of chronometer.—L. de Karasinski: The resistance of materials.—E. Rengade and E. Desvignes: An arrangement for testing the hardness of refractory materials at a high temperature. The method employed is a modification of the Brinell test, in which the ball is replaced by a cone of Acheson graphite. The specimens were heated in an electric furnace and the temperature was determined by an optical pyrometer. The results of numerous observations carried out on clay and bauxite bricks at temperatures between 1150° C. and 1470° C. are given in a diagram. The bricks show a gradual softening, as has been already mentioned by MM. Le Chatelier and Bogitch. Silica bricks behave differently; up to about 1600° C. they give no imprint, then the brick breaks up suddenly.—A. Dauvillier and L. de Broglie: The distribution of the electrons in the heavy atoms.—A. Debiere: The diffraction of the X-rays by liquids.—H. Pélabon: The resistance of thallium sulphide and selenide. The resistance of the compounds Tl_2Se and Tl_2S in the solid state varies with their previous thermal treatment. The specific resistance varies with the temperature according to a law which remains the same, but the resistance is not determined when the temperature is known. In both cases there is an abrupt change in the resistance on melting.—P. Pascal: The magnetic properties of the alkaline earth metals in combination.—H. Weiss and P. Lafitte: The interpenetration of solids. An extension of experiments already described with zinc and copper to other pairs of metals.—E. Decarrière: The rôle of the gaseous impurities in the catalytic oxidation of ammonia gas. The results with traces of sulphuretted hydrogen have been given in a previous communication. Figures for acetylene are now given, and it is shown that the effect of this gas as impurity is more serious than that of sulphuretted hydrogen, since the lowering of the yield increases with the total amount of acetylene which has passed the catalyst, and is not simply dependent on the proportion actually present at any given time. If both sulphuretted hydrogen and acetylene are present as impurities in the ammonia, as is the case with ammonia prepared from commercial cyanamide, the former has a protective action and the injurious effect of the acetylene is in great part neutralised.—L. Hackspill and E. Botolfsen: The preparation of calcium carbide by calcium ammonium and acetylene. Pure calcium carbide is not obtained by Moissan's method, the decomposition at 150° C. of the compound $C_2Ca \cdot C_2H_2 \cdot 4NH_3$. The calcium carbide formed is very impure, and contains cyanamide, calcium cyanide, and free carbon.—C. D. Zenghelis: A new reaction of ammonia. A concentrated solution of silver nitrate in formaldehyde (formol) freshly made gives a mirror of metallic silver with traces of ammonia. The reaction was obtained with 0.00034 milligram of ammonia, and ammonia has been detected in potable water in a case where no indication was given by the Nessler reagent.—M. Picon: A new

method of preparing the sodium derivatives of the true acetylene hydrocarbons. The acetylene is treated with sodium amide in liquid ammonia; the products are pure and the yields are high.—A. and J. Pictet: The polymerisation of the glucosanes.—A. Mailhe: The nitro- and amido-derivatives of methylethylbenzene.—L. Doncieux: An ancient passage of the pre-Wurmian Rhone through the plateau of Clarafond, Haute-Savoie.—J. Savornin: Extension of the continental Aquitanian to Morocco.—H. Ricôme: The causes of the inverse orientation of the root and stem.—M. St. Jonesco: The existence of anthocyanidines in the free state in the fruits of *Ruscus aculeatus* and *Solanum dulcamara*.—P. Benoit: The female gonophores of *Tubularia mesembryanthemum*.—P. Wintrebert: The existence of a transitory nervous dualism at the commencement of the neuro-muscular connection in Selacians.—G. Bertrand and R. Vladesco: The probable intervention of zinc in the phenomena of fertilisation in the animal vertebrates. In man the prostate gland is richer in zinc than the testicles, and its proportion of zinc exceeds that found in any of the other organs of the body. Similar ratios were found for the ox, but in the pig the seminal vesicles possess the maximum zinc content. It would appear that zinc plays an important part in the phenomena of reproduction in vertebrates.—E. Auel: The action of the pyocyanic bacillus on asparagin. Among the reaction products malic, formic, fumaric, and propionic acids were identified.—P. Courmont, A. Rochain, and F. Laupin: The disappearance of pathogenic germs in the course of the purification of sewage by activated sludge. After six hours' treatment pathogenic organisms of the typhoid-paratyphoid group are nearly always present in the effluent; the cholera vibriion disappears.—F. Diéniert: Concerning activated sludge. A study of the influence exercised by carbo-lic acid on the fermentations caused by activated sludge.—MM. Desgrez, Guillemard, and Hemmerdinger: The fixation of carbon monoxide diluted and carried by an air-current. An attempt to find a reagent suitable for the absorption of small proportions of carbon monoxide in a gas-mask. The best results were obtained by using pumice (27) saturated with a mixture of iodic anhydride (9) and sulphuric acid (2.5).

OTTAWA.

Royal Society of Canada, May 18-20.—Presidential address, Prof. J. C. Fields: Division in relation to the algebraic numbers.—Prof. A. S. Eve: Ionisation potential and the size of the atom.—Prof. A. S. Eve and E. S. Biehler: Detection of variation in electric earth-currents by coil and galvanometer.—Miss V. Douglas and Dr. J. A. Gray: The effective range of β -rays.—Dr. J. A. Gray: The velocity of sound in air and soil. Properties of X-rays excited by β -rays. The absorption of γ -rays. A note on the examination of materials by X-rays.—Dr. A. N. Shaw and L. S. Smith: The transmission of heat through the thin boundary films of air or of water at the surface of glass.—Dr. E. H. Archibald, C. E. Stone, and E. M. White: The viscosity of ether at low temperatures, and solution of acetic acid in liquid hydrogen bromide.—Dr. W. F. Seyer: Preliminary report on the lubricating properties of the different series of hydrocarbons.—Dr. D. F. Steadman: An automatic mercury pump.—W. A. Hardy: Some results of the destructive distillation of British Columbia alder and Douglas fir.—Dr. J. H. L. Johnstone: The variation of the "emanating power" of certain uranium minerals with temperature, and a new secondary radium emanation standard.—C. A. Mackay: The effect of thermoluminescence on electrical conductivity.—J. Patterson: The anemometer factor. Pilot-balloon methods in

Canada.—Dr. L. V. King: Some new formulæ for the direct numerical calculation of the coefficient of mutual induction of coaxial circles. A new high-frequency vibration galvanometer. The photographic recording and measurement of radio-telegraph signals. A new lecture-room illustration of atomic models.—Prof. J. C. McLennan: The refractive indices of metallic vapours.—W. W. Shaver: The absorption spectra of liquid and gaseous oxygen.—Prof. J. C. McLennan and P. Lowe: The structure of the Balmer series lines of hydrogen.—Prof. J. C. McLennan and P. A. Petrie: The spectra of helium, hydrogen, and carbon in the extreme ultra-violet.—Prof. J. C. McLennan: The liquefaction of hydrogen.—W. A. Lawrence: Nitrophthalic anhydrides and acetylaminophthalic anhydrides with toluene and aluminium chlorides.—H. N. Stephens: Bromophthalic anhydrides with benzene and aluminium chloride.—N. A. Clark: The effect of certain chemicals on the rate of reproduction of yeast.—Prof. J. B. Ferguson and G. A. Williams: The passage of hydrogen and of helium through silica tubes.—W. B. Leaf: The action of methyl-green on yeast.—K. L. Wismer: Pressure-volume relations of superheated liquids.—W. H. Martin: Scattering of light by dust-free liquids.—Prof. F. B. Kenrick: Note on Wolski's paper on optically empty liquids.—Prof. J. B. Ferguson: Re-determination of the melting point of sodium chloride.—Prof. W. L. Miller: Researches in physical and organic chemistry carried out in the chemical laboratory of the University of Toronto.—Dr. J. C. Glashan: The reduction of the circulants to polynomial form with applications to the circulants of the 7th and 11th degrees.—Prof. A. H. S. Gillson: The gravitation potential of an anchor ring. Some tidal problems.—Prof. E. F. Burton and Miss E. S. Bishop: Law of distribution of particles in colloidal solutions.—S. McLean: Production of heat during charcoal absorption.—Prof. E. F. Burton and E. D. McInnes: The relation between coagulative power of electrolytes and concentration of colloidal solutions.—Dr. J. S. Plaskett: The radial velocities of 570 stars. The orbit and dimensions of TV Cassiopeia. The temperature control of the stellar spectrograph.—W. E. Harper: The orbital elements of the brighter components of Boss 407. The orbits of spectroscopic components of Boss 4622.—H. H. Plaskett: The intensity distribution in typical stellar spectra.—Dr. S. D. Killam: The solution of plane triangles by nomographic charts.—Dr. C. T. Sullivan: Note on the geometrical equivalence of certain invariants.—Dr. W. B. Dawson: The interpolation of breaks in tide curves for recording gauges.—Dr. F. T. Shutt and Miss A. H. Burwash: The vertical movement of alkali under irrigation in heavy clay soils. Notes on the nature of burn-outs.—Prof. H. F. Dawes: Reversible pendulum.—Prof. A. L. Hughes: Characteristic X-rays from boron.—Prof. J. Satterly: A new experiment in vibration.—Prof. J. C. McLennan: Note on the spectrum of potassium. Note on infra-red spectroscopy.—H. J. C. Ireton: Selected radiation emitted by specially excited mercury atoms.

Books Received.

University of Illinois: Engineering Experiment Station. Bulletin No. 120. Investigation of Warm-air Furnaces and Heating Systems. By Prof. A. C. Willard and others. Pp. 145. (Urbana: University of Illinois; London: Chapman and Hall, Ltd.)
Ministry of Agriculture, Egypt: Cotton Research Board. First Annual Report, 1920. Pp. 124. (Cairo.) P.T.10.

A History of British Mammals. By G. E. H. Barrett-Hamilton and M. A. C. Hinton. Part xx. Pp. 649-96+2 plates. (London: Gurney and Jackson.) 3s. 6d. net.

Tychonis Brahe Opera Omnia. Tomi Quinti. Fasciculus Prior. Astronomiæ Instauratæ Mechanica (1598). Pp. 213. (København: Gyldendalske Boghandel.)

Ministry of Public Works, Egypt. Report on a Method of Measuring Small Differences in Longitude. By E. B. H. Wade and P. A. Curry. (Physical Department Paper No. 5.) Pp. 10. (Cairo: Government Press.) P.T.5.

Union of South Africa: Department of Agriculture. Report with Appendices for the Year ended March 31, 1919. (Exclusive of the Section relating to Agricultural Education.) Pp. iv+170. 7s. 6d. Report with Appendices for the Fifteen Months from April 1, 1919, to June 30, 1920. Pp. 77. 4s. (Cape Town.)

Board of Education, South Kensington. Classification for Works on Pure and Applied Science in the Science Library, the Science Museum. Second edition. Pp. 243. (London: H.M. Stationery Office.) 18s. net.

Department of Statistics, India: Agricultural Statistics of India, 1918-19. Vol. ii.: Area, Classification of Area, Area under Crops, Livestock, Land Revenue Assessment, and Transfers of Land in Certain Indian States. (Thirty-fifth issue.) Pp. v+131. (Calcutta: Government Printing Office.) 1 rupee.

The Journal of the Royal Agricultural Society of England. Vol. lxxxi.: Practice with Science. Pp. 278+clxiv. (London: J. Murray.) 15s.

CONTENTS.

	PAGE
Modern Credulity	705
Education and World Citizenship. By J. C. M. G.	707
Practical Chemistry	708
The Nature of Man. By W. J. Perry	710
Principles and Practice of Psychotherapy. By Alfred Carver	711
Torres Strait and its Echinoderms. By F. A. B.	712
Our Bookshelf	712
Letters to the Editor:—	
The "Flight" of Flying-fish.—H. H. Clayton	714
The Colours of Breathed-on Plates.—Prof. C. V. Raman	714
Mutations and Evolution.—Prof. R. Ruggles Gates; The Writer of the Article	714
Molluscan Fauna of Scottish Lakes, and a <i>Pisidium</i> New to the British Isles.—B. B. Woodward	715
Cup and Ring Markings.—C. Carus-Wilson	715
Science and Civilisation.—Dr. C. V. Drysdale	715
Remarks on Simple Relativity and the Relative Velocity of Light. I. By Sir Oliver Lodge, F.R.S.	716
Endowment of Scientific Research in the United States	719
Obituary	720
Notes	722
Our Astronomical Column:—	
Displacement of Lines in the Spectrum of Venus	725
Planetary Photography	725
Measurement of the Diameter of Arcturus	725
The Universities and Technological Education. By Prof. W. W. Watts, F.R.S.	726
The Exploitation of Irish Peat. (Illustrated.) By Prof. Hugh Ryan	728
Geophysical Problems	730
Agricultural Research	731
Meteorology of the Philippines. By C. H.	732
University and Educational Intelligence	732
Calendar of Scientific Pioneers	734
Societies and Academies	734
Books Received	736



THURSDAY, AUGUST 11, 1921.

Editorial and Publishing Offices:

MACMILLAN & CO., LTD.,

ST. MARTIN'S STREET, LONDON, W.C.2.

Advertisements and business letters should be
addressed to the Publishers.

Editorial communications to the Editor.

Telegraphic Address: PHUSIS, LONDON.

Telephone Number: GERRARD 8830.

University Finance.

THE problem of university finance is not a simple one, and the solution is not yet. Apart from endowments, which in this country are relatively small, the three main sources of income are students' fees, Parliamentary grants, and grants from local authorities, and these three bear no fixed relation to one another. Students' fees vary according to time and place; the Parliamentary grant, administered by the University Grants Committee, seems to be allocated according to no definite principle; and the local authorities may or may not contribute to the maintenance of the universities, and where they do contribute their subventions from the rates are by no means uniform in amount. Even in normal years the fluctuating character of the income makes the task of financing a university not a light one, while in abnormal times the task becomes one of difficulty and embarrassment. Under such conditions the marvel is that so many able business men have been found ready and willing in an honorary capacity to give their time and energy to help in directing the financial affairs of our universities. That they do so speaks much for the hold which higher learning has upon a valued and important section of the community, but such interest ought not to be looked upon as a justification of the system, or rather lack of system, of finance which exists at present.

One of the main principles which should govern university finance is that the income should be stable. There should be sufficient for necessary needs, and something over for development and expansion. Now it is no exaggeration to say that in most, if not all, of the universities at present this fundamental principle is more honoured in the breach than in the observance. Very few can budget with reasonable certainty for several years ahead, yet they most certainly ought to be able to do so if they are to fulfil the function for which they were founded. For one thing there should be reasonable assurance of reasonable salaries. But since in general the salary bill of the teachers is rather more than half the total expenditure, it is obvious that a fluctuating income makes it extremely difficult to give that assurance. The teachers may lament their hard lot, and it has been extremely hard with many, but if there is no certainty as to income from year to year there is little hope for a reasonable and proper amelioration. In view of such facts, it was well that university finance should be discussed at the Congress of the Universities of the Empire held recently at Oxford.

The subject was opened by Sir J. A. Ewing and Dr. Adami in two interesting and able papers. The former gave a comparative statistical survey of the larger universities, arriving at the conclusion that the average cost "per head," in the fourteen university institutions selected by him, amounted to approximately 65*l.*, and that of this sum 34*l.* was spent on salaries and superannuation, and about 6*l.* on administration. These figures, though they must be taken with some reserve, are interesting, but do not "cut much ice." Perhaps it is more helpful to learn that 25*l.* of the 65*l.* is paid by the student, and 20*l.* comes from Parliamentary grants, for then we gather that the student pays rather more than one-third of the cost of his education, while the Government pays rather less than one-third. But what further inferences we are to draw from these statements the learned principal of Edinburgh University omits to say. Incidentally, however, there emerge two facts which some of our more observing readers might have anticipated. The first is that among universities the economic advantage of large-scale working holds just as in ordinary business concerns; and the second, that the group of three Scottish universities is run at a lower cost per head than any of the other groups. In view of this it would have been interesting, and no

doubt instructive, had the statistics contained a comparative table of salaries paid in the various universities or groups of universities quoted by Sir J. A. Ewing.

Turning to the paper read by the vice-chancellor of Liverpool University, one is struck by the clear exposition of the subject, the principles enunciated, and the policy suggested. The aggregate income of twenty-one institutions of university rank in Great Britain has been carefully analysed. From the figures given we find that students' fees amount to 39.7 per cent. of the total income; Parliamentary grants, 36.5 per cent.; and local authority grants, plus income from endowments, 23.7 per cent. As the aggregate income is more than 200,000*l.* short of the estimated expenditure, Dr. Adami suggests that the prospective deficit should be met by additional grants from local sources. He thinks that the contribution from the city in which the university is situated should be at least one penny in the pound, and that the other authorities, town and county, of the district served by the university should contribute at least one halfpenny in the pound. The only criticism we have to offer upon this is that Dr. Adami is too modest in his demands. There seems to be no sound reason why the whole of the local authorities in the Kingdom, urban and rural, should not contribute a uniform rate of one penny in the pound. The universities are not local, but national. Undoubtedly a penny rate for the whole country would ensure a greater measure of stability, and would go far to solve the problem of university finance.

Regarding the question of salaries, Dr. Adami quotes extensively and effectively from the memorandum prepared by the Interim Committee of the Conference of University Authorities and the Association of University Teachers. The scale of salaries suggested by the committee, and afterwards adopted by the conference, is given, as is also the estimated additional income required to put the scale into immediate operation in England and Wales. A rough estimate places the sum at about 350,000*l.*

On the subject of the superannuation of university teachers Dr. Adami is on firm ground when he says that the matter cannot rest where it is at present. The recent grant of 500,000*l.* from the Treasury (acceptable as it is) for the purpose of augmenting the superannuation allowances of certain of the senior members of the staffs of the universities is not only totally inadequate for its ostensible purpose, but also sub-

jects those university teachers who have seen teaching in schools or technical institutions outside the university to differential treatment of quite an unjustifiable character. At present a schoolmaster of standing cannot accept a position in the university without a loss of pension benefits. This rift between the universities and the schools and technical and training colleges outside the universities cannot be allowed to continue. Anyone who has the best interests of the universities at heart will agree with Dr. Adami that "some method must be discovered whereby years spent in one service are duly recognised in the other for pension purposes." We have on more than one occasion expressed the same opinion in these columns.

One other point. No discussion of university finance where Parliamentary grants are involved would be complete without reference to the relation of the State to the university. There are some who see in the growing financial intimacy between the State and the university a threat to the autonomy of the latter. Whether this opinion is shared by our readers or not, we believe that the freedom of the university is so vital for its efficiency and its highest development that it is the duty of every university teacher to guard jealously this most valuable possession, and we believe they will not fail in this duty. It was natural and fitting, therefore, that the subject should come up for discussion at the Oxford congress, and, considering the issues involved, it is perhaps not a matter for surprise that it gave rise to one of the outstanding incidents of the congress—a brilliant speech by Sir Michael Sadler on the freedom of the university.

The Bible.

The Bible: Its Nature and Inspiration. By Edward Grubb. (Published for the Woodbrooke Extension Committee.) Pp. 247. (London: The Swarthmore Press, Ltd., 1920.) 2s. 6d. net.

IN this handy little paper-covered volume Mr. Grubb gives us a most readable and interesting historical account of the Bible and of our knowledge of its growth and development. As the advertisement on the cover justly says:—

"This . . . book explains what the Bible really is, and why Christians value it above all other books. Many suppose that if the Bible is not literally true, from beginning to end, it is of no use at all. That is quite unreasonable. The presence of human imperfection in the work of

the men who wrote the Bible is no proof whatever that they had not a real and living message from God to the people for whom they wrote—and for us, if we will take the trouble to understand it.”

Mr. Grubb is a believing Christian, and writes for Christians with a breadth of view that is a tribute to the writer's common-sense and humanity (in the higher sense of the word). One wishes one could say as much for many so-called “Rationalistic” writers, some of whom have been more bigoted and more intolerant, more narrow and uninformed, than the worst Roman “cagot” or Calvinistic heresy-hunter that ever lived. However, these professional anti-Christian fanatics are nowadays almost a thing of the past. A few who still survive here and there are mere relics of the mid-Victorian age who do not count. We are talking of Britain, of course; in France the species still lives and flourishes.

Nothing has contributed more to the rout of the old-fashioned Freethinkers than the discoveries that have been made since the 'seventies in the realm of ancient Oriental history and anthropology, which have shown that the Old Testament was not, as those of our grandfathers who considered themselves enlightened supposed, a collection of baseless fables, but real history, sometimes in the guise of legend, but more often in that of genuine copies of ancient annals. The cuneiform discoveries of Rawlinson and George Smith, the recovery of the ancient history of Egypt to the confusion of the supposedly intelligent but really extremely credulous Sir George Cornwall Lewis, the finding of the Moabite Stone, and the critical study of the text of the historical books of the Old Testament, have all shown that in the Bible we are dealing with real history and with tradition based upon facts. They show also that, in the obvious myths, such as those of the Creation and the Deluge, we have before us extraordinarily interesting accounts akin to the cosmogonical myths of the Babylonians, pointing to the origin of Hebrew civilisation. But in the relief which these discoveries gave to those Christians who demanded “belief in” the Bible (a phrase that meant everything to them, though to the more instructed it might mean anything or nothing) as a condition of their faith in Christianity, and in the triumph which the godly felt had been vouchsafed to them over the vain imaginings of the ungodly, the new discoveries were hailed as “proving the Bible”—as showing irrefragably that the Biblical books were all “inspired” truth, and that Moses wrote the Pentateuch after all. One sees that this would be of great interest and import-

ance to a professing Jew, but one is puzzled to know how, even if Moses did not “write the Pentateuch,” the fact could affect the faith of a Christian. A new law was given to the world by Our Lord, based, indeed, on the traditional beliefs and teachings of His people, the Jews, but owing nothing of its authority to them. Some Christians, however, of the Reformed Churches have always been more Jew than Christian!

There is, indeed, little fact behind the idea which one often meets that archaeological discovery has “proved” the literal truth of the whole of the Old Testament, and incidentally “shown that Darwin was all wrong” (a very prevalent idea). Similarly, as little fact supports the idea of the old-fashioned Rationalists that the Bible was from beginning to end an invention of designing priests. Archaeological discovery has certainly “proved the truth” of the Old Testament, but not in the literal sense which alone is comprehended by the simple-minded. Both the Tale of Troy and the Arthurian Legend are doubtless “true” in that they are indubitably based on fact, and that is what archaeological discovery shows us with regard, for example, to the books of Joshua and Judges. “Kings” and “Chronicles” are annals; they are (as we can see by comparison with contemporary historical documents, Egyptian and Assyrian, as well as from internal evidence) more trustworthy than the others, as the Anglo-Saxon Chronicle may be more trustworthy than Giraldus Cambrensis or Geoffrey of Monmouth; they are on the same level as such chroniclers, no less, but also no more. The Bible must be looked at as objectively as any other scripture; and if we study it so, and also with reverence as the foundation of Christ's teaching, and as a Holy Book inspired by the Spirit of God, because it is the work of man, we shall understand many things that hitherto have been hid from us, and see clearly where formerly we were blind.

This is the position that Mr. Grubb holds in common with all enlightened Christians of to-day, whether English Catholic, Presbyterian, or Free. Rome still seems to affirm “verbal” inspiration officially. The English reformed branch of the Western Catholic Church, with its freedom won by the Reformation from the dead hand of ancient official pronouncements made in the days of ignorance, has during the last fifty years obtained for itself a reputation for freedom of discussion and scientific criticism of Biblical matters on the part of its learned divines even more honourable than that of its fellow Protestant Churches. Many of the greatest lights of the “Higher Criticism” have been English Churchmen, and obscurantist circles have often been scandalised by the fact.

Unhappily, one or two of the "Higher Critics" have gone much too far with their textual criticism, and honestly, but mistakenly, have invented a new Old Testament of their own imagining, and a very dull and uninspired thing at that. The text of the real Book is often obscure, and not seldom corrupt, so that it must be emended, but not so much so as to be a sort of Bacon-Shakespeare cryptogram which can be elucidated only by methods strongly reminiscent of Mrs. Gallup! The "Higher Criticism" does not connote this sort of fantasy; what it really is Mr. Grubb shows with both knowledge and skill. From his little book the interested reader can see just how far archaeological discovery has confirmed the general historical character of the legendary and annalistic books of the Old Testament, and he will be able to realise what "textual criticism" means in the case of Hebrew manuscripts; the distinctions between the different schools of early Jewish religious writers that "wrote the Bible"—the Jahvist ("J"), the Elohist ("E"), and the Priestly ("P") writers—will be made clear to him. He will also be able to understand the fact of the various "strata" of Isaiah, which can be printed, if necessary, in different colours to distinguish them.

The Bible, treated scientifically and subjected to the same criticism as any other collection of ancient legends and poems, becomes extraordinarily interesting. If the sacred books of a religion cannot stand criticism, they are not worth much. The "Book of Mormon" cannot stand criticism; the Holy Bible can and does. Literal truth at all times and in all places is not the question. Christianity does not stand or fall by the "verbal inspiration" or literal "truth" of the Old Testament, but rests foursquare and secure on the teaching of its Founder as given to us in the New. He regarded the scriptures of His ancestors with the same reverence that we do, who seek out and study their origins and growth in order that we may the better understand the bases of our faith and so teach it *ad majorem Dei gloriam*. H. H.

Zoology for Medical Students.

An Introduction to Zoology. By Prof. C. H. O'Donoghue. Pp. x+501. (London: G. Bell and Sons, Ltd., 1920.) 16s. net.

THE object of this volume is to provide a text-book for the zoological portion of the syllabus in biology for the first examination for medical degrees of the University of London, and for the first examination of the Conjoint Examining Board in England.

For an introduction to zoology for medical

students, the subjects discussed, the degree of fullness of treatment, and the order of their presentation are admirably suited. After a preliminary chapter, the frog is first treated as an introduction to anatomy, physiology, and histology; then follow accounts of two free-living and two parasitic Protozoa—Amoeba and Paramoecium, Monocystis and the malaria parasite. A chapter is given to Hydra and Obelia, and another to the earthworm and Tænia, while the dogfish is treated at length. An account of the rabbit takes up nearly 100 pages, and this section includes—an excellent addition—descriptions of the skull of the dog, and of the brain and heart of the sheep. A chapter on histology and cytology follows, which deals mainly with cytology, including spermatogenesis and oogenesis; the section on embryology introduces the early development of Amphioxus and of the frog (which finds its place here instead of in the earlier chapters); while the chick and rabbit are treated more completely. A final chapter is devoted to evolution, variation, and heredity.

The present writer is convinced that such a course, beginning with a fairly full account of an animal that goes on four legs, the internal arrangements of which correspond in some degree with what the beginner already knows of his own body, and then working upwards from the Protozoa, is, as the author has found, the most satisfactory from the point of view of both teacher and student. The number of forms to be studied must be sufficiently large to serve as a basis for the wider appreciations and generalisations on the comprehension of which the value of the course to the medical student depends. Medicine is applied biology, and if the student does not grasp the fundamentals at this stage he will not do so from the specialised study of human anatomy and physiology at a later period. At the same time, as the author implies, the multiplication of types beyond what is strictly necessary to illustrate fundamental principles is to be deprecated as involving a study of unnecessary details. In the present state of the medical curriculum there is no excuse for presenting the ordinary student with a survey of the whole animal kingdom—a practice that perhaps still survives in places. A complete study of a few well-chosen forms, with similarly thorough laboratory work on those forms, is worth more for the purpose of giving an insight into biological principles—and infinitely more as a training in scientific method and thoroughness—than skimming over all or most of the phyla of Invertebrates and the classes, or even orders, of the Vertebrates.

A few criticisms of details are necessary. The account of the physiology of digestion is, quite

suitably, an account of mammalian digestion, but this should be stated; instead, it is said to be an account of the physiology of digestion in general. The respiratory movements in the frog are badly explained; if they took place as described, no air would ever be expelled to the exterior, and the animal would ultimately burst. Also the description of the frog's truncus arteriosus is not easy to follow, and there is no explanation of how its mechanism works, and no statement that the arterial arches contain blood of different degrees of oxygenation. The author appears to distinguish ague from malaria ("three distinct diseases, malaria and two kinds of ague"); while only the maximum recorded length (36 metres) is given for *Taenia saginata*, which is surely liable to mislead the student as to its usual dimensions.

The last chapter, which is so important, is too compressed; the subjects of the forty-two pages include evolution; variation, heredity, and selection in connection with the Darwinian theory; Mendelism; and palæontology as illustrated especially by the reptiles; while the topics of the evolution of sex and its meaning do not appear to find a place. Some of the figures introduced from Bourne's "Comparative Anatomy of Animals" have suffered considerably—*e.g.* those of the nephridium of the earthworm and of the skeleton of Scyllium; they are unworthy of a place in the book.

Errors which have been noted are as follows: A trochanter is a prominence, not a depression (p. 30); to say that membrane bones are "formed by bone tissue being laid down in a membrane" is neither adequate nor correct. Among misprints one might note "Calkin," "Bütchli," "Weissmann," "strobilla," "alteration" (of generations), "aborizations" (p. 95), "cæcum" and "stomodæum" for "cæcum" and "stomodæum," and "anistropic" (p. 42). "Pre-caval" contains an unnecessary hyphen, while in "sub-cutaneous" and "sub-clavian" it is more than unnecessary.

The author, in his preface, acknowledges his indebtedness to Profs. Dendy and Hill, especially to the latter, on whose lecture-notes parts of the book are more or less directly based.

The Analysis of Steel.

The Chemical Analysis of Steel-Works' Materials. By F. Ibbotson. Pp. viii + 296. (London: Longmans, Green, and Co., 1920.) 21s. net.

THE "Analysis of Steel-Works' Materials" of Brearley and Ibbotson has long enjoyed a reputation as a sound and trustworthy manual

of the subject with which it deals, and its contents are familiar to most steel analysts. The revision of the work has been undertaken by one of the authors only, and advantage has been taken of the occasion to extend the treatment of steels, alloys, slags, etc., on the analytical side, and to gain space for such extensions by omitting the sections of the earlier work dealing with pyrometry and the use of the microscope. In the interval which has elapsed since the original publication many books on these two subjects have made their appearance, and their development has been so rapid that it has become undesirable to attempt their treatment in the course of a few short chapters in a work devoted mainly to a different branch of the subject. Mr. Ibbotson's experience of the analysis of steel-works' materials is exceptionally wide, and the methods which he describes have been in all cases personally tested and compared with alternative processes, so that the author may be accepted as a safe guide, especially in the difficult region of the analysis of high-speed tool steels and other complex alloys containing the rarer metals.

The separation of the rarer elements has been worked out with great care for the purposes of mineral analysis, and it is possible, by following somewhat laborious methods, to effect a complete separation of the metals contained in a mineral with a high degree of accuracy, as has been shown more particularly by American work on the composition of rocks. The analysis of complex steels, however, calls for processes which are rapid as well as accurate, since the results are usually required for commercial purposes within the shortest possible time. The high cost of the rarer alloy metals makes their exact estimation very important, whilst certain alloy steels are remarkably sensitive to minute variations in the proportions of the added elements, so that to devise methods which will yield, in the hands of the works chemist, results of the required accuracy in a reasonably short time is a task of some difficulty. The author lays great stress on accuracy, so that while his methods are not invariably the most rapid, they are such as can be trusted where a gain in speed might possibly be accompanied by a serious risk of error.

The work differs a little in its arrangement from most text-books on the subject. The opening chapter deals with certain reactions of a more or less general character, including the separation of iron from other metals, the reduction of solutions by nascent hydrogen by means of the Jones reductor, and the precipitation of chromium, molybdenum, tungsten, and vanadium by means

of mercurous nitrate. The succeeding chapters describe the estimation in turn of the elements which usually occur. The methods for the direct combustion of carbon are comparatively slow, and it would have been advantageous to add a description of the rapid methods, using small electrically heated tubes, which were devised during the war for the enormous number of shell steel samples which had to be analysed in the Admiralty and other laboratories. In such rapid methods soda lime is used with advantage in place of the more cumbersome potash bulbs. In the Volhard estimation of manganese the simple method of precipitation with zinc oxide and titration without removal of the iron, which is very convenient in the analysis of ferro-manganese, is not mentioned. The estimation of sulphur and phosphorus in steels, about which disputes are most frequent, is treated very thoroughly.

The analysis of ores, refractories, slags, fuels, and boiler waters is dealt with in later chapters. The section on slags suffers somewhat from its brevity, and many chemists would welcome a fuller account of this important subject. Thus in the analysis of basic slags no mention is made of the distinction between total and available phosphoric acid, on which the value of the slag so largely depends, and it would also have been well to include some account of the estimation of fluorine in such slags; the addition of fluorspar in the basic open-hearth process is frequently practised, and its effect is to convert a part of the phosphoric acid into an inert form.

Mr. Ibbotson's work may be confidently recommended to the analyst and student as a trustworthy guide to the subject by an author of ripe experience in the field in which he has worked so long.

Relativity and Gravitation.

Relativity: The Electron Theory and Gravitation.

By E. Cunningham. Second edition. (Monographs on Physics.) Pp. vii + 148. (London: Longmans, Green, and Co., 1921.) 10s. 6d. net.

THE second edition of Mr. Cunningham's book, like the first, aims at presenting the problems of relativity in a form suitable for the general physicist. More than half the book deals with the special theory, giving the fullest account of the experimental side in any English book. This part is practically unchanged from the first edition—too little changed, for one would have

liked to see the author's views on Majorana's experiments, which are not mentioned.

In discussing the general theory, he follows the historical order of development, commencing with Eötvös's experiment, which showed that the weights of two bodies of different constitution in the same gravitational field are proportional to their inertias within 5 parts in 10^8 . From this he advances by a series of generalisations. First, light has inertia; if Eötvös's result is true for it, it must also have weight. Therefore it cannot travel in straight lines in a gravitational field. Therefore the differential ds , which is intimately related to the behaviour of light in the special theory, must, if it is still to maintain this relation to light, have a form in a gravitational field that takes the field into account. It has also a relation to the motion of a particle in the special theory; we knew already that it would have to be modified in form to maintain this in a gravitational field.

It is therefore assumed that the same form will still answer both purposes. Previously, again, the law of gravitation satisfied a condition that was unaltered by any displacement of the origin or rotation of the axes. Suppose, then, that the coefficients in the new ds satisfy a condition that is unaltered by any change in the co-ordinates used; the class of changes admitted is to be as wide as will permit some such condition to be satisfied. This leads at once to the irrelevance of the mesh system, and appears to the reviewer to be the best reason yet advanced for attributing to this principle any appreciable prior probability.

The crucial tests of the theory are described, and a chapter is devoted to Weyl's theory of electric and magnetic forces. The book is well arranged and written. Enough does not seem to be made, however, of the crucial tests. For anything that any professed exponent of the theory has said, there might be a million other theories, all as probable as Einstein's, which would give the same predictions. It may be pointed out that on p. 114 the assumptions given are not enough to ensure that the coefficient of $drdt$ shall be zero, which is assumed a few lines later; that in the footnote on p. 107 it is implied that a purely imaginary quantity can have a true minimum; and on p. 120 that the mere fact that the resultant velocity of an object is known is not enough to determine its path. But in the main the book is a careful and sound analysis, and can be recommended to all students of the theory.

H. J.

Our Bookshelf.

The North American Species of Drosophila. By A. H. Sturtevant. (Publication No. 301.) Pp. iv+150+3 plates. (Washington: The Carnegie Institution of Washington, 1921.)

A SYSTEMATIC account of the North American species of *Drosophila* and related genera, which includes many new species from collections made in various parts of the continent, will be found in this volume. One of the chief features of interest in such a monograph lies in a comparison of the systematic differences distinguishing species with those distinguishing mutants. In the latter part of the work this subject is discussed. The species of *Drosophila*, although often closely alike in appearance, so that only intensive study has succeeded in separating them, are extraordinarily difficult to cross. This applies not only to those having different chromosome groups, which no one has yet succeeded in crossing, but also to those in which the chromosomes are alike.

Dr. Sturtevant points out that both species and mutants may differ from each other in such features as eye-colour, wing-shape, abdominal pattern, and size and shape of eyes; but in studying specific differences it is "often necessary to examine minute characters, such as wing-vein indices or the relative sizes of certain bristles, that are seldom examined in material bred for genetic purposes." Many of the mutant characters are, however, similar to those observed between species. The general impression is received that specific differences and mutations may both be found in practically any character studied. The species usually differ slightly in innumerable characters, while mutants often differ strikingly in a few. This does not indicate that specific and mutational characters are different in kind, but that only the smaller mutations, by upsetting less the economy of the species, usually survive as specific differences. R. R. G.

Introduction to General Chemistry. By Prof. H. Copaux. Translated by Dr. H. Leffmann. Pp. x+195. (Philadelphia: P. Blakiston's Son and Co., 1920.) 2.00 dollars net.

IN its translation into "standard English" (*vide* preface) Prof. Copaux's excellent little book has suffered considerably. It may be that "chlorin," "sulfur dioxid," and "do not have" are "standard" English, but in many cases the translator does not appear to have understood what he was doing, and the result (*e.g.* p. 55) is quite unintelligible. There are numerous minor inaccuracies in translation, and others are added in the footnotes contributed by the translator. Through someone's lack of care, several dropped letters have been passed unnoticed. It is regrettable that before sending the book to the printers the translator did not submit his manuscript to someone with a knowledge of physical chemistry. In this way some serious errors might have been avoided. "Wolcott Gibbs" on p. 139 should be "Willard Gibbs."

A Last Diary. By W. N. P. Barbellion. With a preface by A. J. Cummings. Pp. xlviii+148. (London: Chatto and Windus, 1920.) 6s. net.

To speak frankly, we prefer Bruce Cummings to Barbellion—that is to say, the man as he appeared to others rather than as he chose to appear to himself. This diary, no less than the former, contains some brilliant bits of writing, but its mixture of slang and literariness, of wit and self-exposure, grows wearisome. In style and in substance Mr. Arthur Cummings's account of his brother is more pleasing. Barbellion's life was a tragedy, but he succeeded, apparently with intention, in depicting it so as to arouse irritation instead of sympathy. One longs to pity him, but that is the last thing he will permit. As a psychological document, however, the book is profoundly interesting, and for the humanist it is redeemed by the gradually touched-in portrait of simple, lovable old Nanny.

Impressions and Comments. Second series. 1914-20. By Havelock Ellis. Pp. 248. (London: Constable and Co., Ltd., 1921.) 12s.

IT is a pleasure, and in these days a relief, to turn to diarial musings distinguished by sanity, simplicity, and sobriety of statement. Mr. Havelock Ellis may hold strong views, he may deal boldly with dangerous subjects, but he expresses himself so calmly, so frankly, and with an undercurrent of such delicate humour that it were surely impossible to take offence. Unkind fortune had not hitherto distributed the books of Mr. Ellis to this reviewer, who therefore was unprepared for the discovery that one of whose work in other directions he knew was also among the most delightful writers of our day.

Here is no room to quote, though one can scarcely refrain in the face of that exquisite "Christmas Day, 1919." Nor is this the place to challenge an occasional argument; yet in suggesting that familiarity made the ancient Greek insensitive to the charm of the Athenian atmosphere Mr. Ellis has surely forgotten the famous phrase of Euripides: ἀεὶ διὰ λαμπροτάτου βαίνοντες ἀβρῶς αἰθέρος.

That which gives a poignant and peculiar quality to the book is the clear-eyed realisation of approaching departure. We seem to see an honoured worker, resting from his labours on the deck of a vessel that bears him over calm waters to a serene sunset. He looks forward and backward with equal mind, and ever and anon pens some brief message of wisdom or good cheer for those whom he is leaving on the shore.

Diseases of the Ear. By Dr. Philip D. Kerrison. Second edition, revised and enlarged. Pp. xxi+596+vi plates. (Philadelphia and London: J. B. Lippincott Co., 1921.) 35s. net.

THIS is one of the best works on diseases of the ear that have been published for a long time. It is very full and comprehensive, and is written with lucidity and even literary charm. It cannot be too highly praised and recommended.

New Studies of a Great Inheritance: Being Lectures on the Modern Worth of Some Ancient Writers. By Prof. R. S. Conway. Pp. viii+241. (London: John Murray, 1921.) 7s. 6d. net.

PROF. CONWAY'S "Great Inheritance" is classical—in this instance Latin—literature, and the authors with whom he is chiefly concerned are Cicero, Vergil, Horace, and Livy. It is not necessary to dwell upon the numerous instances in which Prof. Conway's originality and insight are brought to bear upon the interpretation of doubtful or obscure passages. It is enough to say that, even in dealing with comparatively technical points such as the authenticity of the minor Vergilian poems, he sees and, what is more, can convey to his readers their broader significance as elements in the history of culture, and, in particular, their bearing upon the problems of modern life. Most readers, we expect, will turn again and again to the lecture on "Man and Nature in the Augustan Poets," which, with its illuminating parallel between the circumstances which led Vergil and Wordsworth respectively to seek consolation and inspiration in Nature, is, in a brief compass, one of the best studies extant of Vergil's point of view.

In the final essay, on "Freedom and Culture," which, in a sense, sums up Prof. Conway's whole position, he indicates how the classical conception of freedom has moulded the social and political life of this country through our traditional system of education. To point out that this system of education is confined to one class which is ceasing, if it has not already ceased, to be predominant, raises the question of the comparative merits of political ideals and tendencies, which it would be out of place to discuss here.

Some Investigations in the Theory of Map Projections. By A. E. Young. (R.G.S. Technical Series, No. 1.) Pp. viii+76. (London: Royal Geographical Society, 1920.) 6s. net.

THE first of the new series of technical publications issued by the Royal Geographical Society is an exhaustive investigation of map projections based upon Airy's idea of making the mean square scale error a minimum. This principle was applied by Airy to zenithal projections as affording a reasonable compromise between the stereographic projection and the projection of equal area. Mr. Young shows how the arbitrary constants in Airy's solution should really be determined, and then proceeds to compare the minimum error projection with others belonging to the zenithal class. The conclusion reached is incorporated in a recommendation to cartographers to use the equidistant projection with total area true as being the best zenithal projection for all cases, except when some specially desired feature necessitates a different projection.

Similar methods are applied to conical projections. It is shown that for a zone the minimum error conical projection is nearly identical with

Murdoch's third projection—a remarkably accurate and simple process invented so far back as 1758, and in the opinion of the author the very best of all conical projections. Later chapters deal with the spheroidal shape of the earth, polyconic projections, finite errors, and the convergency of meridians.

The paper is mathematical throughout. The algebra is laborious, but the results are of great interest. Mr. Young's paper is a valuable contribution to the subject he deals with, and sets a high standard for the series it initiates.

Elementary Vector Analysis: With Application to Geometry and Physics. By Dr. C. E. Weatherburn. (Bell's Mathematical Series.) Pp. xxvii+184. (London: G. Bell and Sons, Ltd., 1921.) 12s. net.

AN excellent introduction to the subject of vector analysis is provided by this book. It is admirably clear, and a natural temptation to develop so fertile a theory in excessive detail and to multiply its applications has been successfully resisted. It is a more elementary work than Dr. Silberstein's "Vectorial Mechanics," and still more so than Joly's "Manual of Quaternions." All the ideas which are based on the differential operator of Hamilton are excluded, and the applications are limited to geometry and to the dynamics and statics of rigid bodies. Enough remains to place in a clear light the general principles of the subject, and its value is less apt to be obscured by the complexity of the material. It is understood, however, that the author contemplates a second volume, in which the higher developments will doubtless be treated. Without such a sequel the reader will be left unprovided with some of the most characteristic and important notions of the calculus.

The diversity of notation has always been, and is likely to remain, a hindrance to progress. The existence of Hamilton's system seems to have had a centrifugal result, and Tait's controversial methods probably had an effect precisely the opposite of that intended. The present author adopts the notation of Gibbs. At the moment the wider diffusion of vectorial methods is very desirable, and though the absence of a uniform notation increases the difficulty of pursuing the subject in different books, it is an obstacle on which too much stress can easily be laid.

The Formation of Colloids. By Prof. The Svedberg. (Monographs on the Physics and Chemistry of Colloids.) Pp. 127. (London: J. and A. Churchill, 1921.) 7s. 6d. net.

IN this small monograph the author, whose brilliant investigations on colloids are familiar to all interested in that important branch of science, has given a very concise account of much recent work on the formation of colloids. References to the literature are given, and the book is valuable in bringing together much scattered information on the subjects of which it treats. The printing and illustrations are well done.

Letters to the Editor.

[The Editor does not hold himself responsible for opinions expressed by his correspondents. Neither can he undertake to return, or to correspond with the writers of, rejected manuscripts intended for this or any other part of NATURE. No notice is taken of anonymous communications.]

Atmospheric Refraction.

THE proposition that "the course of a nearly horizontal ray of light in the lower part of the atmosphere is a circular arc having a radius of 14,900 geographical miles" has been stated by Mr. Mallock in a letter in NATURE of June 9, p. 456. Mr. Mallock states later on in the same communication that rays that are pointed a few degrees up or down will still be arcs of a circle of 14,900 miles radius.

It has been customary for many years in all survey departments to assume that the angle of refraction on a ray bears to the angle subtended at the centre of the earth a ratio denoted by k , which is called the "coefficient of refraction," assumed to be constant at a given point for all rays. It is easy to see from this that the ratio of the curvature of the ray—tacitly assumed to be circular—to the curvature of the earth is $2k$; and that if $2k=1$ a horizontal ray would circle the earth. According to Mr. Mallock's result, $2k=3960/14,900$, taking the earth's radius as 3960 miles, which leads to $k=0.133$. Now this is *not* a value ordinarily met with in practice. In Clarke's "Geodesy" values of k derived from observations of the Ordnance Survey are given as 0.0809 for rays over water and 0.0750 for rays over land. These values are not far different from values obtained from other surveys.

Mr. Mallock's reasoning is based on the equation

$$v_h = v_0 \left(1 - a \frac{H-h}{h} \right).$$

When $h=0$ this becomes $v_0(1-0.00029)$, or v_0/μ , where μ is the refractive index of air at standard pressure and temperature. While this is correct, it appears to me to be quite erroneous to consider the equation as giving the correct velocity at heights of a few thousand feet. It may not be incorrect to state for a limited range of height that the velocity varies as the height; but surely it is incorrect to deduce the factor of this variation from an assumed law which gives the velocity at height H (the height of the homogeneous atmosphere = 8.3 km.) equal to the velocity *in vacuo*?

If the refracted ray is circular and of the same radius of curvature for rays deviating several degrees from the horizontal, it would follow that the value of k at two considerably different levels would be the same. Now the refraction depends on $\mu-1$, which varies as the density of the air. It is manifest that k is smaller at a considerable height than at sea-level in the proportion of the densities at the two heights. The value of k varies not only with the height, but also with the angle of elevation of the ray. The most convenient plan so far evolved is to speak of the "coefficient of horizontal refraction," k_0 , and to give values for this quantity at various heights. Under certain average conditions for a ray from A to B, points the heights of which are h_a and h_b , the refraction may be computed by using the coefficient of horizontal refraction appropriate to height $1/3(2h_a+h_b)$, while for the reverse ray $1/3(h_a+2h_b)$ should be used. The values of k_0 , which follow from purely theoretical considerations if a temperature gradient of 3° F. per 1000 ft. be assumed, vary from 0.08 at sea-level to 0.05 at 19,000 ft. for temperatures and pressures 82° , 30 in., and 25° , 15 in., respectively. These values are found to account very well for refraction in numerous Indian observations.

Refraction is not, in general, constant throughout

the twenty-four hours. It is usually smallest in the afternoon at about 3 p.m., and the minimum value then reached is approximately the same from day to day. On this account observations are often restricted to the hours between 2 and 4 p.m. It may easily happen that the refraction at 8 a.m. is double that at 2 p.m. The values of k given above refer to minimum refraction. Recent research has shown that the diurnal change is due mainly to the changes of temperature in the first 300 ft. of the atmosphere; in that region the form of the ray of light is by no means circular. Beyond a height of 300 ft. temperature changes in the air due to conduction practically disappear. For rays of light which remain most or all of their length within a distance of 300 ft. from the ground, highly anomalous values of k may, and generally do, exist. In such cases afternoon refraction is smaller than is indicated by values of k already given, and in some cases is zero, or even negative. Such rays require special consideration.

Results of a good many observations will be found in my "Formulæ for Atmospheric Refraction and their Application to Terrestrial Refraction and Geodesy" (Professional Paper 14, Survey of India, Dehra Dun, 1913); and a more recent article in "The Dictionary of Applied Physics" (Macmillan and Co.), now under publication, may also be consulted.

J. DE GRAAFF HUNTER.

Dehra Dun, United Provinces, India, July 13.

THE only points in Dr. Graaff Hunter's letter to which I need refer are (1) the objection raised against taking the refractive-index gradient for the lower levels of the atmosphere as being identical with that which would make $\mu=1$ at the height of the homogeneous atmosphere, and (2) the statement that "conduction" of heat extends to a height of 300 ft. above the ground.

With regard to (1), the pressure gradient near the ground, and the density and refractive-index gradients also, decrease linearly at such a rate that if the linear relation continues to hold, the pressure and density would be zero and the refractive-index unity at the height H , and this is the gradient which should be used in correction for refraction to such heights, as the linear relation is a sufficient representation of the facts. How far depends on the order of accuracy aimed at.

Temperature effects may make a difference of 1 or 2 per cent. per 1000 ft., but in such an uncertain correction as that for terrestrial refraction this is scarcely worth notice.

The presence of water-vapour will have an effect as well as variation of temperature, and it will generally be impossible at any particular time and place to know for certain what the refraction really amounts to, especially if the course of the ray is long.

(2) It is scarcely correct to speak of the irregular distribution of temperature near the ground as being due to conduction. True conduction in the air is quite insensible compared with diffusion by eddies and the general instability of flow. A. MALLOCK.

The X-ray Structure of Potassium Cyanide.

WRITING in the current number of the Proceedings of the Royal Society, Prof. A. O. Rankine concludes from determinations of the viscosity of cyanogen gas that the cyanogen molecule "behaves in collision like a hard body formed by two overlapping hard spheres, each of which has the kinetic properties of a nitrogen molecule." He gives as the distance between the centres of these overlapping spheres 2.3×10^{-8} cm. Prof. Rankine also remarks: "It is significant that the crystals of potassium cyanide and those of the potassium halides are usually stated to be iso-

morphous, and that, in addition, we find that KBr and KCN have nearly identical molecular volumes—43.1 and 42.8 respectively. Thus if CN replaces Br there is no appreciable change in volume, and we may conclude, tentatively, that the cyanogen radicle and the bromine atom have the same size."

Acting on the suggestion of Prof. W. L. Bragg, the writer has made X-ray examinations of small single crystals of KCN by the ordinary spectrometer method, and of powdered crystals by the modification of the method recently described by Sir W. H. Bragg before the Physical Society of London. The results of this preliminary investigation indicate that the underlying structure of KCN is similar to that of KBr, the cyanogen radicle replacing the bromine atom. For instance, the strongest reflection is that given by the [100] face at a glancing angle of $6^{\circ} 15'$. This corresponds to a distance of 3.27 Å. between the planes, and the calculated mass associated with the unit cube the edge of which is of this length is one-half of the mass of the KCN molecule; this is a characteristic of the face-centred lattice. The first-, second-, and third-order reflections from the [100] face have intensities which decrease in the normal way, although at a greater rate than is usually the case; the first-order reflection given by the [111] face at a glancing angle of $5^{\circ} 40'$ is relatively small, while the second-order reflection at $11^{\circ} 30'$ is normal, as is also the first-order reflection from the [110] face. These spectra correspond to those given by NaCl, where the unit of the structure consists of a cube with atoms of one kind arranged at the corners and face centres, and atoms of the other kind at the mid-points of the edges and at the cube centre.

The data obtained, while being sufficient to fix the position of the CN radicle as a whole with respect to the potassium atom, afford practically no evidence as to the disposition of the carbon and nitrogen atoms towards each other. So far as the lower orders of spectra are concerned, the CN radicle behaves as a single unit, whose power of diffracting X-rays differs from that of the potassium atom. The edge of the unit cube in the KCN crystal is 6.54 Å. Taking 4.15 Å. as the diameter of the potassium atom (Prof. W. L. Bragg, *Phil. Mag.*, August, 1920), this leaves 2.39 Å. as the width of the space, measured along the cube edge, to be filled by the CN radicle. The diameter of the bromine atom is 2.38 Å.

The results of the investigation will be published in detail elsewhere.

P. A. COOPER.

Manchester University, July 28.

An Ornithological Problem.

STAYING this last week-end with a friend at Overstrand, I was much puzzled on the morning of August 6 by a strange bird which I first saw sitting on some low iron gates at the end of the lawn, when I took it for some kind of hawk. It then settled for a time on a croquet-hoop, and ultimately flew away, when its long wings and tail and smooth flight again suggested a hawk. My host, who had seen it before, thought it might be a cuckoo, and this, when a little later we saw it again in flight, seemed a probable solution.

We did not see the bird again until the evening of August 7, when during a heavy shower it appeared on the lawn and perched on a croquet-hoop close to the house. I then saw that its plumage was not grey-blue, like the adult cuckoo, but a rich mottled brown, and I began to think that it might be a nightjar, though its beak seemed a little too long and its appearance in a beautifully trim garden on the edge of the sea, in the daytime, out of character. Moreover, both on gate and croquet-hoop it sat crosswise, not lengthwise as the nightjar does on a branch. It also

occasionally hopped, somewhat clumsily, across the lawn and regaled itself with a worm like any thrush.

On my return to town it was suggested to me that the bird might be a young cuckoo. It so happened that I had never seen one, and so was not aware how different the plumage is from that of the adult bird. After consulting the authorities, however, such as Dresser and Lilford, I am satisfied that this is the right solution, for the mottled brown plumage is quite in order, and the beak and the length of wings and tail are clearly more those of a cuckoo than of a nightjar. Moreover, we are expressly told that the cuckoo when on the ground hops in an ungainly fashion, whereas it is doubtful whether a nightjar with its peculiarly constructed feet could hop at all. The cuckoo, like the nightjar, is normally insectivorous, but this bird might have been brought up by a thrush and imitated its foster-parent's method of dealing with worms on a lawn. Presumably the young cuckoo is not ready for its long flight across sea so soon as the adult bird, of whom we read, "In August, go he must."

GEORGE A. MACMILLAN.

August 9.

Uniform Motion in the Æther.

It seems to be fairly generally conceded that uniform motion relative to the æther is, in principle, undetectable by optical devices. Poincaré, for instance, who did not entirely accept the positions of relativity, stated as his opinion that "optical phenomena only depend on the relative motions of the bodies concerned, and this not to quantities of the order of the square or cube of the aberration, *but rigorously.*"

A very simple consideration, however, shows that such a view is untenable. Thus, if we have a vertical mirror, with a horizontal motion in its own plane relative to the earth, and if a horizontal beam strikes it, the angles of incidence and reflection must, as measured from the moving mirror, be equal, for otherwise the measured discrepancy would determine the earth's motion.

Owing to the aberration, however, these apparently equal angles are not, in general, truly equal, nor are they equal as measured from the earth. It is only when the direction of the earth's motion is in the direction of the horizontal axis of the mirror that they will be equal when so measured.

This determines the direction of the earth's motion, and from the discrepancy in the other cases the magnitude of the velocity could be found.

An effect of the FitzGerald-Lorentz contraction would be to distort angles, so that, for example, a measured right angle, the bisector of which was in the direction of the earth's motion, would be greater than a true right angle; but this would not be compensatory in the case of the mirrors, and would itself, in another connection, serve to determine the earth's motion.

In fact, angular measurements of the stars would suffer discrepancies of a maximum of about 0.001", in opposite directions, at intervals of three months, owing to the earth's motion in its orbit, and any added motion would probably be detected if an accuracy of 0.001" in the measurement of large angular distances could be obtained.

As another example of a different kind, the simple immersion in still or moving water of the Michelson-Morley apparatus ought, theoretically, to give a positive result, since the water moves relatively to the æther, and Fizeau's law indicates that the velocity of light in moving water is not the same in all directions; while if the water moves relatively to the apparatus, this velocity is independent of the particular contractions of the latter.

E. H. SNYGE.

Dublin.

As Mr. Sygne says, the angles of reflection and incidence as measured by an observer moving with the mirror must be equal. When the motion of the mirror relative to the earth is in its own plane, the effect of the FitzGerald contraction is the same on each angle, since it affects all distances parallel to the motion in the same ratio, while leaving those perpendicular to the motion unaltered. Thus the angles will appear equal to an observer fixed with regard to the earth. They would also appear equal if the motion was normal to the plane of the mirror, but not if it were in any other direction than these two. Even in the last case, however, the difference would depend, not on the motion of the earth, but on the motion of the mirror relative to the earth.

Again, it is true that the apparent distance between two stars must vary during the year on account of the variations in the direction of the earth's motion relative to the stars; if all larger disturbances were eliminated this could be detected, but observation of it could only determine the variations in the velocity of the earth relative to the stars, not its motion in æther or "space." The same applies to the immersion in water of the Michelson and Morley apparatus; none of these methods could tell us anything we do not already know more accurately by other means.

HAROLD JEFFREYS.

Conical Refraction in Biaxial Crystals.

AN arrangement for demonstrating conical refraction usually found in laboratories is a piece of aragonite crystal mounted inside a little tube which has one end covered with a metal foil pierced by a number of pin-holes, and an eye-lens in a focussing mount at the other end. When the tube is directed against a luminous object and the eye-lens focussed on the pin-holes through the crystal suitably oriented they are seen as luminous rings of light. Writers on physical optics who describe this experiment refer to it as illustrating *internal* conical refraction—that is, as due to the fact that the Fresnel wave-surface has a tangent-plane which touches it along a circle. I wish to point out that this is really an error. A little consideration will show that as the eye-lens is focussed on the pin-holes, which may be as small as we please, we are concerned here with the waves *diverging* from them in all directions within the crystal, and the observed effect is due to the fact that the two sheets of the wave-front intersect at a conical point. In other words, the experiment really illustrates *external* conical refraction. This is confirmed by the fact that an extended source of light may be used without interfering with the success of the experiment.

A remarkable effect is observed if, with the tube pointed towards an open window, the eye-piece is steadily drawn back from the crystal. It will be noticed that a well-defined image of each pin-hole may be traced behind the crystal for a distance of several centimetres. The formation of this continuous image by a crystalline plate with parallel faces cannot be explained on geometrical principles, and is of great interest. The effect appears to be due to the dimpled form of the wave-front within the crystal, and is being further investigated by Mr. V. S. Tamma and myself.

C. V. RAMAN.

22 Oxford Road, Putney, S.W.15, August 4.

Coiling of Underground Shoots of *Convolvulus arvensis*.

THE shoots ascending from the rootstock of *Convolvulus arvensis*, before they reach the surface of the ground, are frequently found to be coiled. The coils vary in diameter from one to two inches or more,

and lie closely adpressed upon one another. A considerable length of shoot, in some cases three or four feet, is thus compressed into a small space. No object has been found enclosed by the coils which would serve as a stimulus; the soil contains very few stones to obstruct the straight upward growth of the shoots. In a few cases a similar coiling has been observed in the ascending shoots of *Carduus arvensis*. One of the "popular" names of *Convolvulus arvensis* is "Devil's Corkscrew." These white corkscrew coils of the shoots underground seem more likely to be the origin

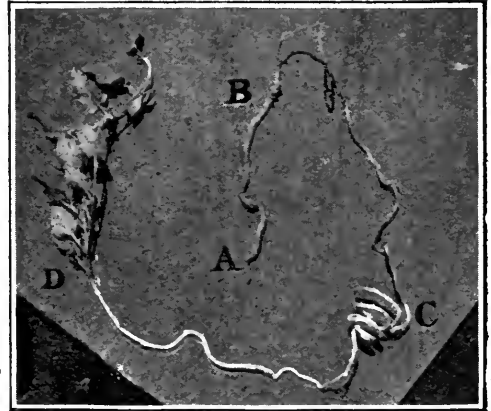

[FIG. 1.—Devil's Corkscrew (*Convolvulus arvensis*).]

of the name than the less noticeable above-ground coiling portion.

In the accompanying illustration (Fig. 1) A-B is the rootstock; the ascending shoot, originating at B, is coiled at C, and terminates in the leafy above-ground portion at D. (The coils were slightly pulled out before taking the photograph.)

J. E. H. BLAKE.

Bees and Scarlet-Runner Beans.

I SHOULD like to add to the remarks on bee visitors to the flower of the scarlet-runner bean contained in my letter in NATURE of July 28, p. 684, the following further observations. Some ten days from the time of making the original notes a complete change was found in the insect visitors to the flowers and in their behaviour towards them. Instead of the smaller black and black with grey humble-bees busy over the blooms in what I termed the legitimate way, there were numbers of a larger, yellow-banded species of humble-bee that had bitten every newly developed bloom and were searching the nectaries through the perforations made in the base of the flower. They all unhesitatingly scrambled to the underneath part of the blooms, which in every instance had been bitten before the observation was made. Many honey-bees were following in their wake, busily draining the exposed nectaries of every particle of the sweet liquid that had been left or had newly formed.

The results of the two ways of visiting the flowers are very marked and distinguishable. The earlier flowers and lowest on the racemes that were first visited without injury are replaced with a good show of pods, while the later bitten blooms drop off very quickly, with only barren pedicels remaining.

The season being so unusually forward gave opportunity to the earlier insect workers, which made some return to the plant for its sweet gifts, while the later humble-bees are mere depredators that only rob and injure the plant.

HARFORD J. LOWE.

The Museum, Torquay, August 3.

Remarks on Simple Relativity and the Relative Velocity of Light.¹

By SIR OLIVER LODGE, F.R.S.

II.

The Relative Velocity of Light.

CONSIDER once more the assumption that is either tacitly or confessedly introduced into the establishment of the Larmor-Lorentz transformation and the consequent composition of velocities.

It is this: that the velocity of light outside and far away from matter is absolute; in the sense that it will be measured as the same velocity by every observer, no matter what his relation may be to space and time—*i.e.* no matter where or when he exists, or at what unknown speed he may be moving, not even if his speed were infinite.

A very extraordinary idea that, and one difficult to believe. It is true that it follows from the equations previously written down by Larmor and Lorentz, but they were originally limited to the small range of u/c that covered all practicable observations, and so were not meant to be of universal application and pressed into infallible consequences. The merit, or demerit, of Einstein is that he had no such compunction, and was ready to follow the argument whithersoever it led; and the result—made possible by his wonderful grasp of recondite machinery which he annexed from pure mathematicians, especially recondite when gravitation was included—was a far-reaching effort towards a universal synthesis, in the course of which a few definite features amenable to observation emerged—with the known brilliant results.

Now that the velocity of light in free æther is constant is admitted by everybody, the only reasonable alternative would be some dependence on wave-length, which would mean that the æther was coarse-grained; and that is experimentally negated by several phenomena and by all manner of determinations of what used to be called a ratio of units, " v ," but is more intelligibly and satisfactorily called a measure of the product of the magnetic and electric ætherial constants μK .

But that the relative velocity of light, determined by an observer travelling with speed u to meet it, should still appear the same, and be independent of his motion, is curious, not to say paradoxical. The relative velocity of the observer and the light must be $c+u$ —common-sense forbids otherwise,—but if he seeks to measure it he will get, we are told and inclined to believe, not $c+u$, but $(c+u) \div (1+cu/c^2)$, and that is simply c .

So far as I know, no one has ever measured the apparent velocity of light from a star or from one of those spiral nebulae from which the earth is receding at hundreds, or even thousands, of miles per second. It is not easy to see how it can be done, for the readily observed Doppler effect is always attributed to relative motion of source

and observer; and if those are relatively fixed it has been definitely shown that no steady motion of the medium has any observable influence on either direction or frequency (Phil. Trans., 1893, vol. clxxxiv., p. 784). Gusts, however, cause wailing; and by utilisation of the variation of an already occurring Doppler effect something may be done (*l.c.*, p. 785). But, in view of the universality of the above transformation equations, we may admit that it is unlikely that any result other than c will be obtained. It is by assuming the velocity of light constant that the recession velocity is measured; the whole observed retardation is naturally attributed to relative velocity of source and observer; though if we could be sure that all the observed relative velocity really belonged to the receiver, and none of it to the source, we should know that the reason we were able to observe an apparent change in frequency was because of the resultant speed at which we received the waves. But that is just the difficulty—we cannot tell how much of the recession belongs to the source and how much to the receiver. If we could know the observer's speed through the æther we could clearly say that he met the waves more slowly or more quickly than he would otherwise get them; and this reasonable statement has never been disproved by observation.

We ought not to claim, therefore, as some philosophers do, that the fundamental hypothesis of Einstein about observed velocity of light has been directly verified and is a sound basis on which to found a theory. The hypothesis does not justify any theory, though a successful theory may justify the hypothesis. A mistaken claim for what has been done by experiment is often made; and as clear statements are always valuable, whether right or wrong, I select for quotation one from Lord Haldane's recent book, "The Reign of Relativity," on p. 82:—

Long before 1905 it had been found by experiment that the velocity of light appeared to be always 186,330 miles per second, whether the passage of its rays was towards us while we were at rest with regard to its source, or whether we were ourselves moving towards that source.

Now whether what is here asserted to have been "found by experiment" about the velocity of light be a fact or not, no observation of a discriminating kind had been made before 1905; and I would myself deny that any such observation has been made since. Certainly no experiment of the direct kind suggested in this quotation has ever been made—it is doubtful if it can be made. Every purely terrestrial measurement of the velocity of light has been made, and must necessarily be made, on light which has travelled round a contour, or, what is the same thing, which has gone and returned over the same path. Such an experiment proves nothing, either for

¹ Continued from p. 719.

or against a discrepancy due to the observer's motion, in the measured 186,330 miles a second. In a to-and-fro journey there is complete compensation for any possible discrepancy in speed so far as small quantities of the first order, involving the ratio u/c , are concerned. The only outstanding discrepancy to be expected is of the second order of minutiae; and that, as many of us think, is systematically neutralised by the FitzGerald-Lorentz contraction, which, though it is a consequence of the electrical theory of matter, is stigmatised as an unreal contrivance, a mere invented refuge, by the philosophers above referred to.

Relativity has only to do with second-order effects; it essentially depends on ds^2 , the square of a small interval; but the statement above quoted is not entirely about second-order effects; it relates to the first order—to a journey in one direction—and would require for direct verification an observation of the difference in the time of a single journey, when the observer is moving (*a*) with, (*b*) against, an æther stream.

The nearest approach to a measurement of this kind that might conceivably be made would be a vastly improved determination of the velocity of light by a method based on the observation of some periodic feature in Jupiter's satellites during the course of Jupiter's year. To make a determination possible at all, the earth must be moving either to or from Jupiter at the time—it does not matter which—and the chance of obtaining a positive result depends on the varying angle which the line joining earth and Jupiter makes with the sun's way, or rather with the direction of locomotion of the solar system through the æther, whatever that direction may be.

But I think it is generally agreed—subject, however, to the opinion of the chief authority on those motions, Prof. R. A. Sampson—that the gravitational theory of the satellites, perturbed as they are by each other as well as by the oblateness of Jupiter, is not yet nearly perfect enough to enable us to decide the question whether the velocity of light deduced from their eclipses is dependent on the season of Jupiter's year,—in other words, whether light appears to reach us with the same speed when we are looking at Jupiter down-stream as it does when we are looking at him up-stream (see *Phil. Trans.*, 1893, vol. clxxxiv., pp. 746, 779, and 785). For we have no means of determining the instant at which the light starts from Jupiter; all that we can really observe is the time that light takes to transit the distance travelled by the earth in the interval between two eclipses.

Apart from all astronomical observation, however, it has been claimed that the rather recent pair of experiments of Prof. Majorana, with moving mirrors (*Phil. Mag.*, February, 1918, p. 163, and January, 1919, p. 145), do establish the thesis that the observed velocity of light is independent of the relative motion of observer; but they, too, are ob-

servations made on a to-and-fro journey, and, therefore, for the present purpose, are beside the mark. If light were a projectile, it could be hit forward by a moving mirror, like a cricket ball, but no one can suppose that any kind of impact can alter the subsequent velocity of waves through a medium, nor is it to be supposed that motion of a source can affect the travelling rate of waves which it has emitted and abandoned.

More Careful Discussion of Doppler Effect.

Motion of the source does not affect velocity, but if a moving source emits waves at constant frequency n , the wave-length ought to be different in different directions θ , and this modified wave-length,

$$\lambda' = \frac{c \cos \epsilon + u \cos \theta}{n}$$

can be observed by a fixed observer, and, when compared with the normal $\lambda = c/n$, is called the Doppler effect. The small aberration angle ϵ , between ray and normal to wave-front, is defined by $c \sin \epsilon - u \sin \theta = 0$.

If, however, the source is fixed in the æther, and only an observer is moving, the velocity and the wave-length are both quite normal; but the frequency with which the waves are encountered by the observer will depend on the speed and direction of his own motion. Consequently there is again an observable Doppler effect expressed as

$$n' = \frac{c \cos \epsilon + u \cos \theta}{\lambda}$$

to be compared with $n = c/\lambda$.

Hence if an observer steadily chases a source, keeping a fixed distance between them, the two effects—the real wave-elongation and the apparent frequency increase—neutralise each other *exactly* whatever the direction of joint motion, because $n\lambda' = n'\lambda$. So drift through a medium produces no trace of a Doppler effect.

Nevertheless, the two types of effect—one with source only moving, the other with receiver only moving—are not identical; they are the same when both are moving in the same direction, so as to be relatively at rest, but not the same when they are moving relatively to each other. For, writing u/c as α , and taking the case of relative recession between source and receiver, we get, for the observed frequency ratio,—if it be the source only which is moving,

$$\frac{n'}{n} = \frac{\lambda}{\lambda'} = \frac{1}{\cos \epsilon + \alpha \cos \theta};$$

while if it be the receiver only which is moving,

$$\frac{n''}{n} = \cos \epsilon - \alpha \cos \theta.$$

Hence

$$\begin{aligned} n'' \text{ is not equal to } n', \text{ but} \\ \frac{n''}{n'} &= \cos^2 \epsilon - \alpha^2 \cos^2 \theta \\ &= 1 - \alpha^2 \sin^2 \theta - \alpha^2 \cos^2 \theta \\ &= 1 - \alpha^2, \end{aligned}$$

which is the square of the usual FitzGerald con-

traction. The relativity doctrine, in order to avoid recognising any such difference, would presumably distribute this factor between the two expressions, making them

$$\frac{\lambda'}{\lambda} = \frac{\cos \epsilon + a \cos \theta}{\sqrt{(1-a^2)}},$$

$$\frac{n''}{n} = \frac{\cos \epsilon - a \cos \theta}{\sqrt{(1-a^2)}};$$

so that there shall be equality between $n''\lambda'$ and $n\lambda$, and then it is impossible to tell to which body the motion belongs.

Note that the introduced β factor cannot in this case be attributed to a FitzGerald contraction of the grating—if a grating is used as the measuring instrument,—for the aspect of the grating to the incident light, and therefore to the motion under examination, is normal, not tangential. But the law of reflection is interfered with by the motion, in a way investigated in Phil. Trans. for 1893 (vol. clxxxiv., A, pp. 793–800), and the result is to give a modified deviation which will be interpreted as part of the Doppler effect. The discrepancy is reckoned, on p. 798 *loc. cit.*, for any incidence angle i and any drift angle ϕ , as $\alpha^2 \cos^2 i \sin 2(i-\phi)$; so it is a maximum for normal incidence and for a drift direction making 45° with the ray.

This might readily have the average value $\frac{1}{2}\alpha^2$ needed to replace the ordinary β factor, but in so far as it yields a factor depending on the angle ϕ its changes seem amenable to observation.

In the same Phil. Trans. paper I show (p. 787) that the Doppler effect observed by a moving grating is really an aberration effect, due to the motion being partly across the diffracted rays, although the incident ray may be along the drift. For a grating *must* deviate in accordance with wave-length, whether it be moving or stationary, so far as first order is concerned.

But the question arises, What happens when the grating is drifting partly in its own plane ($\phi=90^\circ$) and thereby suffering a FitzGerald contraction?

The answer seems to be that the extra aberration due to this drift will just compensate the second-order Doppler effect otherwise to be expected from the ostensibly narrower-ruled grating. There are certain possibilities here, however, which need looking into.

Summary of this Portion.

The Einstein formulation seems to justify itself by results, and may be supposed to strengthen the claims of any philosophy suggested by it, as well as to establish the explicit assumptions on which the theory is based; but we should be careful to perceive that justification is of this subsequent inferential order, and that it is not primarily the outcome of experiment—certainly not of any old unexplained measurements. The whole thing depends on the law that we postulate for the composition of velocities. When two velocities in the same direction are compounded, is the result-

ant velocity $u+v$, or is it really $\frac{u+v}{1+\frac{uv}{c^2}}$? Einstein's

assumption led to the latter as a physical truth, and if that is right it is algebraically undeniable that if one of the component velocities is c , the resultant will be c also; and any such criterion as my old experiment (1892–97) with rotating discs, whereby it was sought to observe a possible difference between $c+v$ and $c-v$, cannot give any positive result. Nor can it, by giving the result zero, prove that v is 0, because, as a matter of simple algebra, if $u=c$, no sort of v can make any difference, not even if it be infinite.

So also Michelson's experiment can show nothing, nor can any velocity compounded with the velocity of light exhibit itself in any way, if that is the true law of composition of velocities in general.

But why into this composition formula should there enter the velocity of light? If, for instance, the composition is between a ship and a tide, or a satellite and a planet, or the usual railway train and embankment, one cannot avoid the question, What on earth has the speed of light to do with it? any more than the speed of sound or of a messenger boy, or whatever agent it is which brings information to an observer. It is true that the law of composition is essential to the principle of relativity, but when we are engaged in establishing that principle it is scarcely fair to assume it.

The curious law of composition is deduced from the Lorentz transformation of space and time to other co-ordinates,

$$x' = \beta(x - ut); \quad t' = \beta\left(t - \frac{ux}{c^2}\right); \quad \beta^2(c^2 - u^2) = c^2;$$

and in the establishment of these equations it is assumed that all observers have the same value of c , or that $x^2 - c^2t^2$ is invariant.

I apprehend that for this transformation, treated as formal correspondence, there is a good deal to be said, so that any law deduced from it may be true with all its consequences; but it is surely a mistake to say that the measured velocity of light has been experimentally proved constant. So far as the velocity of light is concerned, the reasoning is circular. I suggest that it is also dangerous to adopt a mode of exposition which denies reality to the FitzGerald contraction. Still more is it premature to assume, as more than a temporary conclusion, that no phenomenon demonstrating our motion through the æther of space can ever be discovered; which carries with it the implied suggestion that the inability is because such a medium does not exist; so that not only can all motion be treated undynamically as a purely geometrical or kinematic relation, but so also that in absolute truth there is no difference discernible between a dog wagging its tail and the tail wagging the dog. Kinematically, it is as easy to take the apple as standard of reference as it is to take the earth, but physically and ener-

getically the treatment can only be satisfactory when their combined or reciprocal motion is balanced about their common centre of gravity.

Centres of gravity, however, presumably disappear from relativity; and, what is more serious, so does the conservation of energy. For if there is nothing absolute about speed there can be nothing absolute about kinetic energy. The relativity expression for kinetic energy contains an arbitrary constant; and whether energy is conserved or not becomes a matter of convenience and definition. The claim that relativity pressed to extremes does away with all conservation, as hitherto understood in physics, has been seriously made by the eminent mathematician, Prof. Hilbert, of Göttingen. On the other hand, it might be replied, according to Sir Joseph Larmor, that kinetic energy has always been treated as relative to some other body on which work might conceivably be done, and that the really invariant quantity is not energy, but the integral of energy with time, called "action"; or as it may be regarded, perhaps preferably for some purposes, i times angular momentum.² For this appears to be independent of frames of reference—which energy certainly is not.

Acceptance of the theory of relativity correlates results, but does not explain them. The

² Which, by the way, is very suggestive of a constitutional gyrostatic æther structure.

theory does not even seek to explain or account for phenomena: they just are so. It is not a dynamical theory, it is a method of arriving at results, like the second law of thermodynamics and the conservation of energy. The full dynamical explanation remains to be worked out, and it may turn out to be on very much the old lines along which we had previously regarded physical phenomena. The true relation between æther and matter, and how their interaction generates and affects light, is an immense subject, not in the least exhausted, and barely encroached upon, by the perception that certain consequences inevitably follow from an admission that the velocity of light is a critical limiting velocity, which cannot be exceeded, and which when compounded with any other velocity retains its old value.

Whether the properties of the æther can ever be formulated in terms of the same sort of dynamics as we have found so fruitful and effective in dealing with matter is at present an open question. Quite possibly a different dynamics may be needed, one perhaps of which we have as yet no conception; but let us not shut the door on discovery, assume that nothing of the sort can ever be arrived at, and think that pure mathematical abstractions, glorified and complicated sufficiently, can be an ultimate embodiment of physical laws or can adequately express the facts of Nature.

(To be continued.)

The Conference of the International Union against Tuberculosis.

THOSE who have followed the course of tuberculosis in this country have noted that during the years of the war there was a sudden interruption in the fall of the curves illustrating case-rate and death-rate from that disease. Our work was then in fields abroad. Now, however, that we are getting back to pre-war conditions, peoples and nations are again joining forces in a new campaign against tuberculosis in our civil populations, and at the recent conference in London of the International Union against Tuberculosis delegates from forty nations, including China, Japan, Persia, and Czecho-Slovakia, met to discuss the great question of the cure and prevention of tuberculosis. Science knows no national borders, and it is obvious that the union is anxious to work with men from all nations, and to this end has drawn up a series of tentative regulations in order that when German physicians have composed the differences amongst themselves arrangements may be made for their reception into the councils of the union. The secretary of the old International Association against Tuberculosis appears to have assumed that everything would go on as before, and somewhat injudiciously made an attempt to call the old association together as a rival to the conference of the union of Allies and neutrals held in Paris last year. The wiser amongst his countrymen

were against this, and at present the German physicians are divided into two camps. For the present the International Union is content to make good its own footing, go its own way, and lay down its own lines of operations, at the same time leaving the regulations so elastic that as asperities are smoothed down and difficulties removed German workers may come in and take their part in its great work; and it is hoped that steps towards this will have been taken when the meeting is held in Brussels next year, or, at any rate, in Washington two years later. By that time the League of Nations may have got under way, and the international character of the union may have become complete.

At the opening sitting of the London meeting the Foreign Secretary, Lord Curzon, and the Minister of Health, Sir Alfred Mond, blessed in no uncertain terms the ideals and work of the union, and their presence no less than their works may be accepted as of good omen that the Government authorities will, in their anti-waste difficulties, remember that a penny wise Health Ministry may be pound foolish where the public health is concerned, and that the same holds good as regards the Board of Education.

Prof. Calmette, in a most interesting opening address characterised by all the clearness of vision and beauty of expression for which this French savant is noted, outlined a new hypothesis

as to the importance of tuberculosis "carriers"—*i.e.* centres of infection, themselves healthy to all intents and purposes. He claims (though the claim is not universally admitted) that von Pirquet's method of diagnosis is sufficiently characteristic to allow of a decision as to whether a patient is the subject of bacillary infection, or, in other words, capable of reacting to tuberculin as a result of the presence in the patient of a sensitising substance derived from the tubercle bacillus. Prof. Calmette holds, moreover, that by means of this reaction it is possible to work on a grand scale and to determine whether peoples and tribes, infants and adults, are infected by, or free from, tuberculosis. He quotes Col. Cummins and others to the effect that among African tribes about the equator where civilisation has not yet penetrated, and among the nomadic tribes of Arabs and Berbers, tuberculous infection is non-existent, or very rare, whilst in Natal, among the Zulus in the Transvaal, and in Madagascar, as also in the larger cities of North Africa, it is very prevalent. Those living in huts and native villages are, however, gradually becoming infected by contact with men from without. In the hinterland of the Cameroons from 3 to 6 per cent. only of adults are yet affected, whilst many aboriginal tribes are still quite free.

In civilised countries, although the reported percentage of tuberculous infection is comparatively high, a careful examination by the von Pirquet test and an examination of patients who die from other diseases would, Prof. Calmette claims, indicate the infection by the tubercle bacillus of many who, as yet, show no signs of tuberculous disease, and he believes that in the overcrowded cities of Europe and the United States few escape tuberculous infection, although the chances of death from tuberculosis are little more than one in eight. In the country districts the figures are not so high. Amongst the Kalmucks, even where the inhabitants have little intercourse with towns, 69.4 per cent. of the men and 30.6 per cent. of the women give a positive tuberculin reaction, whilst on the outskirts of the same territory, where commercial relations with the Russian population are very close, 95.7 per cent. of male adults and 88.5 per cent. of women give a positive reaction. Moreover, where differences occur, these are due very largely to the fact that tuberculous infection has been implanted in certain races over a longer or shorter period of time, although infections are also variable, being rare and slight or frequent and massive according to the particular mode of life of the people. Those who have been longest protected by virtue of their isolation from contact with the tuberculous prove to be most susceptible, aboriginal tribes and infants being the virgin soil on which the tubercle bacillus flourishes most luxuriantly. In the races that have been contaminated for centuries and exposed from infancy the disease assumes a chronic, slowly progressing form; but almost all become in-

fectured. He finds evidence in support of his contention in the susceptibility of the bovine species to tuberculosis in the domesticated condition, although the wild cattle of Madagascar and of the pampas of the Argentine are said to be free from this disease. (It was found by the Royal Commission on Tuberculosis that Jersey cattle, though free from tuberculosis in the island, were readily infected when brought over to this country.)

Prof. Calmette is of opinion that the spread of human tuberculous infection throughout the world is due entirely to disseminators of virulent bacilli, most frequently through persons suffering from phthisis, who scatter enormous numbers of bacilli in their sputum and intestinal excretions either directly or by means of objects soiled by them, or again through the agency of living carriers, such as flies. These open tuberculous cases are not the only factors in the dissemination of the disease. Many apparently healthy individuals suffering from latent or concealed tuberculous lesions which can be detected only by the tuberculin reaction are a source of danger in that they eliminate bacilli intermittently in their glandular or intestinal excretions, thus spreading infection in their environment.

E. C. Schroeder and W. E. Cotton found that 40 per cent. of cows giving a positive tuberculin reaction and showing no clinically demonstrable lesion discharged bacilli intermittently in their excreta, and that swine fed on these excreta easily became infected.

Similar observations were made by the Royal Commission on Tuberculosis, which, injecting tubercle bacilli into the circulating blood of healthy cattle, demonstrated their early appearance in the milk, whilst Calmette and Guérin showed that some of the bacilli injected into the blood-stream are eliminated through the bile passages. Lydia Rabinowitsch and Kempner, Tirze, with others in Germany, and Sheridan Delépine in England, have made similar observations with regard to the mammary glands of cattle. More recently it has been claimed by several observers that bacilli may often be found in the milk of tuberculous human mothers, even when the disease is in its early stages, or where only lymphatic glandular lesions are present. Prof. Calmette suggests that in the children of these mothers serious forms of tuberculosis are set up by slight but oft-repeated infections through breast-feeding or through prolonged or numerous accidental contacts with intermittent disseminators of bacilli. He goes further, and holds that when tuberculosis appears in environments where it has hitherto been absent it may have been introduced by a bacillus-carrier unrecognised because apparently healthy, which nevertheless has spread virulent germs either in excretions or through glandular secretions—*e.g.* milk in the case of lactating women; also that the disease in these more recently contaminated countries is more serious and more rapidly progressive than in the countries longer infected, and that it then assumes the form met with in young children rather than that met

with in adults. He argues from all this that individuals with occult tuberculosis—the so-called healthy carriers of tubercle bacilli—are largely responsible for the spread of tuberculosis, not only amongst aboriginal and hitherto isolated peoples, but also amongst infants. He claims that this recently acquired knowledge of an unexpected danger makes the organisation of social defence against tuberculosis more difficult than when prophylaxis had to be based only on the education and isolation of phthical patients, though he concedes that these are the principal disseminators of the disease. New peoples and infants should, wherever possible, be protected through a system of detection based both upon the judicious use of tuberculin tests and upon clinical examinations of the glandular system mainly by means of radioscopy.

It was interesting to find that Dr. Eric Pritchard, working along these lines during a period of ten years, had passed through his hands some thirty children who, by a process of injection with Koch's original tuberculin extending over five months, first in minute doses, to which they reacted, gradually increased up to 1 mg., to which the reaction was no more marked, could be immunised against any infection they were likely to be exposed to in the course of their lives. No accident such as might have been anticipated had occurred, and he was very hopeful that they had passed over that susceptible period of which Prof. Calmette had spoken.

It was felt by some who heard Prof. Calmette that his hypothesis, unless more fully explained, might lead to great misconception on the part of the public and be advanced as a reasonable excuse for inaction. If any apparently healthy person may be a "carrier"—and all may be infected in infancy—what good are elaborate precautions against tuberculous infection? The various public authorities might feel justified (and some might wish this) to sit with folded arms and tightly buttoned pockets. Later Prof. Calmette made it clear that his reference was only to those who had not hitherto been brought into contact with tuberculous patients, such as native races and

infants, and that in civilised tuberculous communities other factors, surroundings, conditions of life, sources of infection, etc., must all receive due consideration. It was insisted that much information on these points had already been accumulated, and that the time had undoubtedly arrived when the aid of legislation should be called in for the prevention of tuberculosis. Two great sources of infection, human and bovine—expectorations from the former, and milk from the latter—containing massive doses of tubercle bacilli, must still be dealt with, and dealt with effectively. No measure conducing to the removal of mass infection should be neglected. Panic or phthisiophobia may well be discouraged when we learn from Sir George Newman that in seventy-three years, since 1847, when the death-rate from tuberculosis was 3189 persons per million living, there has been a fall of 74 per cent., the standard death-rate from phthisis in this country in 1920 being 842 per million living. In other countries the decline, though not so marked, is still very substantial.

One feature was very prominent throughout the whole of the discussions. Although the search for prophylactic aids should not be discontinued, it must be recognised that the processes involved in tuberculosis are of a type different from those involved in most of the acute infective diseases, such as typhoid, plague, and the like, and, accepting this, we must follow Sir George Newman in his advice that "there is no beaten track in the further conquest of tuberculosis"; "the healthy child and the adult must be protected from massive, frequent, and prolonged infection"; "the powers of resistance of the patient must be fortified." "Freedom of thought, wide and deep research, and mobility of action will be necessary. Of much are we still in doubt, but of three things we may be certain. Only by surveying the complex problem, as a whole, in the spirit of preventive medicine, and co-ordinating the respective factors concerned, only by thorough, constructive, and intensive practice of our principles and by searching and finding the hidden secrets of immunisation, shall we at last conquer this disease."

The Progress of British Forestry.

THE First Annual Report of the Forestry Commissioners (H.M. Stationery Office, 1921, 9d. net) deals with the period ended September 30, 1920, since which date a whole planting season has intervened; but a preliminary note gives information of the progress made to date. The Forestry Commissioners are now in actual possession of 103,100 acres of land, of which 68,100 acres are classed as plantable with timber trees. The planting operations of the season 1920-21 have been successful, and the total area of new plantations is now about 8000 acres, while the stock of young trees in the nurseries is suffi-

cient to plant next season a largely increased area.

The Report opens with a sketch of the history of forestry in the United Kingdom, showing the stages which led to the passing of the Forestry Act in 1919. State forestry is a new departure in this country, and this part of the Report will instruct the public in the significance of a national forest policy. In the first period—that of destruction of the original forests, which lasted in some districts up to 1750—great clearances were made for agriculture, sheep pasture, and the smelting of iron-ore. In the next period—that of private

enterprise, 1750-1885—landowners attempted by their own efforts to re-establish the depleted woodlands, and they were aided only by voluntary associations like the Society of Arts and the Dublin Society, which encouraged effectively the planting of trees by their prizes and premiums. During the war, when it was a choice between importing food or timber, it was the timber available in privately owned plantations that enabled the people to be fed.

In the third period—that of inquiry, 1885-1915—it was gradually borne in upon the public mind that unaided private enterprise could no longer cope with the growing demand for timber by our ever-increasing industries and that the primeval forests of the world were not inexhaustible. Imported timber increased continuously in price during these thirty years. Select Committees, Departmental Committees, and Royal Commissions on Forestry followed in quick succession and made recommendations which were mostly unheeded. The Development Commissioners appointed in 1909 failed “to purchase and plant land found after inquiry to be suitable”—one of the duties imposed upon them—but it must be admitted that they did useful pioneer work in providing increased educational facilities, in appointing advisory forest officers, and in encouraging with loans certain municipalities to afforest their water-catchment areas. The state of affairs, practically much inquiry and no afforestation, was unsatisfactory in time of peace. One year of war showed how critical the position was in a time of national emergency.

The final stage in our forest history—that of State action, which began in 1915 with the setting up of Lord Selborne's Committee to expedite home fellings of timber—is characterised by the adoption of a definite national forest policy by the Government, which was approved by Parliament when the Forestry Act was passed in 1919. This policy has two aims. Its ultimate objective is the creation in the British Isles of reserves of

standing timber sufficient to tide the nation over three years in time of war. For this purpose the State must afforest 1,770,000 acres of new land—1,180,000 acres in forty years, and the whole in eighty years—and at the same time secure the continuance under timber (with an increased production) of the 3,000,000 acres of private forests which existed in 1914. The immediate objective is a ten-year scheme, based on a block grant of 3,500,000*l.* In this decade the Forestry Commission will afforest 150,000 acres of new land owned or leased by the State. The Commission is also bound to aid private owners and local authorities in planting 110,000 acres during the ten years.

The Report shows that there is no difficulty in the State acquiring and planting the acreage mentioned in the preceding programme. It is another story with regard to private forestry, for aid to which the Commissioners set aside 327,000*l.*, of which 137,000*l.* has been allotted to proceeds-sharing schemes between private individuals or corporate bodies and the State, and 190,000*l.* to grants and loans. However, the proceeds-sharing schemes, being hedged round with cumbersome rules to safeguard the public purse for the period of a rotation (fifty to one hundred years), are unpopular with landowners. Similarly, the statutory regulations, under which 2*l.* grants per acre are made for planting, prove to be so onerous as to offer no inducements to private individuals. The Commission must obtain powers to amend these regulations, which defeat the object of assisting landowners to make plantations.

The Report gives a detailed account of the operations carried out during the year, illustrated with a map showing the land acquired and the present planting centres. Education, research and experiments, and publications are dealt with briefly. Tables of imports of timber, statutory orders and rules, and other official documents conclude a Report which deserves to be studied by all interested in the progress of forestry in this country.

Notes.

THE classical experimental plots which Lawes and Gilbert started at Rothamsted have been of the greatest service to agricultural science, and their importance is constantly increasing. Fundamental questions in the physics, chemistry, and biology of agriculture can be attacked with more confidence in the light of results obtained from long-continued field experiments carried out on a systematic plan. Further, the results are capable of statistical examination. The importance of the Rothamsted experiments led to the institution of a parallel series at Woburn in 1876 by the Royal Agricultural Society. The Woburn soil is light and sandy, but that at Rothamsted is a heavy loam. The two series of experiments enable instructive comparisons to be made between these two soil types. All interested in agricultural science received with concern the decision of the council of

the Royal Agricultural Society to relinquish—owing to economic conditions—the Woburn experiments. Fortunately the danger has been averted. Arrangements have been made for the experiments to be continued under the auspices of, but legally distinct from, the Rothamsted Experimental Station. The general portion of the Woburn farm will continue under the direct control of Dr. A. J. Voelcker, who for many years has carried out the duties on behalf of the Royal Agricultural Society. The new arrangement will not only ensure the continuance of the valuable work already done, but will also lead to a closer contact with the work of Rothamsted.

At our request, Prof. C. Runge, of Göttingen, has been good enough to send us the following list of leading men of science in Germany who have died

since the beginning of the late war. The list is not, however, complete, and may be supplemented later. Short obituary notices of some of the men will be found in the *Geschäftliche Mitteilungen der Göttinger Gesellschaft der Wissenschaften*, 1918-19-20 (Weidmannsche Buchhandlung, Berlin S.W.68, Zimmerstr. 94):—W. Lexis, mathematician and statistician, August, 1914; W. Hittorf, physicist, November, 1914; A. von Auwers, astronomer, January, 1915; A. von Könen, geologist, May, 1915; E. Riecke, physicist, June, 1915; P. Ehrlich, physician, August, 1915; H. Solms-Laubach, botanist, November, 1915; R. Dedekind, mathematician, February, 1916; E. Mach, philosopher and physicist, February, 1916; K. Schwarzschild, astronomer, May, 1916; R. Helmer, mathematician and physicist, June, 1917; A. von Baeyer, chemist, August, 1917; G. Frobenius, mathematician, August, 1917; A. von Froriep, anatomist, October, 1917; H. Vöchting, botanist, November, 1917; C. Rabl, anatomist, December, 1917; G. Cantor, mathematician, January, 1918; L. Edinger, physician, January, 1918; E. Hering, physiologist, January, 1918; F. Merkel, anatomist, May, 1919; S. Schwendener, botanist, June, 1919; E. Fischer, chemist, July, 1919; H. Bruns, astronomer, 1919; Th. Reye, mathematician, July, 1919; W. Voigt, physicist, December, 1919; P. Stäckel, mathematician, December, 1919; W. Pfeffer, botanist, January, 1920; O. Bütschli, zoologist, February, 1920; and W. Förster, astronomer, 1920. J. Elster, physicist, and Joh. Thomae, mathematician, have died recently. In addition to the above, several other German men of science were referred to in the obituary notice of Prof. von Waldeyer in *NATURE* of May 19, and news has also reached us of the following deaths not previously recorded in these columns:—Prof. G. A. Schwalbe, Strassburg, on April 23, 1916, age seventy-one years; and Prof. Karl von Bardeleben, editor of the *Anatomischer Anzeiger*, on December 19, 1918, age sixty-nine years.

THE tendency towards a more popular form of official publications has been evident in recent annual reports of H.M. Chief Inspector of Factories. The report for 1920 is divided into twelve chapters dealing with such matters as safety, dangerous trades, welfare, lighting, etc., prefaced by an introductory general section. The work of the Departmental Committee on Lighting in Factories and Workshops has now been resumed, and the Committee is assisting in the preparation of a pamphlet summarising the chief essentials of industrial illumination. We observe that the scope of the Committee has been somewhat restricted by the prevalent demand for economy. We could wish that the demand was applied with less severity to research of this description, in a field where much remains to be learned and results of experiment may have great economic value. It is, however, gratifying to observe that the recognition of the value of good lighting is increasing. One of the strangest facts mentioned in this report is the habitual disregard, by some firms, of natural illumination. Window-space is not infrequently cramped; existing panes are found to be

broken and covered with sacking, or obscured by paint, oil, or dirt. Seeing that daylight costs nothing, and, according to recent experiments in silk factories, leads to 10 per cent. better production than average artificial lighting, this is evidently a direction in which a demand for economy might be justly pressed and expenditure on publicity well repaid. Another point commented upon in the report is the need for protection of the eyes against the "flash" of arc-welding. Apparently exposure of a few seconds may have ill effects, though fortunately cases of permanent injury seem to be rare. The cataract prevalent among glass workers is now believed to be due, not to ultra-violet rays, but to the continual exposure to intense heat. Suitable Crookes glasses would afford protection, but it is difficult to induce workers to make use of them. Here, as elsewhere, educational work, such as that conducted by the British Industrial "Safety First" Association, is clearly needed.

WE regret to see the announcement of the death, at seventy-nine years of age, of Prof. G. T. Ladd, Clark professor of metaphysics and moral philosophy in Yale University, founder of the American Psychological Association, and author of many important works on philosophy and psychology.

DR. JAMES MARCHANT, director of the National Council for the Promotion of Race-Regeneration, has been appointed a Knight Commander of the Order of the British Empire.

THE council of the Society of Chemical Industry has decided to institute a Messel memorial lecture in memory of Dr. Rudolph Messel. A gold medal with an honorarium will be presented to the lecturer, and for the present the remainder of the income from the bequest to the society will be allowed to accumulate.

WE learn from the *British Medical Journal* of August 6 that the French Academy of Medicine has elected the following foreign correspondants:—Sir Robert Philip (Edinburgh), Sir Humphry Rolleston and Sir D'Arcy Power (London), Dr. Brachet (Brussels), Prof. Christiansen (Copenhagen), Prof. L. J. Henderson (Harvard University), Dr. Lucatello (Padua), Dr. Dominguez de Oliveira (Oporto), Dr. de Quervain (Berne), and Dr. Soubbotitch (Belgrade).

DR. J. CHARCOT, the French polar explorer, sailing in the North Atlantic in his exploring vessel, the *Pourquoi Pas*, has succeeded in landing upon the islet of Rockall, which lies some 260 miles west of the Hebrides and 185 miles from St. Kilda. Rockall is a pinnacle about 75 ft. high rising from a shallow bank which has more than once proved disastrous to shipping. It has seldom been visited, and the *Times* records only five authentic instances of landing previous to Dr. Charcot. The interest of Dr. Charcot's feat lies in the geological specimens which he is reported to have obtained from the rock.

It is announced by the *Times* that Mr. Edwin Naulty, an American aviator, intends to attempt an aeroplane flight across the North Pole next month. He proposes to start from Point Barrow, in Alaska,

and hopes to reach the north-western corner of Spitsbergen. The aeroplane will carry four men and fuel for a fifty hours' flight. If conditions permit, several landings will be made on the polar ice, but if this proves impossible the 1800-mile flight will be made without descent. From Spitsbergen Mr. Naulty proposes to continue his flight *via* Norway to London. Provided clear weather is experienced, it will be possible to make valuable observations on the distribution of ice and air-currents. The flight may throw some light on the doubtful existence of land in the eastern part of the Beaufort Sea.

A TRADING expedition to Siberia *via* the Kara Sea is on the point of leaving Europe. Two cargo-boats from Liverpool, two from Hamburg, and one from Göteborg are to meet at the Russian port of Murmansk, where they will be joined by the ice-breaker *Alexandria* from Leith. The expedition is carrying about 11,000 tons of cargo, most of which is destined to enter Siberia *via* the Yenisei River. This route to Siberia has been used from a very early date, but for a long time fell into disrepute owing to the difficulties presented by ice in the Kara Sea. These difficulties, however, have been exaggerated, and for some years past one or more vessels have made the passage every summer in August or September. The expedition is being organised by the All-Russian Co-operative Society, Ltd., London.

A PROGRAMME has been issued of the autumn meeting of the Institute of Metals to be held at Birmingham under the presidency of Eng. Vice-Admiral Sir George Goodwin on September 21-23. There will be a general meeting on the morning of September 21 in the hall of the Municipal Technical School, at which the Lord Mayor of Birmingham will deliver an address of welcome. The remainder of the morning and the whole of the morning session of September 22 will be devoted to papers dealing with the constitution and properties of various metals and alloys, and, so far as time permits, each paper will be followed by a brief discussion. In addition to the formal meetings, there will be excursions to various works in or near Birmingham, and on the afternoon of Wednesday, September 21, a visit will be paid to the University of Birmingham. The guests will be received by the Vice-Chancellor, Sir Gilbert Barling, Bart., and an address delivered by the Principal, Mr. C. Grant Robertson. Full details of hotel accommodation, railway arrangements, etc., are given in the programme, which can be obtained from the Secretary, the Institute of Metals, 36 Victoria Street, S.W.1.

AFTER seven years' cessation (the result of the war) the excavations at the Meare Lake Village, near Glastonbury (Shapwick and Meare are the nearest railway stations), will be resumed by the Somersetshire Archæological and Natural History Society on August 29, and continued for three weeks (exclusive of the filling-in). The work will be under the direction of Dr. Arthur Bulleid and Mr. H. St. George Gray, who have worked in double-harness at the lake villages for a number of years. The antiquities dis-

covered in past years at Meare are exhibited in the Somerset County Museum at the society's headquarters, Taunton Castle, while those from the Glastonbury Lake Village (described in two royal quarto volumes) are to be seen, for the most part, in the museum at Glastonbury. There is a good deal of expense attaching to this work besides the labour of about eight men; the money in hand is quite insufficient for the work contemplated, and donations will gladly be received by Mr. St. George Gray at the Somerset County Museum, Taunton.

JULY was exceptionally warm and dry in many parts of England. The Greenwich Observatory records, using the civil-day values published in the Registrar-General's weekly returns, give 68.5° F. as the mean temperature for the month; the mean maximum was 81.5° and the mean minimum 55.5°. In the last eighty years, since 1841, July has been warmer only in two years, 1859 with the mean 69.5° and 1868 with the mean 68.9°, and in both 1852 and 1911 the mean temperature exceeded 68°. In July this year there were four days with the shade temperature 90° or above; the highest temperature was 94° on July 11. In 1868 there were six days in July with the shade temperature 90° or above, and July, 1881 and 1900, each had four days with 90° or above. The highest temperature on record in July at Greenwich is 97.1° in 1881. There were four days in July this year with the temperature in the sun's rays 150° or above. The total rainfall at Greenwich for the month which has just closed was 0.15 in., which is the smallest July measurement for nearly a hundred years; the only July with a smaller total was in 1825, when the amount was 0.10 in. The only other years with the July rainfall less than $\frac{1}{2}$ in. are 1835, 1864, 1878, 1906, and 1911. The rainfall has been less than the normal in each of the last twelve months from August, 1920, to July, 1921, with the exception of September, 1920. In the twelve months the total rainfall at Greenwich is 14.98 in., which is 9.43 in. less than the average for the last hundred years, and only 61 per cent. of the normal. The *Times* for August 5 gives a communication from its weather correspondent, "Driest Twelve Months." It mentions that in the east and south-east of England many places besides London had less than 0.25 in. of rain in July, whilst the measurements in some of the western districts were well above the normal. The smallest rainfall for the twelve months is 11 in. at Howden, Yorkshire, and this is stated as quite without precedent in the United Kingdom, so far as can be seen at present. At Yarmouth the rainfall for the twelve months was 12.8 in.; at Benson, Oxon, 13.1 in.; Cranwell, Lincs, 13.7 in.; Kew, 15.0 in.; and Croydon, 15.3 in. The lowest previous fall for the corresponding period at Kew since 1866 is 16.75 in. in 1890-91.

In the August issue of *Man* Major R. Burnett describes a remarkable tribe in the neighbourhood of Mosul, popularly known as "Slaveys," which possibly represents the Bedouin Solibala, of which the Russian writer Ponafidina gives an account in his "Life in the Moslem East." The "Slaveys" are a desert tribe

supposed to be the direct descendants of the Crusaders. Their dress consists of gazelle skins, and they have a cross marked on their backs. "They have no religion and no marriage laws: very poor and peaceable. It is considered unlucky to kill one of them, and they help the wounded." The Mohammedan Arabs despise them and call them "wild dogs." They are known for the shortness of their stature and the great length of their spears. They are the carpenters, blacksmiths, and doctors for man and beast among the Bedouin, and live in tents made, not of hair, but of skins. They may possibly be connected with the Negrito race which Sir Percy Sykes describes in the recently published second edition of his valuable "History of Persia."

IN the *Museum Journal* for March last we find an account of an interesting series of marble vases from Ulua Valley, Honduras, which are of such an unusual type that they have given rise to much speculation. The Ulua culture, like other ancient American cultures, is without date, but it was certainly contemporary with the ancient Maya Empire, as well as with other cultured races that flourished in Mexico, Panama, and Costa Rica. The technique and ornamentation of these vases are certainly remarkable. Attempts made by Mrs. Zelia Nuttall to interpret the symbolism are sharply criticised by the writer of this paper, who remarks:—"It would be as useless to speculate concerning the symbolism of all this ornament as it would be to guess at the service for which the vessel was designed. We are at liberty to assume that so elaborate and refined an object had a ceremonial function, and that its symbolism corresponds to ideas associated with its use, but its interpretation is quite beyond our reach."

THE issue of the *Journal of the Royal Society of Arts* for July 15 is devoted to a lucid paper on the development of Bombay by Sir G. Curtis. The position of the city, including originally seven islands, had long exposed portions of the site to inundation, and the enormous commercial development necessitated extension. These difficulties are being met in various ways, the principal being the reclamation of the area known as Back Bay. The chairman, Sir W. Sheppard, commented on the magnitude of the proposed series of undertakings:—"With regard to cost, there were few works in India—indeed, none of the precise kind described—which had cost, or been expected to cost, so immense a sum as thirty millions. Even in Europe so large a scheme would be considered wonderful, and he believed the renovation of Paris cost only about half the proposed expenditure on Bombay." But this has not deterred the Governor, Sir G. Lloyd, from pressing on the work, and the people of Bombay evidently believe in the project, as they showed by raising a local loan of nearly ten millions.

DR. D. F. CURJEL has obtained records of the weights at birth of 1849 normal Indian infants; the average is 6.5 lb. This compares not unfavourably with that of European infants. The conclusion is that the high infantile mortality which prevails among Indian children is largely due to unfavourable post-natal conditions. The same author has also inquired

into the duration of reproductive life of Indian women. The average age of the onset of puberty was 13.63 years, and the average duration of reproductive life 32.14 years, both of which do not differ materially from the limits for European races (*Indian Journ. of Med. Research*, vol. viii., No. 2, pp. 363 and 366).

EXPERIMENTS have been conducted by Major J. C. G. Kunhardt and Asst.-Surg. G. D. Chitre on the eradication of plague infection by rat destruction. The observations made strongly support the view that the reduction in the rat population, resulting from plague itself (which attacks rats), is the main factor in bringing infection to a natural end, and that it yet remains to be seen if the destruction of rats by any artificial means is capable of producing or accelerating the same result. A number of rat poisons was tested, but none was found better than barium carbonate, of which three grains is a fatal dose for the rat. It is best made into a bait with dough of some grain-flour (the best grain was found to be bajri, *Pennisetum typhoideum*), and without any addition in the form of fat, sugar, condiments, etc. (*Indian Journ. Med. Research*, vol. viii., No. 3, 1921, pp. 409, 446).

IN the July issue of *The Fight against Disease*, the organ of the Research Defence Society, excerpts are given from an address by Sir John Rose Bradford at Oxford on "The Place of Experiment in the Science and Art of Medicine." Dr. Drury communicates notes on an "experiment," made by Nature herself eighteen years ago, on the protection against smallpox afforded by vaccination. In a school at Ossett there were 169 children, of whom 92 were vaccinated and 77 unvaccinated. Smallpox was introduced by a scholar, and no fewer than 37 of the 77 unvaccinated contracted the disease. Only 5 of the 92 vaccinated contracted it, all of whom had been vaccinated ten or more years previously. None of the 14 scholars who had been re-vaccinated took the disease. In the class into which the disease was first introduced (Standard IV.) all the vaccinated escaped and every one of the unvaccinated promptly took the disease.

DR. PERKINS gives in the *Journal of the Torquay Natural History Society* (vol. iii., No. 1) an account of his investigations on the food of trout caught in the Torquay reservoirs in August and September. He found that the nature of the food in the reservoir fish was very different from that of river fish. The latter appeared to be feeding on aquatic insects only, to contain much less food, and to be in an inferior condition generally. In the reservoir fish the food seemed to be composed mainly of such land insects as happen to fall accidentally on to the surface of the water under the stress of weather conditions. Dr. Perkins is of the opinion that this difference in the nature of the food is due to the fact that in the reservoirs the aquatic insects are limited in species, and the rarity or absence of some forms specially favoured by trout is the result of the extermination of the insect by the fish. The reservoir trout have thus to fall back on a source of food denied to the river fish. In a single trout's stomach Dr. Perkins found no fewer than forty-six species of land insects, the

majority of which were beetles. No insect seems to come amiss to the trout as an article of food, and so important is this source of food-supply that the active rising of the fish is dependent on the activities of the land insects at the time.

IN the Journal of the Torquay Natural History Society (vol. iii., No. 1) Mr. Harford J. Lowe gives an interesting account, compiled from original notes and manuscripts, of the excavation work accomplished by the Rev. J. MacEnergy at Kent's Cavern in Devonshire in the early years of last century. MacEnergy was the pioneer worker at this famous cave, and by his energies and enthusiasm dug up huge collections of the remains of extinct British mammals and of the work of early man in Britain. Unfortunately, the results of his work seem to have been overshadowed by the publications of his more illustrious contemporary Buckland, with whom he was in constant communication, and, although published after his death by Vivian in 1859 and Pengelly in 1869, the work accomplished by MacEnergy never seems to have received due recognition and reward. It is interesting to learn from Mr. Lowe's paper that, in spite of the prejudices and antagonistic opinions prevailing at the time, MacEnergy had more than a suspicion of the important bearing of his work on the antiquity of man in Britain. MacEnergy's collection was, unfortunately, dispersed by auction at his death, and students of this subject will be grateful to Mr. Lowe for the information which he gives as to the ultimate destination of part of it at any rate. Some of it found its way to the Jardin des Plantes, Paris, the British Museum, the Athenæum Museum, Penzance, the Plymouth Institution, and possibly to Bristol, while some at least remained at Torquay.

WE have received the first number of a new serial publication, the *Australian Museum Magazine*, issued by the Australian Museum under the editorship of the director, Dr. C. Anderson. The object of the magazine is to put the museum into more intimate relationship with its owners, the public of Australia, by keeping them in touch with the work that it is doing, by making its collections better known, by giving accurate and up-to-date information in simple language on the natural history and geology of the Commonwealth, and, in general, by showing how the museum can be of service to the nation and, conversely, in what ways the public can help the museum. Thus in this first number are to be found articles on the scope, work, and management of the Australian Museum and on museum groups, in which some insight is given into the technical work that has to be done in the preparation and exhibition of specimens, in addition to interesting accounts of Blackfellows' pictures, white ants and other Australian insects, snakes, crawling jelly-fish, and the lure of the big nugget. This experiment of rendering an account of its stewardship by the Australian Museum is one that might well be tried by other national museums. The museum is making a praiseworthy effort to stimulate a healthy pride among the people of Australia in their national institution and to secure that measure of interest and sympathy so essential if it is to

develop its activities to the fullest extent. We hope the public will respond by leaving nothing undone that will place the Australian Museum among the first of its kind.

THE publications of the Naturhistorischer Verein der preussischen Rheinlande und Westfalens for the years 1913-19 have now reached us, and show the remarkable activity of the society even during years of war. The volume of the *Verhandlungen* for 1916 was completed in 1918, and the paper used and the mode of illustration show little falling-away from the high standard of 1914. As has happened in so many countries, deterioration sets in under the conditions following the war; but even now the plates do not suffer. The work of the society is largely geological, but chemists and biologists are concerned with August Thienemann's detailed "Physikalische und chemische Untersuchungen in den Maaren der Eifel" (1913-14). The marked differences in the plankton of the various crater-lakes depend on the distribution of oxygen in the waters. The mineral springs entering from the volcanic rocks show marked differences of composition in different lakes. The author of these researches adds in 1915 a study of the midge larvæ inhabiting the Maare, and in 1917 he describes the vertical zoning of the plankton in the Ulmener Maar. In 1916 F. Goebel gives a morphological description of the well-known district of the Ruhr, on the east bank of the Rhine. F. Winterfeld, of Cologne, publishes (1918) an illustrated paper on "Der aufrechte Gang des Menschen," in which he finds no room for pessimism. He concludes that "der Mensch der Zukunft wird im geistigen Sinne des Wortes aufrecht gehen, sich aufrecht halten, gehoben durch seine Ideale." We cannot help remembering the melancholy fact that hitherto physically upright man has been preserved mainly by the compulsion of military service. Enough has been said to show the range of research embodied in these undeterred publications of the war-time.

UNDER the editorship of M. Maurice Solovine, Messrs. Gauthier-Villars et Cie are issuing a collection of "Maîtres de la Pensée scientifique" in order to keep alive the memory of the advances made in the past by the great masters in every branch of science, whether these masters are French or of other nationalities. The volumes are $6\frac{3}{4}$ by $4\frac{1}{2}$ in., contain about 100 pages, and are issued at about 3 francs each. Huygens's "Lumière," Clairaut's "Géométrie," Carnot's "Réflexions," and d'Alembert's "Dynamique" are amongst the works issued, some of which extend over two volumes of the series. D'Alembert's work is reproduced from the second considerably enlarged edition which appeared in 1758, fifteen years after the first. It furnishes a good example of the clear and logical methods of development of a subject which were adopted by French scientific writers of a century and a half ago.

IN the July issue of *Science Progress* Prof. W. L. Bragg gives a summary of our knowledge of the dimensions of atoms and molecules. He points out

that the kinetic theory of gases allows us, from measurements of the viscosity or the heat conductivity of a gas, to calculate the mean distance of the centres of two molecules of the gas apart when the molecules are in contact, that the constant b of Van der Waals furnishes another estimate of the distance, and that the two estimates agree in giving about 2×10^{-8} cm. for the mean radius of hydrogen and helium molecules and about 3×10^{-8} cm. for the mean radius of the molecules of argon, nitrogen, oxygen, carbon dioxide, and other gases. With these figures as a basis, X-ray crystal analysis then gives the relative positions of the atoms in the molecule of the material analysed. So far the most careful analysis of crystals of potassium chloride has, however, failed to reveal any structure corresponding to the KCl molecule. Each K atom is surrounded by six Cl atoms at equal distances from it. For chlorides the distances vary with the metal in the molecule, are large, -3 to 5×10^{-8} cm., for the first elements of a "period," and decrease to a limit 1.3 to 2.7×10^{-8} for the last elements.

MANY methods of harmonic analysis have been given of recent years. We need mention only the methods of Perry, Silvanus Thompson, and Russell. The question has now come prominently forward in connection with the disturbances induced in telephone and radio stations by the harmonics in the currents

carried by overhead power lines. The power station engineer wants the manufacturer to guarantee that the electric generator he purchases from him shall give a pure sine-shaped wave of electromotive force. As it is impossible to make the machine give an absolutely pure sine wave, limits have to be fixed on the magnitudes of the amplitudes of the harmonics in the wave. Hence harmonic analysis is a necessity. In the Journal of the Institution of Electrical Engineers (vol. lix., p. 491) Mr. A. E. Clayton gives a *réssumé* of the ordinary methods and two schedules for "harmonic analysis" by means of selected ordinates. One goes to the 25th harmonic and the other to the 13th. In the one case the assumption is made that no harmonic higher than the 25th is present, and in the other that there is none higher than the 13th. Seeing that in actual electromotive-force waves there is an infinite number of harmonics present, and as only a limited number of ordinates are drawn, we should have little confidence in results obtained by a "schedule."

THE Cambridge University Press will publish shortly "The Calendar," by A. Philip, the purpose of which is to provide a concise and popular summary of the history and construction of the Gregorian calendar, with special reference to the reform of the calendar and the fixing of the Easter date.

Our Astronomical Column.

BRIGHT OBJECT NEAR THE SUN.—Prof. Campbell, Director of the Lick Observatory, reports by telegraph an object brighter than Venus that was seen on August 7 3° east of the sun and 1° south. The message states that there is no doubt of the object being a celestial object. It is either a comet or a nova. The former appears more probable, owing to the distance from the Galaxy, where most novæ appear.

VARIABLE STARS.—The Bruce 24-in. photographic telescope at Arequipa has been used for taking spectrograms of the Large Magellanic Cloud, in which Miss Leavitt some years ago detected several variable stars (Harv. Ann., vol. lx., No. iv.). Miss Cannon, in Harv. Bull. No. 754, gives the spectral type and magnitude range of eight of them as follows:—No. 884, Mc, 11.4m. to 15.5m.; No. 900, M, 12.2m. to 13.6m.; No. 2257, K5, 12.4m. to 13.2m.; No. 2435, K5, 10.8m. to 11.7m.; No. 2447, K5, 12.0m. to 12.8m.; No. 2622, K5, 13.2m. to 14.0m.; No. 2822, Mc, 9.8m. to 10.6m.; and No. 2882, Mb, 11.0m. to 13.6m. The numbers are from Harv. Ann., vol. lx. It is satisfactory to find that such faint stars are within the reach of spectroscopic analysis.

Mr. Stanley Williams contributed a paper to Monthly Notices, R.A.S., vol. lxxxi., p. 332, on the star B.D.+44-994 $^\circ$, which he announced as a peculiar variable, possibly of the Cepheid type. Miss Cannon gives its spectral type as Ma; and Miss Leavitt has identified 150 images of the star on plates taken during the last twenty years. Its normal photographic magnitude is 10.5m., but on seven dates it was 10.2m.; it is very red (Harv. Bull., No. 754).

C. Hoffmeister, director of Sonneberg Observatory, noted on May 30 last, while observing Reid's comet, an 8th magnitude star that is not in the B.D. Its position for 1855.0 is 7h. 57m., N. $58^\circ 14'$, and it is shown on the Harvard plates. Prof. Küstner has

examined the original observations of the B.D., and finds that a star of 9.5m. was observed in the place on February 10, 1858, but not seen again, so it is probably variable (*Astr. Nach.*, Circ. 22). In the same circular H. Fuss announces that B.D.+42-3351 $^\circ$, 7.5m., has the large proper motion of +0.065s., +0.16".

MR. FLINT'S PARALLAX OBSERVATIONS.—Publications of Washburn Observatory, vol. xiii., part 1, contains the details of the series of meridian observations for stellar parallax made at Washburn between 1898 and 1905 with the Repsold meridian circle of 12.2 cm. aperture, fitted with a travelling-wire micrometer.

The programme extended from declination -35° to $+90^\circ$, and embraced stars from magnitude 1.5 to 2.5, with some binaries and stars of sensible proper motion. A screen with thin metal slats rotating about their axes like the laths of a Venetian blind was used to equalise magnitudes, 7.0m. being made the standard. Two comparison stars, one preceding, the other following, the parallax star, were used in each case.

The mean probable errors of a single observation of unit-weight and of the final parallax of each star are 0.214" and 0.031" respectively. The last quantity is of about three times the size of the probable error in the best recent photographic determinations, showing that the meridian method cannot compete seriously with the photographic. Still, the experiment was well worth making, and the research will occupy a place in the history of the subject, so that it is well to have the details published. The list of parallaxes contains 124 stars, of which the deduced relative parallax is negative in thirty-five cases. The values for Algol and Castor, 0.122" and 0.167", are about three times the accepted values, while that of Altair, 0.071", is only about one-third of it; but in many cases there is better agreement.

The Universities and Research.¹

By PROF. J. JOLY, F.R.S.

THE argument for research in universities rests upon the broad basis of the value of the intellectual progress of mankind. I think I am correct in saying that most men who have adopted a life of research, or have made research the object of their special interest, have acquired their intellectual ideals in the days of their college life. It is through the university that the young man comes into contact with the investigators of his time, and it is their example and teaching which affect his future life. If his teachers are without interest in research the student learns indeed the text-book, but the enthusiasm to create new knowledge is not implanted in him. Whatever his intellectual capacities may be, he passes from his university but an ordinary member of the educated public. What he might have accomplished, and could have accomplished, had he found himself in a creative atmosphere during his student days remain entirely unknown.

I do not think that any other argument for the cultivation and promotion of research in universities need be stated. If the investigation of Nature is good in itself; if its effects are beneficial to our race; if it is desirable that we should advance in knowledge from generation to generation, then we should see to it that our brilliant young men get the chance of taking up this career in the service of mankind. There is, as I say, no answer to this argument unless we assail its basis and determine that obscurantism is the better thing and enlightenment the worse.

Great universities have done great good. They have also done great harm. Their inertia, their opposition to development, to following the evolutionary changes of their times, constitute their principal offence. Even to-day I hear in my own university surviving voices expressive of distrust in science as an educational subject; doubts as to the propriety of including science as a primary subject in the university curriculum; regrets that the so-called "great" or "fundamental" subjects of education—i.e. classics and mathematics—should no longer form the only road to fellowship.

Such views on science are the natural outcome of an upbringing in the traditions of the older educational methods. To attain the forefront of classical criticism or of mathematical advance is a more difficult task than to reach the exploratory front of a branch of modern science. And not only is it more difficult to arrive at the forefront; it is also more difficult, when the forefront is attained, to find work of any probable benefit to mankind. Only the most brilliant scholars and the most original minds can prevail. Compare these conditions with those attending research in any of the newer domains of modern science. No sooner has the student mastered the principles of his subject than he finds himself approaching an unknown territory. Everywhere he sees the words "Not known" written up, and any one of these innumerable avenues to knowledge is for him to tread if he so pleases and is equal to the task.

The contrast is remarkable. The older scholar, who has spent his days turning over the thoughts of others and the time-worn records of past efforts, gradually arrives at the fatal conclusion reached by the wisest of men: "There is nothing new under the sun." He has passed a lifetime of solid work and seen but little come of it. Must not the younger workers be branded by superficiality?

As regards the subject of expense, there is no

doubt that, contrasted with blackboard and chalk, modern scientific apparatus and scientific laboratories are expensive. It is discouraging to compare British outlay with American outlay upon research in universities. We are supposed to have learned a lesson by the war. Let us hope it will bear fruit when business revives in this country. Meanwhile this lesson has placed a heavy demand upon the universities. For every branch of technology is crying out for research workers, and the universities cannot supply them: The fact must be faced that the day of research has come in all the scientific professions and in every domain where technology or business comes into contact with the natural laws governing production and economy.

The reactionary sitting in senate, council, or board, who would close the university to these demands, may indeed effect economies, but his economies are at the expense of the vitality of his university, of its very existence as part of the living, breathing life around it. It is a cheap road, but it leads to stagnation, decay, and death.

Perhaps the most striking feature of American universities, as viewed by the British visitor, is the prevalence of research and the lavish provisions made for its prosecution. It extends into every branch of university work. Special stress is, however, generally laid upon certain subjects. What these subjects are seems to depend upon the initiative and forcefulness of particular teachers of eminence, either past or present, who have been associated with the university. The great Research School of Education in Chicago, of which Prof. Dewey seems to have been the chief originator, may be cited. Highly organised and carefully staffed elementary and high schools are here attached to the university for research in pedagogy. The Nutrition Laboratory of the University of Illinois, founded by Prof. Grindley, is another instance. The State universities are very often in close touch with agricultural research, and not only benefit agriculture thereby, but also extend the influence of the university over the State by the valuable assistance given to the agriculturist. In our own country there is no class of the community more in need of such university influence than the agricultural. It is—in Ireland—not only ignorant of science, but also strongly anti-scientific. This applies almost as much to the so-called educated classes as to the small farmer.

For research in experimental science and chemistry and natural science extensively equipped departments are provided in all the great American universities and technological institutes. The equipment is on the most lavish scale. Everything possible seems to be done for the student.

There is one subject which I must refer to: the compulsory presentation of Latin or of Latin and Greek by students entering the older universities. I know we are a long way from reform in this matter, but its influence upon the present subject is sufficiently important to necessitate a reference to it.

As regards research in the physical and natural sciences, there is no doubt that the compulsory study of dead languages is injurious—indeed, seriously injurious. This is so for two reasons. It serves to keep out many from the universities, and it demands of the science student hours of toil which would be better spent on living tongues, which would help him later on to extend his scientific reading. I am every day in contact with brilliant young men whose minds are absorbed in the interests of physical or natural science, but who cannot read a German book, and

¹ From a paper read before the Congress of the Universities of the Empire at Oxford on July 8.

read a French one only with difficulty. These young men have spent many school years during which the study of Latin and Greek absorbed about one-third or one-fourth their total available study hours. What have they got for it? They cannot read a Latin author or a Greek author at sight. It is true that without their Latin they would not have attained the degree of the University of Dublin. The pro-classic says their minds are the better for it. Well, I freely admit that much mental training was involved, but I do not admit that a sound study of French and German would not have done for them just as much—nay, more.

The reproach that many students fail as research workers, while it has some foundation in fact, is not a fair one, for it ignores the educational value of even elementary research. I believe the outlook of a student who has carried out one single research of an elementary kind is different from that of one whose outlook is derived solely from the text-book and the examination. He learns first-hand the mental point of view of the investigator. He gets ideas of scientific truth and of the legion of errors which lie in wait around it as may in no other way be acquired. He sees the plausible, *prima facie* conclusion break down under the control experiment or in the light of the inexorable requirements of other participating laws of Nature. A new conception of the use of mathematical analysis and of careful observation is created in his mind. More generally he learns the necessity of "thinking round" his subject.

These things he learns in some degree even if he is only of average capabilities. If he is one of the higher spirits the interest of the work seizes on him and calls out every power, latent and developing, wherewith he is endowed. These higher spirits work out their own destiny. I shall not dwell on the ways of genius, but rather upon research as an instrument in the education of less gifted minds. I turn, therefore, to the interesting question: "Is it possible to teach research successfully?" To teach its methods and its spirit to the average student, whether of science or of the "humanities"?

The answer I would give unhesitatingly is "Yes." I would be careful to define that this does not imply the genesis of an original thinker from ordinary material. But it implies just as much as when we say we can teach students mathematics.

I plead, therefore, for lectures in our universities devoted exclusively to studies in research, and I would admit to these lectures students of both junior and senior standing, *i.e.* the beginners in science as well as those working for the Ph.D. as now instituted in all British universities.

Of course, I am not now referring to systematic lectures in this or that branch of science. These are essential to the training of the average student. I

mean something different. I would define research lectures as mainly relating to the professor's own experience and to that of his assistants and co-workers, each worker contributing one or more lectures to the university course in research. Their subject-matter would relate to the objects aimed at by the research, the difficulties attending the work, and how they were surmounted. Such discourses might be supplemented by others of an historical or retrospective character. These might in some cases be delivered by honours students, and would refer to classic researches of the great masters. For recounting these, experimental illustrations should be given. The inspiration to be derived from such retrospective studies will be known to all who have read the original memoirs of great investigators. There need be no extra call upon the professor's time. He would simply substitute these for part of his existing routine lecture work.

The professor is at present too much tied down by routine courses. There is a sort of idea prevalent that it is not fair to his class that he should tell them of his own work, but that this should rather be kept for the academy and for the outside world. Well, I think it *is* fair; and I believe that with reasonable usage the best thing he can do for his class is to tell them of his own work. If this were admitted in high quarters it would be more often carried out. I can imagine nothing more stimulating than a few lectures each term on the work progressing in the laboratory of the professor and his co-workers, for not only is the student brought into touch with the making of knowledge, he is also sure to receive the story in the language of fresh and enthusiastic interest.

I am aware that occasionally and at scientific associations within the university such discourses are delivered. I would make them a part of the sessional work of the university. If not legally obligatory on the professor, it should be morally obligatory on him to contribute a few such lectures every term, or at least every session. I do not think it would impose additional labours on him. Fresh from his work, but little rearrangement would be required, and his facts would be ready marshalled in his memory. Nor would the telling of his ideas fail to react upon the lecturer—to his benefit and to the elucidation of his subject.

The one central result aimed at is the presentation of research as something of paramount importance. It should stand for the highest goal of university effort, for, in truth, success in the making of knowledge is the crown of all human endeavour, and as such the student should be taught to regard it. Teach him this one great ethical truth, and whatever else he may accomplish or fail to accomplish in his student days, he will enter on his life's work an enlightened and a valuable citizen, not only of his own country, but also of the world.

International Exploration of the Upper Air.

By C. J. P. CAVE.

A MEETING of the International Commission for the Exploration of the Upper Air was held at Bergen on the invitation of Prof. V. Bjerknes, president of the commission, in the week ending July 30. The commission was appointed by the Meteorological Conference held at Paris in 1919 to continue the work, in connection with the International Meteorological Committee, which was carried on with marked success from 1896 until the beginning of the war, and with which is specially associated the names of the late Teisserenc de Bort, Rotch, and Assmann, under the presidency of Prof. Hergesell.

The following countries were represented at Bergen: Belgium, Denmark, France, Great Britain, Holland and the Dutch East Indies, Italy, Japan, Norway, Spain, Sweden, and Switzerland; and the meetings were also attended by a number of prominent meteorologists from Norway and Sweden. The proceedings opened with a reception by the president and Mrs. Bjerknes at the Meteorological Office of the Geophysical Institute, and with a lecture by J. Bjerknes on recent advances in the study of the Polar front and its relation to a succession of cyclones. It was arranged that the morning sessions should be devoted

to scientific communications presenting new points of view, and the afternoons to administrative details. This arrangement was disturbed in the course of the week in order to provide more time for administrative questions.

The sessions for scientific discussions were opened by a paper by Prof. V. Bjerknes giving theoretical explanations, on the basis of wave motion at the mutual boundary of two discontinuous media, of the series of phenomena which had been set out by his son, representing the result of observations upon the Polar front in cyclones. This was followed by a paper by Sir Napier Shaw on the structure of the atmosphere and its thermodynamics, to suggest a thermodynamic basis for the study of convection in the atmosphere, and the transformations of energy associated therewith. A paper by L. F. Richardson directed attention to the necessity for studying pilot-balloon observations in relation to the continuity of mass, a subject which in spite of its importance has hitherto not received adequate treatment. Prof. van Everdingen gave an account of a method of obtaining regular observations of pressure, temperature, and humidity in the upper air by means of aeroplanes, using a balloon meteorograph with the usual clock-work drum; such observations had been carried out on upwards of 340 occasions in the past year at Soesterberg and other stations in Holland. S. Fujiwhara, of Tokyo, discussed turbulent movements which are to be observed in clouds, and their relation to eddies in water. Dr. W. van Bemmelen, of Java, gave an account of comprehensive results of great importance of observations of wind in the upper atmosphere up to 30 kilometres, obtained at the observatory at Batavia. H. Köhler, of Holdda, discussed the study of the condensation of water vapour in a cold atmosphere into ice crystals and super-cooled water drops, and the effects which may be attributed to very small quantities of chlorides.

L. F. Richardson discussed the application of the geostrophic principle to winds in the stratosphere. Dr. A. de Quervain, of Zurich, brought up proposals for the establishment of a geophysical observatory at the terminus of the Jungfrau railway, at a height of 3600 metres, which received the cordial commendation of the meeting. P. Schereschewsky, of the Corps of Mines, Paris, explained the method of determining the winds in the upper air by means of sound-ranging applied to detonators carried by pilot balloons, a method which is applicable alike in clear and cloudy weather. R. Sekiguti, of the Observatory of Kobe, explained the application in forecasting of isobaric charts for the level of three kilometres. Col. L. Matteuzzi, director of the Meteorological Service of Italy, presented an atlas of the principal cloud forms, and explained a method of applying the periodicity of barometric oscillations to the anticipation of barometric distribution in the future. O. Devik, of Tromsø, described a new method of observing balloons and its application in forecasting. G. I. Taylor gave an account of the result of his investigation of turbulence in the atmosphere and its symmetric propagation in the three dimensions. M. Dongier discussed the observations of temperature and wind at the Eiffel

Tower and the discontinuities which they disclose. J. Bjerknes directed attention to the unique accumulation of observations of the upper air during the war which had been communicated to the president by the countries on both sides, and gave illustrations of the observations on selected occasions in the study of the method of the Polar front. P. Schereschewsky gave an account of some new methods of forecasting, and the proceedings of the meetings for scientific discussion were concluded with a paper by L. F. Richardson on ideal arrangements of stations on the map for the purpose of numerical computations for forecasting.

The business meetings were devoted largely to the development of a scheme for the collection, compilation, and publication of observations in the upper air on an international basis, in continuation, with such modifications as experience has suggested, of the international scheme which was agreed upon at Petrograd in 1904 and supported by subventions from Government organisations of nineteen countries. The outline of a proposal was agreed upon, and the president was requested to report it to the meeting of the International Meteorological Committee to be held in London in September. The commission adopted resolutions in favour of a geophysical observatory on the Jungfrau, and also appointed a sub-committee to deal with the question of the anomalies in the audibility of the sound of explosions, which was also the subject of a communication by Dr. de Quervain.

It was noticeable that the commission devoted the greater part of its attention to the mode of dealing with the observations of the upper air based upon the supposition that there should be twenty-four days in the year on which balloons for sounding the highest layers of the meteorological atmosphere, including the stratosphere, should be sent up in a sufficient number of countries to secure a general representation of the whole. At present the number of observations is extremely limited, and the reorganisation of the observations would need the support of meteorological institutes in many parts of the world. Beyond pointing out the urgent necessity for such observations over the sea, the technique of which had already been worked out by Teisserenc de Bort and the German meteorologists, but which had not become international in any sense, the commission confined itself to a general invitation to the meteorological organisations of the globe for co-operation on the international days.

An account of the proceedings of the meetings would be incomplete without reference to the hospitality of the citizens of Bergen. It will be remembered that the greater part of the inner town was destroyed by a disastrous fire five years ago, and it has not yet been rebuilt; all the hotel accommodation was required for tourists, and the delegates to the meeting were all entertained with cordial hospitality by the foreign Consuls and the citizens of Bergen, and also honoured by an official dinner given by the municipality, at which the Chief Burgomaster presided. The municipality also placed its ancient and picturesque Council House at the disposal of the commission for the meetings.

A Small Brinell Hardness Testing Machine.

HARDNESS, as recent correspondence in *NATURE* (vol. civ., pp. 377, 440, 534, 599, 662, November, 1920-January, 1921) has shown, is a subject of interest to both the engineer and the physicist. Whatever may be the exact physical significance of the term, there can be no doubt that measurements of this property, or

group of properties, are of increasing practical importance. In the Brinell method of measuring hardness, as commonly applied, a steel ball of diameter about 1 cm. is applied to the surface of the test piece under a load of the order of 3000 kg., and the size of the resulting impression is measured. In practice

the use of a ball of this size is limited to specimens not much less than one-tenth of an inch in thickness and half an inch in width. In 1913 the necessity arose for the accurate determination of the hardness of the walls of small-arm cartridge-cases at different positions along the length. The thickness of wall, diminishing in some cases to about one-hundredth of an inch near the shoulder, is quite insufficient for the application of the usual Brinell test. Accordingly, a machine was designed and constructed by Messrs. H. Moore and R. Mather for the Research Department, Woolwich, in which very small balls with correspondingly small loads could be employed. A description of this machine has been given by Mr. Moore in

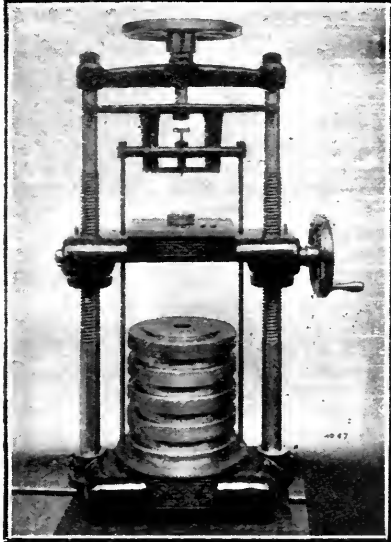

FIG. 1.—A small Brinell hardness testing machine.

the Proceedings of the Institution of Mechanical Engineers of January, 1921. It was designed to permit of great latitude in the dimensions of the test specimen, of the use of various sizes of ball from 1 mm. diameter upwards, and of loads from 5 to 100 kg. The first machine was in continuous use during the war, and was the subject of a secret patent (Craig, Moore, and Mather's patent), which, however, has now been published. The illustration (Fig. 1) shows a simplified form of the machine constructed by Messrs. Alfred Herbert, Ltd., of Coventry.

The machine stands upon a base-plate furnished with levelling screws. This plate supports two vertical threaded columns which carry the table for the

reception of the specimens to be tested. By turning the hand-wheel at the side of the machine the table may be set at the required height. The load seen in the lower part of the photograph is composed of a set of graduated cylindrical weights totalling 50 kg. It is carried by the loading stirrup, to the upper portion of which is attached the ball-holder. The ball is fastened to the ball-holder by india-rubber solution so as to render the changing of balls an easy matter. The most important point in the design of the apparatus is the method by which the load is transferred from the cross-head of the machine to the specimen under test. By turning the hand-wheel at the top a non-rotating screw of fine pitch can be raised or lowered. The lower end of the screw carries a suspension stirrup, which is prevented from rotating by arms bearing against the columns, and from this suspension stirrup is hung the loading stirrup by means of a ball-and-socket joint. When the stirrup is lowered gently, so that the ball rests upon the specimen, the loading stirrup becomes free and disconnected from the suspension stirrup. At this stage the whole of the weight is upon the specimen, there being no parts in friction or rubbing contact. The upper hand-wheel is then turned back to take the load off the specimen, which can now be removed for the purpose of measuring the diameter of the impression by means of a high-power microscope with graduations of $1/200$ mm. on the graticule. The hardness numbers are calculated as in the ordinary Brinell test, the load being divided by the area of the impression, and are directly comparable with the usual Brinell numbers when a load proportional to the square of the ball diameter is employed.

The impressions are so small as to be scarcely perceptible to the eye, and tests may be made on parts of delicate mechanisms without injury to the part tested. Loaded small-arm cartridge-cases may be tested without removal of bullet or charge. The hardness of wire at successive stages of drawing can be measured. Cutlery blades, however thin, may be tested, and the hardness of a cutting tool may be determined close to the cutting edge. Interesting applications of this microscopic Brinell test have been made in the exploration of strain-hardening, for when a metal object has been unequally strained the distribution of strain will usually be indicated by differences in hardness from point to point.

Attention may also be directed to the micro-Brinell apparatus developed by the Ordnance Department of the U.S. Army (Bureau of Standards, Bulletin 16, 1920, p. 557). This has been used with a load of 15 kg. for 30 seconds upon a ball $1/16$ in. in diameter for measuring the hardness of individual crystals or small aggregates in annealed carbon steels.

H. S. A.

The Coal-mining Industry.

By PROF. H. LOUIS.

THE July issue of the *Quarterly Review* contains an article upon the recent coal dispute by Dr. Arthur Shadwell, to which he has given the somewhat unfortunate title "The War of the Mines." Dr. Shadwell points out at the beginning that this dispute was really not a war, and that there was in reality no need at all for a difference, which might have been arranged by mutual concessions, to have degenerated into industrial strife. He recognises that this was not a case of the men striking against any arbitrary action of the employers, but was rather an expression of their irritation at the inevitable development of the economic situation, and he states clearly and definitely the only remedy: "There is only one

way out—the way of work. Other nations in a similar position have taken it; they are at work, and working hard. Here less work is being done than ever before."

It is pointed out quite correctly that the mining industry is distinguishing itself above all others in the readiness with which it resorts to industrial strife, and that the real cause of many of these difficulties, and the basal reason for the present grave position of the coal industry, are to be sought in the Minimum Wage Act of 1911, which is accurately described as "the first instance of a minimum wage established by Parliament in an industry in which the workmen are well organised and able to protect themselves."

Dr. Shadwell is undoubtedly right in saying that the demand for this Act arose on account of the existence of "abnormal places" in coal-mines—that is to say, places in which men cannot make normal wages even though they work up to the normal standard, and that these conditions are due to natural causes which can be neither controlled nor foreseen. He appears to accept the Minimum Wage Act as the only means of meeting the difficulty, but in this view experienced coal-miners are not likely to concur. It should be perfectly possible to devise means other than this Act, which unfortunately encourages slack work, without the grave drawbacks which the Act has brought in its train, but such other methods must be founded on mutual confidence between masters and men.

It must be admitted that this antecedent condition does not exist; masters have in the past been only too ready to look upon hard work or successful work on the part of the men as a fair pretext for cutting piece rates, and this action has sown in the men's minds the seeds of the suspicion that they cannot rely upon the masters for fair treatment in the case of abnormal difficulties. Colliery managers to-day are, no doubt, wiser, and have learnt to appreciate the fact that it is to their advantage, no less than to that of the men, that the latter should be in a position to earn high wages, provided, of course, that they give a commensurate amount of work in return. The old suspicious feeling, however, remains, and it has been responsible for the introduction of legislation which has probably done more harm to the coal industry than any other single step that can be named.

Dr. Shadwell devotes considerable attention to the discussion of the proposal for a national pool, but he evidently fails to see the real object underlying the proposal. He says that "it is impossible to maintain that there is anything impracticable or economically ruinous in pooling or amalgamation," and cites Sir George Elliott's old proposal to amalgamate all the collieries in the kingdom into one concern. He fails to see the difference between voluntary amal-

gamation and compulsory pooling, which latter would necessarily bring in a large number of collieries that are no longer able to produce coal for less than its market price. He suspects, indeed, that the object with which the pool was put forward was political, but does not appear to see the real motive underlying the scheme. As a matter of fact, all the proposals put forward for a considerable time past by the Miners' Federation, the Minimum Wage Act, repeated shortening of the hours, nationalisation, the pool, as well as the less openly avowed tendency to restrict production wherever possible—all these have one and the same underlying object, namely, to keep the largest number of men in the industry.

This object has been only too successful; the coal-miner to-day produces only two-thirds of what he did fifteen years ago, so that for an equal production the number of men employed in the industry is proportionately greater. Obviously, the larger the number of men employed in the industry the greater the political power of the Federation, because it thus obtains control of a larger number of votes and of larger monetary contributions. This gain to the Federation is, however, dearly purchased by the decrease in the efficiency and prosperity of the industry, and obviously such a road can only lead to ultimate ruin and destruction. No industry can prosper if it has in its ranks more men than it can legitimately maintain. The object of nationalisation was to support out of the pockets of the taxpayers the mines incapable of producing economically; the object of the pool was to support them at the expense of the mines that could pay their way. Both schemes were political, in the sense that their object was to keep a number of men in the industry who were working at a loss, and to devise means by which that loss might be made good by someone else. If Dr. Shadwell will consider the effects of the proposed pool upon the mining industry of the country as a whole in the above light, he will readily see why both mine-owners and the Government have offered such strenuous opposition to it.

Botanical Papers from Pennsylvania.

TWO parts of the Journal of the Botanical Laboratory of the University of Pennsylvania recently received (vol. iv., No. 2, and vol. v., No. 1) contain a number of interesting papers. Dr. D. W. Steckebeck has studied the comparative histology and irritability of sensitive plants. The majority of the highly sensitive species are natives of subtropical and tropical America, and their most widespread irritable response is the nyctitropic or "sleep-movement." The author suggests that the phenomenon of propagation of stimuli is centred in the endodermis, the cells of which contain a greater or less number of crystals of oxalate of lime, the number, regularity of shape, and degree of restriction to the endodermis increasing with the increase of sensitivity shown by the plant; the climax is reached in the two highly sensitive plants *Mimosa pudica* and *Biophytum sensitivum*. Each crystal is surrounded by a protoplasmic sac, threads from which pass through adjacent cell-membranes so as to form continuous protoplasmic connections throughout the endodermal tissue; the crystals with their protoplasmic connections are regarded as the special conducting lines for stimuli. The cells of the pulvinus of the leaves are found to contain aggregation bodies, resembling those described by Darwin and others, increasing in amount and complexity with increasing sensitiveness; these show contraction and aggregation changes under stimulation. They are

proteinaceous in nature, and all contractile changes resulting from external stimuli seem to be due to changes primarily in the protoplasmic sac by which each is surrounded, secondly in the aggregation body itself, and finally in the amount of liquid these may absorb or give off.

Dr. J. S. Hepburn and Dr. E. Q. St. John describe the results of their investigation of the active digestive agent in the liquor secreted in the pitchers of the pitcher-plant (*Nepenthes*). Does digestion result from the action of a protease secreted by the pitchers or is it due to bacterial action? The authors found that liquor taken aseptically from unopened pitchers was sterile, but liquor in partly opened pitchers which were free from insects contained bacteria. The slowness with which bacterial digestion of the protein occurred shows that bacteria play a secondary rôle in the digestion of insects; the leading rôle is undoubtedly played by the protease of the pitcher liquor. The enzymes contained in the bodies of the insects may also assist in digestion.

Miss Alice M. Russell gives a comparative study of the macroscopic and microscopic structure of some hybrid *Sarracenia*s and their parent species. *Sarracenia* is the genus of pitcher-plants native to swampy districts in Atlantic North America from Labrador to Florida, and several natural hybrids have been reported. The hybrid forms are found to be inter-

mediate, in comparison with the parents, in almost all details, namely, shape of leaf-pitcher and lid, colouring, size and shape of flower (though the flower of the hybrid is inclined to be larger and more showy than the parent), and size and shape of the petals. The intermediate relation also extends to microscopic details, such as character of cells of the epidermis, number of stomata, and characters of the internal tissues.

Dr. H. W. Youngken has studied the comparative morphology, taxonomy, and distribution of the Myricaceæ (bog-myrtles) of the eastern United States. The author finds that the infesting organism in the characteristic root-tubercles is an Actinomyces, and he has also observed it in the cells of the fruit-wall; after the fall and decay of the fruit it will again make its way into the soil and infect roots of other Myricas. Coccus-like forms, believed to be involution forms of the infesting Actinomyces, were found in the pitted

wood-vessels, and apparently indicate the pathway taken by the parasite in order to reach the fruit-wall.

Miss Margaret Henderson describes the results of a comparative study of the structure and saprophytism of the Pyrolaceæ and Monotropaceæ in relation to the Ericaceæ (heaths). The author suggests that the two former families differ from the Ericaceæ only in their gradually increasing saprophytism and in those characters which go hand-in-hand with this, namely, loss of green colouring matter, reduction from shrubs to herbs, reduction of leaves to scales, increase in the number of seeds, and the reduction in their size and in the number of cells of the endosperm and embryo. Similar degradation changes occur in the orchid and gentian families, and the author therefore supports the view which would regard the Pyrolaceæ and Monotropaceæ, not as distinct families, but as representing subfamilies of the Ericaceæ.

The Claude Process for Ammonia Synthesis.

IN the issue of the *Revue scientifique* for May 28 M. Georges Claude gives an interesting account of his process for the synthesis of ammonia, depending on the use of pressures approaching 1000 atmospheres. The work of compression of a gas at constant temperature varies as the logarithm of the pressure, so that if the work of compression from 1 to 200 atm. is 2.3, that from 1 to 1000 atm. will be only 3, or at most 3.5, if the diminution of compressibility at high pressures is taken into account. At high pressures, however, the percentage of ammonia in equilibrium with hydrogen and nitrogen will be greatly increased. Claude announced in 1917 that his experiments indicated that the yield could be increased from about 13 per cent. at 200 atm. to more than 40 per cent. at 1000 atm., the temperature being the same in both cases. A production of 6 grams of ammonia per gram of catalyst an hour, as compared with 0.5 grams in the Badische process, is attained. Whereas it is necessary at 200 atm., employed by the Badische Co., to circulate the gas several times over the catalyst, and to separate the ammonia after each circulation, it is sufficient to circulate only three or four times at 1000 atm. The volume of the apparatus required for the same production is only about one-tenth that required at 200 atm. pressure. The main source of difficulty in working at high pressures is the evolution of heat, which is 25 to 50 times greater than in working at 200 atm. The difficulty is then, not to conserve the heat of reaction to make the process autothermic, as is the case in the Badische method, but to eliminate this heat. The Claude apparatus has been operated with success at La Grande Paroisse with a unit producing 1.25 metric tons of ammonia per day, and a larger unit, for

5 tons per day, with a compressor dealing with 700 cu. m. of gas per day, has recently been put into operation with success.

The percentage of ammonia after passing the catalyst is about 25 at 1000 atm., as compared with about 6 at 200 atm. The partial pressure is therefore 250 atm., as compared with about 12 atm. at 200 atm. total pressure. The vapour tension of liquid ammonia at atmospheric temperature being from 7 to 8 atm., it will be seen that this is negligible in the gas obtained by the Claude process, but most appreciable with the gas obtained by the Badische process. It is sufficient, in Claude's apparatus, to pass the gas through coils immersed in cooling water in order to separate practically all the ammonia, and the residual gas, after separation of liquefied ammonia, is sent directly, without further compression, to a second catalyst chamber. Three or four catalyst chambers suffice to convert the gas into ammonia. In the Badische process, on the contrary, it is necessary to wash out the ammonia with water under pressure, requiring a complicated apparatus and expenditure of work to bring the gas again to 200 atm. after mixing with fresh gas, and 15 catalyst chambers are required. It is also necessary to use heat to separate the ammonia gas from the solution so obtained, whereas in Claude's process the liquefied ammonia is merely allowed to evaporate, producing cold which can be utilised.

The Claude process, which offers great possibilities in the synthesis of ammonia and in the utilisation of atmospheric nitrogen, is to be installed in England. The patent rights have been acquired by the Cumberland Coal and Chemicals Co., who are to erect a works in the centre of the coke-oven district in Cumberland.

Field-work of the Smithsonian Institution.

THE Smithsonian Institution has just issued its annual Exploration Pamphlet, describing and illustrating its scientific field-work throughout the world during 1920. Twenty-three separate expeditions were in the field carrying on researches in geology, palæontology, zoology, botany, astrophysics, anthropology, archaeology, and ethnology, and the regions visited included the Canadian Rockies, fourteen States of the United States, Haiti, Jamaica, four countries of South America, Africa from the Cape to Cairo, China, Japan, Korea, Manchuria, Mongolia, Australia, and the Hawaiian Islands. The pamphlet serves as a pre-

liminary announcement of the results obtained, though many of the expeditions will be more fully described later in the various series of publications under the direction of the Smithsonian Institution.

Dr. C. D. Walcott, secretary of the Smithsonian Institution, continued his geological work in the Cambrian rocks of the Canadian Rocky Mountains in the region north-east of Banff, Alberta. The work was hindered considerably during July and August by forest fires and by continuous stormy weather in September, but the particular questions involved in the season's research were settled satisfactorily, and some

beautiful photographs of this wild and rugged region are shown in the pamphlet. Other geological field-work was successfully carried on in various States of the United States by members of the staff.

In astrophysical research the institution was unusually active. Through the generosity of Mr. John A. Roebbing, of New Jersey, the Smithsonian solar observing station located on the plain near Calama, Chile, was moved to a mountain peak near by, where the observations will be unaffected by dust and smoke; and a new station was established on the Harqua Hala Mountain, Arizona, probably the most cloudless region in the United States. From daily observations of the radiation of the sun at these two widely separated stations it is hoped to establish definitely the value of "solar constant" observations in forecasting weather. Dr. C. G. Abbot, director of the work, also describes the successful operation on Mount Wilson, California, of a solar cooker devised by him. With this apparatus it was possible, using only the sun's heat, to cook bread, meat, vegetables, and preserves.

Mr. H. C. Raven represented the Smithsonian Institution on an extensive collecting expedition through Africa from south to north. Although many difficulties were encountered, among others a railway wreck in which two members of the expedition were killed, Mr. Raven shipped to the institution much interesting zoological material which was greatly needed for purposes of comparison in working up the famous Roosevelt and Rainey collections already in the National Museum. Many interesting photographs of the animals, the natives, and the country itself are shown in this account and in that of Dr. Shantz, who accompanied the expedition as botanical collector. In Australia a Smithsonian naturalist collected, through the generosity of Dr. W. L. Abbott, specimens of the fast-disappearing remarkable fauna of that continent, while Dr. Abbott himself secured for the National Museum a great number of plants, birds, and other natural history material in various regions of Haiti. A number of other zoological and botanical expeditions are briefly described and illustrated.

In anthropology Dr. Ales Hrdlicka, of the National Museum, conducted extensive investigations in the Far East with the objects of continuing the study of the origin of the American Indian, examining the oldest skeletal remains in Japan, furthering the interests of physical and medical anthropology in China, and studying the rapidly disappearing full-blooded Hawaiians. The work was successful in every respect.

Dr. J. Walter Fewkes continued his archaeological field-work on the Mesa Verde National Park, Colorado. During the field season of 1920 he excavated and repaired a remarkable prehistoric building, which he designates "Fire Temple" on account of the undoubted use of this structure by the Indians in connection with the worship of fire. The ruin is described and illustrated in the pamphlet.

The book concludes with numerous accounts of field-work among the American Indians by members of the staff of the Bureau of American Ethnology, Smithsonian Institution, including researches among the Hopi, the Papago and Pawnee, the Fox and Cree, and others; and archaeological investigations of prehistoric aboriginal structures and dwellings in various regions of the United States.

University and Educational Intelligence.

OXFORD.—Two important elections to professorships have been made since the end of term. The vacant Drummond professorship of political economy has been filled by the appointment of Prof. David Hutchison Macgregor, Stanley Jevons professor of political

economy in the University of Manchester, sometime professor of political economy at Leeds, and fellow of Trinity College, Cambridge. Prof. Macgregor is known as a writer and lecturer on industrial and philosophical questions, and has also done work in connection with the Board of Trade.

The Linacre chair of zoology and comparative anatomy, vacant by the regretted retirement of Prof. G. C. Bourne, has been filled by the appointment of Prof. E. S. Goodrich, fellow of Merton College, and hitherto professor of comparative embryology and Aldrichian demonstrator in comparative anatomy at Oxford. Prof. Goodrich enjoys a high reputation among zoologists, and his artistic attainments are also widely recognised. He is president this year of Section D (Zoology) of the British Association, and the address which he is to deliver at the forthcoming Edinburgh meeting is awaited by zoologists with keen interest.

The University has lately bought a large house in Mansfield Road, part of which will furnish the School of Geography with increased accommodation.

THE Board of Education has at last issued the long-awaited report of the Burnham Committee dealing with scales of salaries for *full-time* teachers in technical schools, schools of art, evening schools, and day continuation schools, in which the local education authority accepts responsibility for the salary scales. The report follows in natural sequence upon the reports of the other two Joint Committees, and is correlated especially with that of the Joint Committee on Secondary Schools. Teachers are graded as (1) principals, headmasters, or headmistresses, (2) heads of departments, (3) graduate assistants, (4) non-graduate assistants, and (5) instructors. For the graduate class the scale determined is 240*l.*, rising to 500*l.* by annual increments of 15*l.*, and for non-graduates 190*l.*, rising to 400*l.* by annual increments of 12*l.* 10*s.* The corresponding figures for women are 225*l.*, rising to 400*l.* by annual increments of 15*l.*, and 177*l.* 10*s.*, rising to 320*l.* by annual increments of 12*l.* 10*s.* For male graduates in the London area the scales are increased by the addition of 50*l.* to both the minimum and the maximum, corresponding additions being made also to the other scales. In order to attract highly trained teachers to the technical service, the local education authority may raise the minimum by 25*l.* and the maximum by 50*l.* in the case of a good honours degree or its technological equivalent. Further, other additions may be made in respect of post-graduate training and posts of special responsibility. It is possible, therefore, for a graduate teacher to secure a maximum salary of 650*l.* in London and 600*l.* in the provinces, with the opportunity of promotion to the higher grades. Under such conditions a real career is offered in the service to both men and women, and the Committee is to be highly congratulated on the satisfactory completion of an extremely difficult problem. The Committee regrets that it has been unable to determine scales for the other grades of teachers owing to the many and various types of schools and the wide divergence of local conditions. Local education authorities are asked, however, to formulate suitable scales by agreement, and it is pointed out that these scales should be comparable with those adopted for similar classes of teachers in the secondary schools of the area. The adoption of the report will influence the desired development in technical and scientific education, which depends so largely on the securing to, and retaining in, the service the best type of teacher. It is in this respect satisfactory to find that technical and commercial qualifications and other experience may be regarded as the equivalent of an academic degree.

Calendar of Scientific Pioneers.

August 11, 1857. Marshall Hall died.—A distinguished physiologist, Hall while practising in London as a doctor studied the circulation of the blood, and in 1832 made his important discovery of reflex action.

August 12, 1865. Sir William Jackson Hooker died.—Few men have done more to advance the study of botany than Hooker, who from 1820 to 1841 held the chair of botany at Glasgow, and from 1841 to 1865 was director of the Royal Gardens at Kew. His herbarium—an exceptionally rich one—was bought by the nation.

August 12, 1896. Hubert Anson Newton died.—Made famous by his study of meteors and his prediction of the memorable display of November 13, 1866, Newton from 1855 until his death held the chair of mathematics at Yale, and for a time he directed Yale Observatory.

August 13, 1907. Hermann Karl Vogel died.—One of the pioneers in the application of Doppler's principle to stellar spectroscopy, Vogel worked with Zöllner and Spörer, and from 1882 was director of the Astrophysical Observatory at Potsdam. In 1883 he published his first spectroscopic star catalogue.

August 15, 1758. Pierre Bouguer died.—A Royal professor of hydrography, Bouguer studied naval architecture, and to him we owe the term "metacentre." He accompanied Godin and La Condamine on the great meridian expedition to South America (1735-45), and is also known as the inventor of a heliometer.

August 15, 1852. Johann Gadolin died.—An early exponent of Lavoisier's views, Gadolin was one of the most distinguished scientific men of Finland. He was the first to introduce the term "specific heat."

August 15, 1856. William Buckland died.—The first reader in geology at Oxford, Buckland made many pioneering geological excursions, wrote one of the Bridgewater treatises, and in 1822 received the Copley medal for his discoveries in a cave at Kirkdale. He was for some years Dean of Westminster.

August 16, 1705. James Bernoulli died.—From 1687 until his death James or Jacob Bernoulli held the chair of mathematics at Basle. His lectures of 1691 contain the first published attempt to construct an integral calculus.

August 16, 1899. Robert Wilhelm Bunsen died.—Holding the chair of chemistry at Heidelberg for thirty-seven years, Bunsen, like Liebig and Hofmann, was a great investigator and an inspiring master. His important work included the study of gasometric analysis and the chemical action of light, the invention of the Bunsen battery, the Bunsen burner, a photometer, and an ice calorimeter, and with Kirchhoff in 1859 he began his epoch-making researches in spectrum analysis.

August 16, 1920. Sir Joseph Norman Lockyer died.—Originally a clerk in the War Office, Norman Lockyer became famous for his pioneering work in astrophysics. Simultaneously with Janssen in 1868 he devised and used a method of viewing the solar prominences in ordinary sunlight, and shortly afterwards discovered helium. Transferred in 1875 to the Science and Art Department, he was from 1885 to 1913 director of the Solar Physics Observatory at South Kensington. He was the founder of this journal, and has been described as "one of the greatest astronomers of all time."

August 17, 1856. Constant Prévost died.—Known for his geological studies of the Vienna basin and of volcanoes, Prévost in 1830 with Boué, Deshayes, and Desnoyers founded the Geological Society of France.

E. C. S.

Societies and Academies.

PARIS.

Academy of Sciences, July 25.—M. Georges Lemoine in the chair.—E. Borel: The fundamental hypotheses of physics and geometry.—G. Lemoine: The mutual reaction of oxalic acid and iodic acid, iii. The influence of sunlight. The experimental difficulties are considerable, owing to the rise of temperature which necessarily takes place during the exposure. In round figures, it may be concluded that in sunlight the time of half-decomposition for a given temperature is 0.4 that found in the dark.—E. Haug: The dysharmonic folds in the mountains to the north of Toulon.—L. Joubin: Oceanographic cruises now being carried out. An account of the work allotted to France by the International Commission at Copenhagen and the researches already in hand.—F. Widal, P. Abrami, and E. Brissaud: Experimental researches on auto-colloidoclasia by cold. Experiments on dogs have shown that immersion in cold water (2° to 3° C.) for periods of from fifteen to forty-five minutes produced changes in the blood identical in character with those due to anaphylactic and other forms of shock. The leucocytes were reduced in number, the leucocytic formula was changed, coagulation of the blood occurred in a shorter time, and the refractive index of the blood serum was lower. The effect was transitory, and the more serious symptoms of anaphylactic or proteid shock were not produced.—P. Sabatier and B. Kubota: The catalytic decomposition of allyl alcohol; action of various oxides. The catalysts studied were blue tungstic oxide, alumina, thoria, zirconia, uranous oxide, and manganous oxide. The gases evolved included carbon monoxide, hydrogen, carbon dioxide, ethylene, and propylene, the last-named being in the highest proportion. Propanal and acrolein were present in the liquid distillate.—P. Humbert: Formula of multiplication for the Kummer function $\Phi(a, \gamma, x)$.—S. Carrus: Triple orthogonal systems.—L. Amaduzzi: A new property of feeble electrical conductors. A discussion of the interpretation of an experiment recently described by M. G. Reboul.—E. Dubois: The minimum potential of electrical discharge in hydrogen at low pressures.—L. and E. Bloch: Critical potentials and band spectra of nitrogen. The negative band spectrum of nitrogen appears at a higher potential than the positive spectrum, and a little higher than the ionisation potential generally attributed to this gas. It appears natural to attribute the positive band spectrum of nitrogen to the neutral molecule N_2 and the negative band spectrum to the positively charged molecule N_2^+ .—F. B. de Lenaizan and L. Maury: The conductivity of the solution of cuprammonium citrate compared with that of copper sulphate. The two salts obey the law of Arrhenius, and the copper ion is free to the same extent in both.—A. Boutaric and M. Vuillaume: The flocculation of colloidal arsenic sulphide. The influence of the dilution and the quantity of the electrolyte.—J. Barlot and J. Pernot: Combinations of the halogen derivatives of mercury and thallium.—A. de G. Rocasolano: The variations produced by stabilisers in the catalytic power of electroplatinosols. Sodium protalbinat, sodium lysalbinat, gum arabic, and gelatine were the stabilisers used in these experiments; in all cases the catalytic power, as measured by the decomposition of hydrogen peroxide, was reduced.—G. Andoyer: An apparatus for the technical analysis of gases.—V. Auger and Mlle. M. Vary: Sulphonations in the presence of iodine. The results obtained by the sulphonation of benzoic acid and pyrocatechol in presence of iodine are not in agreement with the experiments of J. N. Ray and M. Lac Dey

as regards the production of the ortho-isomer.—H. A. **Brouwer**: The eruption of a hornblende andesite in the Malay Archipelago.—L. **Lutaud**: The post-Sahalian movements and their influence on the morphology in the pre-Riffian zone of the northern R'arb, Morocco.—P. H. **Fritel**: The discovery in Senegal of two fossil fruits belonging to the genera *Kigelia* and *Nipadites*.—M. **Romicu**: The eleocytes of *Perinereis cultrifera* (Grube).—R. **Herpin**: The origin and the rôle of the reserve cells of the general cavity in *Perinereis cultrifera* and *P. Mariomi*, and the early differentiation of their eggs. The reserve cells probably arise from the lymphocytes, and have for their principal function the nourishment of the sexual products in course of elaboration. The development of the eggs is extremely slow, and requires more than a year.—M. **Mirande**: The extraction and the nature of the substance producing sulphuretted hydrogen in the seeds of certain Papilionacæ. A protein has been isolated from the seeds of *Lathyrus sativus*. Heated with water to a temperature of about 40° C., there is a spontaneous development of hydrogen sulphide; after this reaction is complete the residue still contains sulphur.—Mme. Z. **Gruzewska** and M. **Fauré-Frémiet**: The localisation of the glycogen in the liver and the muscles of dogs fed with a view to the maximum production of this reserve.—E. **Grynfeltt** and Mlle. R. **Latont**: Experimental porphyrinuria. Lesions of the kidney of the rabbit produced by sulphonal intoxication.—MM. **Desgrez**, **Bierry**, and **Rathery**: Some modifications of the blood-plasma and of the urine during fasting in diabetic subjects.—P. **Masson**: The nervous lesions in chronic appendicitis.

Books Received.

Public Library, Museum, and Art Gallery of South Australia. Records of the South Australian Museum. Vol. ii., No. 1. Pp. 208. (Adelaide.)

Fisheries: England and Wales. Ministry of Agriculture and Fisheries: Fishery Investigations. Series 1: Fresh-water Fisheries and Miscellaneous. Vol. ii., No. 1: The Methods of Fish Canning in England. Pp. 25. (London: H.M. Stationery Office.) 2s. 6d. net.

Rapport sur une Expédition d'Aurores Boréales à Bossekop et Store Korsnes pendant le Printemps de l'Année 1913. By Carl Störmer. (Geofysiske Publikationer, vol. i., No. 5.) Pp. 269+iv plates. (Kristiania: Grøndahl & Sons.) 15.00 kroner.

A French-English Dictionary for Chemists. By Dr. A. M. Patterson. Pp. xvii+384. (New York: J. Wiley and Sons, Inc.; London: Chapman and Hall, Ltd.) 18s. net.

Travels of a Consular Officer in North-West China. By E. Teichman. Pp. xiv+219+lviii plates. (Cambridge: At the University Press.) 25s. net.

A Critical Revision of the Genus *Eucalyptus*. By J. H. Maiden. Vol. v., part 6. (Part xlvii. of the complete work.) Pp. iv+161-85+plates 188-91. (Sydney: W. A. Gullett.) 3s. 6d.

Proceedings of the Royal Society of Victoria. Vol. xxxiii. (New Series). Pp. iv+285+xi plates. (Melbourne.)

A Philosopher with Nature. By Benjamin Kidd. Pp. vii+211. (London: Methuen and Co., Ltd.) 6s. net.

The North of Scotland College of Agriculture. Guide to Experiments at Craibstone, 1921. Pp. 45. (Aberdeen: North of Scotland College of Agriculture.)

Lawes Agricultural Trust: Rothamsted Experimental Station, Harpenden. Report 1918-20, with the Supplement to the "Guide to the Experimental

Plots," containing the Yields per Acre, etc. Pp. 86. (Harpenden.) 2s. 6d.

The Direction of Human Evolution. By Prof. E. G. Conklin. Pp. xiii+247. (London: Oxford University Press.) 12s. 6d. net.

Des Fondements de la Géométrie. By Henri Poincaré. (Bibliothèque de Synthèse scientifique.) Pp. 65. (Paris: E. Chiron.) 3 francs.

Mikroskopische Physiographie der Petrographisch Wichtigen Mineralien. By H. Rosenbusch: Band I., Erste Hälfte. Untersuchungsmethoden. Fünfte völlig Umgestaltete Auflage, von Prof. E. A. Wülfing. 1. Lieferung. Pp. xvi+252. (Stuttgart: E. Schweizerbart.) 16s.

L'Evolution Universelle: Exposé des Preuves et des Lois de l'Evolution Mondiale et des Evolutions particulières (Inorganique, Organique, Intellectuelle et Sociale); l'Evolution Mondiale, Inorganique et Organique. By Prof. B. Petronievics. Pp. viii+212. (Paris: F. Alcan.) 7.50 francs.

Theoretical Mechanics: An Introductory Treatise on the Principles of Dynamics. By Prof. A. E. H. Love. Third edition. Pp. xv+310. (Cambridge: At the University Press.) 30s. net.

The Geography of Illinois. By D. C. Ridgley. (Regional Geographies of the U.S.A.) Pp. xvii+385. (Chicago: University of Chicago Press; London: Cambridge University Press.) 16s. 6d. net.

CONTENTS.

	PAGE
University Finance	737
The Bible. By H. H.	738
Zoology for Medical Students	740
The Analysis of Steel	741
Relativity and Gravitation. By H. J.	742
Our Bookshelf	743
Letters to the Editor:—	
Atmospheric Refraction.—Dr. J. de Graaff Hunter; A. Mallock, F.R.S.	745
The X-ray Structure of Potassium Cyanide.—P. A. Cooper	745
An Ornithological Problem.—George A. Macmillan	746
Uniform Motion in the Ether.—E. H. Syngé; Dr. Harold Jeffreys	746
Conical Refraction in Biaxial Crystals.—Prof. C. V. Raman	747
Coiling of Underground Shoots of <i>Convolvulus arvensis</i> . (Illustrated.)—Rev. Canon J. E. H. Blake	747
Bees and Scarlet-Runner Beans.—Harford J. Lowe	747
Remarks on Simple Relativity and the Relative Velocity of Light. II. By Sir Oliver Lodge, F.R.S.	748
The Conference of the International Union against Tuberculosis	751
The Progress of British Forestry	753
Notes	754
Our Astronomical Column:—	
Bright Object near the Sun	759
Variable Stars	759
Mr. Flint's Parallax Observations	759
The Universities and Research. By Prof. J. Joly, F.R.S.	760
International Exploration of the Upper Air. By C. J. P. Cave	761
A Small Brillell Hardness Testing Machine. (Illustrated.) By H. S. A.	762
The Coal-mining Industry. By Prof. H. Louis	763
Botanical Papers from Pennsylvania	764
The Claude Process for Ammonia Synthesis	765
Field-work of the Smithsonian Institution	765
University and Educational Intelligence	766
Calendar of Scientific Pioneers	767
Societies and Academies	767
Books Received	768



THURSDAY, AUGUST 18, 1921.

Editorial and Publishing Offices:

MACMILLAN & CO., LTD.,

ST. MARTIN'S STREET, LONDON, W.C.2.

Advertisements and business letters should be
addressed to the Publishers.

Editorial communications to the Editor.

Telegraphic Address: PHUSIS, LONDON.

Telephone Number: GERRARD 8830.

A Suggested Institute of Human Sciences.

IN the human sciences—those sciences which deal with the origin, the characters (physical, mental, and moral), and the activities of man: in other words, the anthropological sciences in the broadest sense of the term—co-ordination and co-operation are more essential than in almost any other branch of scientific research. This is due partly to the extent of the ground covered, and partly to the character of the subject-matter, which is frequently based upon a mass of data collected from a wide area. This necessity for co-operation, acting in conjunction with man's perennial interest in himself and his past, has led to the formation of a host of societies, each dealing with one or more branches of the subject. Some cover certain special aspects only—archæological, sociological, linguistic, psychological, and the like; others study man on a regional basis, and of these some cover the whole field more or less completely, as in the case of Asia and Africa; while still others confine themselves almost entirely to the archæological aspect, as in the case of the societies which deal with Egypt, Palestine, and the Mediterranean area.

The function of these learned societies in the main is fourfold. The societies serve as a gathering place for workers at which the latest results of research can be announced and discussed; they provide libraries which in theory contain books and periodicals not otherwise readily accessible

to their members; they act as the publishers of the work of their members, which, on the ground either of its specialist character or of its brevity, is not suitable for publication elsewhere or in book form, thereby assisting further in disseminating the results of scientific investigation; and, lastly, they further the interests of their subject by the promotion and organisation of research and by pressing its claims to support upon the public. There has been considerable variation in the measure of success with which these functions have been performed; but, speaking generally, as the affairs of the principal learned societies which deal with human studies are in the hands of those who have attained distinction in their subjects, they lead the way and exert a not inconsiderable influence upon the lines of development of further investigation.

Those, however, who are concerned with the administration of these societies are well aware that the position is not entirely satisfactory. There is very little co-operation between societies, although a few welcome, but tentative, steps in this direction have been taken. Not only does this restrict undertakings which for financial or other reasons are beyond the resources of a single society, but it also leads to a certain amount of overlapping. Most societies have a library; where several societies deal with cognate subjects, in certain sections the same books and periodicals appear in each. This is a waste of both space and money, whether the library is augmented entirely by purchase or in part by exchange. There is also a waste of the time, energy, and money of the worker. A paper dealing with a certain specific subject may appear in any one of half a dozen or more publications, and it is impossible to know in which of a number of libraries a certain book may be found. In one case a scientific worker who wished to make use in his laboratory of a certain book long out of print visited nearly every scientific society in London before he ran it to ground. He then had to join that society in order to borrow the book.

There is also the question of catalogues and bibliographies. Owing to the cost of printing, any catalogue which is to be of use to the members who live at a distance, and cannot visit the library, is an impossibility, while a bibliography of current literature on comprehensive lines seems equally impossible without greater co-operation than has been secured up to the present.

In addition to the cost of maintaining libraries,

under the present system heavy expenditure is imposed upon each society by the necessity for providing suitable and adequate accommodation for meetings and lectures.

It is unnecessary to labour these points, which must be familiar to many. The difficulties do not date from to-day or yesterday, but at the moment they are more acutely felt. Under financial stress the activities and usefulness of scientific societies are being restricted. Increases in subscriptions do not counterbalance increase in costs. Individual workers also suffer; in many cases they have to confine their membership to the society to which their work is most closely related, thus restricting their outlook and their knowledge of current work.

It would, therefore, seem desirable to cast about for some remedy which might remove or mitigate these disabilities. This might be found in the union of a number of societies dealing with this group of studies to form an Institute of Human Sciences, housed in one building and governed by a supreme council, each society retaining such a measure of autonomy under its own committee as is consistent with the common aim. Considerable economies could then be effected by pooling the respective libraries, thus avoiding unnecessary expenditure on duplicating books, and to a certain extent by pooling the staff. The amount saved might be applied to increased expenditure on the library, on cataloguing, or on bibliographical work, for which the facilities would be greatly extended by the collection of the greater part of the material and the association of a number of specialists in various branches of study within the four walls of one building. The extent to which the various societies would be fused into one institution must depend upon circumstances; but it would probably be a gain if the publications were standardised and issued in series. It would not follow as a matter of course that each member would receive all the series; the issue would be confined to such only as he required. In fact, the issue of publications might well serve as a basis for regulating the amount of the subscription payable over and above the common fee of the institute admitting to the privilege of attendance at meetings, the use of the library, and other services.

That such an institute would greatly increase the resources at the disposal of the scientific worker is self-evident. Not only would he be brought more closely into touch with those investigating different aspects of the same problems

as he himself is investigating, but he would also benefit in other ways. Although scientific investigation is becoming increasingly a matter of specialisation, yet in the anthropological sciences the interrelation of the different branches of study is becoming closer as the need for synthetic treatment is more fully appreciated. No student of the human sciences can afford to neglect results obtained in fields other than his own. Under the present system few have the time at their disposal to attend the meetings of all the societies with the work of which they should be acquainted, or to go through all their publications, even if these are accessible. Given an institution under one roof, organised to meet this need of the worker, with a common library and a common staff, and provided with an adequate bibliographical system, and he should have no excuse if he failed to obtain all that he required.

By a combination such as is indicated science would benefit in at least two directions. Under the control of a supreme council, which from its constitution would be in a position to survey the whole field, research could be organised on a scale and with a certainty of direction which have not yet been attained, while the financial assistance which such an association of interests might hope to command would be considerable. Further, the influence which this body could bring to bear upon public opinion would be such as far to outweigh anything of which the individual societies appear capable at present, however desirable or necessary the objects which they urge from time to time in connection with matters of public interest.

In education it is now becoming generally recognised that, in addition to the study of physical and mental characters, the data of the human sciences have an important bearing upon many of the subjects of the curriculum of both universities and schools, and can be applied with advantage in teaching even quite small children. At present the educationist or the teacher who is not acquainted with the results of specialist research outside the four corners of his own subject is at a loss in which direction to turn for trustworthy guidance. Such guidance it would be one, and that not the least important, of the functions of the institute to provide.

Finally, although this scheme of amalgamation, for obvious reasons, must, with possibly a few exceptions, be confined to societies now housed in London, there is every reason to hope that

local societies throughout the country could participate to some degree. The local archaeological societies have done good work, but in the present state of our knowledge there is great need that their work should be standardised and given direction on a more or less common basis. This object might be attained by a system of affiliation and co-operation, more close than any now existing, with some central body such as the institute here suggested.

Astrology.

- (1) *The Mediaeval Attitude toward Astrology, particularly in England.* By Theodore Otto Wedel. (Yale Studies in English. No. ix.) Pp. vii+168. (New Haven: Yale University Press; London: Humphrey Milford: Oxford University Press, 1920.) 10s. 6d. net.
- (2) *Opera hactenus inedita Rogeri Baconi, Fasc. v. Secretum Secretorum cum glossis et notulis; Tractatus brevis et utilis ad declarandum quedam obscure dicta.* By Fratr̄is Rogeri. Nunc primum edidit Robert Steele. Accedunt versio Anglicana ex Arabico edita per A. S. Fulton. Versio retusta Anglo-Normanica nunc primum edita. Pp. lxiv+317. (Oxford: Clarendon Press.) 28s. net.

THE attitude of man towards Nature may be said to have two stages—the “magical” and the “scientific.” In the former, man lives in a world surrounded by other ill-defined beings and powers. From time to time he finds, or thinks he finds, some way to make these subserve his will, but he has as yet no apprehension of a constant relation of cause and effect. In the later, scientific stage—which first presents itself clearly to our view in the Ionian philosophers of the sixth century B.C.—a belief has arisen in natural law, in an invariable relation of cause and effect. Perhaps the most important step in the journey towards this belief was the discovery of the regularity in the movements of the heavenly bodies. The laws that these movements exhibit had long been the subject of organised observation in the Mesopotamian civilisations from which the Ionians inherited a wealth of data. But the Greeks had a passionate, almost an instinctive, belief in natural law, though few such laws had been demonstrated. Perceiving the majestic and regular recurrence of heavenly phenomena, they learned to predict them. They saw, too, that winter and summer, seed-time and harvest, day and night, and all the other broadly cyclic events of life, could be brought into some sort of relation with the heavenly cycle. Outside and beyond

these there were, indeed, innumerable less regular and unpredictable phenomena, for there was as yet no biology, no chemistry, practically no physics, and scarcely any mathematics. What more reasonable than to attribute a relation between the phenomena observed to be cyclic and those the laws of which were yet unknown? Natural laws there must be, and the field of the known was but extended into the unknown. Thus astrology was born.

Later a definite geocentric spherical system of the universe was introduced—a system that held its own right down to Copernicus and Galileo and beyond. The earth was surrounded by those mysterious concentric spheres in which the stars and planets held their place—the heavenly bodies considered by the greatest of the philosophers to be eternal and divine. Spatially the universe was limited; outside the outmost sphere was nothing; within the inmost sphere was the little world on which we live. To such a view the theory of astral and planetary control of our world was attractive, satisfying, well-nigh inevitable. It needed only verification, but verification was not the strong point of the scientific system of antiquity, still less of the Dark and Middle Ages which followed. The belief in the value of astrology thus remained almost universal from Greek times until the seventeenth century. It is unfair to regard it as a superstition. It is but a discarded and untenable scientific hypothesis.

Astrology, however, had a foe, and that foe was the Church, or rather the Churches. But the opposition of the Churches must not be accounted to them for scientific righteousness; rather it was the other way. The Churches were ever insistent on man's dependence on God. How, then, could man's existence be regulated by the action of the stars that were but God's creatures? Yet as time went on the opposition of all religions, Christian and other, gradually weakened. It became evident that even God Himself worked through agents, and why should not these agents be the stars that He had made? Thus room was made for the acceptance of astrological belief, which from patristic times onward gained steadily on men's minds. In the twelfth and thirteenth centuries, as the great Arabian revival of learning penetrated to the West, astrology became a highly elaborate science; by the fifteenth century, with the ebb of the scholastic movement, it had become a widespread obsession that infected alike the university, the council chamber, the law court, and the physician's consulting-room.

(1) The general history of this extraordinary

error is outlined by Mr. Wedel with a wealth of learning and an aptness of illustration that are a credit to American scholarship. His little volume betrays an enormous amount of research presented in an attractive and succinct manner that is a model for work of this kind. Especially praiseworthy is the logical and efficient distinction between material necessary for his narrative and the equally important material, needed by the specialist for verification and reference, that is rightly relegated to his ample notes; it is a distinction which is all too rarely made. Mr. Wedel is to be congratulated on a very able and readable contribution to the embryology of science.

(2) A much more difficult, though perhaps less thankful, task has been performed by Mr. Robert Steele. His edition of the version of the pseudo-Aristotelian "Secretum Secretorum" used by Roger Bacon, with notes by the father of English science himself, is a definitive contribution to our knowledge of the medieval attitude towards phenomena. This volume forms the fifth and largest fascicule of Mr. Steele's fundamental and valuable series of the hitherto unedited works of Roger Bacon. These works appeal perhaps to few readers, yet they are of permanent value as among the earliest documents of the re-birth of science.

With our present standards of historical and textual criticism it is at first incomprehensible that a great intellect like Bacon's could have taken this debased Arabian work for a treatise of Aristotle. With our standards of scientific verification it is equally incredible that such data as this work presents could make any appeal save to a confused and obfuscated intellect. Yet an appeal it did make, and for precisely that reason the work is of great interest, for by studying it and works like it we may reasonably hope to learn something of the mental processes with which "science" in our sense made its appearance in the modern world. These notes of Bacon were made at the turning point of his career, just before he passed from the pre-scientific to the scientific stage. He never freed himself from his belief in astrology, nor could any man entirely reject this doctrine while the geocentric theory held full sway. But Roger enunciated principles of observation and experiment which, in other hands, ultimately rendered astrological theory untenable. He never developed an adequate standard of textual criticism, but he made a strong appeal for the systematic study of languages, he formulated methods for such study, and he made remarkable and interesting attempts at grammatical analyses. These efforts of his, in other and more fortunate

hands, led to a scientific treatment of languages and of texts.

Roger Bacon stands as one of the heralds of the dawn of science, yet he has suffered much, and still suffers, from misunderstanding and neglect. Some of his most interesting works are still unprinted, and their publication is one of the several important pieces of work that must be achieved before any adequate and continuous history of science can be written. Yet the editing of such works is by no means easy, for it requires, on the one hand a very special training, and on the other a wide range of different kinds of knowledge that are very rarely combined in one individual. It further demands a degree of patient endurance of toil that is rare even among professional scholars; and, lastly, it calls for an indifference to the material reward for such prolonged labours that is perhaps rarest of all. Every one of these qualities the editor of this fascicule exhibits in abundant measure; his introduction and notes are scarcely less valuable than the text itself. We can but hope that Mr. Steele will be spared to complete the task that he has undertaken—a task for which very few besides himself are properly equipped.

It would be ungracious not to mention also the valuable translation from the Arabic text by Mr. Fulton with which the volume is enriched. The book is a peculiarly fine example of the skilful, accurate, and scholarly printing which the Clarendon Press has taught us to expect from it.

CHARLES SINGER.

Physical Chemistry, Pure and Applied.

- (1) *A System of Physical Chemistry.* By Prof. W. C. McC. Lewis. (In three vols.) Vol. ii., *Thermodynamics.* Third edition. (Text-books of Physical Chemistry.) Pp. viii+454. (London: Longmans, Green, and Co., 1920.) 15s. net.
 - (2) *The Determination of Hydrogen Ions.* By Dr. W. Mansfield Clark. Pp. 317. (Baltimore: Williams and Wilkins Co., 1920.) 5.50 dollars.
 - (3) *The Physico-Chemical Properties of Steel.* By Prof. C. A. Edwards. Second edition, thoroughly revised. Pp. xii+281. (London: Charles Griffin and Co., Ltd., 1920.) 21s. net.
 - (4) *Die Reaktionen des freien Stickstoffs.* By Prof. W. Moldenhauer. Pp. viii+178. (Berlin: Gebrüder Borntraeger, 1920.) 26 marks.
- (1) **P**ROF. LEWIS'S "System of Physical Chemistry" has been reviewed in these columns on two previous occasions, in September, 1916, and in May, 1919. Only a brief notice is

therefore required of the third edition of the second volume of the series. The principal additions that have been made deal with the e.m.f. method of determining the transport number of an ion, as employed by MacInnes and Parker, the work of Richards and Daniells on thallium-amalgam cells and of Tolman on centrifugal cells, American work on ionic activity, experimental work in support of Donnan's theory of membrane-equilibrium, and the work of McBain on colloidal electrolytes. Much of this new material is described in the words of the original investigators, as has already been done in earlier parts of the book.

(2) The determination of hydrogen-ions has become a very important section of physical chemistry, especially in its application to biological problems. The fact that Dr. Clark's book on this subject has been produced from the Research Laboratories of the Dairy Division of the U.S. Department of Agriculture is one indication of the practical application of the various methods of measurement which the author describes. These include the use of indicators, of hydrogen and calomel electrodes, and a few supplementary methods. The applications of these methods are so numerous that it is almost impossible to describe them adequately in any single volume; the chapter which deals with these applications has therefore been written in the form of a classified bibliography, the detailed references for which occupy 64 pages of the text.

A noteworthy feature of the book is a chart showing the colour of eight different indicators at nine hydrogen-ion concentrations, covering in each case the change from the alkaline to the acid coloration. The frontispiece is a photograph of Prof. Sorensen. The book is likely to prove of great value either to the physical chemist or to the biochemist who wishes to take up the very fascinating and fertile branch of study with which it deals.

(3) The appearance of the second edition of Prof. Edwards's "Physico-Chemical Properties of Steel" affords an opportunity of directing the attention of the readers of *NATURE* to a valuable book which has not been reviewed previously in these columns. A book with this title may be criticised either as a contribution to metallurgy or as an application of physical chemistry to a group of technical problems. As the author is a metallurgist, the reader will expect to find the technical side of the work well developed, and he will not be disappointed.

The physical chemistry is more open to criticism: thus a paragraph on "allotropy" (a generic term covering at least three distinct

phenomena) is not a satisfactory substitute for a clear description of the phenomena of isomorphism and polymorphism; the idea of "crystal bricks" is so far obsolete that it should surely be replaced by some account of the theory of space-lattices; it is impossible, even on the authority of Ewing, to accept the suggestion that rotating the "bricks" through an angle of 180° could possibly give rise to twinning—perhaps an angle of 90° was meant.

A few verbal errors have escaped correction in this edition, and the lettering of some of the diagrams has been reproduced by a process which leaves much to be desired in the matter of legibility. The micrographs, on the other hand, are a most attractive feature of the book, and none of them are more effective than those which the author has produced to show the formation of twinned crystals and of slip-bands as a result of mechanical strain in metals.

For the physical chemist Prof. Edwards has provided a mine of valuable information, bearing on the application to metallurgy of his branch of chemistry. Even the student is now generally familiar with the iron-carbon diagram and the general relationship of this diagram to the properties of the carbon-steels; but it is equally true that the parts played by sulphur and phosphorus are not generally known, even to the teacher of physical chemistry. It is a great convenience to have the available information put together in a concise form by one who is thoroughly familiar with the practical and not always harmful effects of these important impurities. The effects produced by manganese, chromium, tungsten, aluminium, silicon, and vanadium are also described, as well as the properties of special steels, such as high-speed tool steels and a number of ternary steels. The two new chapters in the second edition deal with the more important methods of making hardness-tests, and the influence of constitution on electrical resistivity.

Whilst the reviewer is not competent to assess the value of this book as a contribution to metallurgy, he can assert confidently that no physical chemist who has to teach students of engineering or metallurgy can afford to be without it, and that the information which it gives will broaden the outlook of any student of physical chemistry who may read it.

(4) Prof. Moldenhauer's book on the reactions of free nitrogen does not profess to deal with physical chemistry, and an apology is perhaps needed for including it in this category; but the nature of the subject is such that the main chapters of the book are necessarily physico-chemical in character, dealing as they do with

the "fixation" of the element in the form of ammonia, cyanamide, cyanides, or oxidised compounds of various kinds. These processes, which occupy the latter half of the book, have formed the subject of an extensive literature in recent years, and no great novelty of subject-matter or treatment is to be looked for.

The earlier half of the book traverses less familiar ground, and it is a great convenience to have the data in reference to the activities of a very inert element collected together in a systematic form. The facts that lithium and magnesium form exothermic nitrides and that cerium and uranium burn with incandescence in nitrogen represent the kind of information that can be given to illustrate the properties of a gas which usually receives but scanty treatment even when the behaviour of hydrogen, oxygen, and chlorine is fully described.

T. M. L.

The Realm of Man.

Principles of Human Geography. By E. Huntington and S. W. Cushing. Pp. xiv + 430. (New York: John Wiley and Sons, Inc.; London: Chapman and Hall, Ltd., 1921.) 21s. net.

The Principles of Economic Geography. By Dr. R. N. Rudmose Brown. (Pitman's Economic Library.) Pp. xv + 208. (London: Sir Isaac Pitman and Sons, Ltd., 1920.) 10s. 6d. net.

THE almost simultaneous appearance of two educational works on geography bearing very similar titles is not without significance. It shows the pressure of circumstances leading to the further elimination from geographical teaching of the mere enumeration of facts which has long been felt to be a desideratum, and to substitute an exposition which may claim to be regarded as a statement of principles. The result is, at any rate, the publication of two very good books, which may be welcomed as forming an important contribution to the definition of geography as it is coming more and more to be apprehended in the higher teaching of the subject. They may both be looked upon as going far towards supplying what the present reviewer has long felt to be a want among geographical text-books—a physical geography in which the main stress is laid upon influences, direct and indirect, on human life connected with place, rather than upon that aspect of the subject which looks to geology as its natural development; that in which almost the entire emphasis is laid on the operations by which the earth's crust undergoes modification.

This conception of the meaning of the designation "Principles" in both books is more apparent

in the larger of the two, that of American origin, the chapters of which all have titles, such as "Man's Relation to Physical Environment," "Man's Relation to Location," "Man's Relation to the Climate," etc., bearing this out. Both works, indeed, involve the statement of a good many mere facts of geographical distribution, but it would be pedantic to take exception to this as not in accordance with the titles. The selection of the facts given shows regard to principle in the singling out of those which it is most important to think of from the point of view maintained by the authors.

While both books may be described as, in a large measure, physical geographies of the kind indicated, they are, of course, not wholly so. Neither would adequately answer to its title if it were, for in both it is recognised that when influences on human life are considered as having the place relation that demands their inclusion in geography, facts derived from many sciences have to be reckoned with and focussed in varying degrees in different cases on particular problems. Further, it should be added that both books are written in a style of admirable clearness.

But it does not follow from what has just been said that no exception can be taken to the exposition of principles by the authors. The eagerness to substitute principles for isolated facts sometimes leads to rather hasty generalisation, which, it must be confessed, has long been an evil in geography. The failing may arise from an insufficiently disciplined desire to place geography on the footing of a science, which, it is thought, it cannot claim without having its own stock of this kind. It might, on the other hand, be pointed out that the very fact that it is so hazardous to frame generalisations aiming at strictly geographical content, and that the function of geography is rather to maintain the habit of looking round in all directions for influences connected with place, has the advantage of making each case a subject for special and comprehensive thought, which surely gives great educational opportunity. At any rate, the tendency to lack of due care in generalising cannot be denied, and there are, especially in the American work, too many evil consequences thereof. Probably most of the hasty statements of which complaint is made would mislead no competent teacher. Most of them result, one may be sure, from no misconception on the part of the authors, who have simply, while using plain language, failed to express exactly what they mean, or in some cases made too summary statements, which may be accepted as true when the necessary qualifications are supplied.

One illustration may be given. Comparing the climate of the Lofoten Isles with that of Verkhojansk in the same latitude, "and no farther apart than Portland, Maine, and Portland, Oregon," the authors ascribe the differences solely to the influence of the ocean. One cannot but ask, if that is so: How are we to explain the great differences especially between the winter climates of Portland, Maine, and Portland, Oregon, or the fact that the average mean January temperature of Cape Hatteras (46° F.) is just the same as that of the Scilly Isles 15° farther north, although the Gulf Stream proper passes close by the cape with a mean winter temperature of 72° F., while the winter temperature of the water round the Scilly Isles is only about 50° F.? One has to go well into the book to find any recognition of the agency of the winds as an intermediary influence on temperature.

One of the excellent features of the book is the number of ingenious and thought-provoking exercises at the end of each chapter, but a good teacher might find it profitable also to supplement those exercises by asking his students to fill up the gaps in the generalisations which are, without doubt, complete in the minds, but not in the text, of the authors.

The smaller book, by Dr. Brown, has no illustrations, but the other has, in addition to views, numerous instructive diagrams and maps.

GEO. G. CHISHOLM.

Calculus for Students.

An Elementary Course of Infinitesimal Calculus.

By Prof. H. Lamb. Third edition, revised.

Pp. xiv + 530. (Cambridge: At the University Press, 1919.) 20s. net.

THE merits of Prof. Lamb's text-books are so well known and appreciated that it is unnecessary to analyse or commend the present one, especially as it appears in its third edition. As the work of an experienced teacher, revised in the light of modern mathematics, the book affords a model, and suggests a few observations. Naturally, the influence of recent research is most evident in the first chapter, "Continuity." This contains a discussion of sequences, upper and lower limits, limiting values and infinitesimals, which we may presume to be the author's idea of what is suitable for the average student before starting upon the infinitesimal calculus. In the light of present knowledge it is a kind of indispensable minimum; but it will probably be found as much as can be comprehended by the type of

student for whom the book is mainly designed. In any case, the inclusion of such a chapter is a significant mark of progress in the practical aims of mathematical teachers.

There are two points to which the author himself directs attention. The first of these is that, in dealing with series, he has confined himself mainly to power-series, and omitted the discussions of uniform convergence previously included. Remembering that this is an *elementary* course, we may acquiesce, if with some reluctance, in the author's judgment. The second point is that $\exp x$ is defined as a particular solution of the differential equation $dy/dx=y$. This is Clifford's procedure in his "Elements of Dynamic," and has everything to be said in its favour—assuming that the student begins the calculus at the proper time in his general course. All the properties of the function and its inverse can be deduced with great ease, and in a way that needs no amendment when the variable is complex. We rather regret that Prof. Lamb has omitted the complex variable altogether; Clifford's graph of $\exp i$, and its connection with the radian, do, in fact, interest quite average students when they are working at de Moivre's theorem and its consequences.

It would be easy to point out many features of the book which show the advantages accruing from the fact that the writer is an applied as well as a pure mathematician. One of these is the excellence and instructiveness of the diagrams; another is the variety of the examples; and as a third we may take the discussion of the linear differential equation $y'' + ay' + by = 0$ and those closely associated with it. It is possible to make the discussion as dull and mechanical as the most old-fashioned solution of a quadratic by completing the square; here we have a treatment which is really instructive, and illustrated by the right sort of examples.

It is curious to notice that nobody seems to have suggested a "standard" sequence of theorems in elementary differentiation, though every argument urged for such a thing in elementary geometry applies here with at least equal force.

G. B. M.

Our Bookshelf.

Map Reading. By G. H. C. Dale. Pp. vii + 170 + xx plates. (London: Macmillan and Co., Ltd., 1921.) 7s. 6d. net.

It is stated in the introduction to this book that a map is at times as valuable as a rifle. One might go further and say that a knowledge of local topography may be as valuable as a bat-

talion. Unquestionably the best of topographical educations is surveying on the ground, which should form part of the instruction of all candidates for commissions in the Regular Army. Unfortunately such instruction has not always been given, and is, perhaps, out of the question for Territorials. Even so, instruction in map reading should be given mainly on the ground. There are, however, examinations to be passed in which questions are based mainly upon certain specified maps and conventional signs. Mr. Dale's book will be found of great assistance in this matter. It is clear and practical, and accompanied by good examples and questions.

The sequence of the book would have been improved by combining parts of chaps. i. and vi. in a separate chapter on finding position. A compass is rarely used for this purpose by an experienced map reader if the map in question shows much detail. This chapter might also have included grids, margins, and co-ordinates both geographical and rectangular. Such information as is given on these points is not very enlightening. For example, the position of the origin of co-ordinates and the direction and order in which they are given may, and doubtless will, vary according to circumstances.

The British soldier may have to accustom himself to many different styles of cartography. He should not be asked to memorise any particular conventional signs, but to study such different maps as he may have to use, and, above all, to educate his eye for country. Artificial and arbitrary differences such as those made in chap. iii. between "hills" and "knolls" would then be unnecessary.

Faune de France. No. 1. Echinodermes. By Prof. R. Kœhler. Pp. 210. (Paris: Paul Lechevalier, 1921.)

WITH the aid of a subvention from the Paris Academy of Sciences, a new fauna of France, of which the first part has been issued, has been prepared by the Fédération Française des Sociétés de Sciences Naturelles. Its object is to furnish naturalists with a handy means of identifying their captures. To this end each group is preceded by a key to the species, and the descriptions which follow are just enough to enable the first result to be verified. The fauna comprises land and fresh-water forms from France (including Corsica), Belgium, the Rhine province, and Western Switzerland, and marine forms within the limits of the continental plateau to a depth of about 300 metres and the corresponding pelagic region from the Sound to the Straits of Gibraltar, including the British Isles and the Western Mediterranean. The work, therefore, should be found useful by British naturalists.

For the Echinoderms no better authority could be desired than Prof. Kœhler, of Lyons. His nomenclature is up to date, his descriptions are to the point, and his illustrations, being, as a

rule, from photographs of the actual specimens, are sufficiently indicative for a work within these limits. Some of the half-tone blocks are, it must be confessed, not very clear, and some of the borrowed diagrams are credited to wrong sources; thus Fig. 10, of a starfish, is not from Goodrich, but from the British Museum Guide; Fig. 68, showing the fascioles of a sea-urchin, is one of the numerous figures taken by Delage and Hérouard from the Echinoderm volume in the "Treatise" edited by Lankester. At the special request of the editors, Dr. Kœhler has gallicised the ordinal names. The historical confusion that has arisen from this common French custom is well known, and we have never grasped why such a name as "Les Forcipulosées" is any more intelligible than "Forcipulata"; it is not even French.

The Place-Names of Northumberland and Durham. By Prof. Allen Mawer. (Cambridge Archæological and Ethnological Series.) Pp. xxxviii+271. (Cambridge: At the University Press, 1920.) 20s. net.

PROF. MAWER'S work on the place-names of Northumberland and Durham has an interest which transcends its geographical limitations. Unlike most workers on this subject, he does not confine himself entirely to the linguistic side of the evidence. He is prepared to turn to topography, ethnology, or history for assistance or confirmation. For instance, he has tested, by a careful examination of topographical conditions, the theory that names ending in *ington* occur on high ground where the geological formation favours the finding of springs. As a result, he finds that the theory holds good in East Northumberland only, but that in the west of the county the water supply is dependent upon other factors. The tendency of the lines of investigation followed by Prof. Mawer will inevitably be to bring the study of place-names into closer relation with cognate problems in ethnology and history, and to break down the isolation which has characterised even some of the best work on the subject in this country.

As a result of Prof. Mawer's very careful survey of the evidence for names recorded before the year 1500, and identifiable on the map, it would appear that the vast majority are Anglian. River names are Celtic, but "Cheviot" is the only recorded Celtic hill-name of note. Prof. Mawer concludes that the Anglian conquest was complete. The distribution of names with a Scandinavian element does not afford strong evidence of settlement except in two, or possibly three, cases. It suggests rather a movement from the sea up the great river valleys or from the more distinctively Scandinavian areas which lie to the south. Prof. Mawer's book lends added force to the plea for an organised survey of English place-names as a whole which he has made elsewhere.

Nuova Navigazione Astronomica: Le Rette di Posizione. Teoria—Applicazioni—Tavole. By Prof. G. Pes. Seconda edizione. Pp. lxxxiii + 127. (Genova: Regio Istituto Sordomuti, 1921.)

THE position-line method in navigation was first introduced by Capt. Sumner; it has greatly grown in favour, since it exhibits in a convenient manner all the information that a single observation of altitude is capable of affording. There have been a large number of nautical tables published with the idea of simplifying the application of the method to determine the position-line of the ship. The "Altitude Tables" of the Rev. F. Ball give the altitude for every degree of latitude, declination, and hour-angle. Other tables by Aquino are in wide use in America. Mr. Herbert Bell proposed some useful modifications of the plan of the latter in a paper in *M.N.R.A.S.*, vol. lxxx., p. 72.

The tables of Prof. Pes are of a different form; the principal table is one of haversines (*i.e.* half versed sines), both the natural and logarithmic values being given to five decimals. The author assumes a point on the earth's surface near the estimated position of the ship, and calculates the hour-angle P , and the meridian zenith distance z_m of the observed body, the declination of which is δ . He finds an auxiliary angle θ from the formula (ϕ is the latitude of the assumed point)

$$\text{hav } \theta = \cos \phi \cos \delta \text{ hav } P.$$

Then

$$\text{hav zen. dist.} = \text{hav } \theta + \text{hav } z_m.$$

A set of four small tables with easily derived arguments enables the direction of the position-line to be determined.

The ship lies on a parallel line separated from the former by the difference between the observed and computed zenith distances.

Opinions will differ as to the relative merits of these rival methods of reduction, but at least it may be said that the method given in this volume is sound and fairly short. A. C. D. C.

A Textbook of Botany for Medical and Pharmaceutical Students. By Prof. J. Small. Pp. x + 681. (London: J. and A. Churchill, 1921.) 25s. net.

THERE has been little attempt at selection in this book, with the result that a great deal of material has been brought together, some of which the beginner will scarcely be able to use. Nevertheless the book is written with independent views, and will doubtless be of service to many. The illustrations are a prominent feature, but some of them are on too small a scale to be satisfactory; *e.g.* Fig. 67, the legend of which also contains inaccuracies, as well as the figure itself. Such figures as 330 and 913 leave much to be desired. The work touches on every phase of botany, with frequent reference to economic applications. The advisability of including in an elementary text-book such a highly speculative subject as the author's theory of geotropism is very questionable, especially since the statolith theory has received

strong experimental confirmation from the work of Bose. In the chapter on heredity it is a mixing of conceptions to apply the term reduplication to the crossing-over of chromosomes. This book will probably find its greatest use as a work of reference for pharmaceutical students and as an accessory text for others. Notwithstanding the above criticisms, it is a welcome addition to botanical text-books.

Stella Maitland; or, Love and the Stars. By H. P. Hawkins. Pp. viii + 249. (London: Simpkin, Marshall, Hamilton, Kent, and Co., Ltd., n.d.) 6s. net.

IN a foreword the writer intimates that her object is "to create a deeper interest in the fascinating subject of astronomy, under the conviction that, if once aroused, it can never fail to yield one of the greatest delights which it is possible for the human soul to experience." The aim is commendable enough, but whether it will be promoted by this rather crude mixture of science and romance must be a matter of opinion. There is no subtlety in the characterisation, and the powder is administered baldly in the form of star-lessons. M. Camille Flammarion's "Stella" appears far more successful, considered as a work of art. But it is a *genre* in which success is scarcely to be expected. It suffers from all the handicap of the novel with a purpose in its most acute form, and it can make an appeal only to minds of an unsophisticated type.

Vocational Chemistry: For Students of Agriculture and Home Economics. By Prof. J. J. Willaman. (Farm Life Text Series.) Pp. ix + 294. (Philadelphia and London: J. B. Lippincott Co., 1921.) 8s. 6d. net.

Boys and girls in American agricultural high schools are the readers for whom this book is intended. The first part is devoted to the fundamental facts and principles of chemistry, whilst the second deals with the main chemical facts concerning plant and animal growth, cooking and cleaning, and with milk and its products. The early portion of the book is superficial, and not free from inaccuracies and ambiguities. There are many illustrations, some of which are rather trivial—*e.g.* "an open fire-place," "a herd of beef cattle"—and some are on pages far removed from the description in the text, no references being given.

The Moral and Social Significance of the Conception of Personality. By the late A. G. Heath. Pp. viii + 159. (Oxford: At the Clarendon Press, 1921.) 7s. 6d. net.

THIS essay was awarded the Green moral philosophy prize in 1914. The author fell in the war. The book is now published by his friends with the desire, we can well understand, to raise to a comrade a *monumentum aere perennius*. It shows wide reading and clear thinking, if it possesses no striking originality.

Letters to the Editor.

[The Editor does not hold himself responsible for opinions expressed by his correspondents. Neither can he undertake to return, or to correspond with the writers of, rejected manuscripts intended for this or any other part of NATURE. No notice is taken of anonymous communications.]

Biological Terminology.

ACTUALLY we are now talking about biological method. In his last letter (NATURE, July 28, p. 680) Sir Archdall Reid makes three appeals to me. My own contribution to the discussion has been confined to a defence of systematic biology, and I have no authority to answer for any "sect of biologists." But surely most of us accept the principles of scientific work that he lays down; most of us realise that our interpretations are mere working hypotheses; and most of us are always on the look-out by observation or experiment for those crucial facts which shall confirm or upset our hypotheses. My own difficulty has been either to devise a question that should be universally accepted as crucial, or, having devised one, to elicit the relevant facts. Biologists who can experiment with their material are certainly in a better position to perform both these operations than is one who can only observe portions of extinct animals. The distinguished author whom Sir Archdall Reid quotes merely uses a little more force in making essentially the same remark. But he can defend himself—if he cares to.

If, then, there are "sects" among biologists, I should be inclined to ask: Which of them does not employ—or, rather, attempt to employ—crucial testing? Apparently Sir Archdall Reid does not study the periodicals with which I am familiar; but possibly, as a medical man, he reads *Parasitology*. I, too, happened to look at its last number, and I observed an inquiry by Mr. P. A. Buxton into the specific distinctness of the mites responsible for three forms of mange. A form known as Norwegian crusted scabies has been the subject of divergent views, and "it is," says Mr. Buxton, "much to be desired that someone who is fortunate enough to see a case should infect a few volunteers in order to discover whether ordinary itch or the crusted variety is induced, and whether, after one or two generations, the mites can in any way be distinguished from typical *S. scabiei* var. *hominis*." This is an application of the crucial test; but Sir Archdall Reid may retort that it is only another of the lakes in an Africa of malpractice, and since I cannot swamp your pages with all the other lakes I must leave him to wander in the desert.

Sir Archdall Reid offers to help me on the question of recapitulation; but I would ask him first to explain his "glaring truism." He writes, "Variation is the sole cause of non-inheritance, etc." Surely "variation" in this sense is but another name for "non-inheritance," and the rest of his sentence therefore merely states that the offspring resembles the parent when it does not differ from it. But if there is any other meaning in the sentence, then I would remind him that whether "like exactly begets like when parent and offspring develop under like conditions" is just one of the questions that divide biologists. A germinal change would be a change of the conditions, and is therefore excluded. Either "the glaring truism" is an identical proposition, or it is a statement actually disputed. In neither case is it the same as the statement that, "apart from variations, offspring tend to recapitulate the development of their parents." If Sir Archdall Reid thinks that it really is the same, he is scarcely the man to dispel our

difficulties. Those difficulties are not implicit in either of his "truisms."

F. A. BATHER.

August 14.

The Fauna of Scottish Lochs.

IN Mr. B. B. Woodward's interesting letter on the occurrence of *Pisidium Clessini* in Loch Ness (NATURE, August 4, p. 715) he does not mention the depth at which his specimens were found. Loch Ness, in the deeper parts of which *Pisidium* has been dredged on more than one occasion, is a very deep lake in which different zones of life undoubtedly occur. In Lake Biwa, in Japan, the Palæartic *P. casertanum* is found only at considerable depths (17–30 fathoms), and it is probable that in Scotland *P. Clessini* lives still deeper.

Last month (July) I spent investigating the fauna, and especially the molluscs and sponges, of two comparatively shallow lakes in Perthshire, Loch Lubnaig and Loch Vennachar. No evidence was obtained in either lake of the occurrence of a deep-water fauna or of the existence of molluscs at greater depths than 70 ft., at which a *Pisidium* (probably not *P. Clessini*) was fairly common; but the area below 100 ft. is there very small. The only other molluscs common in the two lakes were *Limnaea peregra* and "*Ancylus fluviatilis*," both of which also occur in the streams that flow out of them. The faunas and habits of the *Limnaea* in the two lakes are different. I hope to discuss the reasons why elsewhere.

Thirteen years ago I directed attention to our ignorance of the fresh-water sponges of Scotland. Since then nothing further has been published, though Mrs. Scharff (Miss Jane Stephens) has given us an admirable account of the Irish species. In Loch Lubnaig the abnormally low water of last month afforded unusual opportunities for the study of these interesting organisms. Three species (*Spongilla lacustris*, auct., *S. fragilis*, Leidy, and *Heteromeyenia Ryderi*, Potts) were found, mostly in the form of small, thin films on the lower surface of stones that would have been almost inaccessible in ordinary circumstances.

I may also mention another interesting observation made at Loch Vennachar, namely, that a Tubificid worm common at the edge of the lake has the habit of encysting in the earth when the water retreats. Each cyst contains from one to twelve individuals closely coiled and in a state of apparent torpor. When the cysts are placed in water the wall bursts and the worms emerge in a lively condition.

N. ANNANDALE.

Isle of Ulva, Argyllshire.

Magnetic Double Refraction in Smokes.

THE letter from Prof. Elihu Thomson on "A Novel Magneto-optical Effect" which appeared in NATURE of June 23, p. 520, suggested to me that the phenomena were associated with magnetic double refraction.

I used a Nernst lamp with a vertical wire; a parallel beam of light, polarised through a Nicol with the principal section at 45°, passed along a diameter close to the superior plane of a circular plate coil disposed horizontally; and, finally, a second Nicol crossed with the first.

At the bottom of the coil was arranged in a convenient way an arc lamp with metallic electrodes, able to give large quantities of smoke when carrying 30 amperes and 140 volts. A copper pipe, coaxial on the top with the coil, conveyed the fumes on the side of the magnetic field crossed by the polarised light, and was disposed so as to prevent disturbing light from the arc in the observation space. The coil

had an internal diameter of 16 cm., an external diameter of 28 cm., and a height of 6 cm., and it was possible to obtain a magnetic field of many tens of gauss.

Rising from the copper pipe, the yellowish smokes (obtained with iron electrodes by condensation of iron vapour) showed a thick layer of fumes where traversed by polarised light. In these conditions, putting on the magnetic field, light appears through the crossed Nicols and remains until the field is cut off.

In preliminary experiments I was able to determine the following characters of the observed phenomena:—

(1) Turning conveniently the analysing Nicol, chromatic polarisation is obtained.

(2) With monochromatic light it is not possible to reach extinction by turning the analyser. Using a Babinet compensator, a suitable displacement of fringes, with field excited, was observed, and appeared as positive birefringence.

(3) With light polarised in a parallel or normal plane to the direction of the field the phenomenon is not manifest.

Moreover, if the coil is arranged in a vertical position the phenomena appear if the axis of the coil is normal to the polarised luminous beam, but not if the same axis is parallel to it.

Tests made with copper electrodes gave quite negative results with the above-described arrangement. This may be explained by the weakness of the field, as by employing a powerful electromagnet the effect appears also with smoke from copper electrodes.

L. TIERRI.

The Physical Institute, University of Rome,
August 1.

The Exploitation of Irish Peat.

PROF. RYAN in his article under the above title in NATURE of August 4 (p. 728) states that the labour difficulty is a serious obstacle in so far that the work is seasonal. I should like to suggest that this can be overcome by adopting the method employed for the production of moss-litter (used for bedding for animals) as now practised in Scotland and elsewhere. This method allows the men employed to be engaged in cutting peat in the earlier part of the winter and whenever the weather does not permit other operations. It follows that a great quantity of the wet peat lies throughout the winter exposed to the weather, and by the alternate freezing and thawing which it experiences the texture is very much opened up. Consequent on this, when the peat is built up in the spring it dries very much more quickly than material newly cut.

It is true that this method is not practised by crofters and others who depend on peat for fuel for domestic consumption, because the resulting product is not the hard, dense, compact body which is most suitable for burning in an open fire. However, for the exploitation of peat on a large scale this should not be necessary, since the peat is bound to be burned in closed furnaces with a strong draught. So far as my experience goes, it leads to the conclusion that the texture only, and not the composition, is altered by exposure during winter.

The adoption of this method would solve one of the most important labour problems, namely, the constant employment of the necessary able-bodied men. It would not permit the employment of women throughout the whole year, but would require their services to be dispensed with for about three months during the worst part of the winter. Whether such an industry could furnish an adequate wage for the

workers in it is a question that can be considered only with reference to the specific conditions of surrounding industries and consumers.

ALEXANDER FLECK.

26 Manor House Road, Jesmond, Newcastle-upon-Tyne, August 8.

Scarcity of Swallows.

THE following may not throw light upon the scarcity of swallows in England this year, as noted in NATURE of July 14, p. 628, but will explain a shortage in another part of the world, and may be of interest and suggestive.

I live in the Gran Chaco of Paraguay, South America. In July, 1920, there was a succession of dull days extending over a week, accompanied by fine rain and a temperature varying between 20° and 10° C., strong winds also prevailing. On the fourth day of these conditions the swallows sought refuge in the buildings of the Mission Station, where I reside, and for three days dead bodies of the birds were picked up, and afterwards no more birds were seen. A few days later I had to make a journey which took me in a direct line for 120 miles, during which I did not see a single swallow. Managers of four cattle farms through which I passed reported a mortality of swallows at their establishments similar to that seen at the Mission Station. From other reports I concluded that the whole area of the Gran Chaco had been affected by the bad weather, and as in the month of July swallows are always more numerous than in other months and pass in flocks northward, I fear the mortality to swallows in South America must have been very great. The deaths were the result of the lack of insects rather than of the cold.

ANDREW PRIDE.

3 Town Bank Road, Ulverston, July 26.

Earthworms Drowned in Puddles.

ANGLERS use earthworms, and worms found in the little heaps of mud-scrapings on country roads are specially valued as being of a fine, delicate pink colour, clean and tough. I have heard anglers in North Wales say that no worms were so good, especially for sea-trout. But since road-tarring became so general the phenols (=carbolic acid) dissolved out of the tar by rain destroy the worms. Unfortunately, in numberless cases the trout have also been destroyed, adult fish as well as fry, and American experiments have proved that the spermatozoa of fish are killed by carbolic acid from tar even when so diluted as to be almost undetectable by any test.

R. B. MARSTON.

19 Adam Street, Strand, August 7.

The Neglect of Science.

A LADY called on me to-day saying she had been sent by the sanitary inspector of a large town a few miles from Manchester with specimens of a little winged beetle (*Niptus hololeucus*), which she and the inspector thought might be bed-bugs.

Is it not extraordinary that those who are placed in posts of great responsibility in sanitary matters are so ignorant of their job that they cannot distinguish a flat wingless bug from a harmless and almost spherical beetle?

I wonder how much money has been wasted in unnecessary fumigation and the destruction of bedding by the crass ignorance displayed by sanitary inspectors of the elements of the natural history of their calling.

SYDNEY J. HICKSON.

The University, Manchester, August 11.

The Determination of Sex.

By PROF. R. GOLDSCHMIDT, Kaiser Wilhelm-Institut für Biologie, Berlin-Dahlem.

IN this communication it is proposed to give an exposition of the subject of the determination of sex presenting chiefly the line of argument which the writer has been able to develop from recent work on the question. In doing so it will be convenient to confine our attention to one line of thought, though this will compel us to omit mention of much important work upon the problem. Further, it is proposed to limit the account to the writer's own field of work—namely, the animal kingdom. For a more complete account we refer the reader to the author's book, "Mechanismus und Physiologie der Geschlechtsbestimmung" (Borntraeger, Berlin, 1920).

The situation in regard to sex which is typical in nature is that out of a number of fertilised eggs of a given species about equal numbers of male and female individuals are developed. The problem of the determination of sex, then, presents itself in the form of two principal questions: first, what is the mechanism which, at a certain moment, separates the flow of development into two different streams—those of female and male differentiation; and secondly, what is the material difference in the two sets of individuals thus separated, and how does the supposed difference act physiologically in order to direct individual development along female or male lines? We may call the first of these questions the problem of the mechanism of distribution of the two sexes; while the second is the problem of the physiology of sexual determination.

It will be clear to every student of biology that the first problem in question is part of the general problem of the mechanism of heredity—*i.e.* it is concerned with the transmission of genetic properties from parent to offspring and their distribution among offspring. Therefore the study of the mechanism of distribution of the sexes has formed an integral part of modern work in genetics, and partaken of its triumphal progress. We may safely say that to-day, in the light of Mendelism and the work accomplished in the realms of cytology, the problem is solved as completely as the methods of biology permit.

The first successful attack upon the problem was made when Doncaster and Raynor discovered and studied the famous case of sex-linked inheritance in the currant-moth, and Bateson and Punnett furnished the Mendelian analysis of the case. By following the hereditary distribution of a somatic character closely linked with the distribution of sex, the inference could be drawn that one sex must be heterozygous for a Mendelian factor connected with sexual differentiation, and the other sex homozygous. Thus one sex produces two kinds of gametes in respect to the factor in question, the other sex only one kind. The resulting situation is, therefore, the same as in a back-cross between a hybrid Aa and the pure recessive form aa ; both types reappear again in

the offspring in equal numbers. Since then an immense number of cases of sex-linked inheritance have been analysed, all with the same general result; one sex is homozygous in regard to a sex-differentiator, and produces one type of gametes—*i.e.* it is homogametic; the other sex is heterozygous, and produces two types of gametes—*i.e.* it is heterogametic. There is one complication so far as certain groups of animals are concerned: in mammals and in most of the insects the male is the heterozygous sex, whereas in moths and birds it is the female which produces the two kinds of gametes. The possible meaning of these two types is, however, a question of detail which does not concern us here.

Almost simultaneously with the solution of the problem of the mechanism of distribution of sex in terms of Mendelian symbolism, McClung announced that the odd chromosome found in the sperm-cells of certain Orthoptera and Hemiptera might act as a differentiator of sex. Since then the study of the sex-chromosomes has progressed with a rapidity and success which have rivalled Mendelian discoveries regarding sex. The simple result which stands out to-day as one of the basic facts of cytology is this: all the cells of the body of many animals contain in one sex either an odd chromosome, called an X-chromosome, or an unequal pair of chromosomes, called an X-Y group. The cells of the other sex contain, instead, two X-chromosomes. As is well known, all sex-cells undergo a reduction division which reduces the somatic number of chromosomes to one-half; this reduction is brought about by a pairing of each maternal with a corresponding paternal chromosome and subsequent disjunction of whole chromosomes during the meiotic division. An odd X-chromosome, whether it has a Y-partner or not, must, therefore, pass undivided to one of the daughter-cells during the meiotic division. The result is the production of two mature sex-cells, one with X, the other without X. In other words, the sex containing the odd X (or the X-Y group) forms two kinds of gametes, which are with and without X respectively—*i.e.* it is heterogametic. The other sex, however, with its two X's, produces only gametes with X, and is therefore homogametic. In fertilisation, then, an X-gamete of the latter sex may unite either with a Y-gamete, or with an X-gamete of the heterogametic sex. The result is XX- and XY-zygotes—*i.e.* the two sexes.

The close parallelism between the genetic and cytological facts led Gulick, Morgan, and the writer to venture the opinion that the genetic facts of sex-linked inheritance could be completely explained, if it were assumed that Mendelian factors which are inherited in that peculiar way are carried within the X-chromosomes. Such an assumption would lead to the view that the Mendelian explanation of sex-linked inheritance and

distribution of sex is only a symbolical way of representing what actually happens when the mechanism of the X-chromosomes is set to work; or, as we put it occasionally, both sets of facts express the same thing in different language.

Recent work has proved the correctness of such assumptions. We need mention only that in the fly *Drosophila*, where breeding work showed the male to be the heterozygous sex, cytological investigation also demonstrated the existence of an X-Y group in the male (Morgan and collaborators); in moths, where genetic proof exists that the female is the heterozygous sex, the existence of an odd X-chromosome in the female was conclusively shown (Seiler). But what we may regard as final proof was furnished by Bridges when he analysed cases in which unexpected genetical behaviour of sex-linked characters was shown to be explicable on the assumption of a non-disjunction of sex-chromosomes during the meiotic division, and when he was able to add cytological evidence of such an event to the genetic proofs. Thus we are led to believe that the mechanism of the distribution of the two sexes among the offspring is perfectly known; it is furnished by the distribution during meiotic division of the sex-chromosomes, carrying, among other factors, the sex-differentiators. We are confident that the little opposition which is still encountered occasionally will soon vanish before the weight of facts in favour of such conclusions.

A knowledge of the mechanism at work is a safe basis from which we may attack the second part of the problem of sex and so find an answer to the question: How does the one-X-two-X mechanism act physiologically in order to secure the differentiation of one or the other sex? The first attack upon this problem has been made by analysing a phenomenon which we have termed "intersexuality," and the main line of the facts and the analysis in question are given below.

The work was done with the gipsy-moth, in which the female is the heterogametic sex and the mechanism of the distribution of sex is perfectly normal. The phenomenon of intersexuality occurs, then, as breeding experiments show, without any disturbance of this mechanism. Intersexes—*i.e.* individuals which show definite mixtures of the characters of both sexes, and, as a whole, appear to occupy a definite position between the two sexes—are produced regularly and at will in crosses between different geographic races of the gipsy-moth. If, for example, a female of the Japanese race from Tokyo is crossed with a South European male, all the offspring are normal; in the reciprocal cross, however, all males are normal, but all would-be females intersexual. Or, again, if we cross a female of a Japanese race from Hokkaido with a male from Fukuoka, all the offspring are normal, but in the reciprocal cross all females are normal and all would-be males intersexual.

If we fix our attention, for the sake of simplicity, only on the intersexual females—*i.e.* inter-

sexes with the factorial and chromosomal constitution of a female—we may state that the majority of the different races belong to one of two categories—first, what may conveniently be termed weak races; and secondly, strong races, which are those the males of which, if crossed with the female of a weak race, produce normal males and intersexual females. In testing the different strong races at our disposal in crosses with females of any particular weak race, we find among the strong races a graded series according to "strength." The males of one strong race produce with the weak female a low type of intersexuality, individuals which exhibit only slight addition of maleness to their female constitution. Another strong race produces with the same race of females a higher type of intersexuality; still another may produce a high grade of intersexual females; while a fourth may finally transform all would-be females into males, which cannot be distinguished (except by breeding tests) from genetic males. If we test the different weak races by crossing their females with any particular race of strong males, we find again a series of degrees of weakness as shown by the lower or higher type of resulting intersexuality. From such experiments it follows that female intersexuality is produced if a female of a weak race is crossed with a male of a strong race; further, that the grade of intersexuality depends upon two variables—*viz.* the relative degrees of weakness and strength of the parental races; in other words, it depends upon a quantitative relation of what we have termed weakness and strength.

By applying breeding tests it was shown further that strength follows in inheritance the distribution of the X-chromosomes or the sex-factor. Strength must therefore be regarded as a property of the well-known Mendelian sex-factor located in the X-chromosome. What we have termed weakness, however, is inherited purely maternally. This may mean that it is transmitted within the protoplasm or the Y-chromosome, and in any event it must be equally present in every egg. All these facts show clearly that an explanation on ordinary Mendelian lines is not possible. Something has to be added to ordinary Mendelian symbolism in order to account for the facts, and this addition is the assumption that the factors in question are possessed of a definite valency which acts in a quantitative way.

The X-chromosome contains the factor for maleness, whereas the factor for femaleness is inherited maternally. The quantity of the latter is constant for each egg, whereas the quantity of the former is double in the male (XX), single in the female (X). If there exists such a normal relation that the one male quantity is less efficient than the female quantity, while two male quantities act more strongly than the constant female quantity, and, further, if it be assumed that the higher quantity controls sexual differentiation, it is obvious why normally one or the other sex is produced, although each egg might,

as experiments show, develop into a female, a male, or something between. Finally, if it be assumed that the strong races are possessed of sex-factors of a higher absolute quantity, the production of intersexuality in the crosses is also explained—the big dose of a male factor confronted as the result of crossing with a dose of the female factor which is relatively too small determines the character of the offspring even in the one-dose (X) state. As a matter of fact, all the breeding experiments devised to test such views have given results in accordance with theory.

Fortunately, the analysis of the intersexual individuals could be pushed one step further towards a physiological understanding. It could be demonstrated by a very large number of really amazing morphological and embryological facts that intersexual females are individuals which had developed up to a certain moment as females, when suddenly the sex had changed and development was finished as a male. Similarly, intersexual males begin as males and end as females, and the different types of intersexuality were proved to be the consequence of the position of the turning point in development. A late turning point means that only certain organs, which have not completed their development, can be forced into the line of differentiation of the other sex; the result is an intersex of low grade. An earlier position of the turning point consequently leads to the production of the higher grades of intersexes, and a still earlier position to the complete reversal of sex. The degree of intersexuality is inversely proportional to the position of the turning point in the progress of development. The position at this point of the analysis is this: on one hand we have the presence of characteristic doses of substances called sex-factors in definite quantities; on the other, there is a period of varying duration (the time of development up to the turning point), the length of which is proportional to the difference in the quantities of the two sex-factors. This points emphatically to the idea that the sex-factors are substances which cause, take part in, or accelerate a reaction in proportion to the quantity present. The result may then be represented in the graph (Fig. 1): on the abscissa is plotted the time of development, the line $t-t$ being the end of embryonal and larval differentiation. The ordinate indicates the amount of that product of the activity of the sex-factors which carries differentiation in the direction of one sex. The curve F shows the rate of production of the female-

determining substances, which is constant for each egg of a given race. Mm is the curve for the male-determining substances in the female (one dose; X); MM in the male (two doses, XX). In normal reproduction the F and M curves do not intersect in development. M_1m , M_2m , etc., are the curves of the male-determining substances produced by the larger quantities of M substance in the X-chromosomes of the strong races. Their points of intersection with the F curve (in the case of hybrid combination) occur during development, and represent the turning point where sex changes from femaleness to maleness. The graph then gives the physiological solution of the case of intersexuality; simultaneously it answers the question which led to the consideration of the work on intersexuality—viz. : How does

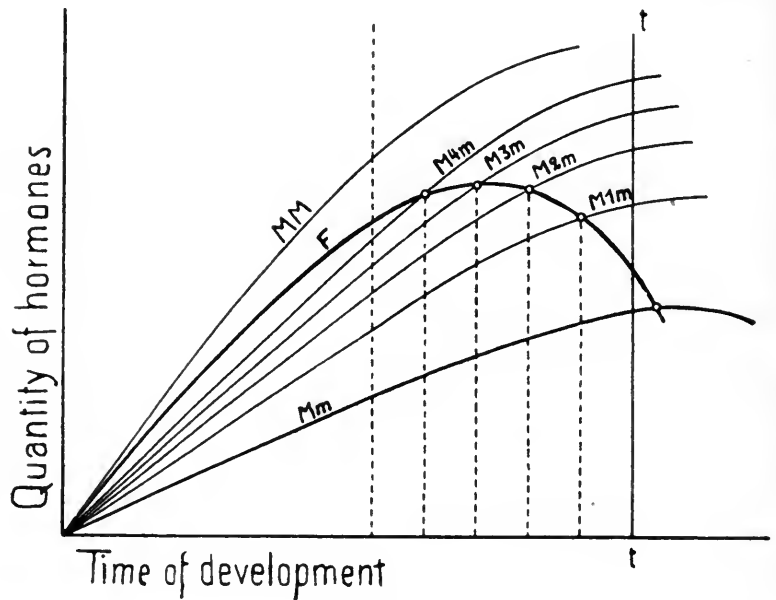

FIG. 1.

the presence of one or two X-chromosomes containing sex-factors act physiologically in order to induce the differentiation of one or the other sex? The answer is: The mechanism which produces germs with two and one X respectively is an ideal mechanism to secure the higher velocity to one or the other of two simultaneous and competing reactions, namely, the male and female reaction, by starting it with the greater quantity of reacting substance.

But there is a limit to our analysis so far as the work on intersexuality is concerned. We can see no means of ascertaining in moths in what this reaction, the velocity of which is influenced by the concentration of the reacting substances, really consists. The answer can be given, we believe, by the facts of hormonal intersexuality.

It is well known to every student of biology and physiology that in the higher vertebrates, at least in birds and mammals, the endocrine function of the sex-gland plays an important rôle in the development of secondary sex-characters.

Early castration in mammals prevents the normal development of the visible characters, and results in the assumption even of female secondary characters by male birds. Early and successful transplantation of the heterologous gonad makes either sex assume, to a more or less complete degree, the characters of the other sex (Steinach, Goodale, etc.). We might term this the production of hormonal intersexuality, but, of course, changes appear only in those organs which are able physiologically to change under the influence of hormones, irrespective of the genetic constitution in regard to sex. But the methods which have to be used exclude a complete experiment in intersexuality, where the entire body, including sex-glands, ducts, etc., must react. Fortunately, Nature has performed such an experiment for us, as the recent analysis of the case of the "freemartin," which we owe to the work of Keller, Tandler, and Lillie, has revealed. Among twin calves, cases of normal male and female are very rare. If both are not of the same sex, in most cases a normal male is accompanied by an abnormal hermaphrodite female, the freemartin. It is now known that this freemartin is a typical case of hormonal intersexuality. The authors quoted above have been able to show independently that in this case—but in this case alone—an anastomosis between the blood-vessels of the twins occurs, so that the same blood flows through both. In the male partner the testis, with its interstitial tissue, develops first, and before the ovary of the female has reached the stage of endocrine function. So the female comes under the influence of the male hormones, the ovary stops differentiation, and all the sex-characters develop in the male direction. The result is the freemartin, a calf with female external sex-organs, almost male sexual ducts, and a sex-gland containing sperm tubules which are incapable of spermatogenesis. Most interesting corroboration of this interpretation has recently been furnished in Lillie's laboratory by Minoura, who was able to produce hormonal intersexuality experimentally by transplanting gonads into developing chickens' eggs.

If we compare this case of true hormonal intersexuality with the zygotic intersexuality of the moths, we see at once that the "turning point" from which sexual differentiation changes in the intersexual moth corresponds exactly to the moment when the male hormones are poured into the blood of the female in the case of the freemartin. Comparing the facts carefully, we feel justified, therefore, in giving the following answer to our former question: What is this reaction which is accelerated by the action of the sex-substances with a velocity proportional to their concentration? The reaction is the production of the specific hormones of sexual differentiation. In insects this occurs in every cell of the body as an irreversible consequence of the combination in fertilisation. In the higher vertebrates the reaction becomes more or

less centralised within the interstitial tissue of the sex-glands.

That this solution of the problem of sex comes near the truth is rendered probable by the ease with which even the most complicated sexual phenomena fall in line with the theory. The questions of parthenogenesis and sex, sex-mosaics or gynandromorphs, sexual polymorphism, inheritance of secondary sex-characters, and the different types of hermaphroditism, all find simple solutions, or, at least, appear capable of such. This may be demonstrated in the interesting case of the Gephyrean worm *Bonellia*, well known for its extreme sexual dimorphism, the male being a rudimentary microscopic worm which lives as a parasite in the oviduct of the large female. Baltzer made the discovery that part of the larvæ, developed from fertilised eggs, become attached to the proboscis of an adult female, and live there for some time in a semi-parasitic way before developing into males. Larvæ, however, which undergo development without the parasitic stage remain for some time undifferentiated, and then develop into females. If larvæ which are fixed to the proboscis of a female are removed after a shorter or longer period, intersexes of different type are produced. Let us now suppose that we could devise an experiment to prove directly the correctness of the quantitative view of sex-determination as represented in the above graph. We might perform it successfully by finding a method of accelerating or retarding the rate of differentiation without influencing the rate of the production of the sex-hormones. In the event of success we ought to be able to shift the point of intersection of the F and M curves back into the time when differentiation was still in progress. The result would be intersexuality. It seems that *Bonellia* is able to perform this experiment by means of the excretion of her proboscis. The F and M curves of the larvæ seem to have such a relation that the male hormones are being produced quickly, and the female hormones slowly. The normal rate of differentiation is slow—so slow that sexual differentiation begins only when the phase of action of the male hormones has passed, and females are produced exclusively. The secretion of the proboscis, however, accelerates the rate of differentiation in a way analogous to the action of the thyroid in accelerating metamorphosis in amphibians. In the case of parasitism of the larvæ, therefore, differentiation takes place during the phase of action of the male hormones. Interruption of the influence of the secretion naturally causes intersexuality. Finally, we may state that recently we were successful to a certain extent in imitating this experiment with moths. By employing low temperatures we could put back the turning point for females of pure races of the gipsy-moth and thus produce intersexuality.

Ever since genetics assumed its modern form the problem of sex has been closely linked with the general problem of heredity. The Mendelian study of sex formed part of the general study of

genetic factors, while the cytological study of sex was closely connected with the chromosome-theory of Mendelian heredity. It therefore appears rather tempting to apply the quantitative views of sexual differentiation to the theory of heredity in general. Recently an attempt has been made by the

writer in "Die quantitativen Grundlagen von Vererbung und Artbildung" (Berlin, J. Springer, 1920) to attack the problem of the physiology of heredity from this point of view. A discussion of this would, however, be beyond the scope of this contribution.

Further Remarks on Relativity.¹

By SIR OLIVER LODGE, F.R.S.

III.

Changes of Frequency.

ACCORDING to the usual presentation of relativity, clocks appear to go slow to a relatively moving observer; quite irrespective of any Doppler effect, which can readily be allowed for. Their rate would have to be multiplied by the fraction $1/\beta$ or $\sqrt{1-u^2/c^2}$; which means that a clock on the sun seen from the earth, say on December 31 or July 1 when the motion is exactly transverse, would lose one second in two hundred million, or about sixteen seconds per century.

But, for testing purposes, we cannot change the motion appreciably, and so we cannot hope to tell if the clock would seem to go quicker if we stopped. Reversal of motion, even if it could be accomplished, would be no good; the difference to be observed—unlike the Doppler effect—is between motion and rest, or between rapid motion and slow, not between *plus* and *minus* motion. If we had a clock which we could fix at relative rest to ourselves, and yet be sure that it kept time with the one we were observing on some relatively moving body, the comparison might be made. And the revolution or vibration of a radiating atom, (a) on earth, and (b) on sun or star, appears to satisfy the conditions. If source and observer were moving together, there would be compensation; but if either was moving without the other, there should be an effect, such as by long accumulation might be detected. The Mercury effect allowed accumulation for a century or more. The spectrum effect does not allow any accumulation; whatever can be seen there must be seen instantly, it must depend on what happens in a single period. It is true that a certain train of waves is needed for visibility, and some succession is necessary for interference; but so short is the series required for interference that position in the spectrum is practically dependent on individual wave-length.

The value of u^2 for the earth's orbit, considered circular, is equal to the sun's gravitational potential at the earth's distance under the inverse square law, say $-V$; or twice that potential under the direct distance or centrifugal-force law. Hence the slowness to be expected, $\sqrt{1-u^2/c^2}$, may be written either $1+V/2c^2$ or $1+V/c^2$; and the second term is the displacement towards the red which is being looked for. Only, of course, it is being looked for where the potential is strongest, viz. close to the sun; for there it is two hundred times stronger than in the neighbourhood of the

earth (the radius of the earth's orbit being two hundred times the radius of the sun). It seems, however, that a small fraction of the gravitational effect ought to be produced as the result of the earth's motion, even if the sun were nothing but a central source of light.

The occurrence of the factor 2 is curious, and corresponds with a similar factor in the ray-bending calculation. But I do not now discuss it, because a spectral shift due to transverse motion is doubtful. Space-measuring rods shrink, it is true, but in the direction of motion, not in the sun's direction; so the measured velocity of light from the sun would be constant without any time-correction. Yet it is not easy to see how a clock-discrepancy can be dependent on the direction of motion, apart from the ordinary allowance for light-speed.

Changes of Inertia and Weight.

That an electric charge possesses the fundamental material quality of inertia, by reason of the magnetic field which inevitably is generated when it moves, was first calculated by Sir J. J. Thomson so long ago as 1881. That this electrical inertia is a function of speed, so that as the speed of light is approached it ought to undergo a rapid increase of value, was predicted, and its amount reckoned, by both J. J. Thomson and Oliver Heaviside. That the facts of observation were in accord with the prediction, was verified, first by Kaufmann and then by others; while that this subordinate dependence of inertia on speed applies even to neutral atoms of matter, is a consequence of the fairly ascertained electrical nature of their constitution. On the theory of relativity the variation of inertia appears to follow, without any electrical theory at all, as a result of changing the frame of reference to moving axes. The additional mass corresponds to the kinetic energy of the moving matter divided by c^2 . Which suggests that the whole mass is probably a demonstration and a result of fine-grained ætherial rotational energy with velocity c .

It is legitimate, anyhow, to assume as a working hypothesis that the mass of a body is not really constant, but that at the speed u it becomes $m = \beta m_0$ or $m_0/\sqrt{1-u^2/c^2}$.

The speed necessary to display this effect is usually attained only by electrons and positive nuclei in a vacuum tube, or by aid of spontaneous radio-activity; but the refinements of astronomy are so great that the planet Mercury is moving fast enough to exhibit some result dependent on

¹ Continued from p. 751.

this variation of inertia, if it were allowed to accumulate for a century. If the speed were constant it could not be detected; but the speed is not constant. The orbit is elliptical, for one thing; and the solar system is in motion, for another. Sometimes, therefore, the solar drift will be added to the orbital speed of Mercury. sometimes it will be subtracted from it.

Here then is a definite problem: to trace the consequences of this variation of inertia on the form or details of its orbit; and this problem I attacked in the *Philosophical Magazine* for August, 1917, and found that it must lead to a cumulative apsidal revolution unless there were some compensating cause. The paper was followed up by Prof. Eddington in September and October 1917 and June 1918, by Mr. G. W. Walker in April 1918, and by myself again in December 1917 and February 1918.

We found that if the solar drift were sufficient, both in magnitude and in direction, to give the proper value for the perihelion progress of both Mercury and Mars—as it easily might be—a smaller effect could not be denied to some of the other inner planets; and there would be accompanying small eccentricity changes, not corresponding with observation. The best solar drift is one with the speed $1.7 \times 10^{-4} c$, and longitude 173° , for its component in plane of ecliptic. This will suit Mercury, both for apsidal revolution and for eccentricity. The perturbations that ought theoretically thus to be caused in the other inner planets are tabulated below; and, to compare with these calculated values, the table gives also the actual estimated or observed outstanding secular variations per century, both for the perihelion progress, $d\bar{\omega}$, and for the change of eccentricity, de . (See *Phil. Mag.*, February, 1918, pp. 148 and 154.)

Outstanding Perturbations per Century.

Solar drift assumed: Speed, $1.7 \times$ earth's orbital vel. Direction, 173° long. and 0° lat.	Calculated.		Observed.	
	$d\bar{\omega}$	de	$d\bar{\omega}$	de
	"	"	"	"
Mercury	+8.34	-0.91	+8.48	-0.88
Venus	+1.46	+1.52	-0.05	+0.21
Earth	+1.04	+0.32	+0.10	+0.02
Mars	-0.12	-0.46	+0.75	+0.29

The discrepancies between theory and practical estimate, though small, are considered to be beyond anything that can reasonably be attributed to errors of modern observation; and if that is the final verdict of astronomers, after reconsideration of the figures, it becomes a question what is the compensating cause that prevents fluctuations of inertia from taking effect. The only cause that has suggested itself is a variation in the Newtonian gravitation constant, due to its being a function of velocity; so that weight is modified, somewhat in the same sort of way as electrostatic forces are modified, by rapid motion. (*Phil. Mag.*, February, 1918, p. 156.)

able book, "Space, Time, and Gravitation," p. 125) that the result of the whole discussion is to prove that gravitation has "joined the conspiracy," and has succeeded in concealing any effect of uniform motion.

But, on Eddington's improved theory (*Phil. Mag.*, October, 1917), it achieves this result in an odd way, and apparently does not sustain Einstein's "Equivalence" thesis, that inertial mass and gravitational mass are the same in all circumstances; or, briefly, that weight is always proportional to mass. Some caution is here required; for the proportionality of weight and inertia seems to be interfered with at high speeds. Their product, not their ratio, appears to be involved in a planetary perturbation, regarded from the point of view of the electrical theory of matter; and hence, if one increases, the other must decrease.

Galileo's experiment on the Tower of Pisa, roughly, and Newton's pendulum determinations, more exactly, established the proportionality of mass and weight; and recently Prof. Eötvös, followed by Prof. Zeeman, has confirmed Newton's conclusion to a high degree of accuracy, so far as ordinary circumstances and slow motions are concerned. (See the excellent new edition of Clerk Maxwell's wonderful little book, "Matter and Motion," brought out last year by Sir Joseph Larmor (S.P.C.K.), pp. 34 and 143.) But the astronomical evidence cited above seems to require that the Newtonian gravitational constant shall diminish at high speeds, being multiplied by the factor $1 - u^2/c^2$. Only thus can it compensate the inevitable increase of inertia $(1 - u^2/c^2)^{-1}$; at least if the increase of inertia sustains its full increment of weight. If the increase of inertia due to motion is *not* subject to gravity, then $\sqrt{(1 - u^2/c^2)}$ will suffice as the factor of the gravitation constant. (*Phil. Mag.*, February, 1918, pp. 143, 145, 155.)

Assuming that so it will turn out, after further detailed scrutiny, it is clear that weight is affected by high-speed locomotion. For the increased mass of a fast-revolving planet would by itself undoubtedly cause a minute apsidal progression sufficient to be observed; and the fact that for several of the inner planets the outstanding perturbations are less than the calculated, shows that compensation must somehow occur. It is to be hoped that the peculiar nature of the compensation, here suggested, may ultimately throw light on the gravitational structure of the æther. Meanwhile, unless some error is detected, it appears in conflict with the universal proportionality of mass and weight.

We shall now proceed to a few remarks on points connected with the more general theory of relativity.

ERRATUM.—In the first article of the present series (NATURE, August 4), on p. 718, 1st col., l. 6 of 2nd para., delete the words "in v if it is opposed to u "; and substitute "when the observer reverses his motion."

(To be continued.)

Prof. Eddington has now agreed (see his admir-

Cohesion.

By DR. HERBERT CHATLEY.

WHEN one turns from an account of the discovery of a "dark star" by celestial dynamics to an investigation of the properties of the excessively minute whirling electrons in an atom, the impression is gained that within these limits at least there is but little more than relatively unimportant detail to learn. Such a notion is quite erroneous. More is known of the mechanism of plants on one hand and of electrons on the other than of the most ordinary and apparently simple mechanical phenomena. The most expert physicist can make only a near guess as to the motion of a billiard ball under given conditions as to stroke, weight, etc., since there is an imperfectly known factor, friction, in the problem. Similarly, although he can calculate with great precision the force with which one piece of iron attracts another when they are a foot apart, he cannot say with any accuracy from first principles what is the tensile strength in each piece of iron. Engineers similarly have made countless experiments and have also obtained very many data from constructional experience which give average values from which, by allowing a liberal margin for uncertainty, structures can be safely designed; but that is all.

Doubt still prevails as to the nature and laws of the force or forces causing cohesion. Lord Kelvin concluded that Newtonian gravitation would explain cohesion if it be supposed that the particles are exceedingly close. Sutherland and Nernst have regarded cohesion as identical with chemical affinity, and therefore with electrostatic force. Tolver Preston believed it was due to some mysterious dynamic action arising from the oscillation of the particles. Crehore, an American physicist, deduces it from a residual electromagnetic effect of the omnipotent electrons. Most recent students, following Sutherland, regard it as a residual electrostatic effect of the opposed charges in the atoms which, although in electrical equilibrium, are not coincident in space; some, however, prefer to consider it as largely electromagnetic.

The only satisfactory method of commencing a scientific investigation is to state all the known particulars and formulate hypotheses on the basis of the apparent facts. Proceeding so, we may note that:—

(1) All solids, being such, cohere to an extent which changes with their composition, physical structure, and temperature. Broadly speaking, cohesion varies with density and decreases with increase of temperature. It is quantitatively of the order of one millionth of a dyne per molecular pair.

(2) The range within which cohesion is effective is very small, not greatly exceeding one mole-

cular diameter. Two pieces of material when pressed together cohere only when great force is used, if they are very highly polished or if they are so soft that they readily interpenetrate. Solids, with very few exceptions, break by tension when stretched 25 per cent. of their length, implying that the particles need to be separated only by less than one-and-a-quarter times the usual distance from centre to centre for cohesion to become inappreciable. Even the exceptional substances, such as rubber, break when stretched but little more than twice their length, and do not change much in volume. Solids at the fusing point become liquid with negligible change of temperature and only from 5 to 10 per cent. increase of volume.

(3) Solids in general, with the exception of the so-called plastic materials, extend with tension and shorten with compression proportionately to the force employed within certain "elastic limits," and are stable within those limits. The volumes increase slightly up to the elastic limits.

(4) Beyond the elastic limits the tensile and compressive strengths increase but slightly, and when the strain (extension or compression) becomes appreciable the strengths decrease.

(5) Liquids and gases show a slight "molecular pressure" or internal attraction, varying approximately as the inverse fourth power of the distances between the centres of the molecules.

It should perhaps be pointed out that an inconsistency is involved in the notion of "failure by compression." It is obvious that compression can do nothing but bring the particles into closer proximity, and if lateral expansion is prevented ultimate failure is inconceivable unless there are internal voids. Ordinary compression causes failure either by oblique sliding ("shear") or by lateral expansion.

It is required, then, to find a force which has no external resultant under natural conditions (save perhaps the normal gravitational attraction), resists tension and compression proportionately to the displacement of the particles for small ranges, and has but a limited power to resist tension which ceases at a moderate range and a great power of resisting compression. It is difficult to conceive of one force having all these properties, but perfectly simple to imagine an attraction and repulsion combined that will do so, provided that *the attraction decreases more slowly with separation than the repulsion*. A series of papers by the present writer to the Physical Society of London (1915-19) and a paper in the *Phil. Mag.* (August, 1920) attempt to deal with the problem on these lines. When the solid is at rest the attractions and repulsions balance. If a tensile force is applied the particles are separated, but since the attrac-

tion diminishes less rapidly with separation than the repulsion, there is a surplus of attraction which provides a tensile resistance. If the applied force is increased, the resistance will also increase up to a certain value, depending on the rates at which the attraction and repulsion respectively change. Further strain causes failure. On the other hand, if a compressive force is applied the particles are brought together and there is a surplus of repulsion which, like the surplus of attraction, varies with the amount of the strain, but differs in that it may be indefinitely great for very high proximity of the particles.

As to the rationale of the process little can be said. The dynamic energy of the oscillating particles and the consequent rigidity of the atoms and molecules seem to provide a kinetic basis for the repulsion. As is well known, most solids contract when they lose heat, and, since heat is electronic, the fact that most solids increase in cohesion when cooled would be quite consistent with atomic and molecular oscillation or rotation, provided that such motion is the cause of repulsion.

Whether the attraction is electrical, chemical, dynamic, or unique is not fully determinate, but since there is a fairly consistent hypothesis in terms of electrical theory, a bias in that direction is natural so long as no practical objections occur. Kelvin's gravitative theory seems to be baseless, for it leads to inconsistent results when the actual spacing of molecules is considered; but there is no intrinsic objection to an hypothesis which would make gravitation the residual of cohesive attraction. The writer has developed an empirical

formula on these lines which gives a continuous expression for cohesion and gravitation. Newton's great discovery was that gravitation varies as the product of the masses concerned divided by the square of the distance between their centres, and the success of this law in explaining the motions of the heavenly bodies proves with overwhelming certitude its accuracy for all distances but the smallest, and possibly also the enormously great. When, however, the distance is comparable to the usual distance between the centres of the atoms or molecules in a solid a strong doubt as to the applicability of Newton's law arises, for it would appear that when two molecules are separated to twice their usual distance in a fluid the mutual attraction in the second position falls away much more rapidly than Newton's rule implies, and the attractions are quantitatively enormously greater. We may of course suppose, as did Sutherland, that gravitation has nothing to do with cohesion, but this does not satisfy the craving for continuity.

Here, then, is a field for investigation of the highest practical importance. If cohesion can be properly connected to other physical properties it is conceivable that new compounds of great strength, due to a critical state of cohesion artificially produced, would be found. Chemistry, crystallography, metallurgy, and engineering would all benefit by such an advance in knowledge of the ordinary properties of matter. Somewhat paradoxically it would appear that a complete solution of the macroscopic properties of matter would also solve the question of the inner structure of the molecules and atoms.

International Conference of Chemistry.

THE International Conference of Pure and Applied Chemistry held at Brussels at the end of June was nominally the second of these conferences, that at Rome in 1920 being the first; but there were at least two earlier assemblies in London and Paris which led up to the organisation, which seems now to be firmly established.

More than twenty countries are included in the organisation, Germany, Sweden, and Austria being the principal ones which are not yet represented. A number of well-known chemists took part in the conference:—Prof. Chavanne, Crismer, Swartz, and Timmermans (Belgium), Billmann (Denmark), Conant and Mackall (United States), Moureu, Béhal, Matignon, and Urbain (France), Pope and Lowry (England), Garelli and Nasini (Italy), Halvorsen (Norway), Holleman and Kruyt (Holland), Guye and Pictet (Switzerland), and several representatives of industrial chemistry, including M. Kestner, to whose energy and determination the organisation is so much indebted.

Each of the countries concerned has a council corresponding to the British Federal Council for Pure and Applied Chemistry, and the various national councils appoint members of the Inter-

national Council and send in addition delegates to the annual conferences. So far as Great Britain is concerned, the Federal Council has invited its president, Sir William Pope, Prof. Philip, Dr. M. O. Forster, Mr. E. V. Evans, and the two honorary secretaries, Prof. H. E. Armstrong and Dr. Stephen Miall, to serve on the International Council for the next three years.

The work of the International Conference is divided among a number of commissions dealing with specific subjects or proposals of an international character. Among these the Commission on Chemical Elements will replace the former Commission on Atomic Weights. It was felt that the exact determination of atomic weights and their publication to several places of decimals has now lost a good deal of its scientific significance in view of the work of Dr. Aston and others, and that exact atomic weights are now becoming factors of analytical calculation rather than features of a chemical hypothesis. The isotopes or atomic numbers are taking the premier place, and the atomic weights—often representing merely the average of a mixture of isotopes—will be of practical rather than theoretical interest. The

commission has therefore enlarged its jurisdiction, and will publish the constants of atomic weights, isotopy, and radio-activity; moreover, instead of being composed almost exclusively of analysts of exceptional ingenuity and manipulative skill, it will include recognised experts on isotopes and atomic pedigrees.

The questions of international nomenclature, contractions, abstracts, and standards were discussed and reports adopted, but the main work on most of these topics is still to be done, and the various committees appointed to consider these matters have a huge mass of detailed investigation before them. In connection with abbreviations in chemical literature Dr. Pondal made the gratifying announcement that the Argentine Chemical Society would bear the necessary expenses.

A list of pure research chemicals manufactured in Great Britain was submitted by the Association of British Chemical Manufacturers, and a further list containing many additional products is in course of preparation. M. Marie, whose name is well known in connection with tables of constants, submitted a report on this subject.

A commission was appointed to consider international patents, and its work is not yet completed. It appears that a considerable mass of evidence is necessary before a report can be drafted, and it is hoped that those who have given consideration to this problem will communicate

with the Federal Council for Pure and Applied Chemistry at the offices of the Chemical Society at Burlington House.

The question of industrial hygiene is coming into prominence, and a commission was appointed to deal with this subject. During recent months papers on industrial hygiene have been read before the Society of Chemical Industry, the Royal Society of Arts, the British Medical Association, and other societies, and the hygiene section of the International Labour Office constituted by the Treaty of Versailles has undertaken an immense task in relation to diseases of occupation. It is time the whole question was examined scientifically and carefully, but the problem is one of considerable complexity. Very few of the medical experts have accurate knowledge of the chemical and engineering factors involved, and but few of the manufacturers or employees most concerned are able to form a sound judgment from a perusal of the pamphlets written by experts maintaining with no little heat their various opinions. If the international commission can study the problem so far as it concerns industrial chemistry, it will perform a most useful and timely service.

It has been decided to hold the next conference of the International Union in France, and there is a suggestion to have the meeting at Lyons, which will be a very convenient locality for most of the countries concerned.

Obituary.

PROF. G. LIPPMANN, For.Mem.R.S.

FRENCH science has suffered a very great loss in the person of Prof. Gabriel Lippmann, who died at sea on July 13 while returning from Canada, where he had taken part in the mission of Marshal Fayolle. Prof. Lippmann was born in 1845 at Hollerich, in the Grand Duchy of Luxemburg, of French parents, who soon after his birth settled in Paris. He passed through the higher normal school, and devoted his life to teaching and research. He became professor of physics at the Faculty of Sciences in Paris in 1878 and director of the laboratory for physical research at the Sorbonne in 1886, and was elected a member of the Paris Academy of Sciences in the same year. Of an original and independent mind, Prof. Lippmann left his personal mark on all questions he touched. The philosophical and general side of scientific conceptions claimed his attention particularly, and he saw clearly the connecting links between differing phenomena. His work on electro-capillarity dates from the time when electricians began to see the power and flexibility of the new instrument. He saw at a glance the future of electricity. Every physicist knows his capillary electrometer and the connection he established between the constant of Laplace's formula and the potential difference: but he showed as well how mechanical work could be obtained from an electro-capillary motor. At the time he made these discoveries and stated the principle of the conservation of electricity he pub-

lished other work in which he played the rôle of pioneer. In his note in the *Comptes rendus* of the Paris Academy of Sciences for 1875 on the properties of an electrified water surface, he earthed a mass of water by a wire ending in a Wollaston electrode, and showed that if a stick of rubbed resin was brought near, oxygen was set free at the electrode, while hydrogen remained in solution. Ostwald, in his "General Chemistry," begins his treatment of ionic theory with a description of this experiment. On the publication of Rowland's discovery Prof. Lippmann showed, in June, 1879, that the phenomena ought to be reversible and that electricity ought to have inertia. This idea of reversibility was a frequent subject of his thoughts, and he often reverts to it in his celebrated treatise on thermodynamics. Prof. Lippmann also published in 1889 some calculations on induction in resistance free circuits, which twenty years after were confirmed by the experiments of Prof. Kamerlingh Onnes. In 1891 he communicated to the Academy of Sciences the principles of the discovery with which his name is immediately associated: that is, colour photography by interference. The accurate solution of the problem of the reproduction of colour is thus obtained from the thin laminæ which had such an attraction for the mind of Newton. Prof. Lippmann was a man of few words. So long as he was unable to give to a problem a form which would lead him to a

solution satisfactory to himself, those who knew him little might believe him indifferent. He would gather himself together, and in a few words would show how far his thoughts had taken him into the fundamentals of the subject. During the last year of his life he devoted much attention to relativity, and on his last voyage from Havre to New York he spent most of his days discussing it with Prof. Michelson. The work Prof. Lippmann leaves behind him is of capital importance; but it represents only a part of the thoughts of a man of science with views acute and deep whom the search for perfection and a reserved temperament kept far from noise and strife.

CAPT. W. E. ROLSTON.

THE sudden death, on August 9, at forty-five years of age, of Capt. W. E. Rolston will be greatly regretted by many old students of the Royal College of Science, South Kensington, where he received his scientific training. Capt. Rolston was the founder and managing editor of the *Cologne Post*—the admirable daily paper published by the British Army on the Rhine—but he was well known in astronomical circles by his work with Sir Norman Lockyer, and at Cambridge. He entered the Royal College of Science as a Teacher in Training, and for about a year assisted in the demonstrations in the course of astronomical physics there, gaining also some experience in solar physics work. In 1899 Rolston took up a teaching post, but returned again to the Solar Physics Observatory at South Kensington in 1901, and remained on the staff of the observatory until he joined the Buffs in 1915. He was with Sir Norman Lockyer for twelve years before the transfer of the observatory to Cambridge in 1913, where he continued to be a member of the staff.

After some preliminary work in the general routine of the observatory, Rolston became mainly responsible for several specialised branches of the investigations in progress. One of the most important of these was an attempt to apply the principles of Stokes's Law of Radiation to the determination of the relative temperatures of stellar atmospheres. A fundamental feature of Sir Norman Lockyer's Kensington classification of stellar spectra required the recognition of different temperature levels, and to investigate this a special prismatic camera, with quartz-calcite optical train, was obtained and mounted on one of the equatorial telescopes. Pairs of stars were photographed on the same plate under conditions as nearly identical as possible, with controlled exposures designed to give equal photographic intensity for the region H_{β} - H_{γ} . By then measuring the relative intensity of the red and violet regions respectively, it was possible to arrange the various spectra in order of temperature level. These observations extended over about three years, and the results were communicated in a paper to the Royal Society in 1904 on the "Temperature Classification of Stars." In addition to taking a share in

the observational routine work, both day and night, on solar and stellar spectra, Rolston repeated much of the reduction work on old observations of widened lines in sunspot spectra, and brought the summaries up to date.

From 1907 to 1912 Rolston was chiefly occupied with the reduction of orientations, and with stone circles and temples in various parts of the world, these being regarded as having originally been designed by their constructors to serve for the determination of time and season in the regulation of the economic and religious life of the early communities. The results of these researches were extremely suggestive, and were communicated by Sir Norman Lockyer to the Royal Society.

During the last two years before the transference of the observatory to Cambridge Rolston was engaged in preparing a comprehensive account of the observations of novæ from the discussion of all available material, and this was published as a separate volume entitled "Phenomena of New Stars." After transference to Cambridge he took charge of the Huggins spectroscopic equatorial, and also assisted in the reductional work on stellar spectra.

Throughout his connection with the Solar Physics Observatory Rolston took great interest in the dissemination of scientific knowledge, and was most successful as a writer and as a popular lecturer. For a number of years before the war he wrote the notes for *Our Astronomical Column*, and also contributed numerous articles and reviews. The experience thus obtained was turned to excellent account when in March, 1919, he founded the *Cologne Post*, the unique daily newspaper which has had such valuable influence in revealing British thought to Germany. His success showed the value of a scientific training to business management and literary balance, and the frequent articles and notes on scientific and educational subjects published in the columns of his journal commanded both attention and respect. Rolston was, indeed, a man of sterling worth and sound knowledge, and all who knew him will deplore that he has been taken from them in the prime of life.

SAMUEL ALFRED VARLEY.

By the death on August 4 of Mr. S. A. Varley, at eighty-nine years of age, we have lost almost the last of those pioneers who were associated with the application of electricity. A younger brother of the late Cromwell Varley, F.R.S., and an early student and disciple of Michael Faraday, Mr. Varley was a notable inventor even comparatively early in life, when in the service of the Electric Telegraph Company. His name and fame will always be especially associated with dynamo-electric machinery, the first example of which he produced in 1866. This was a self-exciting machine with soft iron magnets. Ten years later Mr. Varley patented the original compound-wound dynamo. This afterwards became the subject of litigation, when Mr. Varley's claims

to priority were in the end completely established. The machine may be seen amongst the historical apparatus at the South Kensington Museum. His other inventions included a lightning protector for telegraph lines and cables, a polarised needle telegraph instrument, and the time-ball as now used at Greenwich Observatory and elsewhere.

Mr. Varley, following Lord Kelvin, contributed a highly useful paper, in 1858, to the Institution of Civil Engineers on the electrical qualifications requisite in long submarine telegraph cables, as well as another on the same subject to the Society of Arts. In setting forth here the true electrical qualifications for the working of a submarine cable, he showed in a very convincing way that conductor resistance was as much a factor in retardation as induction. He was the son of a famous artist, Cornelius Varley, and was one of a famous family of electricians. C. B.

It is with much regret that we have to record the death of M. JULES CARPENTIER on June 29. M. Carpentier was born in 1851, and received his education at the Ecole Polytechnique. In 1876 he entered the service of the Paris-Lyons-Marseilles railway as assistant constructional engineer, and would probably have developed his genius for machine construction in the service of the railway had not the death of Ruhmkorff directed his attention to the design of electrical apparatus. He took over Ruhmkorff's workshops, reorganised them, and commenced to manu-

facture standard electrical apparatus suitable for the measurement of the heavy currents necessary for the application of electricity to industry. Amperemeters, voltmeters, electro-dynamometers, and other apparatus associated with the names of d'Arsonval, Marcel Deprez, and Baudot were in a large measure developed and made practical instruments by the genius of Carpentier. His activities did not end with electrical instrument-making, for his name is also associated with three-colour photography, while during the war his workshops turned out a number of periscopes for use on submarines. M. Carpentier was elected a free member of the Paris Academy of Sciences in 1907, where he represented the mechanical arts and the manufacture of instruments of precision.

THE death occurred on August 13, at the age of sixty-five years, of SIR ALFRED W. W. DALE, late vice-chancellor of the University of Liverpool. Sir Alfred was educated at King Edward's School, Birmingham, and Trinity Hall, Cambridge. For twenty years he was lecturer, bursar, and tutor of his old college, during which time he established for himself a reputation as an able administrator of university affairs, as well as a classical scholar. In 1899 he was appointed principal of University College, Liverpool, and when Victoria University was dissolved in 1903, and its separate colleges assumed university rank, he became the first vice-chancellor of Liverpool University, retaining this post until 1919, when he was succeeded by Dr. J. G. Adami.

Notes.

THE local secretaries of the British Association for the Edinburgh meeting desire to contradict the statement which appears to be current in some quarters that the hotels and boarding-houses of Edinburgh are fully booked for the period of the meeting. There is plenty of accommodation vacant in certain hotels, in boarding-houses, and in apartments; and in one of the hostels—a modern hall of residence—fifty places are still available for the accommodation of members. The Secretary for Hotels and Lodgings, the University, Edinburgh, will be glad to answer inquiries. Members who write to hotels and boarding-houses direct should enclose a stamped addressed envelope for reply.

THE outbreak of smallpox in Nottingham is at present kept within bounds by the incessant work of the medical and civic authorities. The trouble is that Nottingham has been for some years a hunting-ground of "anti" people. Still, we may be fairly sure that Nottingham will not suffer the fate of Gloucester, where 279 unvaccinated children died of smallpox in 1895-96. But there is always this difficulty, that vaccination in early childhood, though it may fail to give complete protection against smallpox some years later, may so modify the attack that the case is mistaken for chicken-pox. This mistake must be reckoned as well-nigh inevitable, now that

smallpox is so rare that many doctors have never seen a case of it. The annual report (1920) of the Scottish Board of Health contains a good summary of the Glasgow epidemic last year. It is the old story: that the general neglect of vaccination in childhood is bringing about a reversion to the original habits of the disease. Smallpox naturally prefers children under ten years of age: and now it gets them. Of course we all know that vaccination is not a perfect method; we all hope for a perfect method; we all would like to get rid of the calf, to be able to use a non-living vaccine, exactly standardised; a hypodermic dose, and no scratching of the skin. Some day, surely, this perfect method will be worked out. Meanwhile we all know what would happen if it were possible to take a school of 200 small children, to vaccinate 100, to leave 100 unvaccinated, and then to expose the whole school to smallpox. Even the anti-vaccinationists know what would happen. The present writer put this view of the disease to one of them, and he answered that God would interfere in favour of the unvaccinated children: a fool's answer. Two cases of smallpox have just occurred in Huddersfield (*Times*, August 11). Let us hope that vaccination of contacts, quarantine, and other sanitary measures will prevent the spread of infection. Probably we shall

have other outbreaks of the disease this autumn and winter.

It is the intention of the Rockefeller Foundation to publish from time to time a circular of information reviewing its activities, and the first number was issued on July 25. A million francs was voted towards the endowment of La Fondation Reine Elisabeth, a new institution for medical research established in connection with a hospital in the suburbs of Brussels, while three million dollars have also been allocated to the Brussels authorities for medical education. Reference is also made to the grants of five million dollars each to Canada and to University College and Hospital in 1919 for medical education. Support has been given to several medical schools in the United States, contributions have been made towards campaigns against malaria, yellow fever, hookworm disease, and tuberculosis, and emergency relief of a million dollars has been contributed to the fund for European children. In addition, the Medical School in Peking has been maintained and aid given to thirty-one hospitals in China with the object of increasing their efficiency.

In the June issue of *Folk-lore* Mr. R. Grant Brown discusses the pre-Buddhist religion of the Burmese. It is not confined to the animistic beliefs which were possibly introduced with the so-called "corrupt" Mahayamist or northern form of Buddhism, which, to a far greater extent than the southern form which now prevails, incorporated the ancient beliefs and ceremonies of the people. The animism which now widely prevails is quite apart from Buddhism, and though Burmese Buddhism is in one sense only a veneer over the prevailing animism, it is not more superficial than the state of belief even in Western countries. It is frowned upon by the monks, yet not only do the votaries of the orthodox creed refrain from persecuting the beliefs and practices of the lower orders, but also both forms prevail even among the same individuals. A good example of this form of worship is that of the Nats, spirits of mountain, whirlpool, tree, earth or sky, rain or wind, and a hundred other things. Human sacrifice is still found in the Chindwin district, when a boy or a girl of a distant village is annually sacrificed and the blood sprinkled on the seed-rice. Cannibalism, in the sacramental form, appears in the case of a rebel leader who had been a monk and a reputed sorcerer; he was killed, his body dug up, and the flesh boiled down into a potent decoction. Mr. Brown's account of these and similar practices is interesting for comparison with customs of the same class prevalent in the lower cultures of some tribes in the Indian Peninsula.

THE Pennsylvania University Museum has recently acquired a copy of a rare book, "A Catalogue of Specimens of Tapa or Bark Cloth," illustrated with samples of the cloth collected by Capt. Cook during his three voyages. The book was published in London in 1787, and contains, besides the catalogue and specimens of tapa, "A Particular Account of the Manner of Manufacturing the same in the various Islands of the South Seas: partly extracted from Mr. Anderson and Reinhold Forster's Observations, and the verbal

Account of some of the most Knowing of the Navigators: with some Anecdotes that happened to them among the Natives." The list describes thirty-nine specimens, whilst this copy contains forty-three, four samples having apparently been added since the book was originally published. The *Museum Journal* for March, 1921, reprints the catalogue, with useful notes and descriptions of the method of preparing tapa cloth.

"THE *Rôle* of Meteorology in Malaria" is the subject of a paper by Brevet Lt.-Col. C. A. Gill (*Indian Journ. Med. Research*, vol. viii., No. 4, 1921, p. 633). Col. Gill finds that whilst humidity exercises no direct effect on the malaria parasite in the mosquito, the survival of infected insects during and beyond the incubation period of the parasite in its insect-host is dependent upon the occurrence of certain favourable degrees of relative humidity over a wide range of temperature. On the other hand, the completion of the developmental stage of the parasite in the mosquito is determined by the association of relatively high temperature with relatively high humidity. The meteorological circumstances favourable to mosquito life and to the transmission of infection are thus not identical, and no relationship need, therefore, exist between the distribution of the carrier insect—the mosquito—in Nature and the distribution of endemic malaria.

DR. R. J. TILLYARD deals with the Neuropteroid insects of the Hot Springs region of New Zealand in relation to the problem of trout-food in vol. iii. of the *New Zealand Journal of Science and Technology* (Nos. 5 and 6, 1921). Observations made in various parts of the world, as well as in other regions of New Zealand, show that the larvæ of caddis-flies form one of the most important foods for the trout. In the district under consideration Dr. Tillyard states that the depredation caused by excess numbers of trout has enormously reduced the original fauna of these and other Neuropteroid insects which serve as food for this fish. In fact, the present position of the trout-fisheries in the Hot Springs region is such that there is not enough food for the trout present. It is clear that improvements can be effected along two distinct lines, viz. improvement of the food-supply and reduction in the number of trout. A series of recommendations is made by Dr. Tillyard in order to achieve this end.

THE annual report of the Gresham's School Natural History Society for 1920 is an interesting and valuable record of the work done by a school society which is active and keenly alive to the importance of regional survey work. There are records of plants new to the district round Holt, of the insects collected by various members, of astronomical phenomena observed at the school, and of the first appearance of migratory birds in the neighbourhood. The most interesting record among insects is that of the first fully winged specimen of the Hemipteron, *Nabis boöps*, ever taken in Britain, captured by G. E. Hutchinson at Tidworth Pennings. One of the members, C. E. G. Bailey, has perfected and patented a self-tuning wireless apparatus which should prove valuable in expediting the work of wireless operators

in synchronising their apparatus to that of the transmitting section.

BULLETIN 702 of the United States Geological Survey contains information on the oil possibilities in and around Baxter Basin, Rock Springs Uplift, Wyoming, and is the work of A. R. Schultz. Little work has hitherto been carried out in this area, although geologically it has long been favoured as a likely field, but latterly active interest has been taken in its development, and consequently the presentation of this official report is of much importance. The Rock Springs Uplift consists of an enormous dome of Cretaceous and Tertiary strata rising in the middle of the horizontally bedded rocks of the well-known Green River Basin, the dome itself being much warped into minor folds; Baxter Basin is situated in the central part of this dome, and consists structurally of a broad eroded anticlinal involving the Mesaverde, Blair, Baxter, Frontier, and Aspen series (in descending order) of Upper Cretaceous age, with probable representatives of much older formations. Oil occurs at several horizons, but the Frontier series, the principal oil-bearing series in Wyoming, lies at a depth of some 5000 ft. below the surface, which is almost the limit here for drilling. In addition, there are the extensive deposits of oil shale, the Green River formation of Tertiary age, surrounding the central area of the Rock Springs dome, and development of these should prove successful. Recent drilling on the Baxter Basin anticline has been carried out with promising results, mainly by three companies, small quantities of oil and a flow of gas at several hundred pounds pressure being obtained. This is a field of which we shall undoubtedly hear more in the course of time, and the Geological Survey officers are to be congratulated on the large amount of valuable preliminary information here published as an aid to its development.

In Bulletin 713 of the U.S. Geological Survey (1920) there is an illustration of a recumbent cedar in vigorous growth, a member of a grove of similar habit on a wind-swept slope in Idaho. Physiographers and students of forestry will like to compare it with the drawing of *Pinus montana* in its climbing attitude in Brunhies's "Le Parc National Suisse" (NATURE, vol. cvi., p. 466).

We have recently received a copy of part 3, vol. xl., Mem. Geol. Surv. India, by E. H. Pascoe, dealing with the occurrences of petroleum in the Punjab and North-West Frontier Province, which, though somewhat belated owing to the war and other circumstances, makes a welcome appearance just when first-hand information concerning our Imperial oil resources is required. The main petroliferous region occupies a belt flanking the Himalayas and traceable westwards from Simla, though it is not clearly defined until the division of Rawal Pindi is reached; it extends for 140 miles across the Indus through Kohat and Bannu and southwards into Baluchistan. The altitude of this belt suggests relationship to two distinct systems of tectonic movement: that of the Himalayas to the east, with their north-west to south-east trend in this region, and that of the Afghanistan-Baluchistan system to the west, a somewhat complex series of

tectonic elements with a general curving strike from north to west, here recognised as the Attock arc. The belt lies in the re-entrant between these two systems, and occupies the site of an ancient river valley (Indobrahm), much in the same way as the petroliferous belts of Burma and Assam are coincident with ancient river-courses. Geologically the belt is divisible into halves, a northern and a southern, separated by a broad synclinal area. The northern half embraces the occurrences of oil around Rawal Pindi, in the Kala Chitta Hills, at Khaur, and in the trans-Indus salt area; the southern includes those of the salt range with the seepages of the Khasor Hills. Structurally the oil and gas are associated with anticlines involving rocks of Nummulitic or Muree age, the trend of these anticlines conforming to the main tectonic features existent at the particular locality at which they occur. Although the occurrence of petroleum in this part of India has been known of for many years, exploration has not met with unqualified success save in the case of the Attock Oil Co., which has carried out developments at Khaur. The oil obtained at Khaur varies in specific gravity from 0.894 to 0.876 in the upper sands, and from 0.877 to 0.840 in deeper sands, and is generally darker in colour than Burmese oil. The author regards the origin of the oil in this region as doubtful, though it would seem to be indigenous to the Nummulitic beds, its occurrence in the overlying Muree beds being probably due to upward migration.

THE subject of climatic conditions on the principal air routes in the East Indian Archipelago has been recently dealt with by Dr. C. Braak, of Batavia. Dr. Braak is of opinion that from an international point of view the air route from Singapore to Port Darwin is the most important. Relative to the different conditions in the tropics and in temperate latitudes, he asserts that in the tropics higher temperature at the surface is responsible for lighter air for aeroplanes at the start, but the wind conditions are said to be strongly in favour of the tropical climate. Cyclones are rare in the Archipelago, their occurrence being limited to the month of April and to the late days of March and early days of May, whilst there is usually only one in each year. The variability of wind direction is relatively small, and the wind variations are principally reinforcements and weakenings of the monsoons. A feature favourable to aerial navigation is stated to be the well-marked and very regular daily variation in most of the meteorological factors, so that choice can be made of the time of day that affords the best flying conditions. Details are given of the surface winds, as well as of the air movement in the higher levels. Monthly rain measurements and the number of rainy days are tabulated for many places within the area. The distribution of rainfall over the day is shown, as are also frequency of thunder, relative cloudiness, and haziness. It is stated that when comparison is made with the climatic conditions in temperate latitudes the conditions in the Archipelago may be called rather favourable.

In the Bulletin of the Central Meteorological Observatory of Japan (vol. iii., No. 3, Tokyo, 1921)

Sin-iti Kunitomi and Hikotarô Takô discuss the correlation between the fluctuation of solar activity, as shown by sun-spots and faculæ, and the terrestrial precipitation of rain, as measured at Tokyo and other stations in Japan and Japanese territory elsewhere. The Greenwich records were drawn on for the solar data, and the periodogram method was applied to these and to the rainfall statistics. The investigation suffers from the paucity of the latter material, which is limited to a period of three years; the authors state that only when the influence on the rainfall, of other than solar causes, was eliminated by the periodogram treatment was it possible to obtain any significant correlation coefficients at all. Even so, they suggest that the relation between the solar activity and the precipitation is likely to be somewhat indirect. To the reader acquainted with studies of this kind it will probably appear that the amount of material used was inadequate to allow of even the most tentative conclusions being based upon it. The authors recognise the necessity for further discussion, and promise a more elaborate study of the subject later.

THE August issue of the *Philosophical Magazine* contains the concluding portion of Dr. N. R. Camp-

bell's paper on the disappearance of gas when an electric discharge is passed through more or less exhausted tubes, a subject he has investigated for the General Electric Co. His observations cast serious doubt on the results which have been obtained by many previous workers, according to whom Faraday's laws of electrolysis hold in gases. Dr. Campbell finds, on the contrary, that the current arriving at the electrodes is not related in any simple way to the ionisation and recombination—that is, to the chemical reaction—taking place in the gas. The current, for example, at the cathode is made up of positive ions arriving and electrons leaving, and while the latter process is closely connected with the former, the two processes are not likely to be connected with the rate of progress of the reaction in the gas in the same way.

AFTER an interval of seven years the Geological Society of London has been able to resume the issue of its annual index to "Geo'logical Literature Added to the Geological Society's Library," which is so complete a work of reference, both to subjects and to the output of individual authors. The present part (5s.) brings the matter down to the close of 1913.

Our Astronomical Column.

THE AUGUST METEORIC DISPLAY.—Mr. W. F. Denning writes that on August 8 several fine meteors were observed by him at Bristol, and they belonged to the well-known shower of Perseids. On August 11, watching for two and a quarter hours before midnight, he counted 134 meteors, although the moon in her first quarter was shining brightly nearly all the time. The display was an exceptional one as regards both the number and the brightness of the meteors. Of the total number seen, 122 were Perseids and 12 belonged to the minor showers of the period. The radiant point of the Perseids was at $44^{\circ}+57^{\circ}$, but it was not so sharply defined as it sometimes is.

About 33 of the meteors seen were equal to, or brighter than, stars of the first magnitude, and they exhibited the swift motions and luminous streaks which are characteristic of the August meteor swarm.

Clouds came over the sky at 11.50 G.M.T. and prevented observations in the morning hours, but there probably occurred a very rich exhibition of meteors at places where the stars were visible. On August 12 the firmament was partly cloudy at Bristol, but there was a considerable number of meteors to be observed, for in clear spaces they were frequently seen, though no continuous observations were made. At 2.30 a.m., G.M.T., four Perseids were seen in less than two minutes, but immediately afterwards clouds interfered.

Mr. C. P. Adamson, of Wimborne, Dorset, watched the sky during two and a quarter hours on the evening of August 11, and counted 131 meteors. His results, therefore, as regards the numerical strength of the shower are in close agreement with those obtained at Bristol. Mr. Adamson found the radiant point elongated, from $43^{\circ}+57^{\circ}$ to $49^{\circ}+58^{\circ}$. Of the total number of meteors seen he says there were 125 Perseids, and at least 50 per cent. were equal to, or brighter than, first-magnitude stars.

THE BRIGHT OBJECT NEAR THE SUN.—Three of the five observers of this object, referred to in last week's issue, p. 759, were Prof. Campbell and his wife, and Prof. H. N. Russell, who is staying at the Lick Observatory. The object was seen shortly before

sunset; the fact that it partook of the diurnal motion indicated that it was a celestial body. Prof. Campbell observed it with binoculars, and noted that it still appeared stellar, which favoured its being a nova. If so, it is probably the most brilliant since that of Tycho Brahe. The approximate position is R.A. 9h. 22m., N. decl. 16° . The galactic latitude is about 40° . The object does not appear to have been seen since August 7. It may be recalled that the great 1882 comet and that of January, 1910, were seen close to the sun.

A report from Königstuhl Observatory, near Heidelberg, states that on the night of August 8-9 a number of luminous bands lay across a clear sky from W.N.W. to E.S.E.; they moved slowly towards N.N.E., growing paler as the dawn came. It was conjectured that it might be the tail of the light object seen at Lick Observatory on August 7, passing very near the earth. It will be recalled that a somewhat similar phenomenon was reported when the earth passed through the tail of the great comet of 1861 on June 30 of that year.

It seems possible, however, that the present streamers may have been auroral, as the cometary nature of the Lick Observatory object is still in doubt.

CONTINUATION OF THE EPHEMERIS OF EROS.—This planet was photographed at the Algiers Observatory in July, within 3' of the predicted position. The following ephemeris, for Greenwich midnight, is by Mr. F. E. Seagrave, corrected approximately by observation:—

	R.A.			N. Decl.		R.A.			N. Decl.			
	h.	m.	s.			h.	m.	s.				
Aug. 20	23	25	41	12	20	Sept. 9	22	52	56	13	57	
	24	23	20	18	12	52	13	22	45	22	13	57
	28	23	14	13	13	18	17	22	37	54	13	40
Sept. 1	23	7	32	13	38		21	22	30	44	13	35
	5	23	0	23	13	51	25	22	24	3	13	16

Values of $\log r$, $\log \Delta$, August 20, 0.2249, 9.8676; September 25, 0.2026, 9.8064. The magnitude in mid-September will be 10.5. The planet will thus be easily accessible in ordinary telescopes. Accurate observations of position are desired

University Education in the United States.

THE Washington Bureau of Education has just issued Bulletin No. 87, dealing with certain statistics of State universities and colleges in the United States of America for the year ended June 30, 1919. This is an annual publication which was formerly prepared and published by the National Association of State Universities, and contains data relating to ninety-two public institutions of university rank. The total enrolment in these State institutions for the year 1917-18 was 110,900, as against 244,231 in the corresponding private institutions. In 1918-19 the lowest enrolment was 31 for the New Mexico School of Mines, and the highest 8857 for the University of Michigan. With regard to teaching staff, the numbers in the State institutions vary from 7 to 908, the latter being the number of teachers in the University of Minnesota in 1918-19. It is curious to find that the University of Michigan with its 8857 enrolments shows an average of 20 regular term students per teacher, while the University of Minnesota with an enrolment of 6095 has an average of only 7. What is perhaps more curious is the fact that the total working income of the former is 3,069,587 dollars, while that of the latter is 3,462,361 dollars.

The fact that the institutions to which the bulletin has reference are passing through a stage of financial stringency very similar to that which is being experienced by the British universities at the present time gives an added interest to the publication. In the American State universities, just as in this country, "the cost of salaries has not risen to the same extent as the cost of living," and, as the bulletin very pertinently says, "unless the people wish to see their higher institutions staffed with men of inferior ability, it will be necessary to pay salaries sufficiently large to attract teachers of merit and ability." University teachers in this country will recognise a familiar ring about this language! The bulletin contains a mass of statistics which have been compiled by the Bureau of Education in the hope that they will be "very useful in the promotion of State campaigns for the more adequate support of higher education." While

one may express the hope that American State universities and colleges will receive such public support in the future as will be necessary for their development, it should be observed that already they receive in the aggregate almost 73 per cent. of their income from public funds. In four States, indeed, the percentage is more than 90. In this country, notwithstanding the recent additional grant of 500,000. to the universities, State aid is greatly inferior to the State aid which is given to public institutions in America.

Of special interest is the question of students' fees in these universities and colleges. At the outset one must make a clear distinction between public and private universities or colleges in America. The number of students enrolled in the public higher institutions amounts to about 31 per cent. of the whole, while the remaining 69 per cent. are enrolled in private or non-State-aided institutions. As a rule, the former pay small fees. In the case of New York University the income from fees is as low as 3 per cent. of the total income. The average for the whole country in 1917-18 was 22 per cent. of the total income. In the private institutions the percentage for the same year varied between 17 (Connecticut) and 87 (Alabama), with an average of 54 per cent., the remaining income being derived mainly from "productive funds" or private benefactions. So far as the State institutions are concerned there is no indication that students' fees, though lower than those in this country, are to be increased. The campaign to increase the income is apparently to be directed to obtaining increased assistance from public or State funds. The plea for State aid is concisely expressed in the words:—"When the State appropriates money to education, it is making a wise investment which will yield manifold returns. Liberal support of higher education is good public economy and wise forethought for the future." One may be allowed to hope that the Government of this country will ponder over these words. Our home universities are sadly in need of further State aid.

Recent Work on Minerals and Rocks.

NOW that questions of crystal structure and of approximate isomorphism play so large a part in chemical and physical conceptions, the study of crystallography is no longer for specialists alone. Students of many branches of science will welcome the re-issue of J. B. Jordan's nets for making models of simple crystal-forms (T. Murby and Co., London, 3s.). The older names can be covered by labels bearing those suggested in this edition, though we should like to see "bipyramid" substituted for "pyramid" throughout, since no true pyramids, such as those occurring in tourmaline, are utilised. These models were familiar in the Royal School of Mines forty years ago, and should now serve many future generations of students whose outlook on crystals has widened with physical research. Their effective colours and their price certainly commend them.

A. D. Hall provides a very interesting memoir (Union of South Africa Geol. Survey, No. 15, 1920, 7s. 6d.) on "Corundum in the Northern and Eastern Transvaal," in which the modes of occurrence and of working are fully illustrated. The author, in a chapter on "The Problem of Genesis," very properly directs attention to the tardy recognition of corundum as a rock-forming mineral, and lays stress

on the experimental work of Morozewicz in 1899. Corundum in the Transvaal arises from a granite magma supersaturated with alumina. Hall holds that this supersaturation arises, not through absorption of aluminous material from contact-rocks, but by removal of silica into those rocks along the zones of contact.

In "Phosphate in Canada" (Canada Depart. of Mines, No. 396, 1920) Hugh S. Spence describes and illustrates the well-known occurrences of apatite in Ontario and Quebec, and discusses works established in other parts of Canada where imported phosphatic materials are used. The apatite "is to be considered of igneous origin rather than to have been derived from the original limestones" through which the pegmatite masses have passed. The associated minerals, such as pyroxene, scapolite, and phlogopite, are described. At Huddersfield, Quebec, allanite occurs in crystals more than an inch in diameter, and fluorspar, which is here abundant in calcite, assumes a deeper violet colour in close proximity to it. An emanation-influence naturally suggests itself.

The minerals of saline lakes, notably epsomite, are dealt with by L. Reinecke in "Mineral Deposits between Lillooet and Prince George, British Columbia"

(Canada Geol. Survey, Mem. 118, 1920). R. Lockhart Jack, in "The Salt and Gypsum Resources of South Australia" (Geol. Surv. S. Australia, Bull. 8, 1921) interestingly connects the salt of the lagoons of the Yorke Peninsula, between Spencer Gulf and the Gulf of St. Vincent, with "cyclic" salt imported aerielly during long ages from the sea. The supply thus given to the soil is drawn on by the lakes, with, of course, some addition from salt-dust now falling on their surfaces, and depends on conditions of dryness, whereby the local water-table does not rise dangerously high. The meteorological features of the region are well put forward. The deposits of gypsum are similarly attributed to cyclic matter, which has been redissolved and carried by the saline ground-waters (p. 90) into lake depressions. On the margins of these it evaporates and becomes blown up into dunes. There are also some occurrences of gypsum in a more normal and less interesting manner in Cainozoic rocks.

The graphite deposits of the world outside the United States are reviewed, with maps, in a valuable paper by A. H. Redfield ("Foreign Graphite in 1919," U.S. Geol. Surv., Min. Resources, 1919, part ii., No. 12, 1921). This pamphlet should stand beside our text-books of mineralogy, which constantly require the refreshing influence of general surveys of this nature. Though the commercial aspect is naturally paramount, the names of localities and the references to literature will be of service to the student.

The work of R. E. Liesegang has added considerably to the interest of zoned and banded deposits. P. A. Wagner (Trans. Geol. Soc. S. Africa, vol. xxiii., p. 118, 1921) describes the "Nature and Origin of the Crocodile River Iron Deposits" in the Rustenburg district of the Transvaal. He compares them with those of the Lake Superior region, and holds that the hæmatite and hydroxide masses are concentrations by downward percolation from beds of siderite and ferruginous chert. In some cases alteration in place has led to the formation in chert of magnetite, hæmatite, or brown hydroxide, alike pseudomorphous after rhombohedral siderite.

Olaf Holtedahl (*Amer. Journ. Sci.*, vol. cci., p. 195, 1921) reviews old and recent work on the zoned concretions of calcite in the magnesian limestone of Durham, pointing out the reasons that have led English geologists to regard them as mineral structures arising through secondary alteration. Their resemblance to some of the pre-Cambrian structures claimed by Walcott as algal (*Camasia*, *Newlandia*, *Greysonia*, etc.) inspires the author with caution in dealing with these older specimens.

Mineralogists cannot afford to overlook the paper

by F. W. Clarke and W. C. Wheeler on "The Inorganic Constituents of Marine Invertebrates" (U.S. Geol. Surv., Prof. Paper 102, 1917) with its important series of analyses of the hard parts of a wide range of living creatures. The proportion of magnesium carbonate to calcium carbonate bears, of course, on the much-discussed origin of dolomite, and it is shown that organisms capable of depositing calcite may accumulate magnesium by isomorphous substitution, while this cannot take place when the hard parts are formed of aragonite. The utilisation of magnesium is very distinctly favoured by warm conditions, specimens from Arctic or Antarctic waters, or from very deep waters, showing relatively small proportions. Crinoids, for instance, from 47° N. lat. and a depth of 1000 metres may yield 9 per cent. of magnesium carbonate, while 12 per cent. commonly occurs at similar depths near the equator. A biological problem of much interest is here opened. No such authoritative and detailed analyses have hitherto been available. As was already known, alcyonaria generally are rich in magnesium carbonate. An equatorial specimen of *Phyllogorgia quercifolia* is here shown to contain 15.73 per cent. The influence of these facts on determinations of specific gravity in fossil forms should, of course, be noted.

The rhyolites of Lipari, including the familiar obsidian of the Rocche Rosse, have received complete and critical examination and analysis from H. S. Washington (*Amer. Journ. Sci.*, fourth series, vol. 1, p. 446, 1920). It is shown that in the glassy varieties ferrous oxide predominates largely over ferric oxide, while this condition is reversed in crystalline types. It is suggested that the glassy state retains more nearly the constitution of the igneous magma, while oxidation occurs as the gases are permitted to escape.

W. R. Browne provides a new study of differentiation in an igneous mass, through the sinking of crystals and later extrusions, in his description of "The Igneous Rocks of Encounter Bay, South Australia" (Trans. Roy. Soc. S. Australia, vol. xlv., p. 1, 1920). In the same volume, p. 300, W. Howchin reviews coarse fragmental structures of various kinds in rocks, citing Australian examples, and he usefully directs attention to the influence of desiccation in breaking up a sediment in an early stage of its history. The drying mud of lakes is an example. Attention may be directed to the moderate price (10s. 6d.) of this volume and of some other illustrated publications from our federated Commonwealths, in the hope that the enterprise displayed may react on issues in the homeland.

G. A. J. C.

Plant Pests and their Control.

By DR. WILLIAM B. BRIERLEY.

THE "Report on the Occurrence of Insect and Fungus Pests on Plants in England and Wales for the Year 1919,"¹ which has just been issued by the Intelligence Department—Plant Pests Branch of the Ministry of Agriculture and Fisheries, marks a very definite step in the recognition in this country of the danger to our food crops from diseases caused by insects, fungi, bacteria, etc. This disease-survey work was originated by a sub-committee of the Technical Committee of the late Food Production Department, which was formed to advise the department

¹ Ministry of Agriculture and Fisheries. Intelligence Department: Plant Pests Branch. (Miscellaneous Publications, No. 33.) "Report on the Occurrence of Insect and Fungus Pests on Plants in England and Wales for the Year 1919." Pp. 68. (London: H.M. Stationery Office, 1921.) 1s. 6d. net.

on questions relating to plant disease and insect pests. A few honorary correspondents scattered throughout the country forwarded monthly statements relating to diseases and pests in their own particular areas, and at the close of the year these were summarised by the sub-committee, and a "Report on the Occurrence of Insect and Fungus Pests during 1917" was published. This was the first time that any successful attempt had been made to gather together and systematise data relating to the incidence and spread of plant disease in this country. With the experience gained the work was continued in a more efficient manner, and a report for 1918 issued. There has now appeared the present, and somewhat belated, report for 1919, and a comparison of these three publications.

shows a marked progress in width and inclusiveness of vision. A mass of valuable data has been accumulated, and the Ministry, by becoming acquainted with those areas where disease is most serious, is in a better position to advise and to urge measures of control. Further, the Ministry must lead the way, and by the recognition of those diseases most responsible for heavy losses, it will be enabled to suggest, or institute, policies which will lead to the prevention of the present appalling waste of foodstuffs.

The report for 1919 is divided into three sections, the first being a tabulated and summarised list of the correspondents' reports on insect pests received during the year. The second section is a complete and up-to-date hand-list of the authenticated fungus diseases in the country, and if expanded and elaborated would form a very useful reference book for plant-pathologists, filling a niche at present singularly empty. The third section is a summary of meteorological data with which the incidence and spread of disease might be correlated. The report is a notable achievement, and a fine example of the solid scientific work which, quietly and unassumingly, is being carried out by this branch of the Ministry of Agriculture. Much credit is due to Messrs. Fryer and Cotton, who, in the face of not a little discouragement and lack of aid, have carried this work through to such a pitch of efficiency and permanent value.

There are naturally many features at which one could cavil, but these are due primarily to the exigencies of the incomplete and voluntary system on which the field reporting necessarily is based, and upon the innate difficulties in the reporting itself. Thus whilst it is important to learn that a particular disease is present in certain localities on specific dates, the really important thing in this connection is to find out what, if any, relation exists between the several outbreaks, and what relation the outbreaks bear to

climatic conditions and dispersive factors. The acquiring of such knowledge, however, is a considerable piece of research, needing the whole-time services of a large *personnel* of highly trained investigators, and these the country does not possess, nor will it until plant disease is regarded a little more seriously by the university and the farming mind. Again, to learn that "Mosaic Disease is present in tomatoes grown in the open," is interesting, but one would like to know exactly what percentage of the plants are killed or sterilised by this disease, or of those in bearing what percentage of a normal yield is obtained, and what is the financial loss incurred by the trade? The present lack of standardised criteria in loss estimation is very unsatisfactory. However, these are questions easy to ask, and almost, if not quite, impossible to answer, and only slightly detract from the value of this report as a foundation for epidemiological study in plant disease.

But the preparation of such a report as this has a far greater value than its local interest. Plant diseases are no respecters of diplomats or political boundaries. The disastrous spread into this country of American gooseberry mildew, or wart disease of potatoes; of citrus canker and chestnut bark disease into America; the wiping out of the coffee industry in Ceylon by the introduction of the coffee leaf disease into that island—the remembrance of these among many examples that could be quoted, should convince everyone of the critical importance of an accurate and systematic survey of plant diseases in order that undesirable aliens may be excluded, or if found to be present, crushed whilst still limited in distribution.

The control of plant disease in our crops is one of the most vital factors in agriculture to-day, and in the lean years to come, when every ounce of food will be an asset, the knowledge gathered together in such reports as this will be a very material aid in the struggle to provide the nation's sustenance.

Studies of Shore Fishes.¹

NOT the least of the Danish marine expeditions in the *Thor*, under the skilful hands of Dr. Johs. Schmidt, was that devoted to the careful search of the Mediterranean and the sifting of the work of Grassi and Calandruccio in regard to the spawning of the eel and the murenoids.

In the course of this work many young shore-fishes were encountered, and M. Louis Fage has given an excellent report thereon. Some of them are common to British waters as well as to the Mediterranean, whilst others, such as *Macrorhamphosus*, *Anthias*, *Callanthias*, and *Uranoscopus*, are more characteristic of the southern waters. Though the shores of the Mediterranean are rich, they fall far short of the plenitude and variety of the shore-fishes of Japan. Of the twenty families encountered, thirteen have pelagic eggs and seven demersal. The striking changes between the adult outline and that of the young are well shown in such species as *Macrorhamphosus scolopax*, the gurnards, *Serranus cabrilla*, and *Anthias sacer*. The illustrations appear to have been made from preserved specimens, and in a characteristic form like the grey gurnard in its early stage the pectorals fall short of the actual proportions (*cf.* Prof. Prince's figure from life, *Trans. Roy. Soc. Edin.*, vol. xxxv., pl. xvii., Fig. 5).

Perhaps the most interesting part of M. Fage's memoir is the introduction, in which he discusses the

problems connected with the reproduction of the Teleosteans. Amongst other features, he believes with Giard that the embryology is condensed as we advance to the north, yet that the pelagic embryos are specially adapted to the colder waters. Thus, taking the genera *Sebastes* and *Scorpaena*, the latter having two subgenera, *Helicolenus* and *Scorpaena*, it is found that *Sebastes marinus* is rare south of the Faroes, and is viviparous. The widely distributed *Helicolenus dactylopterus*, Delar., reproduces in winter in northern waters, and the larvæ agree with those of other *Scorpaenidæ*. On the other hand, *Scorpaena porcus* and *S. scropha* in the southern waters are developed in summer, and their early pelagic stages have enormous pectorals for sustaining them. The larval stages of some of the fishes from southern waters are prolonged, *e.g.* *Arnoglossus laterna*, Will., as shown by Dr. H. M. Kyle, undergoes metamorphosis in northern water when 16 mm. long, but in the Bay of Biscay when 26-30 mm. in length.

M. Fage attributes the wide distribution of the young forms of certain shore-frequenting species to the cyclonic currents of the Mediterranean; but he has to except the young of the genus *Caillionymus*. A wider view of the subject, however, creates doubt as to the general applicability of such an explanation. In connection with the adaptations of the larvæ he forms two groups (after Dollo), viz. the *nectique* and the *plantique*. The slow forms, especially the benthic, develop organs for maintaining equilibrium in the plankton, such as long ventral or pectoral fins

¹ Report of the Danish Oceanographical Expeditions in the Mediterranean, 1908-10. "Shore Fishes." By Louis Fage, of the Natural History Museum, Paris. Pp. 154. (Copenhagen: And. Fred. Høst and Son, 1918.)

or elongated dorsal fins, but the author does not allude to the slow lumpsucker, which has none of these characteristics.

Lastly, M. Fage refers to positive and negative heliotropism in the larvæ, the former being illustrated by the capture of the young *Capros aper* much nearer the surface by day than by night, and the latter by the

passage of *Paracentropistis hepatus* from considerable depths by day to a more superficial area by night. The study of this subject, however, is still in its infancy. Many other interesting features are instanced by the author, whose memoir forms an important contribution to the subject of the larval forms of shore-fishes.

W. C. M.

The Lac and Shellac Industry in India.¹

By DR. A. D. IMMS.

AT the present time India holds what is virtually a monopoly of lac production, and no satisfactory substitute has yet appeared on the world's markets. This monopoly cannot, however, be regarded as a sinecure; other countries are likely to be found suitable for lac cultivation, and the present high value of lac and its importance to many Western industries render it urgent that the production of this substance should be encouraged along improved scientific and economic lines. The propagation of lac is still very carelessly carried out, and its methods of collection need much improvement. The crop varies from year to year, prices fluctuate seasonally, and there is much injurious market speculation. The bulk of the world's lac comes from Chôta Nagpur, Orissa, the north-eastern half of the Central Provinces, some western districts of Bengal, and from part of the Mirzapur district of the United Provinces. Out of the ninety or more trees which have been recorded as hosts for the lac insect (*Tachardia lacca*), the most important include *Schleicheria trijuga*, *Butea frondosa*, *Zizyphus jujuba* and *xylopyrus*, together with species of *Acacia*, *Ficus*, etc. These plants contain much gummy or resinous matter or are rich in latex.

The problems concerning lac production are manifold, and may be roughly divided into (1) botanical, (2) entomological, (3) chemical, (4) cultural, and (5) technological. On the botanical side we need more especially to determine the optimum conditions which conduce to the food-plants yielding a heavy crop of lac. It also needs to be ascertained how far it is possible by cultural treatment to stimulate the plant's production of those substances which are utilised by the insect in lac secretion. On the entomological side the most important problem is to deal with the enormous number of parasitic and other insects which annually destroy a prodigious amount of lac, either directly or indirectly. It is extremely unlikely that any marked improvement in lac culture will result until this complex problem has been thoroughly gone into. On the chemical side we need to know what plant substances are essential as food or raw material for the lac insect. Once the biochemistry of this problem is understood, it will pave the way for a better understanding of the requirements of the insect and open up a whole field of research into the cultural conditions necessary.

Under the latter heading are many other problems.

¹ H. A. F. Lindsay and C. M. Harlow: "Report on Lac and Shellac." Indian Forest Records, vol. viii., part 1, 1921. Pp. x+162+4 plates+10 charts+1 map.

Pruning and pollarding are highly desirable, for the lac insect is dependent upon the existence of young shoots in the right physiological condition. The extent and frequency with which the trees can be safely infected to yield the optimum crop need to be ascertained. It is also necessary to acquire definite information whether the best results are likely to be obtained from the establishment of lac nurseries composed of young trees of convenient size under careful cultivation, or whether little benefit is likely to be derived, as compared with the present system of relying solely upon existing trees growing wild and distributed over wide areas. On the technological side much improvement is possible; we need to ascertain the best and most economic methods of dealing with lac in all stages of its treatment—from the condition when it is received as stick-lac up to the final products of shellac, lac-wax, and lac-dye. The present system is primitive and often uneconomic, and adulteration is frequent.

The problems are highly complex and involved, and this fact is fully appreciated by Messrs. Lindsay and Harlow in recommending that a central lac laboratory be established in India. Under the existing system most of what research has been done at all has been carried out partly by the Forestry Department at Dehra Dun and partly by the Agricultural Department at Pusa. Neither of the research institutes located in the above places has the necessary staff available for the work. The choice of a site for such a laboratory is likely to prove difficult, as there are many factors to be considered. The *sine qua non* is that it must be located in an important area of lac production, where the problems can be studied on the spot. Such a laboratory would be devoted primarily to the study of the growing crop in relation to its environment. Its first aim presumably would be to obtain exact and trustworthy information bearing upon the many problems involved. At the present time we need new ideas and trustworthy knowledge. Much that is published is largely a repetition of what has appeared previously; the same statements, and often the same errors, have reappeared with perennial regularity, and little or no real progress has resulted. Messrs. Lindsay and Harlow's bulletin is a useful *résumé* of the present position of the problems concerned, and the suggestions which they bring forward will, it is to be hoped, receive the fullest consideration by those whose duty it is to develop and influence our means of utilising the natural resources of India.

Flight of Flying-fishes.

DR. E. H. HANKIN has made some interesting observations on the "flight" of flying-fishes (Proc. Zool. Soc. London, 1920, pp. 467-74, 2 figs.). He concludes that much depends on the atmospheric conditions. On a very still evening in the Arabian Sea he noticed that the length of a glide after leaving the water was only about a metre, and the fishes

showed much lateral instability. During the same voyage, but in sunshine and with a light wind, the longer flights attained to between 200 and 400 metres in length. The pectoral fins are usually in the "flat" position, *i.e.* extended in the horizontal plane. Sometimes the wings are slightly inclined upwards, with the outer part of the fin at a higher level than its

base. This is the usual position in slow-speed flight. In rare cases the fins are inclined very slightly downwards, and this "down" position is probably used for flight at highest speed. Now soaring vultures have their wings in the "up" position for slow-speed flight, and use the "flat" wing-disposition for flight at high speed.

A further resemblance between flying-fish and soaring vulture is indicated by the observation that the tips of the pectoral fins may be bent up, forming an angle of perhaps 45° with the rest of the fin, which is comparable to the bending up of the terminal quills of the vulture's wing during horizontal soaring flight.

Dr. Hankin confirms the conclusion that while there may be flapping of the pectoral fins at the start, there is none after the fish has got well under way. A speed of 10 metres per second was observed during eight seconds, and a maximum of 20 metres per second is probable. Taking advantage of species of *Exocoetus* with coloured pelvic fins, Dr. Hankin was able to discover how the displacement of these is used to check the velocity in both high-speed and low-speed flight. In a species with the pelvic fins small in size and placed far forwards, therefore unsuitable for checking speed or for steering in the vertical plane, the fishes at the end of their flight steer downwards by drawing the pectoral fins back through an angle of about 45° . They then plunge head foremost into the water without any visible attempt to check their speed.

It seems that flying-fishes sometimes make mistakes as to the suitability of the air for flight. They may emerge with low-speed disposition when high-speed disposition would have been appropriate; they may emerge tail "up" when they should have tried tail "down." Thus their "flights" are often involuntarily short.

University and Educational Intelligence.

LONDON.—The Ph.D. degree in the faculty of science has been conferred on the following:—Connell Boyle (Royal College of Science), for a thesis entitled "Studies in the Physiology of Fungi"; Sri Krishna (East London College), for a thesis entitled "The Condensation of Phenols with Acid Anhydrides, with Special Reference to Coumarin"; Isabel Soar (Birkbeck College), for a thesis entitled "The Structure and Function of the Endodermis in the Abietineæ"; Nellie Barbara Eales (University College, Reading), for a thesis entitled "Monograph on the General Morphology of *Aplysia punctata*"; Frederick H. Newman (Royal College of Science, and University College, Exeter), for a thesis entitled "The Absorption of Gases in the Electric Discharge Tube"; and George N. Pell (University College), for a thesis entitled "The Trajectory of Bombs Dropped from Aircraft."

THE Bureau of Education, Washington, has issued a pamphlet dealing with the opportunities for the study of medicine in the United States (Higher Educational Circular, No. 22). The system of education in the United States is first briefly surveyed, and details are given of the preliminary studies and examinations necessary in order to enter a medical school. The medical curriculum is then described, and a list of the medical schools is given, with notes on their numbers of students, graduates, and teachers, and the fees. Other sections of the pamphlet deal with the expenses incident to an education in an American medical school, social opportunities, and scholarships and loan funds. Of the 85 medical colleges in the country, about 60 are open to both sexes.

Calendar of Scientific Pioneers.

August 19, 1662. Blaise Pascal died.—A religious philosopher, mathematician, and physicist, the author of the "Provincial Letters" and the "Pensées," Pascal spent the earlier part of his life in scientific studies. He made the first calculating machine, measured heights by the barometer, and with Fermat founded the theory of probabilities.

August 19, 1822. Jean Baptiste Joseph Delambre died.—During the French Revolution Delambre with Méchain made the geodetic measurements which formed the base of the metric system. He succeeded Lalande at the Collège de France, and distinguished himself as one of the secretaries of the Paris Academy of Sciences. His great "History of Astronomy" was published during 1817-21.

August 19, 1856. Charles Frédéric Gerhardt died.—An Alsatian by birth, Gerhardt became an assistant to Liebig, held a chair at Montpellier, and during the years 1848-55 resided in Paris, where he published his "Traité de Chimie organique," which contains his important views on the structure and constitution of chemical compounds. He died at Strasbourg, where a monument is to be erected to him.

August 19, 1896. Josiah Dwight Whitney died.—Graduating at Yale in 1839, Whitney rose to a foremost position among American geologists. In 1865 he became professor of geology at Harvard.

August 23, 1782. Henri Louis Duhamel du Monceau died.—A botanist, physicist, and technologist, Duhamel du Monceau had an unrivalled knowledge of timber, and as Inspector-General of the French Navy contributed to the advancement of naval architecture.

August 23, 1806. Charles Auguste de Coulomb died.—A French military engineer, Coulomb made important researches on friction, invented the torsion balance, and discovered the laws of the attraction and repulsion of electrified bodies. He was an original member of the French Institute, and was employed by Napoleon as an Inspector of Public Instruction.

August 23, 1835. Leopoldo Nobili died.—Nobili, who was professor of physics in the Archducal Museum at Florence, is remembered for the introduction of the astatic galvanometer and the thermo-electric pile.

August 24, 1664. Maria Cunitz died.—A native of Germany, during the Thirty Years' War Maria Cunitz removed to Poland, where, with the assistance of her husband, she compiled her astronomical tables, "Urania propitia . . ." From her universal accomplishments she was called the "Silesian Pallas."

August 24, 1832. Nicolas Léonard Sadi Carnot died.

August 24, 1888. Rudolf Julius Emmanuel Clausius died.—Both famous physicists, Carnot and Clausius are among the founders of thermodynamics. The son of the "Organiser of Victory," Carnot was born in the Luxembourg in 1796, passed through the Ecole Polytechnique, and served in the Army. His essay of 1824, "Réflexions sur la Puissance motrice du Feu," called by Kelvin an "epoch-making gift to science," for many years remained unnoticed. Clausius was born in 1822, and as a *Privatdozent* at Berlin in 1850 re-stated Carnot's principle, enunciated the second law, and afterwards developed his conception of entropy. His "Die mechanisch Wärmethorie" appeared in 1867. While Carnot's work was the outcome of his study of the steam engine, that of Clausius led to the application of scientific principles to its improvement. The kinetic theory of gases also owes much to the labours of Clausius, who for some years was professor of natural philosophy at Bonn, where Hertz was his successor. E. C. S.

Societies and Academies.

PARIS.

Academy of Sciences, August 1.—M. Georges Lemoine in the chair.—The President announced the death of M. Edmond Perrier.—A. Lacroix: The mineralogical composition of rockallite. Dr. Charcot has recently made a successful landing on the island of Rockall, examined its geological structure, and collected specimens of the rocks. The present paper contains an account of the mineralogical, chemical, and spectroscopic examination of some of these.—L. Maquenne and R. Cerighelli: The distribution of iron in plants. Figures are given of 100 determinations of iron in various organs of forty species of plants. The quantities found are very small, varying from 1 to 362 parts of iron per million of dry plant material. Young organs, buds, and leaves contain more iron than the older ones.—A. de Gramont and G. A. Hemsalech: The conditions of the emission of the spark lines by the electric arc. Conditions of experiment were devised so that the effects of cooling the metallic vapours or the electrodes, of heating the electrodes, and of varying the chemical nature of the medium in which the arc was struck could be studied. The results prove that spark lines are always emitted when the current of the electric arc is obliged to pass through media (vapours or gases) possessing a relatively low degree of ionisation—that is to say, offering a strong resistance to the passage of the current. This amounts to saying that the emission of spark lines is related to the existence of intense electric fields.—L. Antoine: Perfect ensembles discontinuous throughout.—J. Kampé de Fériet: Certain systems associated with equations of finite differences or with partial linear differential equations.—H. Beghin: The Anschütz and Sperry gyrostatic compasses.—M. Charcot: An expedition of the *Pourquoi-Pas* to Rockall. An account of the landing of two men on the island on June 19 and of three men on July 1 for the purpose of collecting specimens of rocks and algæ.—E. Dubois: The minimum potential of electric discharge in hydrogen at low pressures. A further study of the variations produced in the discharge potential by the occlusion of hydrogen by the platinum wire electrode.—H. Pélabon: The resistivity of selenium. The resistance of liquid selenium falls rapidly as the temperature rises, the logarithm of the resistance being a linear function of the temperature. While the resistance of liquid selenium is defined by the temperature, this is not the case with the solid grey selenium, the resistance of which depends upon its previous heat treatment.—M. Sauvageot: The retarded solution and premature precipitation of cementite in eutectic and hypereutectic carbon steels.—A. Damiens: The system bromine-tellurium. The nature of the lower bromide of tellurium. Since bromine has no solvent action on TeBr_2 , the thermal study is reduced to that of the system TeBr_1 -Te. No indication of the compound TeBr_2 was obtained from the metallographic or thermal analysis, but this substance was proved to be present by heating in a vacuum. This gave a non-volatile portion and two sublimes differing in colour and volatility. One of these was TeBr_1 and the other a mixture of tellurium and its tetrabromide in the proportions required to form TeBr_2 . Hence the lower bromide would appear to exist in the gaseous state, but is unstable in the solid state, decomposing into tellurium and the tetrabromide on solidification.—P. Woog: The oiliness of fatty bodies. The property of oiliness or greasiness, valuable in lubricants, is not capable

of exact definition. The molecular volumes of a considerable number of lubricating oils, fatty and mineral, have been determined by cryoscopic or boiling-point methods, and it is shown that in general the oiliness or greasiness of an oil diminishes as the molecular volume decreases.—V. Auger: The equilibria of tri-, tetra-, and penta-valent vanadium in concentrated sulphuric acid solution.—C. D. Zenghelis: The detection of nitrogen in organic compounds. The compound is heated with a reagent consisting of soda-lime (two parts) and copper powder (one part), and the ammonia evolved detected by the formaldehyde-silver nitrate reagent previously described by the author. Tests with a large number of different types of nitrogen compounds are given, the limits of delicacy ranging between 0.05 and 0.001 milligram of nitrogen.—E. Rengade and J. Clostre: The estimation of water in transformer oils. The oil is heated to 80°C . in a current of dry air, and the escaping vapours are cooled with solid carbon dioxide or liquid air.—E. E. Blaise: The preparation of the acyclic δ -diketones. Glutaric diethylamide is condensed with an alkyl magnesium bromide. The reaction does not proceed normally, much gas being evolved, but the δ -diketone is formed, with a yield of 25 to 30 per cent. Dipropionylpropane and dibutyrylpropane have been prepared by this method: their properties and reactions are described.—H. Gault and R. Weick: Additional properties of the keto-enolic double linkage. A study of the reactions of one of the three isomeric phenylpyruvic esters with ammonia and diethylamine.—R. Fosse and G. Laude: Syntheses of cyanic acid and urea by the oxidation of organic substances: amides, nitriles, and methylcarbylamine.—M. Samec and Mlle. Anka Mayer: The synthesis of amylopectin by the phosphoric etherification of the erythroamyloses.—J. Savornin: The middle atlas of Morocco.—Ph. Wehrlé: The notion of period in the study of the nuclei of pressure variations.—A. Carpentier: The presence of Cycadophytes in the Wealdian layer of Féron.—L. Blaringhem: Researches on the hybrids of flax (*Linum usitatissimum*).—A. Guilliermond: Cytological observations on the bud of *Elodea canadensis*.—G. Bertrand and Mme. M. Rosenblatt: The general presence of manganese in the vegetable kingdom. According to Maumené, certain plants are free from manganese. The authors' analyses show that none of the exceptional cases cited by Maumené can be retained: manganese is present in all plants without exception.—S. Metalnikow and H. Gaschen: Immunity and hypersensitivity in the caterpillar.—R. Sazerac and C. Levaditi: The treatment of syphilis by bismuth. A detailed account of the treatment and results in five cases.

SYDNEY.

Linnean Society of New South Wales, June 29.—Mr. G. A. Waterhouse, president, in the chair.—G. F. Hill: Notes on some Diptera found in association with Termites. In opening up galleries of *Mastotermes darwiniensis* and *Calotermes irregularis*, the author frequently found larvæ and pupæ of Trypaneidae and Syrphidae; he describes one species belonging to each family, that in the Syrphidae being new.—Vera Irwin-Smith: Studies in life-histories of Australian Diptera Brachycera. Part i.: Stratiomyidae. No. 2: Further experiments in the rearing of *Metoponia rubriceps*. Attempts to rear the larval *M. rubriceps* from the egg have met with considerable success, and it has been found possible to breed from flies reared from the larva in captivity. The cycle, from larva to larva of the next generation, has been obtained, but the bred larvæ all perished at an early

stage, so that the cycle has not been quite completed, and the length of time passed in the larval state is still unknown.—Dr. R. J. Tillyard: Revision of the family Eustheniidae (order Perlaria), with descriptions of new genera and species. The Eustheniidae are described as a distinct family possessing only archaic family characters. To the three genera and four species which have been described the author adds two genera and seven species, all of which are described for the first time. The known distribution of the family is Tasmania, Victoria, New Zealand, mountains of East Australia, and southern Chile, and is regarded as an argument in favour of an Antarctic origin of the Perlaria.—Margaret H. O'Dwyer: Preliminary report on the nutritive value of certain Australian grasses. A number of grasses grown at the Botanic Gardens and at various State experiment farms have been analysed with the view of determining their value as foodstuffs. In order that the results might be of value for comparative purposes the material was obtained so far as possible at the following well-defined stages of growth:—(1) About half-way between the time when it begins to shoot and the flowering period, (2) early flowering period, and (3) when the seed is quite set. The paper comprises a preliminary discussion of the methods used and the results of the analyses.

CAPE TOWN

Royal Society of South Africa, June 15.—Dr. A. Young in the chair.—V. H. Brink: A preliminary genetic study on the osteology of the Griquas.—E. Newbery: Note on the life-period of the over-voltage compounds. A series of experiments has been carried out to determine the effect of changes in the speed of the commutator upon the measured over-voltage of various cathodes in dilute sulphuric acid. The commutator was rotated at speeds varying between 300 and 1500 revs. per minute, and an interesting set of curves was obtained by plotting the observed over-voltages against these speeds. The relative rates of decomposition or decay of the over-voltage compounds are shown by these curves. Those of zinc and chromium are so stable that no perceptible change of potential occurs within the time-limits of the experiments. The hydrides of silver, platinum, and graphite show signs of decay after one-twentieth of a second, those of copper and cadmium after one-thirtieth of a second, whilst those of lead and nickel appear to be decomposed with very great rapidity.

July 20.—Dr. J. D. F. Gilchrist, president, in the chair.—E. J. Hamlin: The effect of sunlight on secondary batteries.—Dr. J. D. F. Gilchrist: Note on the pectoral fin of *Achirus* (a species of sole).

Books Received.

Memoirs of the Geological Survey: England and Wales. The Geology of the South Wales Coalfield. Part xiii.: The Country around Pembroke and Tenby. By E. L. Dixon. Pp. vi+220+5 plates. (Southampton: Ordnance Survey Office; London: E. Stanford, Ltd.) 8s. net.

Greek Atrocities in Turkey. First Book, Publication No. 4. Pp. 153+5. (Constantinople: Ministry of Interior, Dept. of Refugees.)

Ministry of Finance, Egypt: Survey of Egypt. The Soils and Water Supply of the Maryut District, West of Alexandria. By Dr. W. F. Hume and F. Hughes. (S.D.P. No. 37.) Pp. v+52+xiii plates. (Cairo: Government Press.) P.T.10

Loughborough College, Leicestershire. Calendar: Session 1921-22. Pp. xviii+190. (Loughborough: The Echo Press.) 2s. 6d. net

A Text-book of Physics. Edited by A. W. Duff. Fifth edition, revised. Pp. xiv+700. (London: J. and A. Churchill.) 16s. net.

Department of Mines and Explosives, Mysore State. Report of the Chief Inspector of Mines in Mysore for the Year 1919-20; with Statistics for the Calendar Year 1919. Pp. 34+45. (Oorgaum.) 2 rupees.

The Law of Births and Deaths: Being a Study of the Variation in the Degree of Animal Fertility under the Influence of the Environment. By Charles Edward Pell. Pp. 192. (London: T. Fisher Unwin, Ltd.) 12s. 6d. net.

Magnetizzazione della Elettricità: Rotazione Elettro-Magnetica del Sistema Planetario e Specialmente del Terreno e dei Vegetali Terrestri. By Niccolò Mancini. Pp. iv+91. (Firenze: B. Seeber.)

Die Ursachen der diluvialen Aufschotterung und Erosion. By W. Soergel. Pp. v+74. (Berlin: Gebrüder Borntraeger.) 18 marks.

Department of Scientific and Industrial Research: Report of the Fuel Research Board for the Years 1920, 1921. First Section: Steaming in Vertical Gas Retorts. Pp. viii+54. (London: H.M.S.O.) 1s. 6d. net.

An Introduction to the Flora of Natal and Zululand. By Prof. J. W. Bews. Pp. vi+248. (Pietermaritzburg: City Printing Works; London: Wheldon and Wesley, Ltd.) 15s.

CONTENTS.

	PAGE
A Suggested Institute of Human Sciences . . .	769
Astrology. By Dr. Charles Singer . . .	771
Physical Chemistry, Pure and Applied. By T. M. L.	772
The Realm of Man. By Geo. G. Chisholm . . .	774
Calculus for Students. By G. B. M.	775
Our Bookshelf	775
Letters to the Editor:—	
Biological Terminology.—Dr. F. A. Bather, F.R.S.	778
The Fauna of Scottish Lochs.—Dr. N. Annandale	778
Magnetic Double Refraction in Smokes.—L. Tieri	778
The Exploitation of Irish Peat.—Dr. Alexander Fleck	779
Scarcity of Swallows.—Andrew Pride	779
Earthworms Drowned in Puddles.—R. B. Marston	779
The Neglect of Science.—Prof. Sydney J. Hickson, F.R.S.	779
The Determination of Sex. (With Diagram.) By Prof. R. Goldschmidt	780
Further Remarks on Relativity. III. By Sir Oliver Lodge, F.R.S.	784
Cohesion. By Dr. Herbert Chatley	786
International Conference of Chemistry	787
Obituary:—	
Prof. G. Lippmann, For. Mem. R.S.	788
Capt. W. E. Rolston	789
Samuel Alfred Varley. By C. B.	789
Notes	790
Our Astronomical Column:—	
The August Meteoric Display	793
The Bright Object near the Sun	793
Continuation of the Ephemeris of Eros	793
University Education in the United States	794
Recent Work on Minerals and Rocks. By G. A. J. C.	794
Plant Pests and their Control. By Dr. William B. Brierley	795
Studies of Shore Fishes. By W. C. M.	796
The Lac and Shellac Industry in India. By Dr. A. D. Imms	797
Flight of Flying-fishes	797
University and Educational Intelligence	798
Calendar of Scientific Pioneers	798
Societies and Academies	799
Books Received	800



THURSDAY, AUGUST 25, 1921.

Editorial and Publishing Offices:

MACMILLAN & CO., LTD.,

ST. MARTIN'S STREET, LONDON, W.C.2.

Advertisements and business letters should be
addressed to the Publishers.

Editorial communications to the Editor.

Telegraphic Address: PHUSIS, LONDON.

Telephone Number: GERRARD 8830.

University and Civil Service Salaries.

UNIVERSITY teachers, and not least those outside Oxford, will be grateful to the provost of Worcester College for his outspoken letter in the *Times* of August 15, in which he contrasts the higher salaries in the Civil Service with those of university professors and tutors in Oxford. The correspondence which this letter has evoked is most interesting, and raises certain points which have not escaped notice in these columns.

It may be recalled that the Select Committee on Estimates appointed by the House of Commons, in taking evidence regarding salaries, asked the representative of the Treasury questions regarding (1) comparable positions outside the Civil Service, and (2) stipends of university professors and tutors. The provost of Worcester College states that in Oxford "the stipend of the best-paid professorships was, and still is, 900*l.*" In this connection it should be pointed out that the average stipend for a university professor in the other universities and institutions of university rank in England and Wales is about 850*l.* per annum, while not a few receive no more than 500*l.* a year.

On the other hand, there are many Civil Servants receiving double the salary that "the greatest learning and distinction can obtain at Oxford, and many receiving much more than treble such stipends." But this is not the full tale, for the salaries of the permanent heads of Government Departments are at present 3500*l.* per annum—emoluments considerably beyond those received by the highest-paid officials in the universities. The tutorial fellow at Oxford, with his modest 800*l.* a year or so, may perhaps be pardoned if he fails to appreciate the point of view of the writer of the letter to the *Times* who may be taken to represent the views of the Civil Service, when he plaintively refers to the fact that after September 1 the salaries of these permanent heads of Government Departments will be "only" 3000*l.* a year. And all the more so if he believes with the provost of Worcester College that "with few exceptions Civil Servants of the highest class are men who in intellectual attainments, by virtue of which as tested in examination they were appointed, fell considerably short of the standard of a tutorial fellowship at Oxford."

From the point of view of the university teacher, whose emoluments at their highest do not approach to anything like this figure, and at their lowest are mere pittances, the situation is not without irony or even humour. Notwithstanding the very favourable comparison with the staffs of the universities, the Civil Service, we are told, is under the impression that it has not received the consideration to which it is entitled, and apparently is advocating a reference of the whole question of its stipends to the National Whitley Council for the Civil Service! Now it is not our purpose to argue the pros and cons of this question. What we are immediately concerned with is the obvious inadequacy of the remuneration of university teachers. "Academic remuneration is a disgrace to the nation," says one of the correspondents—a Civil Servant—in the *Times*; "University professors are scandalously underpaid," says another; while the provost of Worcester College brings a serious charge against the Government by accusing it of having done much to make it impossible for the universities to attract and retain the service of the very ablest men. Such statements without further support might be open to criticism, but it so happens that they are confirmed by statistics and evidence collected by the Association of University Teachers,

to which reference has been made in these columns on previous occasions.

This is a very serious state of affairs and should give pause to thoughtful men. It is futile discussing the minor elements in the problem when the main facts are of so serious a nature. Whether a Civil Servant or a university teacher puts in more hours of work in a year is quite beside the point and from the very nature of the work impossible to decide. Equally beside the point is the fact that the nation's income from foreign investments has shrunk by a hundred millions per annum. The question is whether the university teacher is, under present conditions, adequately remunerated, and, if not, who is to blame. A permanent head of a Government Department receives 3000*l.* or more per annum, a headmistress of a council secondary school may rise to 700*l.* or 800*l.* a year, whereas an Oxford tutor or a professor in one of our modern universities receives on the average a salary of about 850*l.* a year. Is this just or equitable? Is it likely to maintain, let alone increase, the efficiency of the university by attracting to it the right kind of man?

The universities are doing work of the highest importance to the nation, whether it is examined from the cultural or from the utilitarian side. Without this work national life would be immensely the poorer, and yet the staffs are scandalously under-paid. Already this is reacting unfavourably upon the quality of the candidates for vacant appointments, and in course of time the reaction will become even more pronounced.

For this state of affairs the Government cannot escape criticism; we are in entire agreement with the pertinent remarks of the provost of Worcester College. The University Grants Committee is cognisant of the fact that university teachers are underpaid, and that the universities are more or less in debt. As their sources of income are limited, they naturally and properly look to the Government for further aid. An annual grant of a million and a half is quite inadequate, and, in proportion to the total Treasury grant towards education, wretchedly small. If the University Grants Committee cannot convince the Government of the necessity of augmenting the annual grant to the universities for the particular purpose of increasing the stipends of the staffs, it is about time a more representative body took over its functions.

NO. 2704, VOL. 107]

Famous Chemists.

Famous Chemists: The Men and their Work.
By Sir William A. Tilden. Pp. xvi + 296.
(London: George Routledge and Sons, Ltd.;
New York: E. P. Dutton and Co., 1921.)
12s. 6d. net.

SIR WILLIAM TILDEN, like many other persons, has been frequently struck by the general lack of knowledge, even among well-educated people, of the personal history and achievements of the men who have created epochs in science. This, however, need occasion no very great surprise. If the mass of the community are practically ignorant of science owing to the circumstance that they have been taught nothing concerning it, it is scarcely a matter for wonder that they should have no knowledge even of the names of its most distinguished votaries and no interest therefore in their lives and doings. Yet, as the author says, the story of their lives is not infrequently full of interest, even to those who are not specially attracted to science, or have little concern for its progress.

There has been, however, a great awakening of late. The lesson of our recent experience has been driven home. It required the Great War to enforce it. For generations past a few enlightened men have been preaching, with what seemed to many an almost tiresome reiteration, the truth that science in these days is more than ever at the basis of national welfare and security. The peril of the greatest crisis through which this country in all its long history has ever been confronted has at length aroused it to a recognition of this fact. It is unnecessary to dwell upon the evidence of this belated appreciation. We see it in the general anxiety concerning the present character and sufficiency of our secondary education, in the extraordinary rush of students into our university laboratories and lecture-rooms, in the more general recognition by manufacturers of the relation of science to industry, and, lastly, in the action of the Government in creating, on broad and liberal lines, a great scheme of State-aided endowment of science. The establishment of the Department of Scientific and Industrial Research, with its network of affiliated research associations throughout Great Britain, marks an epoch in the history of science of which it is impossible to exaggerate the significance and potentiality. Of course we must be prepared for wasted effort and wasted money. To muddle through is characteristic of our method. Science

is organised common-sense, and it is scarcely to be expected that a community which has hitherto had little training in the methods of science, and no opportunity of cultivating that habit of mind we designate as scientific, will work its opportunity with a maximum of economy. But the atmosphere thus created is bound to have its effect upon the general intelligence, and perhaps none of the many lessons of the war will prove to be more fruitful or more benign in its results.

One consequence, we may hope, will be a wider interest in, and a more generous appreciation of, the labours of those who have enriched science by discovery. Discovery begets invention, and invention begets wealth and prosperity, material comfort, and happiness in living. Science has innumerable gifts in her horn of plenty which she freely offers to her devotees who worship her assiduously and disinterestedly. But these gifts, precious as they are, seldom directly benefit those upon whom they are first bestowed. Those who receive them—the discoverers—give them away, with little or no expectation of material reward or worldly benefit to the inventors, who in their turn hand them on, on terms, to the rest of the community. It therefore behoves the inventors and the community in general, if only in common gratitude, to show some interest in the lives and fortunes of those who in the unselfish pursuit of truth for its own sake thus enrich their fellow-men.

The book under review appears at an opportune time. In it Sir William Tilden tells the life-story of a number of famous chemists, from the time of Boyle down to our own era. His work makes no pretension to be a history of chemistry. His purpose is to make the general reader acquainted with the personal history and work of certain prominent chemists, whose labours may be said to have been largely directed to a common purpose—the elaboration of the atomic theory. To apply Montaigne's phrase, he has gathered a posy of other men's flowers, binding them together with a silver thread of his own. This thread, which serves to connect the life-histories of a score of eminent chemists, is the conception of atoms as a theory of chemistry. From the wealth of material to his hand it was, of course, necessary to adopt some definite principle of selection. To the extent that the phenomena of chemistry are adequately explained by the atomic theory—that it is, in fact, the bedrock upon which the whole superstructure of the science rests—it may be urged that the work of every chemist conduces to its support, even when

unconsciously directed to that end. Sir William Tilden has sought to draw a distinction between work that he regards as indispensable and that which is merely contributory but not essential to the establishment of the atomic doctrine, and on this ground he excludes all mention of many names that by common consent are certainly to be styled famous. This limitation has its difficulties, of which the author is no doubt well aware. It may be argued that the collective work of the chemists, British and Continental, of the Victorian era has done more to place the atomic theory on a firm experimental basis than all the labours of speculative thinkers from the time of Boyle to the death of Dalton. But the life-work of Laurent, Gerhardt, Stas, Kekulé, Hofmann, and Wurtz, as the author is constrained to point out, and with evident regret, finds no place in his book. On the other hand, it is difficult to see how the phlogistians he deals with, with the possible exception of Cavendish, contributed directly to the foundation of the atomic theory. Their work was for the most part wholly qualitative and empirical. Such work as that of Priestley or Scheele, for example, could afford no substantial basis for such a theory, except as supplying facts which enlarged the scope of the science. But this may be said of the work of every chemist who makes a discovery or pursues inquiry in the random method of Priestley.

In spite of the imperfection and limitations of the basis on which it is constructed, Sir William Tilden has put together a most interesting book which adequately fulfils the purpose for which it was written, which is to enlighten the general reader concerning the personal history and work of men who are distinguished for their services to chemical science and whose labours have permanently contributed, and to a noteworthy and memorable extent, to its development. The notices are pleasantly written, and care has been taken, whenever possible, to verify the biographical facts. The book is suitably illustrated with, for the most part, well-known portraits of the several chemists, and with occasional pictures of their laboratories and of apparatus which they employed. Perhaps the least satisfactory portrait is that of Proust. A better one is to be found in Jaeger's "Elementen en Atomen eens en Thans," which deals substantially with the same general theme as that of the book now reviewed, but carries it down, in its latest edition, to its newest developments, which are, indeed, partly dealt with by Sir William Tilden in the epilogue with which his book concludes.

History of Persia.

A History of Persia. By Brig.-Gen. Sir Percy Sykes. (In two volumes.) Second edition. Vol. i., xxviii+563; vol. ii., pp. xx+594. (London: Macmillan and Co., Ltd., 1921.) 70s. net.

THAT this book, first published in 1915, should already have appeared in a second and enlarged edition is a welcome sign of the times, if we may suppose that its popularity is due, not only to the attractive way in which Sir Percy Sykes has handled his subject, but also to the growing interest that is being taken in Oriental learning by many who before the war never realised the importance of such knowledge, and even now, perhaps, are but half aware how much depends on its cultivation and diffusion amongst us. Without understanding there can be no friendship, and without friendship no lasting peace.

Persia has a history of 2500 years, and what a history! Cyrus, Darius, Xerxes, Behistun, Persepolis, Marathon, Alexander and his successors, the Parthians, Ardashir, Shapur and Nushirwan, the wars with Rome, the overthrow of the Sasanian empire by the Arabs, Islam triumphant, Kerbela and the rise of the Shia, the Bagdad Caliphate, the revival of Persian nationalism, Seljuks and Assassins, the Mongol avalanche, Chengiz, Hulagu, and Tamerlane, the Il-Khans, the spacious times of Shah Abbas the Great, Nadir Shah, the Kajars, the Russian campaigns, the envelopment of Persia, the Revolution, the National Assembly and the first painful essays in constitutional government; all this, too, introduced by an account of yet more ancient civilisations which sprang up, flourished, and expired on Persian soil—Medes, Assyrians, Elam, Sumer, and Akkad—while in his closing chapters the author deals with political and military events of yesterday, including his own adventurous march on Shiraz, the Dunsterville mission, and the Anglo-Persian Agreement.

Obviously a work written on this scale must be either a compilation in the main or else the product of co-operative specialism, a method which will always appeal to students rather than to the general reader, and, in the present case, would probably have required ten volumes instead of two. It is no disparagement to Sir Percy Sykes to say that the chief merit of his history consists in the excellent use which he has made of his authorities, in the apt selection of materials, and in the skill with which they have been woven into a well-balanced and interesting narrative.

To have accomplished so much, single-handed, is a remarkable achievement which easily outweighs some defects of detail and others of a more serious kind. Omissions, of course, were inevitable, but it seems extraordinary that only six lines could be spared for Rashidu'ddin Fadlu'llah, the Prime Minister of Ghazan and Uljaytu, equally eminent (to quote Prof. Browne) as a physician, a statesman, a historian, and a public benefactor, and beyond doubt one of the ablest men whom Persia has ever produced.

The author is at his best in describing actions and events; he can tell a story, he goes straight to the point, and his style is pleasing as well as vigorous. But with the inner or deeper side of his subject he is less at home, and here we find a tendency to emphasise comparatively superficial features instead of bringing out the essential. For example, in the notice of Omar Khayyám he gives a familiar reference to the poet's tomb, together with a photograph, for which we are grateful; but it might have been remarked that the quatrains attributed to Omar, and in part composed by him, derive importance from the fact that, being the work of many different hands, and having accumulated in the course of centuries, they exhibit the character, not of any individual Persian, but of Persia as a whole. This is a slight instance, and Sir Percy is so strong in most respects that he can afford to be a little disappointing in his treatment of literary topics, religious doctrines, dervish fraternities, and such matters as the influence of mysticism upon Persian political history. On the other hand, the strictly historical portion of the work is supplemented by chapters giving much useful information about geography, climate, fauna, flora, and minerals, inscriptions and monuments, architecture and art, etc.

The author knows the country well, and has a genuine, if not very profound, sympathy with its people. His two volumes are lavishly illustrated. For this reason alone, not to mention the pocket-maps which accompany them, they are valuable to students, while from what has been said concerning the range and variety of their contents it will be clear that they ought to find a place in the library of everyone who is interested in Persia.

The Kinetic Theory and the Quantum.

The Dynamical Theory of Gases. By Prof. J. H. Jeans. Third edition. Pp. vii+442. (Cambridge: At the University Press, 1921.) 30s. net.

THE first edition of this book was published in 1904, the second in 1916, and now, only five years later (and three of those were war years),

a new edition is required. By itself this indicates the value of the work, and it is also very satisfactory as showing the growth of interest in this important branch of mathematical physics. The main part of the book has scarcely been altered—indeed, too little so, for a good many of the misprints of the second edition have appeared again. In dealing with viscosity and heat conduction, Chapman's important work is given somewhat more fully than before; but it would, of course, be out of the question to reproduce in detail the stupendous formulæ which it involves. The only other point we will mention is to express a doubt whether the author's explanation of irreversibility really does explain that exceptionally difficult question. To put it in an extreme form, has anyone yet really discovered what distinguishes the past from the future?

The main changes are the additions at the end of the book, which deal with the quantum theory, and it must be confessed that we found these in some ways rather disappointing. A certain lack of harmony is produced by the policy of grafting a few chapters on the quantum on to the end of a book originally written before its existence was accepted. It must be recognised that it is a very difficult task to fit the subject in, for it is clearly right to give a complete account of the quantum; yet its field is a great deal wider than the mere kinetic theory of gases, so that its introduction necessitates the treatment of several other branches of physics, some of which are by no means elementary. What the author has given is certainly the most important part of the quantum theory—there is an excellent account of spectra, and also of the Debye theory of the specific heats of solids. The theories of Tetrode, Keesom, and others on the equations of state of gases, however, are barely mentioned; it is true they rest on much less firm foundations than the other questions, but still they are far more closely related to the subject-matter of the rest of the book, and their exposition would not have taken very long. Also the author gives only a very short discussion of the rotations of molecules, though there is direct experimental evidence as to their moments of inertia, and though Ehrenfest's formula for the specific heat of a gas is a type of function novel to the quantum theory. Again, it would have been interesting to have had more of an exposition of the method of solving problems by direct use of the relation of entropy to probability as typified by Planck's original calculation of the radiation formula. This method seems to us, on the whole, inferior to the author's, but it has been used a great deal, and must be understood by anyone who wishes to read the original papers of the subject.

In view of the greatly extended field that these chapters cover, only shortened proofs of many important theorems are given, and some of these are not fortunate. For example, in dealing with the displacement law of Wien the author states that the energy in each wave-length is unaltered during the change of wave-lengths, whereas in fact part of this energy is turned into work, and its disappearance is the essence of the process. Again, the author calculates the equilibrium between the energy of a vibrator and that of the surrounding electromagnetic field by finding separately the amounts of energy absorbed and emitted. This is essentially a problem of resonance, but in the calculation of the absorption the damping factor is omitted without justification. In this particular case the correct proof is no longer or more difficult than the author's.

In a subject like this, based as it is on very uncertain foundations, it must have been exceptionally hard to select what was sufficiently well established to merit inclusion. It will be seen that our chief quarrel with the author is that he did not give us enough. The book contains a great deal of invaluable information critically treated, which it would be hard to find elsewhere in English. If we have laid emphasis on the defects, it is because the excellences of the work are well known.

C. G. D.

Beast and Man in India.

Companions: Feathered, Furred, and Scaled. By C. H. Donald. Pp. ix+159. (London: John Lane; New York: John Lane Co., 1920.) 7s. net.

THESE are vivaciously written reminiscences of Indian animals with which Mr. Donald managed to establish friendly relations. The first is the tale of a bear-cub, Bhaloo, with a strong sense of humour which became very expensive to his owner. The second tells of the rearing of two weaver-birds (*Ploceus baya*), which justified their reputation for inquisitiveness and educability. A weaver, "carefully and kindly taught, will, within a week, let off a toy cannon, select a particular number out of many cards, and bring it to his master; he will catch a two-anna piece which has been thrown into a well before it reaches the water, and bring it back. Some of his tricks seem absolutely incredible, and yet they are simplicity itself, and one and all may be taught in a couple of days each. The first and most important step in his training is to teach him that an open hand means food, and that a closed fist does not. Everything hinges on his mastery of

this secret, and the rest is simple." Of some interest are the instances given of apparent mistakes in building the wonderful nest, such as leaving no doorway.

The third companion was a flying squirrel (*Pteromys*), which moved along the ground in a succession of jumps, "rather a lumbering gallop," soon bringing fatigue. "The leap of the flying squirrel is said to be sixty to eighty yards, but I can safely say it is well over double that distance at times, as I have seen one go right across a valley nearer two hundred yards in extent." "On approaching the tree it means to settle on, the head is raised and the tail lowered so that the parachute then acts *against* the wind as a brake, bringing it slowly against the tree. The tail, to some extent, acts as a rudder, but the change of direction is really made by a slight drawing in of the extended limbs, on the opposite side to that to which the animal wishes to turn." Mr. Donald seems to have been happy with his varied companions, and they seem to have been happy with him. He tells us of his golden eagle (not, however, to be called *Chrysætus*, which spoils the name), of an Isabelline bear, a bull-terrier, a rock-python which could lift three chairs with its tail, and was happy on six crows every Sunday; of hawks and langurs; and more besides. He ends with a fascinating sketch of a fox, which suggests that the secret of domestication has not been lost. This is an enjoyable book, racy, objective, and shrewd, and it has excellent photographic illustrations. We like well enough some of Mr. Donald's pet names for his companions, such as Bhaloo for the bear, and Satan for the python; but Juggins for the golden eagle touches us on the raw.

Our Bookshelf.

Insect Life. By C. A. Ealand. Pp. xii + 340 + lxxiv plates. (London: A. and C. Black, Ltd., 1921.) 30s. net.

In this sumptuous and profusely illustrated volume Mr. Ealand attempts "to provide a text-book of entomology, useful alike to the serious student and to the reader who takes up the subject as a hobby." To us he appears to have fallen between two stools. The opening chapter on classification raised our suspicions when we encountered more than five pages of tabular classification of no possible value to the "serious student," for no hint is given of the basis employed, while to the reader with entomology as a hobby it is positively soul-destroying to be faced with a prodigious list of mere names. The second chapter, on social habits, colouring of insects, and economic questions, is more readable, provided one already possesses

a considerable knowledge of insect orders and suborders. From chap. iii. onwards, however, the accounts of the several orders, etc., are of no value to the specialist, and of but little interest to the amateur. Nowhere do we find either an account or an illustration of the essential structure of an insect, or even of the mouth appendages; true, the serious student should know the main facts about these; but where will he be if his serious study should by misfortune begin with "Insect Life"?

Many of the illustrations are beautifully coloured and do immense credit to the publishers; but the object of the author seems to have been to arrange a striking plate rather than to display the structural features of the insects. Thus in the coloured plates of the *Coleoptera* many brilliant and beautifully coloured species are shown, but the majority have their legs tucked away out of sight beneath the body, so that the tarsal joints are entirely invisible, and in some cases the antennæ are in the same plight. The figures (copied from Shipley's "*Zoology of the Invertebrata*") showing the emergence of the dragonfly imago from the nymph are peculiarly unfortunately arranged, for, as in the original, instead of being placed vertically, the drawings have been turned round into a horizontal position, with the result that the dragonfly is shown emerging in a position that is absolutely impossible and absurd. It is unfortunate that so showy a book contains so little of real value.

A History of Psychology. By Prof. G. S. Brett. (Library of Philosophy.) Vol. ii., *Mediaeval and Early Modern Period*. Pp. 394. Vol. iii., *Modern Psychology*. Pp. 322. (London: George Allen and Unwin, Ltd.; New York: The Macmillan Co., 1921.) 16s. net each.

THE first volume of this work was published in 1912. Starting with an account of primitive animistic notions, it carried the history through the periods of Greek philosophy and Greek Christian philosophy to St. Augustine. The two volumes now added deal, one with the medieval and early modern period to the end of the seventeenth century, the other with the modern period, ending with a final chapter on "The Scope of Modern Psychology." It is difficult to appreciate the purpose or the usefulness of a work of this kind, however much we may admire the devotion and research which have produced it. As an encyclopædia it is of little value, for the simple reason that one human author cannot be encyclopædic. He cannot be a first authority in regard to all the writers with whom he deals. Also it is misleading to describe animistic speculations or even philosophy of mind as parts of the science of psychology. As a matter of fact, the modern science of psychology has little or nothing in common with the theories here recorded, and owes nothing to them.

A more serious criticism, however, is a negative one. Information we naturally expected to

find and which might have made the history of real value is omitted. One illustration is typical. There is a chapter entitled "From Fechner to Wundt." If the reader should refer to it for an account of the psycho-physical law which has made Fechner's name famous, this is what he will find:—"The law known as the 'Weber-Fechner Law' has been so often described and discussed that we may be excused the task of repeating its definition." Practically all we are told about it is that "volumes have been written on it."

The Bases of Agricultural Practice and Economics in the United Provinces, India. By Dr. H. Martin Leake. With a foreword by J. MacKenna. Pp. viii+277. (Cambridge: W. Heffer and Sons, Ltd., 1921.) 15s. net.

THE author of this illuminating book has applied himself to the elucidation of the bases and development of agricultural practice and economics, showing how improvements in methods of farming must necessarily be associated with the due recognition of economic factors if true advance is to be made. Although the text deals solely with India, the underlying principles are applicable to agriculture the world over, and the book throws fresh light upon the new problems that are constantly arising now that scientific principles and methods are being more widely applied to farm practice.

Agricultural practice is essentially based on the relations between the soil and atmospheric conditions and the crops grown, and these are set forth factor by factor, careful distinction being made between those which can and those which cannot be controlled. Possibilities of development and improvement are discussed with special reference to such points as hybridisation and selection, cultivation and manuring, as adapted to Indian conditions. Parallel with this, the economic aspect is considered, particular stress being laid on the possibilities that lie in co-operation of various kinds as a factor in the encouragement of agricultural development.

The book is strongly to be recommended, not only to those connected with Indian agriculture, but also to all who are interested in the progress of modern scientific farming, for the conditions discussed are so varied that they provide scope for the consideration of strongly contrasted aspects of the subject.

W. E. B.

Groundwork of Surgery. (For First-year Students.) By Arthur Cooke. Pp. viii+183. (Cambridge: W. Heffer and Sons, Ltd.; London: Simpkin, Marshall, Hamilton, Kent, and Co., Ltd., 1919.) 7s. 6d. net.

WRITTEN by one who is himself a thinker, worker, and teacher, this book furnishes the beginner with an excellent introduction to the science, art, and craft of surgery. Most manuals are addressed by the expert to other experts, or at least to advanced students. In the present volume the author sets himself, very successfully, to lay the

foundations on which a more detailed knowledge may be reared. The ground which surgery covers is indicated, and its broad outlines are defined; space is given to preventive treatment and surgical sanitation generally; and the main surgical affections of the different regions of the body are described. The book may be cordially recommended.

College Botany: Structure, Physiology, and Economics of Plants. By Dr. M. T. Cook. Pp. x+392. (Philadelphia and London: J. B. Lippincott Co., 1920.) 12s. 6d. net.

IT is said of this book by the author that it is "an effort to meet present conditions," but it is not very clear what these conditions are. The book is divided into sections on morphology, physiology, and classification, the last including general descriptions of the great plant groups. Some of the drawings, such as Fig. 30, representing a lenticel, and Fig. 152, depicting the pine cone and its parts, can only be described as crude; but the photographs of individual plants, of which there are many, are much more successful. A number of maps are given showing the various areas of crop production in the United States, and economic plants of all kinds are frequently introduced into the descriptions. The book would seem to be most suitable for American students beginning the study of agriculture.

Experimental Organic Chemistry. By Prof. A. P. West. (New-World Science Series.) Pp. xiii+469. (London: George G. Harrap and Co., Ltd., 1921.) 10s. 6d. net.

THEORY and laboratory experiments in organic chemistry are combined in this book. Only the more important compounds are discussed, and experiments of a difficult or dangerous character are purposely omitted. Review tables, giving at a glance the chemistry of groups of compounds, are supplied at frequent intervals. The theoretical part of the book is somewhat less satisfactory than the practical, for it is frequently very condensed. The book is well printed and illustrated. This is one of the very few elementary books on organic chemistry which give an accurate description of fractional distillation.

Reports of the Progress of Applied Chemistry: Issued by the Society of Chemical Industry. Vol. v. 1920. Pp. 626. (London: Society of Chemical Industry, n.d.) 15s.

THE annual reports on the progress of applied chemistry issued by the Society of Chemical Industry fulfil the same functions for applied chemistry as do the annual reports of the Chemical Society for pure chemistry. They constitute a most useful and authoritative review of the work done during the year. The present volume is the work of experts in the various branches of applied chemistry, and can be recommended to all who wish to keep in touch with the rapid progress of chemical technology.

Letters to the Editor.

[The Editor does not hold himself responsible for opinions expressed by his correspondents. Neither can he undertake to return, or to correspond with the writers of, rejected manuscripts intended for this or any other part of NATURE. No notice is taken of anonymous communications.]

The Natural History of Man.

IN an article on "New Experiments on the Inheritance of Somatogenic Modifications," in *NATURE* of February 3 (p. 742), Prof. Arthur Dendy writes: "It has long been suspected that the problem of the transmission from parent to offspring of somatogenic modifications ('acquired characters') might be solved more readily by physiological experiments directly involving the complex metabolism of the body than by crude surgical operations, such as the amputation of limbs." He proceeds to tell us of experiments which are thought to demonstrate that when certain toxic substances are injected into the blood of pregnant rabbits a deterioration of the eyes of the offspring sets in, which is transmitted and increased generation after generation.

Now examine the other side of the shield. Let us use a little of the evidence from associated sciences which zoologists and botanists have ignored. It has been said by naturalists that man is a domesticated animal, meaning, probably, that man is a social animal like ants and bees. Man is a typical wild animal, living under an enormous variety of conditions, which have become perfectly natural to him. At any rate, he is not under artificial selection. Again, it has been said by opponents of Darwin that no one has seen natural selection in operation, and that, therefore, its existence is a pure guess; and by yet others, supporters of Darwin, that man has escaped from selection. As a fact, every man, except the biologist as such, has seen natural selection in full blast, and, so far from having escaped from selection, man is everywhere stringently selected in a glaringly obvious way. Indeed, since we are able to follow the career of men with a completeness that is unique in the animal world, man is the only animal in which natural selection can be observed and its consequences traced to the last little detail. Apart from each man's personal experience and a voluminous literature, it is the principal function of all Departments of Public Health to collect precise statistical information bearing on this very subject.

Man is the prey of a multitude of living microbial species, which have become parasitic on him, and attack him in all sorts of ways and with every degree of stringency of selection. It is common knowledge that men vary in their powers of resisting various microbial diseases, and that these powers of resistance tend to "run in families" (*i.e.* are inheritable), as is conspicuously the case in tuberculosis—a fact which is still better observable when we compare men of different races; for example, West African negroes and Englishmen in respect to tuberculosis and malaria. Again, it is common knowledge that powers of resisting any disease do not necessarily imply powers of resisting another disease.

Here, then, is natural selection indubitably manifest in the only wild species in which observation of its operations is possible. What is the effect on races? Does any change result? If so, does it accord with Lamarckian or Darwinian doctrine? It may be laid down as a rule to which there is no exception that *every human race is resistant to every prevalent and lethal human disease in proportion to the length and severity of its past experience of that disease.* Here, then, is evolution indubitably manifest as a consequence of natural selection.

But this recital gives no conception of the fidelity

with which evolution follows selection. Not only does selection by any disease cause evolution against itself alone, but there are also two main types of diseases which select in unlike ways and cause extraordinarily unlike racial effects. In one group (*e.g.* measles and smallpox) the microbes flood the victim with toxins, soaking even his germ-cells. He dies; or, reacting against these toxins, recovers within a definite period, the duration of which, speaking generally, varies with the abundance and virulence of the toxins. Recovery implies "acquired" immunity, which is often of life-long duration, and is simply a "use-acquirement"—a response to functional activity. The individual has become "used to," or trained by, the toxins through some physiological process, just as he becomes used to tobacco, or exertion, or the performance of difficult and complex thinking. Practically everyone is susceptible to this class of disease. As a rule, therefore, the survivors are not those who resist illness, but those who recover from it. In the other group (*e.g.* tuberculosis and leprosy) the microbes retain their poisons within themselves, and the illnesses caused by them are usually prolonged and of indefinite duration. The survivors are, as a rule, not those who recover from illness, but those who resist it, *i.e.* those who are "innately" immune. In this class of disease individuals vary greatly in resisting power. Thus, in tuberculosis, there are those who seem quite immune under the worst conditions, those who fall ill under bad conditions but recover when the conditions are improved, those who die after lingering illness, and those who perish swiftly and, as a rule, in early life. Here there is no "acquired" immunity; whoever is infected suffers nothing but injury.

Plainly in disease we have on a vast scale just those "physiological experiments directly involving the complex metabolism of the body" concerning which Prof. Dendy is so hopeful. If the Lamarckian doctrine be true, diseases of the measles type should, by the "transmission of acquired immunity," render the race less and less susceptible to infection until it acquires "innate" immunity; on the other hand, diseases of the tuberculosis type should enfeeble the race by the accumulation of injury until at last it perished. But nothing of this has happened. On the contrary, racial changes have followed precisely contrary lines, those of natural selection. Thus Englishmen who have long been exposed to measles are fully as susceptible to infection as Polynesians, but recover from illness more easily and frequently; whereas races which have long been exposed to tuberculosis (*e.g.* Jews) resist infection much more stoutly than those that have been less exposed (*e.g.* American Indians). The diseases of animals and plants (*e.g.* in the fly districts of Africa) tell the same story, but here natural selection cannot be as closely studied as in the case of man. We see only the consequent evolution. Now compare as to volume and duration the minutely studied and easily observed physiological experiments of Nature which Prof. Dendy ignores with those to which he pins his faith. Obviously, if anyone did establish that the injection of a toxin caused hereditary degeneration, he would discover, not a rule, but one of the rarest exceptions in Nature.

In order to demonstrate the importance of disease selection, it is worth while to pursue this subject a little further. Doubtless there have been many great human migrations, but two especially are recorded in history—that immense surge of Eastern people which established in their present sites many of the modern races of Europe, and that still vaster overflow which carried the inhabitants of modern Europe to the Western hemisphere. If history teaches any lesson with clearness, it teaches this—that unless

conquered peoples are exterminated they invariably absorb or expel the conquerors. Hence the disappearance of the Greek, Roman, Saracenic, Norman, and Turkish governments.

All, or nearly all, human microbic diseases appear to have originated in the Eastern hemisphere, where men first multiplied sufficiently to provide a constant supply of nutriment to the parasites. Myth and history tell first of epidemics. Such diseases as measles suddenly appeared, attacked young and old, and then, having exhausted the food supply, passed to neighbouring populations, leaving behind a human remnant which had acquired immunity. Later, when populations became more dense, the multitudes of new births furnished a perennial supply of food, and enabled many of these diseases (e.g. measles and whooping-cough) to become endemic. Epidemic disease, especially if occurring at rare intervals, is always the more terrible; for the old as well as the young are affected, and in consequence the sick are left untended, business is neglected, and famine follows. Many perish who would otherwise have survived. Witness in modern times the fate of many Pacific Islanders. Endemic disease selects more stringently, but more cleanly; the old who have acquired immunity tend the young, and only the less resistant die. Some maladies, especially those which are insect-borne (e.g. malaria), are confined to localities, but most others are, in varying degrees, "crowd" diseases. Thus in England no one escapes frequent contact with measles and tuberculosis, which cause illness unless the individual be immune, and death unless he be resistant. All such diseases tend to become endemic as the crowd thickens. We speak of the deadly climate of West Africa; but that of England is even more deadly to visitors from thinly scattered tribes (e.g. nearly all savages). There is no evidence that any human race is mentally unfitted for civilisation, but there is the clearest evidence that, physically, only those races are capable of it which have evolved in response to that slowly increasing stringency of selection which occurs when populations gradually become more dense.

Of old the sword exterminated the conquered and dug deep the foundations of permanent empires. With advancing civilisation and the cessation of deliberate extermination, it lost its power. But when Columbus ended the long separation between East and West he bore weapons more deadly than the sword. Except malaria he met no considerable diseases, but the microbes of the East found virgin soil. Thereupon commenced the greatest event and tragedy in human history. The races of one half of the world began to replace those of the other half. As in the ancient Eastern world, measles, small-pox, and other diseases of definite duration swept the continent in vast epidemics. They left behind them an immune remnant. But tuberculosis, endemic from the first, owing to its long duration in the individual, exterminated wherever the conditions favoured its spread. Spain and Portugal, then powerful maritime States, and first in the field, elbowed the weaker British and French into the seemingly inhospitable North. But, while the tropics were defended by malaria, nothing protected the North, where British and French settlers poured into the vast void created by imported diseases. The former won the battle of Quebec. French immigration ceased, and all North America fell into the grasp of the Anglo-Saxon. Later the microbes created, and the Anglo-Saxons are now filling, another void in Australasia. Thus our race won a place in the sun, and to-day has more room for expansion than any other race. In actual truth, even if soldiers, sailors, and settlers founded the British Empire, it was the microbes that established it on enduring foundations.

Germany began her war a century too late. If history repeats itself, the Anglo-Saxons are sure to lose their Eastern conquests, where every European settlement is surrounded by a flourishing native quarter; but seemingly they are rooted for ever in the West, where the natives can exist only in the wilds. Every travelling disease has reached almost its limits, and therefore diseases, like the sword, are losing their power of founding permanent empires. The period of the great human migrations is drawing to an end.

The story of the evolution against narcotics is similar. For example, individuals differ greatly in their degree of susceptibility to the charm of alcohol. Some men swiftly acquire an intense craving for deep indulgence in it; but most of us are temperate without effort or very little effort. In other words, we have no great susceptibility. Speaking generally, moderate drinkers are not those who resist temptation, but those who are not greatly tempted. Habitual heavy drinkers are always much tempted. Alcohol is a poison which especially affects the habitual heavy drinker, not only killing the worst cases, but also making many more susceptible to numerous ills—for instance, tuberculosis. Every race (e.g. Jew, Greek, Italian, South German, South French, Spanish, Portuguese, West African) which is now temperate in the presence of abundant supplies of alcohol was anciently drunken. That is, every race is insusceptible to the charm of alcohol in proportion to the length and severity of its past experience of it. Precisely the same is true of opium. Natives of India take it in moderation; the Chinese in greater excess, but in less excess than formerly; while Burmans and Australian blacks indulge immoderately and perish swiftly. Nature's un-failing plan of temperance reform is to remove the heavy drinker. The human plan is to remove drink and leave the potential drinker to multiply. But yeast and sugar cannot be eliminated, and human, unlike natural, laws are sometimes disobeyed, and are never immutable.

I have tried to sketch a little of the natural history of man, concerning which so little has been written, but which, even politically, is so much more important than his voluminously described political history. The evidence, none of which I think is disputable, is derived mainly from medical and historical sources, but the problems which arise are biological. They are too big for doctors and historians, who are mere specialists. Meanwhile what has biology done to establish the actuality of natural selection? She has measured some frozen sparrows, she has suffocated some crabs, and she is now conducting some "physiological experiments" to ascertain whether "acquired" characters are "transmissible." Some of her eminent professors have declared that natural selection is a myth, and the pulpits of the contemners of science are filled with acclamations.

But it is mind which presents biology with the greatest of her problems, tasks, and opportunities. Man is the educable animal. On the mental training of his young depends the intellectual status of the individual and the social status of the community. Men of science, especially biologists, frequently urge scientific education. What is it? It implies, I conceive, the supplying of information which is likely to be useful, intellectually or materially, in such a manner that the pupil is left a skilful, unbiassed thinker with an open, receptive, reflective habit of mind. So far as possible he is taught, not what to think, but *how* to think. In the opposite type of education an endeavour is made to close the mind—to bias, to stupefy, to induce an artificial incapacity to profit from fresh experience; to hold beliefs even in the face of conclusive evidence; in brief, to teach the pupil *what* to think, not *how*

to think. Compare, as products of these opposite types of mental training, Darwin and Huxley with devout Mohammedan and Hindu ecclesiastics. The evidence in favour of scientific education is enormous, decisive, indisputable, but it lies outside the sphere of botany and zoology, in psychology and history. By whatever rational standards we judge human communities—material or intellectual progress, efficiency in peace and war, wealth, enterprise, energy, the production of great thinkers and men of action, civil war, brigandage, murder and other crimes, and so on—we find invariably that the societies the mental training of which has most nearly approached the scientific ideal are the superior. Compare the results of the mental training given by Socrates and his fellows to the ancient Greeks with that given by the Russian popes to their victims. Many nations (*e.g.* the Romans) have fallen because a change for the worse in mental training left descendants too inefficient to preserve that which better-trained ancestors had secured. Many nations (*e.g.* after the Reformation) have arisen because improved mental training enabled them to surpass competitors. Consider the late war and how completely the more biassed peoples have been smashed. But this is a subject too vast for present consideration; I have tried to deal with it elsewhere.¹

I may be right or wrong as to the conclusions I have reached, but clearly the evidence and problems I have instanced exist. Clearly they are matters for biology, although they have been neglected by her.

Academic biology is of little account in the world. The hobby of some naturalists who use not a tittle of the evidence available, she possesses next to no established truth. Her few students are engaged in unending disputes, all of which are consequent on a misuse of words or a neglect of crucial testing. Her indefensible terminology separates her from a host of subsidiary sciences. But a biology clarified and simplified by a precise terminology, and in possession of a classification of characters similar to that employed in other studies, might easily become the queen of sciences. A few wide generalisations accepted by everyone would then replace the present chaos of opinions, and provide a basis for work of practical utility. The use of evidence from other studies would make their students her own. So strengthened, she would become a power in the land, and perhaps lay the foundations of that golden age of science and human wisdom and well-being of which we all dream.

Surely there are biologists who perceive that the failure to establish truth can have no cause other than lack of right scientific method, and who are prepared to substitute the method of discussion which has created other sciences for that of controversy which has wrecked biology.

G. ARCHDALL REID.

Magnetic Double Refraction of Smokes.

THE interesting discovery recorded by Sig. Tieri in *NATURE* of August 18, p. 778, that the fumes from an iron arc can, when subjected to the action of a magnetic field, rotate the plane of polarised light, is in close accord with the view of the structure of such fumes advanced by Prof. Elihu Thomson in his recent letters to *NATURE*, and agrees also with the observation of Mr. Speakman and myself (see *NATURE*, June 23, p. 520; and July 14, p. 619).

Prof. Thomson explains the sudden enhanced luminosity of the light scattered by the iron oxide smoke when the magnetic field is applied by the particles arranging themselves along the lines of force. For this structure to be effective the particles

cannot be spherical, but must consist of rods or chains, for only then would the intensity of the reflected or scattered light vary with "end on" or "length on" incidence. This was confirmed by a microscopic examination of the iron oxide fume, which showed the particles to consist of short strings or chains of roundish beads not touching one another.

The experience of Mr. Speakman and myself is that the fumes from metallic arcs in air undergo rapid changes with time. The minute particles produced at first by condensation of vapour aggregate together to form complexes, which often show a definite chain-like structure when examined after deposition on a slide, but in the air are continually altering their form under molecular bombardment.

Now it seems likely that if by magnetic or electric forces the small chains or strings can be made to space themselves with their axes all in one direction, not only will the effect described by Prof. Thomson be produced, but a beam of polarised light traversing the fume at right angles to the field of force would suffer rotation provided that the plane of polarisation is neither parallel nor at right angles to the longer axes of the small chains. This is just what Sig. Tieri finds, and it might be expected further, if the above explanation is the correct one, that the magnetic double refraction would vary with the age of the smoke and its method of production. The bluish-coloured smoke found by Prof. Thomson to accompany the yellow fumes from the iron arc, and which did not exhibit the magneto-optical effect, consisted probably of single particles, and would be unlikely to show magnetic double refraction. It corresponds with the initial stage of the oxide clouds we have studied before agglomeration has had time to occur.

This striking behaviour of iron oxide dispersed in air discovered by Sig. Tieri exhibits a close parallel to the behaviour of the same substance dispersed in water. Cotton and Mouton and others have investigated the magnetic double refraction of iron oxide hydrosol, and they ascribe the effect to the orientation of rod-shaped or lamellar ultramicros. Further, the magnitude of the effect was found to increase as the colloid became coarser.

A continuation of the work commenced by Sig. Tieri may well lead to much interesting information on the form of the particles in smokes.

R. WHYTLAW-GRAY.

Eton College, Windsor, August 21.

The Contractile Vacuole.

IN connection with previous correspondence on the mode of production of the contractile vacuole in Protozoa (*NATURE*, vol. cvi., pp. 343, 376, 441), I find that it is, in point of fact, Prof. Marcus Hartog to whom the credit of the osmotic view is to be given. In a communication to the British Association in 1888 (Rep., p. 714) this observer pointed out that, owing to the semi-permeable surface membrane, substances in solution in the protoplasm of these organisms must attract water, which accumulates at a particular spot until it reaches the surface, breaks through the membrane, and escapes. The membrane spontaneously closes up as the distension is relieved. Prof. Hartog shows that if substances such as sugar or potassium nitrate are dissolved in the outer water to a sufficient osmotic concentration, the production of the vacuole ceases. The paper was reprinted in *Ann. Mag. Nat. Hist.*, Sec. 6, vol. iii., p. 64 (1886). The theory was worked out in more detail by Degen (*Bot. Zeit.*, vol. lxvii., abt. 1, 1905), and is explained by Prof. Hartog in his article on Protozoa in the *Cambridge Natural History* (1906),

¹ *Vide* "Prevention of Venereal Disease," reviewed in *NATURE*, April 14.

p. 15. My knowledge of Stempell's paper was derived from an abstract in which the osmotic aspect was chiefly emphasised. On reference to the original I find that this part of the process is obscured by a number of complicated subsidiary hypotheses.

W. M. BAYLISS.

University College, London.

A Correction.

SOME months ago Sir Ray Lankester was good enough to write to me in regard to the statement in my "System of Animate Nature" (1920) that he had spoken of evolution as "a chapter of accidents." He asked me to verify the quotation, and I thought I had only to turn to my book-shelves for a minute to find the passage. But in spite of some months of very agreeable and profitable re-reading of Sir Ray Lankester's writings, I have failed to verify the quotation, and the only thing to do is to apologise. Perhaps I should have seen that the phrase I ascribed to Sir Ray Lankester was inconsistent with such sentences as these:—"Thus then it appears that the conclusion that Man is a part of Nature is by no means equivalent to asserting that he has originated by 'blind chance'; it is, in fact, a specific assertion that he is the predestined outcome of an orderly, and to a large extent 'perceptible,' mechanism" ("The Kingdom of Man," p. 9); and "They [the mental qualities which have evolved in Man] justify the view that Man forms a new departure in the gradual unfolding of Nature's predestined scheme" (*op. cit.*, p. 25).

I yield to no one in my appreciation of the services which Sir Ray Lankester has rendered to zoology and biology, and I can only express my regret that in a busy life I made a mistake which amounts to an unintentional misrepresentation.

J. ARTHUR THOMSON.

Natural History Department, Marischal
College, University of Aberdeen, August 16.

Wrightson's Hypothesis of Audition.

THE hypothesis advanced by the late Sir Thomas Wrightson in his book "An Enquiry into the Analytical Mechanism of the Internal Ear" has, it would seem, received such wide acceptance that the following comments upon it may be of interest.

Wrightson suggested that the appreciation by the ear of the constituent notes in a musical chord is due to the recognition and measurement by the brain of certain time intervals, which occur between the changes in motion of the air when it is transmitting music. In proof of this suggestion Wrightson gives graphic examples. First he takes two simple sine curves representing two musical notes, and from them he obtains a third curve which shows the motion of the air when both notes are sounding together. On this compound curve he marks distances between crests, troughs, and crossing points which are equal to the wave-lengths of the two separate notes.

From the identity of these distances Wrightson concludes that when the observer appreciates the constituent notes in a chord he does so by recognising the existence of these time relationships.

I find, however, that this proof loses its value, since it can be shown by trial that purely arbitrary wave-lengths are also represented in the compound curve as frequently as are those of the notes actually present.

It is scarcely possible, therefore, to accept Wrightson's explanation of the power of analysis possessed by the ear, since, all wave-lengths being equally repre-

sented, there is no criterion by which the right notes can be recognised and the arbitrary ones excluded.

This criticism, considered in conjunction with that of Boring and Titchener (*American Journal of Psychology*, vol. xxxi., 1920, pp. 101-13), would seem to take from Wrightson's theory almost all the essential features which individualise it from the older telephone theory of Rutherford. H. HARTRIDGE.

The Generation of Heath-fires.

IT is the general practice to attribute the heath-fires which have been so common of late to the careless dropping of matches or to the camp-fires of picnic-parties. But this is not always the cause. An instance came under my notice during the late hot weather which seems to be worth recording. I was walking along one of the ridges at Finchampstead, Berks, and to the south was a fairly steep slope of peaty heath land, giving rise here and there to clumps of bracken, but exposed each day to the sun's rays for many hours at a time. Noticing some smoke emerging from the soil, I turned down the slope to stamp out a possible fire, and I found that as soon as it was put out in one place it emerged elsewhere, a foot or so away. My companion and I repeated the process in many places, but soon we saw that the smoke was emerging from a hundred places, and our efforts were useless. Smoke was rising out of the peaty soil over an area of at least a quarter of a square mile, and another hour of the sun's heat might have been sufficient to result in the place breaking into flame.

From a note in NATURE of January 27 last, p. 704, in regard to the spontaneous burning of coal-seams in the United States, I see that the fine dust of lignite may ignite at 150° C., and I suggest that in the case in point the finely divided carbonaceous soil may have been undergoing such changes under the heat of the sun, which may have brought up the temperature to something approaching this. Anyway, here was a considerable area smoking under the intense heat, and ignition could not have been far off.

EDWD. A. MARTIN.

South Norwood, S.E., August 13.

Cornalith.

IN the *Bulletin of Agricultural Intelligence* issued by the International Institute of Agriculture, just to hand, there is a précis of an article in the *Annales de Gembloux* under the heading "Plastic Materials with a Casein Basis: Galalith and Cornalith." The latter word is not in the N.E.D. or in the recently published "Dictionary of Scientific Terms." Galalith, or "milk-stone," is well known, and cornalith will be "horn-stone." The first sentence in this précis reads: "Galalith and cornalith, two substances made from casein that has been treated with formalin, are produced now in various countries, especially in France, where there are already several factories."

It is stated that, in order to diminish the cost of opaque articles made from casein treated with formaldehyde, the raw material is sometimes mixed with the refuse of horns, horsehair, and other nitrogenous matter. When this is done is it called "cornalith," and, if so, does the name or term correctly describe the material?

It is also stated that attempts have been made to use vegetable casein extracted from soya beans, as being less expensive than casein obtained from milk. Has this been successfully accomplished, and, if so, can the resulting plastic material be called "galalith," or is some other term used? R. HEDGER WALLACE.

August 16.

Pulverised Coal as a Combustible.

By SIR R. A. S. REDMAYNE, K.C.B.

COAL, which has, ever since the growth of modern industrialism, proved the main source of artificial heat, power, and light in civilised countries, is likely to continue to occupy that position for very many years to come. In some industries it constitutes the chief item of cost in production; in others it is second only to that of labour. Its importance, therefore, as a factor in the cost of living is very great indeed. That the price of coal, at any rate for a long time, will be maintained beyond a pre-war level cannot, I think, be controverted. The higher wage demands of labour incident to the advance in the standard of comfort claimed are not likely to be so abated as to bring wages down to a pre-war position; for the same reason the cost of the materials so largely used in mining—*e.g.* timber, steel, lubricants, and machinery—will remain at a high rate. The chief hope of securing a reduction in the cost of production must lie along the lines of research. Similarly, also, the reduction in the cost of our fuel bill must be sought in economy in use—that is to say, in an endeavour to use efficiently every calorie available in the fuel.

In this connection the use of coal in the form of dust has for some few years been occupying the attention of engineers, particularly during the last five years, and more especially in North America. In the year 1919 the Fuel Research Board published a brochure on the subject, and the May number of the *Bulletin de la Société d'Encouragement pour l'Industrie Nationale* contains a most interesting article by M. Frion entitled "Le Chauffage au Charbon pulvérisé," being a report of the "Commission d'Utilisation des Combustibles," in which it is stated that "le développement devint assez rapide à partir de cette époque, et actuellement les industries du fer et de l'acier emploient environ 3 à 4 millions de tonnes de charbon pulvérisé par an, et les industries du cuivre un tonnage à peu près égal."

The use of coal in the form of dust for raising steam had, from isolated experiments, been known for the last thirty to forty years, but the fact that it is probably the most difficult method of burning coal delayed the development of the practice until means were discovered of surmounting the obstacles in the way of its use. When it is considered that if a cubic inch of coal which has an exposed surface of six square inches is crushed into cubes each of which has a side one-hundredth of an inch in length, and the exposed surface of the crushed coal becomes 600 square inches, the theoretical advantage of burning crushed coal becomes obvious. A more intimate mixing of the fuel and air is rendered possible, and this without using a large excess of air; for example, with an average boiler furnace fitted with mechanical stoking it is considered good working practice under normal conditions

if 150 to 200 per cent. of excess air is being admitted to the furnace; on the other hand, under pulverised-fuel firing there is no difficulty in working regularly with not more than 20 to 30 per cent. of excess air.

One of the difficulties which originally lay in the way of the widespread use of pulverised fuel was the heat engendered in the grinding of the coal to the requisite fineness, sometimes resulting in combustion. Again, inasmuch as coal dust cannot be shovelled into and burnt in an ordinary furnace, special burners had to be provided. However, a number of well-tried and standard methods for both the preparation and the burning of the fuel are now in existence, the underlying principle of all of them being the same, though differing in the design of the various parts of the equipment. The coal is dried, pulverised, and the dust, passing to a furnace, is conveyed to a burner, and then, mixed with air, burnt in the form of a jet. Each system has its own peculiar methods of performing these operations, some systems being more suited to certain conditions than others. A point common to all the systems, however, is that of the fineness to which it is necessary to reduce the coal. It has to be ground so fine that the dust will pass through a 100-mesh screen (*i.e.* a screen containing 10,000 apertures to the square inch), and 85 per cent. through a 200-mesh screen (*i.e.* a screen having 40,000 apertures per square inch). In order to effect this the coal must be dried so as not to contain more than 1 per cent. of uncombined moisture, the dryness being necessary from the point of view of manipulation, as the fuel must be capable of being handled without clogging or sticking in the feeding and burning equipment. In the process of drying, care has to be taken against overheating, which may result in loss of volatile hydrocarbons. The cost of securing a higher degree of fineness than that specified above is not justified by the extent of the increased efficiency obtained. On the other hand, practice has shown that if the degree of fineness is much below the standard named above troubles arise due to deposits of ash and slag and from irregular burning.

The separation of the coal ground to suitable fineness from that which is not of sufficient fineness is effected by screening or by air separation. In the latter method a stream of air at constant velocity carries away from the crushed coal particles of a certain definite size and so secures a uniform product, but the use of an air separator requires upwards of 50 per cent. more power to work it than a screen to perform the same amount of useful work, in addition to which the cost of maintenance of the former is heavier, due to high velocity and excessive strains. With air separators the mixture of air and coal dust is carried to a cyclone dust collector, where the stream of air

entering the larger volume of the collector is deprived of its velocity and the coal dust drops. With the screen separator the coal is elevated by a bucket elevator and conveyed to the furnace by a screw conveyor.

There are a number of different forms of burning the dust in use, the fuel being driven into the fire-box by means of either fans or compressed air. In one system the air pressure is exerted in the tank, which is in connection with the furnace by means of a pipe, and the dust forced in a stream, unmixed with air, through the pipe to the furnace. In another system the coal dust is drawn from the storage bin as required, mixed with air, and carried in suspension through pipes to the furnace at a velocity of 5000 ft. per minute. Mixing air with the coal dust would appear to increase the liability to explosion. In yet another system the dust from the feed worms is blown into the fire-box, the fuel and air passing as a cloud into the fire-box and being ignited by a piece of waste soaked in paraffin.

One economy incidental to the use of pulverised fuel under boilers has already been mentioned—viz. reduction in the amount of fuel as compared with lump coal to secure a given heat result. Other economies may be mentioned, as follows:—

- (a) Ability to use low-grade coal.
- (b) Saving in labour of stoking.
- (c) Flexibility of the operation, coal-dust firing being almost equal in this respect to oil firing.
- (d) Elimination of "banking" and easier disposal of ashes.
- (e) Possibility of safely working the boilers at loads largely in excess of their normal rating.
- (f) Ease of control of furnace conditions in the case of metallurgical furnaces.

Against these advantages, however, must be ranged the cost of preparing and conveying the pulverised fuel and the interest and depreciation on the capital outlay. These are very variable items, dependent, as they are, on local conditions in respect of labour, power, and fuel, but chiefly on the output per day of the plant. For instance, in the United Kingdom, under present conditions, it is not considered a paying proposition to use pulverised fuel in the case of stationary boilers having a lower fuel consumption than 40 tons of coal per diem. On the other hand, with a fuel consumption of 200 to 300 tons per diem a handsome saving can usually be secured by the replacement of lump coal by pulverised fuel under almost any conditions. As a rough guide it may be taken that with almost any of the well-known standard "systems" the cost of preparing, pulverising, and burning in the form of dust 1 ton of coal, will be about 5s. in the case of a plant dealing with 100 tons of coal per diem. Of course, the higher the price of the raw fuel the greater the saving by using it in pulverised form.

Pulverised coal has been successfully applied to

almost every kind of heating work, with the possible exceptions of open-hearth steel furnaces, steamships, and such furnaces as glass tanks, where contamination of the charge from particles of ash is to be avoided. The first really successful application of dust-coal fuel was in respect of rotary cement kilns, where the conditions are such that the problem of the disposal of the ash does not exist, and a large combustion volume is available with a free, unobstructed passage for the flame. The next step in its application was in the direction of various types of metallurgical furnaces, more particularly reheating, puddling, and similar furnaces, and complete success has been obtained in most cases.

The case of stationary steam boilers of the water-tube type has been found more difficult of treatment. In the early stages of the adaptation of coal dust to firing, considerable trouble was experienced from the ash and the rapid wear of the furnace lining and from imperfect combustion. Experience has shown the way of avoiding these troubles, and it is now a fact that pulverised fuel can with complete and permanent success be applied in raising steam from any type of tube boiler. In the case, however, of the cylindrical internal flue type of boiler—as, for example, the Lancashire boiler—the process of dust firing has not, so far, proved successful under continuous operation; but, seeing that firing with "straight" oil and with "colloidal" fuel has succeeded in this type, there seems no reason why the problem should not in time be solved in respect of coal-dust firing.

Perhaps the most difficult conditions for the successful application of pulverised fuel were those in respect of locomotives, owing to the small combustion area available and the cramped conditions generally; yet recently it has been completely successful, and locomotives equipped with this system of firing are in use in the United States of America. A fact of peculiar importance, as pointing to a means of utilising low-grade fuel, is that on the Brazilian Central Railway some locomotives are being worked with pulverised coal derived from local deposits of inferior quality in place of using high-grade imported lump coal. In England a system for locomotive use has been successfully developed and has been in service for some time with very successful results. Enough has been said to show that the preparation and use of pulverised coal have been brought to a practical and economic stage, and where the conditions are suitable its use constitutes a proposition worthy of the serious attention of large consumers of fuel. To readers who wish to pursue this matter further the perusal is recommended of the report in the *Bulletin* already named, the Report of the Fuel Research Board, and Mr. C. F. Herington's work on "Powdered Coal as a Fuel."

As illustrative of recent developments, two cases may be quoted. One is from the *Bulletin*, in which M. Frion says:—

"Nous ne citerons que l'exemple particulière-

ment démonstratif de l'installation nouvelle de 50,000 chevaux en cours de montage à la Milwaukee Electric Railway and Lighting Co. destinée à alimenter une centrale de 200,000 kw." At home pulverised coal has recently been applied at the Hammersmith Central Electrical Station.

The advent of a new process in connection with coal dust has resulted in a considerable step forward being made towards the reduction in the extent of the equipment necessary in the preparation and conveyance of coal dust for combustion. This process is that by which the finely divided coal dust is intimately mixed with oil to form what is inaccurately termed a "colloidal" fuel, for *colloidal* it is not. In this process the coal is ground in oil, a mixture resulting which is sufficiently stable for all practical purposes, especially so when the proportion of solid fuel contained therein exceeds 50 per cent.; mixtures of equal quantities of oil and coal have been used after standing three months in barrels without any

difficulty having been experienced in regard to sediment.

In the case of the so-called "colloidal" fuel, unless the amount of moisture is very excessive, the coal can be used without having to resort to drying preliminary to crushing, which means a curtailment in the equipment required as compared with the use of simple pulverised fuel. It has a further advantage in respect of transportation and of handling, in that it is a semi-liquid, and can be treated as an oil fuel, after due allowance for its greater viscosity. It is not liable to spontaneous combustion, and is burnt in the same manner as if it were "straight" oil.

The field for the use of "colloidal" fuel is great. The fuel can be employed wherever oil is applicable as a steam raiser. Its wide application will result in a vast saving in the consumption of oil, and its manufacture allows of the useful employment of low-grade coals and of coals deficient, for other purposes, in volatile constituents.

Remarks on Gravitational Relativity.¹

By SIR OLIVER LODGE, F.R.S.

IV.

WHEN we come to the more general theory, which attends to the acceleration and not merely the velocity of the observer, I find myself in disaccord on some points with many eminent exponents, chiefly in connection with their abolition of the idea of "force," and the consequent replacement of gravitation by a modified geometry; as if the earth's natural motion was in a hypocycloidal sort of spiral, and was not under compulsion by any deflecting force.

A revolt against "force" as a real objective entity was led by that great mathematician and physicist, Prof. Tait of Edinburgh. In the first instance he rebelled against the practice, adopted by text-books of the period, of using the term "accelerative force" instead of "acceleration," and making a muddle of the laws of motion by formulating what they called Law 3 thus:—"When pressure communicates motion to a body the accelerative force varies as the ratio of the pressure to the mass." Then he objected to some of the pedagogic arrow-heads sprinkled on mechanical diagrams, especially the arrow-head representing centrifugal force; since it is obvious that no such force acts on the revolving body. Ultimately Tait or his disciples (W. K. Clifford too, if I remember right, also Mach and Kirchhoff) were prepared to abandon the term force altogether, and to substitute space-rate of change of energy, or time-rate of change of momentum, or mass multiplied by acceleration, as a more real equivalent. Tait even denounced the idea of balanced forces, saying that only their effects were balanced ("Ency. Brit.," 9th ed., art. "Mechanics," §§ 285-300); as if two opposing forces

were each producing their proper amount of acceleration, or of momentum, but in opposite directions. Though how this kind of statement could include the production of scalar quantities, like work and energy, is not apparent. The whole idea of "cause" came into disrepute.

Now mass-acceleration truly is a measure of the force which produces it, but that does not mean identity. Reformers spoke sometimes as if they meant identity, and desired to get rid of the term force altogether because it had been so misused. After a lecture by Prof. Tait to the British Association on "Force" (at Glasgow, in the year 1876), Sir Frederick Bramwell amusingly said that in the North of Britain the term meant a waterfall, while in London it meant the police, and that really, after the lecture, he himself scarcely knew exactly what it did mean! In that lecture Tait had dealt pugnaciously with some misuses of the term by Prof. Tyndall and other scientific people; for it is not so long ago that the words *vis* and *Kraft* were used with but little modification or caution for the quite different conception of Energy. "The Persistence of Force" was a phrase frequently employed in philosophic writings. Indeed, an accurate nomenclature has scarcely yet penetrated into common usage; and the result is an unnecessary vagueness about the term, typified by Sir F. Bramwell's more than half serious confession. Centrifugal force, for example, can be treated correctly enough by equating it to the product of inertia and rate of change of velocity, but that does not do away with the force: the force is exerted by the revolving body against its constraints. The word is misleading if thought of, in what was no doubt its original intention, as a radial fly-away tendency; it should connote only

¹ Continued from p. 785.

an outward radial pressure, due to kinetic reaction against the normal component of acceleration. It is the necessary correlative of the centripetal force which must be acting on any revolving body. Centrifugal force is not acting on the revolving body, and, strictly speaking, should never be so thought of, or so depicted: it is the pressure or reaction exerted by the body on the groove or rail or æther, or whatever it may be that guides and deflects it.

Part of the mistake, if I may call it so, connected with the denial of physical reality to the directly apprehended thing called force, is the identifying of a thing with its measure. Because two things are equivalent it does not follow that they are identical. There is room for both; and force may be measured statically as well as kinetically. It is only unbalanced force that produces acceleration and calls out kinetic reaction. Acceleration is often prevented by an equal opposite force, but that does not abolish the force. Whether balanced or unbalanced, force is real enough. If Galileo had been put on the rack, the assurance of an Inquisitor that he was only suffering from balanced accelerations would have been no relief. It will be said that force is only one end of a stress, and that attention to the stress is the illuminating thing. That is perfectly true; but as a fact of experience we came across force before we understood about stress, and there are states of stress which we still are not able to understand, because they occur in the æther, and only display themselves by their "ends"—that is, by the pair of equal opposite forces in which they terminate—called in old phrase "action and reaction."

The weight of a book, or a stone, or an apple is a force acting on it; this force is due no doubt in the last resort to a stress in the ætheric medium, but we experience it as a force when we resist it muscularly; and though we may measure it by the mass-acceleration of the body when allowed to drop, it acts equally when the body is resting on a table or hanging from a twig; only then the reasoned and hypothetical æther stress is counteracted by an obvious stress in the material support. The stress can be measured by resting the body on a spring, or hanging it from a piece of elastic; and the strain so caused is surely an undoubted reality, about which it would be extremely artificial and confusing to postulate any kind of acceleration. Some day we may be able to dive into deeper constitutional secrets, and explain all stresses and strains kinetically in terms of the gyrostatic rigidity and elasticity of æther; but that time is not yet. Meanwhile the objects here used in illustration are in static equilibrium, are obeying the first law of motion and moving with uniform velocity, so long as the forces acting on them are equal and opposite and therefore balanced.

But an unbalanced force can always be equated to the kinetic reaction or mass-acceleration of the body acted on; and in dynamics unbalanced forces are those which demand attention. All the rest is the statics of strain. D'Alembert's principle

rather tended to tempt us to contemplate spurious forces, for supposed convenience, so as to reduce kinetics to statics when writing down equations—for there must be equilibrium among the internal forces acting within the confines of any closed system—and a flagrant elementary example of the kind of thing thus led up to was the ordinary text-book treatment of centrifugal force.

Elementary Repetition.

If a governor ball or conical pendulum is depicted on paper, the only arrows that ought to be drawn on it are those representing the tension in the string and the weight of the body. But such a diagram looks unfinished; nothing could rest like that; the two forces are evidently not in equilibrium; they clearly have a resultant. The unpardonable, or at least the confusing, thing is for a teacher to draw an arrow indicating a force equal and opposite to that resultant in order to make the diagram look comfortable and static. The fact is that no third force acts on the body; the body itself reacts, its mass-acceleration is equal to the resultant force; and that is the proper fact to express in an equation; you cannot express it in a diagram. The diagram can be completed only by motion, and it ought not to look as if equilibrium were attained by any part of the system. The system as a whole is in equilibrium, or the internal stresses balance, directly the kinetic reaction is taken into account, not otherwise. Centrifugal force, as the term is often employed to signify a force acting on the revolving body, is a fiction.

Yet centrifugal force is a reality; it is essential to the equality of action and reaction. There ought to be no objection to the term or idea when properly applied. But it does not act on the revolving body at all. In every instance the real centrifugal force acts, not on the revolving body, but on whatever fixed centre is responsible for holding it in its orbit; or on the constraint, such as rails or groove or ætherial medium, which is directly effective in guiding and deflecting it. The centrifugal force of the moon acts, not on the moon, but on the earth. It is part of the cause of the tides. No doubt it is primarily exerted on the ætherial medium in contact with each lunar particle, and is thus transmitted to the earth at the other end of the gravitational stress.

To finish this trivial pedagogic discussion of centrifugal force in its true, as distinguished from its usual artificial, sense, and the confusion about which body the force really acts on, we may as well point out that the same sort of trifling difficulty—caused by there being always two bodies bounding a stress,² while we are liable to concentrate attention on one—is responsible for that simple old puzzle about the horse and the cart. If the cart pulls back as hard as the horse pulls forward, why does it move? Every good student, sooner or later, asks himself or his teacher this question. The correspondence columns of the *Engineer* at one time exhibited persistent misconception about this elementary matter among quite a large number of readers, and some text-book writers have been bothered by it. The confusion is caused entirely by the tacit assumption that both forces must act on the cart. Not so; one acts on the cart and one on the horse. Two forces and two bodies, one force acting on each. The difficulty disappears. The horse must get a grip of the ground to enable him to exert his force on the cart, true; and the cart exerts its reaction on the horse entirely be-

² The fact that an advancing wave-front may simulate a body, for this purpose, is of high interest.

cause of, and in proportion to, its mass-acceleration, until friction and other obvious extras have to be taken into account.

The Principle of Equivalence.

In returning from this, I hope pardonable, elementary digression to more general considerations, let me quote and amplify a sentence from a sort of summary which will appear in the *Fortnightly Review* for September:—

To ignore or deny or supersede the gravitational stress, merely because we do not yet understand the particular configuration of the æther which is responsible for it and which renders it possible, is to blind our eyes dangerously to dynamical reality, and to rest satisfied with a mere geometrical specification of the motion as if it were a peculiarity of space.

The "principle of equivalence" formulated by Einstein claims that the inertia reaction of a revolving body, to the centripetal force responsible for the curvature of its path, is of the same character as what we call the force of gravity, due to the neighbourhood of a large mass; that this inertia reaction is indistinguishable from weight; and, generally, that no distinction can be drawn between an artificial field of force, such as that representing the effect of a carefully defined revolution round a centre, and what we are accustomed to think of as a real field of force, such as that surrounding the earth.

We are told that by referring motion to rotating axes it is possible to abolish revolution and to replace it by a centrifugal force acting outwards on the body, thereby enabling the body to be treated as if in static equilibrium. We do this when we draw a static diagram of a revolving body, say a conical pendulum or pair of governor balls, and when a spurious and non-existent force is supplied, to represent the inertia reaction, and to balance the centripetal-force component which in reality is curving the path. I called this "unpardonable" in an elementary text-book, and also wrong as a philosophic representation of fact, but as a mathematical device it seems to be permissible; at any rate, it is quite consistent with the principle of relativity. In fact, it is part of the foundation of Einstein's principle of equivalence.

Now it is true that the most careful experimentation (first Newton, and now Eötvös) has shown that weight and inertia are accurately proportional. So it is possible to balance weight precisely by inertia reaction, and, for calculation purposes, to treat centrifugal force as if it were an artificial kind of gravity, obedient to the same laws. But this can only be done with due caution and limitation, for it does not represent reality, and the laws are not in all respects the same.

We are also told that, by choosing accelerated axes as our frame of reference, weight can be abolished too. Passengers in an unsupported, and therefore freely falling, enclosure, such as a cage or lift, would experience no force of gravity; for nothing would require any support, and nothing would tend to move out of its place as

defined by the walls of the room, which constitutes the passenger's natural frame of reference.

We are told still further that the behaviour of things inside an enclosure or cage in free space, dragged along by a hook with an acceleration of 32 ft. per sec. per sec., would be indistinguishable from the behaviour of things inside a stationary or equilibrated cage slung by the same hook above the earth. These examples are instructive, for in many respects the behaviour would be just the same. But such illustrations must not be pressed to philosophic extremes, as if there were really no discrimination. For one of the two cages, after the lapse of about a year, would attain the velocity of light; and surely something noticeable must happen then, even if only the invisibility of the floor. Moreover, force is not really evaded; for *something* must be dragging at the hook—something quite gratuitous—whereas the influence of the neighbourhood of the earth is a manifest *vera causa*, however little we may as yet understand about its ætherial mechanism. It must not be supposed that we have no criterion for what is *true* in all these cases; we need not allow that we have no means of discrimination, and that we are really subject to all the uncertainties and ignorances about absolute truth which tend to be grafted on to us by the doctrine of relativity in general and by the principle of equivalence in particular.

The fact is that the passengers-in-a-lift argument, like others that we encounter round about this subject, is of very limited application. It can be well used to illustrate certain non-obvious and interesting facts, but innumerable considerations contradict the idea that the force of gravity is really nothing else than a fanciful name for the mass-acceleration which can be written in equations as equivalent to it. After all, distinction is quite feasible between the reaction of a heavy body on the earth to its centripetal diurnal acceleration, and any corresponding fraction of the force of gravitation. The two do not even act in the same direction, save at the equator; and at the poles one vanishes. What is true is that the resultant between the pressure of the ground on a stone or man, and the real weight of the stone or man, is an unbalanced force which causes that stone or man to rotate round the earth once a day, and (if we allow for complete weight) round the sun once a year. Attachment to the earth has nothing to do with astronomical motions of our human body; for we are not attached. Each of us, and each loose pebble, is as much a planet as the earth, and nearly as much a satellite as the moon.

To say—if anyone does—that the force exerted by a gravitational field, such as might be due to a heavy mass at the centre of a wheel, is indistinguishable from any other constraint needed to curb the inertia reaction of a particle attached to the rim of the wheel when it is revolving, is false. For the way the force is applied is not the same, and the law of force is different. The one increases with distance from centre, the other diminishes with the inverse square.

To reduce the field of the earth locally to zero by means of a falling elevator or "lift" is feasible for observers inside the lift, so long as it is small. But if, in an extensive falling chamber, gravity is to be imitated or neutralised exactly, its parts must fall in different directions, or with different accelerations, or both.

The elimination or avoidance of the idea of absolute rotation, through imitating or replacing centrifugal reaction by the influence of the stars, or by an imaginary distribution of attracting matter in distant space, round the earth or other rotating body, is preposterous, and cannot be seriously contemplated.

I know that the mathematical physicists who allow themselves to assist their exposition by employing illustrations of this kind must be well aware of the limitations attending their use; but I do not think that philosophers always are, and they may not always attend to the cautionary language employed by careful expounders. In fact, the so-called "principle of equivalence," like other popular wordings of extreme relativity, is liable to lead an incautious exponent to go beyond what is legitimate or necessary, and to land him in paradox. Yet if not pushed to absurd extremes, and if the wording is carefully guarded, the principle of equivalence is useful enough; for it is true that any effect on bodies produced by their weight can be imitated by whirling them on a revolving table. Mechanically the principle is used in industrial separators of various kinds, and in any operation requiring an enhanced value of gravity; and the principle extends to optic and electric effects also.

Reference to Mercury's Orbit again.

The theory of relativity, though originally suggested by electrical theory, was developed without further reference to that theory, and reduces an orbit to a mere spatial relation determined by the central body. But it should be clear that, unless an æther is admitted, the gravitational potential or potentials essential to the theory must represent an action-at-a-distance of the central body on space. In the third article (NATURE, August 18, p. 784), when discussing the orbit of Mercury, I did not seek to explain how it was that an extra small perturbation was necessitated by the principle of relativity; because no question about it has arisen, and because it has been done, so far as reasonably possible, at least for the bending of light, by Prof. Eddington, in chap. vi. of his book "Space, Time, etc."; while the equations are in chap. v. of his "Report" to the Physical Society of London; or, in another form, in Cunningham's "Relativity," second edition. The theory for a planetary orbit is similar to the light-path theory; but it is difficult to put the gist of it into ordinary language. Suffice it to say (1) that Newton showed, in the "Principia" (Book 1., sect. ix.), that the inverse square law is the only one to give an exact elliptic orbit, and that the slightest interference with that law would bring about a specified revolution of the orbit in its own

plane, *i.e.* an apsidal progression; or, in vaguer words, would prevent the same orbit from being retraced or repeated by the planet. And (2) that the Relativity theory, virtually though not explicitly, does interfere with the exact law of inverse square, especially for a near planet. For in the ordinary equation for orbital revolution in general,

$$\frac{d^2}{dt^2}\left(\frac{1}{r}\right) + \frac{1}{r} = \frac{Pr^2}{h^2}$$

(with P as the acceleration at distance r from the central body M , and $\frac{1}{2}h$ as the constant rate of sweeping areas), the right-hand side is constant only for an inverse square law, $P = GM/r^2$. But relativity adds to the right-hand side, which ordinarily would be GM/h^2 , another term, namely $3GM/c^2r^2$; and this small term is the one responsible for the departure from an exact conic-section orbit. The discrepancy thus introduced turns out to be right for Mercury, and insignificant for other planets; while it does not interfere with their eccentricities. Moreover, the same term is responsible for the bending of a ray of light. So the double success is very striking, and the jubilation entirely justified.

To sum up this portion.

Force is essentially a human conception derived from our muscular sense; and, from the psychological point of view, is as basic as motion, and more directly apprehended than matter. Unforced motion is straight and uniform,³ not varying or curvilinear, and acceleration is not a fundamental property of matter, nor a diversion of empty space, but is always the result of pressure exerted upon a mass by other bodies, or in the last resort by the circumambient medium.

To geometrize physics, even if legitimate for convenience of calculation, is ultimately to complicate it. Directly the operation becomes complicated it becomes needless, or even obstructive. The new facts can be accepted, and the relativity equations can be used, but a physical explanation can still be looked for, and our knowledge of the universe will not be complete until it is found. We cannot be for ever satisfied with a blindfold mathematical method of arriving at results. We can utilise the clues so given, and admire the ingenuity which has provided them, but that is not the end; it is only the beginning. The explanation is still to seek, and when we really know the properties of the æther we shall perceive why it is that things happen as they do.

CONCLUSION.

The relativity method, by aid of its differential geometrical analysis, seeks to interpret all that is directly experienced through our senses as a manifestation of the peculiarities of space. Matter and all its functions are thus reduced to a kind of subjective space-time geometry, and everything absolute has disappeared from the physical world.

An alternative view of what may be the outcome

³ Straightness means that no reason for deflection in any direction can be assigned; and the absence of any accelerating or retarding cause yields uniformity.

of the method—a view taken in these articles, though it is not likely to be immediately acceptable to fully assured relativists—is to regard the theory of relativity as an indirect attempt, not unlike the principle of Least Action, to treat all material phenomena as developments or manifestations of unknown essential features in one universal medium; thus restoring a kind of absoluteness to motion, and therefore presumably to space and time. From that point of view the compre-

hensive scope of the method, with its infinitesimal continuity of treatment, is hopeful and encouraging; and the highly abstract and symbolic modes of representation, which now seem inevitable in its more advanced developments, are the tribute to our ignorance of the kind of dynamics appropriate to a substance the properties of which must be more fundamental than any we are likely as yet to have encountered among its sensory derivatives, electricity and matter.

The Edinburgh Meeting of the British Association.

By PROF. J. H. ASHWORTH, F.R.S.

PROGRAMME OF THE SECTIONS.

THE Journal for the Edinburgh meeting of the British Association, now in the hands of the printers, shows the completed plans for the business of the various sections. In particular, attention may be directed to the careful arrangements for the joint discussions. "The Age of the Earth" is to be the subject of a discussion, by the conjoined sections of physics, geology, zoology, and botany, to take place in the Natural History Lecture Theatre, Old College—the largest theatre in the University, with accommodation for an audience of more than 400. The discussion will be opened by Lord Rayleigh, and other speakers will be Prof. Sollas, Prof. Eddington, Prof. J. W. Gregory, and Prof. Lindemann.

Sections A and B will take part in a discussion on the structure of molecules, to be opened by Dr. Langmuir, of New York. He will be followed by Prof. Smithells, Prof. W. L. Bragg, Prof. Partington, Prof. Rankine, and others.

Chemists and physiologists will find common ground in the discussion on "Oxidations and Oxidative Mechanisms in Living Organisms," to which Prof. Gowland Hopkins will contribute the opening paper.

The sections on geology and engineering are to discuss the various aspects of the proposed mid-Scotland canal. The geology of the suggested route will be explained by Mr. M. Macgregor and Mr. C. H. Dinham, of H.M. Geological Survey.

"The Origin of the Scottish People" is to be the subject of discussion opened by Sir Arthur Keith before the joint sections of geography and anthropology. Prof. T. H. Bryce, Lord Abercromby, Prof. R. Weymouth Reid, Prof. Jehu, Prof. W. J. Watson, and Dr. Tocher are to take part in this discussion.

The sections of geography and education will combine for discussion on the teaching of geography, which will be opened by Mr. G. G. Chisholm, and it is hoped that Sir Richard Gregory, Sir Halford Mackinder, Prof. J. W. Gregory, Prof. Patrick Geddes, Dr. Rudmose Brown, Mr. W. H. Barker, Mr. T. S. Muir, and others will put forward their views on this subject.

The sections of zoology and psychology are to discuss "Instinctive Behaviour." Dr. Drever will

open for the psychologists, and he will be followed by Prof. Goodrich, Prof. J. Arthur Thomson, and others.

A joint meeting of the sections of economics, psychology, and education will be held to discuss "Vocational Training and Tests."

The discussion following the presidential address in Section K, in which Section C is to take part, on the early history of plants, with special reference to the Rhynie fossil plants, promises to be an outstanding feature. These plants, representative of the earliest known land flora, had an organisation different from that of any living land plants, and their investigation by Dr. Kidston and Prof. Lang has thrown much light on the evolution of land floras. In addition to the president of Section K (Dr. D. H. Scott), Dr. Kidston, Prof. Lang, Dr. Horne, Prof. Bower, and Dr. Lotsy will take part in the discussion. There is to be an extensive demonstration by Dr. Kidston in the Botanical Laboratory, Royal Botanic Garden, of sections of these Rhynie plants.

As indicated in a previous notice, the presidential addresses in other sections are to be followed by discussions, and in several cases should lead to interesting debates, for instance, on "The Principles by which Wages are Determined," on "The Place of Music in a Liberal Education," and (at the Conference of Delegates of Corresponding Societies) on "Science and Citizenship."

There are other discussions planned which, though nominally forming part of the programme of one section only, will attract interested members from other sections. Among these may be mentioned discussions on "An Imperial School of Anthropology for the Training of Civil Servants and Administrators in the Dependencies of the Empire," on "Heavy Muscular Work," on "Size and Form," on "Extramural Education," and on "University Reform."

There are to be, as usual, many communications giving the results of recent investigations, and there will be exhibitions of apparatus and specimens and demonstrations of methods.

Nearly all the sections have arranged excursions to places of special interest to their members. The local secretaries of the sections of chemistry, geology, engineering, and botany have been par-

ticularly active and fortunate in their arrangements. These excursions are necessarily limited in number, and only those really interested are expected to join them. The arrangements for these are in the hands of the respective sectional secretaries. There are in addition eighteen excursions open to all members. Information regarding these is given in the local programme, and further details can be obtained at the excursions counter in the reception room. The Excursions Committee has succeeded in making arrangements for members, up to the number of two hundred, to visit Loch Lomond, Loch Katrine, and the Trossachs by motor charabanc and boat, and for a further two hundred to visit the Scott country—Melrose, Dryburgh, Abbotsford, and the Valley of the Tweed—by motor coach. Early application for these excursions is desirable. It is hoped that full advantage will be taken of arrangements which have been made for small parties, not exceeding fifty in each group, to visit Old Edinburgh under the guidance of experts, each visit to extend over two afternoons. Members who will arrive in Edinburgh on Tuesday or early on Wednesday, and are interested in the Old Town, are advised

to join one of the four parties which will set out on the Wednesday afternoon at 2.30. These will complete the inspection of the Old Town on the Thursday afternoon. Another party will start on Thursday afternoon and finish on Friday afternoon, and a third party will begin on Monday afternoon and finish on Tuesday afternoon.

There is to be a special graduation ceremonial in the McEwan Hall on Tuesday, September 13, at 3 p.m., at which honorary degrees in the faculty of law will be conferred. Members of the Association who propose to attend the ceremonial in academic dress are desired to hand in their names at the general inquiries counter in the reception room on or before the morning of Monday, September 12. The secretary of the University has kindly arranged to reserve seats for them and to include them in the academic procession.

Members who are golfers will be glad to hear that several of the well-known Edinburgh clubs have been good enough to intimate that a number of members of the Association will be made honorary members of the clubs for the period of the meeting. The local secretaries will be pleased to give particulars.

Obituary.

PROF. EDMOND PERRIER.

PROF. JEAN OCTAVE EDMOND PERRIER, the announcement of whose death appeared in NATURE for August 4, p. 721, had been, for longer than many of us can remember, one of the most distinguished of contemporary French zoologists. Born in 1844 at Tulle (Corrèze), he entered the Ecole Normale Supérieure in 1864, and for some years devoted himself to mathematical and physical studies; but he was a born naturalist, and the call of the natural sciences was too clear to be resisted. He entered the service of the Museum of Natural History in Paris in 1868 as "aide-naturaliste," and eight years later he became a professor in that institution. On the death of Prof. A. Milne-Edwards in 1900, Perrier was appointed director of the museum, a position which he held until January of last year, when he retired with the title of honorary director. He died in his official residence at the museum on July 31 last.

Prof. Perrier's published writings cover a wide range of subjects. His own researches—morphological, taxonomic, and faunistic—deal mainly with various groups of invertebrates, and are recorded in a long series of memoirs, many of which are of fundamental importance. His monograph on the structure of earthworms (1874) is frequently quoted by Darwin, who refers to it as "M. Perrier's admirable memoir." His researches on echinoderms are well known, and we need do no more than mention his memoirs on the collections of the *Travailleur* and *Talisman*, the *Blake*, and other expeditions, and his detailed study of the structure and development of Antedon. He was also the author of a considerable number of volumes of more

general scope, one of the best known being "La Philosophie zoologique avant Darwin" (1884), in which he emphasised the important part taken by French thinkers in the development of biological theory. "Les Explorations sous-marines" (1886) was based largely on the results of the *Travailleur* and *Talisman* expeditions in the Atlantic, in which he had taken part. "La Tachygénèse, ou accélération embryologique" (in collaboration with Prof. Ch. Gravier, 1902), is an interesting and suggestive attempt at a synthesis of the facts of embryology. In his monumental "Traité de Zoologie," of which six fascicles have appeared since 1892 (a final part was in manuscript at the time of his death), he attempted a task which is now, perhaps, beyond the powers of any single man. His last published work, "La Terre avant l'Histoire" (1920), a general review of the origin and evolution of the living world, is distinguished no less by the author's encyclopædic knowledge than by the lucidity and charm of his style.

A list of Prof. Perrier's academic and other honours would be a lengthy one. He was elected a member of the Académie des Sciences in 1892; he was also a member of the Académie de Médecine, and of many foreign academies and learned societies, including the Linnean and Zoological Societies of London. The distinction of his literary style gained for him the coveted honour of admission to the "Société des Gens de Lettres," of which he was one of the few scientific members. He was one of the founders of the International Congress of Zoology, and succeeded Prof. A. Milne-Edwards as chairman of the permanent committee.

Of Prof. Perrier's personal qualities, a distin-

guished colleague and former pupil of his, to whom we are indebted for some of the facts recorded above, writes: "Je suis navré de la mort de mon vénéré Maître. . . . Il avait conquis les sympathies de tous par son caractère enjoué et si aimable, par son accueil charmant pour tous, les grands comme les petits, les puissants comme les faibles, par son exquise bienveillance. . . . Il restera de lui le souvenir d'un savant érudit d'une haute courtoisie."

A. T. SIMMONS.

MANY science teachers and students will learn with much regret that Mr. A. T. Simmons, inspector of secondary schools for the University of London, and author of a number of widely used text-books of science, died from pneumonia on August 19, at fifty-six years of age. Mr. Simmons received his chief scientific training at the Royal College of Science, London, in 1882-87, and during these years he and his fellow-student, Mr. H. G. Wells, were almost inseparable. After becoming an associate (physics) of the college, he was for three years lecturer in physics, chemistry, and other science subjects at the Southport Science and Art Institute, and while occupying this post he proceeded to work for the B.Sc. degree of the University of London, graduating with first-class honours in physical geography and geology in 1890. During the years 1891-97 he was science and second master at Tettenhall College, near Wolverhampton, where numerous students learned to esteem his high character and teaching aptitude. He came to London in order to undertake general editorial and advisory work for Messrs. Macmillan and Co., Ltd., in connection with school manuals on scientific subjects, and was a part-time member of the staff until his death. In association with Sir Richard Gregory, he founded in 1899 the *School World*, published by Messrs. Macmillan, and continued as joint-editor when that magazine was incorporated with the *Journal of Education* in 1918.

By his many years of devoted service on these periodicals, the sympathetic and helpful spirit in which he carried out his duties as inspector of science work in schools, and the assistance he afforded to many authors of text-books, Mr. Simmons won the highest regard from a large circle of the educational world. His influence upon the teaching of scientific subjects was strong and far-reaching, and his death will be mourned not only by his personal friends, but also by numerous teachers and students familiar with his books both at home and overseas. His personality and his works will long be cherished in most affectionate memory.

NEWS has reached us that one of the best Russian zoologists, PROF. N. A. CHOLODKOVSKY, academician and professor emeritus in the Academy of Medicine and at the Institute of Forestry, died last April in Petrograd at sixty-one years of age. Prof. Cholodkovsky was the author of numerous works on entomology and helminthology. One of his best works is a "Monograph on Chermes Injurious to Coniferous Trees," 1906. His excellent text-books on zoology are adopted in most Russian universities. To the general public Prof. Cholodkovsky was also known as a poet of high merit. To his pen belong the best translations into Russian of Shakespeare, Byron, Goethe, and others. For his masterly translation of Goethe's "Faust," with commentaries and a new criticism, he was awarded the Grand Premium in Literature by the Russian Imperial Academy of Sciences.

THE death is announced, in *Science* of August 12, of CHARLES BARNEY CORY, curator of zoology in the Field Museum of Natural History, which occurred on July 29, at the age of sixty-four years. Mr. Cory was one of the founders and a past president of the American Ornithologists' Union and a member of many learned societies, and was widely known for his ornithological writings.

Notes.

THE announcement appears in *Science* of August 12 that Prof. R. A. Millikan, of the University of Chicago, has been appointed director of the new Norman Bridge Laboratory of Physics at the California Institute of Technology, and chairman of the executive council of the institute. An income of 95,000 dollars for the new laboratory alone has been promised by the institute, and additional funds available comprise sums of 200,000 dollars and 50,000 dollars, which have been promised by Dr. Norman Bridge for the extension of the laboratory and its library respectively. With this generous provision it is hoped to create a large and effective laboratory for research in physics. In conjunction with the laboratory, the Southern California Edison Company is to erect an experimental station in the grounds of the institute for the investigation of the trans-

mission of electric power at high potentials; Prof. Millikan will be partially responsible for the direction of this station. The main problem, however, which Prof. Millikan proposes to attack is the constitution of matter and its relation to the phenomena of radiation, a task for which the new laboratory will provide exceptional opportunities. It is also announced that Prof. H. A. Lorentz, of the University of Leyden, will be in residence at the institute during the winter term as lecturer and research associate in order to supplement the work of the mathematical physics department, and that Dr. C. G. Darwin, of Cambridge, has been appointed professor of this department for the academic year 1922-23.

THE council of the British Association for the Advancement of Radiology and Physiotherapy has recently issued a statement warning the public against

undue optimism about the use of radiotherapy in the treatment of cancer. The new technique, which has been developed at Erlangen, Bavaria, has not yet been thoroughly tested, and, in any case, evidence of success cannot be assumed until after the lapse of some years. The council is of the opinion that of any single method surgery still offers the best prospects of cure in most cases of cancer. Combined treatment by operation and radiation therapy has been employed with good results, and so far the co-operation of the radiologist with the surgeon affords the greatest hope of success. The association has organised a scheme for the investigation of the claims made for the new intensive X-ray treatment, for which purpose a sum of 4000l. has been allocated by an anonymous donor (*Arch. Radiology and Electrotherapy*, No. 252, July, 1921, p. 38). It is suggested that a research scholar be appointed for two years at a salary of 350l., with travelling allowance, and that he proceed to Erlangen, where the treatment has been in progress for several years. If it is found that the results obtained there approach the claims made, a complete outfit of apparatus such as that used at Erlangen would be ordered and installed at the Manchester Royal Infirmary and the work continued there.

THE President of the French Republic has conferred the Cross of Chevalier of the Legion of Honour on Col. Sir Arthur Mayo-Robson for services rendered by him to the French Red Cross during the war.

IT is announced that the Advisory Committee provided for by the Importation of Plumage (Prohibition) Act will be constituted as follows:—Lord Crewe (chairman), Mr. E. C. Stuart Baker and Dr. W. Eagle Clarke (representing ornithology), Mr. C. F. Downham, Mr. W. G. Dunstall, and Mr. L. Joseph (representing the feather trade), Lord Buxton, Capt. E. G. Fairholme, Mrs. Reginald McKenna, and Mr. H. J. Massingham.

At a meeting of the Privy Council, held at Buckingham Palace on August 10, the petition of the Institution of Electrical Engineers for a Royal Charter of Incorporation was approved, and a Royal Charter has now been granted. His Majesty the King has also been graciously pleased to intimate his willingness to become patron of the institution.

IT is announced in *Science* of August 5 that the Municipal Observatory at Des Moines, Iowa, said to be the only municipal observatory in the world, was opened on August 1. The observatory building is to be equipped by Drake University with an 8-in. equatorial telescope. It is to be under the control of the university, and open to the public at least three times a week, and at any other time when occasion may warrant.

CAPT. ROALD AMUNDSEN has arrived at Vancouver from Nome, Alaska. The *Times* announces that he intends to sail for the Arctic next spring to resume his attempt to drift across the Arctic Ocean. Two aeroplanes furnished with sleds will be carried by the expedition. Meanwhile the *Maud* is on her way

to Seattle for repairs and the installation of more powerful wireless equipment. It will be recalled that the *Maud's* first attempt to drift with the pack was unsuccessful, and that she was forced to winter in the ice off the coast of north-eastern Siberia, where she lost a propeller.

ANNOUNCEMENT was made of the coming Paris meeting of the Iron and Steel Institute, under the presidency of Dr. J. E. Stead, in *NATURE* of June 2, p. 434. A programme of the meeting, which will be held at the headquarters of the Comité des Forges de France on September 5 and 6, has now been issued. It is expected that ten papers will be submitted, most of them dealing with the constitution and properties of various types of steel, though two will be of economic interest. Advance copies of the papers can be obtained by members of the institute from the Secretary, 28 Victoria Street, S.W.1. At the conclusion of the meeting, alternative visits have been arranged to works in Lorraine, Burgundy, and Normandy.

IT is reported in the *Pioneer Mail* of July 15 that the Bose Research Institute, established some four years ago at Darjeeling, is actively at work and engaged in investigations of wide interest. The Government of India has obtained the consent of the Secretary of State for a permanent Imperial grant which will be double the income derived from public donations, of which Sir J. C. Bose's contributions alone will amount to 10 lakhs of rupees (66,666l.). Problems dealing with agriculture will be investigated on an experimental station at Sijberia, while at Darjeeling an attempt is to be made to conserve an entire hill-side with the view of investigating the flora of the district and of preserving wild plants from Sikkim and Tibet which are in danger of extermination.

At a small business meeting held on August 16 at the Hotel Cecil, the Society for Constructive Birth Control and Racial Progress was formally constituted, with Dr. Marie Stopes as president. The objects of the society are: (a) To bring home to all the fundamental nature of the reforms involved in conscious and constructive control of conception, and the illumination of sex life as a basis of racial progress; (b) to consider the individual, national, international, racial, political, economic, scientific, spiritual, and other aspects of the theme, for which purpose meetings will be held, publications issued, and research committees, commissions of inquiry, and other activities organised from time to time as circumstances require and facilities offer; (c) to offer to all who still need it the full knowledge of the methods of control.

A CONGRESS of Applied Chemistry, to be held in Paris on October 9-12, is being organised by La Société de Chimie Industrielle de France. The congress, which will also be the first annual meeting of the society, will be split up into thirty-four sections, corresponding to various branches of industrial chemistry. All meetings will be held in the Con-

servatoire des Arts et Métiers, and the inaugural ceremony, which will take place on October 10, will be presided over by M. Dior, the French Minister of Commerce. The society is also organising, at the Conservatoire, a Chemical Exhibition, which will be open on October 9-16. Two sections only will be represented, those dealing with laboratory equipment and colouring matters, but it is hoped that the exhibition, at which most French manufacturers will be represented, will be the germ of a future chemical exhibition embracing all branches of industrial chemistry.

THE latest news from the Mount Everest expedition is contained in Col. Howard Bury's dispatch to the *Times* published on August 17. Leaving their base camp at Tingri, the expedition explored the approach to Mount Everest on the north-west. The chief obstacles were great glacier streams which proved quite unfordable in July, and could be crossed only where frail native bridges existed. The expedition crossed the Kyetrak glacier valley on such a bridge, and marching by Zambu reached the Rongbuk glacier, in the valley of which it camped at a height of 18,000 ft., some miles from the great Rongbuk Monastery, which stands at 16,500 ft. Progress in this direction did not look promising owing to the sheer precipices of 10,000 ft. which descend to the Rongbuk glacier, and even supposing the ridge summits at 26,000 ft. were gained, there still remains difficult rock climbing at greater heights. In the course of their reconnaissance Mr. Mallory and Mr. Bullock climbed a peak of more than 23,000 ft., but their coolies were unable to reach the summit. August was to be devoted to the eastern and north-eastern faces of Mount Everest, which have more snow and ice on them than the north-western side, and the base camp for this purpose was to be moved in the vicinity of Kharta, in the Arun Valley. Col. Howard Bury hopes to find a high pass leading from the Rongbuk glacier into the valley of the Kharta Tsangpo, but finds it impossible to get any accurate information from the Tibetans. The weather broke early in July, and poor visibility now hampers the work.

THE widespread faith in Australia in water-divining has led Dr. Griffith Taylor to examine its working in the Federal Capital Territory, and he has communicated his conclusions and some quotations from the literature of the subject to the Proceedings of the Royal Society of Victoria (vol. xxxiii., N.S., 1921, pp. 79-86). He dismisses water-divining as of no practical value and as of interest to the psychologist rather than to the geologist or farmer. His own evidence, however, like some other scientific tests of the question, is inconclusive. He reports two cases. A well was sunk at Ainslie at a point selected by a diviner, who "estimated that water would occur at about 56 ft." Dr. Taylor reports that "at 56 ft. some water came in; at 64 ft. water was 'bubbling in.'" In this case the well was sunk in an area where drifts lay on a slope of impermeable beds, and water could have been obtained at any site. This success was probably mere coincidence, but the pre-

dition was justified by the result. In the second case another diviner recommended a site on a ridge of shale; naturally, the well was a complete failure. Dr. Taylor quotes records of more extensive inquiries, including the Guildford case of 1913, an early investigation by the Government of South Australia, and one in 1920 by the New South Wales Water Conservation Commission. This Commission's inquiry covered fifty-six bores selected by diviners, and of these 70 per cent. were successful; of ninety-six bores selected without the diviners' aid 87 per cent. were successful. The accumulation of evidence against the divining-rod is useful, and though it may show that the method is of no practical value, many of the tests are not conclusive against those who consider that certain individuals in suitable circumstances are influenced sub-consciously by underground water.

SIR FREDERIC KENYON's presidential address to the Museums Association, in which he set forth his views as to the future development and arrangement of the British Museum (*see NATURE*, July 28, p. 689), is now published in the August issue of the *Museum's Journal* (Dulau and Co.).

REFERRING to recent correspondence in *NATURE*, Mr. A. S. E. Ackermann writes to say that in August of last year at Ypres he saw bumble-bees abstracting nectar from the flowers of white-runner beans through a hole in the side of the corolla instead of in the normal manner.

THE camera is being used increasingly to elucidate the habits of birds, and striking success has been achieved by Dr. Overton in his observations on the great horned owl, described in *Natural History* (vol. xxi., No. 2). It has hitherto been supposed that the bird attacks its enemies and prey by means of its wings or bill. The remarkable series of photographs which are used to illustrate Dr. Overton's article clearly demonstrates, however, that the bird attacks solely with its feet. We have seldom seen so conclusive a collection of photographs of birds.

IN the June issue of the *Lancashire and Cheshire Naturalist* Mr. R. Standen records some interesting observations of his own and other naturalists on the feeding habits of squirrels, with particular reference to fungi. He has watched squirrels feeding on that most poisonous of fungi (to man), the Fly Agaric (*Amanita muscaria*). They were observed to knock off the cap and to eat only the stalk, but so far as is known they were none the worse, and appear to be immune to this particular form of poison. The late Rev. O. Pickard-Cambridge has recorded squirrels as eating *Boletus edulis*, and Mr. Britten has watched them feeding on the Blusher (*Amanita rubescens*), but both these species are non-poisonous. In America squirrels are known to store fungi with their other food, but British squirrels have not as yet been observed to follow this habit. Mr. Standen's notes raise many interesting points, such as the distribution of the poisonous substance in the tissues of the fungus, and the degree of immunity enjoyed by the squirrels. It is clear that there is much to be learnt about the natural history of our British mammals.

THE diminutive shrunken heads made by the Jivaro Indians have long been familiar objects in our museums. In *Natural History* (vol. xxi., No. 2) Mr. C. W. Mead gives an account of how and why they were made. The head, with a small part of the neck, is severed from the body. A cut is made from the base of the skull down through the neck, and through the opening thus made the bones of the skull are carefully removed. The skin and the remaining soft parts are next dipped in the juice of the *huito* fruit, which stains them black. The skin is then ready for the shrinking process. This is done by putting a number of hot stones into the cavity and constantly turning the head in order to bring all parts in contact with the stones. This process is repeated until the head is reduced to the required size. Among some of the tribes a single hot stone nearly as big as the head is used, and replaced by smaller ones until the work is completed. Hot sand is also used in some localities. The lips are then fastened by long pendent cords, and one is run through the top of the head to suspend it. Finally, the cut in the back of the neck is sewn up, and the trophy is completed. Originally a tribal custom of celebrating a victory over an enemy, the Jivaro Indian was not slow to turn it to commercial use when he found that the heads were in great demand among white men. We are told that advance orders were booked and in due course filled.

DR. MARIANNE PLEHN directs attention in an article in the *Allgemeine Fischerei-Zeitung* for August, a translation of which has been sent to us by the Editor of the *Fishing Gazette*, to what she regards as a hitherto unrecognised cause of disease in fish kept in tanks and ponds: this is an excessive quantity of oxygen in solution in the water. It is well known that an abundant growth of algae in fish cultural ponds may be very injurious. So much oxygen is given off by the plants that the water may effervesce when it is stirred violently. In such circumstances more of the gas is taken up by the blood of fishes than can be used in the ordinary way by the tissues, and then a further rise in the water temperature may cause the liberation of gaseous oxygen in the blood. Vesicles, visible to the naked eye, are said to form in the skin, particularly on the fins. Similar gas vesicles may form in the orbits, giving rise to "exophthalmos." Gas embolisms may even form in the heart and vessels of the gills, causing immediate death. Not only oxygen, but also nitrogen, may, at times, be contained in solution in freshwaters to such an extent as to be the occasion of this "Gaskrankheit," and the author also suggests that gas-forming bacteria in the blood of fishes may be the cause of similar effects. The matter is one of much importance in salmon and trout hatcheries, and, quite evidently, it should be the subject of very careful investigation.

A TELEGRAM from Asmara (Eritrea) reports a rather severe earthquake in that region on or shortly before August 15. The shock was especially strong at Massowah and in the surrounding country, at least four people being killed and about twenty injured, while

several houses collapsed. As a rule the earthquakes of Eritrea are infrequent and of slight intensity. Prof. Palazzo, in his catalogue of Ethiopian earthquakes from 1400 to 1912 (Boll. Soc. Sism. Ital., vol. xix., 1915, pp. 293-350), records 142 shocks, the strongest of which occurred in 1400, 1884, and 1901. Asmara itself seems to be one of the least stable regions. Early in 1913 (from January 24 to April 8), 208 disturbances were registered at the seismological station in that place, the strongest of which was of about the same intensity as the recent earthquake.

It is satisfactory to learn that the valuable work of the Kilauea Volcano Observatory is to be maintained, if not extended. Under the supervision of Dr. T. A. Jagger, jun., and supported by the Hawaiian Volcano Research Association, all changes in the activity of the volcano have been chronicled for some years, and the earthquakes, local and otherwise, have been registered. In 1918 a grant of ten thousand dollars was made by Congress, and at the same time the question of placing the observatory under Government direction was considered by a committee of the National Academy of Sciences. On its advice the control of the Kilauea Observatory has been transferred to the Weather Bureau. The full report of the committee has now been published (Proc. Nat. Acad. of Sciences, vol. vi., 1920, pp. 706-16). A general scheme of investigation in either seismology or volcanology is, it considers, beyond the proper scope of the Weather Bureau. For the present, the committee suggests that seismographs might be added at certain selected meteorological stations, and that such work should, if possible, be placed under the direction of a trained seismologist belonging to the Bureau. While the maintenance of the Kilauea Observatory is regarded as of the first importance, the committee recommends that observations should be made on all the active phases of Hawaiian volcanism, and that, especially, the gigantic volcano of Mauna Loa, which represents a different stage in the development of a basaltic volcano, should be subjected to an investigation as systematic as may be possible, taking into account its much greater size and the difficulty of access.

THE hydrous calcium borate inyoite, described by W. T. Schaller from California in 1916, has now been found at a second locality, the Whitehead gypsum quarry, Hillsborough, Albert County, New Brunswick. E. Poitevin and H. U. Ellsworth describe a number of crystals, confirming the monoclinic character of the mineral (Canada Depart. of Mines, Geol. Surv., Bull. 32, 1921). It is "fairly soluble" in water, and separated out somewhat later than the massive gypsum, in the cracks of which it lies.

THE Geological Survey of Ireland has issued through the Ordnance Survey two new sheets of the geological map of the country on the scale of a quarter of an inch to a mile (1:253,440). Sheet 5 covers a region of unusual interest, and should be specially useful to dwellers in Belfast. Educationally, it serves as an epitome of the geology of Ireland. It includes the

gneissic axis of Tyrone, the Caledonian area of Armagh and Down, with the Newry granite in its strike, the down-faulted Carboniferous series of Coal Island, and the Cainozoic granite of the Mourne. The Mesozoic beds, protected by the great plateaus of basaltic lavas, are well seen encircling Lough Neagh. Sheet 16 offers less variety, and shows the rapid succession of Armorican anticlines and synclines in the Devonian and Carboniferous systems round Cork city.

IN a short paper to the International Congress of Mathematicians, Strasburg, 1920, entitled "Une application des polynômes d'Hermite à un problème de statistique," Prof. Alfred Gulberg, of Christiania, reaches the series recommended for the representation of frequency curves and surfaces by Edgeworth in this country, and by Charlier, Thiele, Bruns, and others on the Continent. The large amount of mathematical work on such subjects that is being done in Scandinavia is noteworthy, but the application of the results of the mathematical work on a large scale to a great variety of statistics seems to be required if we are to estimate the usefulness of the work in practice.

THE report of the Royal Observatory, Hong-Kong, for the year 1920 by Mr. Claxton, the director, shows that the usual meteorological and magnetic results have been continued. Automatic records of the temperature of the air and evaporation were obtained with a Richard dry- and wet-bulb thermograph, and the direction and velocity of the wind with a Beckley and a Dines-Baxendell anemograph. The amount of rain is recorded automatically by a pluviograph, and the amount of sunshine is registered by a Campbell-Stokes recorder. Other observations are recorded by eye. The mean barometric pressure and mean temperature for the year were in fair agreement with the normals. The total rainfall for the year was 107.88 in., which is about 24 in. above the normal. The fall in an hour measured 1.44 in. on September 12, and 12.70 in. fell in forty-nine hours on July 18-21. Tracks of sixteen typhoons and four of the principal depressions which occurred in the Far East in 1920 are given in the Monthly Meteorological Bulletin for December. Observations from the Philippines are now received in time for insertion in the daily weather map. Wireless weather telegrams were received from 140 ships in the course of the year, and meteorological registers from 170 ships operating in the Far East. Upper-air research is being considered, as is also the installation of a seismograph.

THE *Meteorological Magazine* for July has an article on the design of rain-gauges, which affects largely the accuracy of rainfall measurements, now being considered with greater assiduity than in the past. The 5000 observers for "British Rainfall" show the necessity for uniformity and precision in the style of gauge. Universal adoption of the now recognised standard patterns of rain-gauge is advocated, and the rejection of certain obsolete patterns. The forms approved are the Snowdon gauge and patterns based on it, such as the Bradford gauge, the

Meteorological Office pattern gauge, and the Sea-thwaite gauge. Some of the essential features given of an approved gauge are: The stout brass turned ring terminating upwards in a knife-edge, exactly 5 or 8 in. in diameter, which forms the rim of the gauge; the vertical cylinder, 4 to 6 in. deep, extending from the rim to the upper edge of the funnel, which is intended to retain snow and hail, to prevent the outsplashing of rain which has fallen upon the funnel, and to reduce to a minimum the risk of loss due to wind eddies; an inner collecting vessel, which can be removed for measuring the fall without disturbing the body of the gauge, the latter being slightly sunk in the ground; and a capacity of not less than 10 in. of rain for a daily gauge. Hints relative to self-recording gauges are also given. Makers of rain-gauges are asked to assist in the elimination of undesirable types of rain-gauge.

SINCE its introduction in 1829 the Trevelyan rocker has formed the subject of many scientific papers, but they have all led to the conclusion that Faraday's explanation of the motion of the rocker was substantially correct. According to Faraday the motion is due to the expansion of the material of the support under one of the two ridges on the under-surface of the rocker by heat communicated to the material from the rocker. This expansion throws the rocker on to its other ridge, allowing the first portion of heated material to cool until it is again the support for the rocker. This theory was put into dynamical form by Davis in 1873, and has been accepted as satisfactory. A recent study of the actual motions of a rocker carried out by Prof. Chuckerbutti, of Calcutta University, and given in vol. vi. of the Proceedings of the Indian Association for the Cultivation of Science, shows, however, that the theory is quite unsatisfactory. The tones produced are those of the elastic vibrations of the system composed of the rocker and its handle, and the pitch of each is determined by these vibrations under the constraints imposed on the rocker by the method of support.

THE third paper on the physical properties of clay, read by Mr. A. S. E. Ackermann before the Society of Engineers, contains a record of forty-nine more experiments, which carry our knowledge of this subject considerably further. By boiling the clay and allowing it to settle, some of the colloidal matter was got rid of, and as a result the pressure of fluidity was decreased by about 25 per cent. When a disc is pressed into a mass of clay, the mean radial speed of flow of the clay underneath the disc is about one-eighth the speed of penetration of the disc, and the mean speed of penetration of the disc when the load on it is just sufficient to produce the pressure of fluidity is about 1 cm. per minute. Some interesting experiments were made with the view of ascertaining the behaviour of the clay immediately below the disc; there appears to be a stagnant cap of clay which remains in contact with the lower side of the disc and travels with it. Even under considerable tangential stress there is no progressive strain in clay containing 25 per cent. of water, which

thus behaves as a solid. The addition of an artificial head to the top surface of the same clay increases the pressure of fluidity by about 7 per cent. when the addition is 200 per cent. of the actual head. The experiments on discharging clay under pressure through sharp-edged circular orifices are also of interest. The rate of discharge increases more rapidly than the rate of increase of pressure, and ultimately there is a phenomenon analogous to the pressure of fluidity. Reducing the size of the orifice, keeping the pressure constant, reduces the discharge per unit

area of orifice. The initial pressure necessary to cause the discharge to begin increases considerably as the diameter of the orifice is decreased. Practically the same result is obtained whether a disc or a sphere is used in determining the pressure of fluidity, and the result is independent of the diameter of the disc or sphere within a considerable range. Mr. Ackermann's work on this subject shows promise of great value to engineers in dealing with foundations and retaining walls, and we trust that his experimental work will be continued.

Our Astronomical Column.

THE RECENT METEORIC DISPLAY.—Mr. W. F. Denning writes that further proof of the unusually abundant display of August meteors is provided by Mr. S. B. Matthey, observing at St. Helier, Jersey, on August 11 during the quarter of an hour between 14h. and 14h. 15m. G.M.T., who saw sixty-two meteors. This indicates a rate of about 250 per hour, and proves that the shower was witnessed in extraordinary activity. About 25 per cent. of the meteors seen by Mr. Matthey were bright ones, exceeding stars of the first magnitude. Their light was frequently strong enough to illumine buildings near his place of observation; in fact, he describes the effect as being somewhat similar to that occasioned by so-called sheet lightning.

DETECTION OF ENCKE'S COMET.—A letter from Mr. J. F. Skjellerup, dated Capetown, July 29, announces that he and Mr. W. Reid detected Encke's comet on July 27 at 5h. 15m. G.M.T., when it preceded 19 Sextantis by 31 seconds, and was 2' to the south of it, which makes its apparent position R.A. 10h. 8m. 11s., N. decl. 4° 58'. The estimates of its magnitude by the two observers were 9.5 and brighter than 8.0.

The following elements were predicted by Mr. Matkiewitch:—

$$\begin{aligned} T &= 1921 \text{ July } 13^{\text{h}} 28 \text{ G.M.T.} \\ \omega &= 184^{\circ} 43' 5'' \\ \Omega &= 334^{\circ} 35' 5'' \\ i &= 12^{\circ} 31' 1'' \\ \log a &= 0.34598 \\ e &= 0.84671 \\ \log q &= 9.53149 \end{aligned}$$

The above observation would indicate a value of T some 0.2 day earlier than the prediction.

The comet will be 1921 *d*.

The letter states that Pons-Winnecke's comet was observed at midnight on July 27, in R.A. 1h. 24m., S. decl. 38°, magnitude about 8.5.

STUDY OF THE MOON'S SURFACE.—Mr. Walter Goodacre has just brought out the eighth report of the Lunar Section of the British Astronomical Association. He dwells on the immense value in selenography of the splendid photographs taken by Mr. F. G. Pease with the 100-in. Mount Wilson reflector. He states that they show more detail than a 6-in. visual telescope would do, even with the best seeing. The report contains several charts showing on a larger scale much of the detail that has been detected on the photographs. One is of the "Straight Wall near Thebit," showing that it is really by no means straight. Enlargements of the craters Ptolemaeus, Clavius, Copernicus, Arzachel, Gassendi, etc., show much new detail, mostly of the nature of tiny craters

or narrow clefts. Mr. Goodacre considers that the new evidence is unfavourable to the theory of meteoric formation of the lunar features. Various fine details are noted, in particular an apparent landslip on the wall of Birt A.

Mr. J. W. Durrad contributes a fine drawing of Gassendi, showing numerous clefts on the floor, some of which are new.

THE DISTANCES OF THE GLOBULAR CLUSTERS.—The Bulletin of the National Research Council, Washington, D.C., for May last contains an interesting discussion between Dr. Harlow Shapley and Prof. H. D. Curtis on this subject. Taking the Hercules cluster as an example, they contend respectively for 36,000 and 3600 light-years as its distance. The strongest argument for the former distance is the presence of B stars in the cluster and the demonstration that the average absolute magnitude of such stars is zero or brighter, judging from the stars in proximity to the sun. Prof. Curtis prefers to work from the average absolute magnitude of all stars within measurable distance, but Dr. Shapley replies that the average is itself a function of distance, since the stars that are really very faint are altogether lost to view at moderate distances.

Another point discussed is the correlation between period and absolute magnitude in the Cepheid variables. Prof. Curtis gives a diagram showing that the case for this correlation becomes much less convincing than Dr. Shapley had supposed, when the number of galactic Cepheids employed is increased. Dr. Shapley replies that he used the Cepheid method solely as corroborative of several others, and that the strongest argument for the correlation is in reality deduced from the fact that the methods all fall into line so well.

The discussion also involves the status of the spiral nebulae. Dr. Shapley's estimate of the size of our Galaxy is so great that if the spirals were similar objects they would be so remote that we could not expect to see novæ in them. From the fact that several novæ have been detected he concludes that they are not stellar, but actually formed of diffused matter. Prof. Curtis's smaller galactic diameter permits the view that the spirals are external galaxies. He estimates the distance of the Andromeda nebula (supposed to be the nearest spiral) as 500,000 light-years, and invokes the presence of a zone of occulting matter near the galactic plane to explain the observed distribution of the spirals.

The discussion is highly instructive, and the method of putting the two views of such difficult questions side by side is most helpful as a check on over-hasty deductions and a test of the weaker links in a chain of evidence.

New Facts of Colour Vision.

By DR. F. W. EDRIDGE-GREEN.

THE White Equation.—The fact that when two or three simple spectral colours are combined a white is produced which matches that from which the spectrum has been formed is the basis of many theories of colour vision. It is therefore of fundamental importance to any theory of colour vision.

In a recent paper (Proceedings of the Royal Society, B, vol. xcii., 1921, p. 232) it was pointed out that when an exact match of a red of $\lambda 6670-6770 \text{ \AA}$., a green of $\lambda 5144-5156 \text{ \AA}$., and a violet of $\lambda 4250-4267 \text{ \AA}$. with white was made, after fatigue with red light in the region of $\lambda 670\mu$, there was no longer a match between the simple and mixed whites, the mixed white appearing bright green, and in order that a match could be made the green had to be reduced to about one-half of the amount required by an un-fatigued eye. It is obvious, therefore, that the underlying physiological processes are not the same with the mixed and simple whites. It should be noted, however, that no change in the equation is seen when the eye is fatigued with red light in the region of $\lambda 780\mu$.

Another fact of colour fatigue bears on this point; red of $\lambda 670\mu$ can be matched with red of the end of the spectrum by varying the intensity, and so it has been stated that red $\lambda 670\mu$, as well as the terminal red, affects only the hypothetical red sensation. If, however, the eye be fatigued with red of the region of $\lambda 760\mu$, and red of the region $\lambda 670\mu$ be afterwards viewed, this appears yellow, or even greenish-yellow, which could not be the case if the red sensation only had been affected.

The Change of Hue produced by the Addition of White Light to Spectral Colours.—White light is a purely relative term. The white light of the sun is not the same as that from an artificial source; the term is therefore employed as meaning the combined light of the source which is used. In making the experiments described, the light was that of a 1000-candle-power tantalum arc, which, compared with sunlight, is yellow. The apparatus used in these experiments was that described in the Proceedings of the Royal Society, B, vol. xcii., 1921, p. 232.

Various spectral colours were isolated on a screen coated with magnesium oxide, and definite proportions of white light taken from the source added. The scale of white light is arbitrary, the maximum amount of light it is possible to add being 100 divisions. A comparison white light taken from the source was used. Each colour became less saturated on adding white light. Red first became orange, then yellow. Orange became yellower. $\lambda 585\mu$, pure yellow, did not change in hue. Orange-yellow and yellow-green became yellow. Green became yellow-green. Blue, $\lambda 480\mu$, became white, the comparison white appearing yellow. The violet end of the spectrum from $\lambda 480\mu$, making a blue on the screen, changed to violet on adding 33 divisions of white light; light purple, on adding 100 divisions. Wave-length 585μ , the point where the addition of white light produces no change of hue, is also the centre point of pure yellow and the apex of the luminosity curve.

The result of these experiments shows that the component part of white light which has the greatest luminosity effect is the hue to which all colours tend on the addition of white light.

The Anomalous White Equation without Colour-blindness.—Just as a man may make an anomalous Rayleigh equation without any evidence of colour-

blindness (Proceedings of the Royal Society, B, vol. lxxxvi., 1913, p. 164), so may a man make an anomalous white equation without being colour-blind. As an example of this, a man was examined who presented no sign of colour weakness. He passed my card test, lantern test, and spectrometer with the ease and accuracy of an absolutely normal-sighted person. His luminosity curve was taken by the flicker method and corresponded with the normal. The wave-length of the apex of the luminosity curve was at 585μ , which is the normal point. When, however, his white equation was taken, he put only eight scale-divisions of green instead of thirteen and a half or fourteen, which is normal, and the mixed light appeared red to the normal-sighted. An important fact was noted, namely, that after fatigue with red in the region of $\lambda 670\mu$ the equation changed to him in the same way as the normal-sighted, and he required only four scale-divisions of green instead of eight. It is quite obvious that this was not a case of partial red-blindness.

The White Equation and Colour-blindness.—The colour-blind have been classified by some as red- or green-blind, in accordance with their white equations, those who put too much red in the equation being classed as red-blind and those who put too much green in the equation being classed as green-blind. There are, however, many who, whilst agreeing with the normal equation, are quite satisfied when a considerable additional amount of green or red is added to the equation. This explains why in certain cases some have been described as red-blind by one observer and green-blind by another.

A remarkable fact which does not seem to have been previously observed is that many colour-blind persons who strongly object to the normal match, but are satisfied with an anomalous equation, will completely agree with the normal equation when the comparison white light is increased in intensity so that it is much too bright to a normal-sighted person. This clearly shows that the normal mixed white produces the same effect so far as colour is concerned, but has a more powerful effect as to luminosity. This is in complete accordance with other observations, and is found in those cases in which there is abrupt and slight shortening of the red end of the spectrum. If there be shortening of the red end of the spectrum which does not affect $\lambda 670\mu$, and $\lambda 670\mu$ has its normal light value, the mixed light will be more luminous than the simple white in the exact proportion of the shortening. This portion of red light not producing any effect has to be subtracted from the white light.

These facts are quite inconsistent with a hypothetical red sensation which is affected by light of all wave-lengths. Another illustration may make this point clear. A man with shortening of the red end of the spectrum and normal colour discrimination will put together as exactly alike a pink and a blue or violet much darker. If, however, the pink and blue be viewed by a normal-sighted person through a blue-green glass which cuts off the red end of the spectrum, both will appear identical in hue and colour. This proves conclusively that the defect is not due to a diminution of a hypothetical red sensation, because all the rays coming through the blue-green glass are supposed to affect the red sensation, and yet we have been able to correct the erroneous match by the subtraction of red light. On the other hand, there are colour-blind persons who, whilst dis-

agreeing with the normal white equation, agree with it when the comparison white is diminished in intensity.

The facts in this article, whilst in complete accord with those previously given ("The Physiology of Vision," G. Bell and Sons, 1920), are inconsistent with any theory of three fundamental sensations of which the other colour sensations are compounded.

Defects of light perception are quite distinct from defective colour discrimination. All degrees of colour discrimination may be classified as dichromic, trichromic, tetrachromic, pentachromic, hexachromic,

and heptachromic. This classification is fact and not theory. For instance, the dichromic have two colour sensations, red and violet, with a neutral division in the spectrum. There are innumerable varieties of dichromic vision, as there may be shortening of either end of the spectrum or defects in the luminosity curve. When the luminosity curve is the same as the normal there is no evidence to show that the perception of white is not the same as the normal.

I must express my indebtedness to Capt. Fulton and Mr. Isaacs, of the Board of Trade, for their help in making these observations.

Regional Geology.

OUR knowledge of the geology of England is enriched by Dr. J. E. Marr's conception (*The Naturalist*, February, 1921) of Yorkshire as an earth-block surrounded by down-folded strata, but with its own Carboniferous series little disturbed, owing to the rigidity of a pre-Cambrian mass beneath. The block, which became tilted somewhat to the east, has had an important effect on the drainage, and even on the progress of ice-sheets, in northern England.

A useful summary and map of the geology of Jersey, by G. H. Plymen, appear in the Proceedings of the Geologists' Association, vol. xxxii., p. 151 (1921), a journal that has maintained its characteristic features despite the difficult conditions following on the war. The Geological Survey should find a ready sale, even at the price of 10s., for its "Short Account of the Geology of the Isle of Wight," by H. J. Osborne White (1921), which contains a coloured geological map on the scale of one quarter of an inch to one mile. The second edition of the memoir that it succeeds is now exhausted, and we must look back on that handsome cloth-bound volume, issued at 8s. 6d., with the customary regret. But Mr. White's treatise is not a mere abridgment of the older one, since he brings to the work his wide knowledge of the south-east of England, and of the literature of the intervening thirty years. He adds original drawings, showing the development of the surface and the relations of the rocks to well known scenic features, and geologists who are fortunate enough to possess the memoir by Reid and Strahan must now add its successor to their libraries before they start once more for the island. Here, again, the question is raised as to whether memoirs by public surveys should be supposed to cover their own "cost of production," or whether their dissemination should, as in Canada and the United States, be regarded as a part of public education.

Dr. Arthur Winkler, as Ordnance-officer of the 7th Gebirgsbrigadecommando, was stationed at Santa Lucia, near Tolmino, in 1916, and found time to extend F. Kossmat's researches on the central Isonzo valley. He remarks, in the true spirit of science, that the war had inflicted wounds on the mountain-sides, and that many new exposures required registration. His observations, continued in 1918, are now recorded in a paper in the *Jahrbuch der geologischen Staatsanstalt*, vol. lxx., pp. 11-124 (1920), illustrated by numerous sections showing the Alpine folding of the strata, from the Triassic limestones to flysch of Eocene age. Glacial beds, dumped down into the valley, play an important part in the dusty groove, and walls of pebbly calcicrete are undermined by the green swirls of the Isonzo. Above them tower the crags of contorted limestone, marked by brown scars where slabs of rock have fallen away. Dr. Winkler's work brings back happier memories than those recently associated with the Bainsizza Plateau and Caporetto.

The Geological Survey of India issues a handsomely illustrated memoir, by C. S. Middlemiss, on Idar State, which lies on the tropic in the north-east of the Bombay Presidency. Evidences of solar weathering are given in the fine views of granite surfaces. The main interest of the district lies in the junction of the Delhi quartzite with the underlying series of Aravalli schists and gneisses. Quartzite blocks again and again appear to be stoped off into the Aravalli rocks; but the latter cannot in all cases be regarded as igneous invaders. The author suggests that the igneous masses which penetrate the Aravalli series softened the metamorphosed sediments until they behaved as a semi-solid or plastic mass. The floor of Finland seems to offer much support to his conclusions.

Dr. W. F. Hume, untiring in his surveys of barren lands, has issued, with his colleagues, a preliminary report on Abu Durba (Western Sinai). This bulletin, dated 1921, is No. 1 of a series on petroleum research. The oil that is traceable at Abu Durba seems to have been absorbed from shales into the Nubian sandstone, and may originate (p. 11) in organic matter washed down with the shale-particles into the Cretaceous sea.

A. L. Du Toit (Union of S. Africa, Geol. Surv., Explanation of Cape Sheet 28, 1920) traces in Ponderland the great monoclinical flexure that, as Penck showed, is responsible for the edge of the plateau-lands of south-eastern Africa. The down-folding has determined the coast-line, and ceased about the close of Cretaceous times. The inland region, however, continued to rise, since Upper Cretaceous beds, near East London, occur 1100 ft. above the sea. The shelves over which the rivers reach the sea represent successive stages of the uplift. One is inclined to ask once more: When was the great peneplain of the plateau-surface formed? How has it escaped dissection inward from its Eocene edge? Has it been perpetuated by wind-action in a region where rains are only seasonal and droughts are more prevalent than rains?

The first pamphlet of the Geological Department of Uganda (Entebbe, 1920) is written by E. J. Wayland, and is intended to direct the attention of residents to the interest of geological features. The prevalence of laterite is discussed; but we should hesitate to say that the iron was "from the first" in the state of hydrous oxide. Glauconite, mentioned in connection with clays, is a silicate and not a phosphate. Are not the cubic pseudomorphs in the argillites (p. 11) more likely to have been originally pyrite than rock-salt? The author introduces (p. 36) a useful geographical term, *arena*, for undulating areas more or less completely surrounded by hill-ranges. These areas are shown to result from the denudation of domes of strata, and rivers run through the surrounding walls. The Woolhope inlier may thus be called an arena, and numerous examples occur in the

Old Red Sandstone and Silurian country of Southern Ireland.

From Australasia we receive comprehensive descriptions of the "Palæozoic Geology of Victoria," by E. O. Teale (Proc. Roy. Soc. Victoria, vol. xxxii., p. 67), with a map of the Mount Wellington area; also of the "Geology of Western Australia," by A. Gibb Maitland, extracted from the Mining Handbook published in 1919 by the Geological Survey. The latter memoir has excellent sketch-maps and illustrations throughout the text, and includes a large coloured geological map of the State, dated 1920, corresponding with that described in NATURE, vol. cv., p. 498. This summary should be serviceable in very many libraries in the homeland, and should be made available in all Australian schools.

In Bulletin 21, at the moderate price of 5s., the New Zealand Geological Survey continues its illustrated descriptions of the Dominion. The Osborne and Whatatutu subdivisions, which are here dealt with by J. Henderson and M. Ongley, lie on the east side of North Island, and include peaks rising to 4000 ft. on the main divide. Oil is found in the district, probably oozing from the Te Arai (Lower Miocene) and Cretaceous strata. As usual in these bulletins, the authors pay full attention to the origin of surface-features, and one of their pleasing landscapes shows us, incidentally, the gathering of thousands of sheep under the raised rock-platform of Waihou Beach.

New Zealand now extends its responsibilities to Pacific isles; and J. Allan Thomson describes (N.Z.

Journal of Science and Technology, vol. iv., p. 49, 1921) the geology of Western Samoa. The lava-tunnels appear to have been used as dwellings, and terraces for sleeping-accommodation have been built up in them—a feature that will pleasantly remind playgoers of the opening scene of Kelly's "Bird of Paradise."

Among American publications, we may note, for comparison with the Triassic beds of Cheshire, the cemented sand-dunes of Eocene age in north-eastern Montana (A. J. Collier, U.S. Geol. Surv., Prof. Paper 120-B, plate iv.), and the cross-bedded De Chelly sandstones (Permian?) of Arizona (H. E. Gregory, *ibid.*, Prof. Paper 93, p. 31, etc.). The latter paper, which is on the "Geology of the Navajo Country," contains notable illustrations of erosion in an arid land. E. G. Fenton (Sci. Proc. Royal Dublin Soc., vol. xvi., No. 19, 1921, 4s. 6d.), in his "Studies in the Physiography and Glacial Geology of Southern Patagonia," brings us to an unusual field. He has specially examined, through years of residence, the results of glacial outwash and of river-erosion between the Andes and the Atlantic coast. He interestingly attributes the hollows known as *bajos* to the action of water falling over an ice-front during a pause in the general retreat of the pampas glaciers. Though he traces several epochs of retreat and of renewed glaciation, during some of which lavas flowed down into valleys cut by rivers streaming from the ice, Dr. Fenton finds no evidence of any genial interglacial epoch in Patagonia.

G. A. J. C.

Artificial Farmyard Manure.

AN article in the current issue (August) of the *Journal of the Ministry of Agriculture* under the above title somewhat modestly announces what must be regarded as one of the most notable advances in agricultural science made by our oldest agricultural research laboratory, the Rothamsted Experimental Station. For many years the composition and fertilising value of farmyard manure have occupied the attention of investigators. The chemical problems involved at first sight appear simple. When cattle are fed with food rich in nitrogen there is a corresponding enrichment of their excrement. "Cake-fed" dung has long been given a high value by the farmer, and on a purely chemical basis its merit was recognised by the man of science. Hence such publications as "Hall and Voelcker's Tables," which give the "residual" values of various foodstuffs—that is to say, the value of the fertilising constituents (mainly nitrogen) in various substances present in the dung of animals to which they have been fed. But the perplexing fact emerged that dung with this higher theoretic value did not give crop increases corresponding to its assumed chemical content. Nevertheless, so strong has been the effect of the publication of these theoretic values that they are given quasi-statutory effect. Entering tenants have generally to pay compensation "for improvements" based upon the quantity and quality of the foods consumed on the farm during the years preceding their entry.

In the paper alluded to Messrs. Hutchinson and Richards indicate the solution of the conundrum. Put shortly, they have established that the whole of nitrogen in the urine of animals will not be present in the manure as applied to the crops unless a certain ratio subsists between the nitrogen voided by the animals and the carbonaceous matter of the litter by

which the urine is absorbed. It seems to follow that "compensation for improvements" should not be awarded on the basis of the food supplied to the stock until the valuer is assured that the feeding was accompanied by an adequate supply of litter, the adequacy being determined by the amount of nitrogen voided by the animals.

Messrs. Hutchinson and Richards show that the factors involved are, in the main, biological, not chemical. The "making" of farmyard manure is essentially the rotting or fermentation of straw. The former writer has published a paper (*Journal of Agricultural Science*, 1919, p. 143) which establishes that straw is fermented by a new aerobic organism, *Spirochaeta cytophaga*, and that this organism requires (in addition to air) a supply of nitrogen, preferably in the form of an ammonia compound (such as, in effect, urea is). It is shown that the amount of nitrogen required for the fermentation of 100 lb. of straw is 0.72 lb. Further, if the nitrogen is in excess of this amount, it tends to pass into the atmosphere as ammonia, with the result that, with a free supply of air, the end product is dung containing about 2 per cent. of nitrogen, *whatever* the original content of the excrement may have been. Under the conditions, however, which obtain in the ordinary farmyard, where some portions of the heap may receive more excrementitious matter than others, the ammonia set free where the nitrogen: cellulose proportion is greater than 0.72:100 may be picked up by those portions where the ratio is less, and used to build up their nitrogen content until the whole heap reaches the characteristic and uniform 2 per cent. content of nitrogen.

Using these results, it has been found possible to make an artificial product, closely resembling farmyard manure in appearance as well as in properties, by

the addition of predetermined amounts of ammonia salts (such as ammonium sulphate) to straw. The commercial value of this development may be considerable. With the advent of the motor the supply of town dung has fallen off. Many market-gardeners are, consequently, in straits, for the so-called artificial manures are lacking in organic matter (humus), without which many garden and glasshouse crops cannot be grown satisfactorily. It may be that the ordinary farmer, too, will find a use for the artificial product. It is difficult under modern conditions to maintain sufficient animals to make all the straw produced into dung. Again, where animal excrements exist in abundance (as in milk production), lack of knowledge of the principles of the interaction between

urine and straw leads to much waste of valuable fertilising material.

Another direction in which these discoveries may have a practical outcome is in removing the soluble compounds of nitrogen present in sewage. Under the existing sludge processes very little of this soluble matter is recovered. It has been shown that if liquid sewage is used to ferment straw, the effluent is practically free from nitrogen; it has all been retained by the straw.

Enough has, perhaps, been said to indicate the great practical importance of the discovery made by the Rothamsted workers. The scientific advance is not less notable, and marks another stage in the capture by the biologists of the agricultural field of research.

West Indian Zoology.¹

By PROF. J. STANLEY GARDINER, F.R.S.

IN 1895 the State University of Iowa, acting through Prof. C. C. Nutting, who was already well known as a member of several marine expeditions, organised a zoological exploration of the Bahamas. Its object was twofold: to give their people experience of marine life in tropical seas, and to secure material for morphological and systematic research and for ordinary laboratory purposes. So satisfactory were the results that Prof. Nutting's staff themselves suggested a further expedition, this time to the Lesser Antilles. Preparations were commenced in 1916, so little was the entry of the United States into the war anticipated. Prof. Nutting himself went down to prospect in 1917, and finally the expedition sailed in April, 1918, the party consisting of nineteen persons, including six ladies.

Barbados was first visited, the party camping for six weeks in the quarantine station on Pelican Island, which was placed at its disposal by the Barbados Government. Groups were formed for shore collecting, row-boat work, launch dredging to 200 fathoms, land work, and laboratory observations.

Barbados Island itself is the most eastern of the Antilles, and, although now consisting largely of elevated coral and limestone rocks, contains the remains of land connecting it in early Tertiary times to South America. It was then sunk to great depths and overlaid by beds of ooze, "Barbados earth," noted for their richness in radiolaria and foraminifera. The uplift raised the sea bottom high enough for corals to thrive, and subsequent elevations are responsible for the terraced effects so apparent in the topography of the present land. The island is about 21 by 14 miles, and has now a population of nearly 200,000. All is cultivated, and land collecting was hence little likely to yield results of much value. The expedition, indeed, mainly concentrated on marine work, and the more striking animals of different

groups are described; the whole forms a guide which will be of value to future workers. The general variety of life is interesting, but the uniformity of all tropical marine life in the coral-reef regions of the world is still more striking; indeed, Prof. Nutting's descriptions would apply almost equally well to faunas from similar grounds off Ceylon, Seychelles, or Fiji.

The second camping place was in the British dockyard in English Harbour, Antigua. Here, on account of the heavy swell, work had to be concentrated in the harbour and in the neighbouring Falmouth and Willoughby Bays. There were compensations in a neighbouring mangrove swamp with its peculiar fauna, in fairly smooth bottom, and in the land being little altered and still largely wild, covered with close tropical jungle. There are volcanic rocks of some age on this side, limestone rocks occurring principally in the north of the island, off which are the chief living coral reefs. The marine crustacean, holothurian, and worm faunas proved particularly interesting, and there are many observations on the modes of life of different forms. Clearly, while the whole surroundings were not so exciting to the party as those of the coral reefs of Barbados, the expedition must have obtained a large number of animals of great interest. Geographically, the mollusca in the clearly capable hands of Mr. Henderson, and the fossil geology in those of Prof. Thomas, may be expected to yield valuable information.

The immediate scientific results of this expedition are not likely to be great, but the whole idea underlying it, and its scope, are of great interest, for it might well be copied by British universities. Here was a party of nineteen charming people, half of whom were interested professionally, while the rest were students. They went off for a term, and came back to their university with a glimpse of what tropical life really is, an abiding picture which will make those who teach interesting to their students, for they will be describing what they have seen, living forms in their natural environments.

¹ University of Iowa Studies in Natural History. Vol. viii., No. 3. "Barbados-Antigua Expedition." By C. C. Nutting. Pp. 274. (Iowa City: University of Iowa, n.d.)

Thomas Wharton Jones, F.R.S.

SIR RICKMAN GODLEE'S memoir of Wharton Jones, reprinted from the *British Journal of Ophthalmology*, March and April, 1921 (London: Geo. Pulman and Sons, Ltd.), is a most admirable short study. It gives us in close compass not only the man's work, but also the man, from 1808 to 1891—a long life in the service of physiology and ophthalmology. Wharton Jones's

work on the capillary circulation and on the processes of inflammation is memorable, and was recognised and honoured by all men of science: but the advance of the medical sciences carried the younger men far ahead of him. From Edinburgh, where Wharton Jones was one of Knox's assistants, and suffered a share of the public hatred which flared up over the Burke and Hare murders, he came to London in 1838

as lecturer on anatomy and physiology at Charing Cross Hospital; among his pupils were Huxley and Fayrer. In 1840 he was elected to the Royal Society. From 1851 to 1881 he was professor of ophthalmic medicine and surgery at University College. His thirty years of teaching and writing failed to shield him in later life from miserable poverty; he fell out of the running. He was found at last, in the bitter winter of 1880-81, "crouched over a fireless grate, his shoulders hunched up under a mass of shawls and shabby wraps, the picture of destitution . . . not only very ill, but penniless and starving." Friends saved him, and collected money for him; Huxley and Fayrer obtained from Mr. Gladstone a Civil List pension for him; Jenner obtained a Tancred pension for him. The work was ended in London, and for the last ten years he lived in a couple of tiny rooms in a cottage in Ventnor.

And here is the immense value of this memoir: that we are able to see why Wharton Jones made a better job of science than he made of life. His intense individualism, his combativeness, his opposition to the Darwinian new learning, his perverse liking for small personal grievances, his oddities of dress—these hindrances, none of them insuperable, yet were combined to keep him back from anything like the full happiness of success. "He seems to have missed," says Sir Rickman Godlee, "by so little, much that might have made him happy and successful. But this little made all the difference. . . . When all is said, it is impossible to believe that, on the whole, he had more than a very moderate share of happiness, or even of contentment."

Perhaps, as there are martyrs of science, so there are profiteers of science, men who inflate the value of scientific discoveries or seek to "corner" scientific facts. Wharton Jones was neither martyr nor profiteer. Only he could not get clear away from self-preoccupation; and it is a rather unhappy and perplexed face that looks out at us from the frontispiece of this masterly study of him.

University and Educational Intelligence.

CAMBRIDGE.—Baron R. von Hügel has resigned the curatorship of the Museum of Archaeology and Ethnology, and Dr. A. C. Haddon, Christ's College, has been appointed deputy curator. Mr. R. W. Stanners, Gonville and Caius College, has been appointed University lecturer in historical and economic geography. Mr. T. G. Bedford, Sidney Sussex College, and Dr. J. A. Crowther, St. John's College, have been reappointed demonstrators in experimental physics.

Mr. F. J. W. Roughton, Trinity College, has been elected to the Michael Foster research studentship in physiology, and Mr. J. H. Richardson, Emmanuel College, Wrenbury scholar in political economy. Dr. R. L. M. Wallis, Downing College, has been awarded the Raymond Horton-Smith prize in medicine.

Mr. T. F. T. Plucknett, Emmanuel College, has been elected Choate memorial fellow at Harvard College.

Mr. H. H. Thomas, curator of the Herbarium, has been re-elected fellow of Downing College.

Two University lecturers in biochemistry are to be appointed shortly.

PROF. H. LEBESQUE, of the Faculty of Sciences, University of Paris, has been elected professor of mathematics at the Collège de France.

MR. H. P. PHILPOT, assistant professor at University College, has been appointed to the professorship of

civil and mechanical engineering at the Finsbury Technical College; and Mr. A. J. Hale, chief assistant in the department of applied chemistry, to the professorship in that department. The entrance examination of the college will be held on Tuesday, September 20.

LOUGHBOROUGH COLLEGE, Leicestershire, has issued a calendar for the academic year 1921-22, in which full accounts of the intellectual and social activities of the college will be found. Work is distributed over a number of faculties, of which the most prominent appear to be those concerned with engineering and pure and applied science. Full details of the courses followed are given, together with a number of full-page reproductions of photographs of the workshops and laboratories. The engineering departments were opened in 1918, and they are designed to give specialised training to boys above sixteen years of age. The course covers five years, during which time the student passes through every department found in an engineering works. On the social side there are, among other societies, engineering, wireless, and chemical and metallurgical societies, while in June last the council of the Junior Institution of Engineers sanctioned the formation of a sub-section, with headquarters at the college. These societies are doing much to bring the student into contact with industrial methods, and should serve as the much-desired link between the technical school and the works.

THE "Handbook of Lectures and Classes for Teachers for the Session 1921-22," which has been issued by the London County Council, contains a number of features likely to interest readers of NATURE. The teaching of mathematics in elementary and continuation schools forms the subjects of courses in the section on mathematics; geography in secondary schools and as a pivotal subject in education are the themes of two courses in the section on geography. Natural science is well represented by a number of courses and lectures: Prof. A. Wolf is giving five lectures on "Pioneers of Science"; Sir William H. Bragg, six lectures on crystal structure; Prof. C. Spearman and the Rev. F. Aveling, ten lectures on the mentality of individual children; Dr. W. H. R. Rivers, five lectures on the psychology of dreams; Mr. C. Burt, ten lectures on intelligence tests; Mr. P. R. Coursey, five lectures on war developments in wireless telegraphy and telephony; and Dr. C. A. Keane, ten lectures on science in elementary schools. There will also be two courses of lectures on laboratory arts. The special science lectures are as follows: "Modern Astronomical Theories," by Prof. H. H. Turner, on October 15; "The Wonders and Problems of Food," by Prof. H. E. Armstrong, on November 12; "Fallacies," by Prof. Karl Pearson, on November 26; "Geology as a Basis for Geography," by Prof. W. W. Watts, on December 10; "Yeast, what it is and what it does," by Mr. A. Chaston-Chapman, on January 21; "Aluminium and its Alloys," by Dr. W. Rosenhain, on March 16; "The Relation between Pure and Applied Chemistry," by Dr. M. O. Forster, on February 4; "The Migration of Birds," by Prof. J. A. Thomson, on February 18; and "Vitamins," by Prof. A. Harden, on March 4. All lectures are open to teachers employed within the county of London; those outside the administrative county will be admitted where accommodation permits. The Council has also arranged for the issue to teachers of science in London schools of tickets of admission to the meetings of certain scientific societies. Communications should be addressed to the Education Officer, New County Hall, S.E.1.

Calendar of Scientific Pioneers.

August 25, 1814. Sir Benjamin Thompson, Count von Rumford, died.—The founder of the Royal Institution and of the Rumford medals of the Royal Society and the American Academy of Sciences, Rumford devoted much time to science and its application to practical purposes, and was one of the first to show that heat was "a mode of motion."

August 25, 1822. Sir William Herschel died.—Pre-eminent among the astronomers of his day, Herschel extended immensely the bounds of sidereal astronomy. In 1781 at Bath he discovered Uranus. His great telescope at Slough was one of the wonders of the scientific world. He made extensive observations of the moon and planets, first established the motion of the sun in space, discovered many nebulae, and showed that the components of double stars were moving round their common centre of gravity.

August 25, 1867. Michael Faraday died.—Unrivalled as an experimental investigator and as a lecturer, Faraday was the assistant to Davy and the successor of Brande at the Royal Institution, and in 1833 became the first Fullerian professor. Though his investigations covered a wide range, the great work of his life was his series of "Experimental Researches in Electricity," to which all later students of electricity owe a vast debt.

August 25, 1908. Antoine Henri Becquerel died.—The son and grandson of distinguished physicists, Becquerel made himself famous by his memorable discovery in 1896 of radio-activity, for which in 1903, with the Curies, he was awarded the Nobel prize.

August 26, 1723. Anton van Leeuwenhoek died.—A pioneer worker with the microscope, Leeuwenhoek made important discoveries in support of the circulation of the blood, blood-corpuscles, spermatozoa, and other subjects, and contributed 112 papers to the *Philosophical Transactions*.

August 28, 1839. William Smith died.—The "father of English geology," Smith published his epoch-making geological map of England in 1815.

August 28, 1863. Eilhard Mitscherlich died.—The discoverer in 1819 of isomorphism and of dimorphism, Mitscherlich spent two years with Berzelius at Stockholm, and then in 1821 succeeded Klaproth as professor of chemistry in the University of Berlin.

August 29, 1816. Johann Hieronymus Schröter died.—For more than thirty years Schröter studied the topography of the planets. He has been called the Herschel of Germany. His observatory at Lilienthal, in which Bessel worked, was pillaged during the War of 1813.

August 29, 1868. Christian Friedrich Schönbein died.—Schönbein for many years held the chair of physics and chemistry in the University of Basle. In 1839 he discovered ozone, and in 1846 made known his invention of gun-cotton.

August 30, 1844. Francis Baily died.—After amassing a fortune on the Stock Exchange, Baily devoted himself to astronomy. He was a founder of the Royal Astronomical Society, reformed the Nautical Almanac, edited a star catalogue, and during the years 1838-42 repeated the Cavendish experiment for determining the density of the earth.

August 30, 1888. Johann Peter Griess died.—In 1858 Griess discovered the first diazo-compound, and three years later the first azo-colours, which have produced a revolution in the art of dyeing.

August 31, 1900. Sir John Bennet Lawes, Bart., died.—A great pioneer in the application of science to agriculture, Lawes was the founder of the Rothamsted Experimental Station, where for fifty-seven years Gilbert was his collaborator. E. C. S.

Societies and Academies.

PARIS.

Academy of Sciences, August 8.—M. Léon Guignard in the chair.—A. Demoulin: Surfaces generated by circles.—P. Fafou: The domains of existence of certain uniform functions.—M. Potron: The representation of the group of 27 right lines in a group of quaternary collineations.—K. Ogura: The movement of a particle in the field of a charged nucleus.—L. Dunoyer: A new spectrum of caesium. The metal was contained in a quartz tube, with plane parallel quartz ends, and surrounded with a wire spiral in which high-frequency currents were produced. The whole could be heated uniformly in an electric furnace. The vapour commenced to be luminous at 100° C., reaching a maximum luminosity at 250° C. The spectrum consists of fine lines with no trace of a continuous background. Measurements of more than 300 wave-lengths for the low-temperature spectrum are given.—S. Procopiu: Magnetic double refraction of mixed liquids and crystalline structure.—E. Moles and F. Gonzalez: A new revision of the density of oxygen gas. Special attention has been paid to varying the method of preparing the gas, and density measurements are given for oxygen prepared from potassium permanganate, potassium chlorate, mercuric oxide, and silver oxide, and by the electrolysis of water. The general mean is 1.42889, differing only by one part in 10,000 from the figure at present accepted, 1.42905. The densities, classified according to the method of preparation, showed no sign of any systematic error.—A. Mailhe: The preparation of a petrol from a fatty oil. Linseed oil was passed over a catalyst composed of copper, magnesia, and kaolin heated to 550°-650° C. The volatile product was further treated with hydrogen and reduced nickel at 180° C. After refining, petrol and kerosene fractions were obtained. The petrol contained benzene and naphthene derivatives.—G. Vavon: The velocity of the reaction in the hydrogenation by platinum black. The rapidity with which the hydrogenated body formed leaves the surface of the catalyst is a governing factor in the velocity of the reaction.—V. Yéramian: The synthesis and dehydration of ethylpropylphenylcarbinol. Ethylpropylphenylcarbinol was prepared by the Grignard reaction from propylphenylketone and ethylmagnesium bromide. This can be distilled without decomposition under low pressure (25 mm.), but is readily dehydrated, producing an unsaturated hydrocarbon, C₁₂H₁₈, probably 3-phenyl-3-hexene.—V. Lubimenko: The state of chlorophyll in the plants. A study of the causes of the inactivity, from the point of view of photosynthetic reactions, of pure chlorophyll prepared by chemical methods. It was found that treatment of the living tissue by various solvents, besides coagulating the proteid substances in the plants, produces sensible changes in the optical properties of the green pigment. The chlorophyll of the leaves of *Aspidistra elatior* can be completely removed by extraction with water. The absorption spectrum of the material thus extracted is absolutely identical with that of the living leaf. The chlorophyll is intimately related to the proteid substances of the plants, and this is probably of a chemical nature.—M. Romieu: The crystalline inclusions of the elocytes of Nereis and their relations with the eosinophil granulation.—C. Levaditi: Embryonic leaflets in relation to pathogenic micro-organisms. Mesodermic infections are caused by bacteria, fungi, spirillae, and protozoa, whilst infections of the ectoderm are produced by virus, usually invisible and capable of passing filters.

SYDNEY.

Royal Society of New South Wales, July 6.—Mr. E. C. Andrews, president, in the chair.—W. R. Browne: Note on the relation of streams to geological structure, with special reference to "boathook bends." The influence of geological structures on the courses of streams, as illustrated by certain rivers of New South Wales, is discussed, and it is suggested that what Dr. Griffith Taylor has termed "boathook bends" in rivers are in many cases to be attributed to the presence of directive geological structures rather than to river-piracy and the breaching of divides.—Marie Bentivoglio: Notes on cassiterite crystals from New England district, New South Wales, and Stanthorpe, Queensland. The crystals were taken directly from hand-specimens of igneous rocks obtained from Stannum, Pheasant Creek, Mandoie Station, and Stanthorpe. Crystal habit varies with locality. Almost all the crystals are twinned, the twinning occurring on the $e(101)$ face, according to the usual law. Doublets are the commonest grouping, but triplets and quartuplets were also observed.—Dr. E. E. Turner and F. H. H. Wilson: The decomposition of dimethyl oxalate by acetic acid. Pure methyl acetate may be prepared by the action of 80 per cent. acetic acid on dimethyl oxalate, the theoretical quantities of reactants being used. The yields obtained are virtually theoretical.—Dr. L. A. Cotton: The Kurrajong earthquake of August 15, 1919. The special feature of the Kurrajong earthquake is the peculiar Y-shaped character of the isoseismals. One arm of the Y and its stem lie subparallel to, and superimposed over, the line of structural weakness shown by the Kurrajong fault and the Glenbrook monocline. The other arm of the Y is not known definitely to coincide with a fault zone. The direction corresponds to a major direction of tectonic weakness—the Permo-Carboniferous geosyncline—and also to numerous large faults in the Maitland district. It is suggested that the earthquake was caused by block faulting in which the south-eastern corner of a crustal block has foundered. This would account for the peculiar form of the isoseismals. The shape of the boundary of the sound area confirms the Y-shaped form of the isoseismals.

Books Received.

Revelation and Science: A Reply to Higher Critics and Darwinists. By John Leslie. Pp. 156. (Aberdeen: W. Jolly and Sons, Ltd.) 3s. 6d.

Calculations in Organic Chemistry. By Prof. V. K. Bhagwat. Pp. xi+138. (Bombay: S. Govind and Co.)

British (*Terra Nova*) Antarctic Expedition, 1910-1913: Terrestrial Magnetism. By Dr. Charles Chree. Pp. xii+548+lx plates. (London: Harrison and Sons, Ltd.)

Memoirs of the Geological Survey, Scotland. Special Reports on the Mineral Resources of Great Britain. Vol. xvii.: The Lead, Zinc, Copper, and Nickel Ores of Scotland. By G. V. Wilson. With Contributions by Dr. John S. Flett. Pp. vi+159+2 plates. (Southampton: Ordnance Survey Office; London: E. Stanford, Ltd.) 7s. 6d. net.

Die Grundlagen der Geometrie: Als Unterbau für die Analytische Geometrie. By Prof. Lothar Heffter. Pp. iv+27. (Leipzig and Berlin: B. G. Teubner.) 18 marks=1.25 shillings.

Imperial Institute. Indian Trade Enquiry: Reports on Jute and Silk. Pp. ix+90. (London: John Murray.) 5s. net.

Proceedings of the Aristotelian Society. New

Series. Vol. xxi. Containing the Papers read before the Society during the Forty-second Session, 1920-21. Pp. iv+246. (London: Williams and Norgate.) 25s. net.

Liquid and Gaseous Fuels and the Part they Play in Modern Power Production. By Prof. Vivian B. Lewes. Second edition. Revised and edited by John B. C. Kershaw. (The "Westminster" Series.) Pp. xiv+353. (London: Constable and Co., Ltd.) 12s. 6d. net.

The Angami Nagas, with some Notes on Neighbouring Tribes. By J. H. Hutton. Pp. xv+480. (London: Macmillan and Co., Ltd.) 40s. net.

The Fourth Dimension. By Prof. E. H. Neville. Pp. vii+56. (Cambridge: At the University Press.) 5s. net.

Zentralblatt für die gesamte Landwirtschaft mit Einschluss der Forst- und Teichwirtschaft, der Tier-Pathologie und Medizin. Edited by Prof. Richard von der Heide and Robert Lewin. Erster Band. 1920. Pp. 524. (Leipzig: Gebrüder Borntraeger.) 90 marks.

First Principles of the Electrical Transmission of Energy: A Survey of the Physical Basis of Electrical Transmission, its Methods and Phenomena from the Standpoint of the Electron, for Students and Practical Engineers. By Prof. W. M. Thornton. (Pitman's Technical Primer Series.) Pp. xii+116. (London: Sir Isaac Pitman and Sons, Ltd.) 2s. 6d. net.

CONTENTS.

	PAGE
University and Civil Service Salaries	801
Famous Chemists	802
History of Persia	804
The Kinetic Theory and the Quantum. By C. G. D.	804
Beast and Man in India	805
Our Bookshelf	806
Letters to the Editor:—	
The Natural History of Man.—Sir G. Archdall Reid, K.B.E.	808
Magnetic Double Refraction of Smokes.—Dr. R. Whytlaw-Gray	810
The Contractile Vacuole.—Prof. W. M. Bayliss, F.R.S.	810
A Correction.—Prof. J. Arthur Thomson	811
Wrightson's Hypothesis of Audition.—Dr. H. Hart-ridge	811
The Generation of Heath-fires.—Edwd. A. Martin	811
Cernalith.—R. Hedger Wallace	811
Pulverised Coal as a Combustible. By Sir R. A. S. Redmayne, K.C.B.	812
Remarks on Gravitational Relativity. IV. By Sir Oliver Lodge, F.R.S.	814
The Edinburgh Meeting of the British Association. By Prof. J. H. Ashworth, F.R.S.	818
Obituary:—	
Prof. Edmond Perrier	819
A. T. Simmons	820
Notes	820
Our Astronomical Column:—	
The Recent Meteoric Display	825
Detection of Encke's Comet	825
Study of the Moon's Surface	825
The Distances of the Globular Clusters	825
New Facts of Colour Vision. By Dr. F. W. Edridge-Green, C.B.E.	826
Regional Geology. By G. A. J. C.	827
Artificial Farmyard Manure	828
West Indian Zoology. By Prof. J. Stanley Gardiner, F.R.S.	829
Thomas Wharton Jones, F.R.S.	829
University and Educational Intelligence	830
Calendar of Scientific Pioneers	831
Societies and Academies	831
Books Received	832

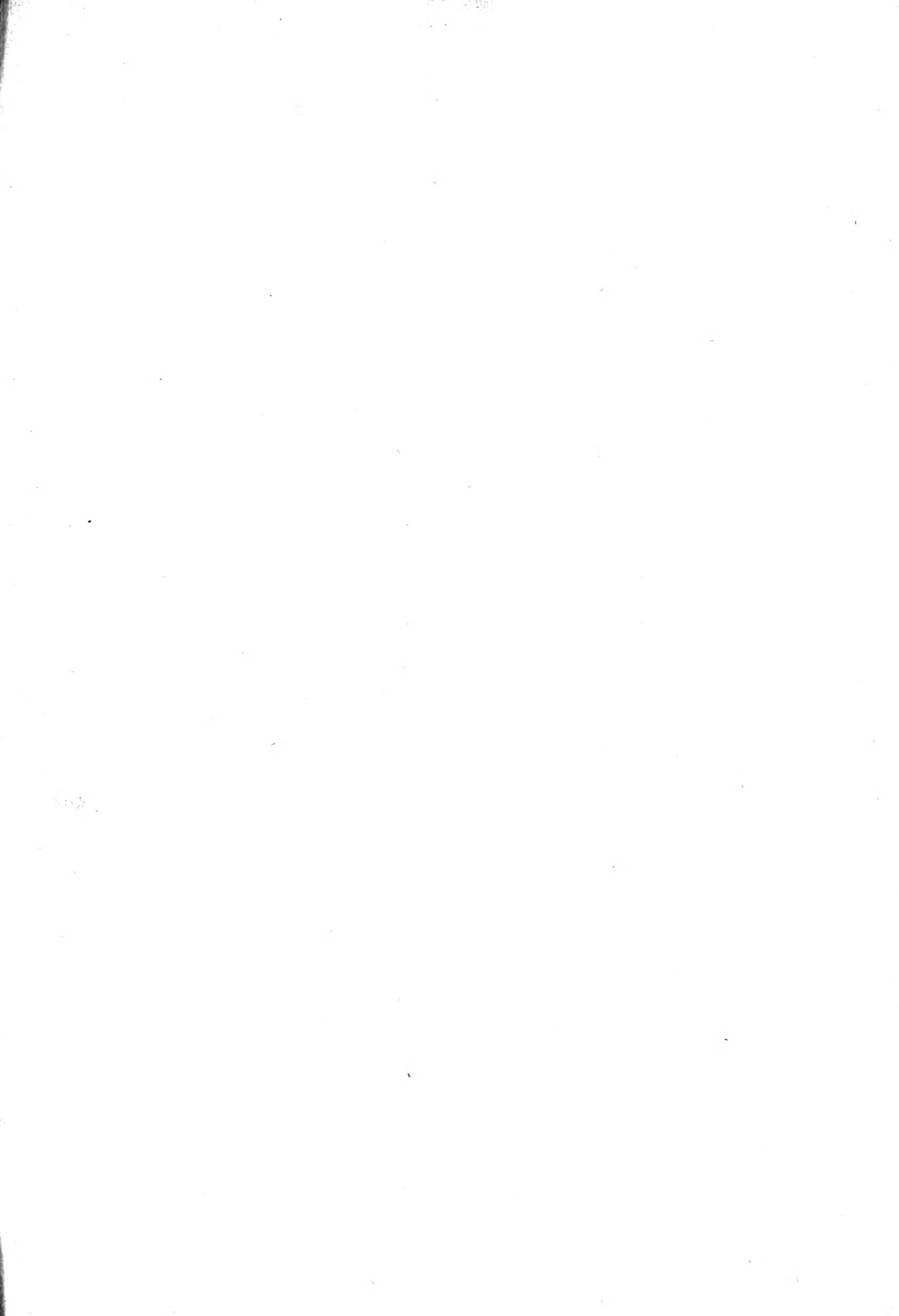

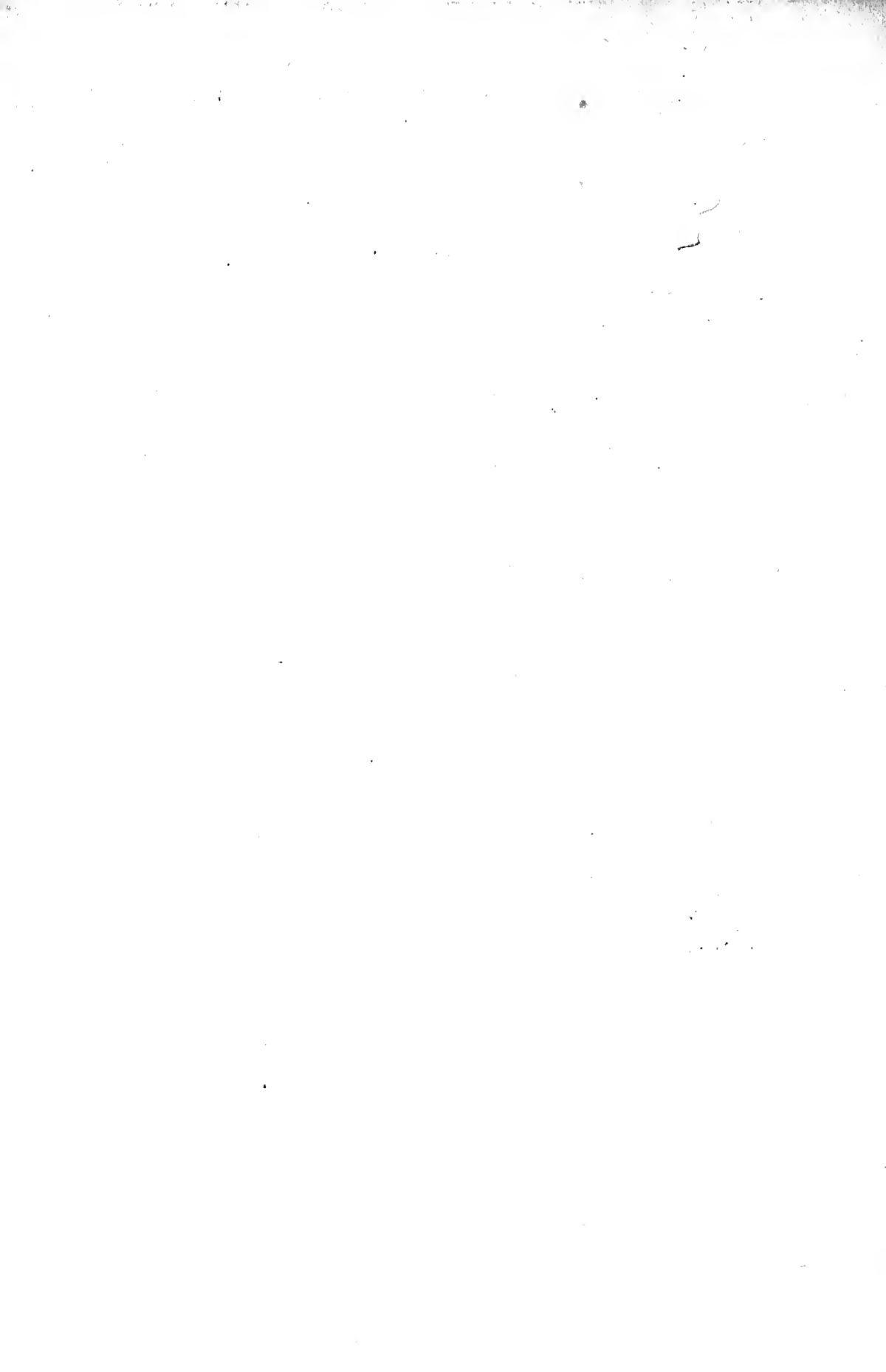

Q Nature
1 v. 107
N2
v. 107
cop. 2

**Physical &
Applied Sci.
Serials**

PLEASE DO NOT REMOVE
CARDS OR SLIPS FROM THIS POCKET

UNIVERSITY OF TORONTO LIBRARY

716/19, 748/51, 785/7, 814/8

